

JMA-9133-SA

JMA-9132-SA

JMA-9123-7XA/9XA

JMA-9122-6XA/9XA/6XAH

JMA-9110-6XA/6XAH

**MARINE RADAR
EQUIPMENT**

**INSTRUCTION
MANUAL**



Japan Radio Co., Ltd.

◆◆◆ PRECAUTIONS BEFORE OPERATION ◆◆◆

■ Cautions for high voltage

High voltages from hundreds volts to tens of thousands volts are to be applied to the electronic equipment such radio and radar devices. You do not face any danger during normal operation, but sufficient cares are required for maintenance, inspection and adjustment of their internal components. (Maintenance, check-up and adjustment of the inside of the equipment are prohibited except by maintenance specialists.)

High voltages of tens of thousands volts are so dangerous as to bring an instantaneous death from electric shock, but even voltages of hundred volts may sometimes lead to a death from electric shock. To prevent such an accident, make it a rule to turn off the power switch, discharge capacitors with a wire surely earthed on an end make sure that internal parts are no longer charged before you touch any parts inside these devices. At the time, wearing dry cotton gloves ensures you further to prevent such danger. It is also a necessary caution to put one of your hands in the pocket and not to use your both hands at the same time.

It is also important to select a stable foothold always to prevent additional injuries once you were shocked by electricity. If you were injured from electric shock, disinfect the burn sufficiently and get it taken care of promptly.

■ What to do in case of electric shock

When finding a victim of electric shock, turn off the power source and earth the circuit immediately.

If it is impossible to turn off the circuit, move the victim away promptly using insulators such as dry wood plate and cloth without touching the victim directly.

In case of electric shock, breathing may stop suddenly if current flows to the respiration center in the brain. If the shock is not so strong, artificial respiration may recover breathing. When shocked by electricity, the victim will come to look very bad with weak pulse or without beating, resulting in unconsciousness and rigidity. In this case, it is necessary to perform an emergency measure immediately.

◆◆◆ FIRST-AID TREATMENTS ◆◆◆

☆ First-aid treatments

As far as the victim of electric shock is not in dangerous condition, do not move him and practice artificial respiration on him immediately. Once started, it should be continued rhythmically.

- (1) Do not touch the victim confusedly as a result of the accident, but the rescuer may also get an electric shock.
- (2) Turn off the power source calmly and move the victim away quietly from the electric line.
- (3) Call a physician or ambulance immediately or ask someone to call a doctor.
- (4) Lay the victim on this back and loosen his necktie, clothes, belt, etc.
- (5)
 - a. Examine the victim's pulse.
 - b. Examine his heartbeat bringing your ear close to his heart.
 - c. Examine his breathing bringing the back of your hand or your face close to his face.
 - d. Check the size of the pupils of his eyes.
- (6) Open the victim's mouth and take out artificial teeth, cigarette or chewing gum if any. Keep his mouth open, stretch his tongue and insert a towel or the like in his mouth to prevent the tongue from suffocating. (If it is hard to open his mouth due to set teeth, open it with a screwdriver and insert a towel in this mouth.)
- (7) Then, wipe his mouth so that foaming mucus does not accumulate inside.

☆ When pulse is beating but breathing has stopped

(Mouth-to-mouth respiration) Fig 1.

- (1) Tilt the victim's head back as far as this face looks back. (A pillow may be inserted his neck.)
- (2) Push his jaw upward to open his throat wide (to spread his airway).
- (3) Pinch the victim's nostrils and take a deep breath, block his mouth completely with yours and blow into his mouth strongly. Take a deep breath again and blow into his mouth. Continue this 10 to 15 times a minutes (blocking his nostrils).
- (4) Carefully watch that he has recovered his natural breathing and atop practicing artificial respiration.
- (5) If it is difficult to open the victim's mouth, insert a rubber or vinyl tube into one of his nostrils and blow into it blocking the other nostril and his mouth completely.
- (6) When the victim recovers consciousness, he may try to stand up suddenly, but let him lie calmly and serve him with a cup of hot coffee or tea and keep him warm and quiet. (Never give him alcoholic drinks.)

Method of mouth-to-mouth respiration by raising hea

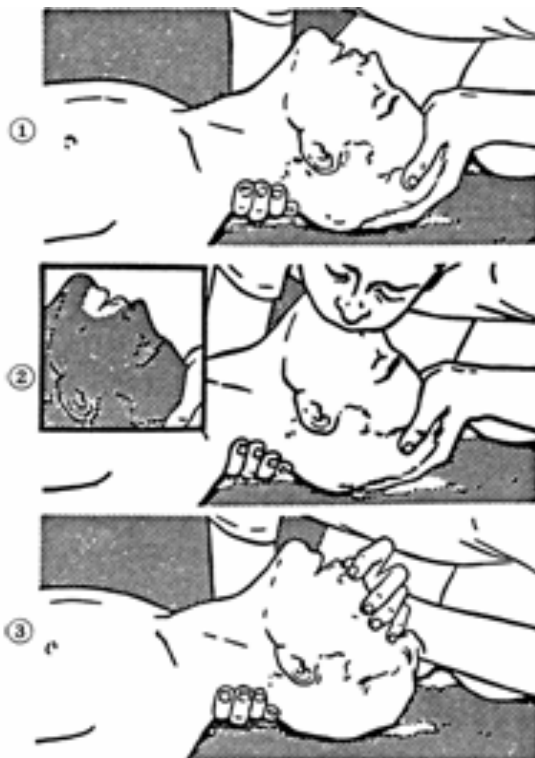

(1) Raise the victim's head. Support his forehead with one of your hand and his neck with the other hand. ①

When you tilt his head backward, the victim, in most cases, opens his mouth to the air. This makes mouth-to-mouth respiration easy.

(2) Cover his mouth as widely as possible with yours and press your cheek against his nose ②

or, pinch his nostrils with your fingers to prevent air from leaking. ③

(3) Blow into his lungs. Continue blowing into his mouth until his breast swells. Blow into his mouth as quickly as possible for the first 10 times.

Fig 1. Mouth-to mouth respiration

☆ When both pulse and breathing have stopped

Perform the (Cardiac massage) Fig 2. and (Mouth-to-mouth respiration) Fig 1.

When no pulse has come not to be felt, his pupils are open and no heartbeat is heard, cardiac arrest is supposed to have occurred and artificial respiration must be performed.

- (1) Place your both hands, one hand on the other, on the lower one third area of his breastbone and compress his breast with your elbows applying your weight on his breast so that it is dented about 2cm (Repeat compressing his breast 50 times or so a minutes). (Cardiac massage)

- (2) In case of one rescuer,

Repeat cardiac massages about 15 times and blow into his mouth 2 times quickly, and repeat this combination.

In case of two rescuers,

One person repeats cardiac massages 15 times while the other person blow into his mouth twice, and they shall repeat this combination. (Perform the cardiac massage and mouth-to-mouth respiration)

- (3) Examine his pupils and his pulse sometimes. When the both have returned to normal, stop the artificial respiration, serve him with a cup of hot coffee or tea and keep him warm and calm while watching him carefully. Commit the victim to a medical specialist depending on his condition. (Never give him alcoholic drinks.) To let him recover from the mental shock, it is necessary for persons concerned to understand his situations and the necessary treatment.

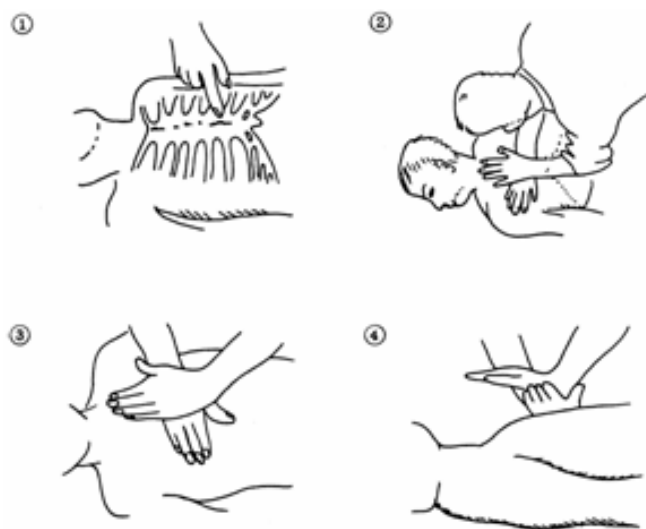

Fig 2. Cardiac massage

PREFACE

Thank you very much for purchasing the JRC marine radar equipment, JMA-9100 series.

This equipment is a marine radar equipment designed to obtain safe operation of marine ships.

This equipment consists of a radar signal transmitter-receiver unit, a LCD display unit and a scanner unit as its main units.

- Before operating the equipment, be sure to read this instruction manual carefully for correct operation.
- Maintain this instruction manual so that operators can refer to it at anytime.



Refer to this manual when any inconvenience or defect occurs.

● Before Operation ●

Pictorial Indication

Various pictorial indications are included in this manual and are shown on these equipment so that you can operate them safely and correctly and prevent any danger to you and/or to other persons and any damage to your property during operation. Such indications and their meanings are as follows.

Please understand them before you read this manual:

 DANGER	This indication is shown where incorrect equipment operation due to negligence may cause death or serious injuries.
 WARNING	This indication is shown where any person is supposed to be in danger of being killed or seriously injured if this indication is neglected and these equipment are not operated correctly.
 CAUTION	This indication is shown where any person is supposed to be injured or any property damage is supposed to occur if this indication is neglected and these equipment are not operated correctly.

Examples of Pictorial Indication



The \triangle mark represents CAUTION (including DANGER and WARNING). Detailed contents of CAUTION ("Electric Shock" in the example on the left.) is shown in the mark.

Electric Shock



Disassembling
Prohibited



Prohibited

The \odot mark represents prohibition. Detailed contents of the prohibited action ("Disassembling Prohibited" in the example on the left.) is shown in the mark.



Disconnect the
power plug



Instruction

The \bullet mark represents instruction.

Detailed contents of the instruction ("Disconnect the power plug" in the example on the left.) is shown in the mark.

Warning Label

There is a warning label on the top cover of the equipment.

Do not try to remove, break or modify the label.

● PRECAUTIONS ●



DANGER



Never conduct inspection or repair work of equipment components.

Inspection or repair work by uncertified personnel may result in fire hazard or electrocution.

For inspection and repair work of equipment components, consult with our branch office, branch shop, sales office, or our distributor in your district.



When conducting maintenance, make sure to turn the main power off. Failure to comply may result in electrocution.



Turn off the main power before cleaning the equipment. Especially when a rectifier is used, make sure to turn it off since voltage is still outputted from the rectifier even after the indicator and the radar are turned off. Failure to comply may result in equipment failure, or death or serious injury due to electric shock.



When conducting maintenance work on the scanner, make sure to turn its main power off. Failure to comply may result in electrocution or injuries.



DANGER



Make sure to turn off the scanner safety switch. Failure to comply may result in injuries caused by physical contact with the rotating scanner.



WARNING



Never directly touch the internal components of the scanner or indicator. Direct contact with these high-voltage components may cause electrocution. For maintenance, inspection, or adjustment of equipment components, consult with our branch office, branch shop, sales office, or our distributor in your district.

To contact our sales department, branch offices, branch shops, and sales offices:

Please refer to the "Office List" at the end of the document.



Do not get close to the radiant section of the scanner. It is a rotating part, and it may cause injuries if it suddenly starts rotating and consequently hits the body. It is recommended that the radiant section be installed at a high place such as on the roof of the wheelhouse, on the flying bridge, on the trestle, or on the radar mast so that no one can get close to it. When any work must be done on the scanner, make sure to turn the safety switch off.



WARNING



Microwave radiation level:

Keep out from a distance closer than that specified below for each type of scanner when it is transmitting. Being within the specified distance from the center of the front face of the scanner may cause microwave exposure which could result in injuries (especially of the eyes).

NKE-2103 (radiation levels: 10 W/m²): 0.6 m

NKE-2254 (radiation levels: 10 W/m²): 0.6 m

NKE-1125/1129 (radiation levels: 10 W/m²): 0.7m

NKE-1130/1139 (radiation levels: 10 W/m²): 1.1 cm



Make sure to install the scanner at a place higher than human height.

Direct exposure to electromagnetic waves at close range will have adverse effects on the human body.



Direct exposure to electromagnetic waves at close range will have adverse effects on the human body. When it is necessary to get close to the scanner for maintenance or inspection purposes, make sure to turn the indicator power switch to "OFF" or "STBY."

Direct exposure to electromagnetic waves at close range will have adverse effects on the human body.



When conducting maintenance work, make sure to turn off the power so that the power supply to the equipment is completely cut off.

Some equipment components can carry electrical current even after the power switch is turned off, and conducting maintenance work without unplugging the power connector may result in electrocution, equipment failure, or accidents.



WARNING



When cleaning the display screen, do not wipe it too strongly with a dry cloth. Also, do not use gasoline or thinner to clean the screen. Failure to comply will result in damage to the screen surface.



Do not change MBS Level/Area unless absolutely necessary.

Incorrect adjustment will result in deletion of nearby target images and thus collisions may occur resulting in death or serious injuries.



When disposing of used lithium batteries, be sure to insulate the batteries by attaching a piece of adhesive tape on the + and - terminals. Failure to comply may cause heat generation, explosion, or fire when the batteries get shorted out.



CAUTION



Use the radar only as a navigation aid. The final navigation decision must always be made by the operator him/herself. Making the final navigation decision based only on the radar display may cause accidents such as collisions or running aground.



CAUTION



Use Target Tracking (TT) function only as a navigation aid. The final navigation decision must always be made by the operator him/herself. Making the final navigation decision based only on tracking target information may cause accidents.

Tracking target information such as vector, target numerical data, and alarms may contain some errors. Also, targets that are not detected by the radar cannot be acquired or tracked.

Making the final navigation decision based only on the radar display may cause accidents such as collisions or running aground.



A malfunction may occur if the power in the ship is instantaneously interrupted during operation of the radar. In this case, the power should be turned on again.



When using the [AUTO SEA] function, never set the suppression level too high canceling out all image noises from the sea surface at close range.

Detection of not only echoes from waves but also targets such as other ships or dangerous objects will become inhibited.

When using the [AUTO SEA] function, make sure to choose the most appropriate image noise suppression level.



When using the [AUTO RAIN] function, never set the suppression level too high canceling out all image noises from the rain or snow at close range.

Detection of not only echoes from the rain or snow but also targets such as other ships or dangerous objects will become inhibited.

When using the [AUTO RAIN] function, make sure to choose the most appropriate image noise suppression level.



CAUTION



When setting a guard zone, make sure to properly adjust gain, sea-surface reflection suppression level, and rain/snow reflection suppression level so that the optimal target images are always on the radar screen. The guard zone alarm will not be activated for targets undetected by the radar, and it may result in accidents such as collisions.



The simulation function is used exclusively for deciding whether or not target tracking is properly operating. Therefore, never use this function unless you wish to check target tracking operations.

Note especially that, if this function is used during actual navigation, simulated targets are displayed and may become confused with other actual targets. Therefore, never use this function during actual navigation.



Optimal values have been set for VD LEVEL and CONSTANT; therefore, never change their values unless absolutely necessary. Failure to comply may result in accidents that would lower target tracking performance.



Make sure to shut off the main power before replacing parts. Failure to comply may result in electrocution or equipment failure.



When replacing magnetrons, make sure to shut off the main power and let the equipment stand for more than 5 minutes to discharge the high-voltage circuit. Failure to comply may result in electrocution.



CAUTION



Make sure to take off your watch when your hand must get close to the magnetron.

Failure to comply may result in damage to the watch since the magnetron is a strong magnet.



Make sure that two or more staff member work together when replacing the LCD. If only one person attempts to replace the LCD, he/she may drop it and become injured.



Do not directly touch the inverter circuit of the LCD display with a bare hand since high voltage temporarily remains in the circuit even after the main power is shut off.

Failure to comply may result in electrocution.



Any adjustments must be made by specialized service personnel.

Incorrect settings may result in unstable operation.



Do not make any adjustments during navigation. Failure to comply may result in adverse effects on the radar function which may lead to accidents or equipment failure.



Any adjustments must be made by specialized service personnel.

Failure to comply may result in accidents or equipment failure.



Do not make any adjustments during navigation. Failure to comply may result in adverse effects on the radar function which may lead to accidents or equipment failure.



CAUTION



Do not change the quantization level settings unless absolutely necessary. If set at an inappropriate value, the target acquisition or target tracking function deteriorates, and this may lead to accidents.

The Mounting Point of the Warning Label

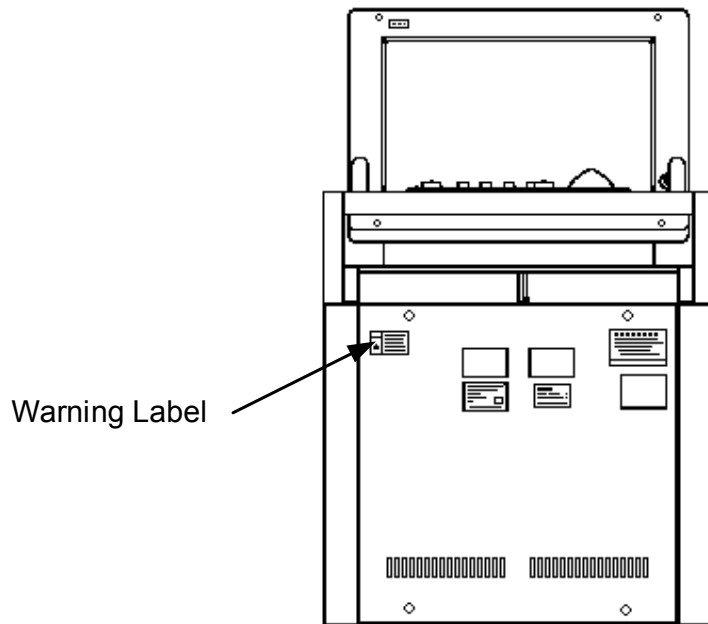

NCD-4990 Display Unit

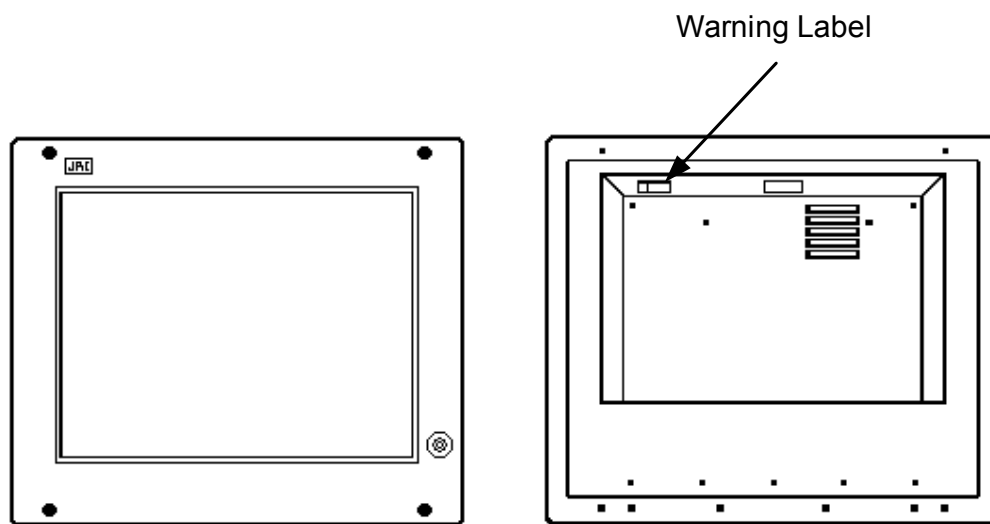

Front face

Back face

NWZ-170 Monitor Unit

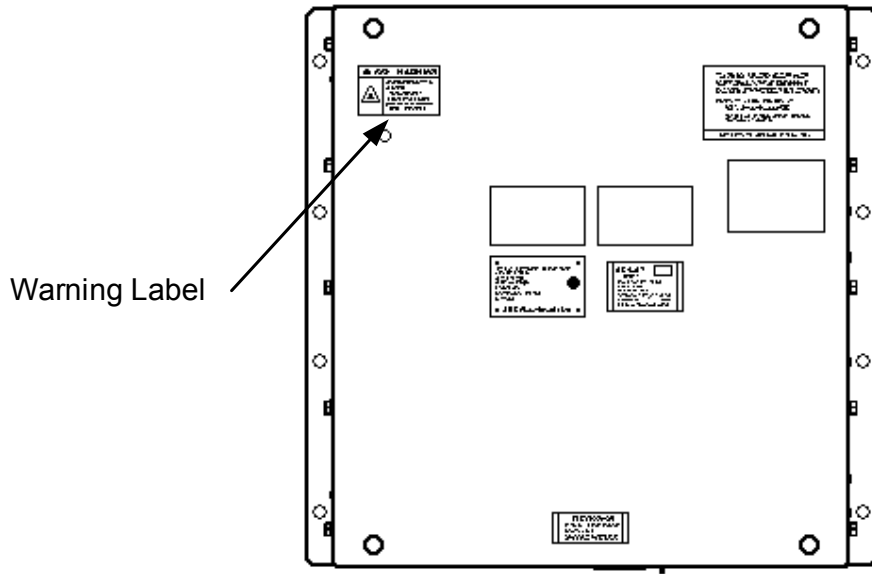

NDC-1399-9 Radar Process Unit
(Desktop Type)

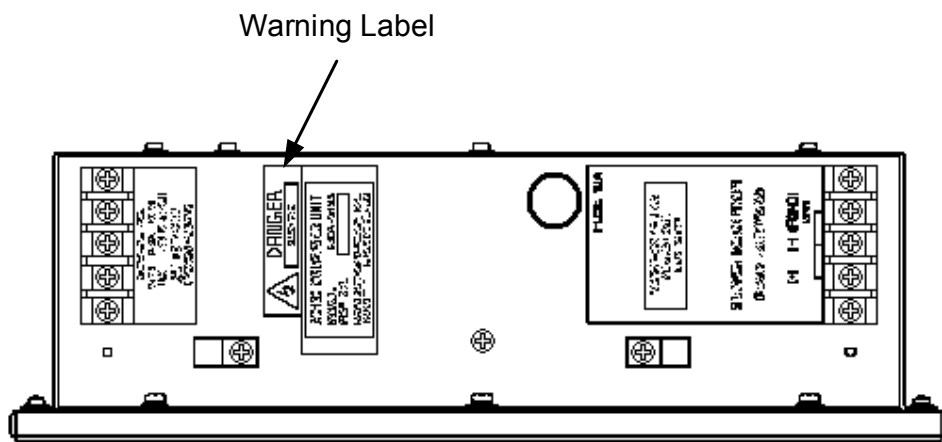

NBA-5135 AC/DC Converter
(Desktop Type)

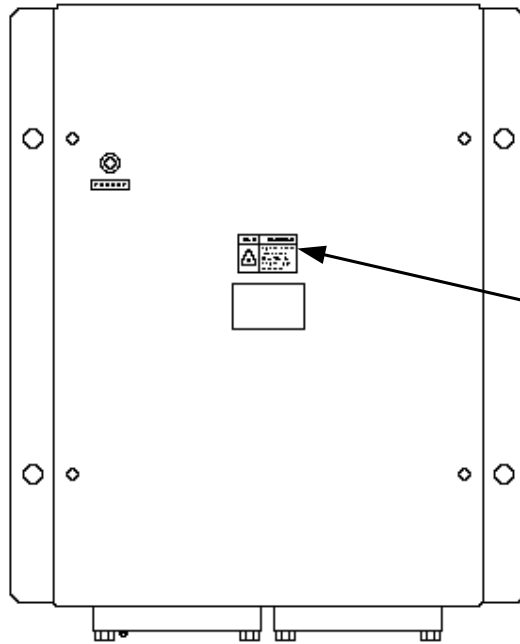

Warning
Label

NQE-3141-4A/8A Interswitch Unit

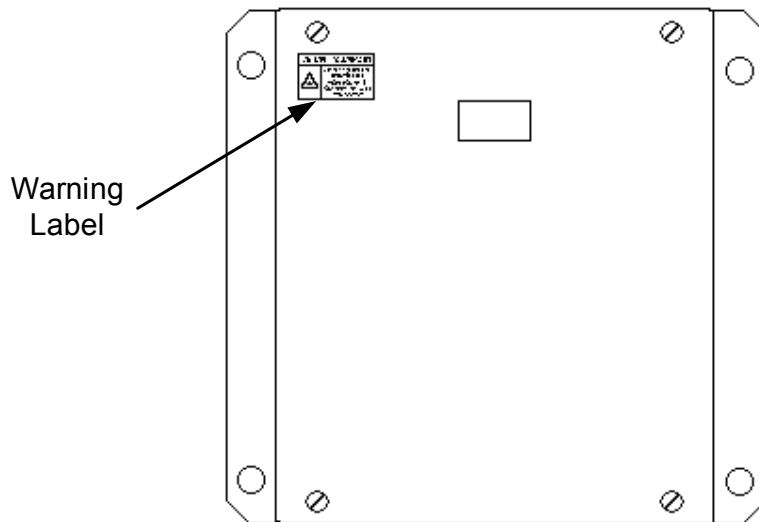

Warning
Label

NQE-3167 Power Control Unit

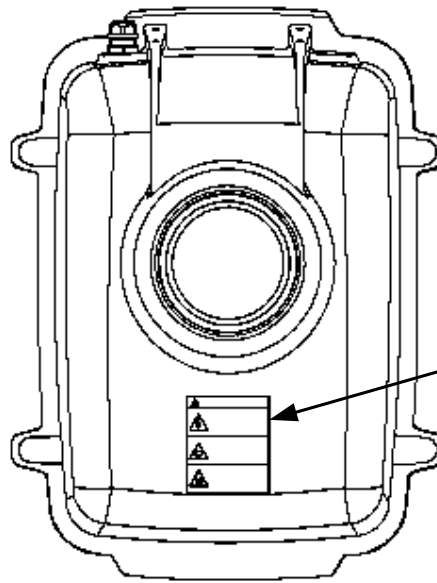

Warning Label

NKE-2103-6/6HS Scanner Unit

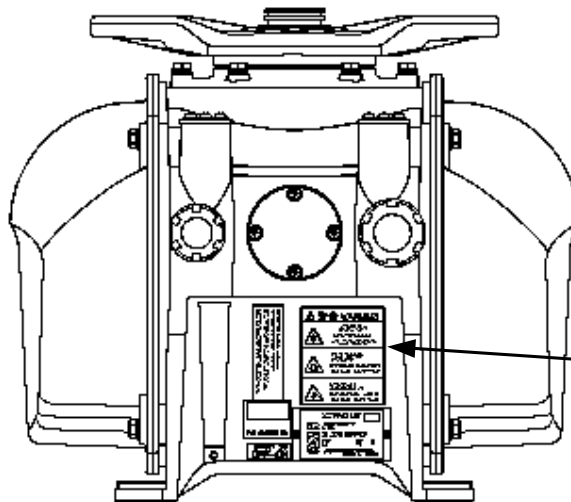

Warning

NKE-1129-7/9 Scanner Unit
NKE-1125-6/9 Scanner Unit
NKE-2254-6HS Scanner Unit

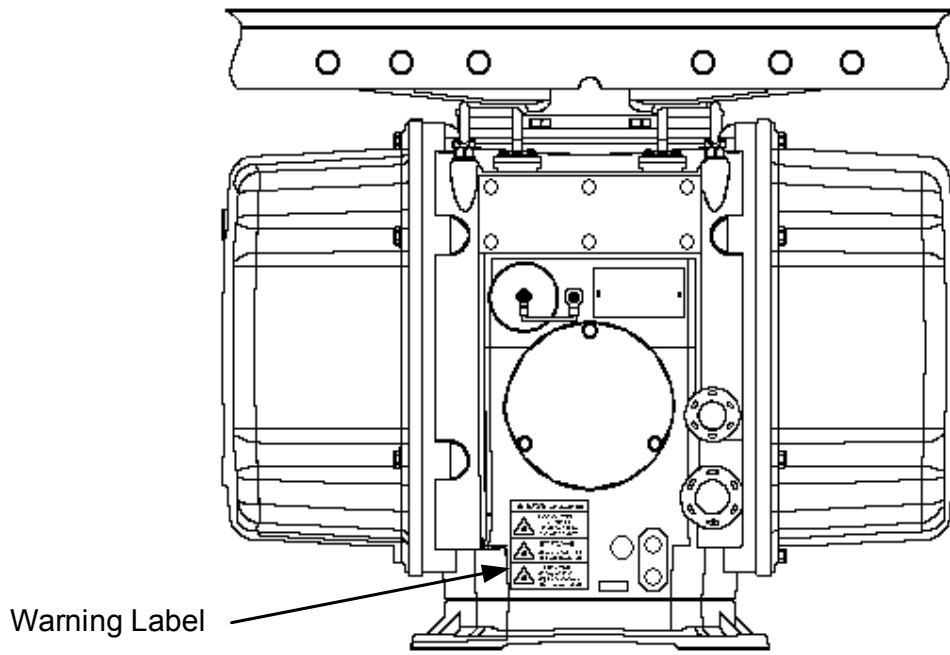

NKE-1139/1130 Scanner Unit

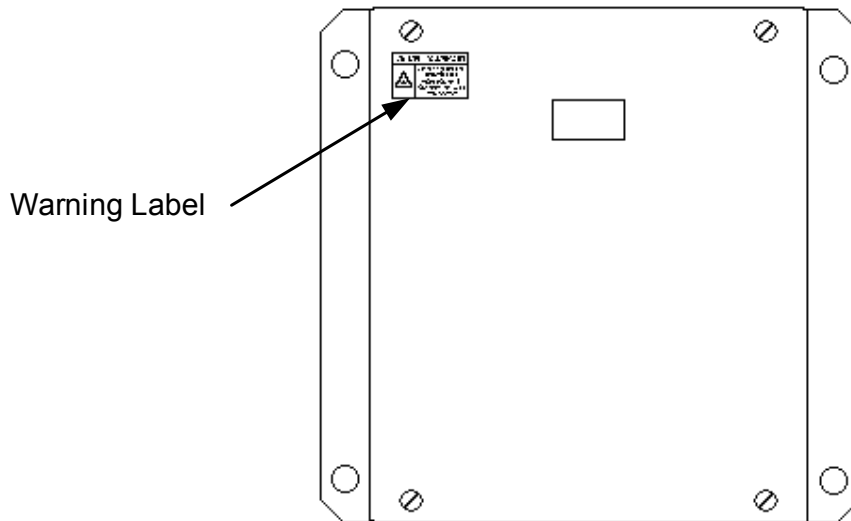

NTG-3230/3225 Transmitter Receiver Unit

EQUIPMENT APPEARANCE



Scanner Unit Type NKE-1130 (12 feet)



Scanner Unit Type NKE-1139 (12 feet)



Transmitter Receiver Unit Type NTG-3230(30kW)



Scanner Unit Type NKE-1129-7 (7 feet)



Scanner Unit Type NKE-1129-9 (9 feet)



Transmitter Receiver Unit Type NTG-3225(25kW)



Scanner Unit Type NKE-1125-6 (6 feet)



Scanner Unit Type NKE-1125-9 (9 feet)



Scanner Unit Type NKE-2254-6HS (6 feet)



Scanner Unit Type NKE-2103-6 (6 feet)



Scanner Unit Type NKE-2103-6HS (6 feet)



Power Control Unit Type NQE-3167



Display Unit Type NCD-4990 (Stand alone type)



Interswitch Unit Type NQE-3141-4A



Monitor Unit Type NWZ-170 (Desktop type)



Operation Unit Type NCE-5163 (Desktop type)



Radar Process Unit Type NDC-1399-9 (Desktop type)
DISPLAY UNIT TYPE NCD-4990T (DESKTOP TYPE)

GLOSSARY

This section describes the main terms used for this equipment and general related maritime terms.

A

AZ	Acquisition/Activation zone A zone set up by the operator in which the system should automatically acquire radar targets and activate reported AIS targets when entering the zone.
Activated target	A target representing the automatic or manual activation of a sleeping target for the display of additional information.
AIS	Automatic Identification System A system which enables ships and shore stations to obtain identifying and navigation information about other ships at sea, using an automated transponder.
Anti-clutter rain	Rain/snow clutter suppression.
Anti-clutter sea	Sea clutter suppression.
Associated target	A target simultaneously representing a tracked target and a reported AIS target having similar parameters (position, course, speed) which comply with an association algorithm.
AZI	AZImuth stabilization mode

B

BCR/BCT	Bow Crossing Range/Bow Crossing Time
----------------	--------------------------------------

C

C up	Course up Own ship's course is pointed to the top center of the radar display.
CCRP	Consistent Common Reference Point A location on own ship, to which all horizontal measurements such as target range, bearing, relative course, relative speed, CPA or TCPA are referenced, typically the conning position of the bridge.
Clutter	Unwanted reflections on a radar screen, from sea surface, rain or snow.
COG	Course Over Ground The direction of the ship's movement relative to the earth, measured on board the ship, expressed in angular units from true north
CORREL	CORRELation

CPA/TCPA The distance to the Closest Point of Approach/Time to the Closest Point of Approach.
Limits are set by the operator and are related to own ship.

CTW Course Through Water
The direction of the ship's movement through the water

D

DRIFT The current velocity for manual correction or the current speed on the horizontal axis of the 2-axis log is displayed.

E

EBL Electronic Bearing Line
An electronic bearing line originated from own ship's position.

ETA Estimated Time of Arrival

G

Ground stabilization A display mode in which speed and course information are referred to the ground, using ground track input data.

H

HDG Heading
The horizontal direction that the bow of a ship is pointing at any instant, expressed in angular units from a reference direction.

HL Heading line
A graphic line on a radar presentation drawn from the consistent common reference point to the bearing scale to indicate the heading of the ship .

HSC High Speed Craft
Vessels which comply with the definition in SOLAS for high speed craft

H up Head up
Own ship's heading line is always pointed to the top center of the radar display.

I

IMO International Maritime Organisation

IR RADAR Interference Rejector

ISW A device to switch over two or more radar display units and two or more scanners.

L

Lost AIS target	A target symbol representing the last valid position of an AIS target before the reception of its data was lost, or its last dead-reckoned position.
Lost tracked target	One for which target information is no longer available due to poor, lost or obscured signals.
LP	Long Pulse
M	
MMSI	Maritime Mobile Service Identity
MOB	Man OverBoard
MON	Performance monitor
MP	Medium Pulse
N	
NM	1nm=1852m
N up	North up
P	
PI	Parallel Index line
Past positions	Equally time-spaced past position marks of a tracked or AIS target and own ship.
POSN	POSitioN
PRF	Pulse Repetition Frequency The number of radar pulses transmitted each second.
PROC	PROCeSS Radar signal processing function
R	
Radar beacon	A navigation aid which responds to the radar transmission by generating a radar signal to identify its position and identity
Radar cross-section	Radar cross-section of a target determines the power density returned to the radar for a particular power density incident on the target
Range Rings	A set of concentric circles labeled by distance from CCRP.
Reference target	A symbol indicating that the associated tracked stationary target is used as a speed reference for the ground stabilisation
Relative speed	The speed of a target relative to own ship's speed data
Relative vector	A predicted movement of a target relative to own ship's motion

RM	Relative Motion A display on which the position of own ship remains fixed, and all targets move relative to own ship.
RM(R)	Relative Motion. Relative Trails.
RM(T)	Relative Motion. True Trails.
ROT	Rate Of Turn Change of heading per time unit.
Route	A set of waypoints.
RR	Range Rings

S

SART	Search And Rescue Transponder Radar transponder capable of operating in the 9GHz band
Sea stabilization	A display mode in which speed and course information are referred to the sea.
Sea state	Status of the sea condition due to the weather environment, expressed as a sea state 0 for flat conditions with minimal wind, to sea state 8 for very rough sea conditions.
SET	The current direction for manual correction or the current speed on the horizontal axis of the 2-axis log is displayed.
Sleeping AIS target	A target indicating the presence and orientation of a vessel equipped with AIS in a certain location.
SOG	Speed Over the Ground The speed of the ship relative to the earth, measured on board of the ship.
SP	Short Pulse
STAB	STABilization
STW	Speed Through Water The speed of the ship relative to the water surface.

T

TCPA	Time to Closest Point of Approach to own ship
Test target	Radar target of known characteristics used for test requirement
TM	True Motion A display across which own ship moves with its own true motion.
Trails	Tracks displayed by the radar echoes of targets in the form of an afterglow.

Trial manoeuvre	A graphical simulation facility used to assist the operator to perform a proposed maneuver for navigation and collision avoidance purposes.
True course	The direction of motion relative to ground or to sea, of a target expressed as an angular displacement from north
True speed	The speed of a target relative to ground, or to sea
True vector	A vector representing the predicted true motion of a target, showing course and speed with reference to the ground or sea
TT	Target Tracking. A computer process of observing the sequential changes in the position of a radar target in order to establish its motion. Such a target is a Tracked Target.
TTG	Time To Go. Time to next waypoint.
TXRX	Transmitter Receiver Unit

U

UTC	Universal Time Coordinated. The international standard of time, kept by atomic clocks around the world.
------------	--

V

VRM	Variable Range Marker An adjustable range ring used to measure the distance to a target.
------------	---

W

Waypoint	A geographical location on a route indicating a event.
-----------------	--

Index

◆◆◆ PRECAUTIONS BEFORE OPERATION ◆◆◆	i
◆◆◆ FIRST-AID TREATMENTS ◆◆◆	ii
PREFACE	V
The Mounting Point of the Warning Label	xv
EQUIPMENT APPEARANCE	xx
GLOSSARY	xxvi

SECTION 1

GENERAL AND EQUIPMENT COMPOSITION

1.1 FUNCTIONS	1-1
1.1.1 Function of This System	1-1
1.2 FEATURES	1-2
1.3 CONFIGURATION	1-4
1.4 EXTERIOR DRAWINGS	1-6
1.5 GENERAL SYSTEM DIAGRAMS	1-26

SECTION 2

NAMES AND FUNCTIONS OF CONTROL PANEL KEYS AND FUNCTIONS OF SOFTWARE BUTTONS

2.1 NAMES OF DISPLAY	2-1
2.2 NAMES AND FUNCTIONS OF CONTROL PANEL KEYS	2-11
2.3 FUNCTIONS OF SOFTWARE BUTTONS	2-16

SECTION 3

BASIC OPERATION

3.1 OPERATION FLOW	3-1
3.1.1 Power ON and Start the System	3-2
3.1.2 Observe and Adjust Video	3-4
3.1.3 Acquire and Measure Data	3-4
3.1.4 Display and Measure with Reference to CCRP	3-4
3.1.5 End the Operation and Stop the System	3-5
3.2 OBSERVE AND ADJUST VIDEO	3-6
3.2.1 Adjust Monitor Brilliance [BRILL]	3-6
3.2.2 Change Observation Range [RANGE+/-]	3-6
3.2.3 Tune	3-7
3.2.4 Adjust Gain [GAIN]	3-8
3.2.5 Suppress Sea Clutter [SEA]	3-9
3.2.6 Suppress Rain/Snow Clutter [RAIN]	3-11

3.2.7	Reset Alarm Buzzer [ALARM ACK]	3-12
3.2.8	To get the appropriate image that targets can be easily observed	3-13
3.3	OPERATION PROCEDURES	3-14
3.3.1	Move Cross Cursor Mark by Trackball	3-14
3.3.2	Operate Software Buttons	3-15
3.3.3	Basic Menu Operation	3-16
3.3.4	Operation on Numeric Value, Latitude / Longitude and Character Input menu	3-17
3.3.5	Overview of Menu Structure	3-22
3.4	GENERAL RADAR OPERATION	3-23
3.4.1	Interference Rejection (IR)	3-23
3.4.2	Switch Transmitter Pulse Length [GAIN]	3-24
3.4.3	Target Enhance (ENH)	3-25
3.4.4	Use Video Processing (PROC)	3-26
3.4.5	Switch Azimuth Display Mode (AZI MODE)	3-27
3.4.6	Switch True/Relative Motion Display Mode (TM/RM)	3-28
3.4.7	Move Own Ship's Display Position (Off Center)	3-29
3.4.8	Display Radar Trails (Trails)	3-30
3.4.9	Zoom (x2)	3-33
3.4.10	Hide/Display Range Rings [HL OFF]	3-34
3.4.11	Hide Graphics Information on Radar Display [DATA OFF]	3-34
3.4.12	Switch Day/Night Mode [DAY/NIGHT]	3-35
3.4.13	Adjust Operation Panel Brilliance [PANEL]	3-35
3.4.14	Set True Bearing	3-36
3.4.15	Set Own Ship Speed	3-36
3.4.16	Magnet Compass Correction (MAG Compass Setting)	3-37
3.5	USE OWN SHIP'S TRACK	3-39
3.5.1	Display Own Ship's Track (Display Own Track)	3-39
3.5.2	Set Display Color of Own Ship's Track (Display Own Track Color) ..	3-40
3.5.3	Save Own Ship's Track (Own Track Memory)	3-41
3.5.4	Cancel Saving of Own Ship's Track (Own Track Memory)	3-41
3.5.5	Clear Own Ship's Track (Clear Own Track)	3-42
3.5.6	Use Expanded Own Ship's Track (Own Track Type)	3-42
3.5.7	Use Water Depth Track (Water Depth Track)	3-44
3.5.8	Use Water Temperature Track (Water TEMP Track)	3-45
3.5.9	Use Tidal Current Track (Current Vector Track)	3-46

3.6	DISPLAY USER MAP	3-47
3.6.1	Create User Map (Mark/Line)	3-47
3.6.2	Set User Map Display (Mark Display Setting)	3-50
3.6.3	Edit User Map (Edit User Map)	3-52
3.6.4	Correct Position on User Map (Shift User Map)	3-60
3.6.5	Save User Map	3-61
3.6.6	Set and Display Geodetic System (Geodetic)	3-65
3.7	USE ROUTE FUNCTION	3-67
3.7.1	Display Route/Destination Mark (Select Route)	3-67
3.7.2	Edit Route (Set Route Sequence)	3-68
3.7.3	Edit Route Make with Latitude and Longitude (Waypoint Input)	3-75
3.7.4	Use Route Monitoring Function (Waypoint/Route Alarm)	3-79
3.7.5	Method of Using Route	3-81
3.7.6	Detailed Route Settings	3-82
3.7.7	Clear Waypoint/Route Data (Clear WPT/Route Data)	3-86
3.7.8	Operate Route Data File	3-87
3.8	APPLIED OPERATIONS	3-91
3.8.1	Set Radar Signal Processing (Process Setting)	3-91
3.8.2	Set Radar Trails (RADAR Trails Setting)	3-95
3.8.3	Set Scanner Unit (TXRX Setting)	3-97
3.8.4	Set Cursor (Cursor Setting)	3-98
3.8.5	Set Radar Display (Display Setting)	3-99
3.8.6	Adjust Sound Volume (Buzzer Volume)	3-102
3.8.7	Set User Option Keys [OPTION 1/2]	3-103
3.8.8	Set Navigation Data Display (Multi Window Setting)	3-105
3.8.9	AUTO Backup	3-110
3.9	USE FUNCTION KEY [USER]	3-111
3.9.1	Operation Procedures	3-111
3.9.2	Function Setting Menu Items	3-112
3.9.3	Overview of Function Operations (User Function Setting)	3-113
3.9.4	Overview of saved Function Setting Data	3-117
3.10	USE USER SETTING	3-118
3.10.1	Save Operating State (Save User Setting)	3-118
3.10.2	Load Operating State (Load User Setting)	3-119
3.10.3	Delete Operating State (Delete User Setting)	3-119

3.11	USING CARD	3-120
3.11.1	Operate File on the Card (File Manager)	3-120
SECTION 4		
MEASUREMENT OF RANGE AND BEARING		
4.1	USE OF NAVIGATION TOOLS	4-1
4.1.1	Using Cursor (Cursor)	4-2
4.1.2	Using Range Rings (Range Rings)	4-2
4.1.3	Using Electronic Bearing Line (EBL1/EBL2)	4-3
4.1.4	Using Parallel Index Lines (PI Menu)	4-8
4.1.5	Operating EBL Maneuver Function (EBL Maneuver Setting)	4-14
4.1.6	Operating EBL, VRM, and PI with Cursor	4-16
4.2	MEASUREMENT OF RANGE AND BEARING	4-19
4.2.1	Measurement with Cursor Position (Cursor)	4-19
4.2.2	Measurement with Electronic Bearing Line and Variable Range Marker [EBL] [VRM]	4-20
4.2.3	Measurement with Two Arbitrary Points	4-21
SECTION 5		
OPERATION OF TARGET TRACKING AND AIS		
5.1	PREPARATION	5-1
5.1.1	Collision Avoidance	5-2
5.1.2	Definitions of Symbols	5-5
5.1.3	Radar Display	5-8
5.1.4	Cursor Modes (Cursor)	5-10
5.1.5	Setting Collision Decision Criteria	5-12
5.1.6	Setting Vectors (Vector Time)	5-13
5.1.7	Setting the GPS antenna location	5-13
5.2	TARGET TRACKING OPERATION	5-14
5.2.1	Acquiring Target [ACQ]	5-14
5.2.2	Canceling Unwanted Tracked Targets [ACQ CANCEL]	5-16
5.2.3	Tracked Target Data Display [TGT DATA]	5-17
5.2.4	Displaying Target ID No.(Target Number Display)	5-18
5.2.5	Adding Tracked Target ID Name (Name)	5-19
5.2.6	Reference Target (Reference)	5-20
5.2.7	Operation Test (TT Test Menu)	5-21

5.3	AIS OPERATION	5-26
5.3.1	Restrictions	5-26
5.3.2	Setting AIS Display Function (AIS Function)	5-26
5.3.3	Activate AIS Targets (Activate AIS)	5-27
5.3.4	Deactivate AIS Targets (Deactivate AIS)	5-27
5.3.5	Displaying AIS Information [TGT DATA]	5-28
5.3.6	Displaying Target ID No. (Target Number Display)	5-31
5.3.7	Setting AIS Filter (AIS Filter Setting)	5-32
5.3.8	Conditions for Deciding AIS Target to be Lost	5-35
5.3.9	Setting Conditions for AIS Alarm (AIS Alarm Setting)	5-36
5.4	DECISION OF TARGETS AS IDENTICAL (Association)	5-37
5.4.1	Setting of Function to Decide Targets as Identical (Association)	5-37
5.4.2	Setting of Conditions for Deciding AIS and Tracked Targets as Identical (Association Setting)	5-37
5.4.3	Types of Decision Conditions to be Set	5-38
5.5	ALARM DISPLAY	5-39
5.5.1	CPA / TCPA Alarm	5-40
5.5.2	Alarm for New Target Acquired in Automatic Acquisition Zone (New Target)	5-41
5.5.3	Lost Target Alarm (Lost)	5-41
5.5.4	Gyro Set Alarm	5-42
5.6	TRACK FUNCTION	5-43
5.6.1	Past Position (Past POSN)	5-43
5.6.2	Target Ship's Tracks (Target Track)	5-44
5.7	TRIAL MANEUVERING (Trial Maneuver)	5-53
5.7.1	Trial Maneuvering in the True Vector Mode	5-54
5.7.2	Trial Maneuvering in the Relative Vector Mode	5-55
5.7.3	Operation of Trial Maneuvering Function	5-56

SECTION 6

TRUE AND FALSE ECHOES ON DISPLAY

6.1	RADAR WAVE WITH THE HORIZON	6-1
6.2	STRENGTH OF REFLECTION FROM THE TARGET	6-3
6.3	SEA CLUTTER AND RAIN AND SNOW CLUTTER	6-5
6.4	FALSE ECHOES	6-9
6.5	DISPLAY OF RADAR TRANSPONDER (SART)	6-12

SECTION 7

SETTINGS FOR SYSTEM OPERATION

7.1	SETTINGS AT INSTALLATION	7-1
7.1.1	How to Open the Serviceman Menu (Service Man Menu)	7-1
7.1.2	GYRO I/F Setting	7-2
7.1.3	Tuning (Tune Adjustment)	7-5
7.1.4	Bearing Adjustment	7-7
7.1.5	Range Adjustment	7-7
7.1.6	Navigator Setting (Device)	7-8
7.1.7	Setting of True Bearing Value	7-9
7.1.8	Antenna Height Setting (Antenna Height)	7-9
7.1.9	Setting of CCRP (CCRP Setting)	7-10
7.2	SETTINGS	7-12
7.2.1	Communication Port Setting (COM Port Setting)	7-12
7.2.2	Sector Blank Setting (Sector Blank)	7-16
7.2.3	TNI Blank Setting (TNI Blank)	7-17
7.2.4	Setting of Bearing Pulses from Scanner Unit (Output Pulse)	7-18
7.2.5	Slave Mode Setting (Master/Slave)	7-19
7.2.6	Language Setting (Language)	7-20
7.2.7	Date Time Setting	7-20
7.2.8	Input Installation Information	7-21
7.2.9	Setting the Alarm System	7-22
7.3	ADJUSTMENT	7-26
7.3.1	Noise Level Adjustment (Noise Level)	7-26
7.3.2	Adjustment of Target Tracking Function (TT)	7-27
7.3.3	Main Bang Suppression Level Adjustment (MBS)	7-29
7.3.4	Adjustment of Performance Monitor	7-31
7.4	MAINTENANCE MENU	7-33
7.4.1	Antenna Safety Switch (Safety Switch)	7-33
7.4.2	Initialization of Memory Area(Area Initial)	7-34
7.4.3	Save of Internal Memory Data (Card1/2)	7-35
7.4.4	Restoration of Scanner Unit Operation Time (TXRX Time)	7-36
7.4.5	Update of Character String Data (String Data Update)	7-38

SECTION 8

COUNTERMEASURES FOR TROUBLE AND ADJUSTMENT



8.1	ROUTINE MAINTENANCE	8-1
8.2	MAINTENANCE ON EACH UNIT	8-2
8.2.1	Scanner Unit NKE-1125/1129/1130/1139/2103/2254	8-2
8.2.2	Wave Guide Tube (JMA-9123-7XA/9XA)	8-4
8.2.3	Coaxial Cable (JMA-9133-SA)	8-4
8.2.4	Transmitter Receiver Unit (NTG-3225/3230)	8-5
8.2.5	Display Unit (NCD-4990)	8-5
8.3	PERFORMANCE CHECK	8-6
8.3.1	Check Performance on Test Menu	8-6
8.4	REPLACEMENT OF MAJOR PARTS	8-12
8.4.1	Parts Required for Periodic Replacement	8-13
8.4.2	Replacement of magnetron	8-13
8.4.3	Replacement of Motor	8-28
8.4.4	Replacement of LCD Monitor	8-33
8.4.5	Replacement of Backup Battery	8-36

SECTION 9

TROUBLE SHOOTING AND AFTER-SALES SERVICE

9.1	FAULT FINDING	9-1
9.1.1	List of Alarms and other Indications	9-1
9.1.2	Operation Checking	9-5
9.1.3	Fuse Checking	9-5
9.2	TROUBLE SHOOTING	9-6
9.2.1	Special Parts	9-7
9.2.2	Circuit Block to be Repaired	9-8
9.3	AFTER-SALES SERVICE	9-14
9.3.1	Keeping period of maintenance parts	9-14
9.3.2	When you Request for Repair	9-14
9.3.3	Recommended Maintenance	9-14

SECTION 10

DISPOSAL

10.1	DISPOSAL OF THE UNIT	10-1
10.2	DISPOSAL OF USED BATTERIES	10-1
10.3	DISPOSAL OF USED MAGNETRON	10-2
10.4	DISPOSAL OF TR-TUBE	10-2

10.5	ABOUT THE CHINA ROHS	10-3
------	----------------------------	------

**SECTION 11
SPECIFICATION**

11.1	JMA-9133-SA TYPE RADAR	11-1
11.2	JMA-9132-SA TYPE RADAR.....	11-2
11.3	JMA-9123-7XA/9XA TYPE RADAR	11-3
11.4	JMA-9122-6XA/9XA TYPE RADAR	11-4
11.5	JMA-9122-6XAH TYPE RADAR	11-5
11.6	JMA-9110-6XA TYPE RADAR	11-6
11.7	JMA-9110-6XAH TYPE RADAR	11-7
11.8	SCANNER UNIT (NKE-1139)	11-8
11.9	SCANNER UNIT (NKE-1130)	11-9
11.10	SCANNER UNIT (NKE-1129-7/9)	11-10
11.11	SCANNER UNIT (NKE-1125-6/9)	11-11
11.12	SCANNER UNIT (NKE-2254-6HS)	11-12
11.13	SCANNER UNIT (NKE-2103-6)	11-13
11.14	SCANNER UNIT (NKE-2103-6HS)	11-14
11.15	TRANSMITTER RECEIVER UNIT (NTG-3230)	11-15
11.16	TRANSMITTER RECEIVER UNIT (NTG-3225)	11-16
11.17	DISPLAY UNIT (NCD-4990)	11-17
11.18	Target Tracking Function	11-20
11.19	AIS FUNCTION	11-21
11.20	PERFORMANCE MONITOR (NJU-84)	11-22
11.21	PERFORMANCE MONITOR (NJU-85)	11-22
11.22	AC-DC CONVERTER (NBA-5135)	11-22

Appendix A

NQE-3141 Interswitch Unit

A.1	OVERVIEW	A-1
A.1.1	Overview	A-1
A.1.2	Interswitch Setup	A-1
A.2	INTERSWITCH OPERATION	A-3
A.2.1	Operation Flow	A-3
A.2.2	Inter Switch Menu	A-4
A.2.3	Change of Connection Pattern (with 2 Display Units)	A-6

A.2.4	Change of Connection Pattern (with 3 or More Display Units) ..	A-7
A.2.5	Operating Connection Pattern Files (File Operations)	A-8
A.2.6	Names of Display Units and Scanner Units	A-9
A.3	REFERENCE	A-10
A.3.1	Preheat Time after Change of Connection Pattern	A-10
A.3.2	Notes on Changing Connection Pattern	A-10
A.3.3	Notes on Connecting Slave Display Unit	A-10
A.3.4	Setting at Installation	A-11

Appendix B DRAWINGS

B.1	Interconnection Diagram of Display Unit	B-1
B.1.1	NCD-4990	B-2
B.1.2	NCD-4990 w/NBA-5135	B-3
B.1.3	NCD-4990T	B-4
B.1.4	NCD-4990T w/NBA-5135	B-5
B.1.5	NWZ-170-R	B-6
B.1.6	NWZ-170-RT	B-7
B.1.7	NCE-5163-R	B-8
B.1.8	NCE-5163-RT	B-9
B.1.9	NBA-5135	B-10
B.2	Power System Diagram of Display Unit	B-11
B.3	Signal Flow Diagram of Display Unit	B-12
B.4	Primary Power System Diagram	B-13
B.5	Block Diagram of Scanner Unit	B-14
B.5.1	NKE-2103	B-15
B.5.2	NKE-2254	B-16
B.5.3	NKE-1125/NKE-1130	B-17
B.5.4	NKE-1129, NTG-3225 / NKE-1139, NTG-3230	B-18
B.6	Interconnection Diagram of Scanner Unit	B-19
B.6.1	NKE-2103	B-20
B.6.2	NKE-2254	B-21
B.6.3	NKE-1125 (AC110V)	B-22
B.6.4	NKE-1125 (AC220V)	B-23
B.6.5	NKE-1129 (AC110V)	B-24
B.6.6	NKE-1129 (AC220V)	B-25

B.6.7	NTG-3225	B-26
B.6.8	NKE-1130 (AC110V)	B-27
B.6.9	NKE-1130 (AC220V)	B-28
B.6.10	NKE-1139 (AC110V)	B-29
B.6.11	NKE-1139 (AC220V)	B-30
B.6.12	NTG-3230	B-31
B.7	Terminal Board Connection Diagram	B-32
B.7.1	JMA-9110-6XA/JMA-9110-6XAH	B-33
B.7.2	JMA-9110-6XA/JMA-9110-6XAH (desktop)	B-34
B.7.3	JMA-9122-6XAH	B-35
B.7.4	JMA-9122-6XAH (desktop)	B-36
B.7.5	JMA-9122-6XA/9XA	B-37
B.7.6	JMA-9123-7XA/9XA	B-38
B.7.7	JMA-9132-SA	B-39
B.7.8	JMA-9133-SA	B-40
B.7.9	NCD-4990T	B-41
B.8	GYRO I/F	B-42
B.9	Inter Switch Unit	B-44
B.9.1	Terminal Board Connection Diagram	B-44
B.9.2	Interconnection Diagram	B-46

Appendix C

Menu Index

C.1	Main	C-1
C.2	PI	C-5
C.3	TT	C-7
C.4	AIS	C-8
C.5	AZ	C-9
C.6	Track	C-10
C.7	Route	C-11
C.8	U.Map	C-12
C.9	Serviceman Menu	C-14

1	GENERAL AND EQUIPMENT COMPOSITION
2	NAMES AND FUNCTIONS OF CONTROL PANEL KEYS AND FUNCTIONS OF SOFTWARE BUTTONS
3	BASIC OPERATION
4	MEASUREMENT OF RANGE AND BEARING
5	OPERATION OF TARGET TRACKING AND AIS
6	TRUE AND FALSE ECHOES ON DISPLAY
7	SETTINGS FOR SYSTEM OPERATION
8	COUNTERMEASURES FOR TROUBLE AND ADJUSTMENT
9	TROUBLE SHOOTING AND AFTER-SALES SERVICE
10	DISPOSAL
11	SPECIFICATIONS

Appendix

1

2

3

4

5

6

7

8

9

10

11

A

SECTION 1

GENERAL AND EQUIPMENT COMPOSITION

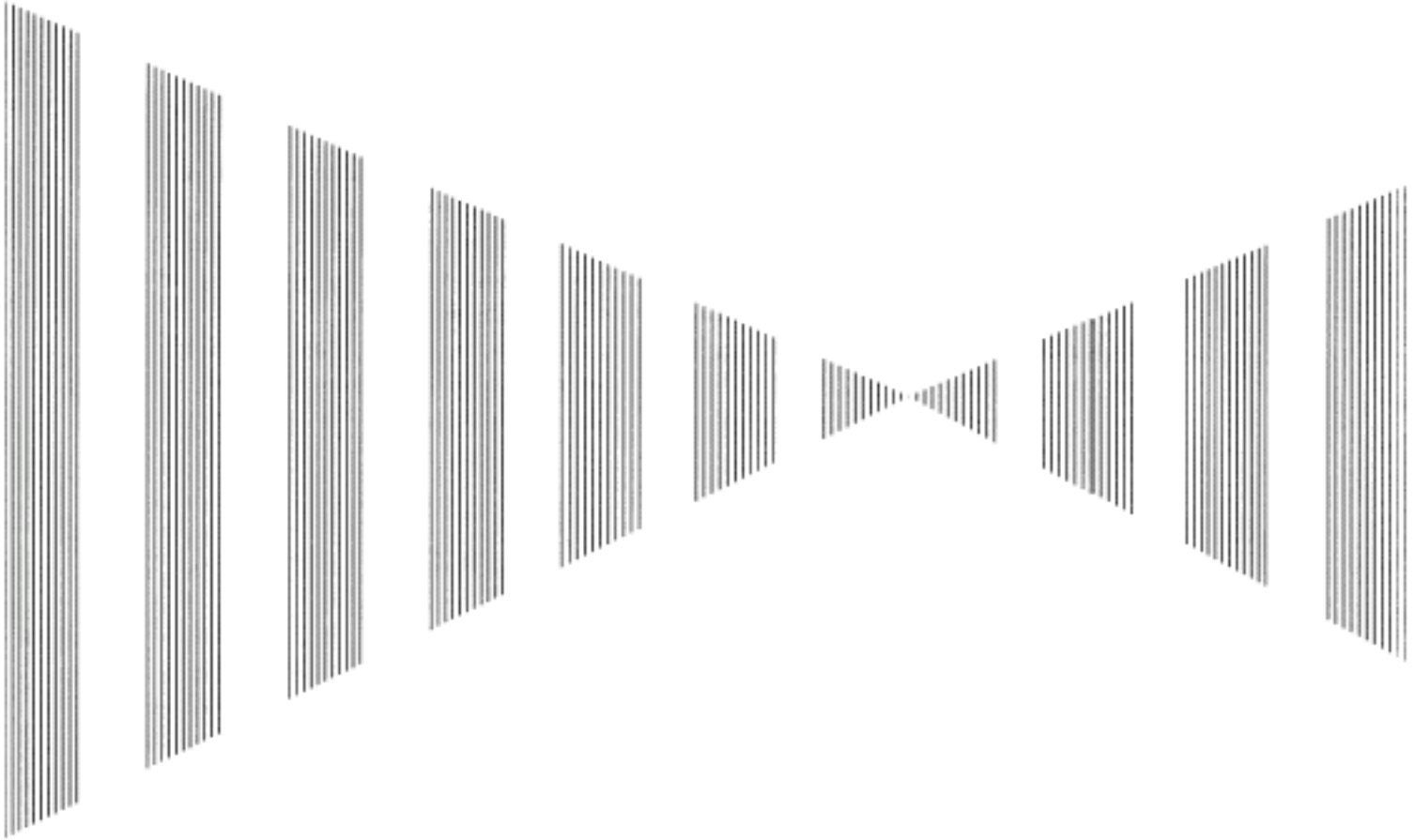

GENERAL AND EQUIPMENT COMPOSITION

1.1	FUNCTIONS	1-1
1.1.1	Function of This System	1-1
1.2	FEATURES	1-2
1.3	CONFIGURATION	1-4
1.4	EXTERIOR DRAWINGS	1-6
1.5	GENERAL SYSTEM DIAGRAMS	1-26

1.1

FUNCTIONS

1

This equipment is a high-performance radar equipment consisting of a scanner unit, a transmitter-receiver unit and a high resolution color LCD display unit.

This equipment complies with the performance standard of IMO.

1.1.1 Function of This System

The JMA-9100 series is a color radar system designed to comply with the international standards of the IMO. The main functions include:

- sensitivity adjustment
- sea clutter and rain/snow clutter suppression
- interference rejection
- bearing and range measurement using a cursor, fixed/variable range markers, and electronic bearing line
- colored own track display(7 colors)
- NAV line and marker displays
- TM (True Motion) presentation
- self-diagnostic facilities
- radar performance monitoring (Performance Monitor)
- Target Tracking functions (manual/automatic, target acquisition and tracking, vector and trail displays, Trial maneuver and alarm displays)
- 8-unit switchover (Interswitch) function (option)

1.2 FEATURES

Realization of Large, Easy-to-see Screen with High Resolution

The 23.1-inch color LCD with high resolution of 1600x1200 pixels can display radar images of 320 mm or more in diameter. Even short-range targets can also be displayed as high-resolution images.

Target Detection by Latest Signal Processing Technology

The system employs the latest digital signal processing technology to eliminate undesired clutter from the radar video signals that are obtained from the receiver with a wide dynamic range, thus improving the target detection.

Target Tracking (TT) Function based on Advanced Technology

The target acquisition and tracking performance is enhanced by the use of the fastest DSP and tracking algorithm. So stable operation in target tracking under clutter is ensured.

- Acquisition and tracking of 100 targets.
- Hazardous conditions are represented by shapes and colors of symbols as well as sounds.
- Trial maneuvering functions provided.
- Tracks of up to 20 target ships can be stored with a maximum of 1,500 points for each of them, and displayed distinguished by using seven different colors.

Overlay of Radar Images, Coastlines, and Own Ship's Track

As well as operator-created NAV lines and own ship's tracks/ARPA tracks, which is stored on the memory card can be superimpose-displayed with radar images and radar trails in all display modes including the head-up mode.

Easy Operation with GUI

All the radar functions can be easily controlled by simply using the trackball and two switches to operate the buttons shown on the radar display.

Improved Day/Night Mode

Five types of background colors are available in Day/Dusk/Night mode (total 5 background colors). Each background color can be reproduced to be suited for the user's operating environment by simple key operation. The radar echoes and a variety of graphics can also be represented in different colors, ensuring easy-to-see displays.

Compact Design and Low Power Consumption

Since an LCD has been implemented as the display device, the weight of the display is greatly reduced and the power consumption is lowered in comparison with the conventional radar equipment.

Self-diagnostic Program Incorporated

The Self-diagnostic program always monitors all the functions of the system. If any function deteriorates, an alarm message will appear on the radar display and an alarm sounds at the same time. Even when the system is operating, the functionality test can be carried out. (except on some functions)

Performance Monitor

The radar performance (transmitted output power and receiving sensitivity) can appear on the radar display.

Easy Interswitch Operation (Option)

If an interswitch unit (option) is connected, up to eight JMA-9100 radars can be switched over by performing simple operation.

Up to 2 radars: NQA-3141-2A is needed in Display Unit.

Up to 4 radars: NQA-3141-4A is needed separately.

Up to 8 radars: NQA-3141-8A is needed separately.

Various Functions

- RADAR Trails (Other ship's track display)
- TM (True Motion) display
- Head-up/North-up/Course-up display
- Own ship's track display
- Auto-acquisition Zone function

1.3 CONFIGURATION

Table1-1:Specified of scanner, and categories of ship/craft for SOLAS V

Radar model	Antenna type	Transmitted Output Power	Band	Rate of rotation	Category
JMA-9133-SA	12ft Slotted Antenna	30kW	S	24rpm	CAT 1
JMA-9132-SA	12ft Slotted Antenna	30kW	S	24rpm	CAT 1
JMA-9123-7XA	7ft Slotted Antenna	25kW	X	24rpm	CAT 1
JMA-9123-9XA	9ft Slotted Antenna	25kW	X	24rpm	CAT 1
JMA-9122-6XA	6ft Slotted Antenna	25kW	X	24rpm	CAT 1
JMA-9122-9XA	9ft Slotted Antenna	25kW	X	24rpm	CAT 1
JMA-9122-6XAH	6ft Slotted Antenna	25kW	X	48rpm	CAT 1H
JMA-9110-6XA	6ft Slotted Antenna	10kW	X	27rpm	CAT 1
JMA-9110-6XAH	6ft Slotted Antenna	10kW	X	48rpm	CAT 1H

※ The class of emission: P0N (All scanner types)

Table1-2:Radar Configuration and Ship's Mains

Radar model	Scanner Unit	Performance Monitor	Transmitter Receiver Unit	Display Unit	Ship' s Main
JMA-9133-SA	NKE-1139	NJU-84	NTG-3230	NCD-4990	AC100 to 115V, or AC220 to 240V 50/60Hz 1φ
JMA-9132-SA	NKE-1130	NJU-84	——	NCD-4990	
JMA-9123-7XA	NKE-1129-7	NJU-85	NTG-3225	NCD-4990	
JMA-9123-9XA	NKE-1129-9	NJU-85	NTG-3225	NCD-4990	
JMA-9122-6XA	NKE-1125-6	NJU-85	——	NCD-4990	
JMA-9122-9XA	NKE-1125-9	NJU-85	——	NCD-4990	
JMA-9122-6XAH	NKE-2254-6HS	NJU-85	——	NCD-4990	AC100 to 115V, or AC220 to 240V 50/60Hz 1φ
JMA-9110-6XA	NKE-2103-6	NJU-85	——	NCD-4990	
JMA-9110-6XAH	NKE-2103-6HS	NJU-85	——	NCD-4990	

Notes:

- 1) **The drive motor for the scanner unit is available in AC100-115V or AC220-240V type for NKE-1139/1130/1125/1129 series. Please specify the motor type when ordering.**
- 2) **The motor of NKE-2254/2103 can operate under both AC100-115V and AC220-240V, then need not to specify the motor type.**
- 3) **When using NKE-2254/2103, they need AC/DC Converter Unit NBA-5135 (Option) in display unit.**
- 4) **The scanner unit except NKE-2103 series can be equipped with a deicing heater as an option, and '-D' shall be suffixed to the type name. (e.g. NKE-1139-D, NKE-1125-6D).**
- 5) **When using the ship's mains of AC440V as the radar power source, a step-down transformer shall be used.**
- 6) **The desktop option is available for display NCD-4990. It has a separate structure consisting of the following:**

Monitor Unit	NWZ-170
Radar Processor Unit	NDC-1399-9
Operation unit	NCE-5163

- 7) **In JMA-9123, the following type name of JRC is used for the waveguide between the scanner unit and the transmitter receiver unit.**

Type of Radar	Waveguide	Length(m)	Type name of JRC
JMA-9123-7XA/9XA	FR-9	20MT	H-7AWRD0003
JMA-9123-7XA/9XA	FR-9	30MT	H-7AWRD0004

- 8) **In JMA-9133, the following type name of JRC is used for the RF coaxial cable between the scanner unit and the transmitter receiver unit.**

Type of Radar	RF COAX cable	Length(m)	Type name of JRC
JMA-9133-SA	HF-20D	30MT	HF-20D (30MT)

1.4 EXTERIOR DRAWINGS

Fig 1-1: Outline Drawing of Scanner Unit, Type NKE-1139

Fig 1-2: Outline Drawing of Scanner Unit, Type NKE-1130

Fig 1-3: Outline Drawing of Scanner Unit, Type NKE-1129-7

Fig 1-4: Outline Drawing of Scanner Unit, Type NKE-1129-9

Fig 1-5: Outline Drawing of Scanner Unit, Type NKE-1125-6

Fig 1-6: Outline Drawing of Scanner Unit, Type NKE-1125-9

Fig 1-7: Outline Drawing of Scanner Unit, Type NKE-2254-6HS

Fig 1-8: Outline Drawing of Scanner Unit, Type NKE-2103-6

Fig 1-9: Outline Drawing of Scanner Unit, Type NKE-2103-6HS

Fig 1-10: Outline Drawing of Transmitter Receiver Unit, Type NTG-3230

Fig 1-11: Outline Drawing of Transmitter Receiver Unit, Type NTG-3225

Fig 1-12: Outline Drawing of Display Unit, Type NCD-4990

Fig 1-13: Outline Drawing of Monitor Unit, Type NWZ-170 (Desktop type option)

Fig 1-14: NDOutline Drawing of Radar Process Unit, Type NDC-1399-9 (Desktop type option)

Fig 1-15: Outline Drawing of Operation Unit, Type NCE-5163 (Desktop type option)

Fig 1-16: Outline Drawing of AC/DC Converter Unit, Type NBA-5135 (Desktop type option)

Fig 1-17: Outline Drawing of Interswitch Unit, Type NQE-3141-4A (Option)

Fig 1-18: Outline Drawing of Interswitch Unit, Type NQE-3141-8A (Option)

Fig 1-19: Outline Drawing of Power Control Unit, Type NQE-3167 (Option)

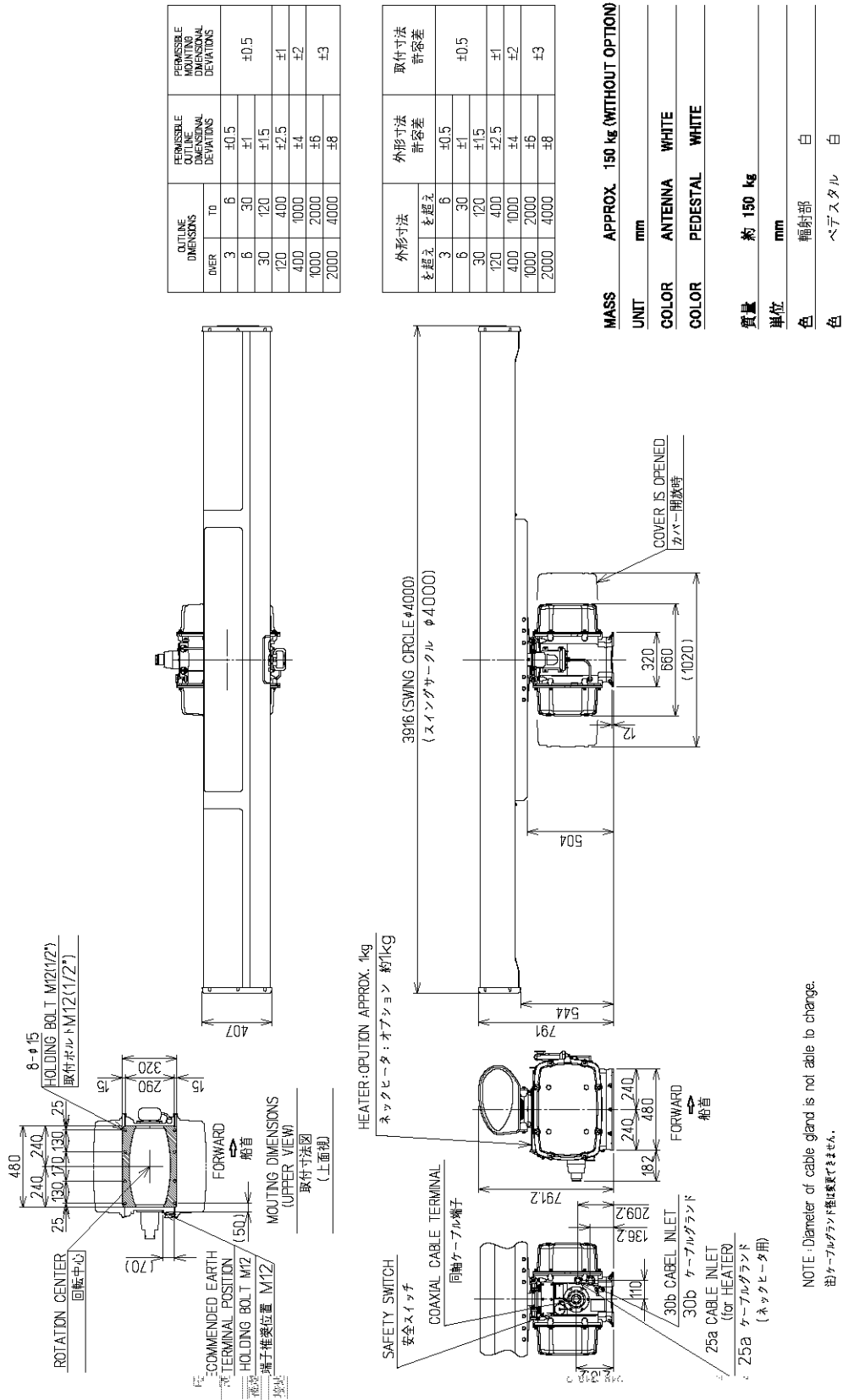

Fig 1-1: Outline Drawing of Scanner Unit, Type NKE-1139



SCANNER UNIT OUTLINE DRAWING

NIKE-1139

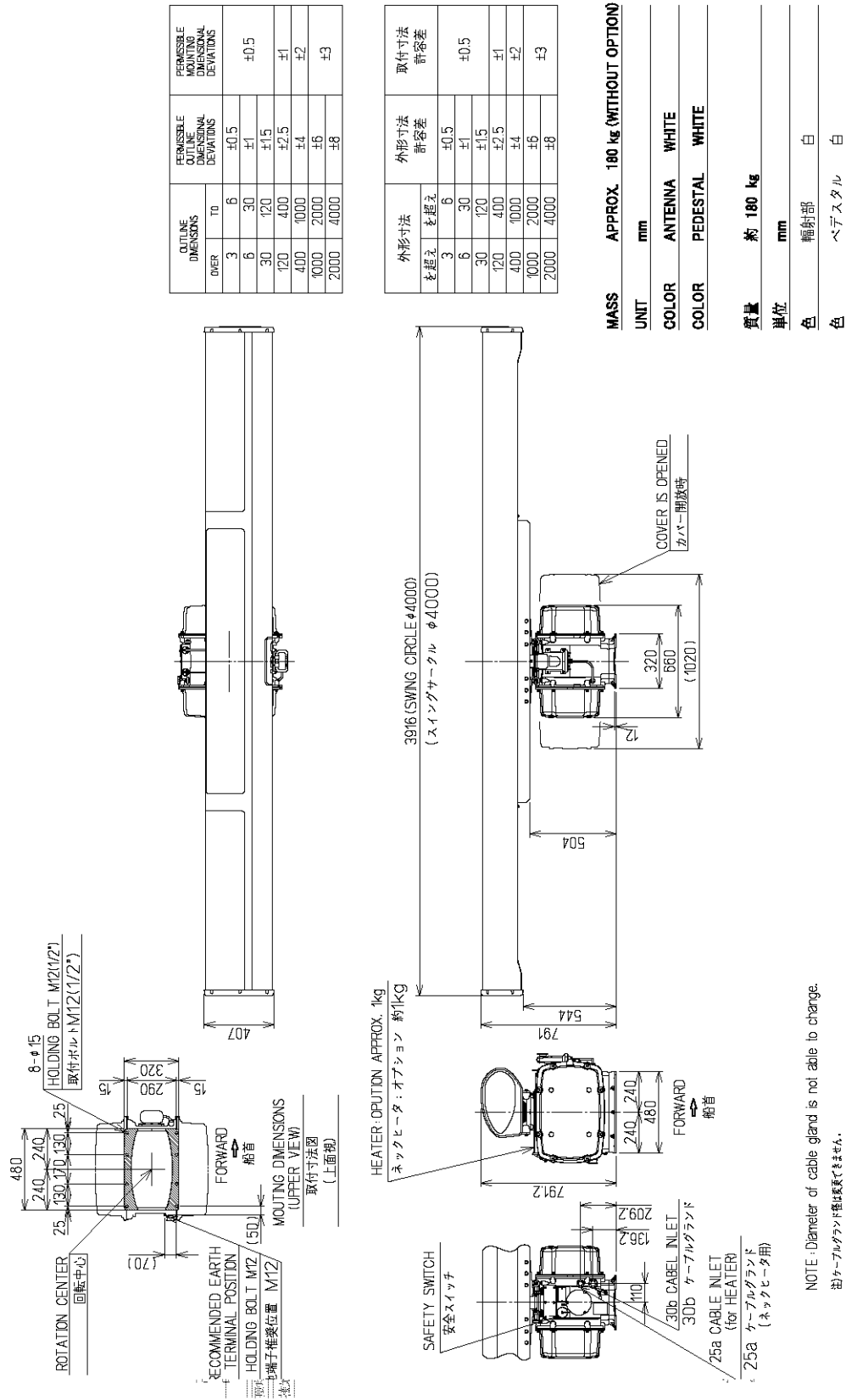
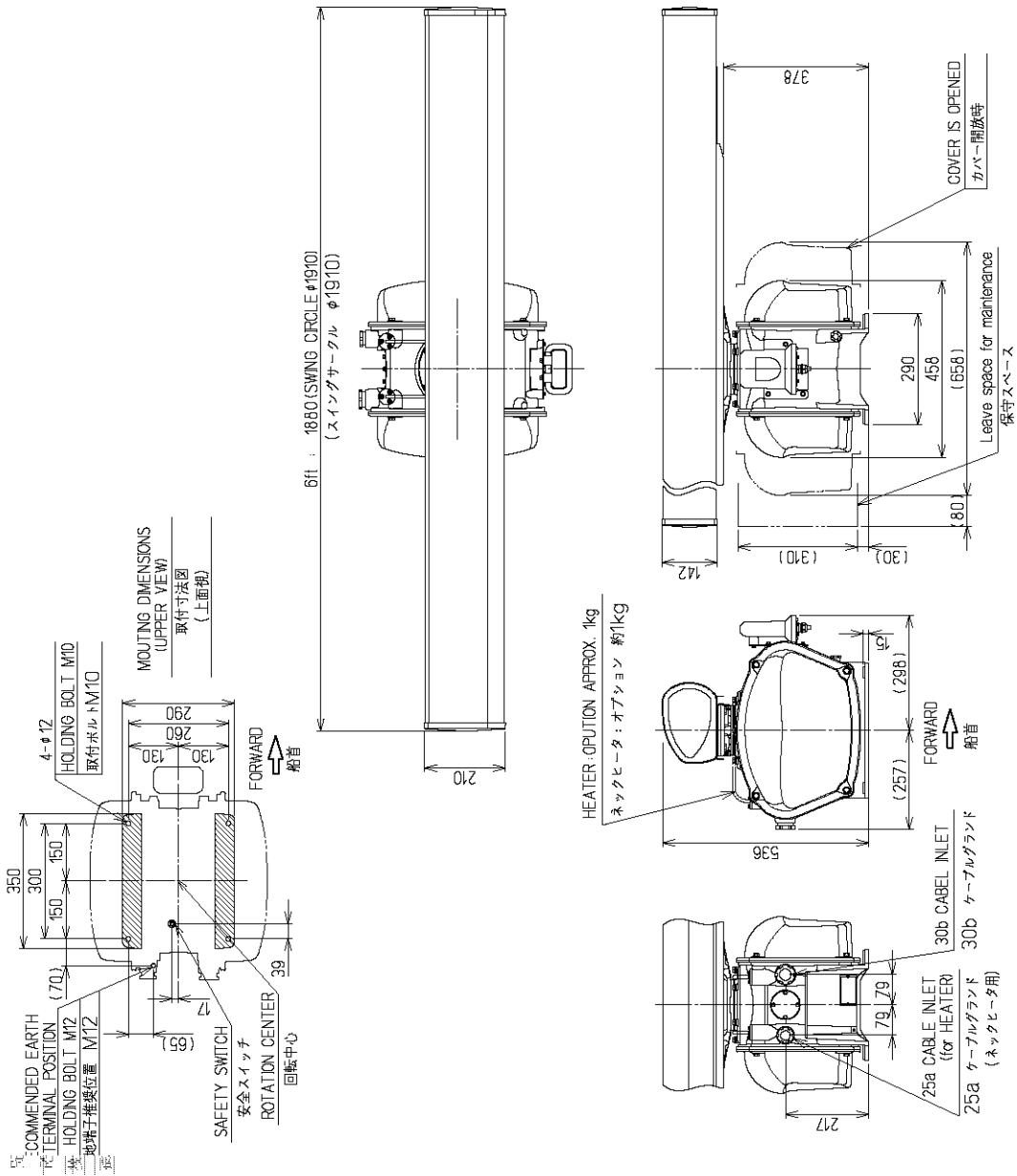

Fig 1-2: Outline Drawing of Scanner Unit, Type NKE-1130



OUTLINE DIMENSIONS		PERMISSIBLE MOUNTING POSITIONAL DEVIATIONS
OTHER	T0	
3	6	±0.5
6	30	±1
30	120	±1.5
120	400	±2.5
400	1000	±4
1000	2000	±6
2000	4000	±8

外形寸法		取付寸法 許容差
寸法	以下	
3	6	±0.5
6	30	±1
30	120	±1.5
120	400	±2.5
400	1000	±4
1000	2000	±6
2000	4000	±8

MASS APPROX. 55 kg (WITHOUT OPTION)

UNIT	mm
COLOR	ANTENNA WHITE
COLOR	PEDESTAL WHITE

質量 約 55 kg
 単位 mm
 色 輻射部 白
 色 ベース部 白

SCANNER UNIT OUTLINE DRAWING

NOTE : Diameter of cable gland is not able to change.
 (注) ケーブルグラウンド径は変更できません。

SCNKE5297

Fig 1-5: Outline Drawing of Scanner Unit, Type NKE-1125-6



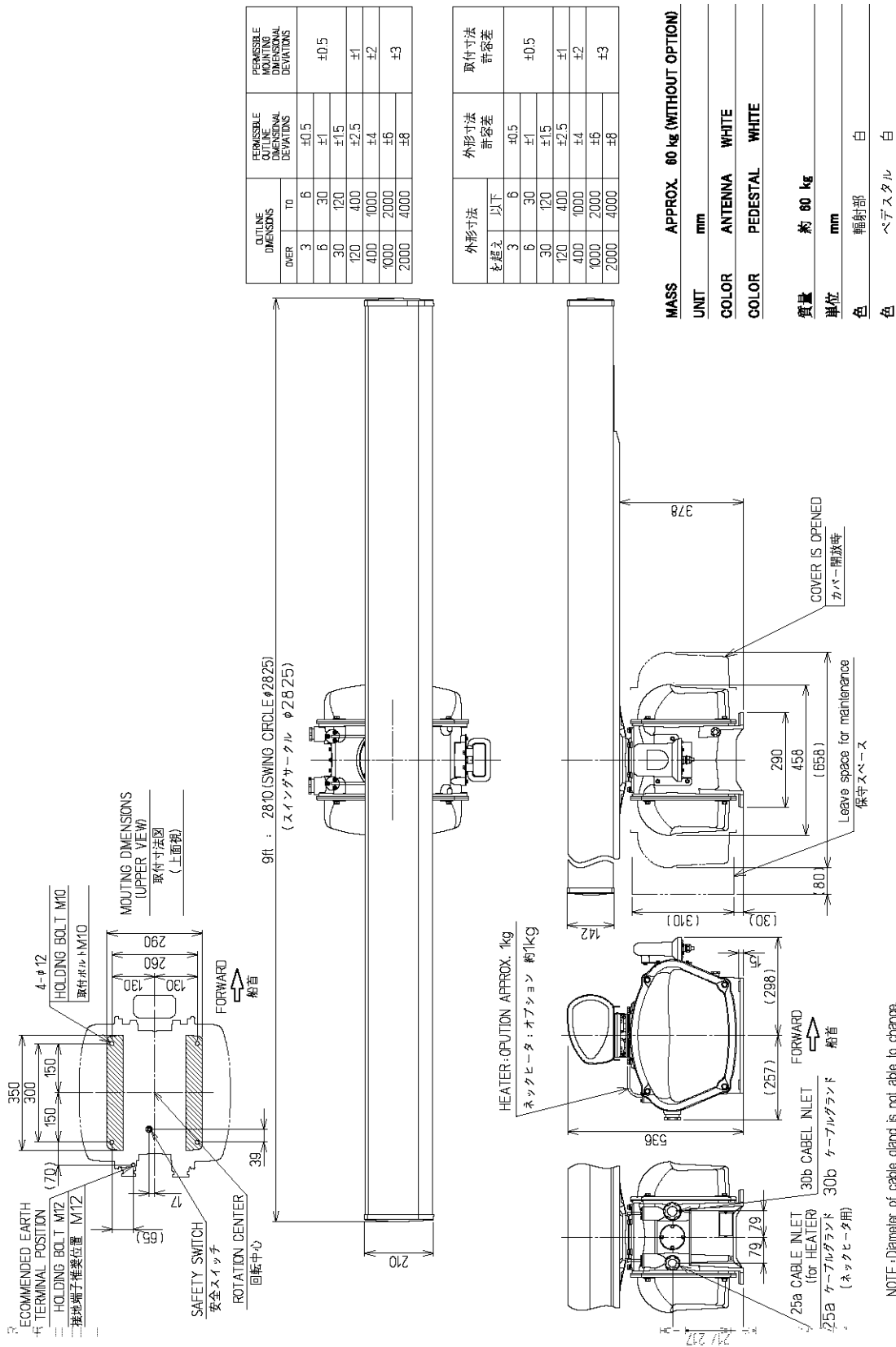

SCANNER UNIT OUTLINE DRAWING

NKE-1125-9

NOTE : Diameter of cable gland is not able to change.
(注) ケーブルランド径は変更できません。

SCNKE5296

Fig 1-6: Outline Drawing of Scanner Unit, Type NKE-1125-9

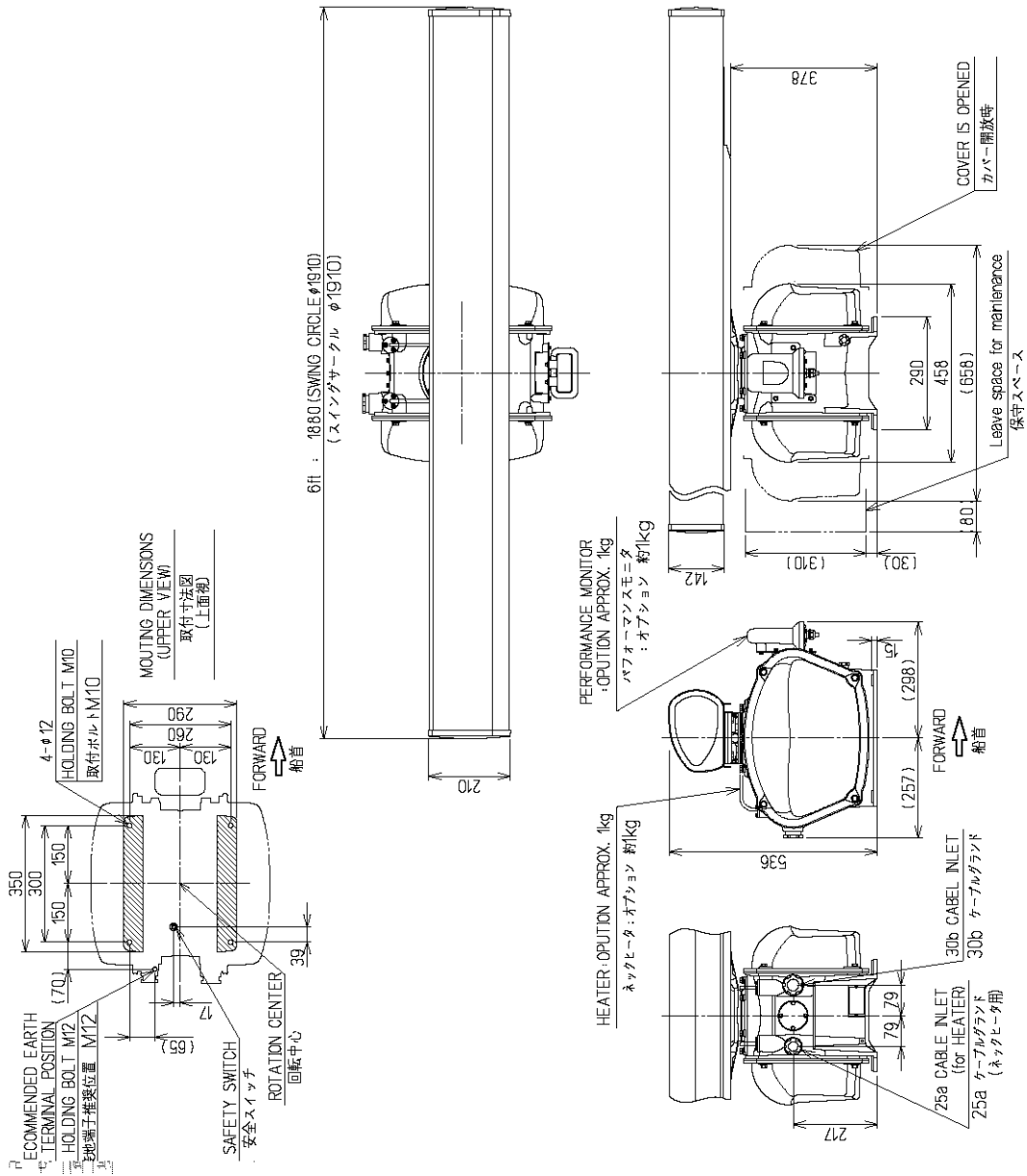

OUTER DIMENS	OUTLINE DIMENSIONS		PERMISSIBLE MOUNTING POSITIONAL DEVIATIONS
	TO	±	
3	6	±0.5	±0.5
6	30	±1	
30	120	±1.5	
120	400	±2.5	±1
400	1000	±4	±2
1000	2000	±6	±3
2000	4000	±8	

寸法	外形寸法 許容差		取付寸法 許容差
	以下	±	
3	6	±0.5	±0.5
6	30	±1	
30	120	±1.5	
120	400	±2.5	±1
400	1000	±4	±2
1000	2000	±6	±3
2000	4000	±8	

MASS APPROX. 55 kg (WITHOUT OPTION)

UNIT	mm
COLOR	ANTENNA WHITE
COLOR	PEDESTAL WHITE
質量	約 55 kg
単位	mm
色	輻射部 白
色	ベースタル 白

SCANNER UNIT OUTLINE DRAWING

SCNKE5302

NOTE: Diameter of cable gland is not able to change.
(注) ケーブルグランド径は変更できません。

Fig 1-7: Outline Drawing of Scanner Unit, Type NKE-2254-6HS

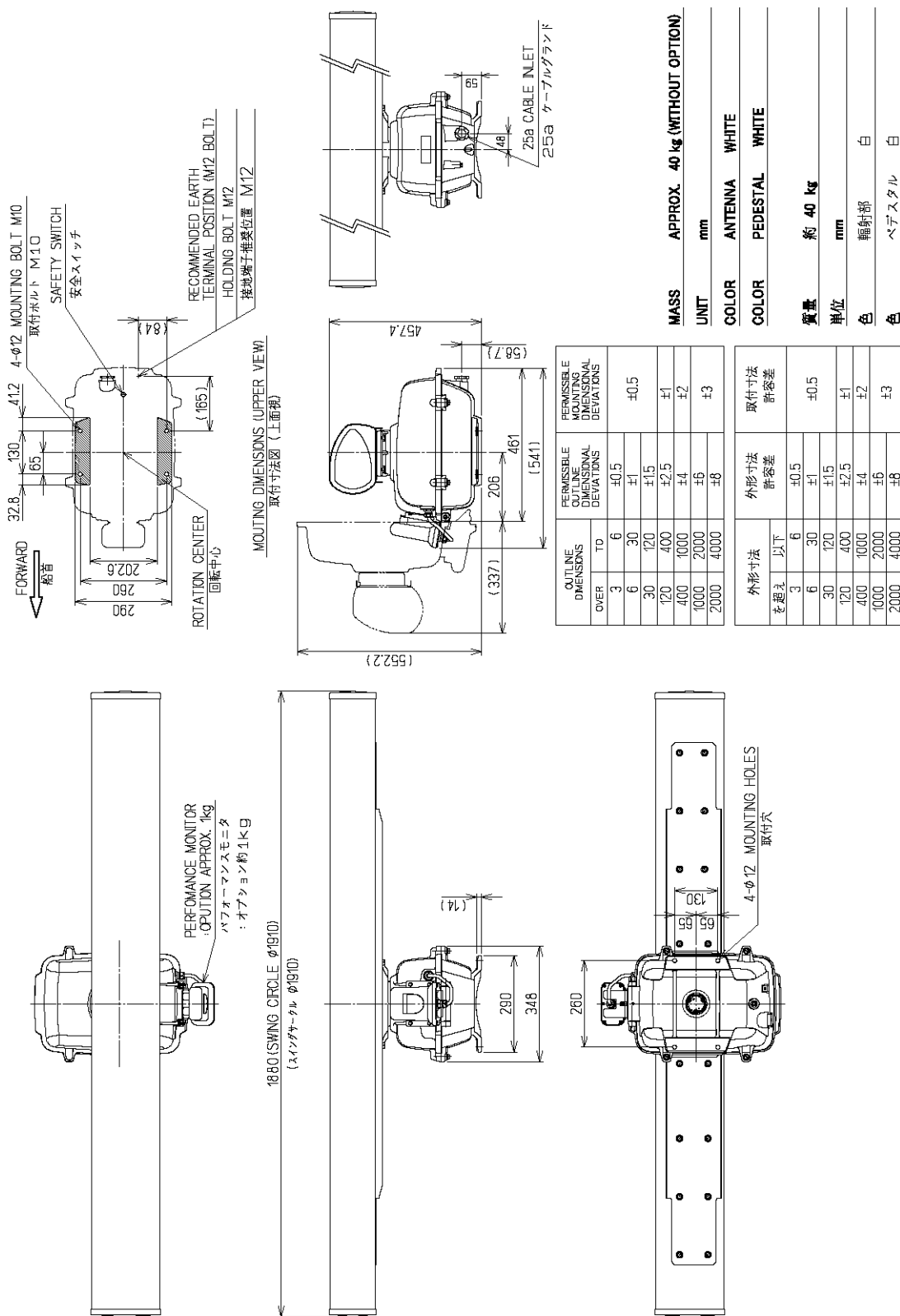

SCANNER UNIT OUTLINE DRAWING NKE-2103-6/NKE-2103-6HS

Fig 1-8: Outline Drawing of Scanner Unit, Type NKE-2103-6

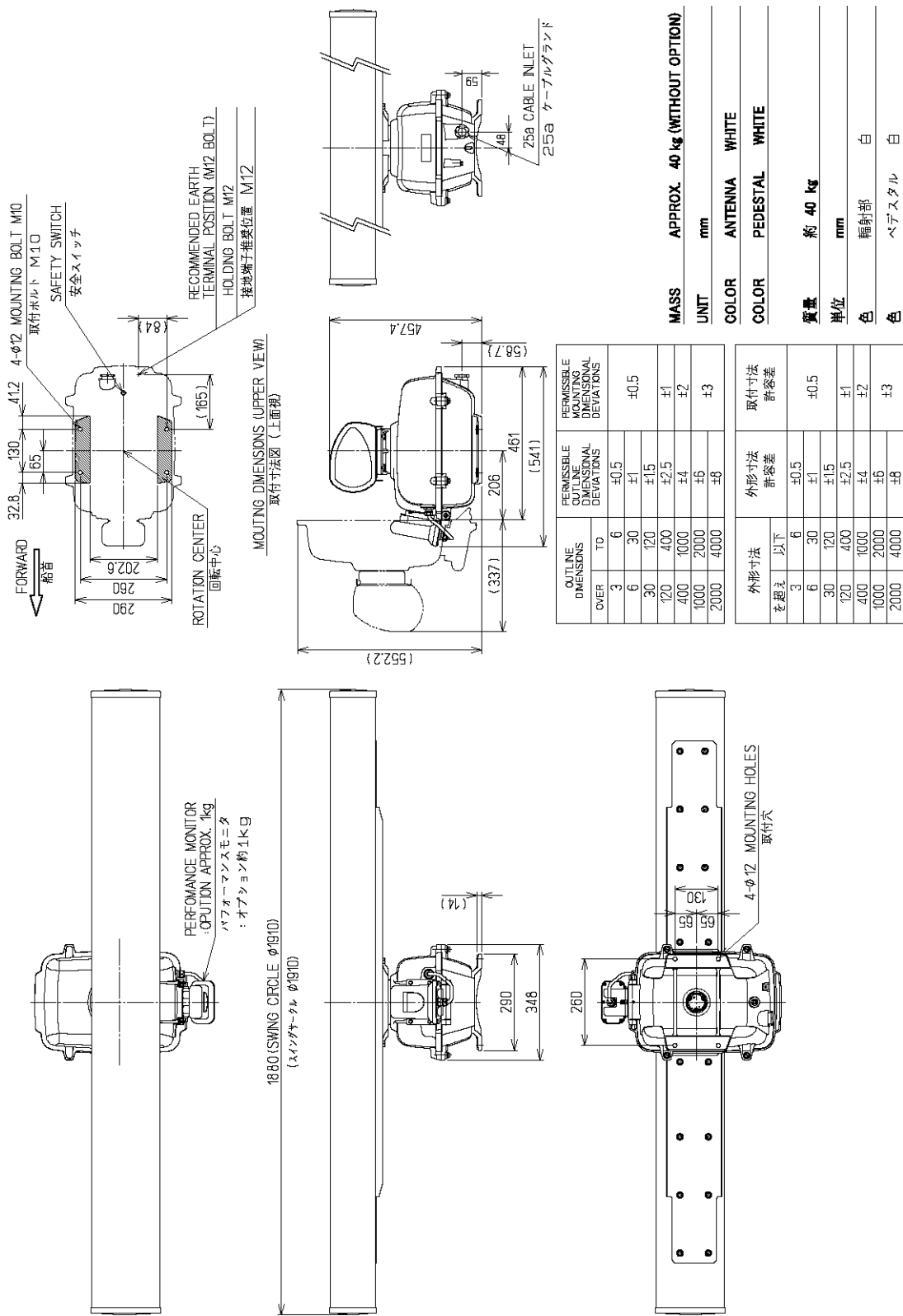

NKE-2103-6/NKE-2103-6HS

SCANNER UNIT OUTLINE DRAWING

JRC NKE5303



Fig 1-9: Outline Drawing of Scanner Unit, Type NKE-2103-6HS

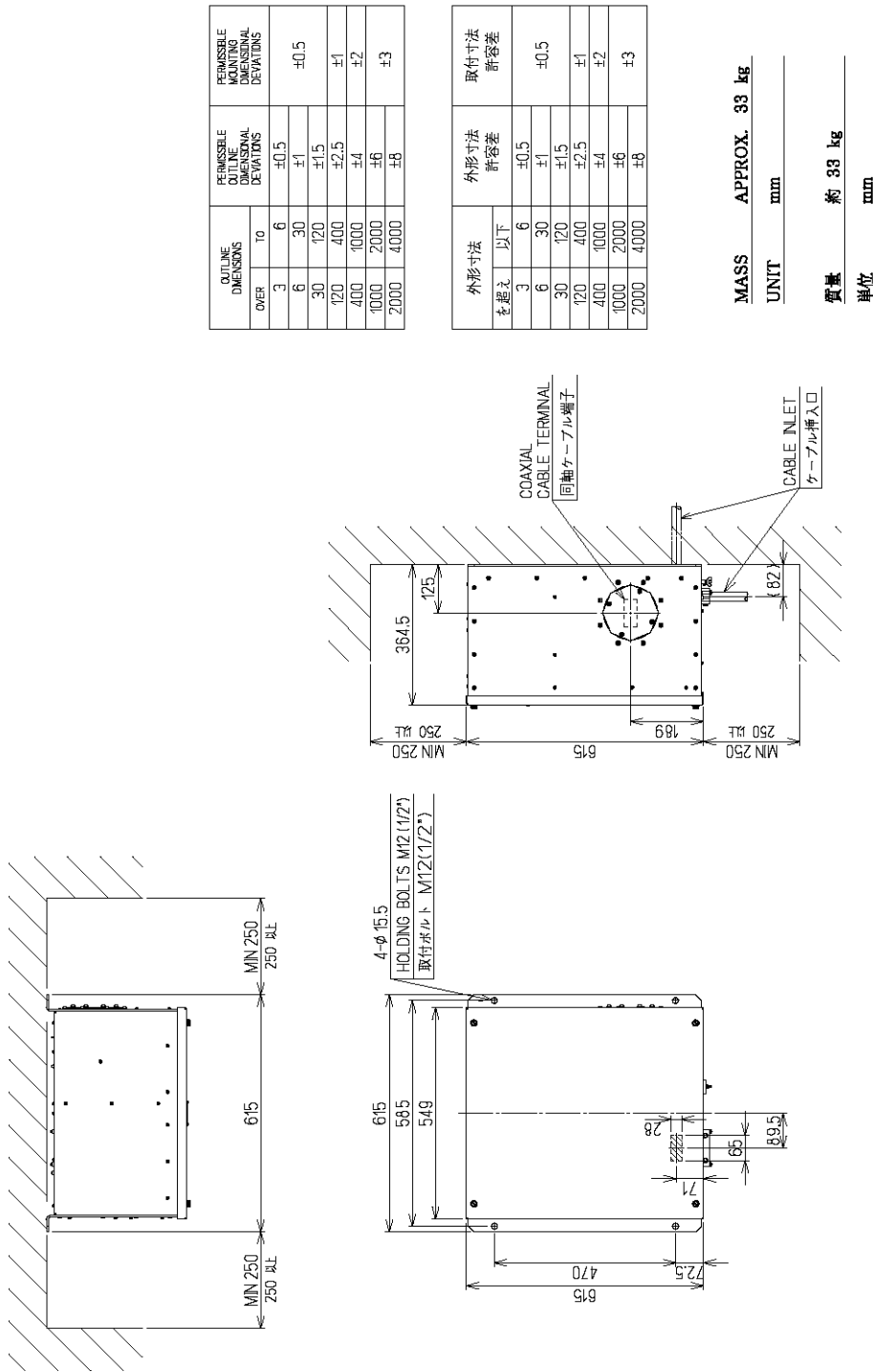

NTG-3230

TRANSMITTER RECEIVER UNIT OUTLINE DRAWING

30NT05176

Fig 1-10: Outline Drawing of Transmitter Receiver Unit, Type NTG-3230

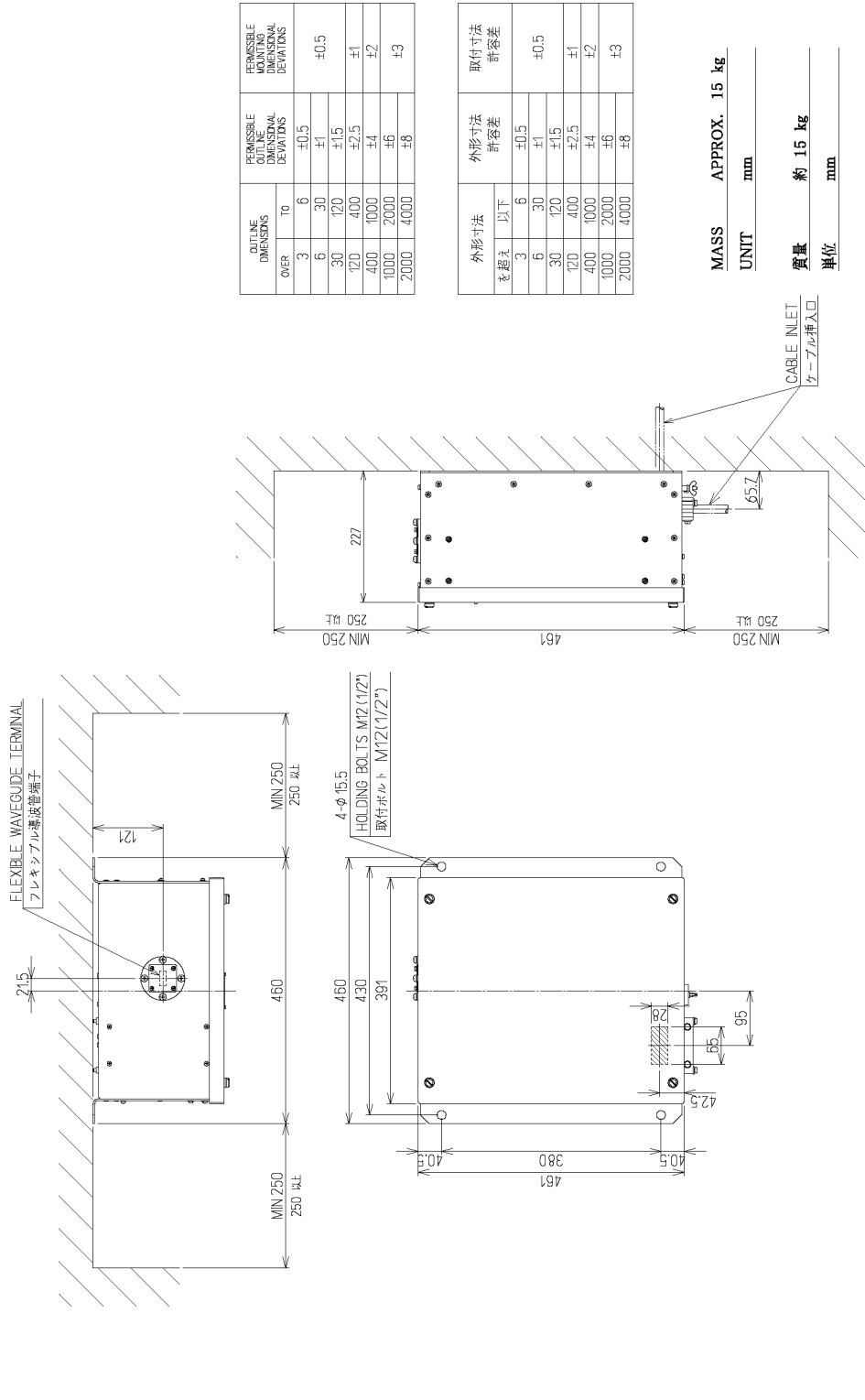

NTG-3225

TRANSMITTER RECEIVER UNIT OUTLINE DRAWING

SCNTG5177

Fig 1-11: Outline Drawing of Transmitter Receiver Unit, Type NTG-3225

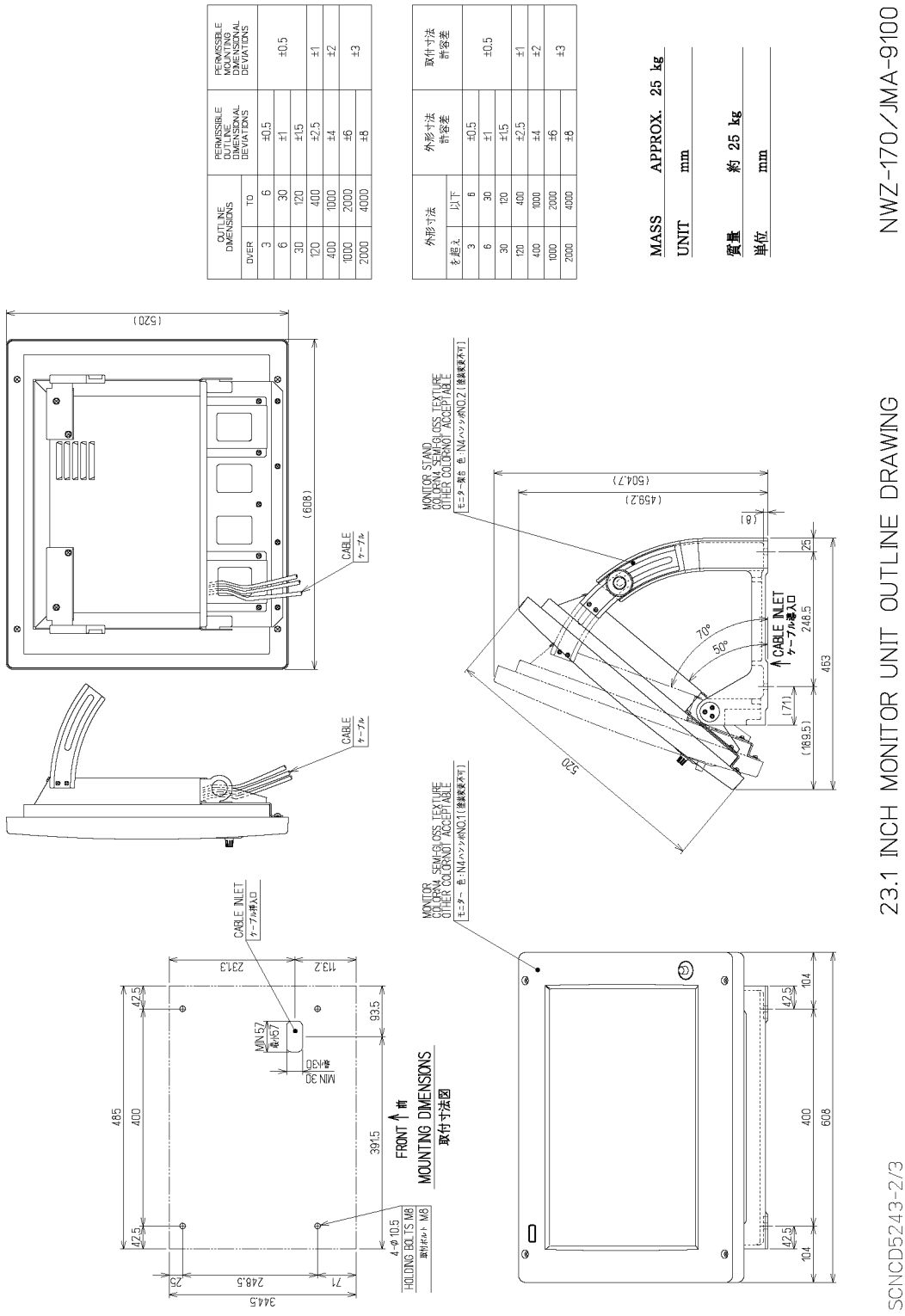
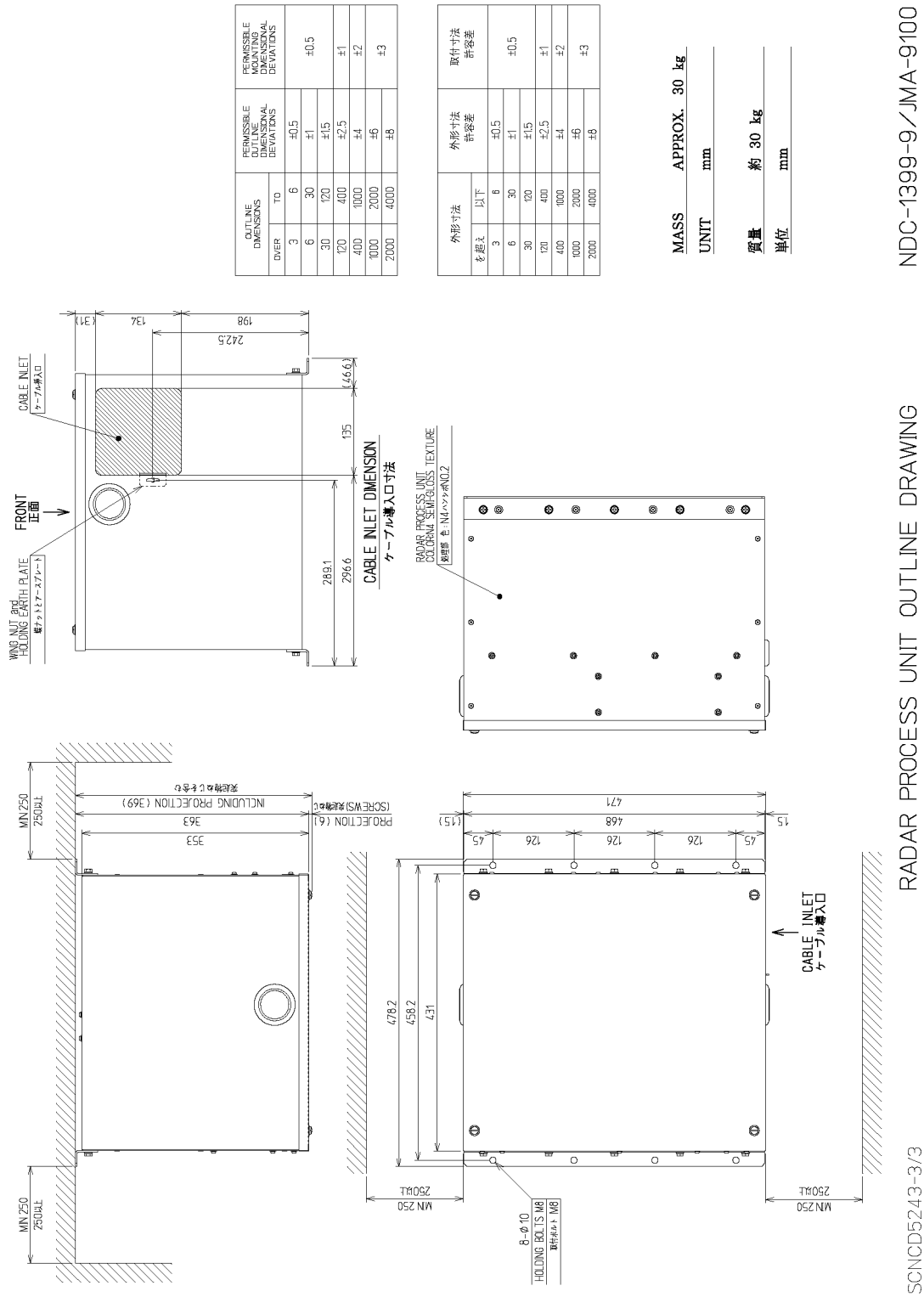

Fig 1-13: Outline Drawing of Monitor Unit, Type NWZ-170 (Desktop type option)



NDC-1399-9/JMA-9100

RADAR PROCESS UNIT OUTLINE DRAWING

SONCD5243-3/3

Fig 1-14: NDOutline Drawing of Radar Process Unit, Type NDC-1399-9 (Desktop type option)

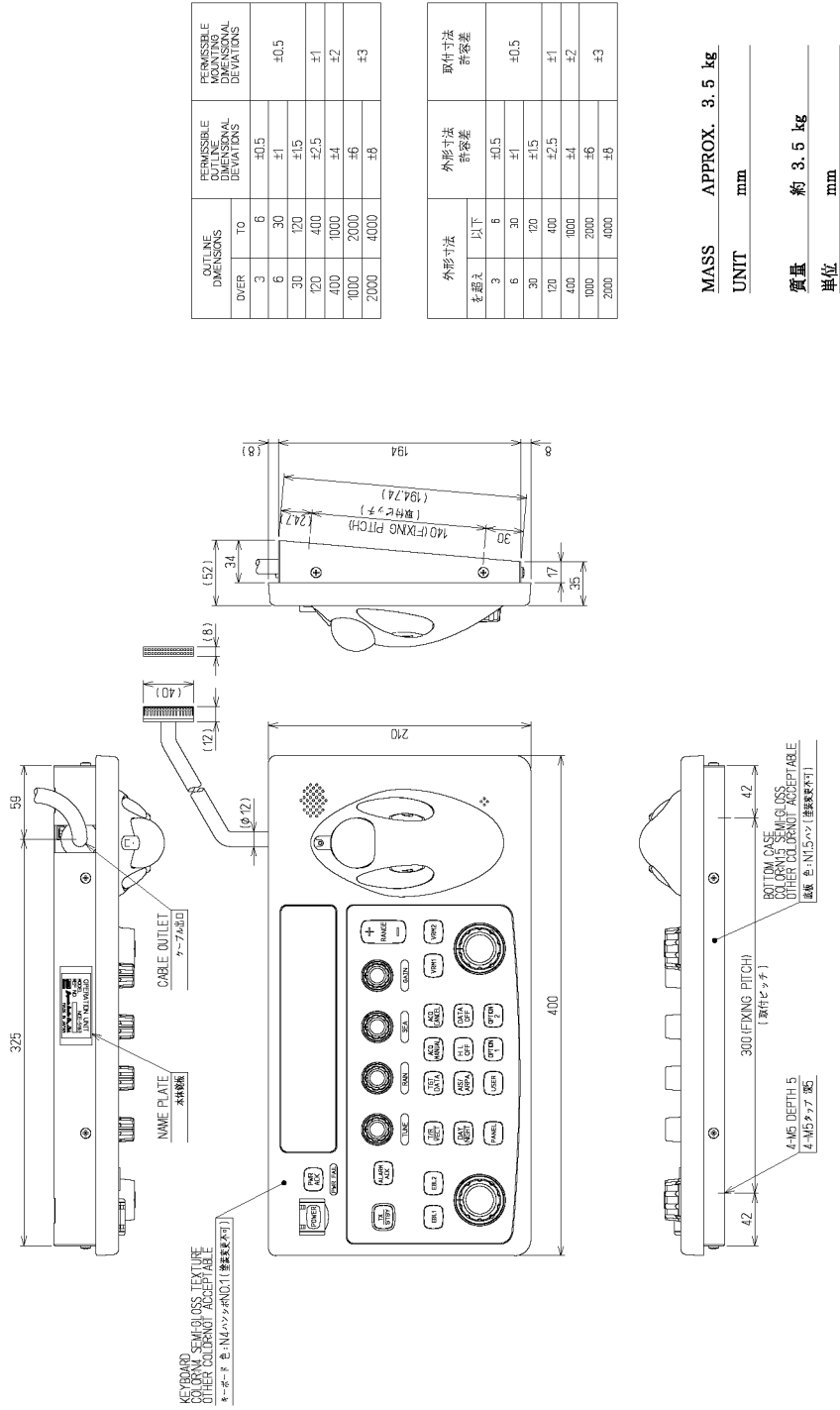

NCE-5163/JMA-9100

OPERATION UNIT OUTLINE DRAWING

SCNCD5243-1/3

Fig 1-15: Outline Drawing of Operation Unit, Type NCE-5163 (Desktop type option)

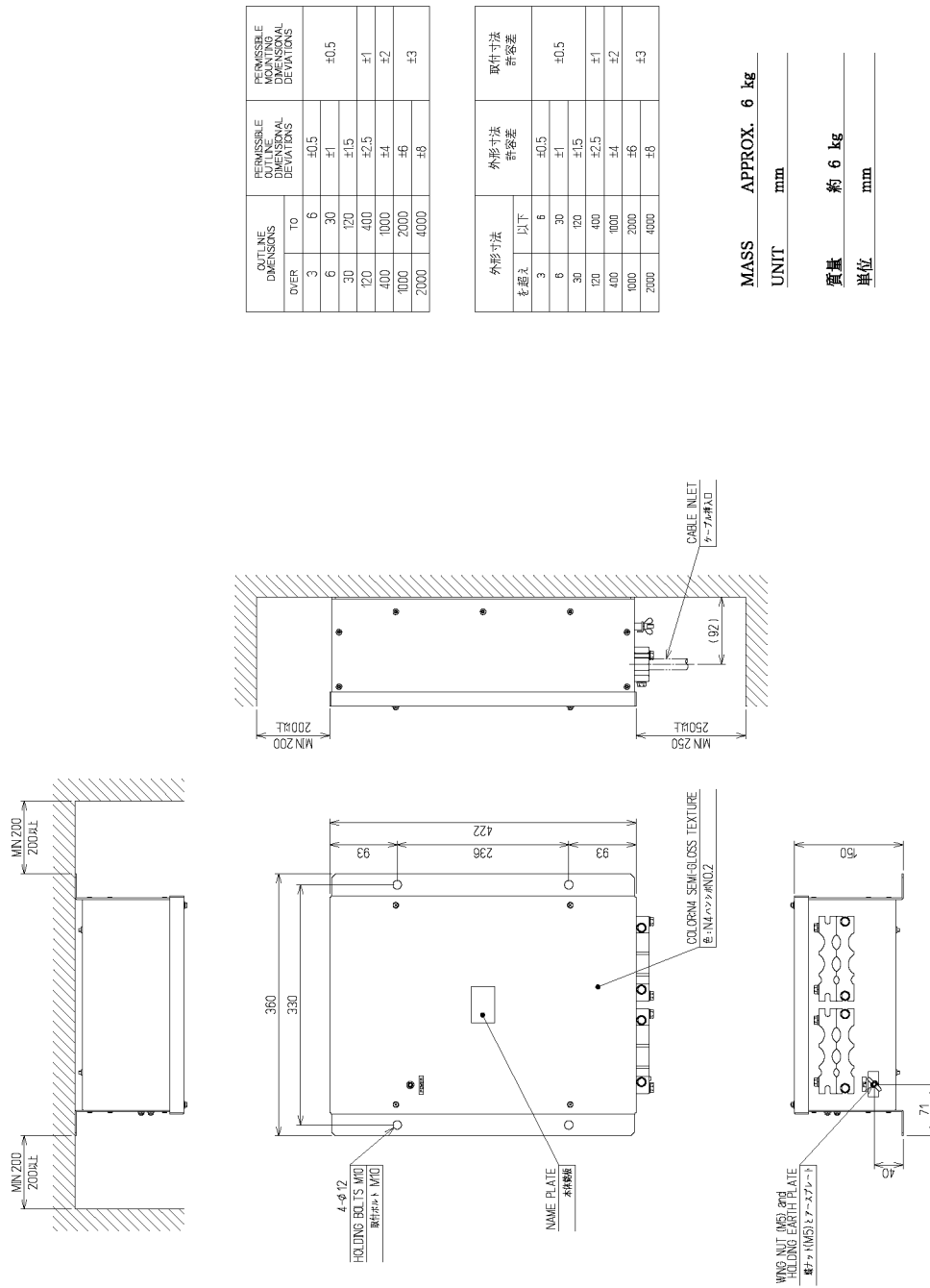

NQE-3141-4A

INTERSWITCH UNIT OUTLINE DRAWING

SCNQE5084

Fig 1-17: Outline Drawing of Interswitch Unit, Type NQE-3141-4A (Option)

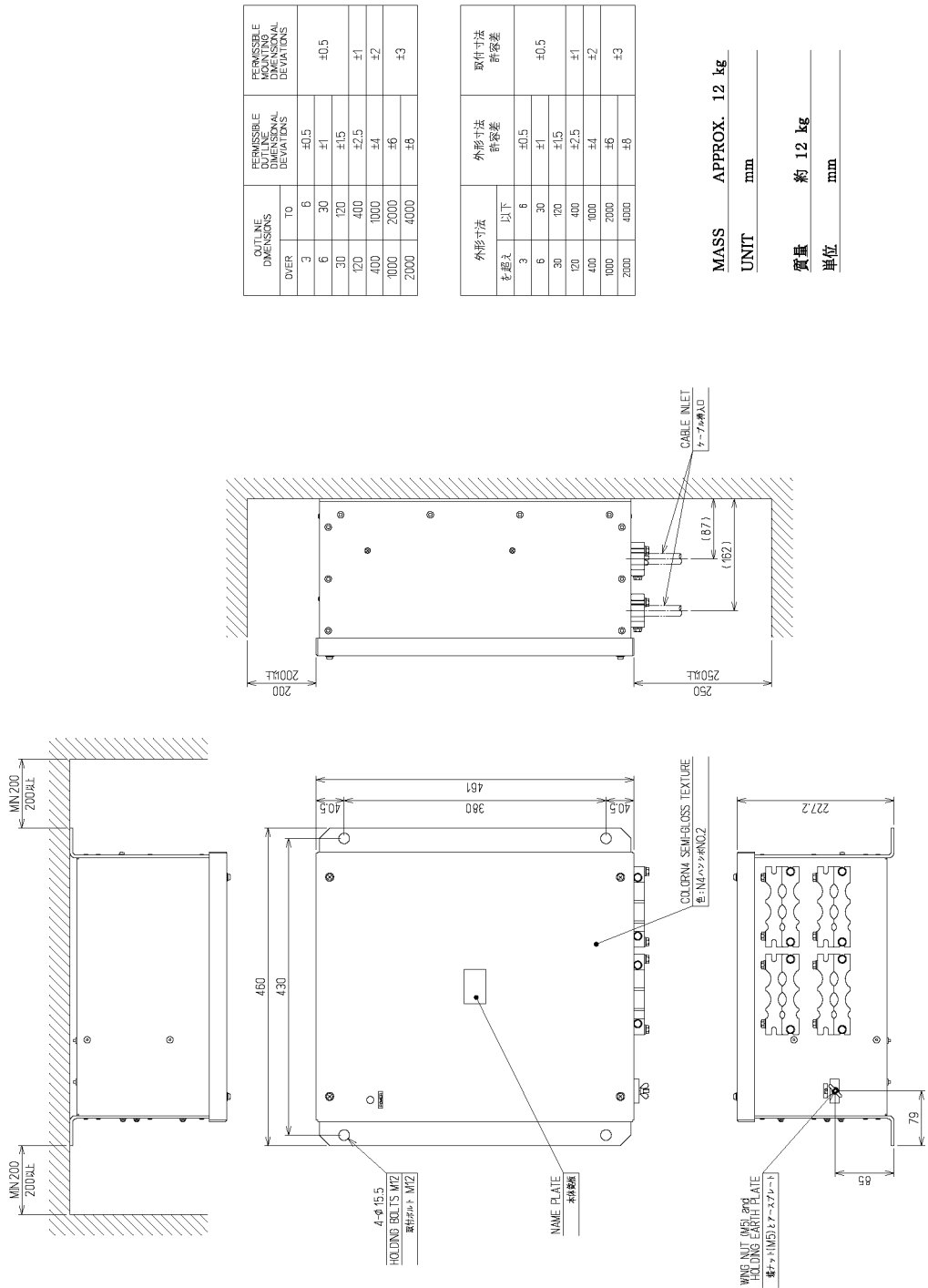
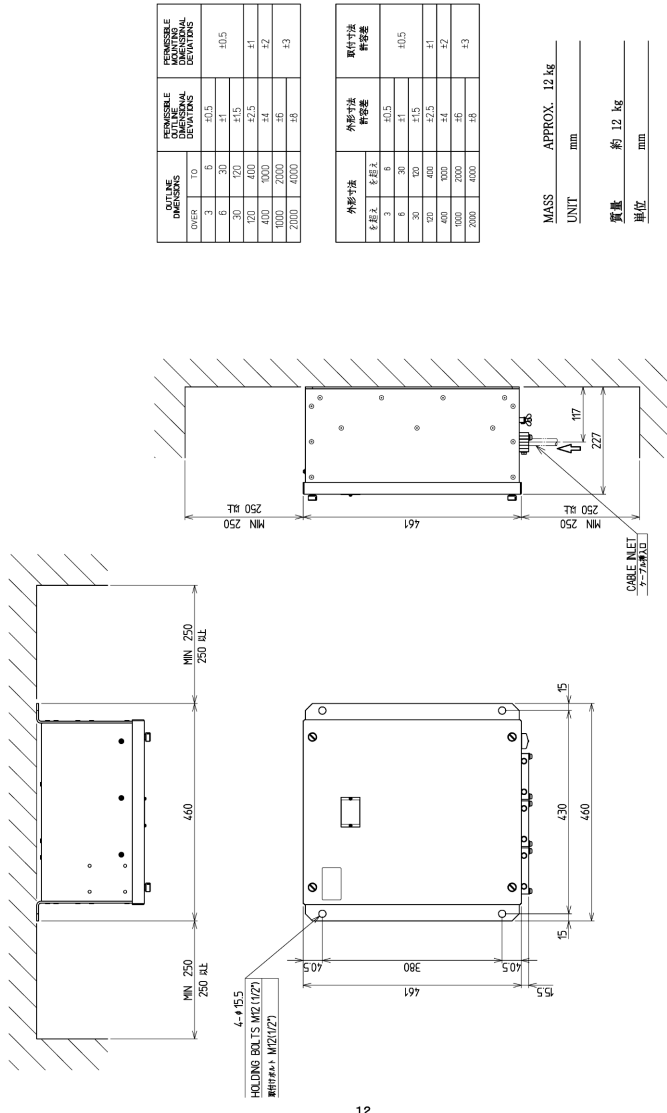

Fig 1-18: Outline Drawing of Interswitch Unit, Type NQE-3141-8A (Option)

NQE-3141-8A

INTERSWITCH UNIT OUTLINE DRAWING

SONQE5085



NQE-3167

POWER CONTROL UNIT OUTLINE DRAWING

SONQE5080

Fig 1-19: Outline Drawing of Power Control Unit, Type NQE-3167 (Option)

1.5 GENERAL SYSTEM DIAGRAMS

Fig 1-21: General System Diagram of Radar, Type JMA-9132-SA

Fig 1-22: General System Diagram of Radar, Type JMA-9123-7XA

Fig 1-23: General System Diagram of Radar, Type JMA-9123-9XA

Fig 1-24: General System Diagram of Radar, Type JMA-9122-6XA

Fig 1-25: General System Diagram of Radar, Type JMA-9122-9XA

Fig 1-26: General System Diagram of Radar, Type JMA-9122-6XAH

Fig 1-27: General System Diagram of Radar, Type JMA-9110-6XA

Fig 1-28: General System Diagram of Radar, Type JMA-9110-6XAH

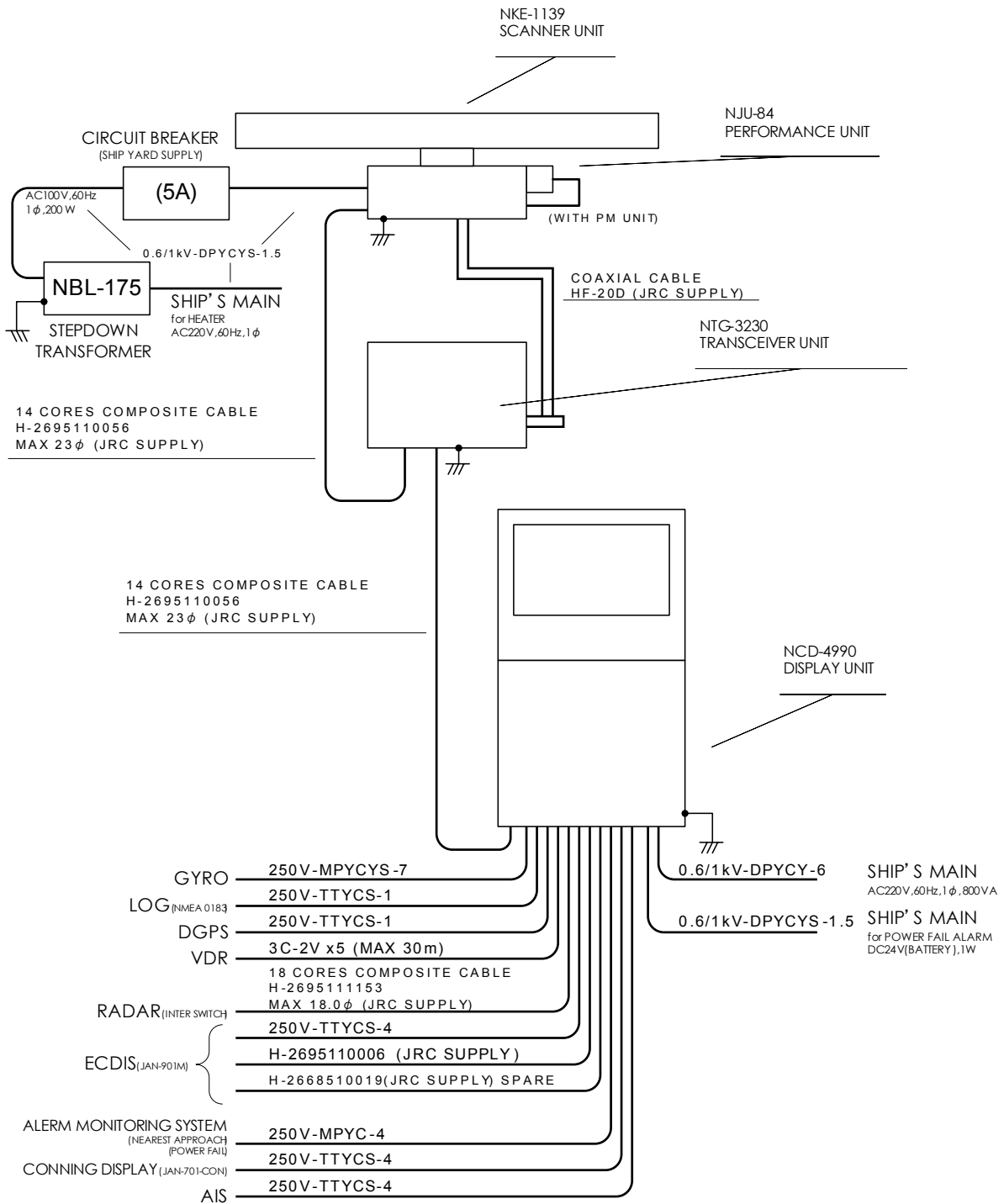

Fig 1-20: General System Diagram of Radar, Type JMA-9133-SA



Eliminating the interference on frequencies used for marine communications and navigation due to operation of the radar. All cables of the radar are to be run away from the cables of radio equipment. (Ex. Radiotelephone. Communications receiver and direction finder, etc.) Especially inter-wiring cables between scanner unit and display unit of the radar should not be run parallel with the cables of radio equipment.

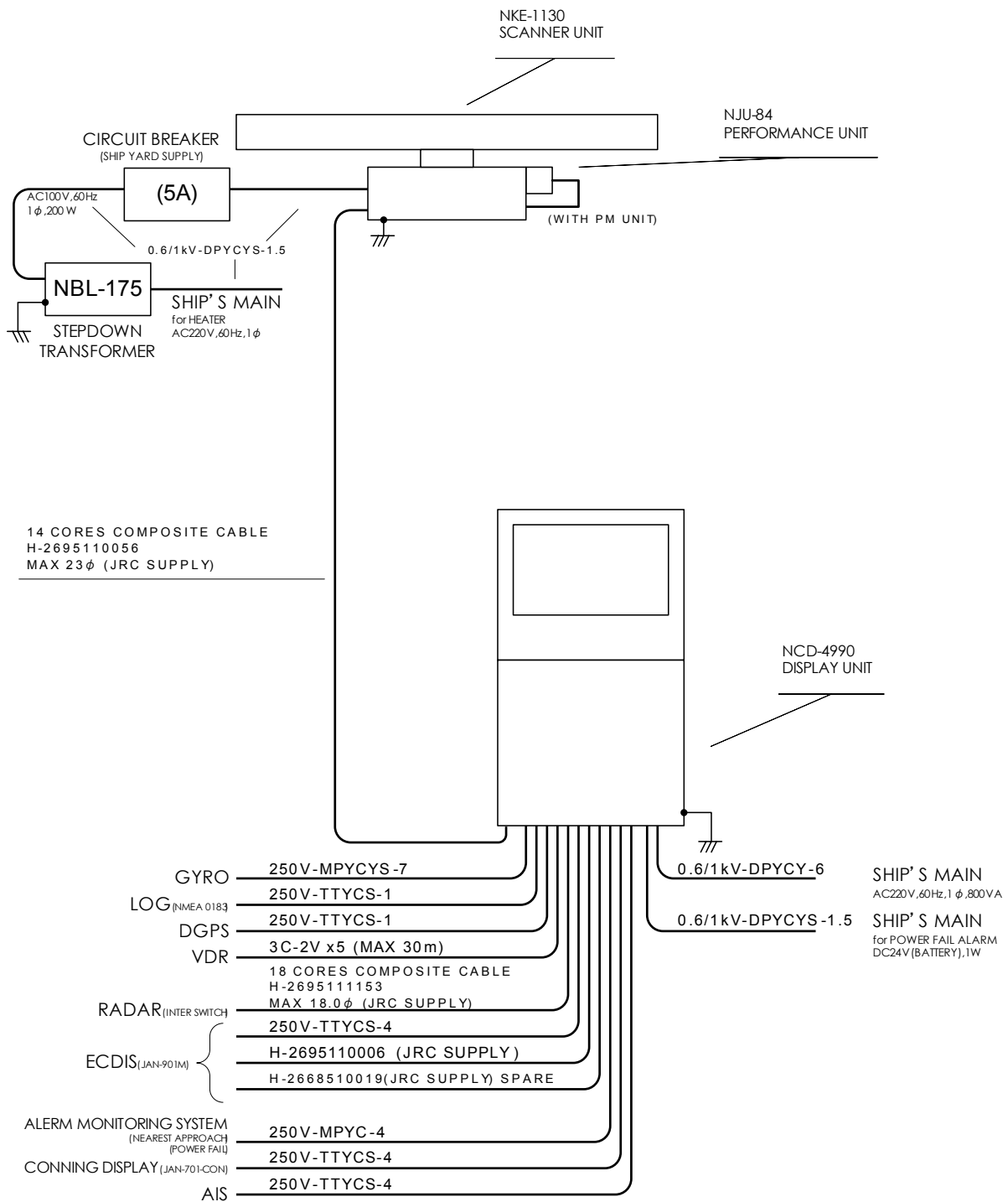

Fig 1-21: General System Diagram of Radar, Type JMA-9132-SA



Eliminating the interference on frequencies used for marine communications and navigation due to operation of the radar. All cables of the radar are to be run away from the cables of radio equipment. (Ex. Radiotelephone. Communications receiver and direction finder, etc.) Especially inter-wiring cables between scanner unit and display unit of the radar should not be run parallel with the cables of radio equipment.

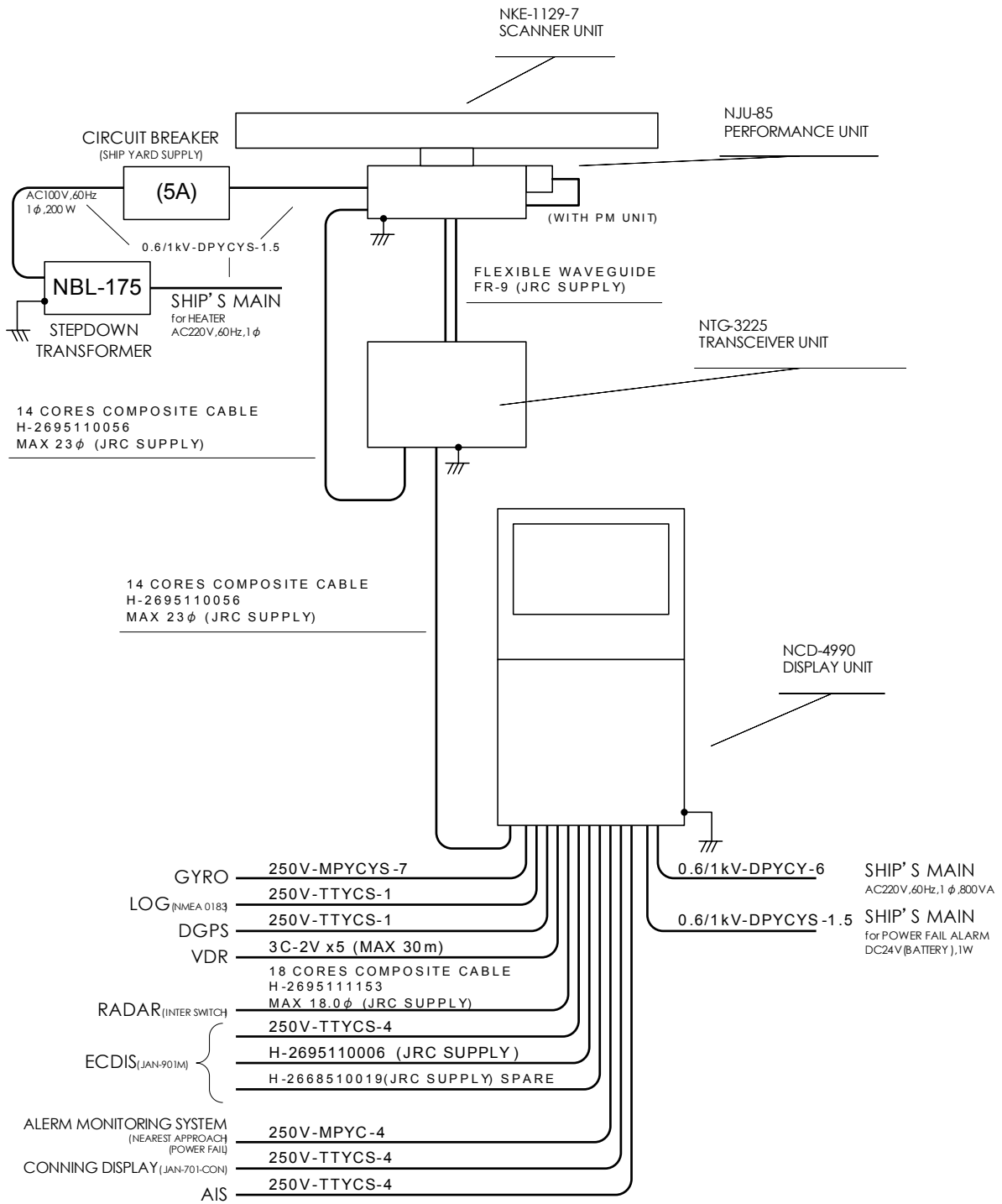

Fig 1-22: General System Diagram of Radar, Type JMA-9123-7XA



Eliminating the interference on frequencies used for marine communications and navigation due to operation of the radar. All cables of the radar are to be run away from the cables of radio equipment. (Ex. Radiotelephone. Communications receiver and direction finder, etc.) Especially inter-wiring cables between scanner unit and display unit of the radar should not be run parallel with the cables of radio equipment.

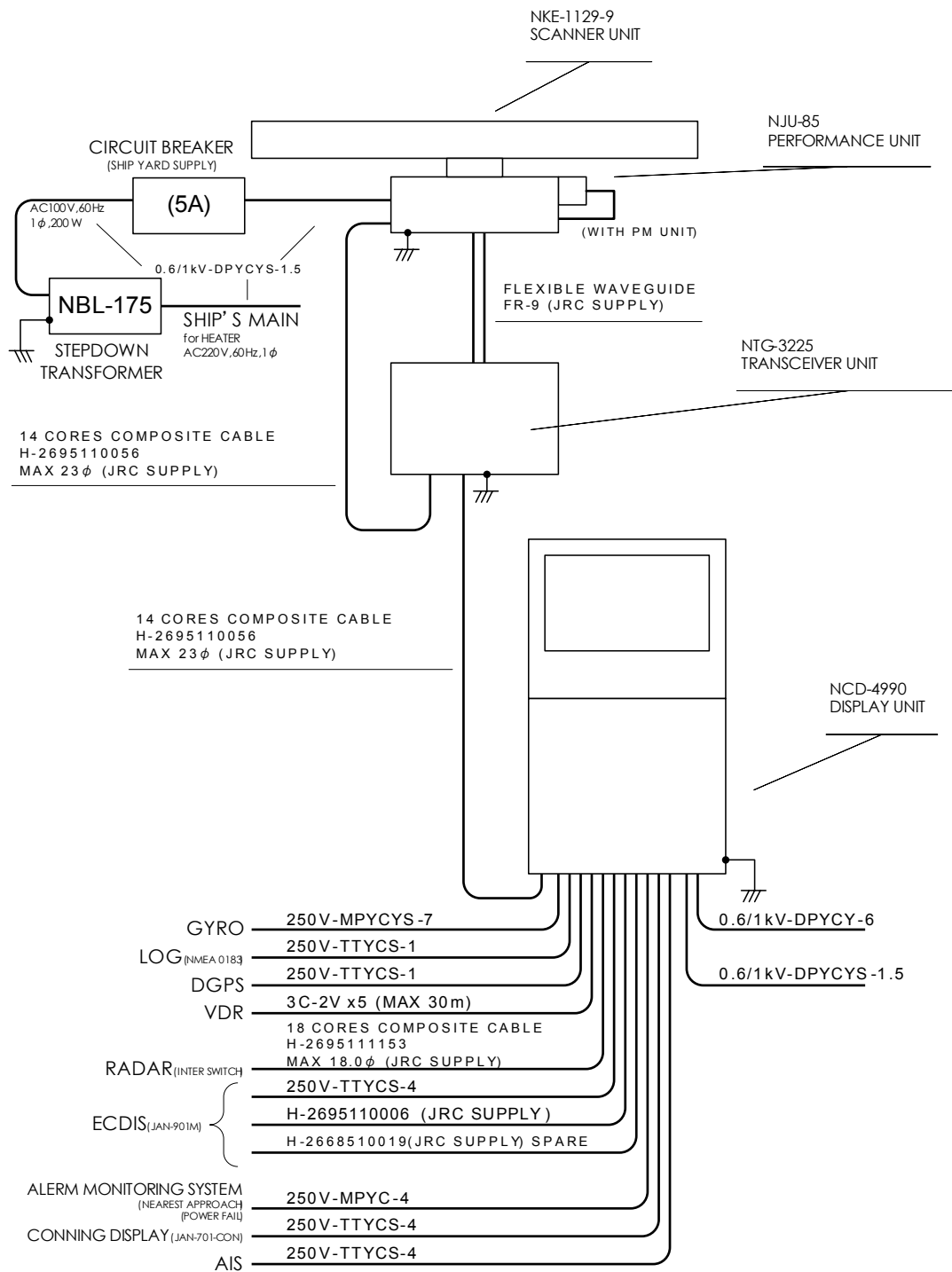

Fig 1-23: General System Diagram of Radar, Type JMA-9123-9XA



Eliminating the interference on frequencies used for marine communications and navigation due to operation of the radar. All cables of the radar are to be run away from the cables of radio equipment.(Ex. Radiotelephone. Communications receiver and direction finder, etc.) Especially inter-wiring cables between scanner unit and display unit of the radar should not be run parallel with the cables of radio equipment.

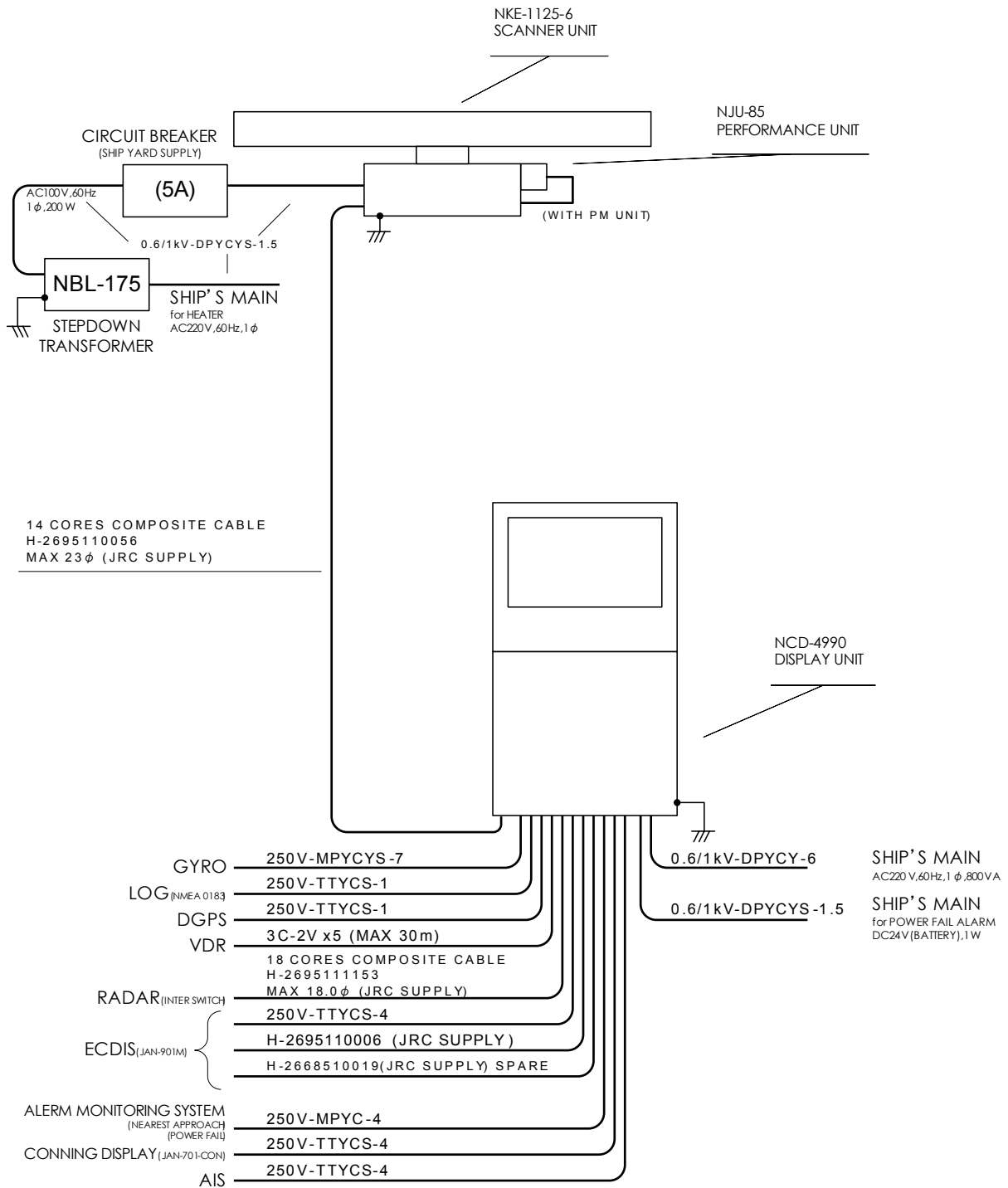

Fig 1-24: General System Diagram of Radar, Type JMA-9122-6XA



Eliminating the interference on frequencies used for marine communications and navigation due to operation of the radar. All cables of the radar are to be run away from the cables of radio equipment. (Ex. Radiotelephone. Communications receiver and direction finder, etc.) Especially inter-wiring cables between scanner unit and display unit of the radar should not be run parallel with the cables of radio equipment.

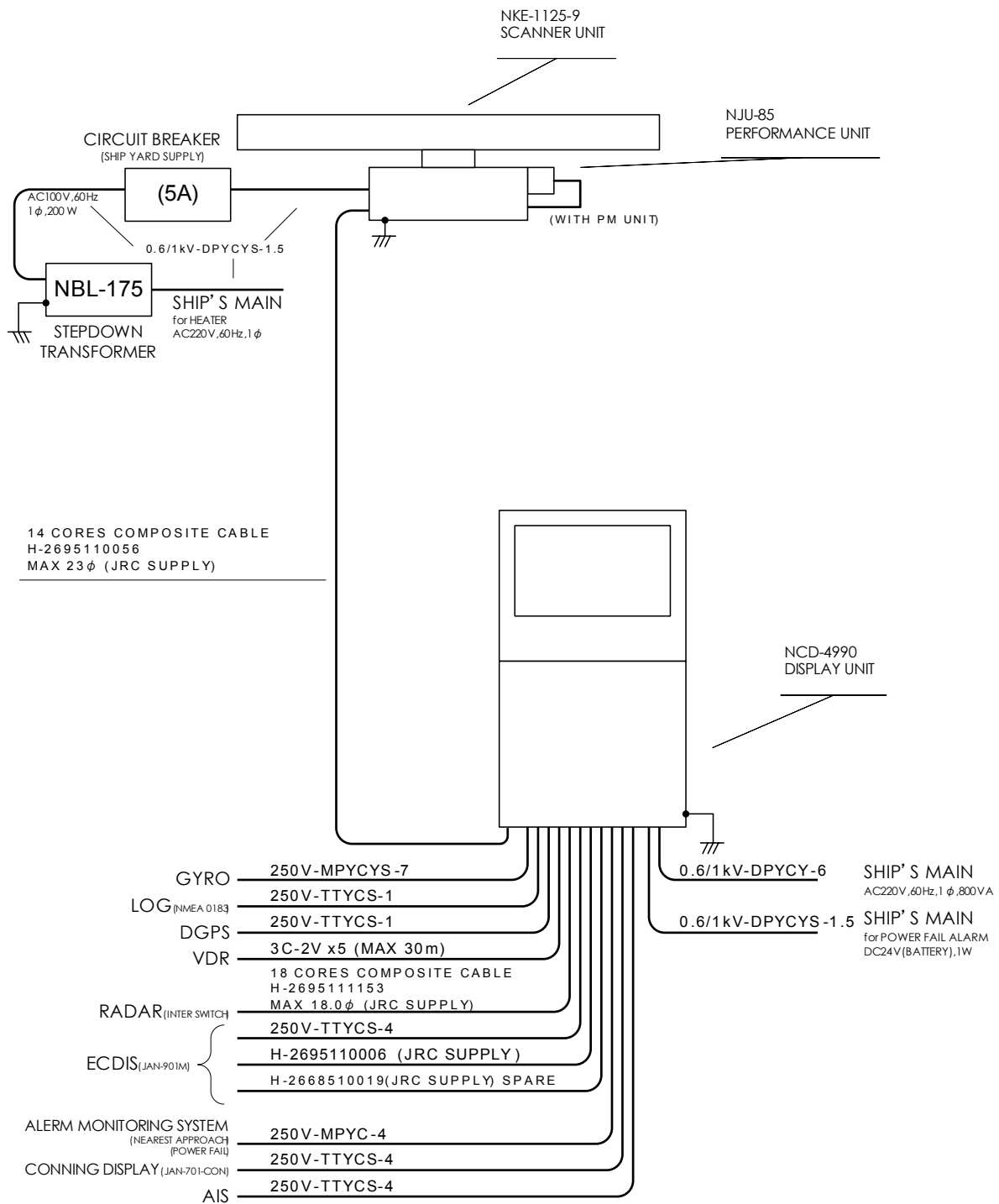

Fig 1-25: General System Diagram of Radar, Type JMA-9122-9XA



Eliminating the interference on frequencies used for marine communications and navigation due to operation of the radar. All cables of the radar are to be run away from the cables of radio equipment. (Ex. Radiotelephone. Communications receiver and direction finder, etc.) Especially inter-wiring cables between scanner unit and display unit of the radar should not be run parallel with the cables of radio equipment.

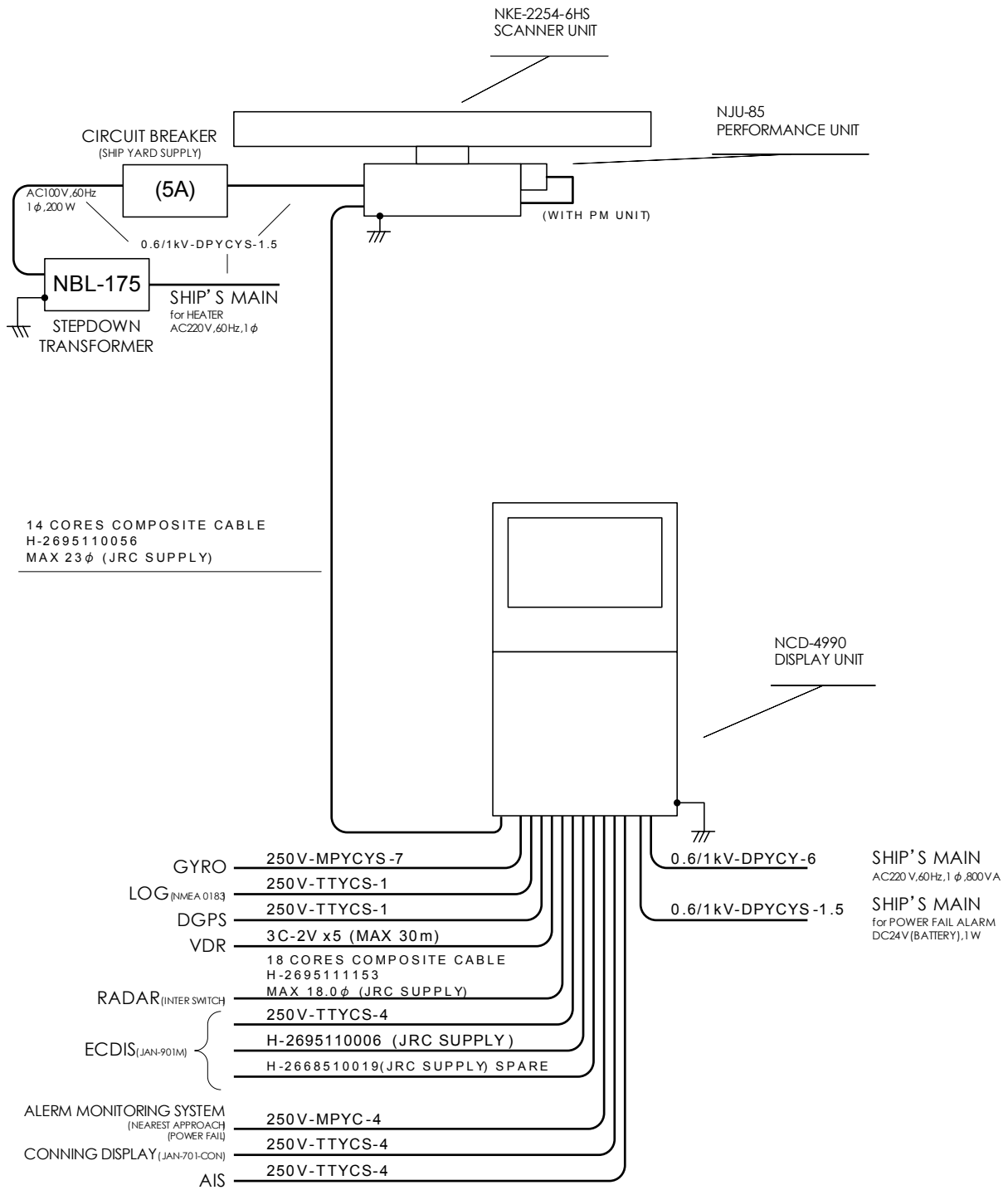

Fig 1-26: General System Diagram of Radar, Type JMA-9122-6XAH



Eliminating the interference on frequencies used for marine communications and navigation due to operation of the radar. All cables of the radar are to be run away from the cables of radio equipment. (Ex. Radiotelephone. Communications receiver and direction finder, etc.) Especially inter-wiring cables between scanner unit and display unit of the radar should not be run parallel with the cables of radio equipment.

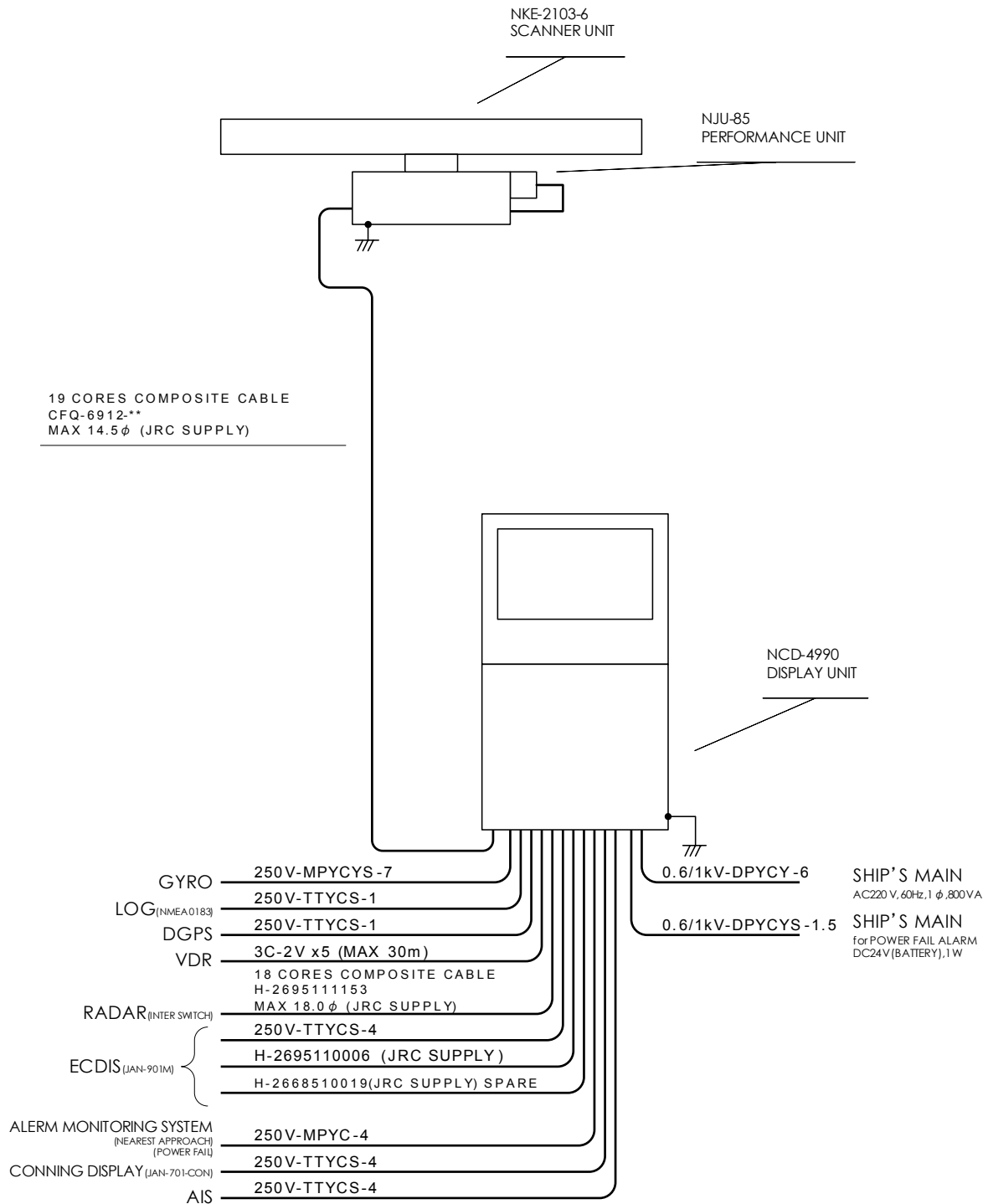

Fig 1-27: General System Diagram of Radar, Type JMA-9110-6XA



Eliminating the interference on frequencies used for marine communications and navigation due to operation of the radar. All cables of the radar are to be run away from the cables of radio equipment. (Ex. Radiotelephone. Communications receiver and direction finder, etc.) Especially inter-wiring cables between scanner unit and display unit of the radar should not be run parallel with the cables of radio equipment.

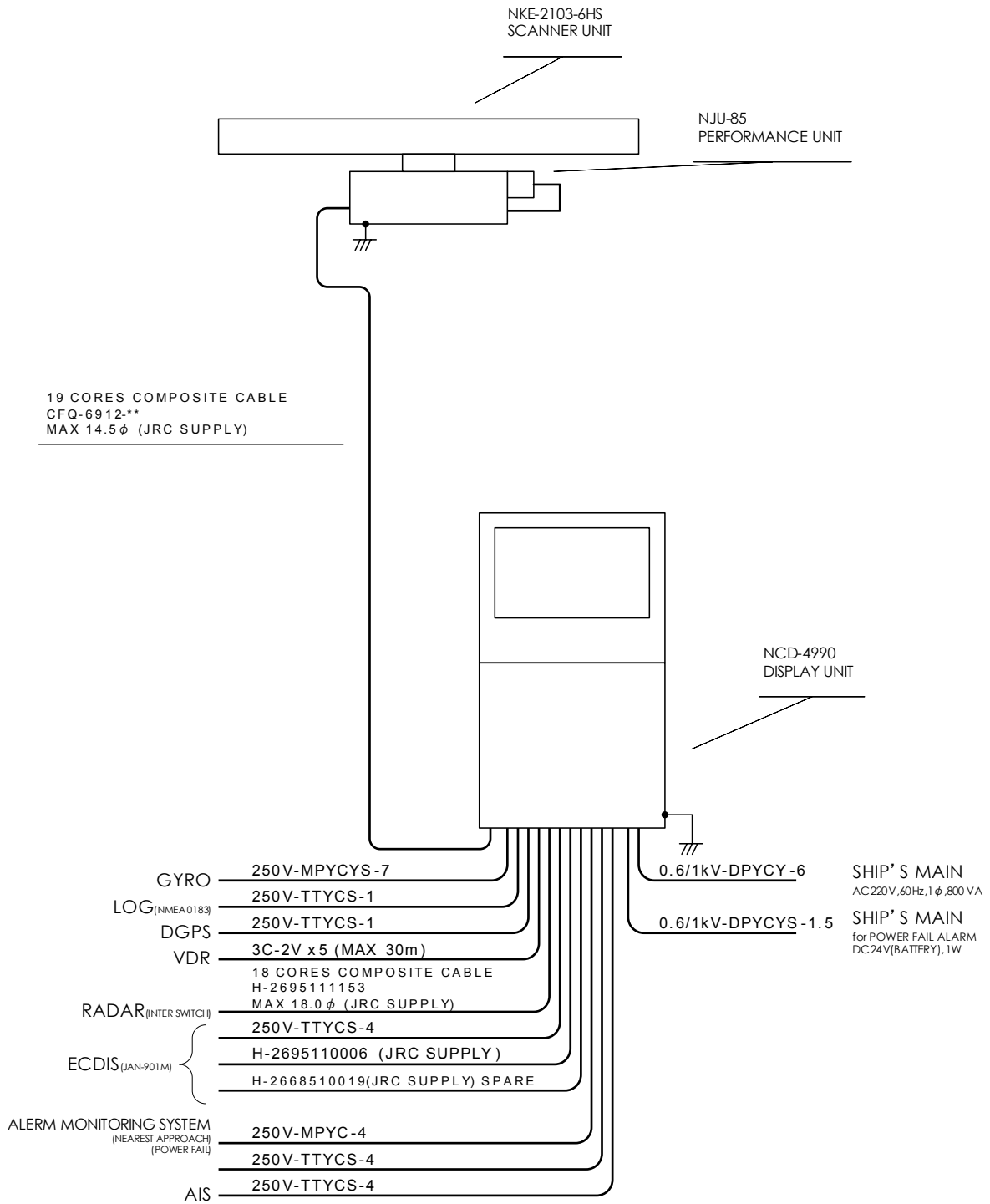

Fig 1-28: General System Diagram of Radar, Type JMA-9110-6XAH



Eliminating the interference on frequencies used for marine communications and navigation due to operation of the radar. All cables of the radar are to be run away from the cables of radio equipment. (Ex. Radiotelephone. Communications receiver and direction finder, etc.) Especially inter-wiring cables between scanner unit and display unit of the radar should not be run parallel with the cables of radio equipment.



SECTION 2

NAMES AND FUNCTIONS OF CONTROL PANEL KEYS AND FUNCTIONS OF SOFTWARE BUTTONS

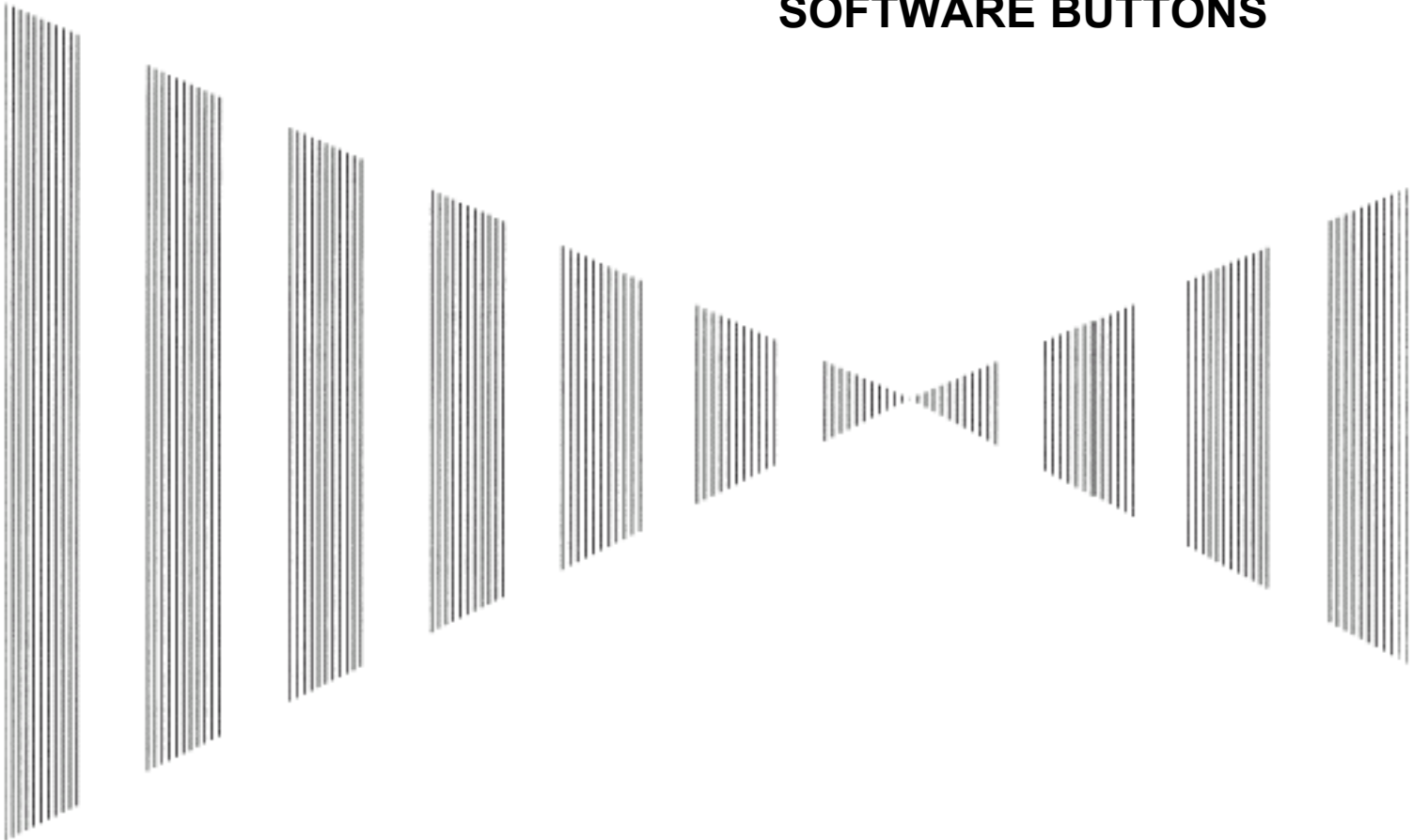

NAMES AND FUNCTIONS OF CONTROL PANEL KEYS AND FUNCTIONS OF SOFTWARE BUTTONS

2.1	NAMES OF DISPLAY	2-1
2.2	NAMES AND FUNCTIONS OF CONTROL PANEL KEYS	2-11
2.3	FUNCTIONS OF SOFTWARE BUTTONS	2-16

2.1 NAMES OF DISPLAY

Example of screen display

2

In this example, the screen is divided into a number of areas and the names in each area are indicated.

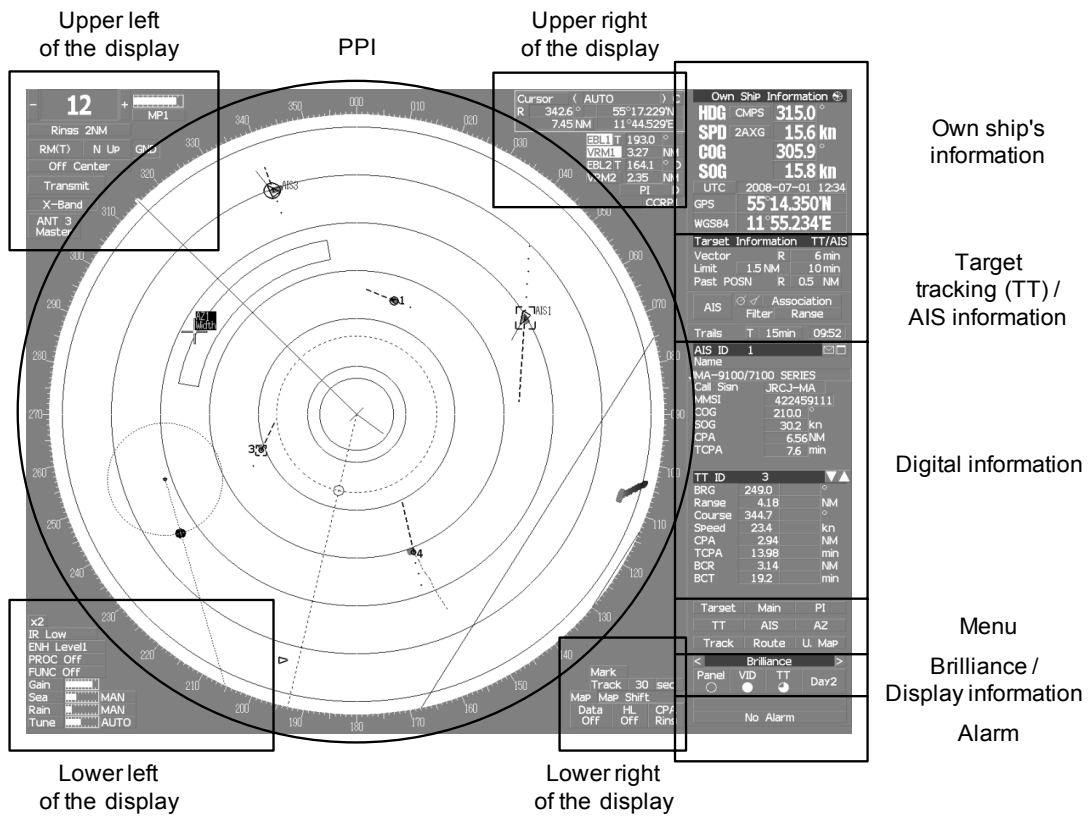

PPI

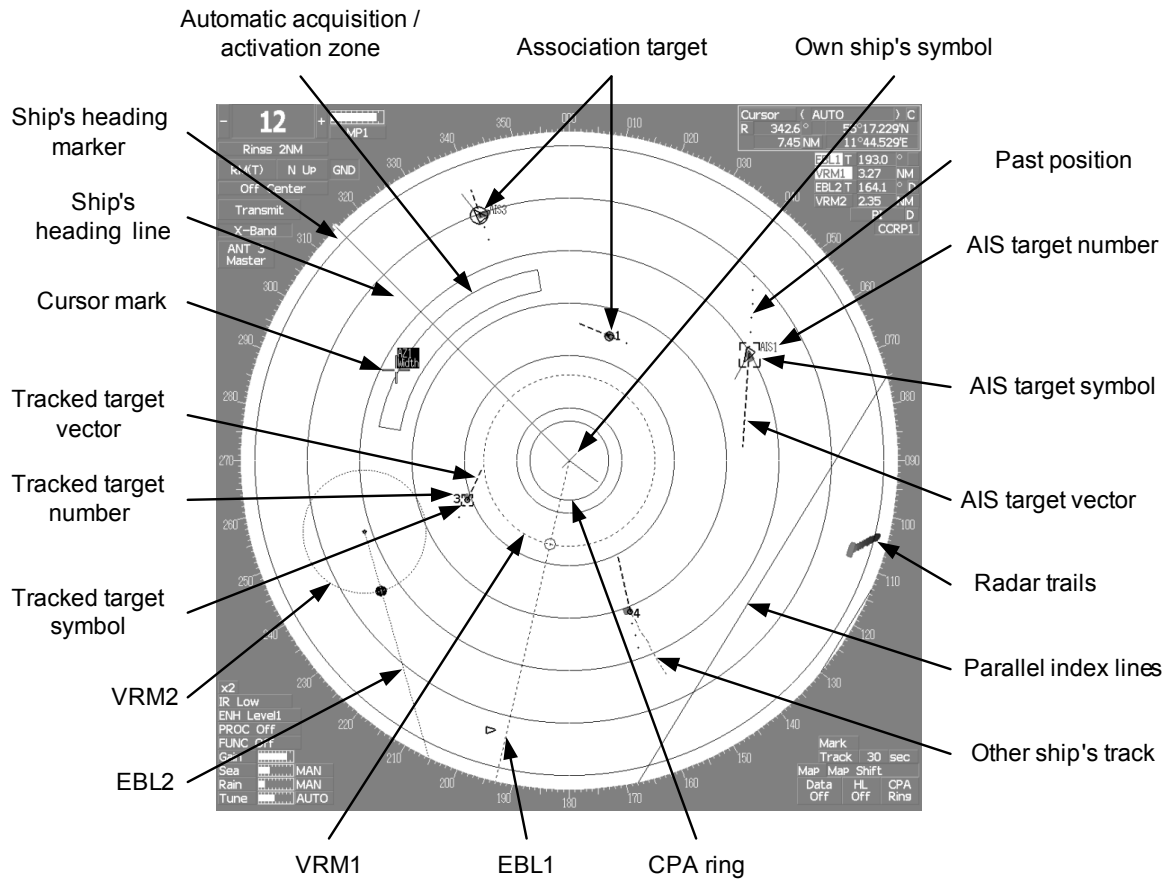

Upper left of the display

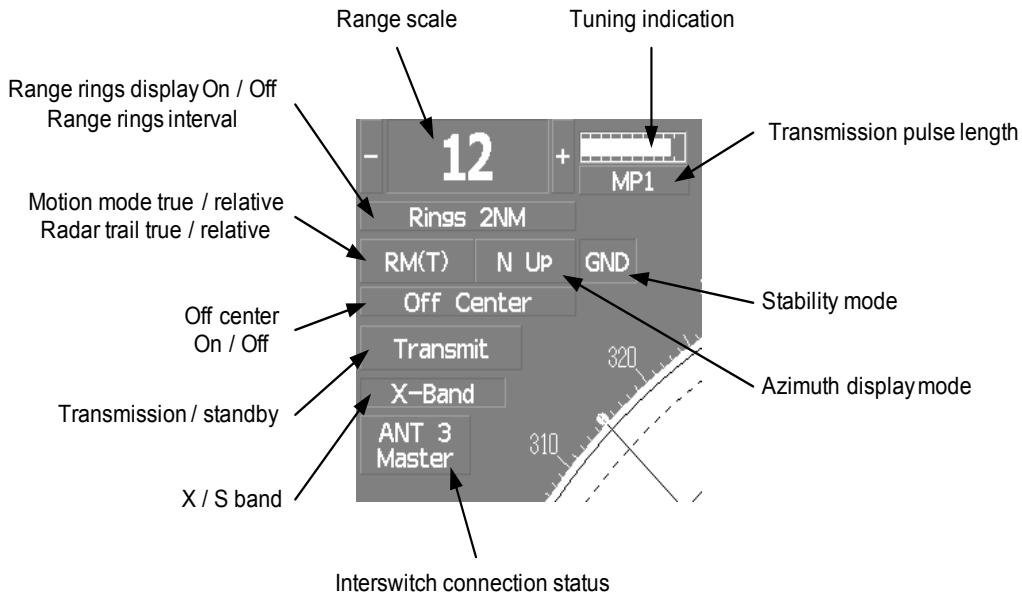

About ground and sea stabilization

Speed sensor source is **MAN** , **LOG** , **2AXW**

If Set/Drift Setting menu is on : GND (Ground stabilization)

If Set/Drift Setting menu is off : Sea (Sea stabilization)

Speed sensor source is **GPS** , **2AXG** : GND (Ground stabilization)

Lower left of the display

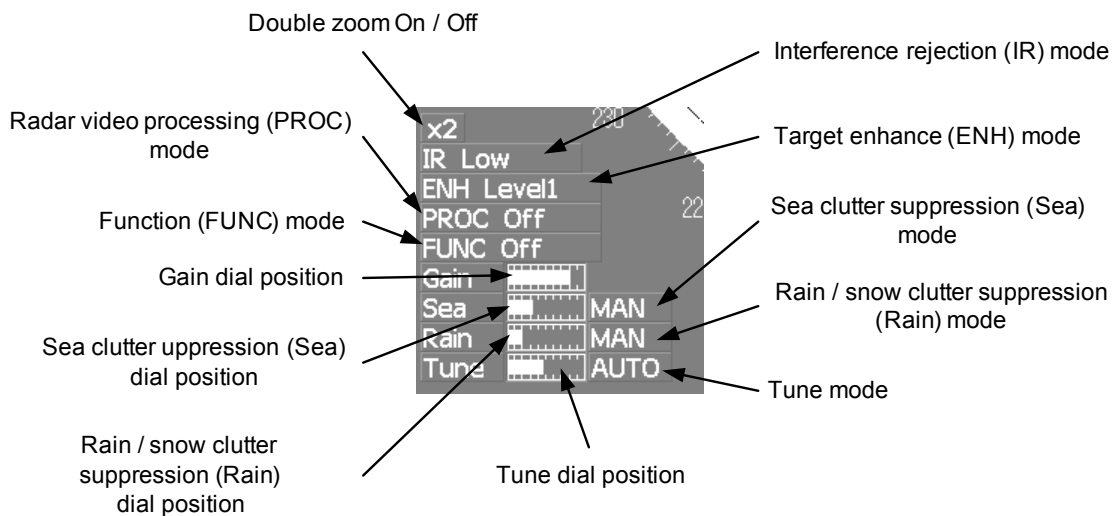

Upper right of the display

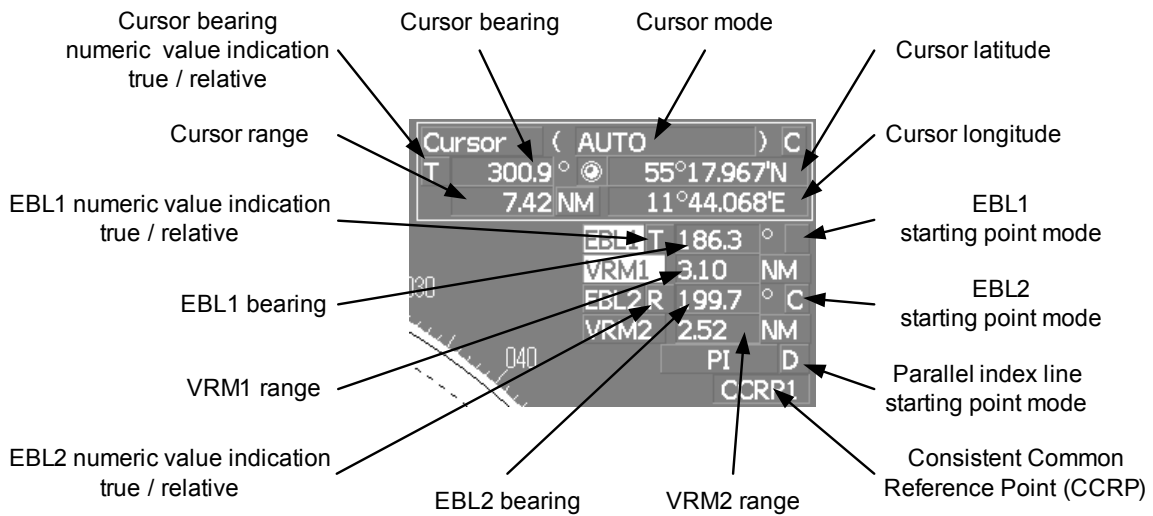

Lower right of the display

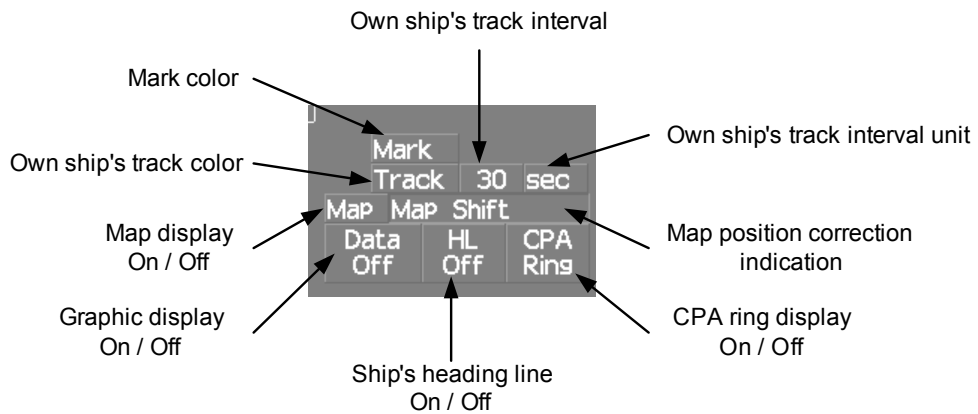

Own ship's information

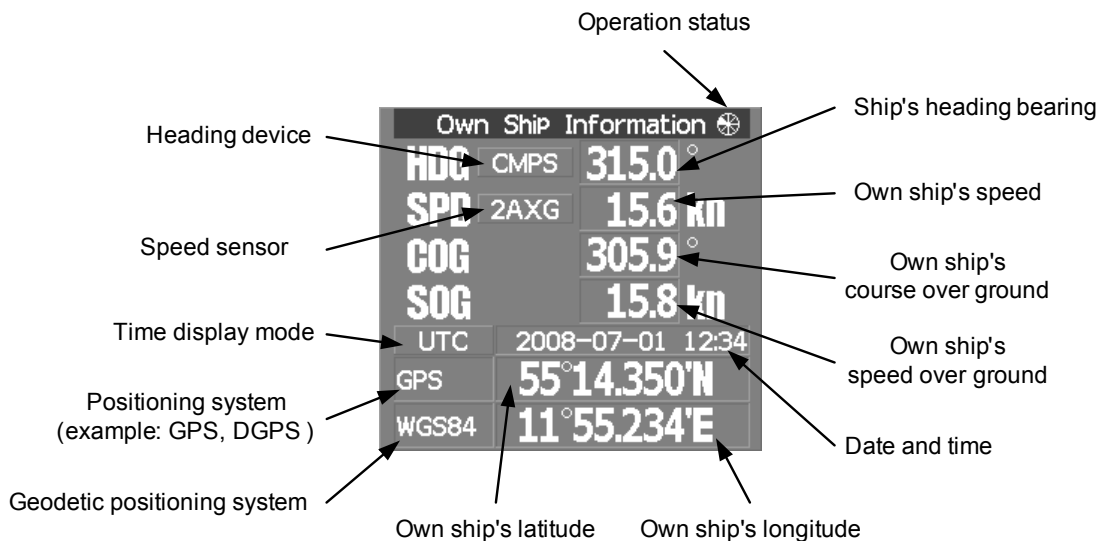

Target tracking (TT) / AIS information

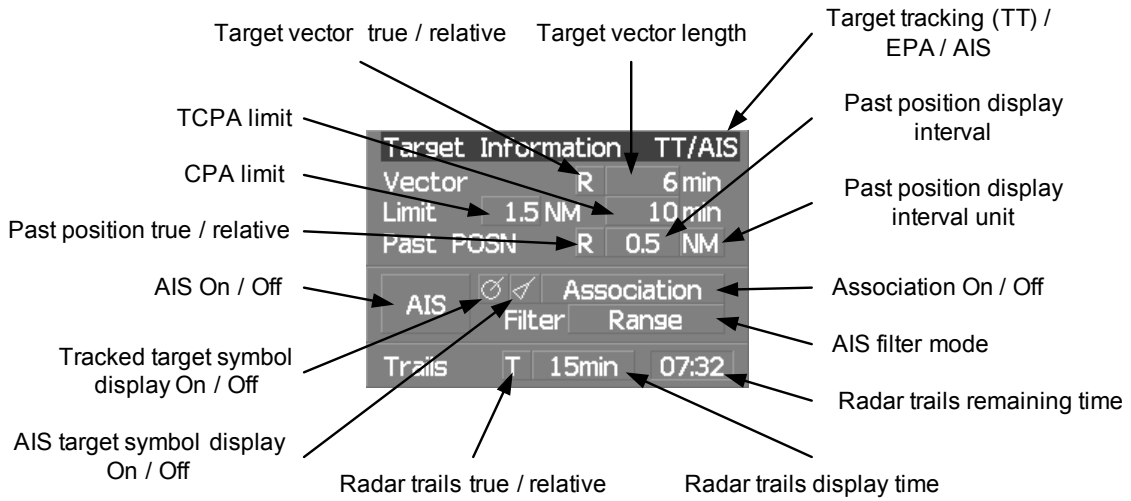

Numeric information: AIS target information

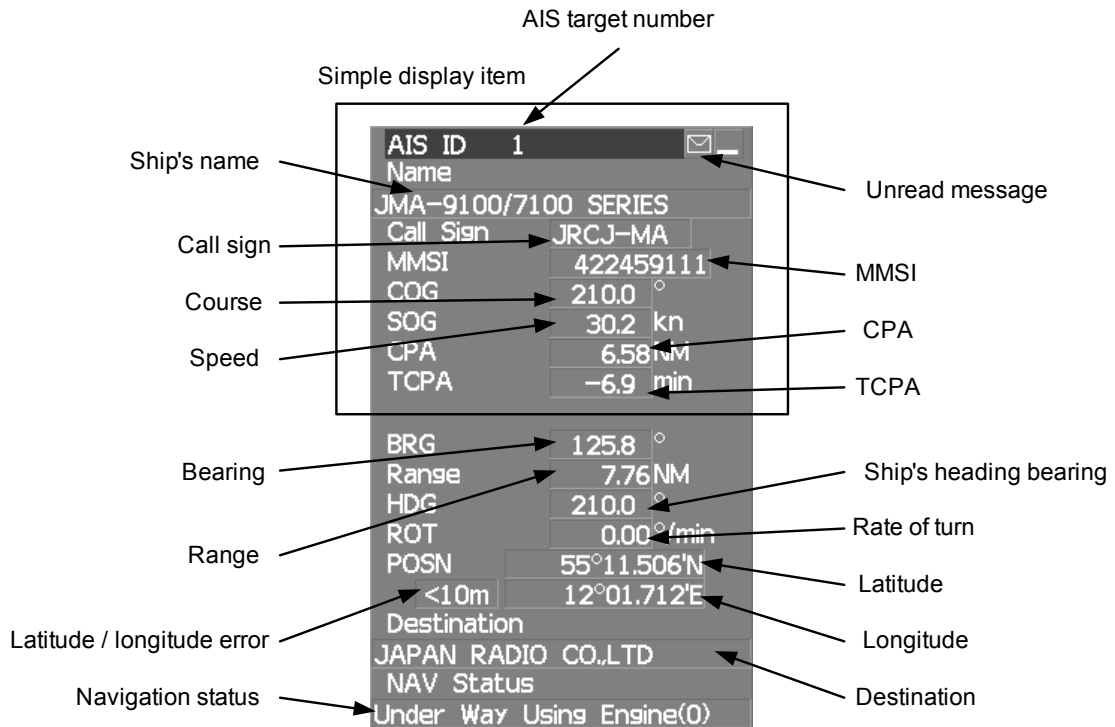

Numeric information: Tracked target information

Tracked target number

TT ID	2	1	
BRG	247.9	157.1	°
Range	3.97	5.98	NM
Course	337.0	327.3	°
Speed	19.0	31.9	kn
CPA	2.27	1.20	NM
TCPA	17.55	18.43	min
BCR	2.27		NM
BCT	17.2		min

No information is displayed if digital information value is not displayed

Numeric information: Enhancement of cursor position numeric value indication

Cursor bearing	126.2	°	T	Cursor bearing numeric value indication true / relative
Cursor range	11.42		NM	
	35	°	33.383'N	Cursor latitude
	139	°	51.658'E	Cursor longitude

Numeric information: Enhancement of EBL / VRM numeric value display

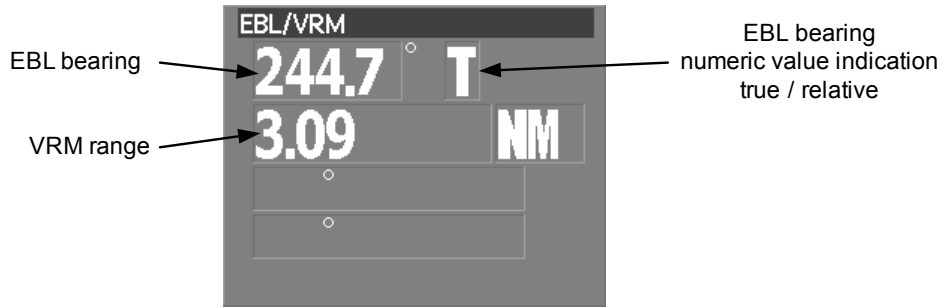

Numeric information: Navigation information

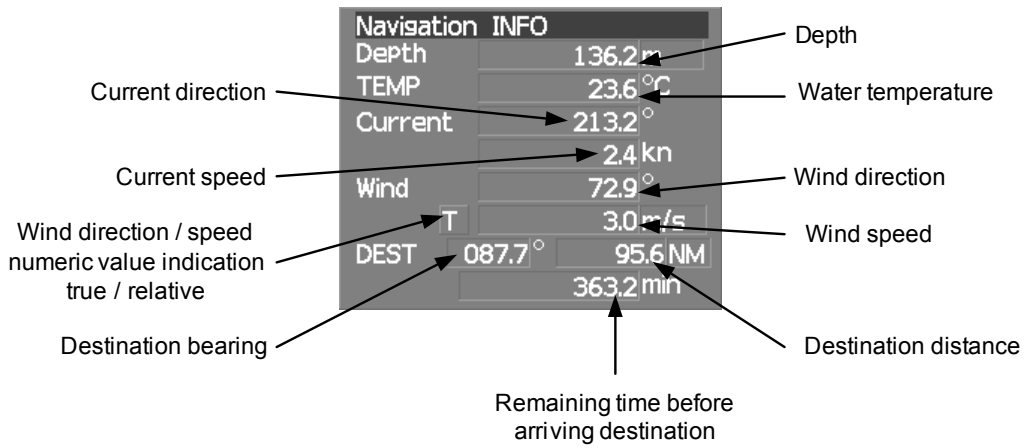

Graph information: Depth indication

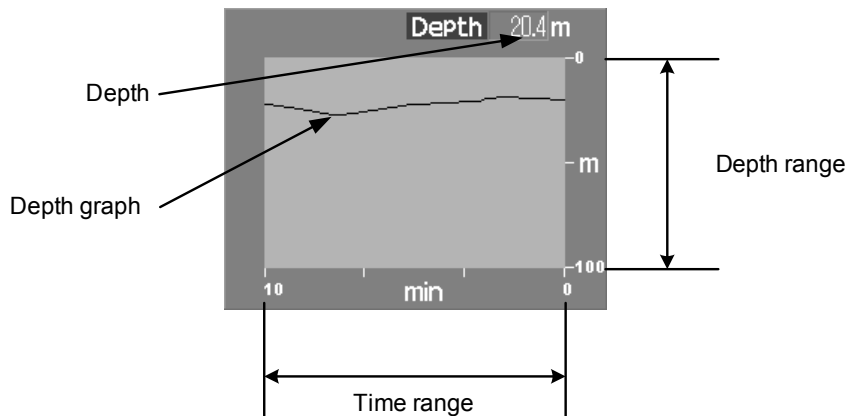

Graph information: Water temperature indication

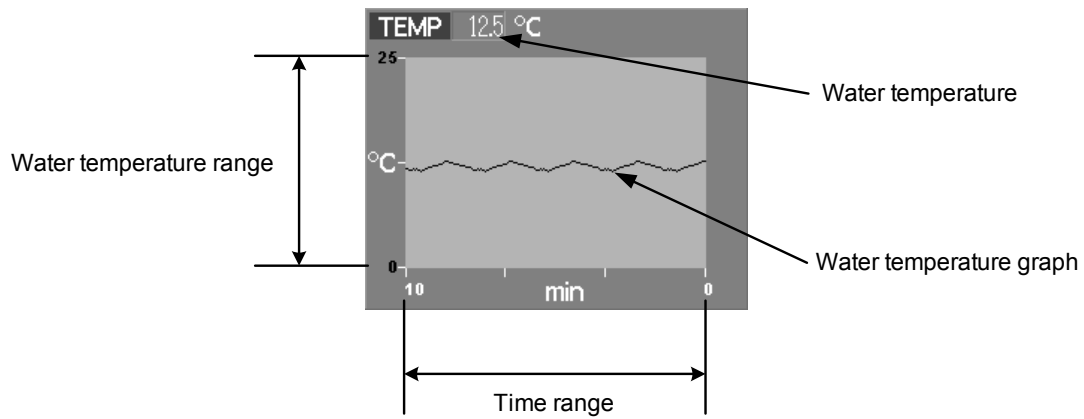

Graph information: Wind direction / speed

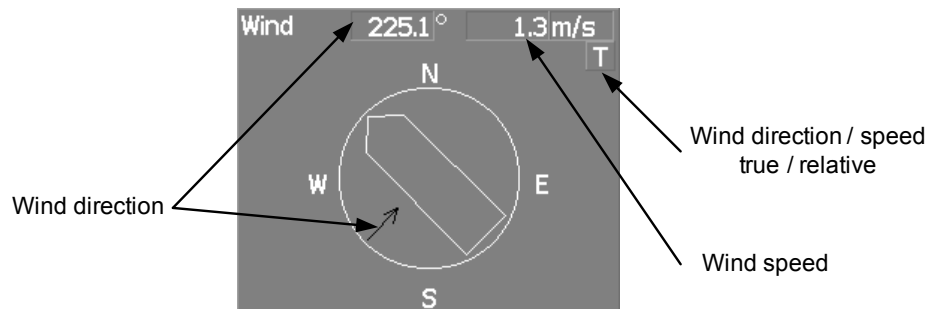

Graph information: Course bar

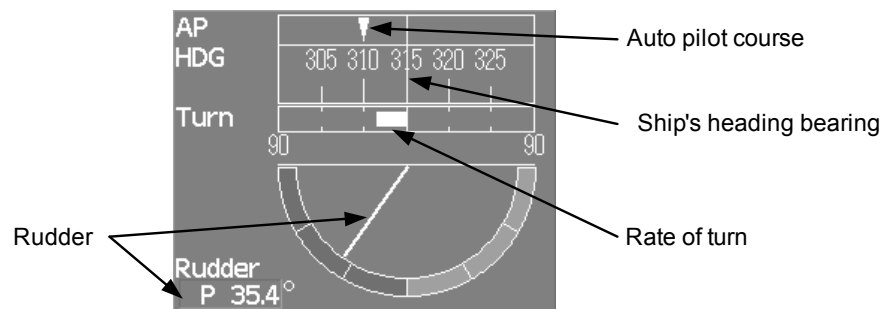

Numeric information: Marker



Menu

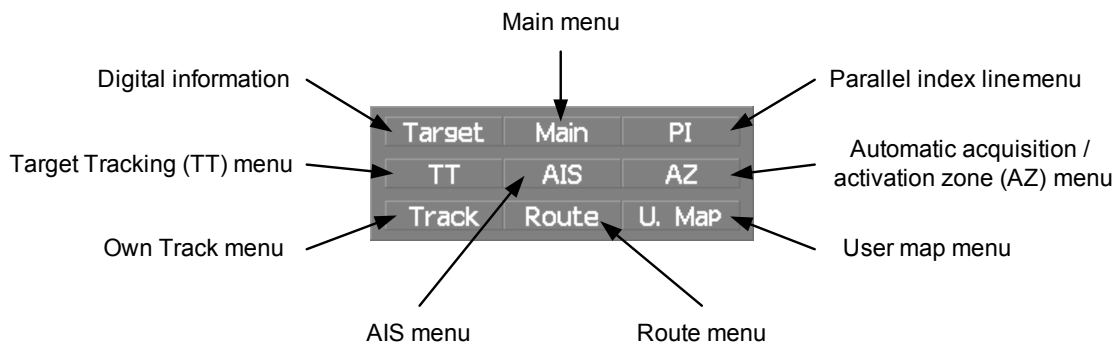

Brilliance

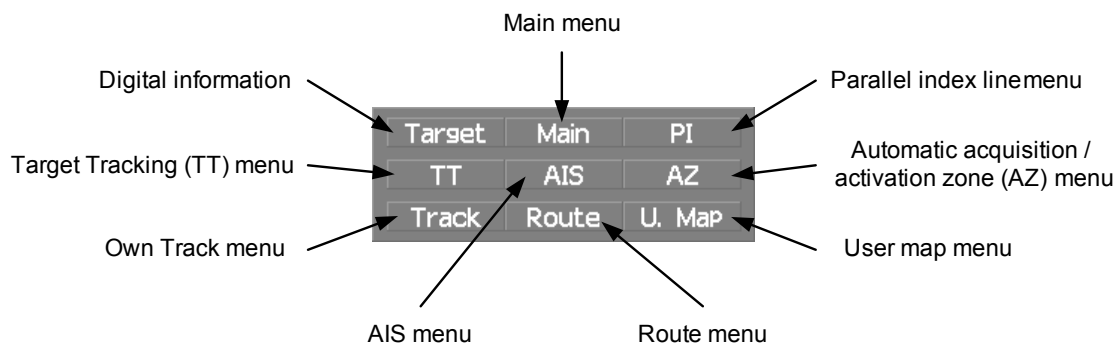

Display information

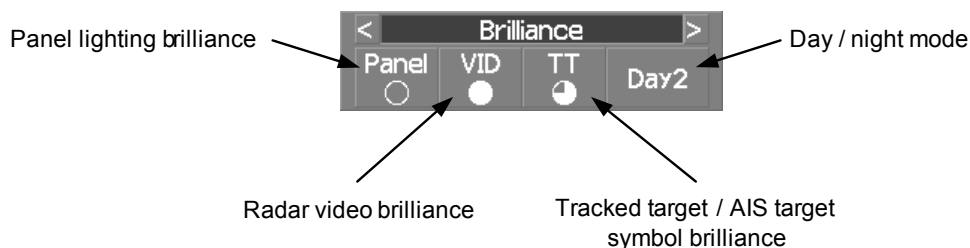

Alarm



Alarm indication
(The system alarm indicated in red.
Other information indicated in blue or yellow.)

2.2

NAMES AND FUNCTIONS OF CONTROL PANEL KEYS

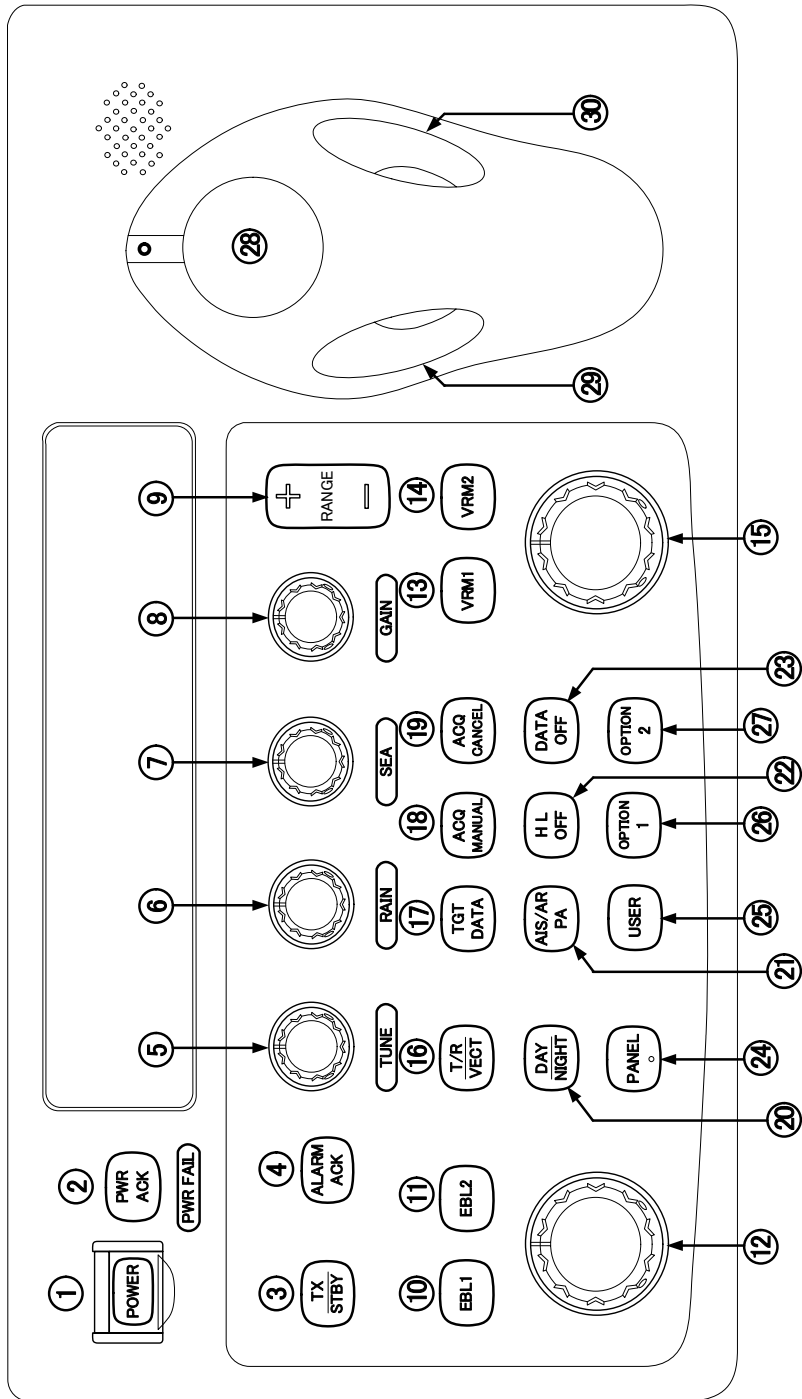

The name of each button is described from the following page. See below.

① **[POWER] (Power supply) switch**

The lamp is lit and the equipment is activated.

If this switch is pressed while the equipment is running, the power of the equipment is shut down.

→ 3.1.1 on page 3-2

② **[PWR ACK] (Power alarm acknowledgement) key**

Use this function to acknowledge the alarm when power supply abnormality occurs.

To enable this key, an external battery (separate power from normal AC) is required.

③ **[TX / STBY] (Transmission/Standby) key**

When the [POWER] switch is pressed, the "STANDBY" message is displayed in the top-left corner of the screen in about 3 minutes. If this key is pressed, transmission starts. If this key is pressed during transmission, the equipment is set to a standby state.

→ 3.1.1 on page 3-2

④ **[ALARM ACK] (Alarm acknowledgement) key**

Use this function to acknowledge alarms such as failure alarm, approaching target alarm, and collision alarm.

By pressing this key at the occurrence of an alarm, the alarm sound can be stopped.

If multiple alarms occur, press this key same time as the alarms.

→ 3.2.7 on page 3-12

⑤ **[TUNE] (Tuning) dial**

Use his function to tune a transmitter.

The mode is switched to manual/automatic whenever this dial is pressed.

→ 3.2.3 on page 3-7

⑥ **[RAIN] (Rain / snow clutter suppression) dial**

This function suppresses rain / snow clutters.

To increase the effect of suppression, turn the dial clockwise.

The mode can be switched to manual or automatic by pressing the dial.

→ 3.2.6 on page 3-11

⑦ **[SEA] (Sea clutter suppression) dial**

This function suppresses sea clutter.

To increase the effect of suppression, turn the dial clockwise.

The mode can be switched to manual or automatic by pressing the dial.

→ 3.2.5 on page 3-9

⑧ **[GAIN] (Gain/pulse length) dial**

This function adjusts the reception sensitivity of the radar.

To increase the sensitivity, turn the dial clockwise.

The transmission pulse width can be switched by pressing the dial.

gain → 3.2.4 on page 3-8

pulse width → 3.4.2 on page 3-24

⑨ **[RANGE + / -] (Range switching) key**

This function switches the range.

Press [+] to increase the observation range.

Press [-] to reduce the observation range.

→ 3.2.2 on page 3-6

⑩ **[EBL1] (Electronic Bearing Line 1) key**

Use this function to display and select EBL1.

If the key is pressed for 2 seconds or more, the menu for setting EBL1 is displayed.

→ 4.1.3 on page 4-3

⑪ **[EBL2] (Electronic Bearing Line 2) key**

Use this function to display and select EBL2.

If the key is pressed for 2 seconds or more, the menu for setting EBL2 is displayed.

→ 4.1.3 on page 4-3

⑫ **[EBL] (Electronic Bearing Line) dial**

This function rotates the azimuth of the EBL that is selected in EBL1/2.

By pressing the dial, the selected EBL can be switched to Center fixing → Floating → Center fixing.

→ 4.1.3 on page 4-3

⑬ **[VRM1] (Variable Range Marker 1) key**

This function selects VRM1. The On/Off and dial use right are switched.

→ on page 4-6

⑭ **[VRM2] (Variable Range Marker 2) key**

This function selects VRM2. The On/Off and dial use right are switched.

→ on page 4-6

⑮ **[VRM] (Variable Range Marker) dial**

This function changes the range of the VRM that is selected by VRM1/2.

By pressing the dial, the parallel line cursor function can be switched to Operation → Fixed → Off → Operation.

→ on page 4-6

⑯ **[T / R VECT] (True vector display / Relative vector display) key**

This function switches the display mode (true/relative) of the tracked target and AIS target vector.

→ 5.1.6 on page 5-13

⑰ **[TGT DATA] (Target data display) key**

This function displays the digital data of the tracked target or AIS target at the cursor position.

the tracked target → 5.2.3 on page 5-17

the AIS target → 5.3.5 on page 5-28

⑱ **[ACQ MANUAL] (Manual acquisition) key**

This function enables manual acquisition of the target at the cursor position.

→ 5.2.1 on page 5-14

⑲ **[ACQ CANCEL] (Tracked target cancellation) key**

This function cancels the symbol and vector of the target that is being tracked and stops the tracking of the target.

If this key is pressed for 2 seconds or more, all the targets that are being tracked are cancelled.

→ 5.2.2 on page 5-16

⑳ **[DAY / NIGHT] (Day/night mode) key**

This function switches the color and brightness of the screen that was preset.

→ 3.4.12 on page 3-35

㉑ **[AIS/TT] (AIS On/Off) key**

This function switches the AIS function to ON/OFF when the AIS function is enabled.

→ 5.3.2 on page 5-26

㉒ **[HL OFF] (Ship's heading line Off) key**

HL (ship's heading highlight line) can be set to Off only while this key is pressed.

→ 3.4.10 on page 3-34

⑳ **[DATA OFF] (DATA Off) key**

This function sets the graphics other than HL, range ring, EBL, and VRM to OFF temporarily while this key is pressed.

→3.4.11 on page 3-34

㉑ **[PANEL] (Operator panel brilliance) key**

This function adjusts the lighting brilliance of various switches and dial positions on the operator panel. The brightness changes cyclically whenever this key is pressed.

→3.4.13 on page 3-35

㉒ **[USER] key**

By pressing this key, the signal processing setting that is preset can be called.

The setting changes to FUNC OFF ==> FUNC1 ==> FUNC2 ==> FUNC3 ==> FUNC4 whenever this key is pressed.

If this key pressed for 2 seconds or more, the function setting menu is displayed.

→3.9 on page 3-111

㉓ **[OPTION1] key**

By pressing this key, the pre-registered menu position can be directly displayed.

At factory shipment, the calling of [Main Menu] is assigned.

→3.8.7 on page 3-103

㉔ **[OPTION2] key**

By pressing this key, the pre-registered menu position can be directly displayed.

At factory shipment, the calling of [Sub Menu] is assigned.

→3.8.7 on page 3-103

㉕ **Track ball**

This function moves the cursor mark to any position. Use this function for setting in each mode.

Use this function to specify a center position of floating EBL and an off-center position.

→3.3.1 on page 3-14

㉖ **[Track ball left button]**

Use this function to confirm menu selection and numeric value input.

㉗ **[Track ball right button]**

Use this function to reset menu selection and numeric value input.

㉘ **[BRILL] (Brilliance dial)**

This dial is provided at the right of the monitor. Use this function to adjust the brilliance of the monitor.

→3.2.1 on page 3-6

2.3

FUNCTIONS OF SOFTWARE BUTTONS

In this radar, the frequently used functions can be directly set from the screen without opening the menu by using the software buttons on the screen for quick handling. The screen is divided into a number of areas and each area is named.

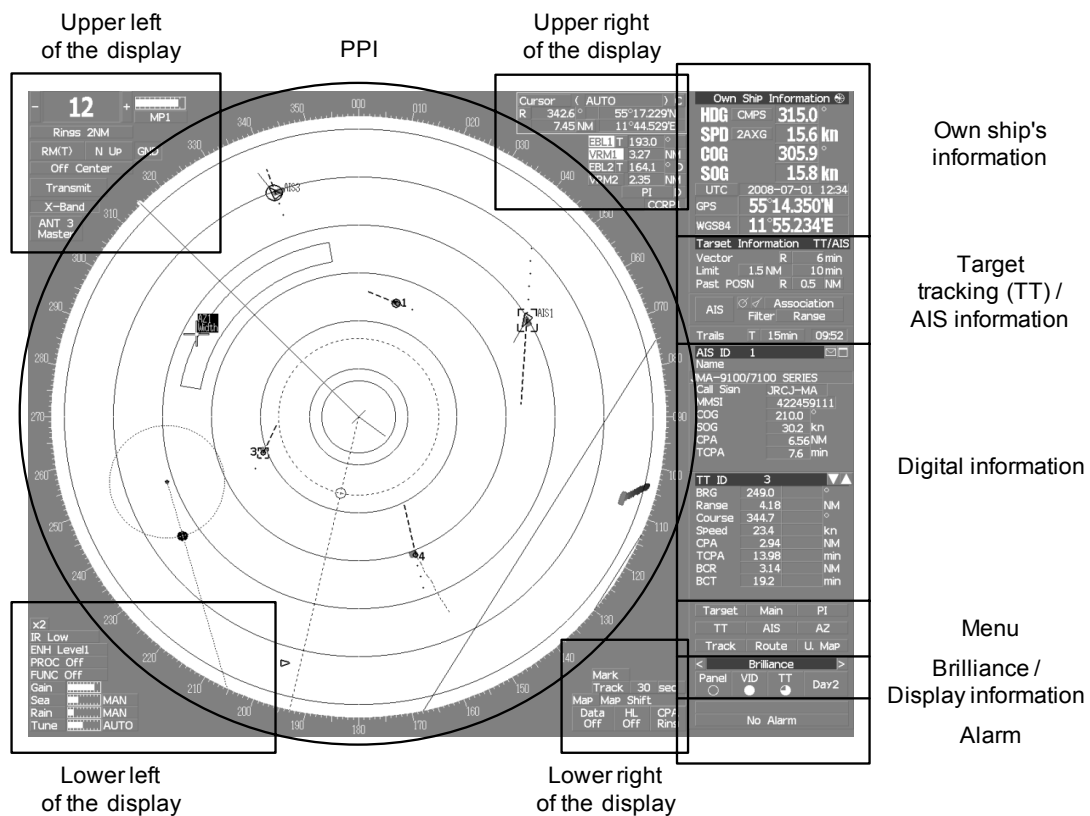

The name of each button is described from the next page. The function can be used by left-clicking while setting the arrow cursor on the button position.

Upper left of the display

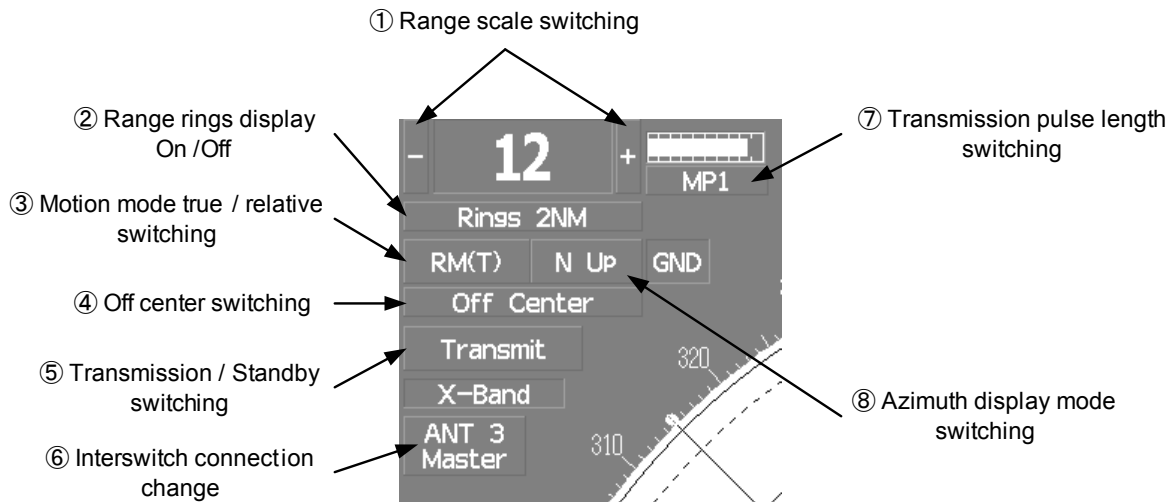

① Range scale switching

To increase the observation range scale (maximum 96NM), click **+** and to reduce the range (minimum 0.125NM), click **-**.

② Range rings display On / Off

The display of range rings are set to On / Off whenever this button is clicked. When the display is set to On, the interval of the fixed range marker is displayed.

③ Motion mode true / relative switching

The screen motion mode is switched whenever the button is clicked.

TM (true motion) ⇒ **RM** (relative motion) ⇒ **TM**

RM(R) indicates that the radar trails is a relative trail.

RM(T) indicates that the radar trails is a true trail.

④ Off center switching

If this button is clicked, the cursor is moved, and left-clicked, the ship's position can be moved to the cursor position. The moving range is within 66% of the radius.

If the button is clicked for 2 seconds, the off-center is set to Off and the ship's position is returned to the center of the screen.

⑤ Transmission / standby switching

At expiration of the pre-heat time after the power is turned on, **Preheat** changes to **Standby**.

Standby :Indicates a standby state. If this button is clicked in this state, the equipment is set to a transmission state.

Transmit :Indicates a transmission state. If this button is clicked in this state, the equipment is set to a standby state.

⑥ Interswitch connection change

This button is displayed when the interswitch is connected. This button indicates the connection status of the scanner unit that is connected to the indicator.

If the button is clicked in the transmission standby state, the menu for changing the connection state between the scanner unit and the indicator is displayed. The connection state of the scanner unit and indicator cannot be changed unless the master indicator is in a standby state.

Refer to the *Appendix A NQE-3141 Interswitch Unit Interswitch (Optional) Instruction Manual* that is attached for the setting method. This button is not displayed if the interswitch is not connected.

⑦ Transmission pulse length switching

The transmission pulse length is switched whenever this button is clicked. Three types of pulses are available, short pulse (SP), middle pulse (MP), and long pulse (LP). The pulse length and repetition frequency vary even for the same short pulse, according to the range that is used and it is displayed as **SP1** , **SP2** .

⑧ Azimuth display mode switching

The azimuth display is switched whenever this button is clicked.

H Up (Head Up) ⇒ **N Up** (North Up) ⇒ **C Up** (Course Up) ⇒ **H Up**

If the button is clicked for 2 seconds, the GYTO Setting menu is displayed.

Lower left of the display

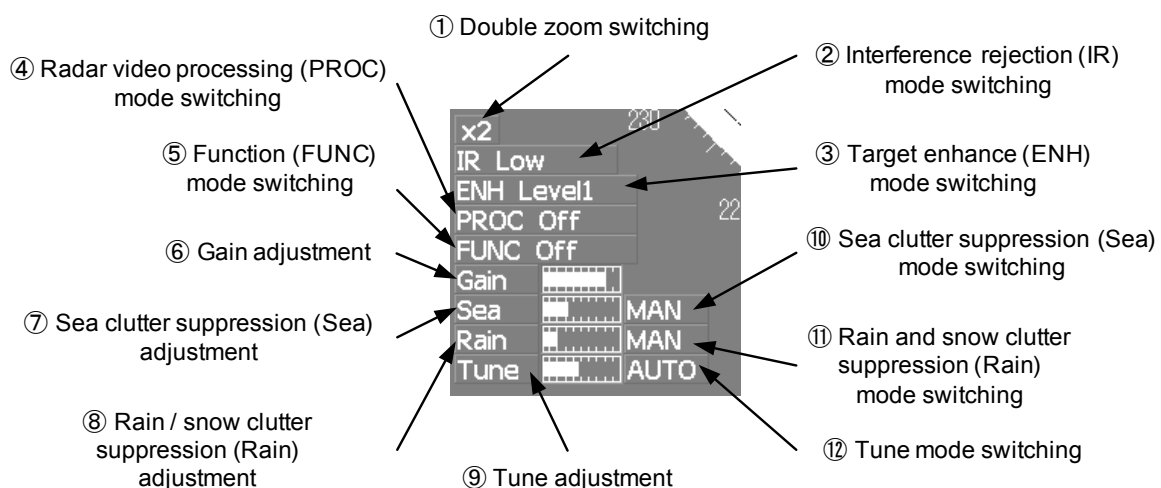

① Double zoom switching

Use this function to enlarge to double the size the display screen of the position specified by the cursor. If this button is clicked, the zoom mode is set. When the cursor is moved to the radar screen and left-clicked, the screen is enlarged to double the size so that the middle of the cursor and the own ship's position is set to the center of the screen. This function cannot be used when the range is 0.125NM.

② Interference rejection (IR) mode switching

The interference rejection mode is switched whenever this button is clicked.

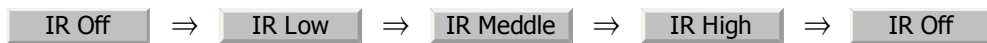

③ Target enhance (ENH) mode switching

The target enhance mode is switched whenever this button is clicked.



④ Radar video processing (PROC) mode switching

The radar video processing mode is switched whenever this button is clicked.

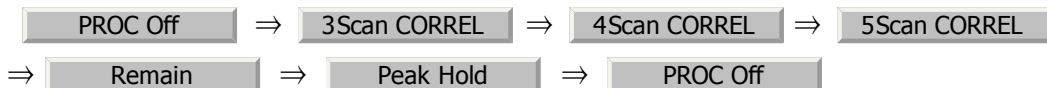

⑤ Function (FUNC) mode switching

The function mode is switched whenever this button is clicked.

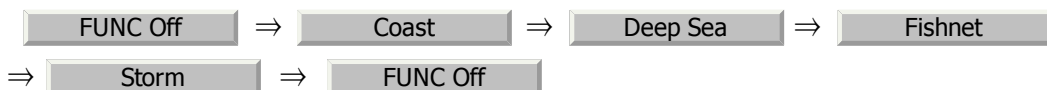

If the button is clicked for 2 seconds, the function registration menu (User Function Setting) is opened.

⑥, ⑦, ⑧ and ⑨ Gain, Sea clutter suppression(Sea), Rain / snow clutter suppression (Rain), Tune adjustment (Tune)

Adjust the gain, sea clutter suppression, rain / snow clutter suppression and tune using the track ball.

If the button is clicked on, the adjustment value is shown at the upper-right of the cursor. Make adjustments by moving the track ball to the left and right. Determine the adjustment by left-clicking.

⑩, ⑪ and ⑫ Sea clutter suppression (Sea) mode, Rain and snow clutter suppression (Rain) mode, and Tune mode switching

Use these functions to switch to the manual or automatic mode of sea clutter suppression, rain and snow clutter suppression, and tune. The bar on the left side indicates the position of the dial.

The mode is switched to **MAN** (manual) / **AUTO** (automatic) whenever the button is clicked. If rain and snow clutter suppression is switched to an automatic mode, sea clutter suppression is switched to an automatic mode also.

Upper Right of the display

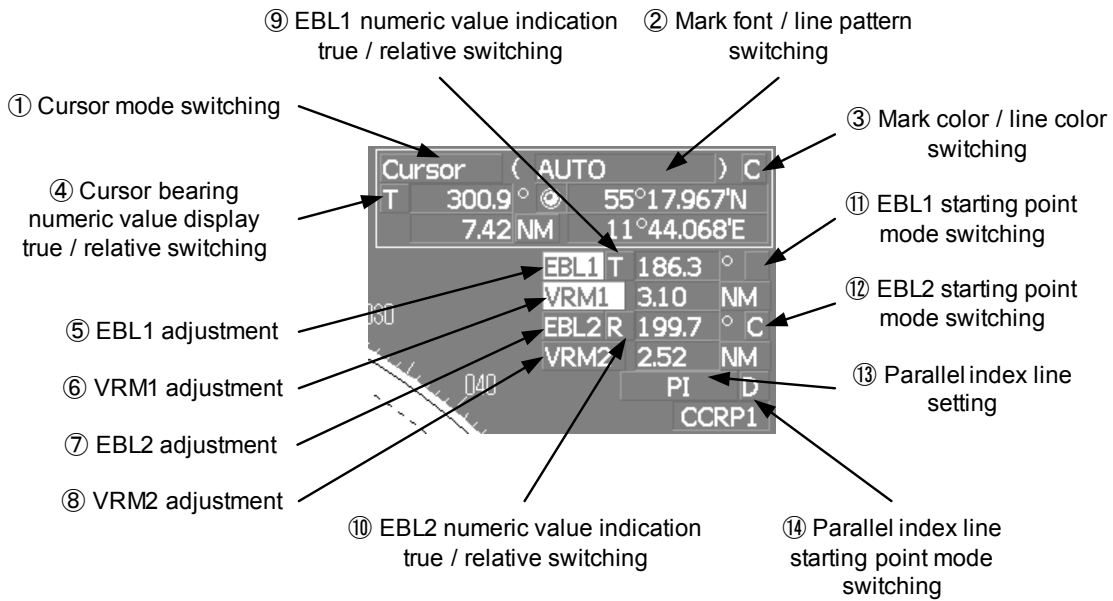

① Cursor mode switching

The mode of the function that uses the cursor is switched whenever this button is pressed.

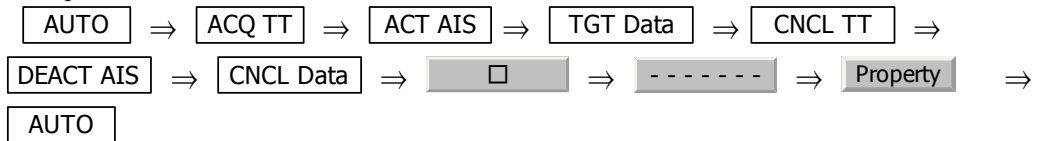

② Mark font / line pattern switching

This function switches a mark font / line pattern. If this button is clicked while the cursor mode is (mark) or ----- (line), the mark font / line pattern is changed.

③ Mark color / line color switching

This function switches a mark color / line color. If this button is clicked while the cursor mode is (mark) or ----- (line), the mark color / line color is changed.

④ Cursor bearing numeric value display true / relative switching

The bearing numeric value display **T** (true bearing) / **R** (relative bearing) of the cursor is switched whenever this button is clicked.

⑤, ⑥, ⑦ and ⑧ EBL1 / 2 and VRM1 / 2 adjustment

These functions set the EBL1 , VRM1 , EBL2 , and VRM2 displays to On / Off and acquire the operation right.

If the button is clicked on, the operation right is acquired. Make adjustments by moving the track ball to the left and right Determine the adjustment by left-clicking.

⑨ and ⑩ EBL1, EBL2 numeric value true / relative switching

The EBL1 / 2 bearing numeric value display **T** (true bearing) / **R** (relative bearing) is switched whenever the button is clicked.

If the button is clicked for 2 seconds, the EBL / Cursor Setting menu is displayed.

⑪ and ⑫ EBL1 / EBL2 starting point mode switching

The EBL starting point is set to CCRP or any position on the radar screen whenever this button is clicked.

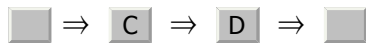

: Center

The starting point is fixed to the CCRP position.

C : Screen Fix

The starting point is set to the cursor position. If left-clicked subsequently, the starting position is fixed to the cursor position.

D : L/L Fixⁱ

The starting point is set to the cursor position. If left-clicked subsequently, the starting position is fixed to the latitude / longitude of the cursor. (Connection of a navigator is necessary.) If the starting point is moved outside of the screen, the operation is reset automatically and the starting point returns to the CCRP position.

i. **D** is enabled only when a navigator is connected.

⑬ Parallel index line setting

This function sets the parallel index line display to On / Off and acquires the operation right.

If this button is clicked, the operation right is acquired and the menu is opened. After setting, determine the setting by left-clicking.

⑭ Parallel index line starting point mode switching

The parallel index line starting point is set to CCRP or any position on the radar screen whenever this button is clicked.

In the same way as for the EBL starting point, three options are available, : Center, **C** : Screen Fix, and **D** : L/L Fix.

Lower right of the display

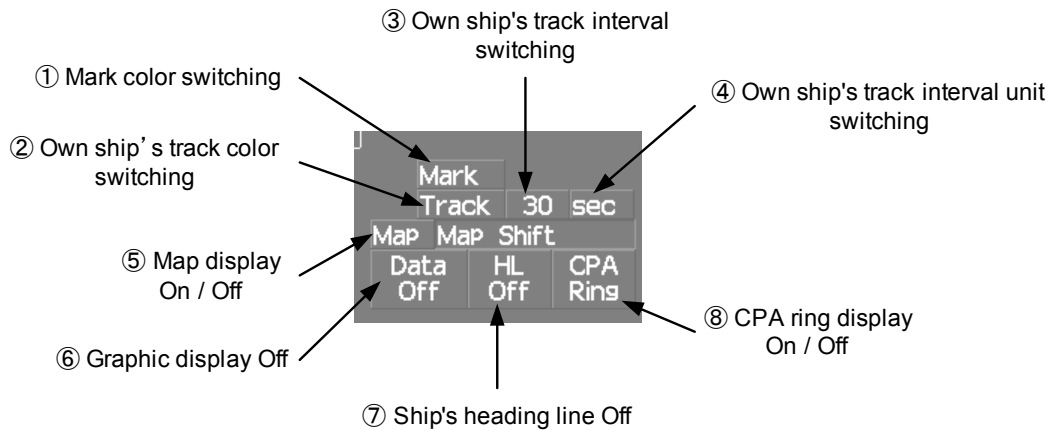

① Mark color switching

The color of the mark is switched whenever this button is clicked.
If the button is clicked for 2 seconds, the Mark Setting menu is opened.

② Own ship's track color switching

The own ship's track color is switched whenever this button is clicked.

③ Own ship's track interval switching

The own ship's track interval is switched whenever this button is clicked.

④ Own ship's track interval unit switching

The unit of the own ship's track interval is switched whenever this button is clicked.

sec ⇒ **min** ⇒ **NM** ⇒ **sec**

⑤ Map display On / Off

The map display is set to On / Off whenever this button is clicked.
Map information must be inserted in the card slot of the radar process unit in advance.
If the button is clicked for 2 seconds, the Map Setting menu is opened.

⑥ Graphic display Off

While the button is clicked, the graphic display other than VRM, EBL, HL, a cursor, and range rings on the radar screen is cleared temporarily.

⑦ Ship's heading line Off

The ship's heading line (HL) display is set to Off while this button is clicked.
Since the ship's heading line is cleared while the button is clicked, the target in the ship's heading bearing can be clearly seen.

⑧ CPA ring display On / Off

The CPA ring display is switched to On / Off whenever the button is clicked.

When the target vector display mode is **T** (true vector), the CPA ring cannot be set to On.

Own ship's information

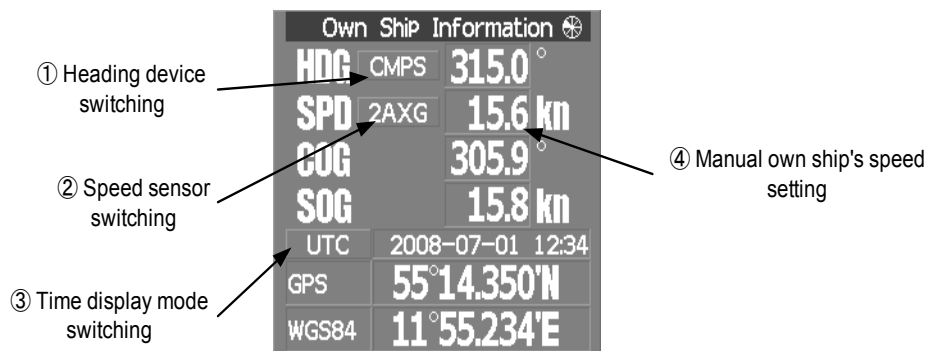

① Heading device switching

The heading device is switched whenever this button is clicked.

GYRO ⇒ **CMPS** (Electronic compass) ⇒ **GYRO**

When the selected heading device is not connected to the equipment, an alarm is issued.

② Speed sensor switching

The speed sensor is switched whenever the button is clicked.

MAN (Manual) ⇒ **LOG** (Single-axis water log) ⇒ **2AXW** (Dual-axis water log) ⇒ **2AXG** (Dual-axis ground log) ⇒ **GPS** ⇒ **MAN**

When the selected speed device is not connected to the equipment, an alarm is issued.

③ Time display mode switching

The time display mode **UTC** (universal time clock) / **LMT** (local mean time) is switched whenever this button is clicked.

④ Manual own ship's speed setting

When selection of the speed sensor is set to **MAN**, enter the own ship's speed manually.

If this button is clicked, the numeric value input screen is opened. After setting a value, determine the entry by clicking **ENT**.

Target tracking (TT) / AIS information

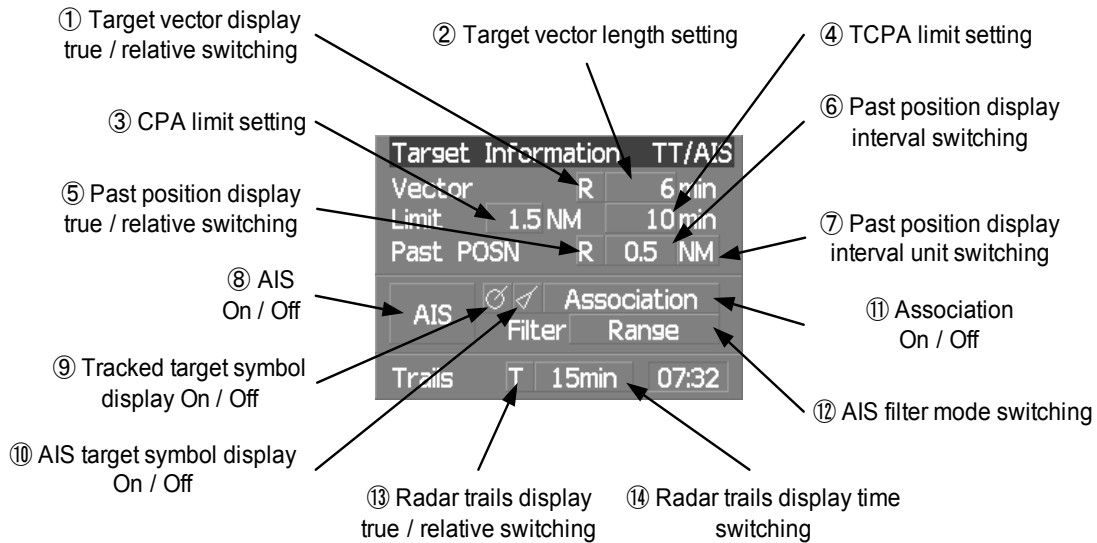

① Target vector display true / relative switching

The tracked target / AIS target vector display is switched to **T** (true vector) / **R** (relative vector) whenever this button is clicked.

This setting is switched together with the past position display true / relative switching.

② Target vector length setting

Set a vector length of the tracked target / AIS target.

If this button is clicked, the numeric value input screen is opened. After setting the length, determine the setting by clicking **ENT**.

③ CPA limit setting

Set a CPA limit.

If this button is clicked, the numeric value input screen is opened. After setting the limit, determine the setting by clicking **ENT**.

④ TCPA limit setting

Set a TCPA limit.

If this button is clicked, the numeric value input screen is opened. After setting the limit, determine the setting by clicking **ENT**.

⑤ Past position display true / relative switching

The tracked target / AIS target past position display is switched to **T** (true past position) / **R** (relative past position) whenever the button is clicked.

This setting is switched together with the target vector display true / relative switching.

⑥ Past position display interval switching

The past position display interval is switched whenever the button is clicked.

⑦ Past position display interval unit switching

The past position display interval unit is switched whenever the button is clicked.

min ⇒ **NM** ⇒ **min**

⑧ AIS On / Off

The AIS display is switched to On / Off whenever the button is clicked.

⑨ Tracked target symbol display On / Off

The tracked target symbol display is switched to On / Off whenever the button is clicked. Use this function to avoid confusion with the AIS symbol.

⑩ AIS target symbol display On / Off

The AIS target symbol display is switched to On / Off whenever the button is clicked. Use this function to avoid confusion with the tracked target symbol.

⑪ Association On / Off

The tracked target / AIS target association is switched to On / Off whenever the button is clicked.

⑫ AIS filter mode switching

The AIS filter is switched whenever the button is clicked.

Range ⇒ **Sector** ⇒ **Zone** ⇒ **Range**

⑬ Radar trails display true / relative switching

Radar trails are switched to **T** (true motion trail) / **R** (relative motion trail) whenever this button is clicked.

This setting is restricted by the radar display motion mode.

In relative motion display mode (RM), switching to **T** / **R** is possible.

In true motion display mode (TM), only **T** can be set.

⑭ Radar trails display time switching

The radar trails display time is switched whenever the button is clicked.

If the time does not reach the radar trails time that was set, the remaining time is displayed on the right-hand side.

If the button is clicked for 2 seconds, the RADAR Trails Setting menu is opened.

Numeric information: AIS target information

simple display

AIS ID	1	
Name	JMA-9100/7100 SERIES	
Call Sign	JRCJ-MA	
MMSI	422459111	
COG	210.0 °	
SOG	30.2 kn	
CPA	6.58 NM	
TCPA	-6.9 min	
BRG	125.8 °	
Range	7.76 NM	
HDG	210.0 °	
ROT	0.00 °/min	
POSN	55°11.506'N	
<10m	12°01.712'E	
Destination	JAPAN RADIO CO.,LTD	
NAV Status	Under Way Using Engine(0)	

① : Detail / simple display switching

② : Unread message display

① Detail / simple display switching

This function switches the display mode to detail / simple display when AIS target information is displayed.

② Unread message display

When there is an unread message from the AIS target that is displayed, the message is displayed. If this button is clicked, the message is displayed.

Numeric information: Tracked target information

TT ID	2	1	
BRG	247.9	157.1	°
Range	3.97	5.98	NM
Course	337.0	327.3	°
Speed	19.0	31.9	kn
CPA	2.27	1.20	NM
TCPA	17.55	18.43	min
BCR	2.27		NM
BCT	17.2		min

① Tracked target numeric value indication scroll

① Tracked target numeric value indication scroll

This function scrolls the target numbers that are indicated in the tracked target information.

Numeric information: Navigation information

Navigation INFO	
Depth	136.2m
TEMP	23.6°C
Current	213.2°
	2.4 kn
Wind	72.9°
	3.0 m/s
DEST	087.7° 95.6 NM
	363.2 min

① Wind direction / speed numeric value indication true / relative switching

① Wind direction / speed numeric value indication true / relative switching

The wind direction / speed numeric value indication is switched to **T** (true) / **R** (relative) whenever this button is clicked.

Graph information: Wind direction / speed

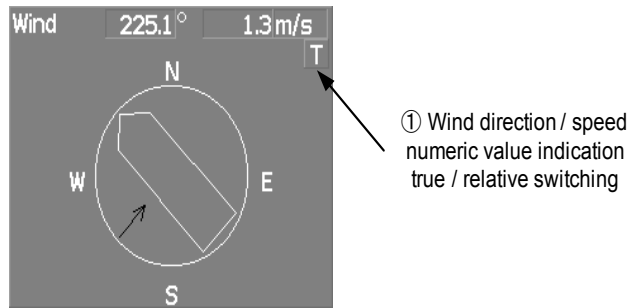

- ① Wind direction / speed numeric value indication true / relative switching

The wind direction / speed numeric value indication is switched to **T** (true) / **R** (relative) whenever this button is clicked.

Menu

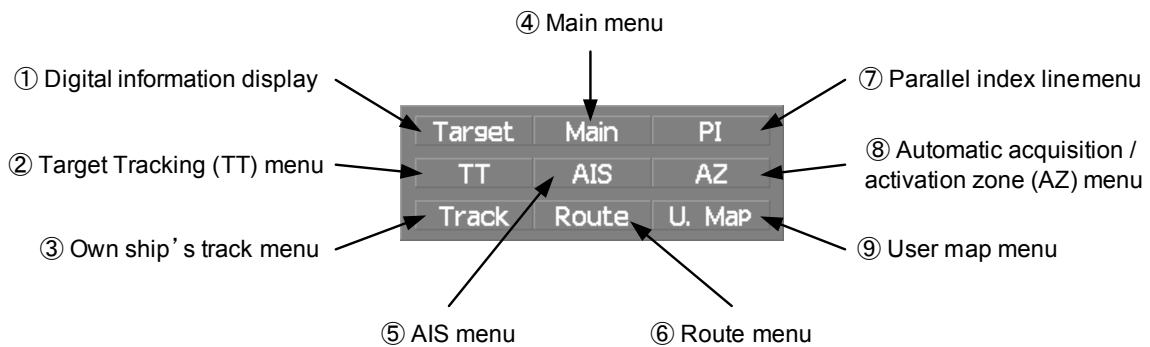

- ① Digital information display

If this button is clicked while the menu screen is open, the menu is closed and control returns to the digital information display.

This function switches between the tracked target / AIS target display and navigation information or the course bar, and so on.

- ② Target Tracking (TT) menu

If this button is clicked, the TT Menu is opened.

- ③ Own track menu

If this button is clicked, the Own Track Menu is opened.

- ④ Main menu

If this button is clicked, the Main Menu is opened.

⑤ AIS menu

If the button is clicked, the AIS Menu is opened.

⑥ Route menu

If this button is clicked, the Route Menu is opened.

⑦ Parallel index line menu

If this button is clicked, the PI Menu is opened.

⑧ Automatic acquisition / activation zone menu

If this button is clicked, the AZ Menu is opened.

⑨ User map menu

If the button is clicked, the User Map Menu is opened.

Brilliance

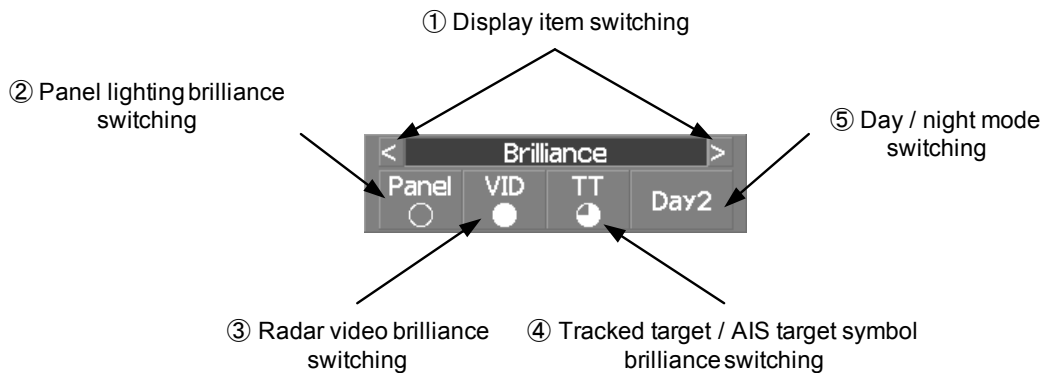

Display information

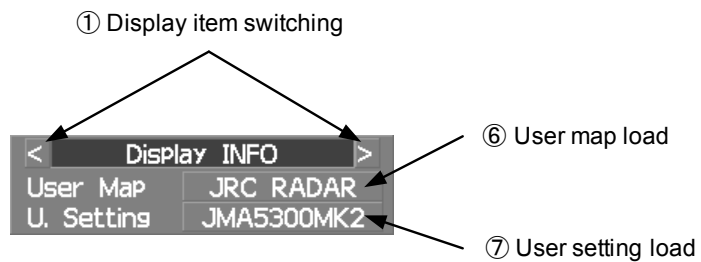

① Display item switching

The brilliance adjustment screen and display information setting screen interchange whenever this button is clicked.

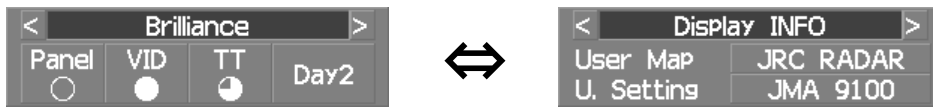

② Panel lighting brilliance switching

This function enables the setting of the brilliance of the lighting of the control panel. The brilliance changes whenever this button is clicked. Five levels of settings are available.

③ Radar video brilliance switching

Adjust the brightness of the radar video (echo). The brilliance changes whenever this button is clicked. Four levels of settings are available.

④ Tracked target / AIS target symbol brilliance switching

Use this function to adjust the brilliance of the tracked target / AIS target symbol. The brilliance changes whenever this button is clicked. Five levels of settings are available.

⑤ Day / night mode switching

The day / night mode is switched whenever this button is clicked.

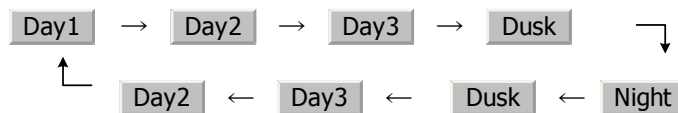

⑥ User map load

If this button is clicked, the user created map read menu is opened.

⑦ User setting load

If this button is clicked, the user setting read menu is opened.

Alarm

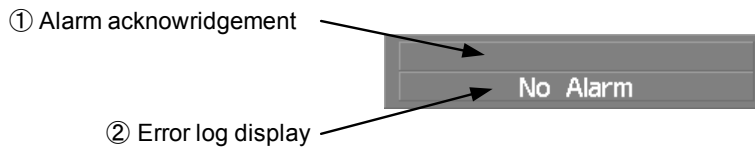

① Alarm acknowledgment

If this button is clicked, the buzzer sound of the alarm that is currently issued is stopped and the alarm lamp stops blinking. If multiple alarms are issued, the next alarm to be acknowledged is displayed.

If the button is clicked, the alarm displayed on the top is acknowledged.

The alarms that are currently issued are displayed at the bottom one by one.

② Error log display

If this button is clicked, the error log is display.



SECTION 3

BASIC OPERATION

BASIC OPERATION

3.1	OPERATION FLOW	3-1
3.1.1	Power ON and Start the System	3-2
3.1.2	Observe and Adjust Video	3-4
3.1.3	Acquire and Measure Data	3-4
3.1.4	Display and Measure with Reference to CCRP	3-4
3.1.5	End the Operation and Stop the System	3-5
3.2	OBSERVE AND ADJUST VIDEO	3-6
3.2.1	Adjust Monitor Brilliance [BRILL]	3-6
3.2.2	Change Observation Range [RANGE+/-]	3-6
3.2.3	Tune	3-7
3.2.4	Adjust Gain [GAIN]	3-8
3.2.5	Suppress Sea Clutter [SEA]	3-9
3.2.6	Suppress Rain/Snow Clutter [RAIN]	3-11
3.2.7	Reset Alarm Buzzer [ALARM ACK]	3-12
3.2.8	To get the appropriate image that targets can be easily observed ...	3-13
3.3	OPERATION PROCEDURES	3-14
3.3.1	Move Cross Cursor Mark by Trackball	3-14

3.3.2	Operate Software Buttons	3-15
3.3.3	Basic Menu Operation	3-16
3.3.4	Operation on Numeric Value, Latitude / Longitude and Character Input menu	3-17
3.3.5	Overview of Menu Structure	3-22
3.4	GENERAL RADAR OPERATION	3-23
3.4.1	Interference Rejection (IR)	3-23
3.4.2	Switch Transmitter Pulse Length [GAIN]	3-24
3.4.3	Target Enhance (ENH)	3-25
3.4.4	Use Video Processing (PROC)	3-26
3.4.5	Switch Azimuth Display Mode (AZI MODE)	3-27
3.4.6	Switch True/Relative Motion Display Mode (TM/RM)	3-28
3.4.7	Move Own Ship's Display Position (Off Center)	3-29
3.4.8	Display Radar Trails (Trails)	3-30
3.4.9	Zoom (x2)	3-33
3.4.10	Hide/Display Range Rings [HL OFF]	3-34
3.4.11	Hide Graphics Information on Radar Display [DATA OFF]	3-34
3.4.12	Switch Day/Night Mode [DAY/NIGHT]	3-35
3.4.13	Adjust Operation Panel Brilliance [PANEL]	3-35
3.4.14	Set True Bearing	3-36
3.4.15	Set Own Ship Speed	3-36
3.4.16	Magnet Compass Correction (MAG Compass Setting)	3-37
3.5	USE OWN SHIP'S TRACK	3-39
3.5.1	Display Own Ship's Track (Display Own Track)	3-39
3.5.2	Set Display Color of Own Ship's Track (Display Own Track Color)	3-40
3.5.3	Save Own Ship's Track (Own Track Memory)	3-41
3.5.4	Cancel Saving of Own Ship's Track (Own Track Memory)	3-41
3.5.5	Clear Own Ship's Track (Clear Own Track)	3-42
3.5.6	Use Expanded Own Ship's Track (Own Track Type)	3-42
3.5.7	Use Water Depth Track (Water Depth Track)	3-44
3.5.8	Use Water Temperature Track (Water TEMP Track)	3-45
3.5.9	Use Tidal Current Track (Current Vector Track)	3-46
3.6	DISPLAY USER MAP	3-47
3.6.1	Create User Map (Mark/Line)	3-47
3.6.2	Set User Map Display (Mark Display Setting)	3-50
3.6.3	Edit User Map (Edit User Map)	3-52
3.6.4	Correct Position on User Map (Shift User Map)	3-60
3.6.5	Save User Map	3-61
3.6.6	Set and Display Geodetic System (Geodetic)	3-65
3.7	USE ROUTE FUNCTION	3-67
3.7.1	Display Route/Destination Mark (Select Route)	3-67
3.7.2	Edit Route (Set Route Sequence)	3-68
3.7.3	Edit Route Make with Latitude and Longitude (Waypoint Input)	3-75
3.7.4	Use Route Monitoring Function (Waypoint/Route Alarm)	3-79

3.7.5	Method of Using Route	3-81
3.7.6	Detailed Route Settings	3-82
3.7.7	Clear Waypoint/Route Data (Clear WPT/Route Data)	3-86
3.7.8	Operate Route Data File	3-87
3.8	APPLIED OPERATIONS	3-91
3.8.1	Set Radar Signal Processing (Process Setting)	3-91
3.8.2	Set Radar Trails (RADAR Trails Setting)	3-95
3.8.3	Set Scanner Unit (TXRX Setting)	3-97
3.8.4	Set Cursor (Cursor Setting)	3-98
3.8.5	Set Radar Display (Display Setting)	3-99
3.8.6	Adjust Sound Volume (Buzzer Volume)	3-102
3.8.7	Set User Option Keys [OPTION 1/2]	3-103
3.8.8	Set Navigation Data Display (Multi Window Setting)	3-105
3.8.9	AUTO Backup	3-110
3.9	USE FUNCTION KEY [USER]	3-111
3.9.1	Operation Procedures	3-111
3.9.2	Function Setting Menu Items	3-112
3.9.3	Overview of Function Operations (User Function Setting)	3-113
3.9.4	Overview of saved Function Setting Data	3-117
3.10	USE USER SETTING	3-118
3.10.1	Save Operating State (Save User Setting)	3-118
3.10.2	Load Operating State (Load User Setting)	3-119
3.10.3	Delete Operating State (Delete User Setting)	3-119
3.11	USING CARD	3-120
3.11.1	Operate File on the Card (File Manager)	3-120

3.1 OPERATION FLOW

Attention

- Do not put anything on the operation panel.
If you put anything hot on it, it may be deformed.
- Do not give any impact to the operation panel,
trackball, or controls.
Otherwise, any failure or damage may result.

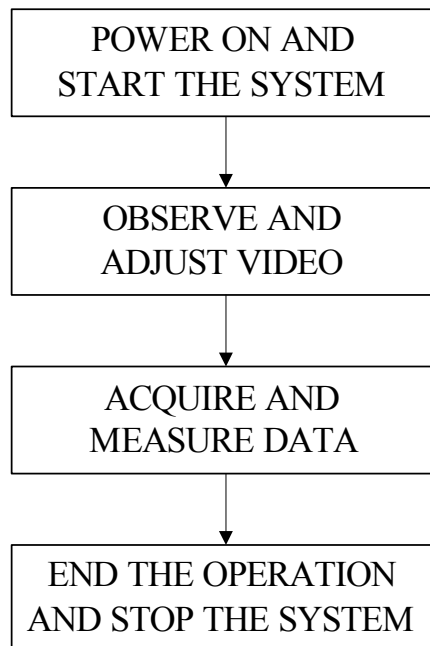

Each operation is described in detail below.

3.1.1 Power ON and Start the System



CAUTION



- A malfunction may occur if the power in the ship is instantaneously interrupted during operation of the radar. In this case, the power should be turned on again.

Attention

- Wait for about 2 seconds before turning on the power again.
- Immediately after the radar is installed, at start of the system after it has not been used for a long time, or after the magnetron is replaced, preheat the equipment in the standby state for 20 to 30 minutes before setting it into the transmit state.
- If the preheating time is short, the magnetron causes sparks, resulting in its unstable oscillation.

Start transmission on a short-pulse range and change the range to the longer pulse ranges in turn. If the transmission is unstable in the meantime, immediately place the system back into the standby state and maintain it in the standby state for 5 to 10 minutes before restarting the operation.

Repeat these steps until the operation is stabilized.

Procedures

- 1) **Check that the ship's mains are turned on.**
- 2) **Press [POWER] key.**

The system is turned on, and the preheating time is displayed.

Preheat is indicated at the upper left of the radar display.

- 3) **Wait until the preheating time is over.**

When the preheating time is over, the preheating time screen disappears, and **Preheat** at the upper left of the radar display changes to **Standby** .

- 4) **Press [TX/STBY] key.**

The radar will start transmission and the antenna will start rotating.

Standby at the upper left of the radar display changes to **Transmit** .

NOTE: The radar does not start transmission if you press [TX/STBY] key while **Preheat** is indicated.

3.1.2 Observe and Adjust Video

Procedures

- 1) Press **[RANGE+]** key or **[RANGE-]** key to set the range to the scale required for target observation.
- 2) **[GAIN]** **[SEA]** and **[RAIN]** to obtain the clearest targets.

Refer to

[GAIN] dial → Section 3.2.4 "Adjust Gain [GAIN]"

[SEA] dial → Section 3.2.5 "Suppress Sea Clutter [SEA]"

[RAIN] dial → Section 3.2.6 "Suppress Rain/Snow Clutter [RAIN]"

for how to use each dial.

For how to adjust video, see Section 3.2 "OBSERVE AND ADJUST VIDEO"

3.1.3 Acquire and Measure Data

For details on how to acquire data and measure, see the SECTION 4 "MEASUREMENT OF RANGE AND BEARING".

3.1.4 Display and Measure with Reference to CCRP

The radar video, range, bearing, Target Tracking and AIS data display etc... are displayed with reference to CCRP (Consistent Common Reference Point).

If scanner is switched, these data are measured from CCRP.

If some kind of functions set scanner position to outside of the PPI range, these data except Target Tracking and AIS data are displayed with reference to scanner position.

For how to setting CCRP, see the Section 7.1.9 "Setting of CCRP (CCRP Setting)".

3.1.5 End the Operation and Stop the System

Exit

1) **Press [TX/STBY] key.**

The radar will stop transmission and the antenna will stop rotating.

Transmit at the upper left of the radar display changes to **Standby**.



Maintain the standby state if radar observation is restarted in a relatively short time. Only pressing the [TX/STBY] key starts observation.

2) **Press [POWER] key.**

The system will be turned off.



WARNING



- **When conducting maintenance work, make sure to turn off the power and make the main breaker OFF so that the power supply to the equipment is completely cut off.**
- **Some equipment components can carry electrical current even after the power switch is turned off, and conducting maintenance work without unplugging the power connector may result in electrocution, equipment failure, or accidents.**

3.2

OBSERVE AND ADJUST VIDEO

3.2.1 Adjust Monitor Brilliance [BRILL]

Procedures

- 1) **Obtain the best-to-see display with optimum brilliance by turning the [BRILL] dial at the lower right of the monitor unit.**

Turning the [BRILL] dial clockwise increases the brilliance of the entire display.

Conversely, turning the [BRILL] dial counterclockwise decreases the brilliance of the entire display.

In consideration of the ambient brightness, adjust display brilliance that is high enough to easily observe the radar display but does not glare.

3.2.2 Change Observation Range [RANGE+/-]

Procedures

- 1) **Pressing the [RANGE+] key will increase the observation range, enabling the wider area to be observed.**



Increasing the observation range will enable a wider range to be observed.

However, a video image is small and the ability to detect targets near own ship decreases. Therefore, when observing the vicinity of own ship, use the smaller observation range.

- 2) **Pressing the [RANGE-] key will decrease the observation range, reducing the area that can be observed.**

Decreasing the observation range will enable the vicinity of own ship to be enlarged. However, caution must be taken because video images of the area beyond the observation range cannot be displayed.

3.2.3 Tune

 CAUTION	
	<p>Normally, use the automatic tune mode.</p> <p>Use the manual tune mode only when best tuning is not possible in the automatic tune mode due to deterioration of magnetron.</p>

3

This radar system provides the automatic tune mode and the manual tune mode. The automatic tune mode automatically adjusts the tuning of the transmitting frequency and the receiving frequency, and the manual tune mode enables tuning to be adjusted by using the dial located on the operation panel. Normally use the automatic tune mode. Only when the best tuning is not possible by the automatic tune mode due to the deterioration of magnetron, use the manual tune mode.

The currently used tune mode is displayed in the area at the lower left of the display.

3.2.3.1 When using the automatic tune mode

Procedures

- 1) **Press the [TUNE] dial to set the automatic tune mode.**



Tune adjustment is automatically conducted in the automatic tune mode. Tune is adjusted at the start of transmission, at the change of the range or pulse width. Tune adjustment is completed within several seconds.

3.2.3.2 When using the manual tune mode

Procedures

- 1) **Press the [TUNE] dial to set the manual tune mode.**
- 2) **Turn the [TUNE] dial to make adjustments so that the tuning bar is maximized. The tuning bar is displayed in the area at the upper left of the display.**

3.2.4 Adjust Gain [GAIN]

 <h2 style="display: inline;">CAUTION</h2>	
	<p>If the gain is too high, unnecessary signals including receiver noise and false images increase resulting in reduction of visibility of targets.</p> <p>On the contrary, if the gain is too low, targets including ships and dangerous objects may not be clearly indicated.</p> <p>Be sure to always adjust for the best gain.</p>

See also the Section 3.2.8 "To get the appropriate image that targets can be easily observed".

Procedures

- 1) **Adjust noise on the radar display by turning the [GAIN] dial until targets can be easily observed.**

Turning [GAIN] dial clockwise increases gain.

Turning [GAIN] dial counterclockwise decreases gain.

Turning the [GAIN] dial clockwise will increase the receiving gain, and the range to observe radar video is widened. However, if the gain is too high, unnecessary signals including receiver noise and false images increase resulting in reduction of targets' visibility.

To observe densely crowded targets or short-range targets, turning the [GAIN] dial counterclockwise will decrease the receiving gain, which enables targets to be easily observed. However, caution must be taken so as not to overlook a small and important target.



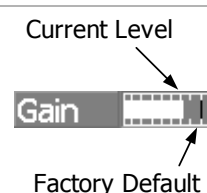

It is recommended to restore the setting to the factory default, if you lost the appropriate settings. The factory default level is shown on the bar chart as a green line.

The factory default level is assigned by every function mode. See the Section 3.9 "USE FUNCTION KEY [USER]"



3.2.5 Suppress Sea Clutter [SEA]

 <h2 style="display: inline;">CAUTION</h2>	
	<p>When using the [AUTO SEA] function, never set the suppression level too high canceling out all image noises from the sea surface at close range.</p> <p>Detection of not only echoes from waves but also targets such as other ships or dangerous objects will become inhibited.</p> <p>When using the [AUTO SEA] function, make sure to choose the most appropriate image noise suppression level.</p>

3

See also the Section 3.2.8 "To get the appropriate image that targets can be easily observed".

3.2.5.1 Using the manual sea clutter suppression mode

Procedures

- 1) **Adjust the sea clutter returns on the radar display by turning the [SEA] dial until targets can be easily observed.**

Turning [SEA] dial clockwise suppresses sea clutter returns.

Turning [SEA] dial counterclockwise intensifies sea clutter returns.

The sea clutter suppression function suppresses sea clutter returns by decreasing the receiving gain on a short range.

Turning the [SEA] dial clockwise heightens the effect of sea clutter suppression. However, be careful that excessive suppression causes low signal-strength targets such as buoys and boats to disappear from the radar display.

i It is recommended to restore the setting to the factory default, if you lost the appropriate settings. The factory default level is shown on the bar chart as a green line.

The factory default level is assigned by every function mode. See the Section 3.9 "USE FUNCTION KEY [USER]"

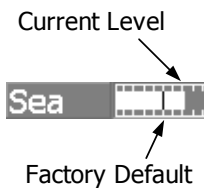

The diagram shows a horizontal bar chart with a scale. A green vertical line is positioned at the far left of the scale, labeled 'Factory Default'. A black vertical line is positioned further to the right, labeled 'Current Level'. The word 'Sea' is written on the left side of the bar chart.

3.2.5.2 Using the automatic sea clutter suppression mode

The sea clutter suppression in accordance with the intensity of sea clutter is possible. Use this mode when the sea clutter's intensity differs according to directional orientation.

Procedures

- 1) **Press the [SEA] dial. Alternatively, Left-click the Sea MAN button located at the lower left of the display.**

The automatic sea clutter suppression mode is selected, and Sea AUTO is displayed in the lower left of the radar display.

- 2) **Make adjustments by turning the [SEA] dial.**

Even when the automatic sea clutter suppression mode is selected, turning the [SEA] dial can make fine adjustments manually.

NOTE: When the automatic sea clutter suppression mode is selected, the automatic rain/snow suppression mode is switched to the manual mode.



To select both the sea clutter suppression function and the rain/snow suppression function in the automatic mode, use the automatic rain/snow suppression mode.

Cancel

- 1) **Press the [SEA] dial. Alternatively, Left-click the Sea AUTO button located at the lower left of the display.**

The automatic sea clutter suppression mode is cancelled, and Sea MAN is displayed in the lower left of the radar display.

3.2.6 Suppress Rain/Snow Clutter [RAIN]

 <h2 style="display: inline;">CAUTION</h2>	
	<p>When using the [AUTO RAIN] function, never set the suppression level too high canceling out all image noises from the rain or snow at the close range.</p> <p>Detection of not only echoes from the rain or snow but also targets such as other ships or dangerous objects will become inhibited.</p> <p>When using the [AUTO RAIN] function, make sure to choose the most appropriate image noise suppression level.</p>

3

See also the Section 3.2.8 "To get the appropriate image that targets can be easily observed".

3.2.6.1 Using the manual rain / snow clutter suppression mode

Procedures

- 1) **Adjust the rain / snow clutter returns of the display by turning the [AUTO-RAIN] dial until targets can be easily observed.**

Turning [RAIN] dial clockwise suppresses rain / snow clutter returns.

Turning [RAIN] dial counterclockwise intensifies rain / snow clutter returns.

When the [RAIN] dial is turned clockwise, the rain / snow clutter suppression function suppresses rain / snow clutter returns and gets targets hidden by rain / snow clutter returns to appear of the display. However, be careful that excessive suppression may cause small targets to be overlooked. Since the rain / snow clutter suppression function also has the effect of suppressing sea clutter, the suppression efficiency improves when the [RAIN] dial is used with the [SEA] dial. In general, turn the [RAIN] dial fully to the left.

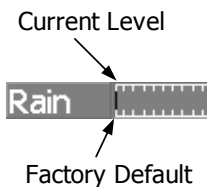
	<p>It is recommended to restore the setting to the factory default, if you lost the appropriate settings. The factory default level is shown on the bar chart as a green line.</p>	
<p>The factory default level is assigned by every function mode. See the Section 3.9 "USE FUNCTION KEY [USER]"</p>		

3.2.6.2 Using the automatic rain / snow clutter suppression mode

The rain / snow clutter suppression in accordance with the intensity of rain / snow clutter is possible. Use this mode when the rain / snow clutter's intensity differs according to directional orientation.

Procedures

- 1) **Press the [RAIN] dial. Alternatively, Left-click the Rain MAN button located at the lower left of the display.**

The automatic rain / snow clutter suppression mode is selected, and Sea AUTO, Rain AUTO is displayed in the lower left of the radar display.

- 2) **Make adjustments by turning the [RAIN] dial and the [SEA] dial.**

Even when the automatic rain / snow clutter suppression mode is selected, turning the [RAIN] dial and the [SEA] dial can make fine adjustments manually.

NOTE: When the automatic rain / snow clutter suppression mode is selected, the automatic sea clutter suppression mode is also activated.

It is not possible to set only the rain / snow clutter suppression function to the automatic mode.

Cancel

- 1) **Press the [RAIN] dial. Alternatively, Left-click the Rain AUTO button located at the lower left of the display.**

The automatic rain / snow clutter suppression mode is cancelled, and Sea AUTO, Rain AUTO is changed to Sea MAN, Rain MAN in the lower left of the radar display.

3.2.7 Reset Alarm Buzzer [ALARM ACK]

When an audible alarm is issued, use ALARM ACK to acknowledge the alarm information, stop the alarm buzzing, and stop the alarm lamp flashing. (If more than one alarm has occurred, press the switch for each alarm indication.) The alarm stops buzzing, but the alarm indication does not disappear.

Procedures

- 1) **Press [ALARM ACK] key. Alternatively, Left-click the Alarm Acknowledge button located at the lower right of the display.**

The alarm will stop buzzing.

3.2.8 To get the appropriate image that targets can be easily observed

To get the appropriate image that targets can be easily observed which requires an understanding for RADAR signal processing features and an adjustment for the sea state. All of the parameter can be set indivisually and manually, but it may be difficult for even expert person.

The sets of signal processing parameters for the general using condition are stored in FUNC as factory default settings. In most cases, to select the FUNC mode which fit in the current sea state is lead to get the appropriate image easily and quickly. So It is recommended to enable the FUNC mode.

Procedures

- 1) **Press [USER] key / Press FUNC mode switch button and select the mode which fit in the current sea state.**

The four preset modes is assigned on the FUNC mode. For details, refer to the Section 3.9 "USE FUNCTION KEY [USER]".

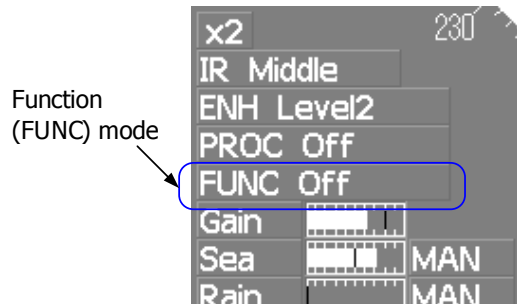

- Coast** : Use this mode to monitor a relatively short range, for example, bays and coasts where many boats and ships are running.(Importance is attached to resolution.)

- Deep Sea** : Use this mode to monitor a relatively long range, for example, the open sea. (Importance is attached to long-range gain.)

- Storm** : Use this mode when many rain / snow clutter returns or sea clutter returns are detected in stormy weather. (Importance is attached to rain / snow clutter and sea clutter suppression, and gain slightly lowers.)

- Rain** : Use this mode when sea clutter is not strong but rain / snow clutter is strong. (Importance is attached to rain / snow clutter suppression, and gain slightly lowers.)

- 2) **Make adjustments by turning the [GAIN] dial, the [SEA] dial and the [RAIN] dial when it is necessary.**

In most cases, it may be get the appropriate image.

i It is recommended to restore the setting to the factory default, if you lost the appropriate settings.The factory default level is shown on the bar chart as a green line.

The factory default level is assigned for every function mode. See the Section 3.9 "USE FUNCTION KEY [USER]"

3.3

OPERATION PROCEDURES

3.3.1 Move Cross Cursor Mark by Trackball

The cross cursor mark + is used for position designation and other purposes in various operating procedures. The cross cursor mark + moves in coupling with the trackball. If the trackball is rotated up and down or right and left, the cross cursor mark follows the move of the trackball.

Operators must be familiar with trackball operation before running the system.

3.3.1.1 Operation inside Radar Video PPI

The cross cursor mark as shown at right is displayed inside the radar video PPI.



- The distance, bearing, and latitude/longitude are digitally indicated in the cursor bearing, distance, latitude, and longitude fields (located at the upper right of the radar display.)
- When moving the current center position, use the cross cursor mark to designate a new center position.
- Use the cross cursor mark to create marks and lines.
- Use the cross cursor mark to manually acquire a target in the target tracking / AIS display functions.

3.3.1.2 Operation outside Radar Video PPI

As shown at right, the cursor mark changes into the cursor outside the radar video PPI.



- Use the cursor to operate software buttons.
- Use the cursor to select menu items.



The EBL / VRM dial is available for operating the cursor mark. Pressing the EBL dial for 2 seconds can perform switching to the trackball operation. For details, refer to Section 3.8.4 "Set Cursor (Cursor Setting)".

3.3.2 Operate Software Buttons

Software buttons are provided on the radar display so as to easily switch functions without operating menu items.

For software buttons that can be operated and their locations, see Section 2.3 "FUNCTIONS OF SOFTWARE BUTTONS".

Procedures

1) **Put the pointer on the software button on the radar display.**

The software button indicated by the cursor will be shown in reverse video, which indicates that the button is specified.

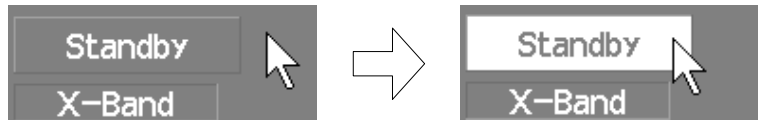

2) **Press the left button of the trackball.**

The operating state changes according to the function of the software button.

In this instruction manual, this manual operation is described as "left-clicking."

- On/Off settings

Each time the left button is pressed, the operating state switches as follows:

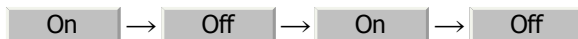

- Multiple settings

For example, each time the left button is pressed, the operating state switches as follows:



3.3.3 Basic Menu Operation

3.3.3.1 To open the menu

By left-clicking the **Main** button located at the lower right of the radar display, the main menu will open

By left-clicking the buttons, **TT** , **AIS** , and **AZ** , adjacent to **Main** , each function's exclusive menu will open.

For the arrangement of software buttons, see Section 2.3 "FUNCTIONS OF SOFTWARE BUTTONS".

3.3.3.2 To close the menu

By left-clicking the **Target** button, the menu will close and the target data display screen will appear.

Alternatively, left-click **0.Exit** located at the bottom of the menu until the menu will close.

3.3.3.3 To move to a lower level of the menu

The menu is in hierarchical structure. By left-clicking the software button for a desired menu item, it is possible to move to the lower level of the menu.

Alternatively, Click items corresponding to the desired menu item number, and the **>** mark will appear at the right end of a menu item having a lower level.

3.3.3.4 To move to a higher level of the menu

By left-clicking **0.Exit** at the bottom of the menu while the menu is open, it is possible to return to the upper level of the menu.

3.3.3.5 To determine an item

By left-clicking the software button for a menu item for which settings are to be changed, the selected item will be displayed.

3.3.3.6 To determine the selected item

Left-click the software button for an item you want to set, and then the selected item will be determined.

If you do not change the setting, right-click the button. The selected item will close without changing the setting.

3.3.3.7 Menu Operation with the Trackball

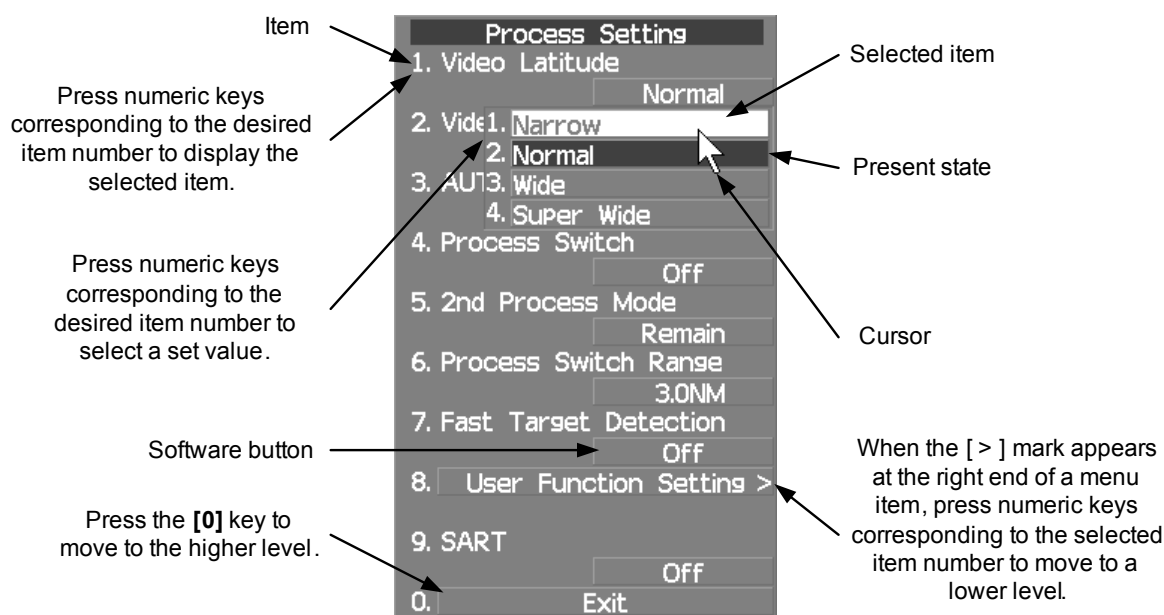

3.3.4 Operation on Numeric Value, Latitude / Longitude and Character Input menu

When a numeric value must be entered while operating this radar system, the numeric value input screen will appear. In that case, enter a numeric value according to the following operation method.

3.3.4.1 Numeric value input screen

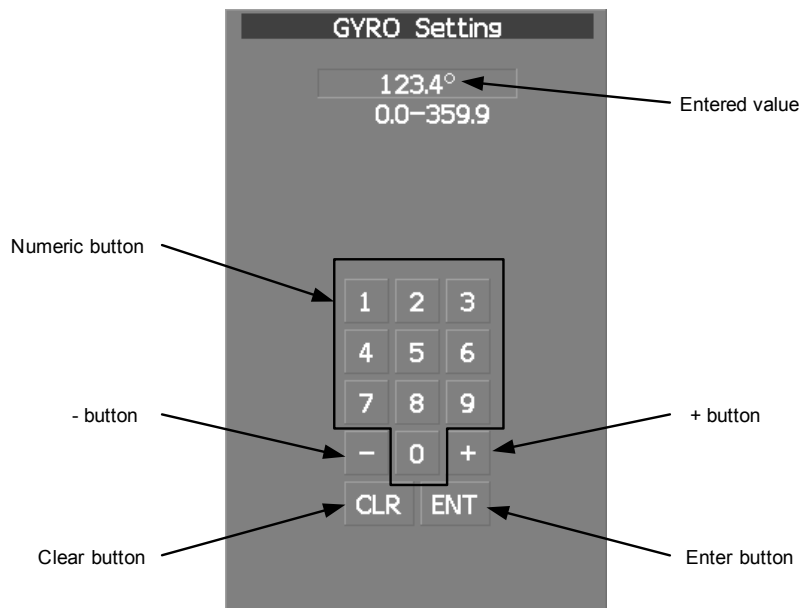

3.3.4.2 Directly entering a numeric value

Procedures

- 1) **On the numeric value input screen, sequentially left-click the software number keys located on the radar screen, and enter a desired numeric value.**

For example, when entering **1** → **2** → **3** → **4** for a bearing value, sequentially left-click the software number keys as shown below.

- 2) **Make sure that the entered value is correct, and left-click the **ENT** button.**

The set value is reflected to the operating state.

- 3) **To stop entering a value, right-click the **[ENT]** button. Alternatively, left-click the **CLR** button.**

The numeric value input screen will close without reflecting the set value to the operating state.

3.3.4.3 Increasing or decreasing a numeric value

Procedures

- 1) On the numeric value input screen, sequentially left-click the software button **+** or **-** located on the radar screen, and enter a desired numeric value.

For example, when adjusting 123.0° to 123.4° for a bearing value, sequentially left-click the software number keys as shown below.

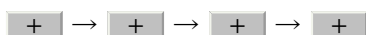

- 2) Make sure that the entered value is correct, and left-click the **ENT** button.

The set value is reflected to the operating state.

- 3) To stop entering a value, right-click the **ENT** button. Alternatively, left-click the **CLR** button.

The numeric value input screen will close without reflecting the set value to the operating state.

3.3.4.4 Latitude/longitude input screen

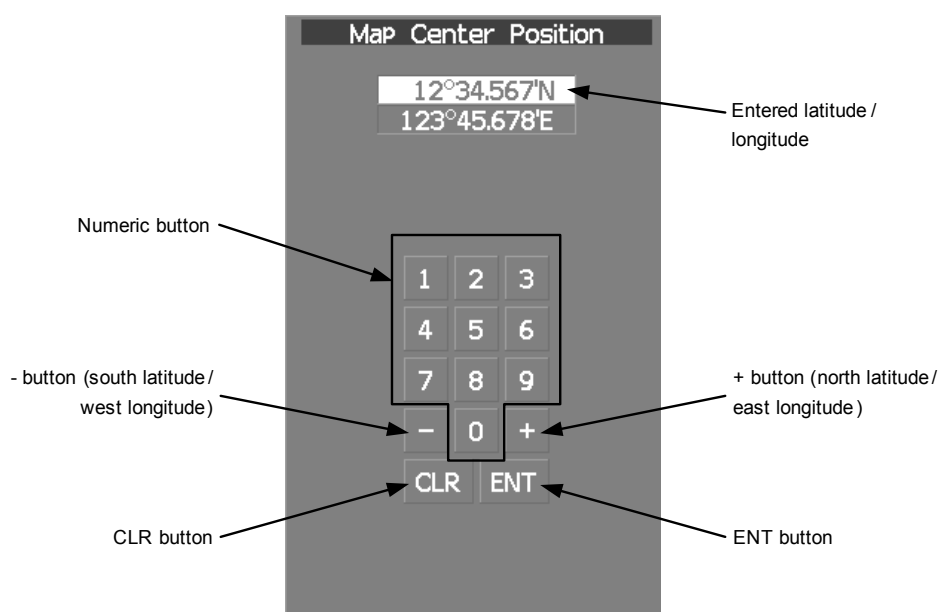

3.3.4.5 Entering latitude/longitude

Procedures

- 1) **On the latitude/longitude input screen, sequentially click numeric buttons to enter latitude (XX° XX. XXX').**

For example, to enter 12° 34.567', sequentially click numeric buttons as follows.

1 → **2** → **3** → **4** → **5** → **6** → **7**

- 2) **To make change between north latitude and south latitude, use **+** and **-**.**

North latitude: Left-click the **+** button.

South latitude: Left-click the **-** button.

- 3) **Left-click the **ENT** button.**

The manually entered latitude value is determined. Then, enter the longitude value.

- 4) **Sequentially click numeric buttons to enter longitude (XXX° XX. XXX').**

- 5) **To make change between east longitude and west longitude, use **+** and **-**.**

East longitude: Left-click the **+** button.

West longitude: Left-click the **-** button.

- 6) **Left-click the **ENT** button.**

The manually entered longitude value is determined.

- 7) **To cancel input, put the cursor on **CLR** and then left-click the **button**.**

The latitude/longitude input screen will close without reflecting the set value to the operating state.

3.3.4.6 Character input screen

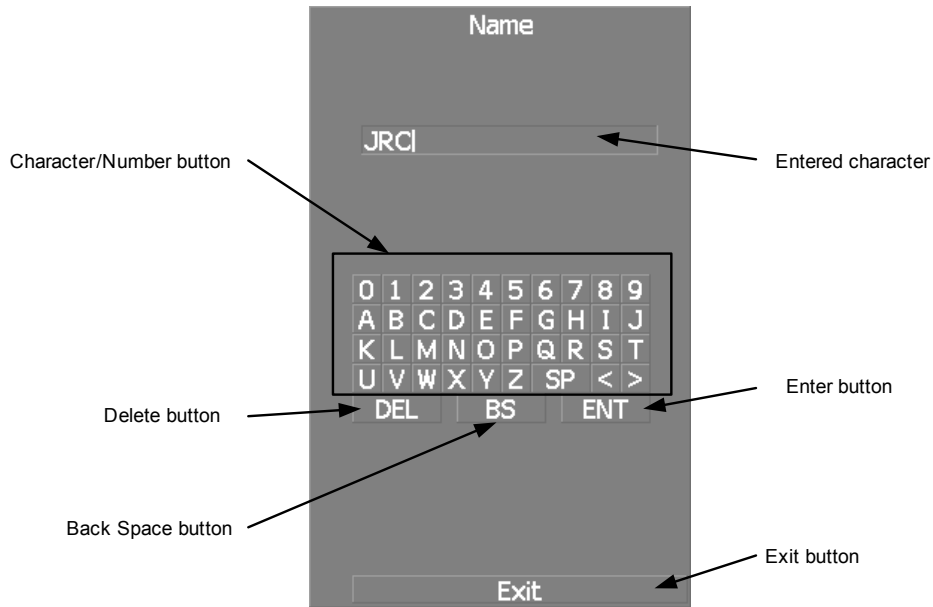

3

3.3.4.7 Entering a character

Procedures

- 1) On the character input screen, use trackball to select alphabet from A to Z, numbers from 0 to 9, or symbols (only comments for mark/line), and then left-click the ENT button to enter one character of the name to be inputted.

For example, JRC for a name, click button as follows:

J → R → C

- 2) Make sure that the entered character is correct, left-click the ENT button.

The character has been entered.

- 3) To cancel input, left-click the Exit button.

The character input screen will be closed without entering the character.

3.3.5 Overview of Menu Structure

The menu structure of this radar system consists of eight frequently used function menus, one main menu, and one service man menu used for the installation settings.

Software buttons for opening those menus are displayed in the menu area located at the bottom ten of the display.

For each menu item and structure, see the menu list in the appendix.

To prevent incorrect use, enter the special code to open the service man menu. For operating the service man menu, see Section 7.1.1 "How to Open the Serviceman Menu (Service Man Menu) "

Frequently used functions

TT	Used for operating and setting the target tracking function.
Track	Used for operating and setting the other ship trails function.
AIS	Used for operating and setting the AIS display function.
Route	Used for operating and setting the route function.
PI	Used for operating and setting the parallel-index-line function.
AZ	Used for operating and setting the automatic acquisition / activate function.
U.MAP	Used for operating and setting the user map function.

Main menu

Main	Used for operating and setting the functions.
------	---

Serviceman menu

This menu is used for operation and settings when a system is installed.

It is not used during normal operation. The special code must be entered to open the service man menu.

3.4 GENERAL RADAR OPERATION

3.4.1 Interference Rejection (IR)

Interference by other radars is rejected.

Attention

- When viewing a radar beacon or SART signal, select **IR Off** (Interference Rejector OFF) because IR processing suppresses the video.

Procedures

- 1) Left-click the **IR** button located at the lower left of the radar display.

The interference rejection modes are switched.

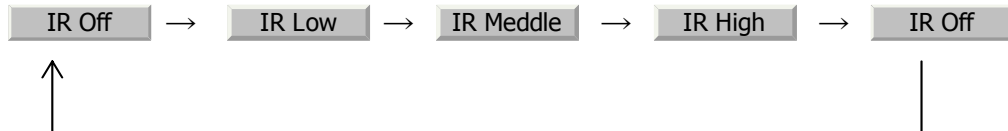

Rejection levels of the interference rejector

IR Off : Interference rejector off

IR Low : Interference rejection level - low

IR Middle : Interference rejection level - moderate

IR High : Interference rejection level - high

When a high interference rejection level is selected, the radar's ability of detecting small targets such as buoys and small boats lowers.

In general, **IR Low** should be selected.

3.4.2 Switch Transmitter Pulse Length [GAIN]

Procedures

1) Press [GAIN] dial

Values of the transmitter pulse width are switched.

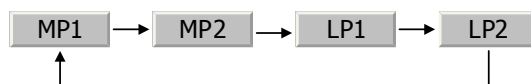

Effects of transmitter pulse width

With SP selected: The transmitter pulse becomes shorter, and the range resolution improves. The effect of suppressing sea clutter returns and rain/snow clutter returns heightens.

Recommended condition for selection: In bays/harbors where targets are densely crowded. Rough sea state due to torrential rain or stormy weather.

With MP selected: The normal transmitter pulse length is set. Both range resolution and gain are appropriately set.

Recommended condition for selection: General navigation

With LP selected: The transmitter pulse becomes longer, and gain improves. Small targets are zoomed and are easy to observe. When the sea state is bad, detection performance decreases.

Recommended condition for selection: Detection of small targets in good weather conditions.

Usable transmitter pulse width differs according to the type of antenna being used and the observation range being used. For usable pulse width, see Section 11.8 "SCANNER UNIT (NKE-1139)" ~ Section 11.14 "SCANNER UNIT (NKE-2103-6HS)".

3.4.3 Target Enhance (ENH)

The dimension of video display is enlarged to enhance a target.

Procedures

- 1) Left-click the ENH button located at the lower left of the radar display.

The target enlargement levels are switched.

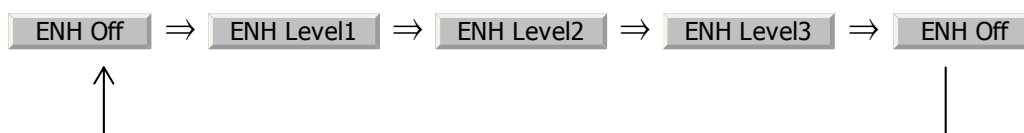

Effect of target enlargement

ENH Off	:Expansion off	Select this mode particularly when resolution is required.
ENH Level1	:Expansion small	Select this mode in general. Radar echoes are expanded by 1 scale in all directions.
ENH Level2	:Expansion medium	Select this mode to easily view the radar video. Radar echoes are expanded by 2 scales in all directions on the display.
ENH Level3	Expansion large	Select this mode to detect small targets such as buoys. The expansion near a screen center is added to ENH Level2.

NOTE: When ENH Level3 is selected, sea clutter returns and rain/snow clutter returns are apt to be expanded. When using this expansion mode, operate [SEA] dial and [RAIN] dial to suppress sea clutter returns and rain/snow clutter returns.

In general, ENH Level1 or ENH Level2 should be selected.

3.4.4 Use Video Processing (PROC)

This function reduces unnecessary noise to highlight targets.

Attention

- When viewing a radar beacon, SART signal, or fast moving target on the radar display, select **PROC Off** (video process off).
- If video processing mode is set to **CORREL**, it may be difficult to detect high speed target.

Procedures

- 1) Left-click the **PROC** button located at the lower left of the display.

The video processing modes are switched.

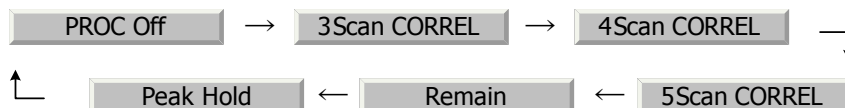

Video process modes

- PROC Off** : Select this mode in general.
- 3Scan CORREL** : Select this mode when many rain/snow clutter returns are detected.
- 4Scan CORREL** : Select this mode to highlight targets while suppressing sea clutter returns.
- 5Scan CORREL** : Select this mode to detect small targets hidden by sea clutter returns.
- Remain** : Select this mode when own ship yaws wildly.
- Peak Hold** : Select this mode to detect small targets of which detection probability is low.

3.4.5 Switch Azimuth Display Mode (AZI MODE)

Select the bearing for the radar video to be displayed on the radar display.

Procedures

- 1) Left-click the **AZI Mode** button located at the lower left of the display.

The bearing display modes are switched.

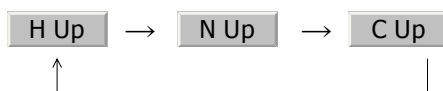

True Bearing Mode [North Up]

The video is displayed so that the zenith of the PPI (0° on range rings) points to the due north. Fixed targets do not flicker and are easily identified on the chart, and the true bearing of a target can easily be read out.

Relative Bearing Mode [Head Up]

The video is displayed so that the ship's heading line points to the zenith of the PPI (0° on range rings). Since targets are displayed in their directions relative to the ship's heading line, the operator can view the video in the same field of view as in operating the ship at sea. This mode is suitable for watching over other ships.

Course-up Bearing Mode [Course Up]

By setting the course-up mode, own ship's course is fixed so that it is located on the zenith of the radar display (0° on range rings). In the same way as in the North-up mode, fixed targets do not flicker, and are stabilized even if the ship is yawing. The bearing of the heading line varies by the same shift of own ship's course. To change the course, press the [AZI MODE] key several times again to select the course-up mode so as to set a new course.

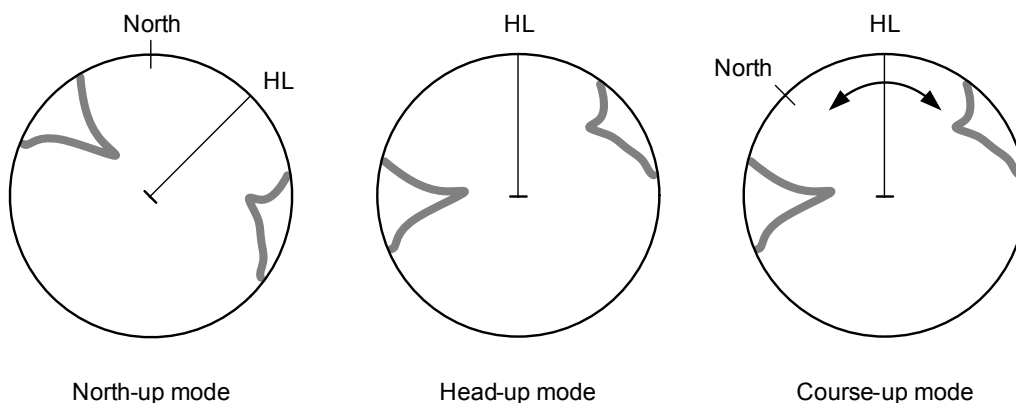

North-up mode

Head-up mode

Course-up mode

3.4.6 Switch True/Relative Motion Display Mode (TM/RM)

3.4.6.1 Switching Relative Motion (RM) Mode to True Motion (TM) Mode

Procedures

- 1) **Left-click the motion mode button located at the upper left of the radar display.**

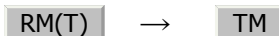

The true motion mode will be selected. In the true motion mode, the own ship's position on the radar display moves depending upon its speed and course and the influence of the current. Land and other fixed targets are fixed on the radar display and only actually moving targets move on the radar display. When the true motion mode is selected, the own ship's position is set to about 60% of the display radius in the opposite direction to its course allowing for the influence of the current. Own ship starts moving depending upon its speed and course and the influence of the current. Subsequently, when own ship arrives at the position of about 66% of the display radius, it is automatically reset to its initial position at about 60% of the display radius in the opposite direction to its course allowing for the influence of the current.

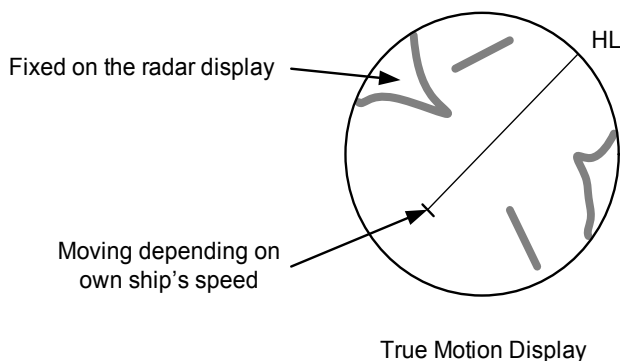

3.4.6.2 Resetting Own Ship to its Initial Position in True Motion (TM) Mode

Procedures

- 1) **Left-click the motion mode button for 2 seconds.**

Own ship will be reset to its initial position as established when the relative motion mode is changed to the true motion mode. The ship starts moving from that position.

3.4.6.3 Switching True Motion (TM) Mode to Relative Motion (RM) Mode

Procedures

- 1) **Left-click the motion mode button.**

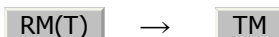

The relative motion mode will be selected. Own ship returns to the center of the radar display.

3.4.7 Move Own Ship's Display Position (Off Center)

The own ship's position can be moved from the display center to any position within 66% of the display radius. This function is convenient for observing a wide coverage in any direction.

If Off Center functions set to scanner position is outside of the PPI range, when function switching display with reference to scanner position.

 This function is not available on the 96 NM range.

Procedures

- 1) **Left-click the Off Center button located at the upper left of the display.**

The cross cursor mark will appear at the own ship's position on the radar display.

- 2) **Move the cross cursor mark (own ship's display position) to a desired position by using the trackball.**

While the cross cursor mark is moving, the own ship's display position moves following the cross cursor mark.

When it moves to a position outside 66% of the display radius, the center position is limited to a position within 66% of the display radius.

- 3) **Press the trackball button on the left key.**

The own ship's display position will be fixed to the cross cursor mark.

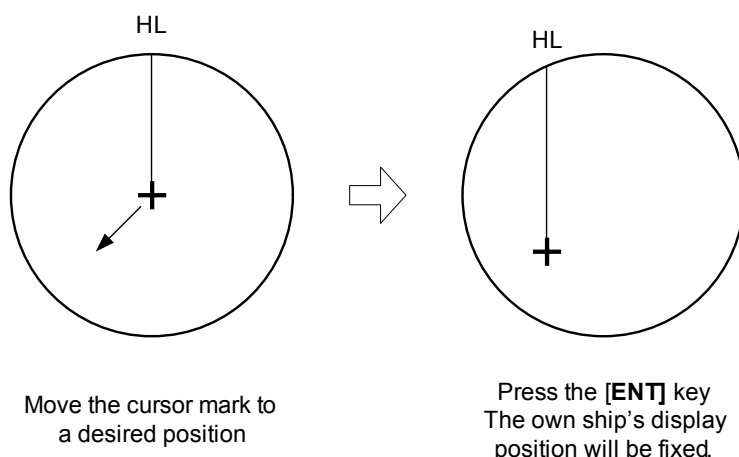

3.4.7.1 Returning Own Ship's Position to the Center

Procedures

- 1) **Left-click the Off Center button for 2 seconds.**

The own ship position is returned to the center of the display.

3.4.8 Display Radar Trails (Trails)

Other ship's movements and speeds can be monitored from the lengths and directions of their trails, serving for collision avoidance. The trail length varies according to setting.

3.4.8.1 Changing the length of the trail

Procedures

- 1) **Left-click the Trails button located at the upper left of the display.**

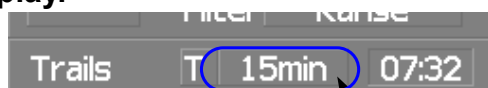

RADAR trails display time

Values of the length of the radar trails are switched.

Trails length setting: Short mode

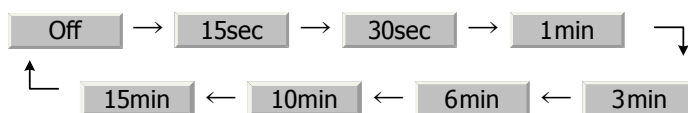

Short : 15秒、30秒、1分、3分、6分、10分、15分

Middle : 30秒、1分、3分、6分、10分、15分、30分

Long : 1分、3分、6分、10分、15分、30分、60分

Saved trails cannot be erased even when the trail lengths are changed by using Trails button. Even after the trails display is turned off, the past trails can be displayed traced back by setting a desired time.

The radar system is start transmission, trails is start plot.

The system is plotting trails even while the trails display is off.

If the transmit time is short, the indicated trails duration may not have achieved the specified time. The radar trails remaining time is indicated at the right of the trails length setting.

3.4.8.2 Erasing Trails Data

Procedures

- 1) **Hold down the Trails button for five seconds located at the upper right of the display.**

All the saved trails data will be erased. The system starts plotting trails in initial state. When Trails button is clicked for 2 seconds, a RADAR Trails Setting menu will be displayed. Furthermore, data will be erased if it continues pushing.

3.4.8.3 Trails Motion Mode

There are two types of trails: relative motion trails and true motion trails.

Relative motion The system plots the trails of a target at a position relative to trails: the own ship. The operator can easily judge whether the target is approaching the own ship. While the own ship is moving, the system also plots the trails of land and other fixed targets.

True motion The system plots the absolute motion trails of a target, trails: irrespective of the own ship's position. The operator can easily judge the course and speed of the target. The system does not plot the trails of land and other fixed targets.

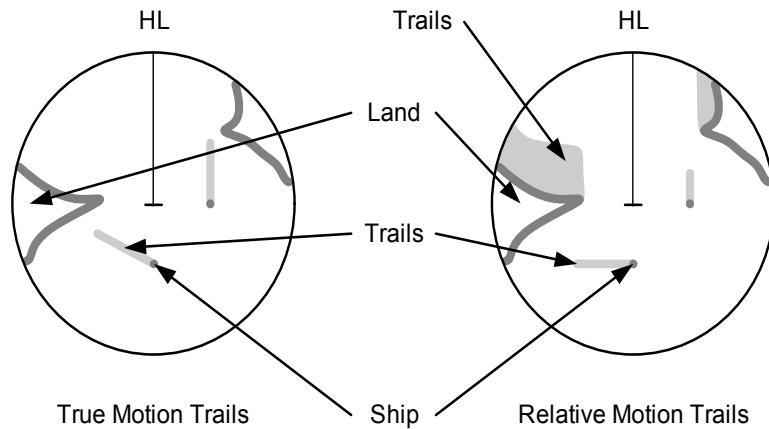

Trails modes provided with this system vary depending on the motion mode.

With true motion (TM) mode: Only the true motion trails mode is available.

With relative motion (RM) mode: The relative motion trails mode or true motion trails mode is selectable.

RM(R) is indicated while the relative motion trails mode is active.

RM(T) is indicated while the true motion trails mode is active.

While the true motion trails mode is active, this system enables the continuous use of true motion trails even if any of the following operations is performed:

- Motion display mode change (TM/RM)
- TM reset
- Bearing display mode change
- Center move (Off Center)
- MAP display on/off (Map)



Accurate true bearing signals and speed signals are necessary for using the true motion trails mode.

3.4.8.4 Changing Motion Mode of Trails (Trails Mode)

Procedures

- 1) Click the **Trails Mode** located at the upper right of the radar display.



RADAR trails true/relative

The trails motion modes are switched.

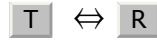

3.4.9 Zoom (x2)

This function doubles the size of radar video near a specified position.

NOTE: If the range is 0.125 NM , this function is not available.

Procedures

- 1) **Left-click the x2 button located at the lower left of the display.**

The zoom mode is selected.

- 2) **Subsequently, put the cross cursor mark on a location you want to zoom into, and press the left key of the trackball.**

The zoom is set.

Using the cross cursor mark as reference, the zoom function doubles the size of a radar video with the midpoint between the cursor mark and own ship's position being set to the center of radar display.

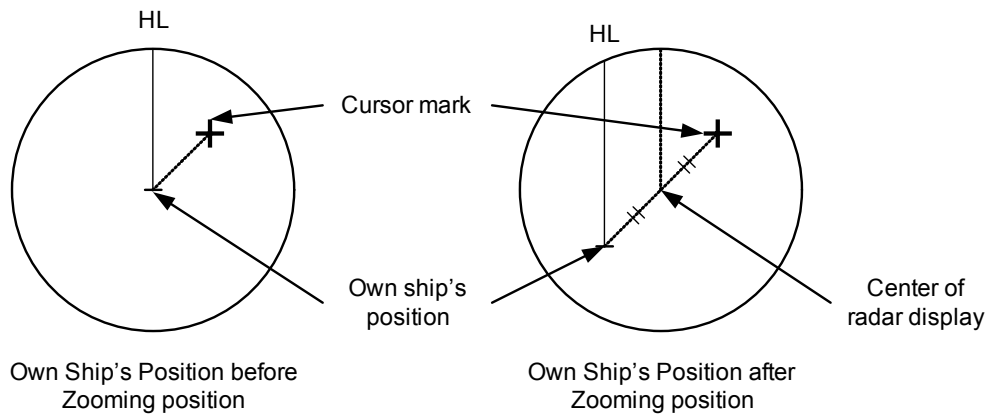

Cancel

- 1) **Left-click the  button located at the lower left of the display.**

The zoom mode is cancelled.

3.4.10 Hide/Display Range Rings [HL OFF]

Procedures

- 1) **Press the [HL OFF] key. Alternatively, Left-click the button located at the lower right of the display.**



The ship's heading line (HL) is hidden while the [HL OFF] key is held down.

The ship's heading line that indicates the course of own ship is always shown on the radar display. The heading line is hidden while the [HL OFF] key is held down, so the targets on the heading line can be easily observed.

3.4.11 Hide Graphics Information on Radar Display [DATA OFF]

Various graphics information such as target tracking TT/AIS symbols, NAV lines, and MAP information is shown on the radar display of this radar system, and may make it difficult to view the radar video. In that case, use this function to temporarily hide unnecessary graphics information.

Procedures

- 1) **Press the [DATA OFF] key. Alternatively, Left-click the button located at the lower right of the display.**



While the key is pressed, graphics data other than VRM, EBL, HL, cross cursor mark, and range rings on the radar display is temporarily hidden.

3.4.12 Switch Day/Night Mode [DAY/NIGHT]

Several combinations of the display color and brilliance according to the ambient lighting conditions are provided. The display color setting is easily changed.

Procedures

- 1) Press the [DAY/NIGHT] key. Alternatively, left-click the Day/Night button located at the lower right of the radar display.

The DAY/NIGHT modes are switched.

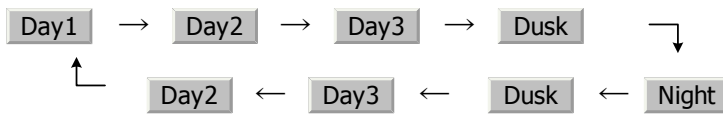

The current mode is displayed at the lower right of the radar display.

For how to set the display color and brilliance for each mode, see Section 3.8.5 "Set Radar Display (Display Setting)"

3.4.13 Adjust Operation Panel Brilliance [PANEL]

Adjust brilliance of the operation panel according to the ambient lighting conditions.

Procedures

- 1) Press the [PANEL] key. Alternatively, left-click the  button located at the lower right of the radar display.

In consideration of the ambient brightness, adjust panel brilliance that is high enough to read the characters on the operation panel but does not glare.

The [PANEL] key lamp lights up irrespective of panel brilliance adjustment.

3.4.14 Set True Bearing

When the GYRO I/F is used to enter a gyro signal, there is a rare case in which a true bearing value indicated by the master gyro does not match the true bearing value indicated by this radar system.

In that case, adjust the true bearing value of this system so that it matches the value indicated by the master gyro.

Procedures

- 1) **Open the numeric value input screen to enter a true bearing value by performing the menu operation below.**

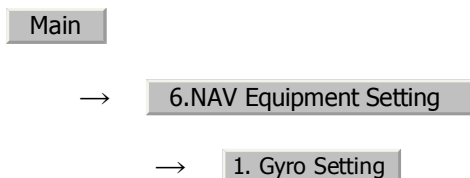

- 2) **Enter a value indicated by the master gyro on the numeric value input screen.**

For how to input numeric data on the numeric value input screen, see Section 3.3.4 "Operation on Numeric Value, Latitude / Longitude and Character Input menu".

3.4.15 Set Own Ship Speed

3.4.15.1 Switch the own ship speed device

Procedures

- 1) **Left-click the own ship speed device button in the Own Ship Information area located at the upper right of the display.**

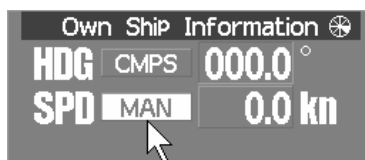

The speed sensor is switched whenever the button is clicked.

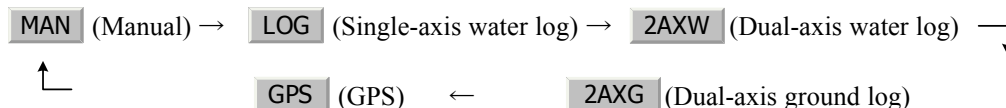

NOTE:

- If the single axis water log display can present the speed of the ship in other than the forward direction, the direction of movement should be indicated unambiguously. Therefore single axis water logs cannot detect the effect of leeway.
- If ships in shallow water, when the accuracy of the dual-axis log may be decreased. If ships in deep sea area, when the accuracy of the dual-axis log error may be occurred.
- The accuracy of GPS's COG is $\pm 3^\circ$ when own ships speed no fewer than 1kn, no more than 17kn. The accuracy of GPS's COG is $\pm 1^\circ$ when own ships speed over 17kn.

3.4.15.2 Input the own ship speed (Manual Speed)

If the ship-speed system, such as LOG, etc., connected to this radar system malfunctions, it is possible to manually enter own ship speed by the method described below to use the target tracking (TT) and true motion display functions.

Procedures

- 1) **Left-click the own ship speed device button in the Own Ship Information area located at the upper right of the display, and select the manual mode MAN.**

- 2) **Left-click the value of the speed.**

The numeric value input screen will open to enter the own ship speed.

- 3) **Enter the value for the own ship speed on the numeric value input screen.**

For how to input numeric data on the numeric value input screen, see Section 3.3.4 "Operation on Numeric Value, Latitude / Longitude and Character Input menu".

3.4.16 Magnet Compass Correction (MAG Compass Setting)

Set the correction value, when the radar receive HDM sentence from magnet compass or the variation of HDG is NULL.

Procedures

- 1) **Open the MAG Compass Setting menu by performing the following menu operation.**

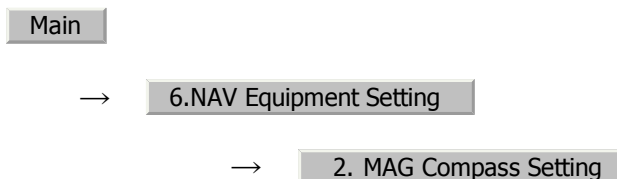

2) **Set whether to make corrections or not.**

1. Heading Correction

Off ⇔ On

3) **Input the correction value.**

Press the **+** or **-** button to select south and north for latitude or the east and west for longitude.

For how to input numeric data on the numeric value input screen, see Section 3.3.4 "Operation on Numeric Value, Latitude / Longitude and Character Input menu".

3.4.16.1 Set Drift Correction

The direction and speed of the drift are set.

This function can be used only when **MAN** or **LOG** is selected for ship-speed data.

Procedures

1) **Open the Set/Drift Setting menu by performing the menu operation below.**

Main

→

6.NAV Equipment Setting

→

3. Set/Drift Setting

2) **Set whether to make corrections or not.**

1. Correction

Off ⇔ On

For menu operation, see Section 3.3.3 "Basic Menu Operation".

3) **Enter the correction value for tidal current.**

2.Set : Direction of tidal current (true bearing)

3.Drift : Speed of tidal current

For how to input numeric data on the numeric value input screen, see Section 3.3.4 "Operation on Numeric Value, Latitude / Longitude and Character Input menu".

3.5 USE OWN SHIP'S TRACK

The own ship's track function saves and displays own ship's track.

If navigation equipment is connected, this radar system records latitude/longitude data sent from the navigation equipment and displays own ship's track.

NOTE: Even when own ship's track storage interval is turned **Off**, own ship's track can be displayed. However, in this case, if rewrite operation such as changing of the display range is performed for the radar display, own ship's track display is erased and the track will not be plotted again.

If the own ship track display is turned off when own ship track is in storage, own ship's tracks are not shown on the radar display, but own ship's track is still saved.



3.5.1 Display Own Ship's Track (Display Own Track)

Procedures

- 1) Left-click the Own Track Color **Track** button located at the lower right of the display.

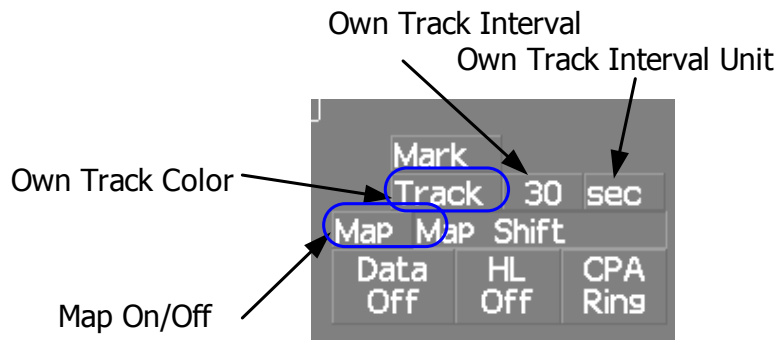

The color of the own ship's track are switched.

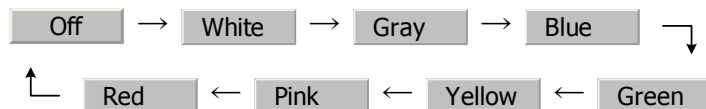

- 2) Left-click the **Map** button located at the lower right of the display.

The map display function is turned on **Map** or off **Map**.

When Color is selected, the own ship's track is displayed.

3.5.2 Set Display Color of Own Ship's Track (Display Own Track Color)

Own ship's track can be saved in seven different colors.

Own ship's track can be displayed or not displayed individually by color.

Procedures

- 1) **Open the Display Own Track Setting menu by performing the menu operation**

Track

→

1. DISP Own Track Color

The Display Own Track Setting menu will open.

Operations differ according to the following set modes.

When is set to All of own ship's tracks are displayed.

When is set to All of own ship's tracks are not displayed.

When is set to Settings are made by color by performing the operation below.

- 2) **Left-click the color button for the desired display setting which is to be changed.**

Display of each item is switched between and

On : Own ship's track plotted by the color is displayed.

Off : Own ship's track plotted by the color is not displayed.

3.5.3 Save Own Ship's Track (Own Track Memory)

To save own ship's track, storage at a specified time interval and at a specified range interval can be selected.

The track storage interval can be selected from 10 preset time intervals and 8 preset range intervals.

Storage intervals that can be selected

Time : 3 sec, 5 sec, 10 sec, 30 sec, 1 min, 3 min, 5 min, 10 min, 30 min, and 60 min

Range : 0.1 NM, 0.2 NM, 0.3 NM, 0.5 NM, 1 NM, 3 NM, 5 NM, and 10 NM

3

Procedures

- 1) **Left-click the Own Track Interval unit button located at the lower right of the display.**

Every time the button is clicked, the units of measure for the storage are switched.

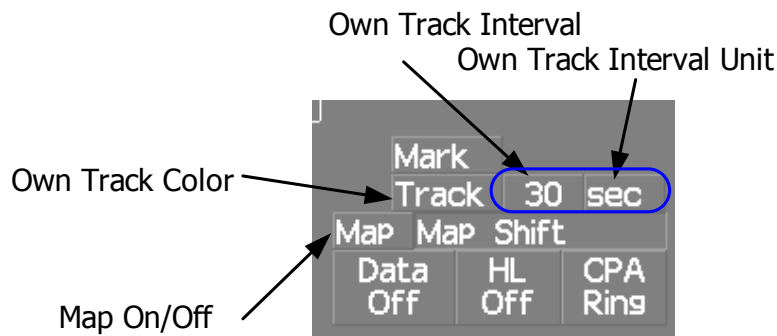

- 2) **Left-click the Own Track Interval button located at the lower right of the display.**

Every time the button is clicked, storage intervals are switched.

When Off is selected, the storage function is turned off.

3.5.4 Cancel Saving of Own Ship's Track (Own Track Memory)

Storage of own ship's track can be turned off.

Cancel

- 1) **Left-click the Own Track Interval button located at the lower right of the display.**

Every time the button is clicked, interval for track storage are switched.

When Off is selected, the storage function is turned off.

3.5.5 Clear Own Ship's Track (Clear Own Track)

This function cancels the storing of own ship's track.

Procedures

- 1) **Open the Clear Own Track Color menu by performing the menu operation below.**

Track

→

2. Clear Own Track Color

The Clear Own Track Color menu will appear.

- 2) **Left-click the button for the color to be deleted.**

All : All tracks are deleted

White / Gray / Blue / Red / Pink / Yellow / Green :

Only track of specified color is deleted.

After the item has been selected, Clear Own Track Confirmation Window will appear.

- 3) **Left-click the Yes button.**

Own ship's track indicated by the specified color will be deleted.

3.5.6 Use Expanded Own Ship's Track (Own Track Type)

The following expanded track functions can be used for this radar system.

Water temperature track : The water temperature value at the latitude/longitude is recorded.

Water depth track : The water depth value at the latitude/longitude is recorded.

Tidal current track : The tidal current vector at the latitude/longitude is recorded.

Only one type of expanded own ship's track can be used at a time. Multiple types of expanded tracks cannot be used at the same time.

Specify the type of the expanded own ship's tracks to be used by performing the operation below.

Procedures

- 1) **Left-click the button located at the lower right of the display.**

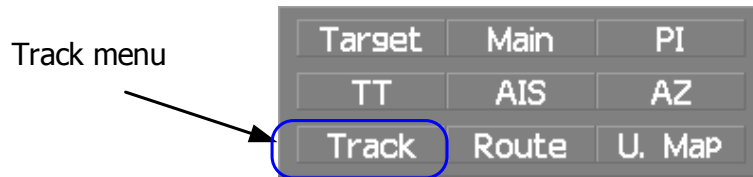

The Own Track Menu will appear.

- 2) **Left-click the item button of .**

The numeric value of the navigation data can be shown by the color of own ship's track.

- : The expanded own ship's track function is not used.
- : The color of the tracks is changed according to the water depth value
- :The color of the tracks is changed according to the water temperature value.

- 3) **Select the function to be used.**

- 4) **Left-click the item button of .**

Numeric value or vector of navigation data can be added to own ship's track.

- : Numeric value and vector are not added.
- : Water depth value is added.
- : Water temperature value is added.
- :current vector is added.

- 5) **Select the function to be used.**

NOTE: To use the expanded own ship's track function, the track must be entered from the special navigation equipment into this radar system.

3.5.7 Use Water Depth Track (Water Depth Track)

Set the corresponding conditions for the water depth value and the color of own ship's track by performing the operation below.

Procedures

- 1) Open the Water Depth Setting menu by performing the menu operation below.

Track

→

6. Water Depth Setting

The Water Depth Setting menu will appear.

Enter a value of the boundary water depth for each item according to the table below to set up the corresponding conditions for the water depth value and the color of own ship's track.

	Water depth value	Color of track
		White
1.	xxxx m Min	
		Gray
2.	xxxx m	
		Blue
3.	xxxx m	
		Green
4.	xxxx m	
		Yellow
5.	xxxx m	
		Pink
6.	xxxx m Max	
		Red

For example, if 10m is entered for 1. , 30m is entered for 2. , and 50m is entered for 3. , the area with a water depth of less than 10 meters is indicated by white tracks, the area with a water depth of 10 to 30 meters is indicated by light blue tracks, and the area with a water depth of 30 to 50 meters is indicated by blue tracks.

3.5.8 Use Water Temperature Track (Water TEMP Track)

Set the corresponding conditions for the water temperature value and the color of own ship's track by performing the operation below.

Procedures

- 1) Open the Water TEMP. Setting menu by performing the menu operation below

Track

→

7. Water TEMP. Setting

The Water TEMP. Setting menu will appear.

Enter a value of the boundary water temperature for each item according to the table below to set up the corresponding conditions for the water temperature value and the color of own ship's track.

Water temperature value	Color of track
1. xx.x °C Min	White
2. xx.x °C	Gray
3. xx.x °C	Blue
4. xx.x °C	Green
5. xx.x °C	Yellow
6. xx.x °C Max	Pink
	Red

For example, if 10.0 ~ is entered for 1. , 13.0 ~ is entered for 2. , and 15.0 ~ is entered for 3. , the area with a water temperature of less than 10.0 °C is indicated by white tracks, the area with a water depth of 10.0 ~ to 13.0 ~ is indicated by light blue tracks, and the area with a water depth of 13.0 ~ to 15.0 ~ is indicated by blue tracks.

3.5.9 Use Tidal Current Track (Current Vector Track)

Set the conditions for adding tidal current vectors to own ship's track by performing the operation below.

Procedures

- 1) **Open the Current Setting menu by performing the menu operation below.**

Track

→

8. Current Setting

The Current Setting menu will appear.

Set the tidal current vector display conditions.

[1]Length of the tidal current vector (Current Size)

- Set the length of the tidal current vector.
- The unit of measure is kn/cm.
- If 1.0kn/cm is set, a tidal current of 1.0kn is shown as a one-centimeter line on the radar display.

[2]Color of the vector for tidal current layer A (Layer A)

- Set the vector's display color for tidal current layer A.
- Choose one of the following colors
White、 Gray、 Blue、 Green、 Yellow、 Pink、 Red

[3]Color of the vector for tidal current layer B (Layer B)

- Set the vector's display color for tidal current layer B.
- Choose one of the following colors
White、 Gray、 Blue、 Green、 Yellow、 Pink、 Red

[4]Color of the vector for tidal current layer C (Layer C)

- Set the vector's display color for tidal current layer C.
- Choose one of the following colors
White、 Gray、 Blue、 Green、 Yellow、 Pink、 Red

3.6 DISPLAY USER MAP

Up to 20,000 items of NAV lines, coastlines, depth contours, and NAV marks can be created, displayed, loaded, and saved. (This function is available only when navigation equipment is connected to this radar system.)

Marks that can be used : 29 types

Lines that can be used : 3 types (solid, broken, and dashed-dotted line)

Color of mark and lines : 7 colors
that can be used

3

 If radar video is poor visibility caused by user map function, press the [DATA OFF] key to map displays temporarily off.

3.6.1 Create User Map (Mark/Line)

In this system, when the radar is in the transmission state, the user map is displayed all the time. However, valid latitude/longitude data and true bearing data must be entered into the system.

The user map can be created and edited by performing the following operation.

3.6.1.1 Plotting a mark

Procedures

- 1) Left-click the button located at the upper right of the display to set the Mark mode.

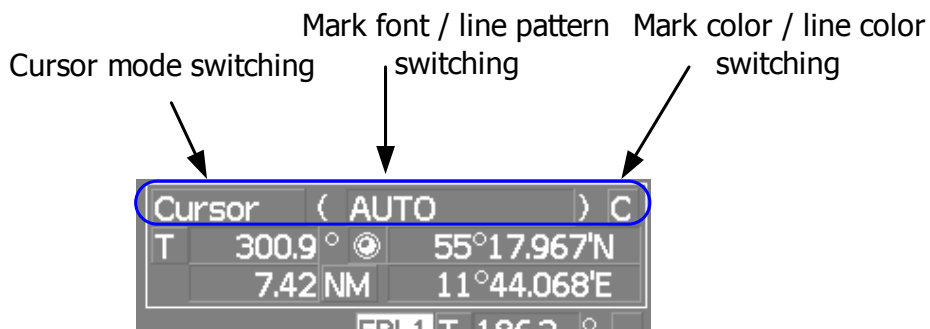

The mark font to be used is displayed to the right of the button.

- 2) **Left-click the mark font  button to select a font for the mark.**

The mark fonts are switched.

- 3) **Left-click the  button located to the right of the mark font to select a color for the mark.**

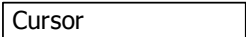
The color for the mark font located to the right of the  button will change.

- 4) **Left-click at a desired location on the radar display.**

The specified mark will be displayed in the specified color.

To create another mark, repeat the above procedures.

3.6.1.2 Plotting a line

Procedures

- 1) **Left-click the  button located at the upper right of the display to select the line mode.**

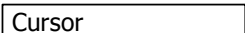
The line pattern to be used is displayed to the right of the  button.

- 2) **Left-click the  button located at the upper right of the display to select the line pattern.**

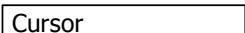
The line pattern to be used is displayed to the right of the  button.

- 3) **Left-click the  button located to the right of the line pattern to select a color for the line.**

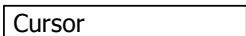
The color for the line pattern located to the right of the  button will change.

- 4) **Left-click at a desired location on the radar display.**

Line colors are switched.

- 5) **Move the cursor to a desired location on the radar display and left-click.**

A line is plotted between the previous point and the end point. Repeat this procedure so that sequential lines can be plotted.

- 6) **When you want to finish plotting the line, left-click at the previous point.**

Line plotting will be terminated. To plot another line, repeat procedures 3.

3

3.6.1.3 Plotting a mark / line make with latitude and longitude

Procedures

- 1) **Open the Edit User Map menu by performing the following menu operation.**

U.Map

→

2. Edit User Map

→

2. Make with L/L

- 2) **Left-click the 9. New Mark Input button.**

The Mark Input menu and the Line Input menu are switched.

- 3) **Left-click the item button of 1. Type to select the type of mark font or line pattern to be created.**

The desired mark font or line pattern is selected.

To add a line, select midpoint --O-- .

- 4) **Left-click the item button of 2. Color to select the color of mark or line to be created.**

The desired mark or line color is selected.

- 5) **Left-click the  button to input the latitude / longitude.**

For the input method on the latitude / longitude input screen, see Section 3.3.4.5 "Entering latitude/longitude"

- 6) **Left-click the  button to input the comment.**

For the input method on the character input screen, see Section 3.3.4.7 "Entering a character"

The window will not be open when the system is in the transmission state.

- 7) **Left-click the  button.**

Mark / Line plotting will be terminated.

To create another mark or line, repeat procedures 4 to 7.

3.6.2 Set User Map Display (Mark Display Setting)

The user map can be individually displayed (On) or hidden (Off).

Setting by type : Setting can be made by mark font and line pattern.

Setting by color : Setting can be made by color of mark or line.

The mark font display size can be selected.

Normal: The mark is displayed in normal size.

Small: The mark is displayed in a size smaller than usual.

3.6.2.1 Setting display by type

Procedures

- 1) **Open the Display Mark Type menu by performing the menu operation below.**



→



→



The Display Mark Type menu will open.

2) **Specify whether to turn on or off the display for each type of mark and line.**

When 1. All is selected, the setting will reflect to all types of marks and lines.

Off : All types are not displayed.

Individual : All types are displayed.

On : Setting by type is activated.

3.6.2.2 Setting display by color

Procedures

- 1) **Open the Display Mark Color Type menu by performing the menu operation below.**

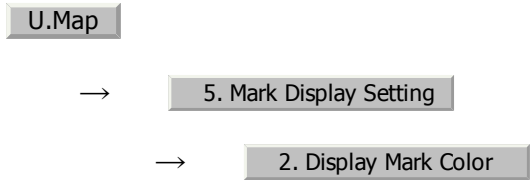

The Display Mark Color Type menu will open.

2) **Specify whether to turn on or off the display for each color type of mark and line.**

When 1. All is selected, the setting will reflect to all color types of marks and lines.

Off : All color types are not displayed.

Individual : Setting by color type is activated.

On : All color types are displayed.

3.6.2.3 Setting the mark font size

Procedures

- 1) **Open the Mark Size menu by performing the menu operation below.**

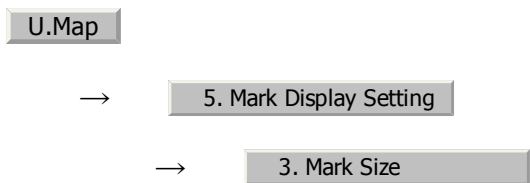

The Mark Size menu will appear.

2) **Specify the mark font size.**

Normal : The mark is displayed in normal size.

Small : The mark is displayed in a size smaller than usual.

3.6.2.4 Setting the character size for comments

Procedures

- 1) **Open the Comment Font Size menu by performing the menu operation below.**

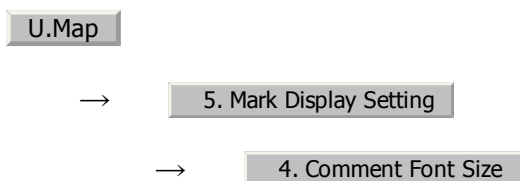

The Comment Font Size menu will appear.

2) **Specify the comment font size.**

Normal : The characters for comments are displayed in normal size.

Small : The characters for comments are displayed in a size smaller than usual.

3.6.3 Edit User Map (Edit User Map)

3.6.3.1 Manually entering the own ship position (Own Ship Position)

Use this function when editing navigation data for a location different from the own ship position.

Procedures

- 1) **Open the Own Ship Position menu by performing the menu operation below.**



The number key screen for entering the latitude/longitude of the Own Ship Position will appear.

- 2) Use the number buttons **0** to **9** to enter a value of latitude (xx°xxx.xxx').
- 3) To make changes between north latitude and south latitude, use the **+** and **-** buttons.

North latitude : Left-click the **+** button.

South latitude : Left-click the **-** button.

- 4) Left-click the **ENT** button.

The manually entered latitude will be determined. Then, enter the value of longitude.

- 5) Use the number buttons **0** to **9** to enter a value of longitude (xx°xxx.xxx').
- 6) To make changes between east longitude and west longitude, use the **+** and **-** buttons.

East longitude: Left-click the **+** button.

West longitude: Left-click the **-** button.

- 7) Left-click the **ENT** button.

The manually entered longitude will be determined.

NOTE: The own ship's position manually entered by using the function above is valid only in the navigation data setting menu. After exiting from the menu, the manually entered position data is invalidated.

3.6.3.2 Moving a mark or line (Move)

With regard to the created user map, a mark or line is moved individually.

Procedures

- 1) Open the Edit User Map menu by performing the following menu operation.

U.Map

→

2. Edit User Map

The Edit User Map menu will appear.

- 2) Left-click the **3. Move** button.

The user map move mode is selected.

Move Map is displayed in the cursor mode located at the upper right of the display.

3) **Put the cursor on a mark or line, and left-click.**

When a mark or line to be moved is selected, the  cursor mark will appear.

4) **Move the  cursor mark to the destination, and left-click.**

The selected mark or line is moved to the destination.

To move another mark or line, repeat procedures 3 and 4.

5) **When finished with the correction of all items, left-click the 0.Exit button.**

The cursor mode changes to the normal operation mode, terminating the user map move mode.

(Example)

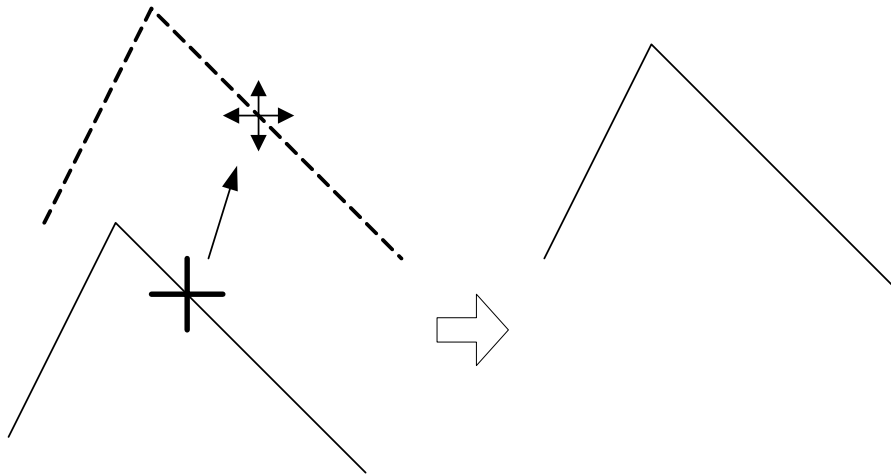

3.6.3.3 Deleting a mark or line (Delete)

With regard to the created user map, a mark or line is deleted individually.

Procedures

- 1) **Open the Edit User Map menu by performing the following menu operation.**

U.Map

→

2. Edit User Map

The Edit User Map menu will appear.

- 2) **Left-click the 4. Delete button.**

The user map delete mode is selected.

Delete

is displayed in the cursor mode located at the upper right of the display.

- 3) **Put the cursor on a mark or line, and left-click.**

The entire selected mark or line is deleted.

To delete another mark or line, repeat procedures 3 and 4.

- 4) **When finished with the correction of all items, left-click the 0.Exit button.**

The cursor mode changes to the normal operation mode, terminating the user map delete mode.

3.6.3.4 Inserting a vertex into a line (Insert/Move Vertex)

With regard to the created user map, a vertex is inserted into a line.

Procedures

- 1) **Open the Edit User Map menu by performing the following menu operation.**

U.Map

→

2. Edit User Map

The Edit User Map menu will appear.

- 2) Left-click the 5. Insert/Move Vertex button.

The user map insert/correction mode is selected.

Insert/Move is displayed in the cursor mode located the upper right of the display.

- 3) **Put the cursor to a side line into which a vertex will be inserted, and left-click.**

A vertex is inserted into the selected line, and the  cursor mark will be displayed.

- 4) **Move the  cursor mark to the newly inserted vertex, and left-click.**

To insert another vertex, repeat procedures 3 and 4.

- 5) **When finished with the correction of all items, left-click the 0.Exit button.**

The cursor mode changes to the normal operation mode, terminating the user map insertion/correction mode.

(Example)

The side line into which
a vertex is inserted

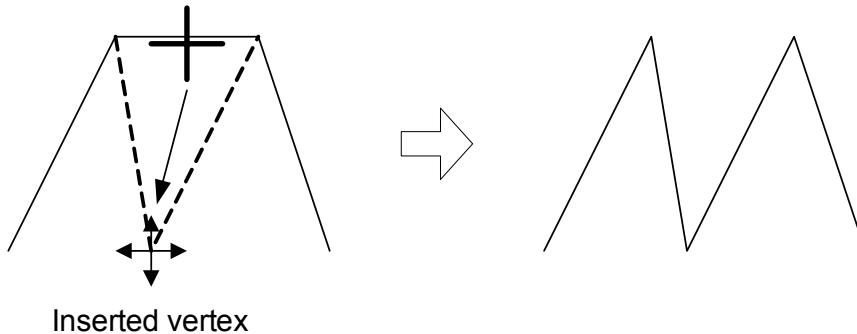

3

3.6.3.5 Correcting the mark or vertex of a line (Insert/Move Vertex)

With regard to the created user map, a mark or line is corrected.

Procedures

- 1) **Open the Edit User Map menu by performing the following menu operation.**

U.Map

→

2. Edit User Map

The Edit User Map menu will appear.

- 2) **Left-click the 5. Insert/Move Vertex button.**

The user map insertion/correction mode is selected.

Insert/Move is displayed in the cursor mode located at the upper right of the display.

- 3) **Put the cursor on the mark or vertex of a line, and left-click.**

When the mark or vertex of a line to be corrected is selected, the  cursor mark will appear.

- 4) **Move the  cursor mark to the destination, and left-click.**

The selected mark or vertex of the line is moved to the destination.

To correct another mark or vertex of a line, repeat procedures 3 and 4.

- 5) **When finished with the correction of all items, left-click the 0.Exit button.**

The cursor mode changes to the normal operation mode, terminating the user map insertion/correction mode.

(Example)

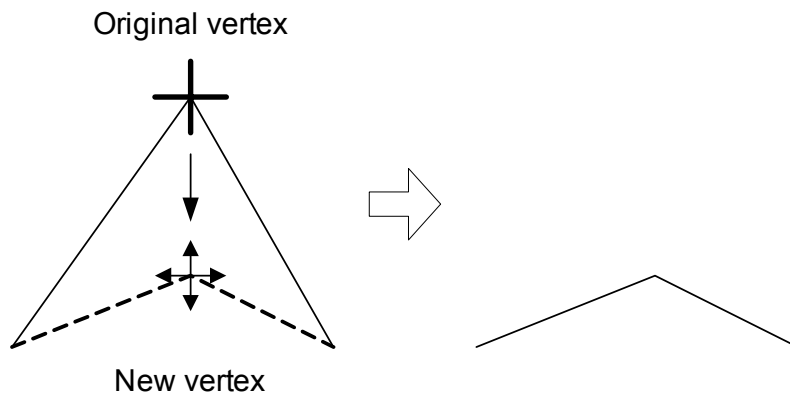

3.6.3.6 Deleting a mark or vertex from a line (Delete Vertex)

With regard to the created user map, a vertex is deleted individually from a mark or line.

Procedures

- 1) **Open the Edit User Map menu by performing the following menu operation.**

U.Map

→

2. Edit User Map

The Edit User Map menu will appear.

- 2) **Left-click the 6. Delete Vertex button.**

The user map delete mode is selected.

Delete

is displayed in the cursor mode located at the upper right of the radar display.

- 3) **Put the cursor on the vertex of a mark or line, and left-click.**

The selected mark or vertex of the line is deleted.

All of the lines drawn by joining two points are deleted.

To delete another mark or vertex of a line, repeat procedure 3.

- 4) **When finished with the correction of all items, left-click the 0.Exit button.**

The cursor mode changes to the normal operation mode, terminating the user map delete mode.

(Example)

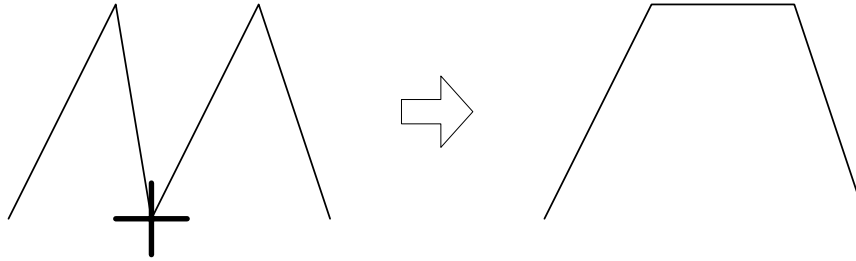

The vertex to be deleted

3

3.6.3.7 Batch clearing marks or lines (Clear)

With regard to the created user map, marks or lines are batch cleared by type or by color.

Procedures

- 1) Open the Edit User Map menu by performing the following menu operation.

U.Map

→

2. Edit User Map

The Edit User Map menu will appear.

- 2)-1 Left-click the item button of 7. Delete by Type

Select the type of marks or lines to be deleted.

To select all types, select All .

For example, to delete "red ○" marks, select ○ .

- 2)-2 Left-click the item button of 7. Delete

Select the color of marks or lines to be deleted.

To select all colors, select All .

For example, to clear "red ○" marks, select Red .

After the items have been selected, Confirmation Window will appear.

- 3) **Left-click the 1. Yes button.**

The selected mark will be deleted.

NOTE: If data is not copied on the flash memory card (option), the data is not be reloaded.

3.6.4 Correct Position on User Map (Shift User Map)

3.6.4.1 Correcting the display position on the user map (Shift)

If the display position on the user map is different from an actual position, it can be changed to the correct position in manual mode.

Procedures

- 1) **Open the [Shift] menu by performing the menu operation below.**

U.Map

→

3. Shift

Shift is displayed for the Cursor mode, indicating that the user map shift mode is selected.

- 2) **Put the pointer on a mark or end of a line, coastline, or depth contour line, and left-click.**
- 3) **Move the cross cursor mark to the location to be corrected, and left-click.**

Positions of all marks and lines currently displayed will be corrected.

At this time, Map Shift is displayed in the map position correction (lower right of the display), indicating that the position is being corrected.

Map Shift : Heading correction is conducted

Map Shift : Heading correction is not conducted

3.6.4.2 Restoring the corrected user map to its original state (Shift Clear)

Procedures

- 1) Open the Mark Operations menu by performing the following menu operation.

U.Map

→

4. Shift Clear

Only the most recently corrected data (for a single input) will be cleared, and the data will be displayed at its original position.

At this time, Map Shift is not displayed in the map position correction (lower right of the display).

Map Shift : Heading correction is conducted

Map Shift : Heading correction is not conducted

3.6.5 Save User Map

3.6.5.1 Loading navigation data (Load User Map)

Procedures

- 1) Insert a flash memory card into the card slot.

Flash memory card (option) is necessary.

- 2) Open the File Operations menu by performing the following menu operation.

U.Map

→

7. File Operation

- 3) Left-click the item button of and select the card slot.

Slot1 and Slot2 of the Select Card Slot items are switched.

- 4) Left-click the item button of and select / .

and of the Load Mode items are switched.

When [Add] is selected, new data is added to the saved data. When [Overwrite] is selected, the saved data is overwritten.

- 5) **Left-click the**  **button.**

The list of navigation data saved in the system will be displayed.

- 6) **Left-click the button for the file to be loaded.**

Confirmation Window will appear.

- 7) **Left-click the**  **button.**

The selected navigation data will be loaded and displayed on the radar display.

3.6.5.2 Discarding navigation data (Unload User Map)

Procedures

- 1) **Open the File Operations menu by performing the following menu operation.**



→



- 2) **Left-click the**  **button.**

Unload Confirmation Window will appear.

- 3) **Left-click the**  **button.**

The saved navigation data will be discarded.

3.6.5.3 Storing navigation data (Save User Map)

Navigation data can be saved when navigation equipment is connected, or the own ship position on the user map is entered in the manual mode.

Procedures

- 1) **Insert a flash memory card into the card slot.**

Flash memory card (option) is necessary.

- 2) **Open the File Operations menu by performing the following menu operation.**

U.Map

→

7. File Operation

- 3) **Left-click the item button of 1. Select Card Slot and select the card slot.**

Slot1 and Slot2 of the Select Card Slot items are switched.

- 4) **Left-click the 5. Save button.**

The Input File Name screen will appear.

- 5) **Enter the file name to be saved.**

Up to 10 characters can be entered. For the input method on the character input screen, see Section 3.3.4.7 "Entering a character".

After the data has been entered, Confirmation Window will appear.

- 6) **Left-click the 1. Yes button.**

Navigation data currently being displayed is saved.

3.6.5.4 Clearing the saved navigation data (Erase User Map)

Procedures

- 1) **Insert a flash memory card into the card slot.**

Flash memory card (option) is necessary.

- 2) **Open the File Operations menu by performing the following menu operation.**

U.Map

→

7. File Operation

- 3) **Left-click the item button of 1. Select Card Slot and select the card slot.**

Slot1 and Slot2 of the Select Card Slot items are switched.

- 4) **Left-click the** 6. Erase **button.**

The Erace screen will appear.

The list of navigation data saved in the card will be displayed.

- 5) **Click numeric buttons corresponding to the number for the file to be deleted.**

Confirmation Window will appear.

- 6) **Left-click the** 1. Yes **button.**

The selected navigation data is deleted and the name of the file is deleted from the list.

3.6.5.5 Displaying saved navigation data (Card Mark Display)

Procedures

- 1) **Insert a flash memory card into the card slot.**

Flash memory card (option) is necessary.

- 2) **Open the File Operations menu by performing the following menu operation.**

U.Map

→

7. File Operation

- 3) **Left-click the item button of** 1. Select Card Slot **and select the card slot.**

Slot1 and Slot2 of the Select Card Slot items are switched.

- 4) **Left-click the** 7. Card Mark Display **button.**

The Card Mark Display screen will appear.

The list of navigation data saved in the card will be displayed.

- 5) **Left-click the button corresponding to the number for the file to be displayed.**

Confirmation Window will appear.

- 6) **Left-click the** 1. Yes **button.**

The selected navigation data will be displayed.

3.6.6 Set and Display Geodetic System (Geodetic)

To create navigation information, set the geodetic system that is used with the connected navigation equipment. When navigation information is loaded, the geodetic system used when the navigation information was saved, is displayed. Make sure that the displayed geodetic system is identical to the one used with the navigation equipment. If the two geodetic systems are different, the positions of navigation information on the radar display will be shifted. Therefore, it is important to set the geodetic system of the navigation equipment.

[1] Setting the geodetic system for navigation data to be saved (Geodetic)

Procedures

- 1) **Open the Geodetic menu by performing the following menu operation.**

U.Map

→

6. Geodetic

The numeric value input screen for Geodetic will appear.

- 2) **Enter the desired geodetic system number.**

The geodetic system is determined.

For how to input numeric datas on the numeric value input screen, see Section 3.3.4 "Operation on Numeric Value, Latitude / Longitude and Character Input menu".

[2] Displaying the geodetic system of the navigation data being displayed (Geodetic)

Procedures

- 1) **Load navigation data by referring to Section 3.6.5.1 "Loading navigation data (Load User Map)".**
- 2) **Open the Mark Operations menu by performing the following menu operation.**

U.Map

The geodetic system will be displayed in the 6. Geodetic field.

Table3-1 : Geodetic System List

#	NAME
0	WGS-84
1	WGS-72
2	Japan
3	North American 1927(U.S)
4	North American 1927(Canada & Alaska)
5	European 1950 (Europe)
6	Australian geodetic 1966 (Australia)
7	Ordnance Survey of Great Britain (England)
8	NAD-83
9	- (No Use)
10	- (No Use)
11	ADINDAN (Ethiopia & Sudan)
12	ARC 1950 (Botswana)
13	AUSTRALIAN GEODETIC 1984 (Australia)
14	BERMUDA 1957 (Bermuda islands)
15	BOGOTA OBSERVATORY (Colombia)
16	CAMPO INCHAUSPE (Argentine)
17	CHATHAM 1971 (Chatham Islands)
18	CHUA ASTRO (Paraguay)
19	CORREGO ALEGRE (Brazil)
20	DJAKARTA (VATAVIA) (Sumatra)
21	EUROPEAN 1979 (Europe)
22	GEODETIC DATUM 1949 (New Zealand)
23	GUAM 1963 (Guam)
24	HAYFORD 1910 (Finland)
25	HJORSEY 1955 (Iceland)
26	INDIAN (India & Nepal)
27	IRELAND1965 (Ireland)
28	KERTAU 1948 (West Malaysia)
29	L.C.5 ASTRO (Cayman Brac Island)
30	LIBERIA 1964 (Liberia)
31	LUZON (Philippines)
32	MERCHICH (Morocco)
33	MINNA (Nigeria)
34	NAHRWAN (Oman)
35	NAPARIMA, BWI (Trinidad & Tobago)
36	OLD EGYPTIAN (Egypt)
37	OLD HAWAIIAN (Hawaii)
38	PICO DE LAS NIEVES (Canary Islands)
39	PROVISIONAL SOUTH AMERICAN 1956 (South America)
40	PROVISIONAL SOUTH CHILEAN 1963 (South Chile)
41	PUERTO RICO (Puerto Rico & Virgin Islands)
42	QORNOQ (South Greenland)
43	RT90 (Sweden)
44	SANTA BRAZ (San Miguel island & Santa Maria islands)
45	SOUTH AMERICAN 1969 (South America)
46	SOUTHWEST BASE (Faial & Sao Jorge & Pico & Graciosa & Terceira island)
47	TIMBALAI 1948 (Brunei & East Malaysia)
48	- (No Use)
49	- (No Use)

3.7 USE ROUTE FUNCTION

In this radar system, a destination mark set by navigation equipment can be displayed, and a simple route can be created, displayed, loaded and saved. (To use this function, navigation equipment must be connected to this system)



If radar video is poor visibility caused by route function, click the Map button to turn off the Map function. Otherwise, press the [DATA OFF] key to map displays temporarily off.

3

3.7.1 Display Route/Destination Mark (Select Route)

In this radar system, the following route and destination marks can be displayed.

Route : Route created in the radar system are displayed.

Destination mark : Destination marks sent from outside navigation equipment are displayed.

Procedures

- 1) **Left-click the button located at the lower right of the radar display.**

The Route Menu will appear.

- 2) **Set the item.**

The following route/destination mark display modes can be selected.

: Route and destination marks are not displayed.

: Route saved in the system are displayed.

: Destination marks are displayed by using WPT data sent from outside navigation equipment.



To display the mark on the radar display, select NMEA .

The destination mark is displayed only when the Waypoint data is received from outside by using the NMEA sentence (RMB,BWC,BWR).

3.7.1.1 Displaying route created by the radar system (Internal)

In this radar system, route created by the radar system are displayed as shown below.

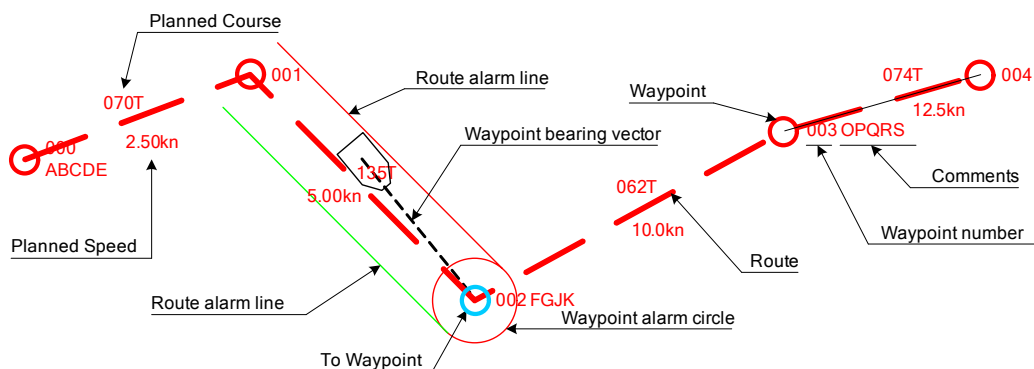

The following route data is displayed.

Waypoint : Up to 512 points (number: 000 to 511), comments can be entered.

To Waypoint : Next Waypoint is displayed in a light blue circle.

Route : A route line that connects Waypoints.

Planned Course : Scheduled route between Waypoints (automatically calculated).

Planned Speed : Scheduled sailing speed between Waypoints (entered by user).

Waypoint alarm circle : The circle that shows the distance to judge arrival in Waypoint.

Route alarm line : The line that shows the distance width to judge route alarm.

Waypoint bearing vector : A vector line that shows next destination from own ship's CCRP.

3.7.2 Edit Route (Set Route Sequence)

In this radar system, it is possible to easily create and correct route by performing operation on the radar display.

3.7.2.1 Initializing route data (New Monitor Route)

Route data saved in the radar system is initialized.

NOTE: Once route data is initialized, route data saved in the radar system's storage section is deleted. If there is necessary route data, save the route data on the flash memory card before initializing it.

Procedures

- 1) **Open the Set Route Sequence menu by performing the menu operation below.**

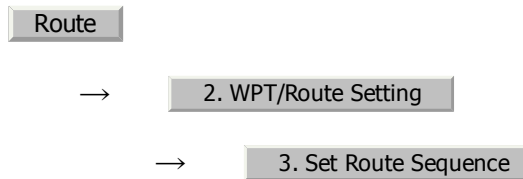

- 2) **Left-click the 7. New Monitor Route button.**

Confirmation Window will appear.

- 3) **Left-click the 1. Yes button.**

The saved route data will be deleted.

3.7.2.2 Adding a Waypoint (Add Waypoint)

New Waypoint data is added to the route data saved in the radar system.

Procedures

- 1) **Open the Set Route Sequence menu by performing the menu operation below.**

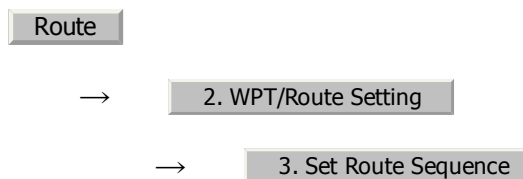

- 2) **Left-click the 2. Add button.**

The Waypoint adding mode is selected.

The rubber band from the last Waypoint to the cursor position will be displayed on the radar display.

- 3) **Left-click the location at which you want to add a Waypoint.**

A Waypoint will be added.

When a Waypoint is added, the value of the Planned Speed in the section up to the menu is used for the Planned Speed value up to the added Waypoint.

- 4) **To add another Waypoint, repeat procedure 3.**
- 5) **To finish adding a Waypoint, left-click twice at the last Waypoint.**

The Waypoint adding mode is cancelled.

(Example)

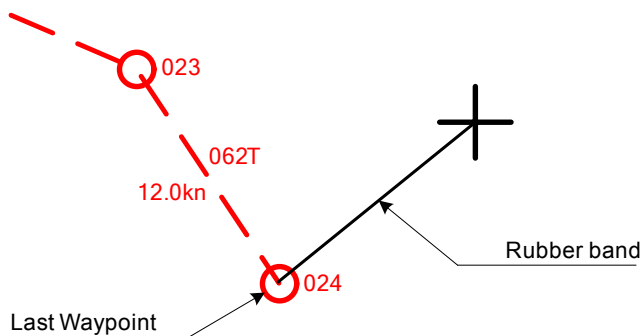

3.7.2.3 Correcting coordinates of a Waypoint (Correct Position)

The coordinates of a Waypoint in the route data saved in the radar system are corrected.

Procedures

- 1) **Open the Set Route Sequence menu by performing the menu operation below.**

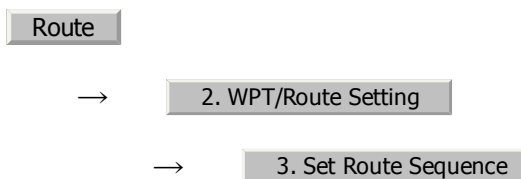

- 2) **Left-click the 3. Correct Position button.**

The Waypoint correcting mode is selected.

- 3) **On the radar display, put the cursor on the Waypoint that is to have its coordinates corrected, and left-click.**

The Waypoint to be corrected is specified.

The cursor display becomes a  cursor mark, and a rubber band is displayed.

4) **Move the cursor to new coordinates, and left-click.**

The coordinates of the Waypoint are corrected, and then the Waypoint correcting mode is cancelled.

(Example)

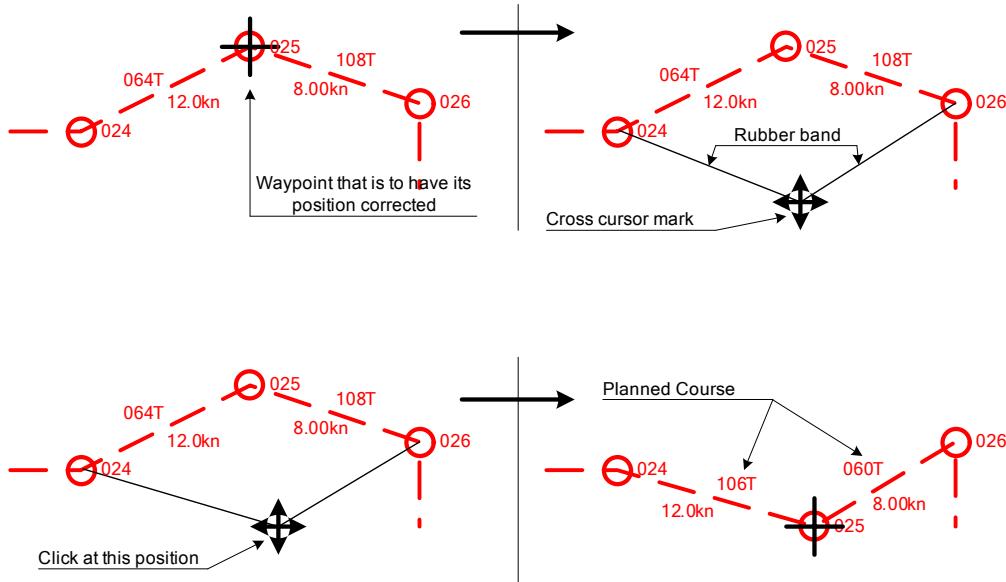

3.7.2.4 Correcting Planned Speed (Correct Planned Speed)

Planned Speed of the route data saved in the radar system is corrected.

Procedures

- 1) **Open the Set Route Sequence menu by performing the menu operation below.**

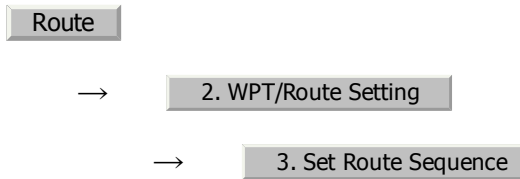

- 2) **Left-click the 4. Correct Planned Speed button.**

The Planned Speed correcting mode is selected.

- 3) **Left-click the 1. Planned Speed button.**

The Planned Speed input screen will appear.

Enter a numeric value of new Planned Speed.

- 4) **On the radar display, put the cursor on the line extending between Waypoints that is to have its Planned Speed corrected.**

The section that is to have its Planned Speed corrected is specified, and the new Planned Speed is applied to the section.

- 5) **To correct the Planned Speed of another section, repeat procedures 3 and 4.**

- 6) **To finish correcting Planned Speed, left-click the 4. Correct Planned Speed button.**

The Planned Speed correcting mode will be cancelled.

(Example)

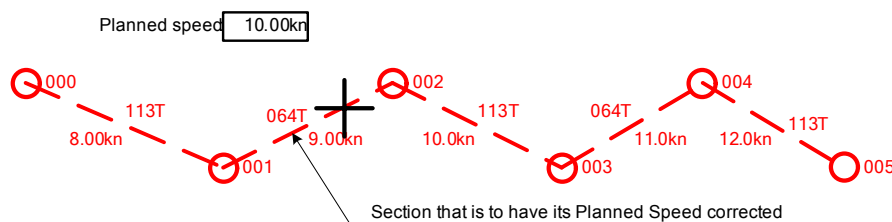

3.7.2.5 Deleting a Waypoint (Delete Waypoint)

The specified Waypoint in the route data saved in the radar system is deleted.

Procedures

- 1) **Open the Set Route Sequence menu by performing the menu operation below.**

Route

→

2. WPT/Route Setting

→

3. Set Route Sequence

- 2) **Left-click the 5. Delete button.**

The Waypoint deleting mode is selected.

- 3) **On the radar display, put the cursor on a Waypoint to be deleted, and left-click.**

The specified Waypoint is deleted, and the previous and following Waypoints are then connected by a line.

- 4) **To delete another Waypoint, repeat procedure 3.**

- 5) **To finish deleting a Waypoint, left-click the button.**

5. Delete

The Waypoint deleting mode will be cancelled.

(Example)

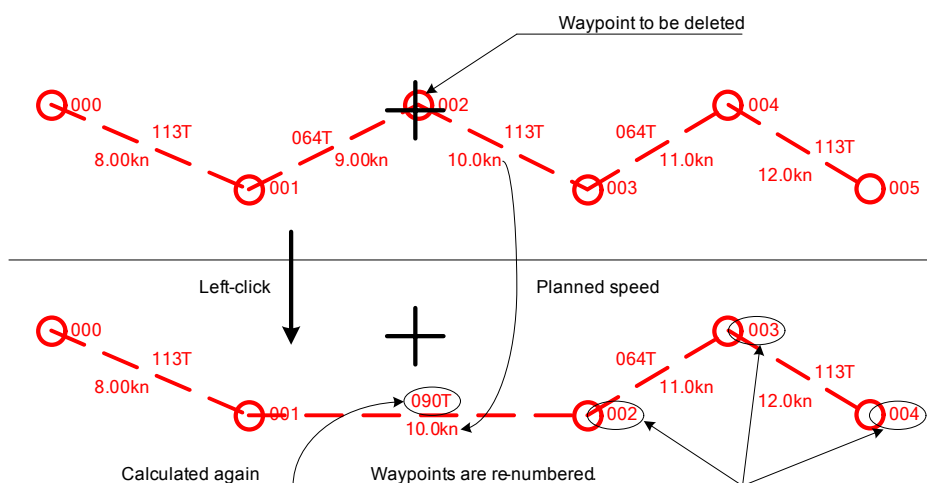

3.7.2.6 Inserting a Waypoint (Insert Waypoint)

A Waypoint is inserted at a specific location of the route data saved in the radar system.

Procedures

- 1) **Open the Set Route Sequence menu by performing the menu operation below.**

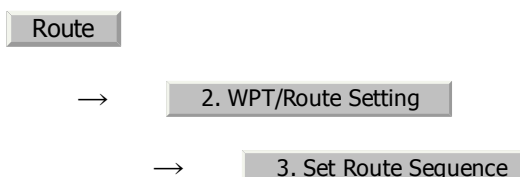

- 2) **Left-click the**  **button.**

The Waypoint inserting mode is selected.

- 3) **On the radar display, put the cursor on the section line into which a Waypoint is to be inserted, and left-click.**

The section is specified, the cursor becomes a cross cursor mark, and the cross cursor mark is connected to the previous and following Waypoints by a rubber band.

- 4) **On the radar display, put the cursor on the location at which a Waypoint is to be inserted, and left-click.**

The coordinates of the new Waypoint are specified, and the new Waypoint is connected to the previous and following Waypoints by a line.

- 5) **To insert another Waypoint, repeat procedures 3 and 4.**

- 6) **To finish inserting a Waypoint, left-click the**  **button.**

The Waypoint inserting mode will be cancelled.

(Example)

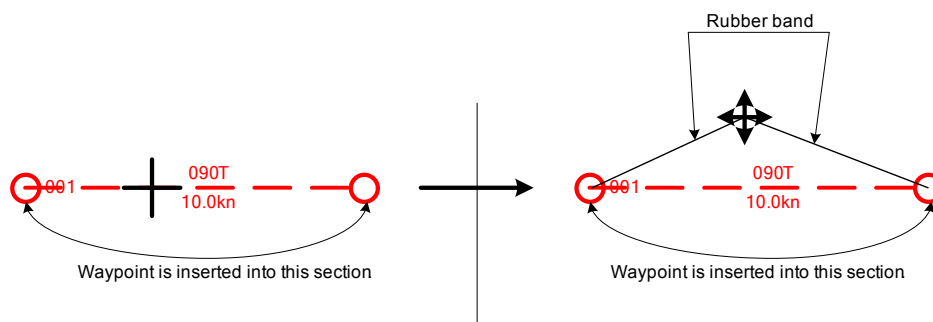

3.7.3 Edit Route Make with Latitude and Longitude (Waypoint Input)

In this radar system, it is possible to create and correct route by performing operation on the Waipoint Input menu.

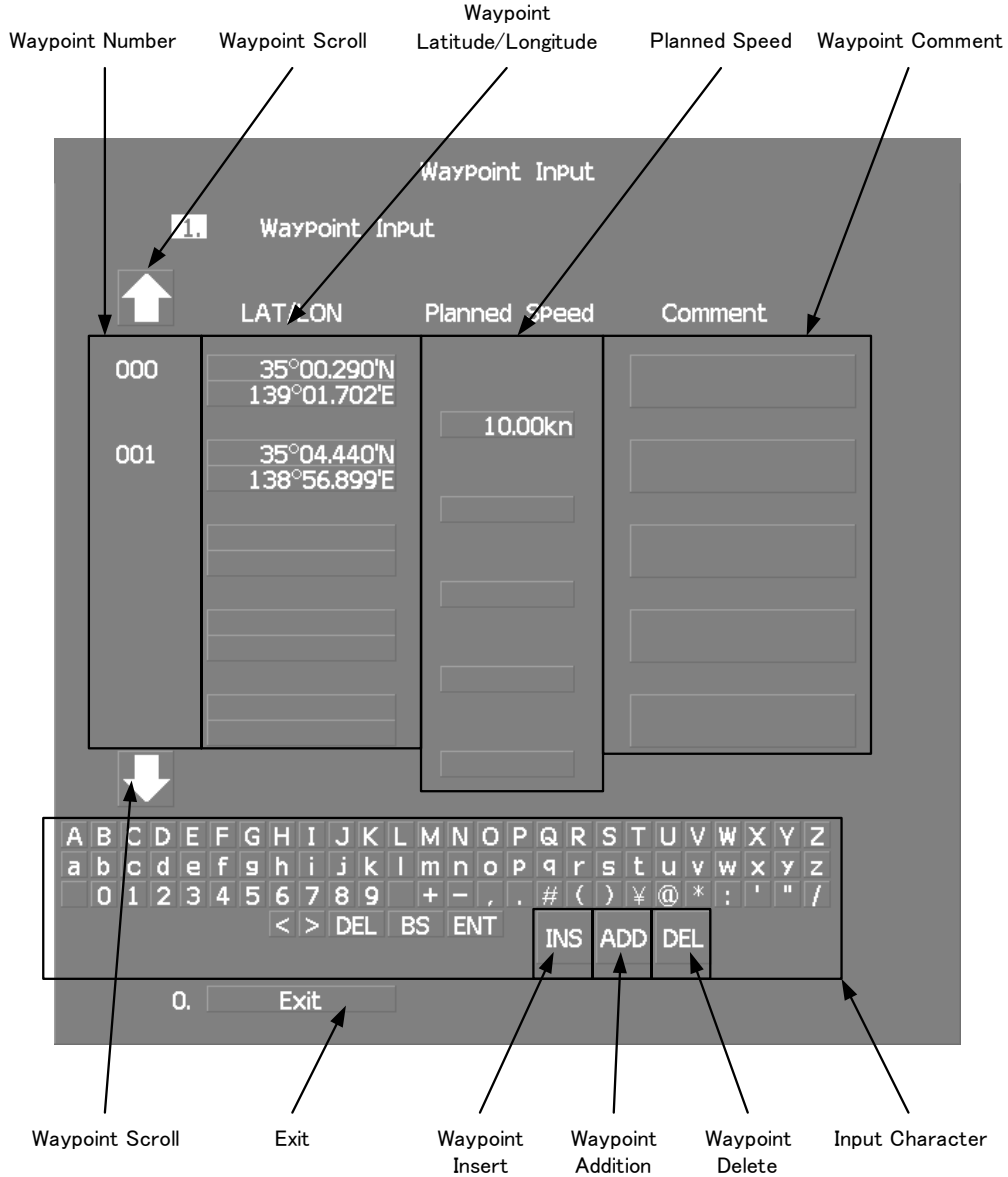

3

3.7.3.1 Open the Waipoint Input Menu

Procedures

- 1) Open the Waypoint Input menu by performing the menu operation below.

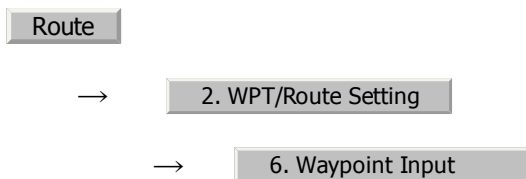

When transmitting, it can not be open.

3.7.3.2 Adding a Waypoint (Add)

New Waypoint data is added to the route data saved in the radar system.

Procedures

- 1) **Open the Waipoint Input menu.**

- 2) **Left-click the  button.**

The new latitude of waypoint is reversed.

- 3) **Enter a latitude / longitude and a planned speed.**

A Waypoint will be added.

For the input method on the latitude / longitude and numeric value input screen, see Section 3.3.4.5 "Entering latitude/longitude" and Section 3.3.4.7 "Entering a character".

3.7.3.3 Adding a Comment (Comment)

New Waypoint data is added to the route data saved in the radar system.

Procedures

- 1) **Open the Waipoint Input menu.**

- 2) **Left-click the **Waypoint Scroll** button.**

Left-click to show the desired comment.

- 3) **Left-click the **Comment** button to be added.**

The comment of waypoint is reversed.

- 4) **Enter a comment.**

A comment will be added.

For the input method on the character input screen, see Section 3.3.4.7 "Entering a character".

3.7.3.4 Correcting latitude / longitude of a Waypoint (LAT/LON)

The latitude / longitude of a Waypoint in the route data saved in the radar system are corrected.

Procedures

- 1) **Open the Waipoint Input menu.**

- 2) **Left-click the Waypoint Scroll button.**

Left-click to show the desired latitude / longitude.

- 3) **Left-click the Latitude / Longitude button to be corrected.**

The latitude of waypoint is reversed.

- 4) **Enter a latitude / longitude.**

A Waypoint will be corrected.

For the input method on the latitude / longitude input screen, see Section 3.3.4.5 "Entering latitude/longitude".

3

3.7.3.5 Correcting Planned Speed (Planned Speed)

Planned Speed of the route data saved in the radar system is corrected.

Procedures

- 1) **Open the Waipoint Input menu.**

- 2) **Left-click the Waypoint Scroll button.**

Left-click to show the desired planned speed.

- 3) **Left-click the Planned Speed button to be corrected.**

The planned speed of waypoint is reversed.

- 4) **Enter a planned speed.**

A Planned Speed will be corrected.

For the input method on the numeric value input screen, see Section 3.3.4 "Operation on Numeric Value, Latitude / Longitude and Character Input menu".

3.7.3.6 Deleting a Waypoint (DEL)

The specified Waypoint in the route data saved in the radar system is deleted.

Procedures

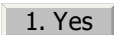
- 1) **Open the Waipoint Input menu.**
- 2) **Left-click the Waypoint Scroll button.**
Left-click to show the desired waypoint.
- 3) **Left-click the  button to be corrected.**
Confirmation Window will appear.
- 4) **Left-click the  button.**

The specified Waypoint is deleted, and the previous and following Waypoints are then connected by a line.

3.7.3.7 Inserting a Waypoint (INS)

A Waypoint is inserted at a specific location of the route data saved in the radar system.

Procedures

- 1) **Open the Waipoint Input menu.**
- 2) **Left-click the Waypoint Scroll button.**
Left-click to show the desired waypoint.
- 3) **Left-click the  button to be corrected.**
The new latitude of waypoint is reversed.
- 4) **Enter a latitude / longitude and a planned speed.**

A Waypoint will be inserted.

For the input method on the latitude / longitude and numeric value input screen, see Section 3.3.4 "Operation on Numeric Value, Latitude / Longitude and Character Input menu".

3.7.4 Use Route Monitoring Function (Waypoint/Route Alarm)

This radar system can monitor the movement of own ship with regard to its route and activate a variety of alarms.

Destination alarm (Waypoint Alarm): When own ship arrives at next Waypoint, an alarm will be activated.

Route alarm: When own ship deviates from the specified route, an alarm will be activated.

3

3.7.4.1 Destination alarm (Waypoint Alarm)

The destination alarm is activated when own ship has reached next Waypoint or own ship has deviated from the scheduled route.

A Waypoint alarm circle with a specified radius distance is displayed.

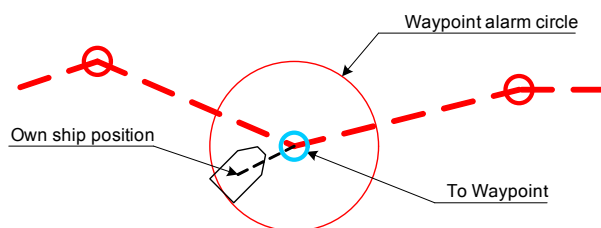

Waypoint Alarm has the following two types of alarms:

Arrival: An alarm is activated when own ship has entered the circle from outside.

Break Off: An alarm is activated when own ship has left the circle to the outside.

Procedures

- 1) **Open the WPT/Route Setting menu by performing the menu operation below.**

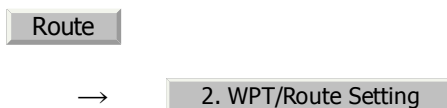

- 2) **Left-click the set value of the** 1. Waypoint Alarm **item, and select an operation mode.**

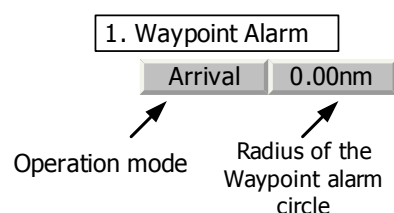

Arrival / **Break Off** : Set the operation mode.

0.00nm : Set the radius of the Waypoint alarm circle. If 0.00nm is set, alarm operation will be turned off.

3.7.4.2 Route Alarm

The route alarm is activated when own ship deviates from the specified width of the route.

The route alarm lines are displayed with a specified width provided.

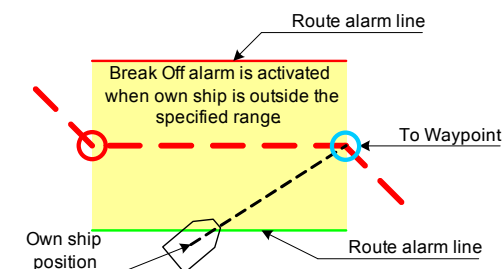

Route Alarm has the following two types of operations:

Approach : An alarm is activated when own ship enters the route range from outside.

XTE(Cross Track Error) : An alarm is activated when own ship leaves the route range.

Procedures

- 1) Open the WPT/Route Setting menu by performing the menu operation below.

Route



2. WPT/Route Setting

- 2) Left-click the set value of the **2. Route Alarm** item, and select an operation mode.

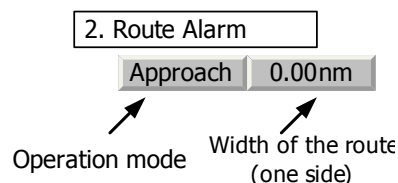

Approach / **XTE** : Set the operation mode.

0.00nm : Set the width of the route (one side). If 0.00nm is set, an alarm operation will be turned off.

3.7.5 Method of Using Route

The method of using the route will be described.

Displaying the route (Route Alarm Color):	The internal route is displayed according to the procedures in Section 3.7.1 "Display Route/Destination Mark (Select Route)".
Selecting the forward or backward of the route (Route Sequence):	Whether to use Waypoints forward or backward is selected.
Skipping of route (Waypoint Skip):	The Waypoint which is after next Waypoint is set as the next Waypoint.
Skipping back of the route (Waypoint Back Skip):	The previous Waypoint is set as the next Waypoint.



3.7.5.1 Selecting the forward or backward of the route (Route Sequence)

Select whether Waypoints in route data are used in the forward direction or backward direction.

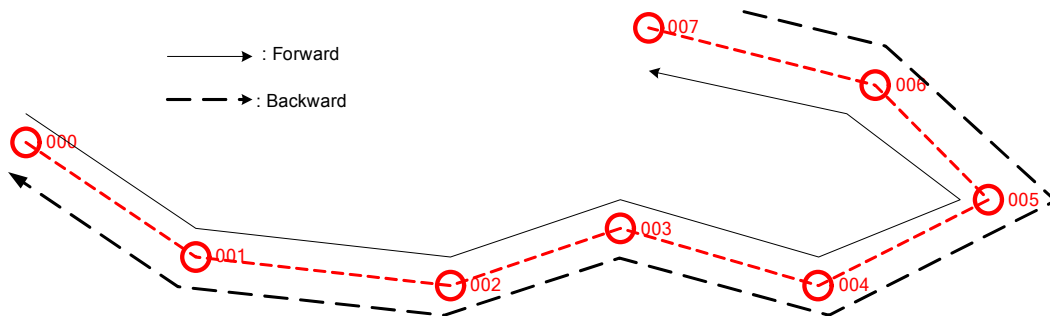

Procedures

- 1) Open the WPT/Route Operations menu by performing the menu operation below.



- 2) Left-click the set value of the 1. Route Sequence item, and select an operation mode.

- Forward :Waypoints are used in the forward direction (ascending order).
- Reverse :Waypoints are used in the reverse direction (descending order).

3.7.5.2 Skipping/Back-skipping of the route (Waypoint Skip/ Waypoint Back Skip)

Next Waypoint of the route can be changed by user manually.

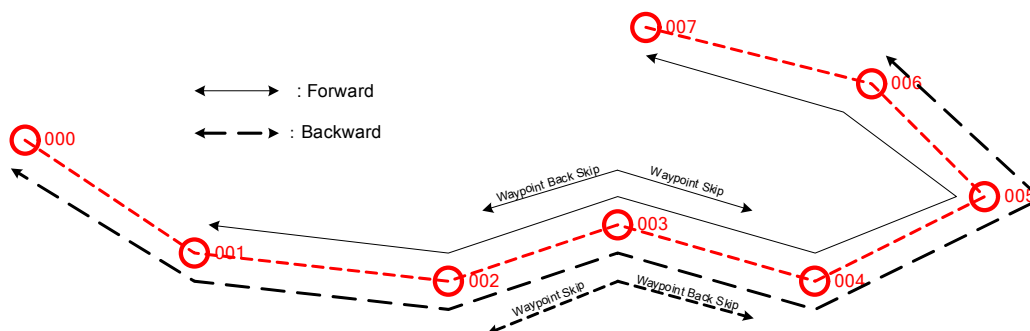

Skipping of route (Waypoint Skip):	The Waypoint which is after the next Waypoint is set as the next Waypoint.
------------------------------------	--

Skipping back the route (Waypoint Back Skip):	The previous Waypoint is set as the next Waypoint.
---	--

Procedures

- 1) Open the WPT/Route Operations menu by performing the menu operation below.

Route



3. WPT/Route Operations

- 2) To execute Waypoint Skip, left-click the **3. Waypoint Skip** button.

The Waypoint which is after the next Waypoint is set as the next Waypoint.

- 3) To execute Waypoint Back Skip, left-click the **4. Waypoint Back Skip** **Skip** button.

The previous Waypoint is set as the next Waypoint.

3.7.6 Detailed Route Settings

Make detailed settings of the route.

Color for the route alarm line (SEL NUM/Comment Size)	Set the display color for the route alarm line.
---	---

Display character size (SEL NUM/Comment Size)	:Specify the size of the numeric value and character displayed on the radar display.
Waypoint bearing vector (Waypoint Vector)	:Set the method to display line between next Waypoint and own ship.
Display of bearing distance to the destination(Status of Origin/DEST)	:Select the start point to be used for the bearing/distance display in the Waypoint data display area.
ON/OFF of Waypoint number display (WPT Number Display)	:Set whether or not to display Waypoint number next to the Waypoint mark.
Waypoint update (Waypoint Switch Mode)	:Set how to update Waypoint number when one Waypoint has been reached.

3.7.6.1 Color for the route alarm line (Off-Track Limit Line)

Route alarm lines are displayed on both sides of the center line of the route.

For this item, set which color is used to display each line.

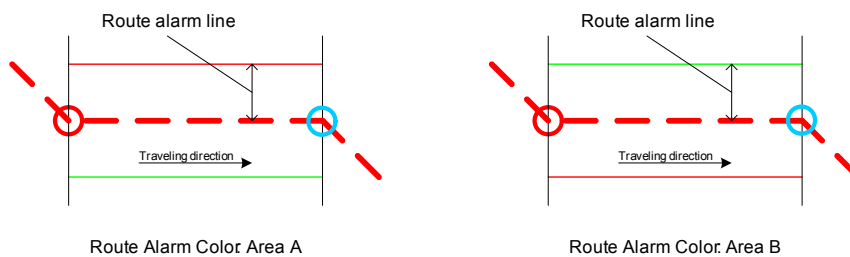

Area A (IALA-A) : The port-side is red and the bow-side is green along the traveling direction.

Area B (IALA-B) : The port-side is green and the bow-side is red along the traveling direction.

Procedures

- 1) Open the WPT/Route Setting menu by performing the menu operation below.

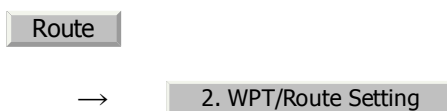

- 2) Left-click the set value of the 8. Off-Track Limit Line item, and select an operation mode.

IALA-A : Area A

IALA-B : Area B

3.7.6.2 Display character size (SEL NUM/Comment Size)

Specify the size of the numeric value and character displayed on the radar display.

Procedures

- 1) Open the Next menu by performing the menu operation below.

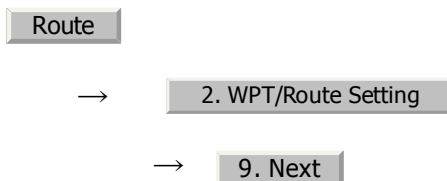

- 2) Left-click the set value of the 1. SEL NUM/Comment Size item, and select an operation mode.

Normal :Numbers and characters are displayed in normal size.

Small :Numbers and characters are displayed in a size smaller than usual.

3.7.6.3 Waypoint bearing vector (Waypoint Vector)

Set how to display a line between next Waypoint and own ship.

Procedures

- 1) Open the Next menu by performing the menu operation below.

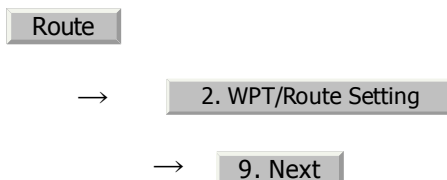

- 2) Left-click the set value of the 2. Waypoint Vector item, and select an operation mode.

Off : The Waypoint bearing vector is not displayed.

From Origin : A line is displayed from the previous Waypoint to next Waypoint.

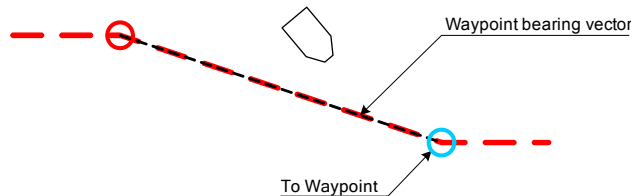

From CURR : A line is displayed from own ship to next Waypoint.

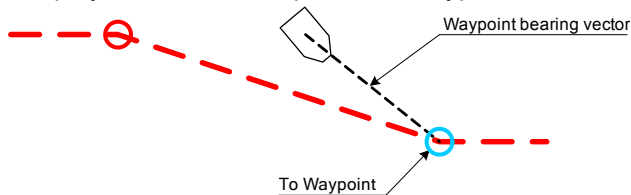

3.7.6.4 Displaying bearing distance to the Waypoint (Status of Origin/DEST)

Select a start point used to display bearing/distance in the Waypoint data display area.

Procedures

- 1) Open the Next menu by performing the menu operation below.

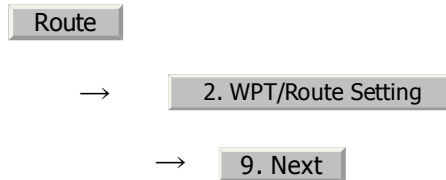

- 2) Left-click the set value of the 3. Status of Origin/DEST item, and select an operation mode.

From CURR POSN :The bearing distance from the own ship position to next Waypoint is displayed.

Fix :The bearing distance from the previous Waypoint to next Waypoint is displayed.

3.7.6.5 ON/OFF of Waypoint number display (WPT Number Display)

Set whether to display a Waypoint number next to the Waypoint mark.

Procedures

- 1) Open the Next menu by performing the menu operation below.

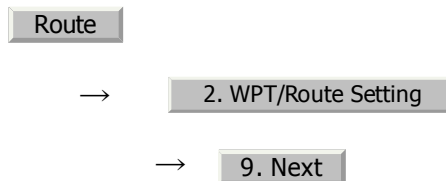

- 2) Left-click the set value of the 4. WPT Number Display item, and select an operation mode.

Off : The Waypoint number is not displayed.

On : The Waypoint number is displayed.



3.7.6.6 Updating Waypoint data (Waypoint Switch Mode)

Set how to update the Waypoint number when one Waypoint has been reached.

Procedures

- 1) Open the WPT/Route Operations menu by performing the menu operation below.



- 2) Left-click the set value of the 2. Waypoint Switch Mode item, and select an operation mode.

Manual : When next Waypoint has been reached, user updates the following Waypoint.

AUTO : When next Waypoint has been reached, the following Waypoint is automatically updated.

3.7.7 Clear Waypoint/Route Data (Clear WPT/Route Data)

This function clears waypoint/route data from memory.

Procedures

- 1) Open the WPT/Route Operations menu by performing the menu operation below.

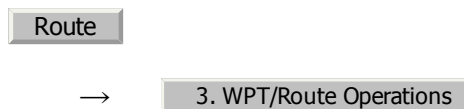

- 2) Left-click the 6. Clear WPT/Route Data button.

Confirmation Window will appear.

- 3) Left-click the 1. Yes button.

A route data will be cleared.

NOTE: If data is not copied on the flash memory card (option), the data is not be reloaded.

3.7.8 Operate Route Data File

Route data saved in the radar system can be saved onto a flash memory card, and data can be loaded from a flash memory card into the radar system.

With regard to this item, only route data can be saved and loaded. To save or load own ship's track, target track data, and mark/line data, see Section 3.11 "USING CARD".

Selecting a card slot (Select Card Slot):	Specify the card slot to be used for operating a route data file.
Saving route data (Save):	Route data saved in the radar system is saved onto a flash memory card.
Loading route data (Load):	Route data saved on a flash memory card is loaded into the radar system.
Erasing route data file (Erase):	A route data file saved in a flash memory card is erased.

3.7.8.1 Selecting a card slot (Select Card Slot)

Specify the card slot to be used for accessing a route data file
Flash memory card (option) is necessary.

Procedures

- 1) **Insert a flash memory card into the card slot.**
- 2) **Open the File Operations menu by performing the menu operation below.**



- 3) **Left-click the set value of the 1. Select Card Slot item, and select a card slot.**

Slot1 and Slot2 of the Select Card Slot items are switched.

3.7.8.2 Saving route data (Save)

Route data saved in the radar system is saved onto a flash memory card.
Flash memory card (option) is necessary.

Procedures

- 1) **Insert a flash memory card into the card slot.**

- 2) **Open the File Operations menu by performing the menu operation below.**



- 3) **Left-click the 3. Save button.**

The file name input screen will appear.

For the input method on the character input screen, see Section 3.3.4.7 "Entering a character".

- 4) **After having entered a file name, left-click the ENT button.**

The entry of the file name will be finished.

Confirmation Window will appear.

- 5) **Left-click the 1. Yes button.**

The route data will be saved with the specified file name.

3.7.8.3 Loading route data (Load)

Route data is loaded into the radar system from a flash memory card.

Flash memory card (option) is necessary.

NOTE: Once route data has been loaded into the radar system from a flash memory card, the route data that has been saved in the radar system is overwritten and erased. Route data that has been erased cannot be resaved. Note that important route data should be saved in a flash memory card.

Procedures

- 1) **Insert a flash memory card into the card slot.**

- 2) **Open the File Operations menu by performing the menu operation below.**



- 3) **Left-click the 2. Load button.**

Contents of the specified memory card (file list) will be displayed.

- 4) **Left-click the button for the desired file name.**

Confirmation Window will appear.

- 5) **Left-click the 1. Yes button.**

The route data with the specified file name will be loaded.

3.7.8.4 Erasing route data (Erase)

An unnecessary route data file saved on a flash memory card is erased.

Flash memory card (option) is necessary.

NOTE: Once route data files that have been saved on a flash memory card is erased, the erased data cannot be resaved. Note that important files should not be erased.

Procedures

- 1) **Insert a flash memory card into the card slot.**

- 2) **Open the File Operations menu by performing the menu operation below.**



3) **Left-click the button.**

Contents of the specified memory card (file list) will be displayed.

4) **Left-click the button for the desired file name.**

Confirmation Window will appear.

5) **Left-click the button.**

A route data file with the specified file name will be erased.

3.8

APPLIED OPERATIONS

3

3.8.1 Set Radar Signal Processing (Process Setting)

This function enables the setting of detail information about radar signal processing.

Procedures

- 1) Open the Process Setting menu by performing the menu operation below.

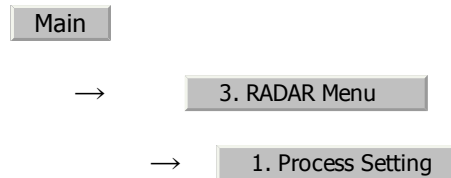

The Process Setting menu will appear.

Detail information about radar signal processing can be set by changing the settings of the menu items.

NOTE: After the settings for radar signal processing are changed, small targets may not be displayed or unwanted waves may not be suppressed. Thus, do not make a significant change in the settings.

3.8.1.1 Video Latitude

- Select the dynamic range in which receiving signals are to be shown on the radar display.
- Select **Normal** in standard, and **Wide** in rainy weather.
- **Narrow** clearly displays short-range videos when STC is used in manual mode.

Narrow : Narrows the dynamic range at short range.

Normal : Standard setting

The dynamic range varies depending on the actual range:

Short distance: wide **Long distance:** narrow

Wide : Use this mode when rainy weather intensifies unwanted waves. The dynamic range is about twice as wide as when **Normal** is selected.

Super Wide : Use this mode when rain cloud remain at **Wide** mode.

3.8.1.2 Video Noise Rejection

- This function rejects signals that assumed as noise and clutter in radar videos.
- Select **Off** to display radar videos like analog signals.
- Select **Level1** or **Level2** to suppress noise and clutter.
- Select **Level1** or **Level2** to superimpose-display the chart.

Off : Turns off the noise rejection function, and displays all signals. Targets are popped up from noise and displayed like analog signals.

Level1 : Rejects the signals of definitely unwanted waves (noise and clutter). When detection of targets or unwanted waves is not definite, the signals are displayed.

Level2 : Rejects the signals of definitely unwanted waves (noise and clutter). When detection of targets or unwanted waves is not definite, the signals are rejected. Only when detection of targets is definite, the signals are displayed.

3.8.1.3 Auto Dynamic Range

- When the automatic sea clutter suppression mode and the automatic rain/snow clutter suppression mode are in use, the dynamic range is automatically controlled.
- When the automatic sea clutter suppression mode is in use, this function improves gain by widening the dynamic range of only areas where sea clutter is strong and narrowing the dynamic range of areas where sea clutter is not detected.
- When the automatic rain/snow clutter suppression mode is in use, this function improves gain by widening the dynamic range of areas where sea clutter and rain/snow clutter are strong and narrowing the dynamic range of the other areas.
- Land videos become obscure when the automatic rain/snow clutter suppression mode is in use.

Off : Does not control the dynamic range automatically. (Standard setting) The dynamic range is set in the same manner as when the manual sea clutter suppression mode or the manual rain/snow clutter suppression mode is in use.

On : Automatically controls the dynamic range.

3.8.1.4 Process Switch

- This function sets a specific area and switches the video process mode between the inside and outside of the area.
- In Section 3.8.1.5 "2nd Porcess Mode" 2nd Process Mode, set the second video process mode for the area outside the boundary.
- In [2] PROCESS of Main Menu , set the first video process mode for the area inside the boundary.
- Gain at a distance can be improved by suppressing near sea clutter through the correlative process.
- There are two methods for setting an area:

Off : Disables the Process Switching function. (Standard setting)

Range Fix : Sets a boundary at a constant range from the center. Set the boundary range in Section 3.8.1.6 "Process Switch Range". The specific area turns out to be a circle with the own ship' s position as the center.

AUTO : Automatically sets a specific area. The area subject to many clutter returns is inside the boundary, and the area less subject to clutter returns is outside the boundary.

3.8.1.5 2nd Porcess Mode

- Set the second video process mode for the outside of a specific area.
- This function is enabled when **Range Fix** or **AUTO** is selected in Section 3.8.1.4 "Process Switch".

Video process modes

PROC Off : Select this mode in general.

3Scan CORREL : Select this mode when many rain/snow clutter returns are detected.

4Scan CORREL : Select this mode to highlight targets while suppressing sea clutter returns.

5Scan CORREL : Select this mode to detect small targets hidden by sea clutter returns.

Remain : Select this mode when own ship yaws wildly.

Peak Hold : Select this mode to detect small targets of which detection probability is low.

3.8.1.6 Process Switch Range

- Set the boundary range of a specific area.
- This function is enabled when **Range Fix** is selected in Section 3.8.1.4 "Process Switch".
- The specific area turns out to be a circle with the own ship' s position as the center.
- The boundary range can be set in units of 0.1 nm, ranging 0.1 to 25.5 nm.

3.8.1.7 Fast Target Detection

- This function displays fast moving targets that are suppressed in scan-correlative process mode.
- This function is enabled when **3Scan CORREL**, **4Scan CORREL**, or **5Scan CORREL** is selected as the video process mode.
- If unwanted waves remain on the radar display, suppress them by using the [SEA], [RAIN], or [GAIN] dial, or adjusting the interference rejection mode.

Off : Disables the Fast Target Detection function.

On : Enables the Fast Target Detection function.

3.8.2 Set Radar Trails (RADAR Trails Setting)

This function enables the setting of detail information about radar trails processing.

Procedures

- 1) Open the RADAR Trails Setting menu by performing the menu operation below.

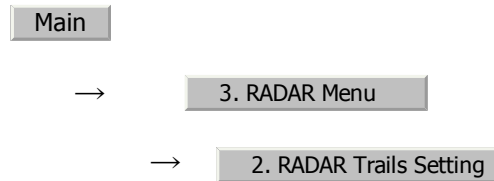

The RADAR Trails Setting menu will appear.

Detail data about radar trails processing can be set by changing the settings of each menu item.

NOTE: After the settings for radar trails processing are changed, targets' trails may not be displayed or trails may be plotted with unwanted waves. Thus, do not make a significant change in the settings.

3.8.2.1 Trails Mode

- Set the radar trail display mode.
- For details on the trail mode, see Section 3.4.8 "Display Radar Trails (Trails)"

3.8.2.2 Trails REF Level

- Select a radar video level required for plotting radar trails.
- The radar video threshold level increases in order of **Level1** → **Level2** → **Level3** → **Level4**.
- To plot radar trails with unwanted waves, change to a higher level.
- To thin radar trails, change to a higher level.
- If radar trails are plotted in snatches, change to a lower level.

3.8.2.3 Trails Reduction

- Make a setting for thinning radar trails.
- The effect of thinning increases in order of → → .
- Radar videos do not become obscure because of the thinning of radar trails.

: Disables the Trails Reduction function.

: Enables the Trails Reduction function. (Effect: Low)

: Enables the Trails Reduction function. (Effect: Modest)

: Enables the Trails Reduction function. (Effect: High)

3.8.2.4 Trails Process

- Determine whether to use the video process with radar signals for plotting radar trails.
- When Trails Process is , radar trails are never plotted with unwanted waves, but the radar trails of moving targets may not be plotted.
- When Trails Process is , radar trails may be plotted with unwanted waves, but the radar trails of moving targets are always plotted.

: Disables the Trails Process function.

: Enables the Trails Process function.

3.8.2.5 MAX Interval

- Select the maximum time for displaying radar trails.
- Select when short radar trails are often used in bays and the likes.
- Select when long radar trails are necessary for ocean navigation.

: Sets 15 minutes as the maximum time for radar trails display.

: Sets 30 minutes as the maximum time for radar trails display.

: Sets 60 minutes as the maximum time for radar trails display.

3.8.3 Set Scanner Unit (TXRX Setting)

This function enables the setting of detail information about an antenna.

Procedures

- 1) **Open the TXRX Setting menu by performing the menu operation below.**

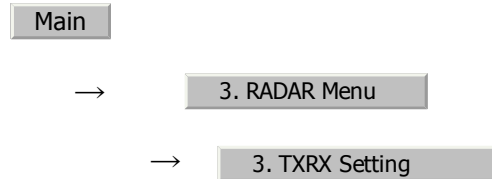

The TXRX Setting menu will appear.

Detail information about antenna operation can be set by changing the settings of the menu items.

3.8.3.1 PRF Fine Tuning

- Fine-tune the transmitting repetition frequency of the transmitter in the range 90 to 100%.
- If radar's interference patterns are concentrically displayed, increment or decrement the set value by 3 to 4 in order to heighten the effect of interference rejection.
- One of 32 levels 0-31 can be set.

3.8.3.2 Stagger Trigger

- The interference reduction function is activated by using the transmission repetition frequency control of the transmitter.
- This function is effective when radar interference does not go away.

Off : Stagger Trigger is not used.

On : Stagger Trigger is used.

3.8.3.3 PRF

- Select the operation mode the transmitting repetition frequency of the transmitter.

Normal :Standard mode Both appropriate gain and magnetron's life expectancy are maintained.

Economy :Power saving mode Gain slightly lowers, but the service life of magnetron is prolonged when short pulses are used.

High Power :High gain mode Gain improves when long pulses are used, but the service life of magnetron is slightly shortened.

3.8.3.4 Ice Class Standby Mode

- In this mode, the antenna is rotated when transmission is in the standby state.
- This mode is effective to prevent the antenna's rotating shaft from freezing.

Off :The ice class standby mode is not used. When transmission is in the standby state, the antenna also stops rotating.

On :The ice class standby mode is used. When transmission is in the standby state, the antenna rotates.

3.8.4 Set Cursor (Cursor Setting)

This function enables the setting of detail information about cursor operation and display.

Procedures

- 1) **Open the Cursor Setting menu by performing the menu operation below.**

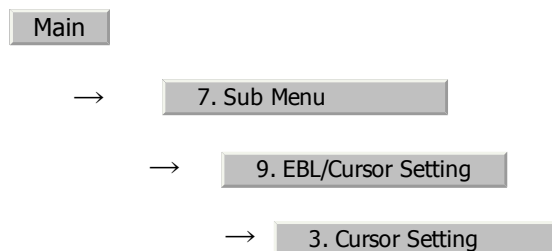

The Cursor Setting menu will appear.

Detail information about cursor operation and display can be set by changing the settings of the menu items.

3.8.4.1 EBL/VRM Control CURS

- The EBL/VRM Control Cursor is switched between Valid and Invalid.
- The trackball is provided as a standard device. If the trackball malfunctions, the cursor can be moved by using the [EBL] dial and [VRM] dial.
- The cursor moves horizontally when [EBL] is operated, and moves vertically when [VRM] is operated.
- To switch between EBL/VRM operation and cursor operation while ON is selected, hold down the [EBL] dial for 2 seconds.

On : Cursor is operated using a [EBL] [VRM] dial.

Off : Cursor is operated using a trackball.

3.8.4.2 Cursor Length





- Set the length of the cross cursor mark on the radar display.

Short Cuts the cross cursor mark in length.

Long : Makes the cross cursor mark twice as long as when Short is selected.

3.8.4.3 Cursor Pattern

- The type of the cross cursor mark displayed of the display is selected.

-  : Type 1 is selected for the cross cursor mark 1 displayed in the radar display.
-  : Type 2 is selected for the cross cursor mark 2 displayed in the radar display.
-  : Type 3 is selected for the cross cursor mark 3 displayed in the radar display.
-  : Type 4 is selected for the cross cursor mark 4 displayed in the radar display.

3.8.5 Set Radar Display (Display Setting)

This system can save combinations of display color and brilliance in accordance with ambient lighting conditions and the radar display can be easily switched.

Follow the procedures below to set display color and brilliance to be saved before hand.

3.8.5.1 Setting display color (Display Color Setting)

Procedures

- Open the Color Setting menu by performing the menu operation below.

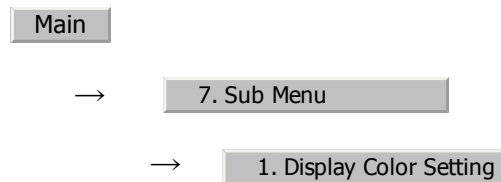

Display Color Setting menu will appear.

3.8.5.2 Day/Night

- Specify the mode to be changed.
- The following modes are available:

Day1	: Day mode 1	: Used under bright lighting conditions.
Day2	: Day mode 2	: Used under bright lighting conditions.
Day3	: Day mode 3	: Used under bright lighting conditions.
Dusk	: Dusk mode	: Used under dim lighting conditions.
Night	: Night mode	: Used under dark lighting conditions.

Setting color of each element

- Specify the color for the element.
- The color for the following elements can be specified.

<input type="text" value="Outer PPI"/>	: The color of the background outside radar video PPI is selected.
<input type="text" value="Inner PPI"/>	: The color of the background inside radar video PPI is selected.
<input type="text" value="Character"/>	: The color of the character and bearing scale is selected.
<input type="text" value="RADAR Video"/>	: The color of the radar video is selected.
<input type="text" value="RADAR Trails(Time)"/>	: The color of the time radar trails is selected.
<input type="text" value="RADAR Trails(All)"/>	: The color of the time radar trails is selected.
<input type="text" value="Target Symbol"/>	: The color of the target symbol is selected.
<input type="text" value="Cursor"/>	: The color of the cursor is selected.
<input type="text" value="Range Rings"/>	: The color of the range rings is selected.
<input type="text" value="EBL/VRM/PI"/>	: The color of the EBL / VRM / PI is selected.
<input type="text" value="Own Symbol/HL/Vector"/>	: The color of the own ship symbol, heading line, own ship vector is selected.



Those selected color can be saved for each Day/Night mode.

3.8.5.3 Setting display brilliance (Brilliance Setting)

For each Day/Night mode, background color outside the bearing scale, background color inside the bearing scale, and color for characters, radar echo and radar trails can be selected.

Procedures

- 1) **Open the Brilliance Setting menu by performing the menu operation below.**

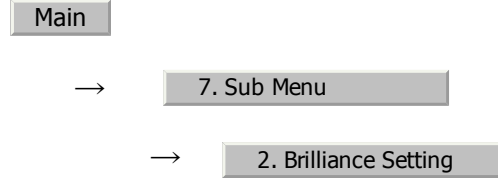

Display Brilliance Setting menu will appear.

Setting brilliance of each element

- Specify the brilliance for the element.
- Level4 indicates maximum brilliance and Level1 indicates minimum brilliance.
- The brilliance for the following elements can be specified.

<input type="text" value="RADAR Video"/>	: The brilliance of the radar video is selected.
<input type="text" value="RADAR Trails"/>	: The brilliance of the radar trails is selected.
<input type="text" value="Target Symbol"/>	: The brilliance of the target symbol is selected.
<input type="text" value="Range Rings"/>	: The brilliance of the range rings is selected.
<input type="text" value="EBL/VRM/PI"/>	: The brilliance of the EBL / VRM / PI is selected.
<input type="text" value="Character"/>	: The brilliance of the character and bearing scale is selected.
<input type="text" value="Own Symbol/HL/Vector"/>	: The brilliance of the own ship symbol, heading line, and own ship vector is selected.
<input type="text" value="Keyboard"/>	: The brilliance of the operation panel is selected.



Those selected brilliance can be saved for each Day/Night mode.

3.8.5.4 Setting radar video brilliance (VID)

The brilliance of the video on the radar display is adjusted.

Procedures

- 1) **Left-click the  button located at the lower right of the radar display, and adjust the brilliance of the radar video so as to get the best view of the video display.**

The brilliance of the radar video can be adjusted on four stages without opening the Brilliance Setting menu.

Adjust the radar display to obtain the best-to-view video.

3.8.5.5 Setting target symbol brilliance (TT)

The brilliance of the target symbol on the radar display is adjusted.

Procedures

- 1) Left-click the  button located at the lower right of the radar display, and adjust the brilliance of the target symbol so as to get the best view of the video display.

The brilliance of the target symbol can be adjusted on four stages without opening the Brilliance Setting menu.

Adjust the radar display to obtain the best-to-view video.

3.8.6 Adjust Sound Volume (Buzzer Volume)

When an alarm is activated, the operation panel issues an alarm audible to inform user of the change of the condition.

The alarm sound can be adjusted by performing the following procedures.

Procedures

- 1) Open the Buzzer Volume menu by performing the menu operation below.

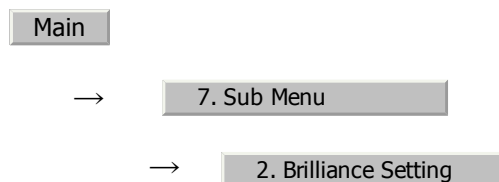

Display Buzzer Volume menu will appear.

The volume of the alarm sound can be specified for each cause for alarm.

 indicates maximum volume and  indicates minimum volume.

Key ACK	: The operation key acknowledgement is set.
OPE Miss	: The incorrect operation alarm is set.
CPA/TCPA Alarm	: The dangerous ship alarm is set.
New Target Alarm	: The automatic acquisition target alarm is set.
Lost Alarm	: The target lost alarm is set.
Navigation Alarm	: The navigation data abnormality alarm is set.
System Alarm	: The system abnormality alarm is set.
Inter Switch	: The inter switch switching alarm is set.

3.8.7 Set User Option Keys [OPTION 1/2]

Users can freely make settings with [OPTION 1] key and [OPTION 2] key.

By using the keys, users can open a frequently used menu by only single operation, or assign special functions, to the user key switches.

3.8.7.1 Initial Setting (Option Key Setting)

Set functions that can be performed with the option key switches.

Procedures

- 1) Open the Option Key Setting menu by performing the menu operation below.

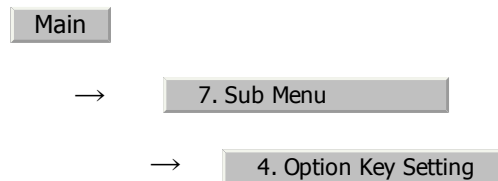

The Option Key Setting menu will appear.

This system provides two user keys: [OPTION 1] and [OPTION 2]. Different functions can be allocated to each key.

Functions that can be allocated to each key are as follows:

- Menu** : A specific menu is directly displayed.
- Zoom** : The zoom display function is switched between on and off.
- DEST** : Set/Cancel Waypoint menu key
- >O** : Start-point, Pass-point key in simple route operating
- O->** : End-point key in simple route operating
- Capture Screen** : Screen capture key (This function is enabled only when the card (optional) is connected.)

3.8.7.2 Using Option Keys (Directly displaying a specified)

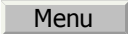
Preset the  that is to be displayed with the option key switch.

Procedures

- 1) **Perform the general menu open procedure to open the menu that is to be directly displayed with Option Key.**
- 2) **While the menu is open, hold down [OPTION 1] key or [OPTION 2] key for 2 seconds.**

The menu currently being displayed is saved for the pressed option key.



The menu set for the pressed option key will open. Subsequently, general menu operation can be performed.

3.8.7.3 How to use the Optin key (Display)

Preset whether to execute the  display by operating the user key.

Procedures

- 1) **Press either [OPTION 1] key or [OPTION 2] key for which  has been set.**

The zoom mode is activated.

- 2) **Put the cursor on a location that is to be zoomed, and left-click.**

Zoom is set.

Cancel

- 1) **Press either [OPTION 1] key or [OPTION 2] key for which  has been set.**

The zoom mode is cancelled and a normal display will appear.

3.8.8 Set Navigation Data Display (Multi Window Setting)

By performing the following operation, it is possible to display navigation data of the wind direction / velocity, water depth and the like, as a graph on the radar display.

Procedures

- 1) **Open the Multi Window Setting menu by performing the menu operation below.**



The Multi Window Setting menu will appear.

Detailed settings of the display are possible by changing the settings of each item.

3.8.8.1 DIR/DIST EXP Display

- Determine whether to expand the value display of cursor, EBL, and VRM.
- The value display is expanded in digital information area 2.
- When the cursor mark moves on the PPI, the display of cursor information is expanded.
- When an EBL or VRM is operated, the value display of each marker is expanded.
- While the menu is open, any display is not expanded.

Off : Does not expand any display.

On : Expands the display in digital information area 2. The expanded display remains for 5 seconds after the operation of each marker, and then it will disappear.

Always On : Expands the display in digital information area 2.

3.8.8.2 Numeric NAV INFO

- Determine whether to display the numeric values of received navigation information.
- One of two digital information areas is used to display data.
- When navigation data is displayed, the sizes of the target tracking (TT)/AIS numeric data display areas are exclusively decreased.

- Navigation information of the water depth, water temperature, tidal current, wind direction/velocity, and destination is displayed with numeric values.
- Left-click the **Target** button located at the lower right of the display. The navigation data display function is switched between On and Off.

Off : Does not display the numeric values of navigation information.

Area1 : Displays the numeric values of navigation information in digital information area 1.

Area2 : Displays the numeric values of navigation information in digital information area 2.

3.8.8.3 Depth Graph Setting

- The Depth Graph Setting menu will appear.

[1] Depth Graph Display

- Determine whether to display received water depth information with a graph.
- One of two digital information areas is used to display data.
- When the water-depth graph is displayed, the sizes of the target tracking (TT)/AIS numeric data display areas are exclusively decreased.
- Left-click the **Target** button located at the lower right of the display. The water-depth graph display function is switched between On and Off.

Off : Does not display a water depth graph.

Area1 : Displays the water depth graph in digital information area 1.

Area2 : Displays the water depth graph in digital information area 2.

[2] Depth Range

- Select the depth range on the water depth graph.

50m : Sets 50 m as the depth range.

100m : Sets 100 m as the depth range.

250m : Sets 250 m as the depth range.

AUTO : Uses the depth range in the DPT sentence included in received data.

[3] Time Range

- Select the time range on the water depth graph.

10min : Sets 10 minutes as the time range.

15min : Sets 15 minutes as the time range.

30min : Sets 30 minutes as the time range.

60min : Sets 60 minutes as the time range.

12hour : Sets 12 hours as the time range.

[4] Depth Unit

- Set the unit of water depth for the water-depth graph.

Feet : The foot is used as the unit of water depth.

Fathom : The fathom is used as the unit of water depth.

Meters : The meter is used as the unit of water depth.

3.8.8.4 Wind Graph Setting

- The Wind Graph Setting menu will appear.

[1] Wind Graph Display

- Determine whether to display received wind direction/velocity information with a graph.
- One of two digital information areas is used to display data.
- When the wind direction / speed graph is displayed, the sizes of the target tracking (TT) / AIS numeric data display areas are exclusively decreased.
- Left-click the **Target** button located at the lower right of the display. The wind direction / speed graph display function is switched between On and Off.

Off : Does not display the wind direction / speed graph.

Area1 : Displays the wind direction / speed graph in digital information area 1.

Area2 : Displays the wind direction / speed graph in digital information area 2.

[2] Wind Speed Unit

- Set the unit of wind velocity for the wind direction / speed graph.

m/s : Meters per second are used as the unit of wind speed.

km/h : Kilometers per hour are used as the unit of wind speed.

kn : Knots are used as the unit of wind speed.

3.8.8.5 TEMP Graph Setting

- The TEMP Graph Setting menu will appear.

[1] TEMP Graph Display

- Determine whether to display the graph of the water-temperature data that has been received on the radar display.
- One of two digital information areas is used to display data.
- When the water-temperature graph is displayed, the sizes of the target tracking (TT)/AIS numeric data display areas are exclusively decreased.
- Left-click the **Target** button located at the lower right of the display. The water-temperature graph display function is switched between On and Off.

Off : The water-temperature graph is not displayed.

Area1 : The water-temperature graph is displayed in digital information area 1.

Area2 : The water-temperature graph is displayed in digital information area 2.

[2] TEMP Graph Color

- Set the color for the water-temperature graph.
- There are eight selection items:

White , **Gray** , **Blue** , **Green** , **Yellow** , **Pink** , **Red**

[3] TEMP Range

- When Color is selected for the display color for the water-temperature graph, set the temperature range of each color.

[4] Time Range

- Set the time range for the water-temperature graph.

10min : The time range is set at 10 minutes.

15min : The time range is set at 15 minutes.

30min : The time range is set at 30 minutes.

60min : The time range is set at 60 minutes.

12hour : The time range is set at 12 hours.

3.8.8.6 Course Bar Setting

- The Course Bar Setting menu will appear.

[1] Course Bar Display

- Determine whether to display the bar graph for the course data that has been received on the radar display.
- One of two digital information areas is used to display data.
- When the course-bar graph is displayed, the sizes of the target tracking (TT)/ AIS numeric data display areas are exclusively decreased.
- Left-click the **Target** button located at the lower right of the display. The course bar display function is switched between On and Off.

Off : The course bar graph is not displayed.

Area1 : The course bar graph is displayed in digital information area 1.

Area2 : The course bar graph is displayed in digital information area 2.

[2] Autopilot Course

- Determine which field of the APB sentence that has been received is used to display AP course.

Course to Steer : Heading to Steer to Destination

From Origin : Bearing Origin to Destination

From CURR POSN : Bearing, Present Position to Destination

[3] ROT Scale

- Set the maximum scale for the TURN Rate graph.

30-0-30 : The scale is set at $\pm 30^\circ/\text{min}$.

60-0-60 : The scale is set at $\pm 60^\circ/\text{min}$.

90-0-90 : The scale is set at $\pm 90^\circ/\text{min}$.

120-0-120 : The scale is set at $\pm 120^\circ/\text{min}$.

150-0-150 : The scale is set at $\pm 150^\circ/\text{min}$.

300-0-300 : The scale is set at $\pm 300^\circ/\text{min}$.

3.8.9 AUTO Backup

Data can be automatically backed up when the power supply is turned on.

Procedures

- 1) **Insert a flash memory card into the card slot.**

Flash memory card (option) is necessary.

- 2) **Open the Plot Setting menu by performing the following menu operation.**

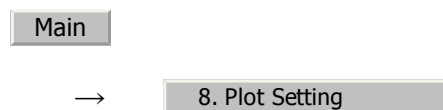

- 3) **Left-click the item button of 5. AUTO Backup Backup button.**

The AUTO Backup menu will appear.

- 4) **Select the number for the card slot to back up data.**

- Off** : The automatic backup function is turned off.
- Slot1** : Data is automatically backed up on the compact flash memory card inserted into slot 1.
- Slot2** : Data is automatically backed up on the compact flash memory card inserted into slot 2.

Data that can be backed up includes own ship's track (Own Track), other ships' trails data (Target Track), mark/line data (Mark/Line), destination data (WPT), and route data (Route).

The file name to be saved is either 9998 or 9999. Every time the power supply is turned on, those numbers are alternately displayed.

3.9

USE FUNCTION KEY [USER]

3

"Radar Function Setting" is provided for easily obtaining the best radar video by storing complex radar signal processing settings in the optimum status by use, and calling the setting in accordance with the conditions for using the function.

Functions are factory-set for general use, and the settings can be fine adjusted by operating the menu.

Four function modes are available, and they are factory-set as follows:

- Function 1: Coast Useful for observing short-range videos.
- Function 2: Deep Sea Suitable for general ocean navigation.
- Function 3: Storm Useful for observing videos in stormy weather.
- Function 4: Rain Use this mode when sea clutter is not strong but rain / snow clutter is strong.

3.9.1 Operation Procedures

3.9.1.1 Calling a Function

Procedures

- 1) **Press the [USER] key.**

Each time the [USER] key is pressed, the selection changes cyclically as follows:

Function Off → Function1 → Function2 → Function3 → Function4 → Function Off

The name of the current function mode is displayed at the lower left of the display.

Alternatively, left-clicking the function button located at the lower left of the radar display will enable the same operation.

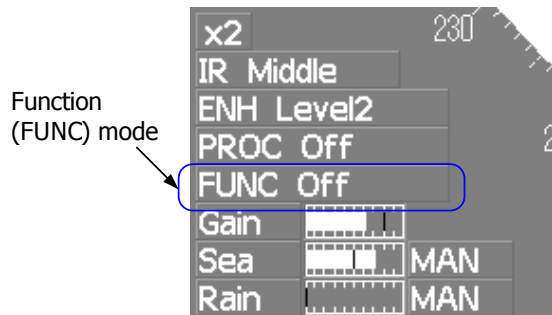

3.9.1.2 Changing Function Setting (temporary change)

When radar signal processing setting is changed by using the menu or button on the radar display while function 1 to 4 is called, the change is temporarily reflected to the operating state.

Since this method does not change the memory contents, the new setting is discarded as soon as another function is called.

When the previous function is called again, operation is performed according to the memory contents.

3.9.1.3 Changing Function Setting (memory contents change)

To change the memory contents of functions 1 to 4, use the function setting menu.

For how to operate the function setting menu, see Section 3.9.3 "Overview of Function Operations (User Function Setting)".

3.9.2 Function Setting Menu Items

The function setting menu has the items below.

page 1		Option
1. Mode	Name of the mode to be used	Coast/Deepsea/....
2. IR	Radar interference rejection	Off/Low/Middle/High
3. Process	Video process	PROC Off/3Scan CORREL/....
4. Target Enhance	Target expansion	Off/Level1/Level2/Level3
5. AUTO Sea/Rain	Automatic clutter suppression	Off / AUTO Sea / AUTO Sea/Rain
6. Save Present State	Saving the present state	

page 2		Option
1. Pulse Length 0.75NM	Standard pulse length for 0.75nm range	SP1/MP1
2. Pulse Length 1.5NM	Standard pulse length for 1.5nm range	SP1/MP1/MP2/MP3
3. Pulse Length 3/4NM	Standard pulse length for 3nm range	MP1/MP2/MP3/LP1
4. Pulse Length 6/8NM	Standard pulse length for 6nm range	MP1/MP2/MP3/LP1/LP2
5. Pulse Length 12NM	Standard pulse length for 12nm range	MP1/MP2/MP3/LP1/LP2
6. Pulse Length 16NM	Standard pulse length for 16nm range	MP1/MP2/MP3/LP1/LP2

page 3		Option
1. Video Latitude	Dynamic range of radar video	Narrow/ Normal /Wide/Super Wide
2. Video Noise Rejection	Radar video noise rejection	Off/Level1/Level2
3. AUTO Dynamic Range	Automatic dynamic range control	Off/On
4. Process Switch	Radar video process switching	Off/Range FIX/AUTO
5. 2nd Process Mode	2nd video process mode	PROC Off/3Scan CORREL/....
6. Process Switch Range	Video process switching range	
7. Fast Target Detection		Off/On

page 4		Option
1. Trails Interval	Radar trails length	Off/15sec/....
2. Trails Mode		True/Relative
3. Trails Reference Level	Radar trails plotting threshold	Level1-4
4. Trails Reduction	Thinning of radar trails	Off/Level1-3
6. Trails Process	Superimpose-display of time radar trails and continuous radar trails.	Off/On
7. Max Interval	Maximum time for radar trails display	Short/Middle/Long

page 5		Option
1. Gain Offset	Gain correction	
2. PRF	Transmitting repetition frequency	Normal/Economy/High Power
3. Small Buoy Detection	Small target detection mode	Off/On
4. Fishnet Detection	Fishnet detection mode	Off/On
5. Antenna Height		Default/-5m/5-10m/10-20m/20m
8. Set Mode Default		
9. Initialize		

3.9.3 Overview of Function Operations (User Function Setting)

The following outlines the operation of each function selected from the function setting menu:

Procedures

- 1) Open the Process Setting menu by performing the menu operation below.

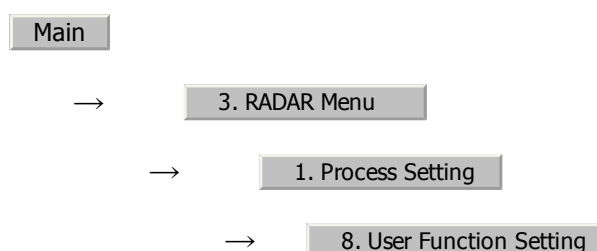

The User Function Setting menu will appear.

Specify the number for the function for which the settings are to be changed.

The following are the operation overviews of each function setting item.

page 1-[1] Mode

- Selects the function name to be indicated at the lower left of the radar display when the function is selected.
- When the setting is changed back to the factory setting, the initial value of the selected mode is called.
- The following 11 modes are provided:

Coast	: Use this mode to monitor a relatively short range, for example, bays and coasts where many boats and ships are running. (Importance is attached to resolution.)
Deep Sea	: Use this mode to monitor a relatively long range, for example, the open sea. (Importance is attached to long-range gain.)
Fish Net	: Use this mode to detect small targets such as fishnets of round haul netters hidden by sea clutter returns. (Importance is attached to sea clutter suppression, and gain to moving targets lowers.)
Storm	: Use this mode when many rain / snow clutter returns or sea clutter returns are detected in stormy weather. (Importance is attached to rain / snow clutter and sea clutter suppression, and gain slightly lowers.)
Calm	: Use this mode when only a few rain / snow clutter returns or sea clutter returns are detected.
Rain	: Use this mode when sea clutter is not strong but rain / snow clutter is strong. (Importance is attached to rain / snow clutter suppression, and gain slightly lowers.)
Bird	: Use this mode to detect flocks of sea birds.
Long	: Use this mode to monitor utmost distances in the broad ocean.
Buoy	: Use this mode to detect small targets like radio buoys in areas outside the sea clutter area. (This mode displays targets of which detection probability is low.)
User1	: General mode used when the nine modes above are not applicable.
User2	: General mode used when the nine modes above are not applicable.

page 1-[2] IR (Radar interference rejection)

- Same function as IR Setting described in Section 3.4.1 "Interference Rejection (IR)".

page 1-[3] Process (Video process)

- Same function as PROCESS Setting described in Section 3.4.4 "Use Video Processing (PROC)"

page 1-[4] Target Enhance

- Same function as TARGET ENHANCE Setting described in Section 3.4.3 "Target Enhance (ENH)".

page 1-[5] Auto STC/FTC (Auto Sea/Rain)

- Detects unwanted waves such as rain/snow clutter and sea clutter and automatically suppresses them.
- When the sea state or weather changes, this function automatically performs suppression processing in accordance with the situation.
- Suppression processing is not full automatic, and requires the operator to adjust the afterimages of unwanted waves.
- To adjust the afterimage of sea clutter, use the [SEA] dial.
- To adjust the afterimage of rain/snow clutter, use the [RAIN] dial.
- In areas where the density of unwanted waves is low, unwanted waves may remain being judged as targets. Thus, use the automatic clutter suppression mode together with the video process mode.
- Characteristics of the automatic clutter suppression function:

Off	: Disables the automatic clutter suppression function. Select off when rain / snow clutter and sea clutter are not strong or when the ship is in a bay.
AUTO Sea	: Automatically detects the strength of sea clutter, and performs the most suitable sea clutter suppression processing. Even when the strength of sea clutter varies depending on the wind direction, AUTO Sea performs the most suitable suppression processing. Land like islands can be displayed naturally. Since rain clouds outside sea clutter areas are recognized as land, there is no effect of suppressing rain / snow clutter.
AUTO Sea/Rain	: Along with AUTO Sea, AUTO Rain automatically detects the strength of rain / snow clutter, and performs the most suitable rain / snow clutter suppression processing. When rain clouds are scattered about, AUTO Rain performs rain / snow clutter suppression processing for only the rain-cloud areas. Since land is recognized as rain clouds, land videos become obscure.

page 2-[1]~[7] PL (Pulse Length)

- Sets the standard transmitter pulse length in each range.
- When the range is called, the pulse range is used.

page 3-[1]~[7] Video setting menu (Process Setting)

- Operation is the same as that of the Process Setting menu described in Section 3.8.1 "Set Radar Signal Processing (Process Setting)".

page 4-[1]~[7] Radar trails settings (Trails Setting)

- Same functions as in the Trails Setting of the RADAR Menu described in Section 3.8.2 "Set Radar Trails (RADAR Trails Setting)".

page 5-[1] Gain Offset

- Corrects gain while the function mode is called.
- Since the displayed noise level varies depending on the combination of the video process mode and the interference rejection level, gain needs fine adjustment for always obtaining the highest level.
- The gain correction function saves the correction value set by the gain adjust in each function mode, so it can obtain the highest gain without the gain adjust being operated when the function mode is changed.
- To set high gain, set a value on the “+” side.
- To set low gain, set a value on the “-” side.
- When the radar interference rejection level is increased, the noise level is lowered. Thus, set a gain correction value to the “+” side.
- When the video process mode **3Scan CORREL**, **4Scan CORREL**, or **5Scan CORREL** is used, the noise level is lowered. Thus, set a gain correction value to the “+” side.
- When the video process mode **Remain** or **Peak Hold** is used, noise is hard to disappear. Thus, set a gain correction value to the “-” side.

page 5-[2] PRF

- Same function as in the TXRX Setting described in Section 3.8.3 "Set Scanner Unit (TXRX Setting)".

page 5-[3] Small Buoy Detection

- Reduces the loss of signal processing during detection of small targets.

:Activates the general signal processing mode.

:Activates the small buoy detection mode that reduces the loss of signal processing.

page 5-[4] FishNet Detection

- Use this mode to detect small targets hidden by sea clutter returns.
- This function becomes more effective when the AUTO RAIN clutter suppression function is used together.

:Activates the general signal processing mode.

:Activates the fishnet detection mode.

page 5-[5] Antenna Height

- Set the height of radar antenna above sea level.
- The STC/FTC curve is changed.

: Set default

: Set the antenna height under 5m.

: Set the antenna height 5m to 10m.

: Set the antenna height 10m to 20m.

: Set the antenna height over 20m.

3.9.4 Overview of saved Function Setting Data

The overview of saved function setting data is as follows:

Factory-set data: : Saved data that general operation cannot change

Default data: : Standard data of each function mode that users can change

Data that can be called: : Saved data that can be called by pressing the [USER] key called:

Procedures

- 1) Open the User Function Setting menu by performing the menu operation below.

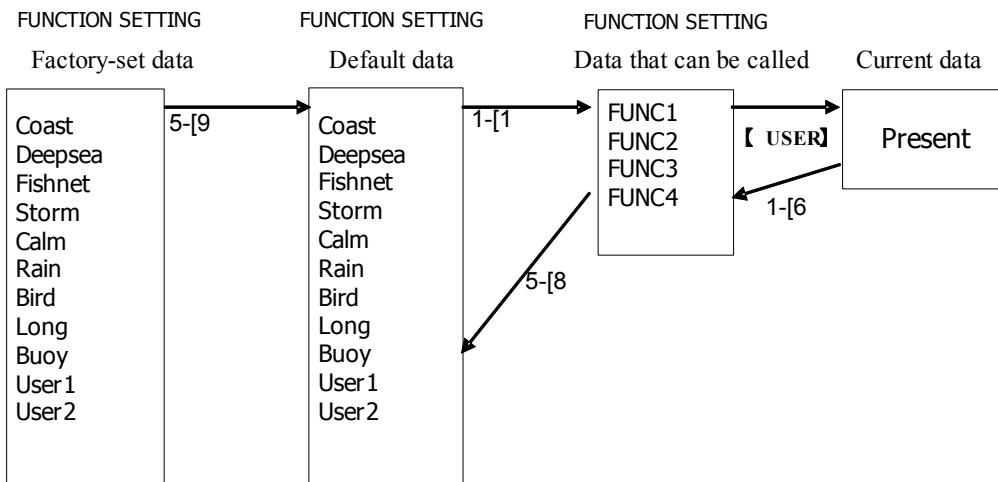
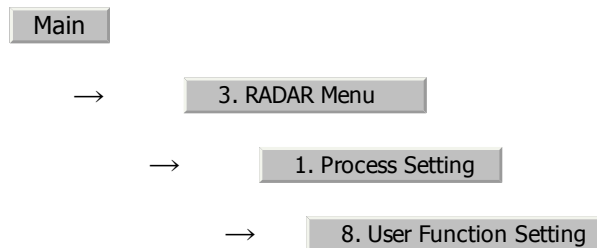

page 1-[1] Mode

- Calls the default value of the mode, and saves it for the function number.

page 1-[6] Save Present State

- The currently operating state can be saved for the function number.
- Use this function to save the state of good setting that will be frequently used.

page 5-[8] Set Mode Default

- Saves the setting of the current function number, as the default setting of the mode.

page 5-[9] Initialize

- Changes the memory contents of the mode, which is used with the current function number, back to the factory setting.

3.10 USE USER SETTING

The operation status of the radar is recorded. If the system is operated by more than one operator, the operators can register operation status as suitable for them and call the status. Operation status for up to five operations can be registered, and a name can be assigned to each status. (Up to 10 alphanumeric characters)

Data saved by the user setting
Display Color Setting
Buzzer Volume
Option Key Setting
Date Display Style
EBL/VRM Control CURS
Cursor Length

3.10.1 Save Operating State (Save User Setting)

The system's current operating state can be saved in the system by performing the operation below.

Procedures

- 1) **Open the Save User Setting menu by performing the menu operation below.**

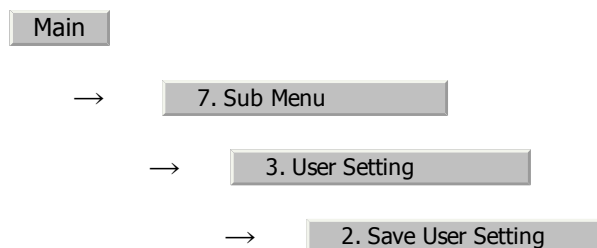

The Save User Setting menu will appear.

- 2) **Left-click the button for the file to be saved.**

The file name input screen will appear.

- 3) **Enter a file name to be saved.**

The Input File Name menu will appear.

On the numeric value input screen, enter a file name.

After the file name has been entered, the operating conditions will be saved.

3.10.2 Load Operating State (Load User Setting)

The operating state saved in the system can be loaded by performing the operation below.

When the operating state is loaded, the previous operating state data is discarded. Therefore, if you do not want to discard the operating state data, save the operating state by performing the operation described in Section 3.10.1 "Save Operating State (Save User Setting)".

Procedures

- 1) **Open the Load User Setting menu by performing the menu operation below.**

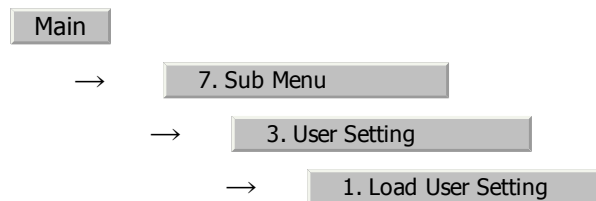

The Load User Setting menu will appear.

- 2) **Left-click the button for the file to be loaded.**

Confirmation Window will appear.

To load the file, left-click the **1. Yes** button.

3.10.3 Delete Operating State (Delete User Setting)

The operating state saved in the system can be deleted by performing the operation below.

Use this function to delete unnecessary operating state data.

Procedures

- 1) **Open the Delete User Setting menu by performing the menu operation below.**

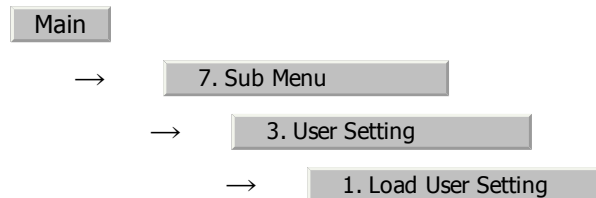

The Delete User Setting menu will appear.

- 2) **Left-click the button for the file to be deleted.**

Confirmation Window will appear.

To delete the file, left-click the **1. Yes** button.

3.11 USING CARD

This radar has two card slots. Inserting a flash memory card (option) into a card slot, you can save the following contents, saved in the processor, in the card or can load data from the card to the processor.

Trails of own ship: 7000 points maximum

Track of other ship: 20 target X 500 points

Mark/Line: 20000 points maximum

WPT: 512 points maximum

Route: 1 route maximum

These pieces of information can be saved in a flash memory card as a file. The internal capacity is as large as only a file. An internally created file can be saved until the flash memory card is full.

3.11.1 Operate File on the Card (File Manager)

Procedures

- 1) **Insert a flash memory card into the card slot.**

Flash memory card (option) is necessary.

- 2) **Set the radar in the standby state.**

While the radar is in the transmission state, the File Manager screen cannot be opened.

- 3) **Open the File Manager window by performing the menu operation below.**

Main

→

2. File Manager

The File Manager window will appear.

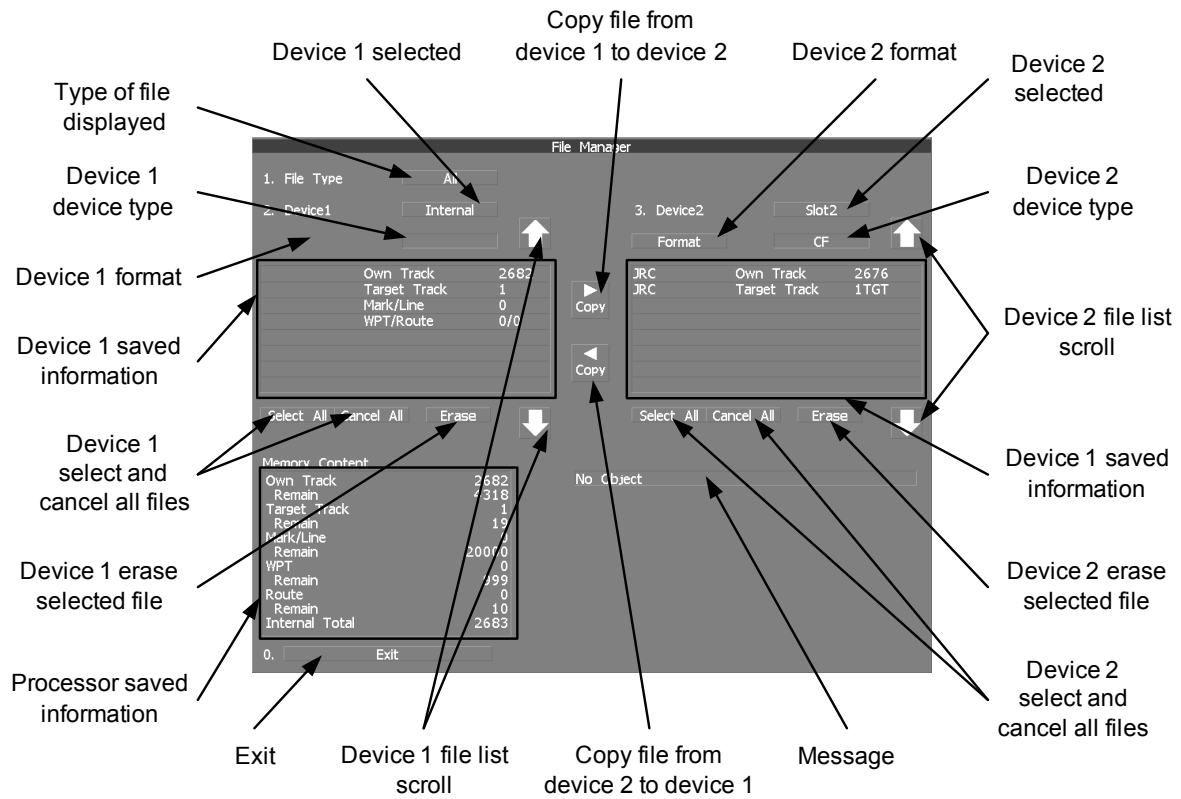

3

Information saved in the processor is displayed in the Memory Content.

Own Track	: Number of data points for own ship's track (7000 points maximum)
Remain	: Number of remaining data points of own ship's track that can be saved
Target Track	: The number of other ships' trails (up to 20 targets)
Remain	: The remaining number of other ships' trails to be saved
Mark/Line	: Number of mark and line points made with user map (up to 20000 items)
Remain	: Number of remaining data points of marks and lines that can be saved
WPT	: Number of data points of created waypoints (512 points maximum)
Remain	: Remaining waypoints that can be saved
Route	: Number of data points of created routes (1 route maximum)
Remain	: Remaining routes that can be saved
Internal Total	: Total number of data points

- The file name and data saved in the selected device will be displayed.
- Pressing the arrows located at the upper right and lower right of the file name list will scroll the list.

3.11.1.1 Copy Internal Information to Card (Copy Internal -> Card)

Procedures

- 1) **While the File Manager window is open, left-click the device 1 selection button.**

Selected items for Device1 will be displayed.

- 2) **Left-click the  button among the selection items.**

Internal is selected.

- 3) **Left-click the device 2 selection button.**

Selected items for Device2 will be displayed.

- 4) **Left-click button corresponding to the device to which data is to be copied.**

The list of files saved in the selected device will be displayed.

- 5) **Put the cursor on the data to be copied, and Left-click button.**

Left-click button one more time will cancel the selection.

- 6) **Left-click the  button.**

The character input screen for the Input File Name menu will appear.

- 7) **Enter the file name to be saved.**

Up to 10 characters can be entered. For the input method on the character input screen, see Section 3.3.4.7 "Entering a character".

After the data has been entered, Confirmation Window will appear.

- 8) **Left-click the  button.**

The entered name is written into the selected device as a file name.

Up to the maximum number of items, described on the previous page, can be saved in the device. With regard to the capacity for saving data, data can be saved on a flash memory card as a file, and those files can be saved until the flash memory card is full.

3.11.1.2 Load Information from Card to Internal Portion (Copy Card -> Internal)

Procedures

- 1) **While the File Manager window is open, left-click the device 1 selection button.**

Selected items for Device1 will be displayed.

- 2) **Left-click the  button among the selection items.**

Internal is selected.

- 3) **Left-click the device 2 selection button.**

Selected items for Device2 will be displayed.

- 4) **Left-click button corresponding to the device in which data to be loaded is saved.**

The list of files saved in the selected device will be displayed.

- 5) **Select the desired data.**

Left-click button one more time will cancel the selection.

- 6) **Left-click the  button.**

Confirmation Window will appear.

- 7) **Left-click the  button to overwrite data, or Left-click the  button to add new data.**

When Overwrite is selected, internally saved data is deleted and new data is loaded. When Add is selected, new data is added to the saved data.

- 8) **Left-click the  button.**

The selected file is loaded into the system from the card.

When adding data saved on the card to the data saved in the system, data can be copied from multiple files. However, when the maximum number of units of data is reached, additional data cannot be loaded. Even in the ADD mode, WPT data and Route data are overwritten.

3.11.1.3 Copy Information (Copy)

Procedures

- 1) **While the File Manager window is open, left-click the device 1 selection button.**

Selected items for Device1 will be displayed.

- 2) **Left-click the button corresponding to the device from which data is to be copied.**

The list of files saved in the selected device will be displayed.

- 3) **Left-click the device 2 selection button.**

Selected items for Device2 will be displayed.

- 4) **Left-click button corresponding to the device to which data is to be copied.**

The list of files saved in the selected device will be displayed.

- 5) **Put the cursor on the data to be copied, and Left-click button.**

Left-click button one more time will cancel the selection.

- 6) **Left-click the  button.**

The character input screen for the Input File Name menu will appear. If there is a file having the same name, the file selection window will appear.

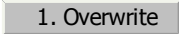
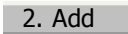
- 7) **When deleting saved data and copying new data, left-click  to select Overwrite. When adding data to a destination file, left-click  to select Add. Even in the Add mode, WPT data and Route data are overwritten. When selection has been made, Confirmation Window will appear.**

- 8) **Enter the file name to be saved.**

Up to 10 characters can be entered. For the input method on the character input screen, see Section 3.3.4.7 "Entering a character"

After the data has been entered, Confirmation Window will appear.

- 9) **Left-click the  button.**

The entered name is written into the selected device as a file name.

3.11.1.4 Erase File (Erase)

Procedures

- 1) **While the File Manager window is open, left-click the device 1 selection button.**

Selected items for Device1 will be displayed.

- 2) **Left-click button corresponding to the device in which data to be erased is saved.**

The list of files saved in the selected device will be displayed.

- 3) **Select data to be erased.**

Left-click button one more time will cancel the selection.

- 4) **Left-click  button.**

Confirmation Window will appear.

- 5) **Left-click the  button.**

The selected file will be erased.

3.11.1.5 Initializing a card (Format)

Procedures

- 1) **While the File Manager window is open, left-click the device 1 selection button or the device 2 selection button.**

Selection items for Device1 or Device2 will appear.

- 2) **Left-click the button which corresponds to the system (device) where data to be displayed is saved.**

The File Manager window will appear.

- 3) **Put the cursor on  for the device to be initialized, and Left-click button.**

Confirmation Window will appear.

- 4) **Left-click the  button.**

Initialization will be executed.

3.11.1.6 Showing data saved on the card (Show Card)

Procedures

- 1) **While the File Manager window is open, left-click the device 1 selection button.**

Selected items for Device1 or Device2 will be displayed.

- 2) **Left-click button corresponding to the device in which data to be displayed is saved.**

The list of files saved in the selected device will be displayed.

Exit

- 1) **Left-click the  button.**

The File Manager menu will close.

SECTION 4

MEASUREMENT OF RANGE AND BEARING

MEASUREMENT OF RANGE AND BEARING

4.1	USE OF NAVIGATION TOOLS	4-1
4.1.1	Using Cursor (Cursor)	4-2
4.1.2	Using Range Rings (Range Rings)	4-2
4.1.3	Using Electronic Bearing Line (EBL1/EBL2)	4-3
4.1.4	Using Parallel Index Lines (PI Menu)	4-8
4.1.5	Operating EBL Maneuver Function (EBL Maneuver Setting)	4-14
4.1.6	Operating EBL, VRM, and PI with Cursor	4-16
4.2	MEASUREMENT OF RANGE AND BEARING	4-19
4.2.1	Measurement with Cursor Position (Cursor)	4-19
4.2.2	Measurement with Electronic Bearing Line and Variable Range Marker [EBL] [VRM]	4-20
4.2.3	Measurement with Two Arbitrary Points	4-21

4.1

USE OF NAVIGATION TOOLS

The system is equipped with the navigation tools below.

- Cursor:** Specifies an arbitrary point, and measures the range and bearing from the own ship.
- Range Rings:** Displays concentric circles with own ship's position as the center at specified intervals, and the rings are used as rough guides for range measurement.
- Electronic Bearing Line (EBL1/2):** Displays a straight line for specifying an arbitrary bearing, and measures the bearing from the own ship. The process unit is equipped with two electronic bearing lines.
- Variable Range Marker (VRM1/2):** Displays a circle for specifying an arbitrary range, and measures the range from the own ship. The process unit is equipped with two variable range markers.
- Parallel Index Line (PI):** Displays straight lines at even intervals, and the lines are used as rough guides for complex measurement or ship courses.
- EBL Maneuver:** Displays the course by steering the own ship, and it is used as a rough guide for ship maneuvering.
- Man Overboard:** Stores the latitude and longitude where the own ship was at the point of storing the markers, and shows an anchor symbol on the radar display. When the own ship has moved, the system displays the range and bearing to the position. Use this tool when the ship is anchored or man overboard.
- EBL/VRM/PI Operation with Cursor (Cursor AUTO):** Operates EBL, VRM, or PI on the radar display by using the cursor.

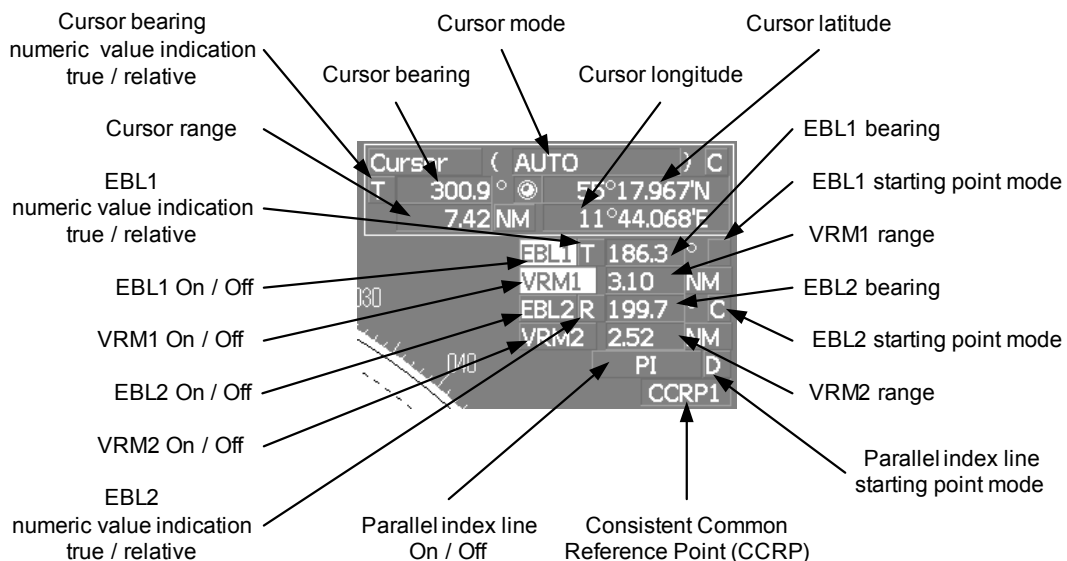

4.1.1 Using Cursor (Cursor)

Procedures

- 1) Move the cursor onto the PPI display by moving the trackball.

When the cursor is moved onto the PPI display, the arrow cursor turns into a cross cursor.

4.1.2 Using Range Rings (Range Rings)

Procedures

- 1) Left-click the **Rings** button on upper left area on the display.

Range rings display On / Off

Range rings interval

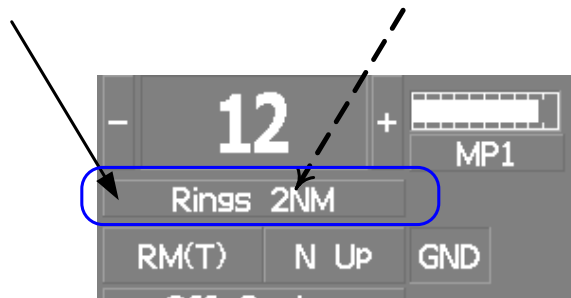

The range ring display switches disappear and appear between display and non-display each time the **Rings** button is clicked. The range ring interval is shown in the **Rings** button.

The range between the target and own ship can be determined by visually measuring the target's position that lies between two range rings.

For change of the brilliance of range rings, refer to Section 3.8.5 "Set Radar Display (Display Setting)".

4.1.3 Using Electronic Bearing Line (EBL1/EBL2)

Electronic bearing lines (EBL) are indispensable to the measurement of bearings.

Operators must be familiar with the operation of EBL beforehand.

The system is equipped with two EBL. The bearing and starting point of an EBL can be operated separately from the other EBL.

An intersection marker is displayed at the intersection point of the EBL and VRM of the same number.

Intersection markers shown on EBL:

○: EBL1, VRM1

●: EBL2, VRM2

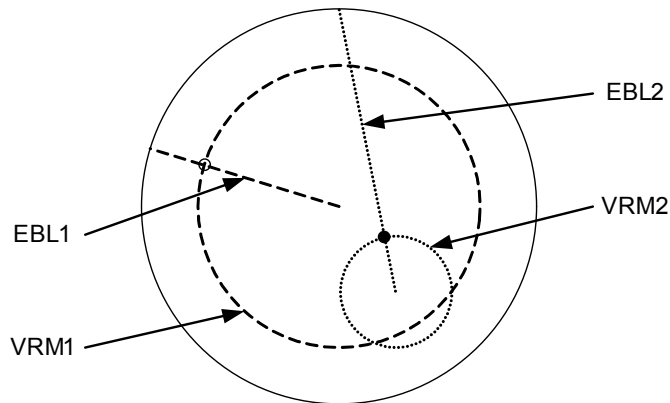

EBL Bearing Display

The bearing value of the current or on the PPI display is shown in the upper right of the display.

The currently operable or is highlighted in the upper right of the display.

Starting Point of EBL

The starting point of the currently operating EBL can be switched from the center of the radar display to any offset position. The offset position of the EBL starting point can be fixed on the radar display or at the latitude and longitude. (The setting of the navigator is necessary for fixing the offset position at the latitude and longitude.)

4.1.3.1 Operating EBL (EBL)

Procedures

- 1) **Press the [EBL1] or [EBL2] key.**

The EBL button (located at the upper right of the display) will be highlighted, and the selected EBL becomes operable.

Turn the [EBL] dial.

To turn the [EBL] dial to the right, turn the EBL control clockwise; to turn the [EBL] dial to the left, turn the EBL control counterclockwise.



Cancel

- 1) **Press the [EBL1] or [EBL2] key again.**

The selected EBL display will disappear.



4.1.3.2 Moving the Starting Point of EBL

The system provides three types of EBL starting points. Select one of them in accordance with purpose.

-  : The EBL starting point is defined as the own ship's position.
-  : The EBL starting point is moved and fixed on the radar display.
-  : The EBL starting point is moved and fixed at the latitude and longitude. (The navigator needs to be connected.)

[1] To move the starting point of EBL

Procedures

- 1) **Make EBL1 or EBL2 operable.**
- 2) **Press the [EBL] dial to set  or  for the EBL1 / EBL2 starting point mode switching located at the upper right of the display.**

The selected EBL starting point mode is switched as shown below each time the dial is pressed.

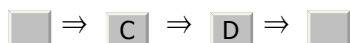

- 3) **Put the cursor on the EBL starting point is to be moved, and left-click.**

The selected EBL starting point will be determined.

[2] To return the EBL starting point to own ship's position

Procedures

- 1) Make EBL1 or EBL2 operable.
- 2) Press the [EBL] dial to set  for the EBL1 / EBL2 starting point mode switching located at the upper right of the display.

The selected EBL starting point will be set as the own ship's position.



4.1.3.3 Setting EBL Operation Mode

[1] To set the numeric value display mode of EBL (EBL Bearing REF)

Determine whether to display EBL in true bearing mode or relative bearing mode.

Procedures

- 1) Put the cursor on the EBL1/2 numeric value indication true / relative switching (located at the upper right of the display), and left-click.

The selected mode is switched as shown below each time the left button is clicked.  ⇒  ⇒ 

 :EBL bearing is displayed in true bearing mode.

 :EBL bearing is displayed in relative bearing mode.

[2] To set a mode for fixing EBL display (EBL Bearing Fix)

When this function is set to Angle , an EBL is fixed to the preset bearing. For example, if a true bearing of 020° is preset, the EBL is fixed to the true bearing 020° even when the own ship turns.

When the function is set to Screen , the EBL is fixed on the radar display. In this case, the EBL is always fixed to the same bearing on the display when the own ship turns.

Procedures

- 1) **Open the EBL/Cursor Setting menu by performing the following menu operation.**

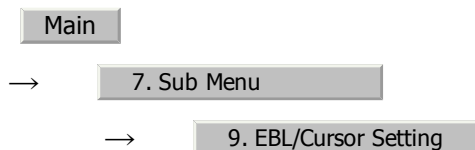

- 2) **Left-click at the item button**

of **1. EBL1 Bearing FIX** or **2. EBL2 Bearing FIX** .

Angle :EBL bearing is fixed to the preset value.

Screen :EBL bearing is fixed on the radar display.



Course data is necessary for turning on this function.

Variable range markers (VRM) are indispensable to the measurement of ranges. Operators must be familiar with the operation of VRM beforehand.

The system is equipped with two VRM. The VRM can be operated separately from each other.

An intersection marker is displayed at the intersection point of the VRM and EBL of the same number.

When the starting point of an EBL is offset, the center of the VRM is defined as the offset EBL starting point.

Intersection markers shown on VRM:

○ : EBL1, VRM1

● : EBL2, VRM2

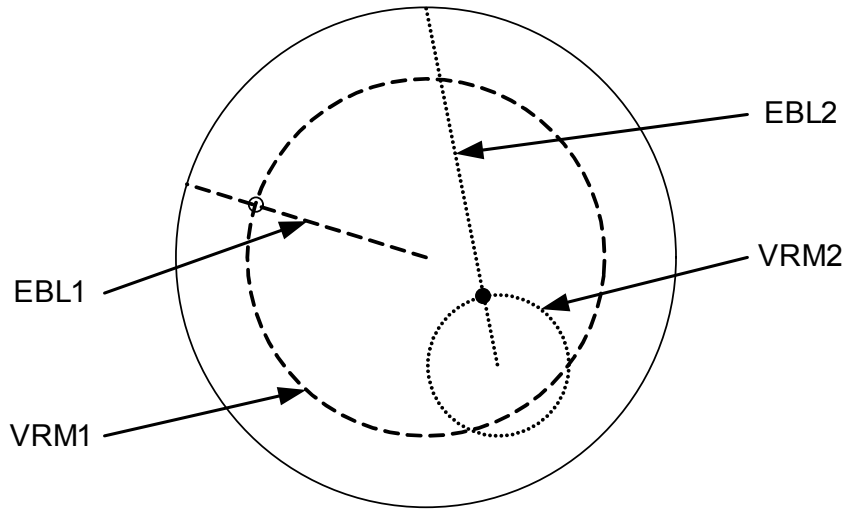

VRM Operation

The range value of the current or on the PPI display is shown in the VRM1/2 range located at the upper right of the display. The currently operable VRM1 or VRM2 is highlighted in the button located at the upper right of the display.

4.1.3.4 To operate VRM (VRM)

Procedures

- 1) **Press the [VRM1] or [VRM2] key.**

The and buttons (located at the upper right of the display) will be highlighted, and the selected VRM becomes operable.

- 2) **Turn the [VRM] dial.**

To turn the [VRM] dial to the right, the VRM control wide, to turn the [VRM] dial to the left, the VRM control narrow.

Cancel

- 1) **Press the [VRM1] or [VRM2] key again.**

The selected EBL display will disappear.

4.1.4 Using Parallel Index Lines (PI Menu)

Parallel index lines can be displayed.

4.1.4.1 Operating Parallel Index Lines (PI)

Procedures

1) **Press the [VRM] dial.**

Parallel index lines and the PI Menu will appear.

To change the bearing of parallel index lines, turn the [EBL] dial, to change the line interval, turn the [VRM] dial.

The bearing and interval of parallel index lines are displayed in the PI Menu.

2) **Press the [VRM] dial again.**

The parallel index lines will be fixed.



Parallel index lines are operable only while the PI Menu is displayed. When the menu is closed, the parallel index line display remains, but the settings of the bearing and interval cannot be adjusted any more. To adjust the bearing and interval after closing the menu, press the [VRM] dial twice to open the PI Menu.

Cancel

1) **Press the [VRM] dial again.**

The parallel index line display will disappear.

4.1.4.2 Operation of Parallel Index Lines

- Parallel index lines rotate in the same direction as you turn the [EBL] dial. (①, ②)
- The intervals of parallel index lines narrow when you turn the [VRM] dial counterclockwise (③), and widen when you turn the [VRM] dial clockwise (④).
- When the [VRM] dial is pressed, the PI Menu closes and the parallel index lines are fixed.

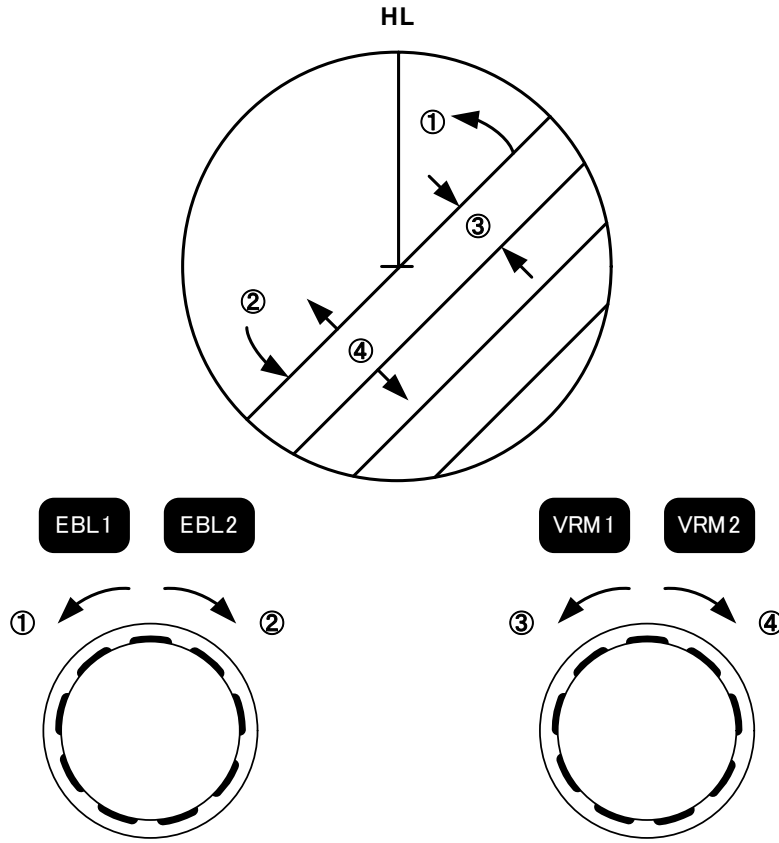

During the operation of parallel index lines, pressing the [EBL1] or [EBL2] key disables operation for rotation directions. Pressing the [VRM1] or [VRM2] key disables operation for parallel index line intervals.

4.1.4.3 Settings in PI Menu (PI Menu)

The operation of parallel index lines can be set in the PI Menu.

Procedures

- 1) Left-click the button to open the PI menu.

[1] Display for All Lines

Sets the parallel index line display to on or off.

:Parallel index lines are displayed.

:Parallel index lines are not displayed.

[2] Operation Mode

Sets an operation mode for parallel index lines.

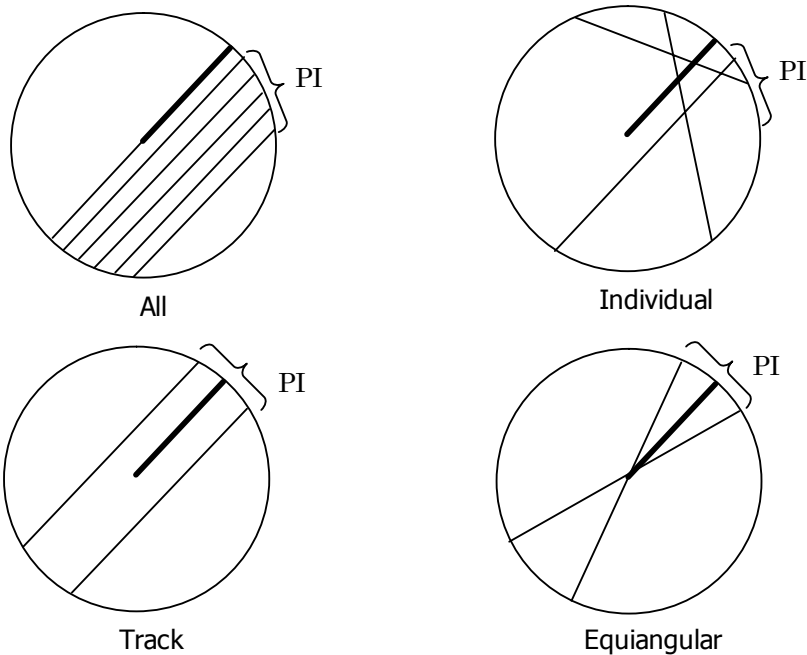

All :All the parallel lines are operated at the same time.

Individual :The bearing of each line is operated individually.

Track :Equally spaced lateral lines are displayed on both sides.

Equiangular :Two lines intersecting at the center of a circle are displayed.

a. Operation if **Individual** is selected

- A line perpendicular to the own ship and the intersection marker "----○" are displayed on an operable line.
- Turning the [EBL] dial changes the direction.
- Pressing the [VRM] dial changes the range, end point 1, or end point 2 to be operated.
- An operable point is displayed with "●" and can be operated by turning the [VRM] dial.
- If Sequential is selected for [3] Control, the parallel index lines of the next number can be displayed by pressing the [EBL] dial.
- To close the menu, left click **0.Exit** software button.

b. Operation if **Equiangular** is selected

- Select a group of lines to be operated according to the setting of [3] Control.
- Pressing the [EBL] dial switches between the direction change mode and elevation-angle change mode. Turning the [EBL] dial changes the direction or elevation angle.

[3] Control

Determines whether to operate all the lines at the same time. The setting items are determined by the setting of Section [2] "Operation Mode".

a. If All is selected

The setting cannot be changed.

All :All the lines are operated at the same time.

b. If Individual is selected

Determine whether to set consecutive lines or individual lines.

Sequential :Lines are operated sequentially.

Index Line1 to Line8 :A specified line is operated.

c. If Track or Equiangular is selected

Select a group of lines to be operated.

Group1 to Group4 :A specified group is operated.

[4] Floating

Moves the center point of parallel index lines.

Off :The starting point of parallel index lines is defined as the own ship's position.

Screen Fix :The center of parallel index lines is moved and fixed on the radar display.

L/L Fix :The center of parallel index lines is moved and fixed at the latitude and longitude. (The navigator needs to be connected.)

[5] Heading Link

Determines whether to operate parallel index lines following the heading bearing.

On :Parallel index lines are operated following the heading bearing.

Off :Parallel index lines are not operated following the heading bearing.

[6] Next

Moves to the next page.

[7] Range Scale Link

Determines the operation of parallel index line intervals when the range is changed.

On :The intervals are fixed with the actual range (nm). The appearance of parallel index line intervals changes when the range is changed.

Off :The intervals are fixed with the display range. The parallel index line intervals (nm) change when the range is changed.

[8] Reference Bearing

Sets a reference bearing for the numeric data display of parallel index lines. The setting items are determined by the setting of Section [2] "Operation Mode"

a. If **All is selected**

True :Displayed with true bearing (with North as reference).

HL :Displayed with the heading line as reference.

b. If **Individual is selected**

True :Displayed with true bearing (with North as reference).

HL :Displayed with the heading line as reference.

Index Line1 to **Line8** :Displayed with a specified line as reference.

c. If **Track** is selected

True : Displayed with true bearing (with North as reference).

HL : Displayed with the heading line as reference.

Index Line1 to **Line8** : Displayed with a specified line as reference.

Line1, Line3, Line5 and Line7 correspond to Group1, Group2, Group3 and Group4, respectively.

Line1	↔	Group1
Line3	↔	Group2
Line5	↔	Group3
Line7	↔	Group4

d. If **Equiangular** is selected

The setting cannot be changed.

[9] Operation Area

If All is selected for Section [2] "Operation Mode", this function sets an area for displaying parallel index lines.

One Side :Parallel index lines are displayed only on one side.

Both Side :Parallel index lines are displayed on both sides.

[10]Display for Individual Line

Determines whether to turn on / off the parallel index line display of a selected number.

On :The line of the selected number is displayed.

Off :The line of the selected number is not displayed.

If **All** is selected for Section [2] "Operation Mode", the line near the own ship is **Index Line1**.

If **Track** or **Equiangular** is selected for Section [2] "Operation Mode", Line1, Line3, Line5 and Line7 correspond to Group1, Group2, Group3 and Group4, respectively.

Line1	↔	Group1
Line3	↔	Group2
Line5	↔	Group3
Line7	↔	Group4

4.1.5 Operating EBL Maneuver Function (EBL Maneuver Setting)

4.1.5.1 Initial Setting (EBL Maneuver Setting)

Procedures

- 1) Open the EBL Maneuver Setting menu by performing the following menu operation.

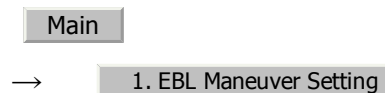

- 2) Set the following parameters.

Reach :Set the range from when the rudder is steered to when the ship begins to turn.

Turn Mode :Select a turn mode.

Radius :Turning radius (NM)

Rate :Rate of turn (deg/min)

Turn Set :Select the setting for turning.

If **Radius** is selected :Turning radius (NM)

If **Rate** is selected :Rate of turn (deg/min)

For inputs to the value input screen, refer to Section 3.3.4 "Operation on Numeric Value, Latitude / Longitude and Character Input menu".

 A wrong initial setting affects the maneuver curve function explained below.

4.1.5.2 Creation of Maneuver Curve (EBL Maneuver)

Procedures

- 1) **Left-click the item button of 1. EBL Maneuver while the EBL Maneuver Setting menu is open.**

The EBL maneuver function will be set to on or off.

A auxiliary line for maneuver curve creation, a maneuver curve, and a WOL will appear on the radar display.

- 2) **Put the cursor on the starting point of the auxiliary line, and set the bearing of the auxiliary line by operating the [EBL] dial.**

The bearing of the auxiliary line is the final bearing in which the own ship is to move.

The WOL position varies depending on the bearing of the auxiliary line.

If the WOL is behind the CCRP, the line color of WOL will change.

- 3) **Left-click.**

The setting will be determined. However, if the WOL is behind the CCRP position at this point, left-clicking is rejected, and the setting is not determined.

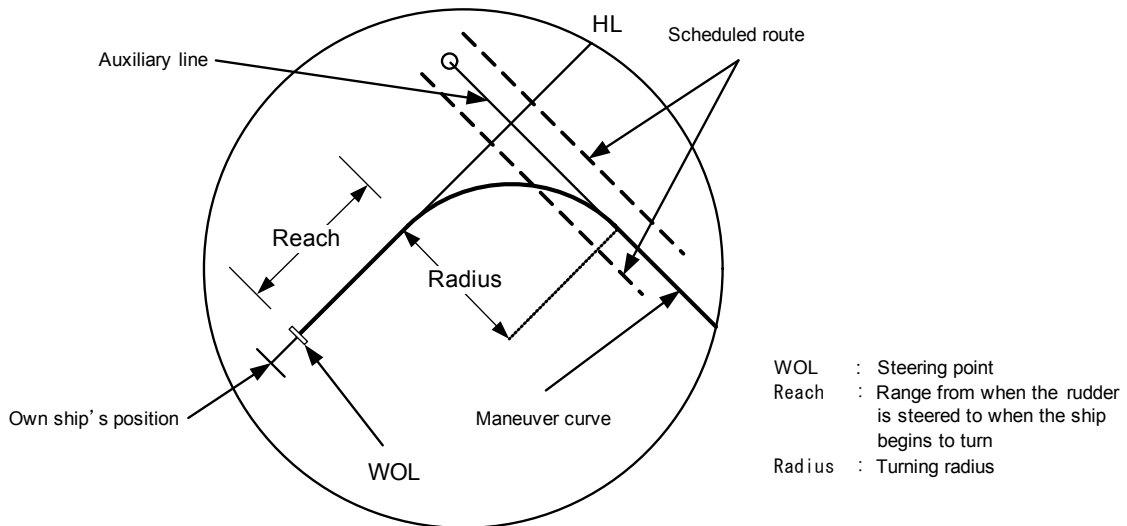

4.1.6 Operating EBL, VRM, and PI with Cursor

When the cursor mode is set to **AUTO** (located at the upper right of the display), EBL, VRM, and PI can be operated simply by using the trackball.

4.1.6.1 Operating Electronic Bearing Line (EBL)

Procedures

- 1) **Put the cursor on EBL1 or EBL2, and left-click.**

When the cursor is moved to it, EBL1 or EBL2 is shown at the upper right of the cursor. The EBL becomes operable when left-clicking. カーソルを合わせるとカーソル右上に **EBL1** または **EBL2** が表示されます。左クリックすると操作状態になります。

- 2) **Move the cursor to the bearing to be set.**

The EBL will move as the cursor moves.

- 3) **Left-click.**

The EBL will be fixed.

4.1.6.2 Operating Variable Range Marker (VRM)

Procedures

- 1) **Put the cursor on VRM1 or VRM2, and left-click.**

When the cursor is moved to it, **VRM1** or **VRM2** is shown at the upper right of the cursor. The VRM becomes operable when left-clicking.

- 2) **Move the cursor to the range to be set.**

The VRM will move as the cursor moves.

- 3) **Left-click.**

The VRM will be fixed.

4.1.6.3 Operating EBL and VRM Concurrently (EBL · VRM)

Procedures

- 1) **Put the cursor on the intersection marker (◯ or ●), and left-click.**

When the cursor is moved to it, **EBL1** **VRM1** or **EBL2** **VRM2** is shown at the upper right of the cursor. The EBL and VRM become operable when left-clicking.

- 2) **Move the cursor to the bearing / range to be set.**

The EBL and VRM will move as the cursor moves.

- 3) **Left-click.**

The EBL and VRM will be fixed.

4.1.6.4 Operating Parallel Index Lines (PI)

[1] To change the direction of parallel index lines

Procedures

- 1) **Put the cursor on near the center of line, and left-click.**

When the cursor is moved there, it will turn into  and **PI** will be displayed at the upper right of the cursor. The parallel index lines become operable when left-clicking.

- 2) **Move the cursor to the direction to be set.**

The parallel index lines will change the direction as the cursor moves.

- 3) **Left-click.**

The parallel index lines will be fixed.

[2] To change parallel index line intervals

Procedures

- 1) **Put the cursor on near the end of line, and left-click.**

When the cursor is moved there, it will turn into \Leftrightarrow and **PI** will be displayed at the upper right of the cursor. The parallel index lines become operable when left-clicking.

- 2) **Move the cursor to the interval to be set.**

The parallel index lines interval will change as the cursor moves.

If Individual is selected for Operation Mode, the parallel index lines move.

- 3) **Left-click.**

The parallel index lines will be fixed.

[3] To change the end points of parallel index lines

If Individual is selected for Operation Mode, the length of parallel index lines can be changed.

Procedures

- 1) **Put the cursor on the end point of parallel index lines, and left-click.**

When the cursor is moved there, it will turn into \Leftrightarrow and **PI** will be displayed at the upper right of the cursor. The parallel index lines become operable when left-clicking.

- 2) **Move the cursor to the position to be set.**

The position of the end point will change as the cursor moves.

- 3) **Left-click.**

The parallel index lines will be fixed.

4.2 MEASUREMENT OF RANGE AND BEARING

4.2.1 Measurement with Cursor Position (Cursor)

Procedures

- 1) Make sure of the target echoes on the radar display.
- 2) Move the cursor to the target.

The bearing and range of the target will be shown in the Cursor bearing / range located at the upper right of the display. The range is a distance from the own ship's position.

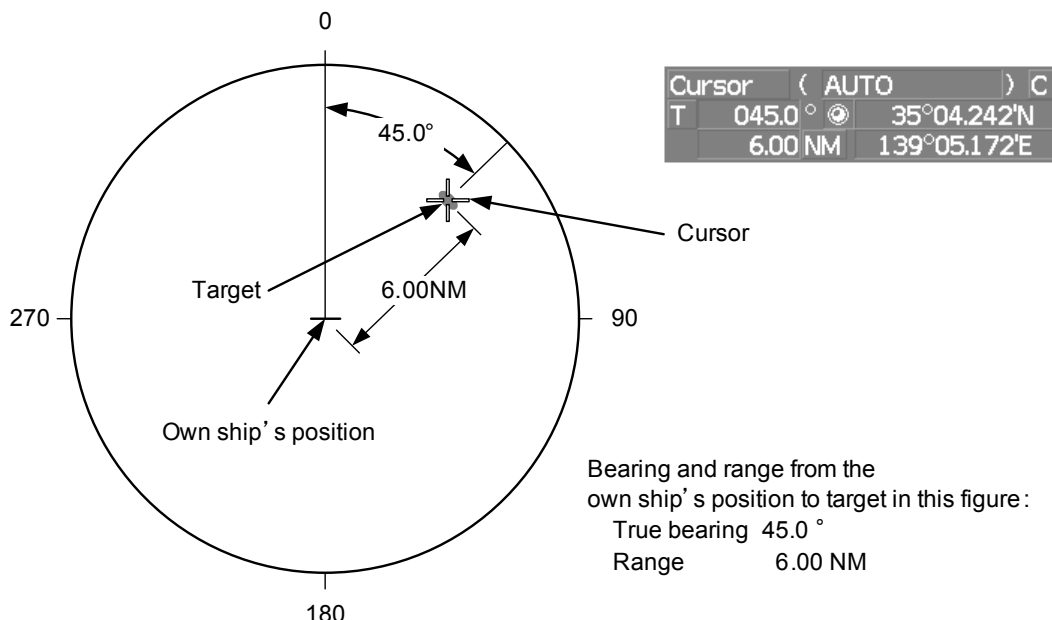

4.2.1.1 To set a cursor bearing numeric value mode

Determine whether to display a cursor bearing in true or relative bearing mode.

Procedures

- 1) Put the cursor on the Cursor bearing numeric value indication true / relative switching (located at the upper right of the display), and left-click.

The selected mode is switched as shown below each time left-clicking.

T ⇒ **R** ⇒ **T**

T :Cursor bearing is displayed in true bearing mode.

R :Cursor bearing is displayed in relative bearing mode.

4.2.2 Measurement with Electronic Bearing Line and Variable Range Marker [EBL] [VRM]

Procedures

- 1) Press the [EBL1] key.

The **EBL1** (located at the upper right of the display) will be highlighted, and EBL1 will be shown with a dotted line on the PPI display.

- 2) Move the EBL1 to the target by turning the [EBL] dial.

The EBL1 bearing will be shown in the EBL1 bearing (located at the upper right of the display). The EBL1 bearing is the bearing of the target.

- 3) Press the [VRM1] key.

The **VRM1** (located at the upper right of the display) will be highlighted, and VRM1 will be shown with a dotted line on the PPI display.

- 4) Move the VRM1 to the target by turning the [VRM] dial.

The range of VRM1 from the own ship's position will be shown in the VRM1 range located at the upper right of the display.

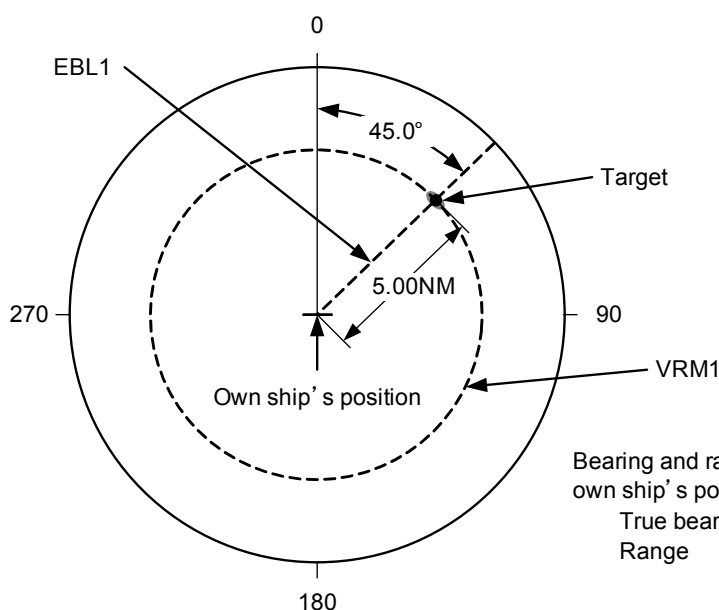
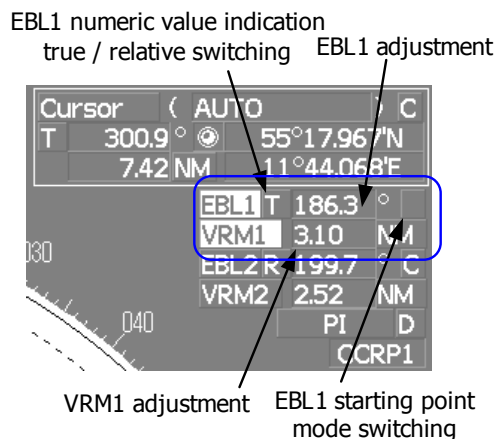

Bearing and range from the own ship's position to target in this figure:
True bearing 45.0 °
Range 5.00 NM

4.2.3 Measurement with Two Arbitrary Points

Procedures

- 1) Press the [EBL2] key.

The **EBL2** (located at the upper right of the display) will be highlighted, and EBL2 will be shown on the PPI display.

- 2) Press the [EBL] dial to select **C** for the EBL2 starting point mode switching located at the upper right of the display.

- 3) Put the cursor on the point **A** of the two points between which measurement is made, and left-click.

Refer to the figure below.

- 4) Move the EBL2 to the other point **B** by turning the [EBL] dial.

- 5) Press the [VRM2] key.

When VRM2 is selected, • (intersection marker) will appear on the dotted line of EBL2.

- 6) Move the intersection marker on the dotted line to point **B** by turning the [VRM] dial.

The range and bearing between the two points will be shown in the VRM2 range and EBL2 bearing (located at the upper right of display).

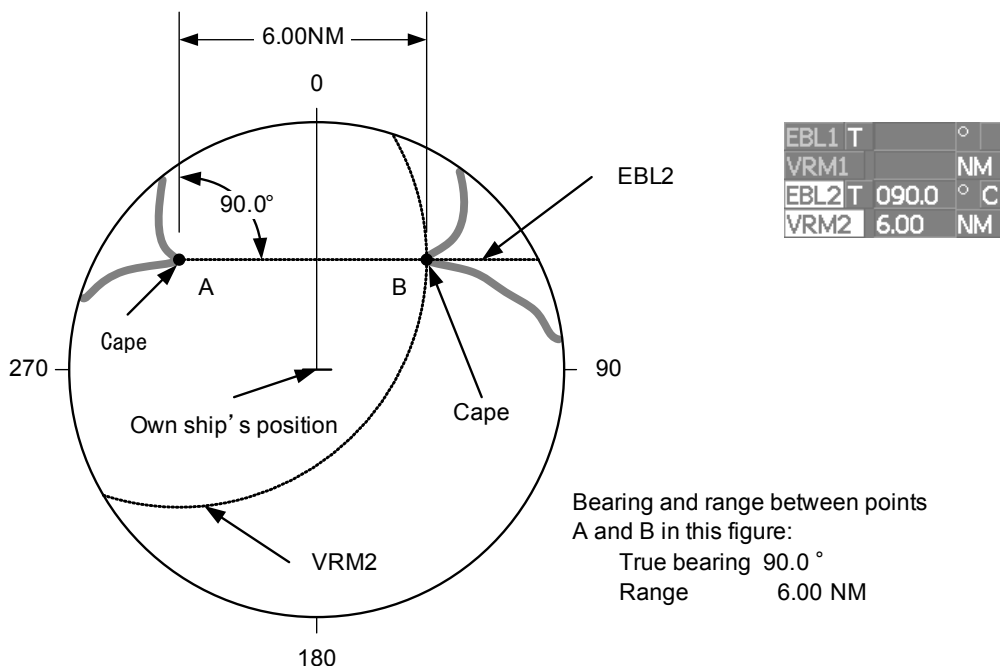

Similarly, EBL1 can also be used for measuring the bearing and range between two points. In this case, perform the above procedure reading EBL2 as EBL1 and VRM2 as VRM1.



SECTION 5

OPERATION OF TARGET TRACKING AND AIS

OPERATION OF TARGET TRACKING AND AIS

5.1	PREPARATION	5-1
5.1.1	Collision Avoidance	5-2
5.1.2	Definitions of Symbols	5-5
5.1.3	Radar Display	5-8
5.1.4	Cursor Modes (Cursor)	5-10
5.1.5	Setting Collision Decision Criteria	5-12
5.1.6	Setting Vectors (Vector Time)	5-13
5.1.7	Setting the GPS antenna location	5-13
5.2	TARGET TRACKING OPERATION	5-14
5.2.1	Acquiring Target [ACQ]	5-14
5.2.2	Canceling Unwanted Tracked Targets [ACQ CANCEL]	5-16
5.2.3	Tracked Target Data Display [TGT DATA]	5-17
5.2.4	Displaying Target ID No.(Target Number Display)	5-18
5.2.5	Adding Tracked Target ID Name (Name)	5-19
5.2.6	Reference Target (Reference)	5-20
5.2.7	Operation Test (TT Test Menu)	5-21
5.3	AIS OPERATION	5-26

5.3.1	Restrictions	5-26
5.3.2	Setting AIS Display Function (AIS Function)	5-26
5.3.3	Activate AIS Targets (Activate AIS)	5-27
5.3.4	Deactivate AIS Targets (Deactivate AIS)	5-27
5.3.5	Displaying AIS Information [TGT DATA]	5-28
5.3.6	Displaying Target ID No. (Target Number Display)	5-31
5.3.7	Setting AIS Filter (AIS Filter Setting)	5-32
5.3.8	Conditions for Deciding AIS Target to be Lost	5-35
5.3.9	Setting Conditions for AIS Alarm (AIS Alarm Setting)	5-36
5.4	DECISION OF TARGETS AS IDENTICAL (Association)	5-37
5.4.1	Setting of Function to Decide Targets as Identical (Association)	5-37
5.4.2	Setting of Conditions for Deciding AIS and Tracked Targets as Identical (Association Setting)	5-37
5.4.3	Types of Decision Conditions to be Set	5-38
5.5	ALARM DISPLAY	5-39
5.5.1	CPA / TCPA Alarm	5-40
5.5.2	Alarm for New Target Acquired in Automatic Acquisition Zone (New Target)	5-41
5.5.3	Lost Target Alarm (Lost)	5-41
5.5.4	Gyro Set Alarm	5-42
5.6	TRACK FUNCTION	5-43
5.6.1	Past Position (Past POSN)	5-43
5.6.2	Target Ship's Tracks (Target Track)	5-44
5.7	TRIAL MANEUVERING (Trial Maneuver)	5-53
5.7.1	Trial Maneuvering in the True Vector Mode	5-54
5.7.2	Trial Maneuvering in the Relative Vector Mode	5-55
5.7.3	Operation of Trial Maneuvering Function	5-56

5.1 PREPARATION

Attention

- There are the following limitations on use of the target acquisition and target tracking functions.

[I] Resolution between adjacent targets and swapping during automatic target tracking

Depending on the particular distance and echo size, resolution between adjacent targets during automatic target tracking usually ranges somewhere between 0.03 to 0.05 NM. If multiple targets approach each other, resolution will become about 0.05 NM and this may cause the system to regard them as one target and thus to swap them or lose part of them. Such swapping or loss of targets may also occur if the picture of the target being tracked is affected by rain/snow clutter returns or sea clutter returns or moves very close to land.

[II] Intensity of echoes and the target tracking function

The intensity of echoes and the tracking function have a relationship, and thus the target will be lost if no echoes are detected during six scans in succession. If a lost target exists, therefore, radar gain must be increased to support detection of the target. If, however, radar gain is increased too significantly, sea clutter returns or other noise may be erroneously detected and tracked as a target, and resultingly, a false alarm may be issued.

[III] Adverse effects of error sources on automatic tracking

To execute accurate tracking, it becomes necessary first to appropriately adjust the [GAIN], [SEA] and [RAIN] dials of the radar so that the target to be acquired and tracked is clearly displayed on the radar display. Inappropriate settings of these adjustments reduce the reliability / accuracy of automatic tracking.

This section explains the features of the target tracking and AIS functions, and the initial setting for using each function.

Target Tracking Function

The target tracking function calculates the course and speed of a target by automatically tracking the target's move.

The target tracking function enables the automatic acquisition of targets by using the automatic acquisition zone function.

The target tracking function also enables the simulation of the ship maneuvering method to avoid collisions by using the trial maneuver function.

If the mode is ground stabilization, SOG/COG used for own ship's information in target tracking. If the mode is sea stabilization, SPD (speed through the water) / HDG (heading) used for own ship's information in target tracking.

AIS (Automatic Identification System) function

The AIS function shows the target's information on the radar display, using other ship's information sent out from the AIS unit.

5.1.1 Collision Avoidance

5.1.1.1 Problems of Collision Avoidance in Navigation

Marine collision avoidance is one of the problems that have been recognized from of old. Now, it will be described briefly who the collision avoidance is positioned among the navigational aid problems.

The navigation pattern of all mobile craft constitutes a system with some closed loops regardless of the media through which the mobile craft travels, whether air, water, the boundary between air and water, or space. This pattern consists of two closed loops in principle, one of which is a collision with another mobile craft and the other is a loop of finding a right and safe way to reach a predeterminate destination. Fig. 5-1 shows the conceptual diagram of navigation pattern by MR. E.W. Anderson. The closed loop of collision avoidance is shown on the left side and the closed loop of finding a right course on the right side.

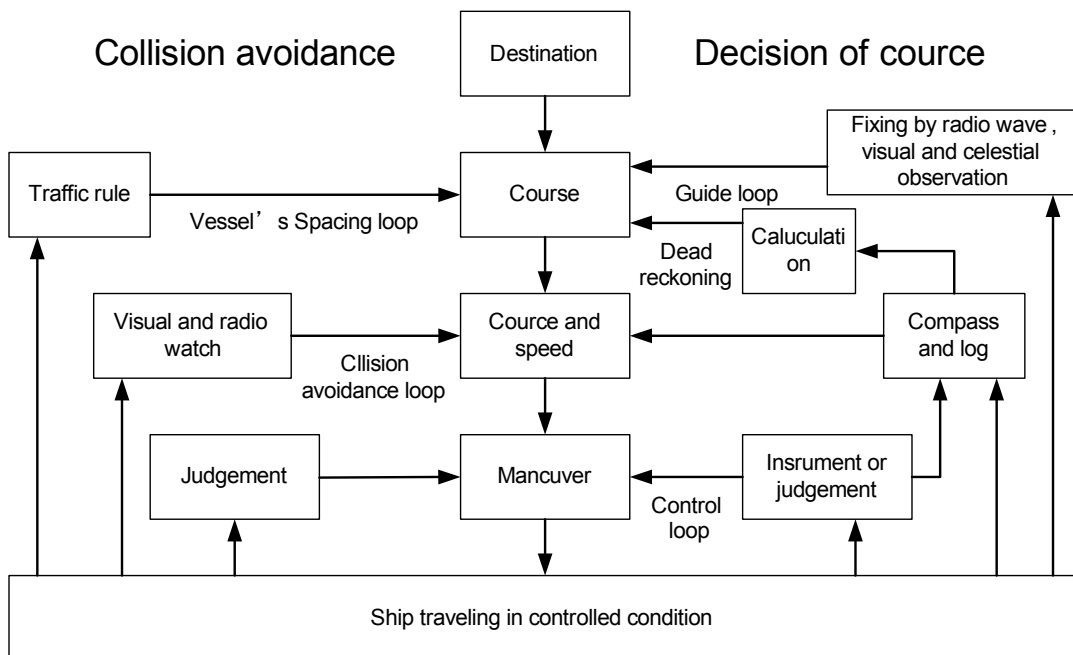

Fig 5-1: Navigation Pattern

5.1.1.2 Marine Accidents and Collisions

Among marine accidents, collision accidents have been highlighted as the tonnages and speeds of ships become higher along with the increase in traffic at sea. If a tanker carrying dangerous articles such as crude oil collides with any other vessel, then not only the vessels involved with the accident but other vessels in the vicinity, port facilities, inhabitants in the coastal area as well as marine resources may also suffer immeasurable damages and troubles. Collision accidents have a high percentage of the marine accidents that have occurred in recent years. To cope with these problems, any effective measures are needed and some equipment to achieve collision avoidance requirements have been developed at rapid strides.

5.1.1.3 Basic Concept of Collision Avoidance

There are two aspects in collision avoidance: collision prediction and avoidance. Collision prediction is to predict that two or more vessels will happen to occupy the same point at the same time, while collision avoidance is to maneuver vessels not to occupy the same point at the same time.

In practical operation of vessels, a spot of collision has to be deemed to be a single point but a closed zone. This closed zone is conceptually defined as a CPA (Closest Point of Approach). In collision prediction, the time to be taken until a ship reaches the CPA is defined as a TCPA (Time to CPA).

Fig. 5-2 shows a diagram caked "Collision Triangle".

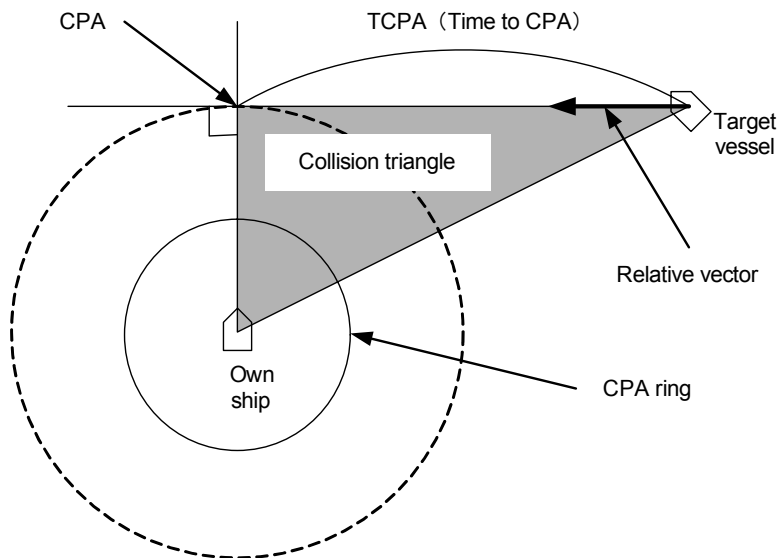

Fig 5-2: Collision Triangle

5.1.1.4 Relative Vector and True Vector

From two points of view, collision prediction and avoidance, it is necessary to obtain the relative vector of other ship for prediction and the true vector of other ship for collision avoidance in order to grasp other ship's aspect. The relationship between the relative vector and true vector is shown in Fig. 5-3.

Both rough CPA and TCPA can be obtained easily from the relative speed vector of other ship. This method has an advantage that the risks of collision with all other ships within the radar range can be seen at a glance. On the other hand, the course and speed of other ship can easily be obtained from its true speed vector, enabling other ship's aspect to be seen at a glance. Thus, the aspects of other ships (transverse, outsail, parallel run, reverse run, etc.) as described in the act of prevention of collision at sea can be readily grasped. If there is a risk of collision with other ship, the operator can determine which rule to be applied and how to operate own ship.

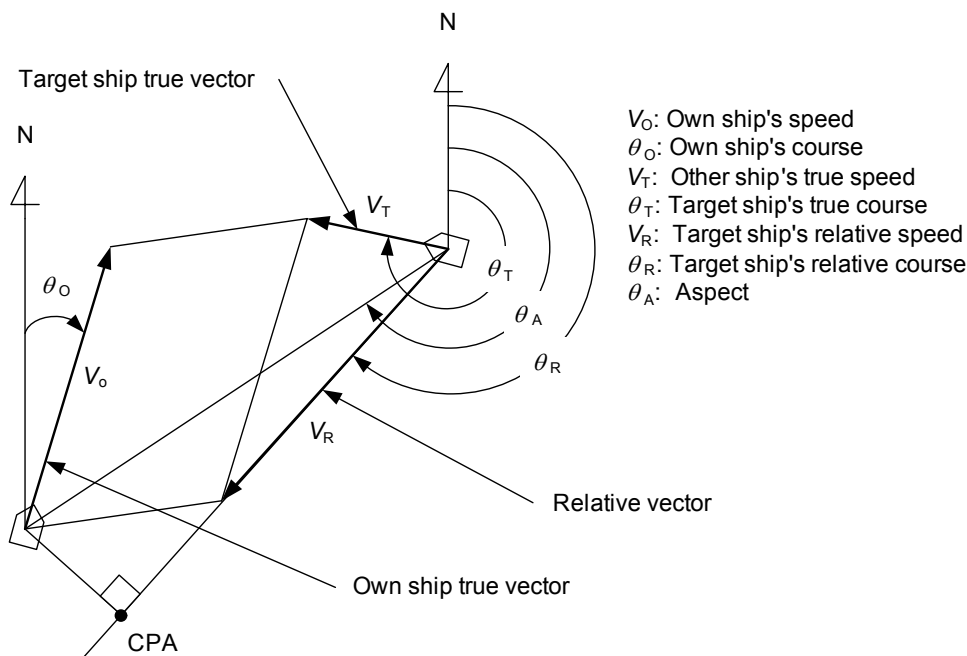

Fig 5-3: Relative Vector and True vector









5.1.1.5 Radar and Collision Avoidance

Radar is still playing an important roll for collision prevention and positioning.

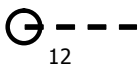

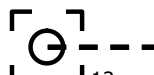

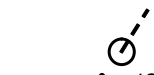

A plotter is used to further enhance the radar functionality. The plotter is capable of plotting other positions of other ships in 3 to 6 minute intervals to monitor their movement. The plots of other ships represent their tracks relative to own ship, and it is shown whether there is a risk of collision, namely CPA and TCPA can be obtained. This method using a plotter is fairly effective, but the number of target ship, which is manually plotted, is limited and it takes several minutes to measure those.

5.1.2 Definitions of Symbols

5.1.2.1 Types and Definitions of Target Tracking Symbols

Vector/ Symbol	Definition	Remarks
	Initial acquisition target	This symbol is displayed until the vector is displayed after target acquisition.
	Target acquired in automatic acquisition zone	The alarm sounds. The alarm message (New Target) turns red and blinks. The symbol is red colored.
	Tracked target	
	Dangerous target	The alarm sounds. The alarm message (CPA/TCPA) turns red and blinks. The symbol turns red and enlarges.
	Numeric displayed target	When the numeric data is displayed, the target symbol is enclosed in a square.
	Lost target	The alarm sounds. The alarm message (Lost) turns red and blinks. The symbol turns red, and indicates with X mark.
	Past position	The past positions of an AIS target are displayed as well as the target tracking symbol.
	Target track	The track of another ship as an AIS target is displayed as well as the target tracking symbol.

5.1.2.2 Types and Definitions of AIS Target Symbols

Vector/ Symbol	Definition	Remarks
	Sleeping target	This symbol is displayed when received data is valid. The direction of the triangle's vertex indicates the target's bow or course.
	Activated target	The heading direction is displayed with a solid line, and the course vector is displayed with a dotted line. The line perpendicular to the heading direction indicates the direction to which the course is to be changed. This line may not be displayed.
	Target acquired in automatic acquisition zone	The alarm sounds. The alarm message (New Target) turns red and blinks.
	Outline display	The outlines of ships are displayed scaled down.
	Numeric displayed target	When the numeric data is displayed, the target symbol is enclosed in a square.
	Dangerous target	The alarm sounds. The alarm message (CPA/TCPA) turns red and blinks. The symbol turns red and enlarges.
	Lost target	The alarm sounds. The symbol turns red, and indicates with X mark.

Up to 300 targets can be displayed in total of activated and sleeping AIS targets. Up to 100 activated AIS targets can be included in the total.

- If there are more AIS targets than the allowable maximum, they are displayed in the following priority order:
 1. Numeric displayed target
 2. Target of which CPA / TCPA is lower than the set value (Target as a dangerous ship for which an alarm has occurred)
 3. Target in automatic activation zone
 4. Activated AIS target
 5. Target inside AIS filter
 6. Target outside AIS filter

- If the number of targets at the same priority level exceeds the allowable maximum, they are displayed in the following priority order:
 1. Association target

2. Activated AIS target
3. Sleeping AIS target

The vector of an AIS target is to be displayed with a vector over ground or over water, depending on the speed sensor setting and current offset setting. The type of the currently displayed vector can be confirmed by viewing the setting of the stable mode.

When **GND** is displayed for **Vector over ground** the stability mode (Upper left of the display on page 2-3):

When **Sea** is displayed for **Vector over water** the stability mode (Upper left of the display on page 2-3):



When the vector of an AIS target is displayed with a vector over water, the system has converted the AIS target's vector over ground to the vector over water according to the data received from the AIS and the own ship's information.

NOTE: When the AIS target's symbol is activated but the vector is not displayed, the following are probable causes of the trouble:

- COG/SOG is not yet input from the GPS.
- The selected speed sensor is malfunctioning.

5.1.2.3 Types and Definitions of Association Target Symbols

When a tracked target and an AIS target are decided as identical, it is displayed with either of the following symbols:

Vector/Symbol	Definition	Remarks
	Priority for tracked target Association target	
	Priority for AIS target Association target	

a. Setting of Tracked Target Symbol Display

This function switches the tracking target symbol display between on and off. Even if the tracking target symbol display is turned off, the data is retained.

Procedures

- 1) **Left-click the  button in the Target Information located at the upper right of the display.**

The tracking target symbol display will be set to on or off.

b. Setting of AIS Target Symbol Display

This function switches the AIS target symbol display between on and off.

Procedures

- 1) Left-click the button in the Target Information located at the upper right of the display.

The AIS target symbol display will be set to on or off.

5.1.3 Radar Display

5.1.3.1 Vector Display

A vector to represent a target's predicted position can be presented in the True vector or Relative vector mode. In each mode, a vector length can be freely changed for a time interval of 1 to 60 minutes.

To switch between the true vector mode and relative vector mode, press the [T/R VECT] key.

5.1.3.2 Vector Mode Selection

[1] True Vector Mode

In the true vector mode, the direction of a target vector indicates the true course of the target and its vector length is proportional to its speed.

In this mode, own ship's vector is displayed as shown Fig 5-4.

In this mode, the movements of other ships around own ship can be accurately and easily monitored.

However, CPA Ring cannot appear in this mode.

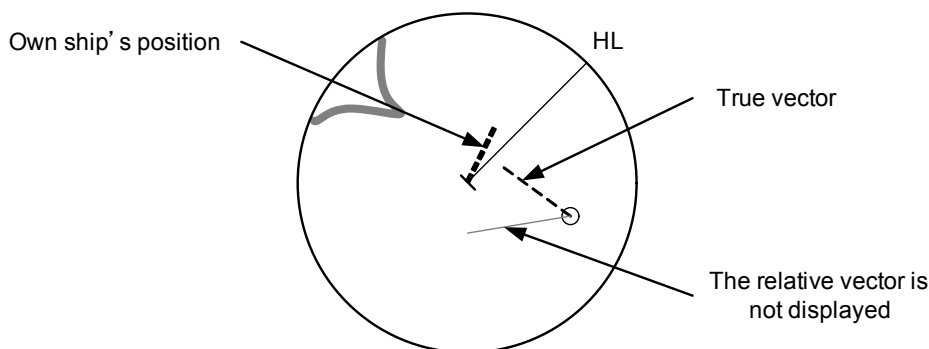

Fig 5-4: True Vector