

6.2.24 JMR-7272-S

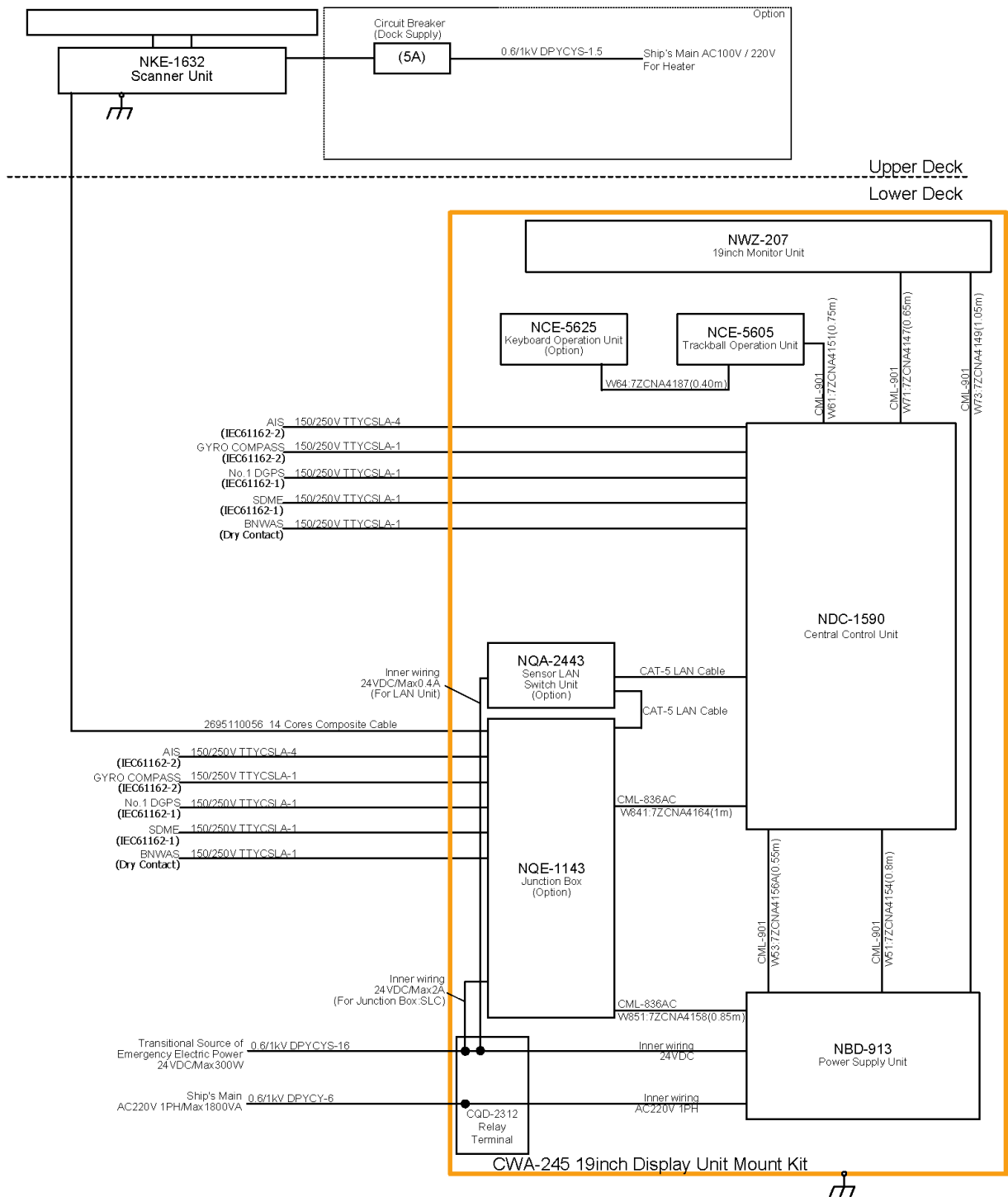

NOTE: ELIMINATING THE INTERFERENCE ON FREQUENCIES USED FOR MARINE COMMUNICATIONS AND NAVIGATION DUE TO OPERATION OF THE RADAR.
 ALL CABLES OF THE RADAR ARE TO BE RUN AWAY FROM THE CABLES OF RADIO EQUIPMENT.
 (ex. RADIOTELEPHONE, COMMUNICATIONS RECEIVER and DIRECTION FINDER, etc.)
 ESPECIALLY INTER-WIRING CABLES BETWEEN SCANNER UNIT AND DISPLAY UNIT OF THE RADAR
 SHOULD NOT BE RUN PARALLEL WITH THE CABLES OF RADIO EQUIPMENT.

General System Diagram of JMR-7272-S RADAR

6.2.25 JMR-7282-S

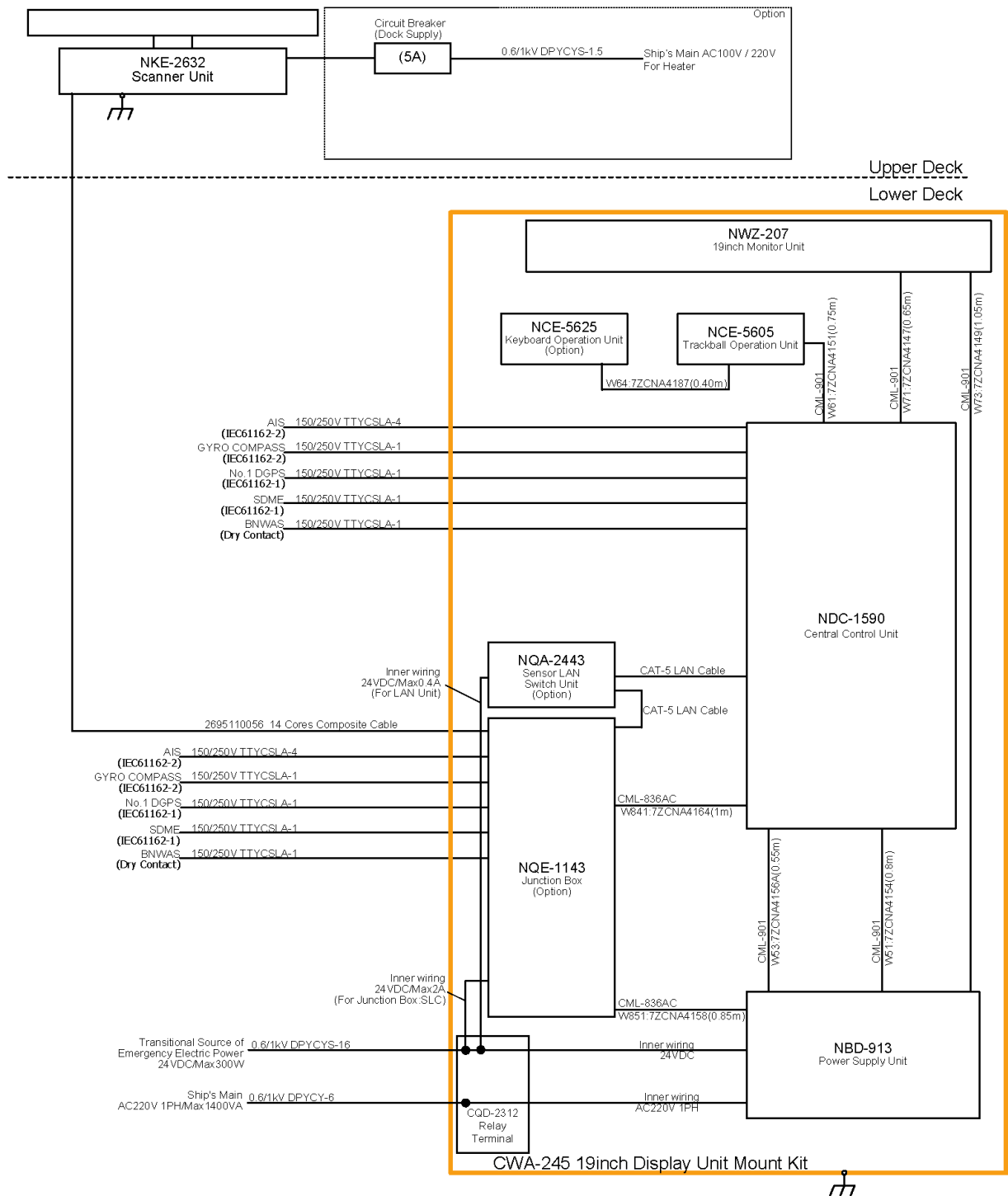

NOTE: ELIMINATING THE INTERFERENCE ON FREQUENCIES USED FOR MARINE COMMUNICATIONS AND NAVIGATION DUE TO OPERATION OF THE RADAR.
 ALL CABLES OF THE RADAR ARE TO BE RUN AWAY FROM THE CABLES OF RADIO EQUIPMENT.
 (ex. RADIOTELEPHONE, COMMUNICATIONS RECEIVER and DIRECTION FINDER, etc.)
 ESPECIALLY INTER-WIRING CABLES BETWEEN SCANNER UNIT AND DISPLAY UNIT OF THE RADAR
 SHOULD NOT BE RUN PARALLEL WITH THE CABLES OF RADIO EQUIPMENT.

General System Diagram of JMR-7282-S RADAR

6.2.26 JMR-7282-SH

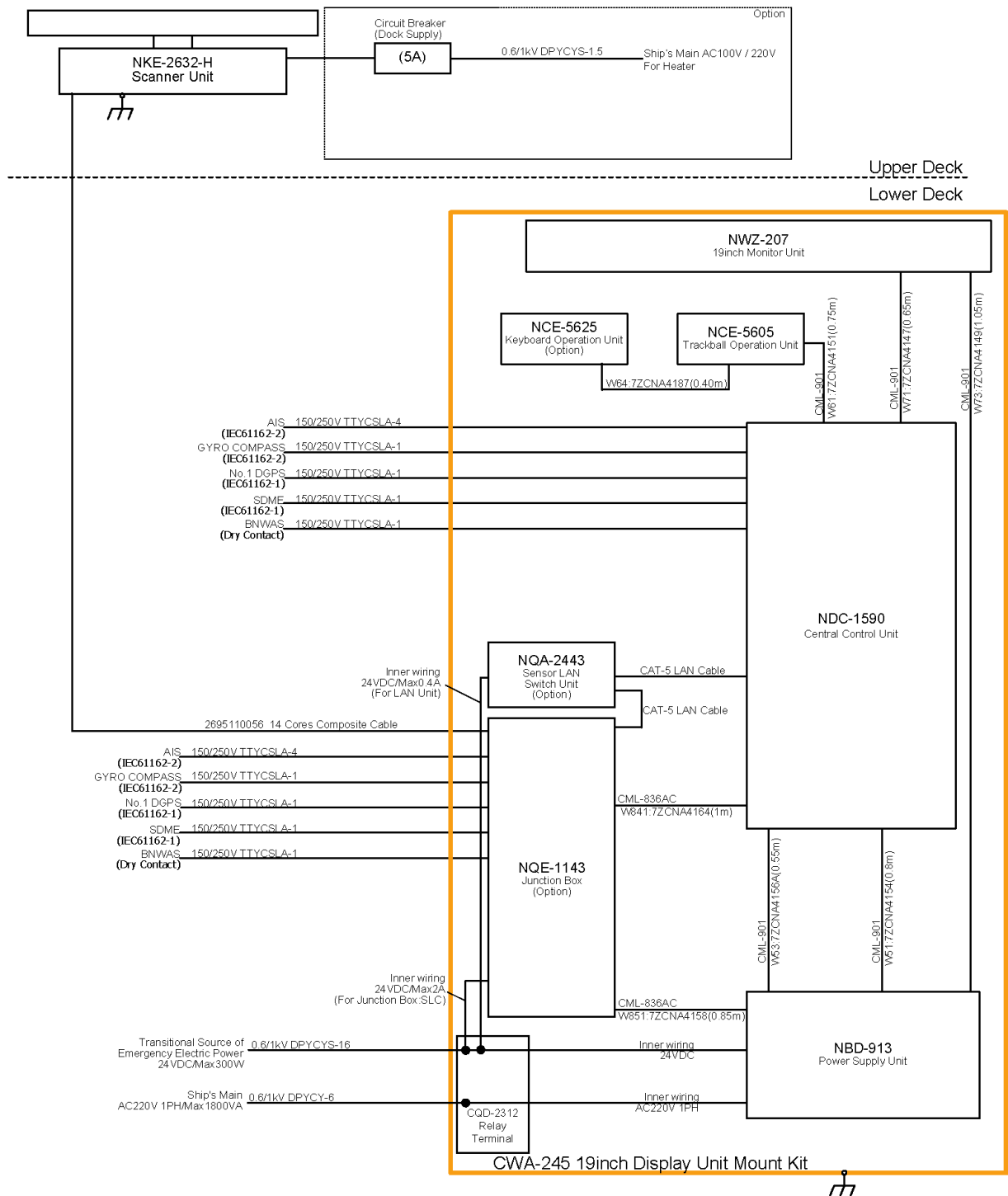

NOTE: ELIMINATING THE INTERFERENCE ON FREQUENCIES USED FOR MARINE COMMUNICATIONS AND NAVIGATION DUE TO OPERATION OF THE RADAR.
 ALL CABLES OF THE RADAR ARE TO BE RUN AWAY FROM THE CABLES OF RADIO EQUIPMENT.
 (ex. RADIOTELEPHONE, COMMUNICATIONS RECEIVER and DIRECTION FINDER, etc.)
 ESPECIALLY INTER-WIRING CABLES BETWEEN SCANNER UNIT AND DISPLAY UNIT OF THE RADAR SHOULD NOT BE RUN PARALLEL WITH THE CABLES OF RADIO EQUIPMENT.

General System Diagram of JMR-7282-SH RADAR

6.2.27 JAN-7201

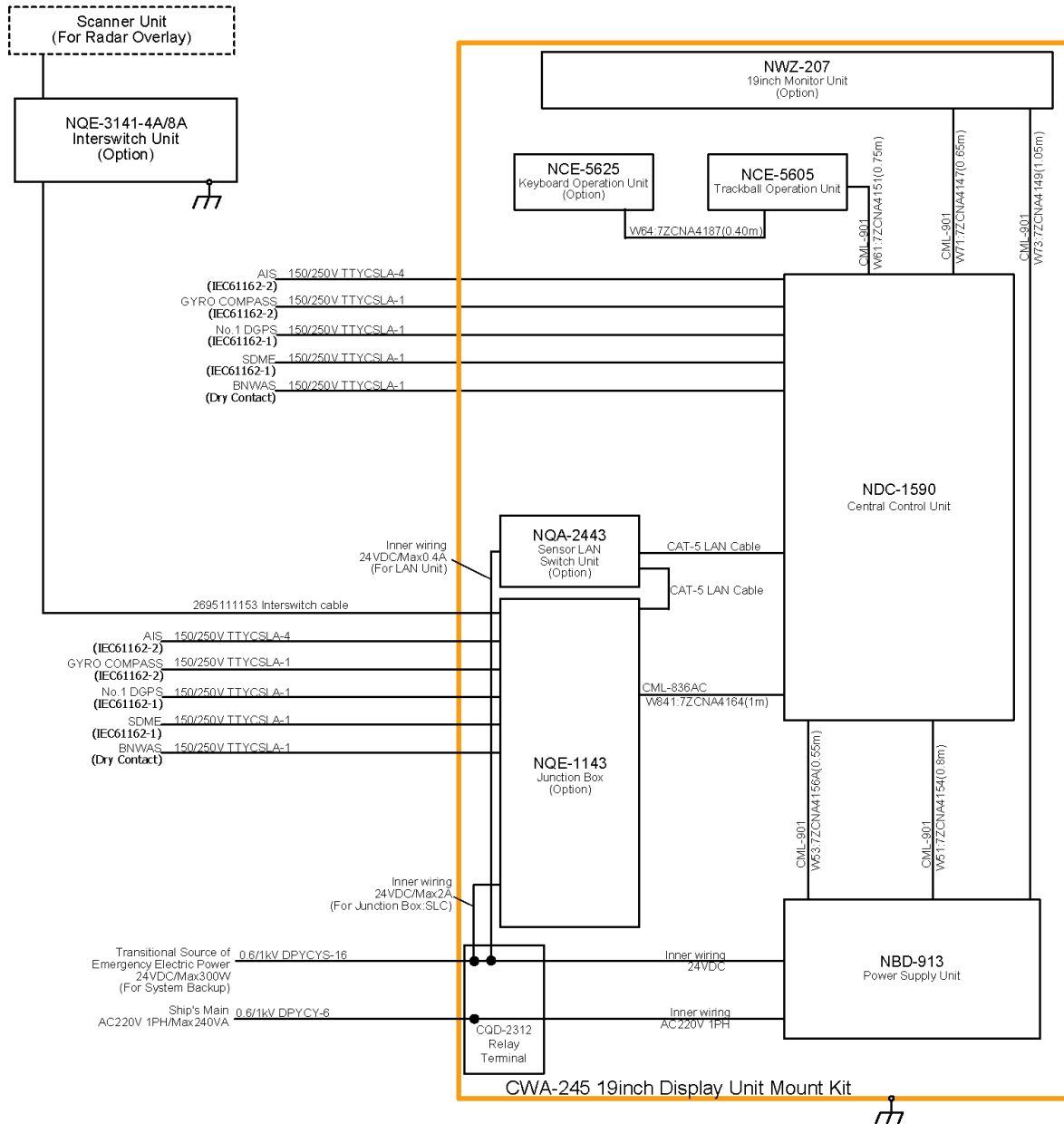

NOTE: ELIMINATING THE INTERFERENCE ON FREQUENCIES USED FOR MARINE COMMUNICATIONS AND NAVIGATION DUE TO OPERATION OF THE RADAR,
 ALL CABLES OF THE RADAR ARE TO BE RUN AWAY FROM THE CABLES OF RADIO EQUIPMENT.
 (ex. RADIOTELEPHONE, COMMUNICATIONS RECEIVER and DIRECTION FINDER, etc.)
 ESPECIALLY INTER-WIRING CABLES BETWEEN SCANNER UNIT AND DISPLAY UNIT OF THE RADAR
 SHOULD NOT BE RUN PARALLEL WITH THE CABLES OF RADIO EQUIPMENT.

General System Diagram of JAN-7201 ECDIS

6.2.28 JAN-7202

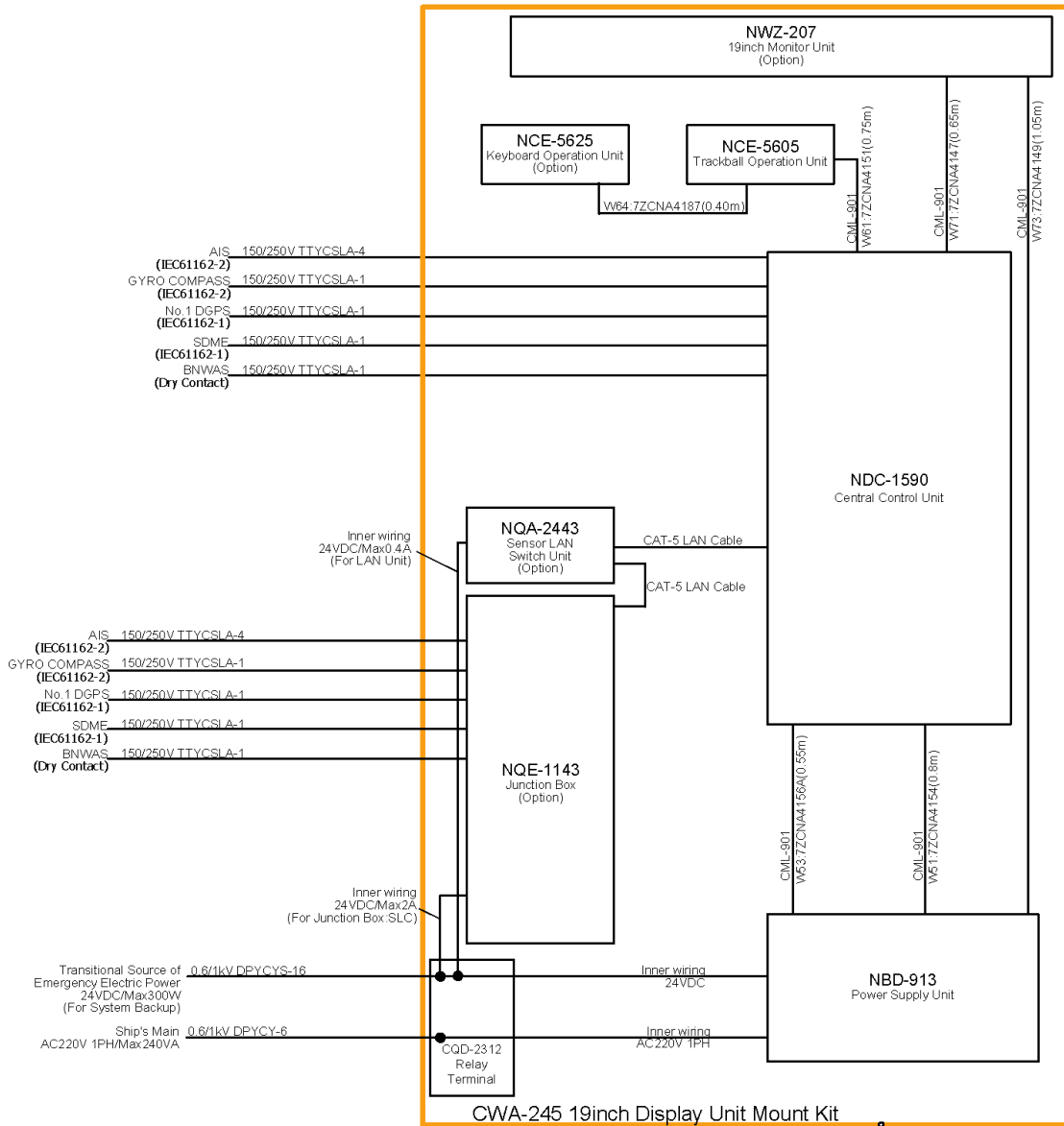

NOTE: ELIMINATING THE INTERFERENCE ON FREQUENCIES USED FOR MARINE COMMUNICATIONS AND NAVIGATION DUE TO OPERATION OF THE RADAR.
 ALL CABLES OF THE RADAR ARE TO BE RUN AWAY FROM THE CABLES OF RADIO EQUIPMENT.
 (ex. RADIOTELEPHONE, COMMUNICATIONS RECEIVER and DIRECTION FINDER, etc.)
 ESPECIALLY INTER-WIRING CABLES BETWEEN SCANNER UNIT AND DISPLAY UNIT OF THE RADAR SHOULD NOT BE RUN PARALLEL WITH THE CABLES OF RADIO EQUIPMENT.

General System Diagram of JAN-7202 CONNING

6.3 General System Diagram of Desktop Type

6.3.1 JMR-9210-6X

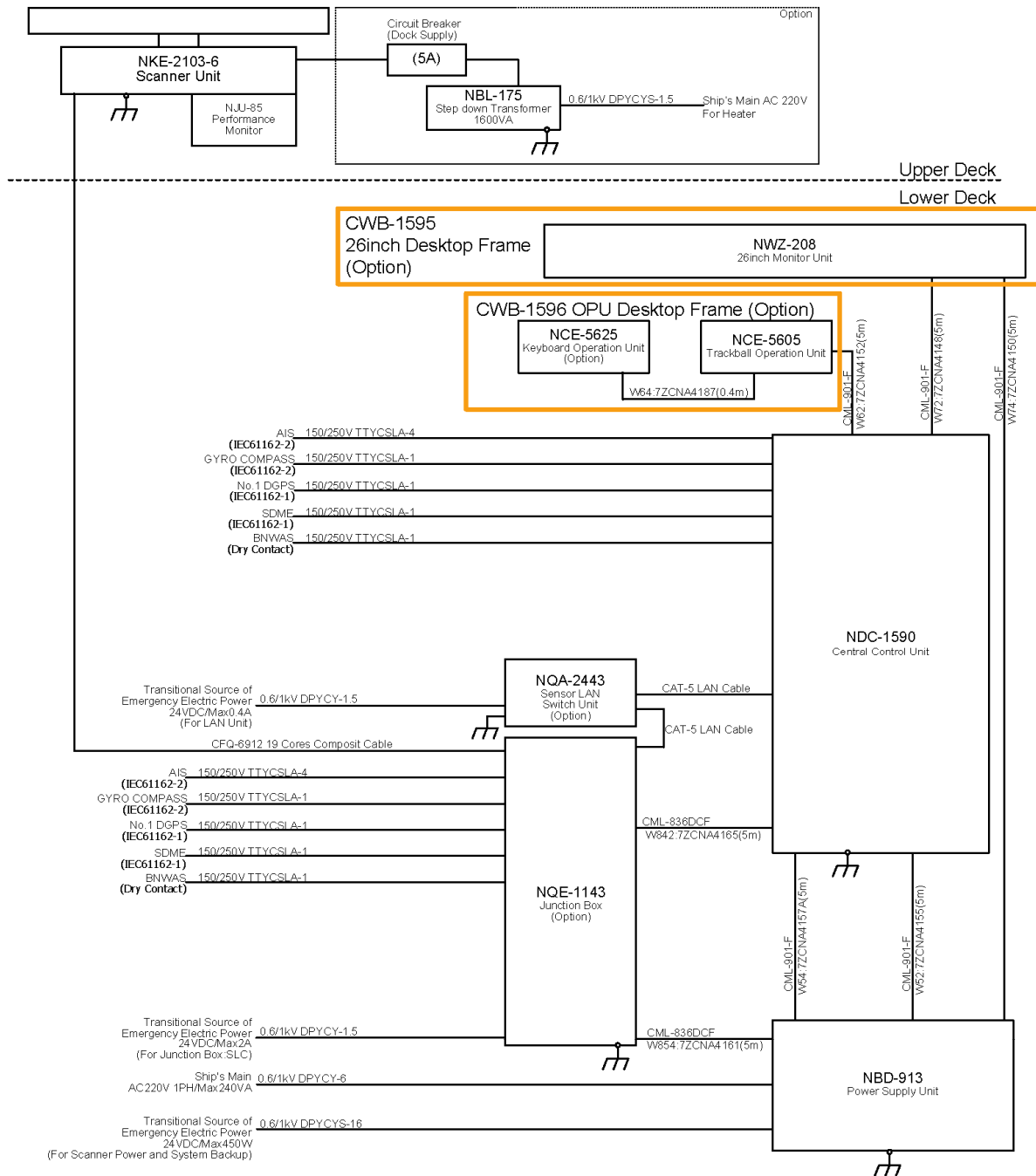

NOTE:ELIMINATING THE INTERFERENCE ON FREQUENCIES USED FOR MARINE COMMUNICATIONS AND NAVIGATION DUE TO OPERATION OF THE RADAR, ALL CABLES OF THE RADAR ARE TO BE RUN AWAY FROM THE CABLES OF RADIO EQUIPMENT. (ex. RADIOTELEPHONE, COMMUNICATIONS RECEIVER and DIRECTION FINDER, etc..) ESPECIALLY INTER-WIRING CABLES BETWEEN SCANNER UNIT AND DISPLAY UNIT OF THE RADAR SHOULD NOT BE RUN PARALLEL WITH THE CABLES OF RADIO EQUIPMENT.

General System Diagram of JMR-9210-6X RADAR

6.3.2 JMR-9210-6XH

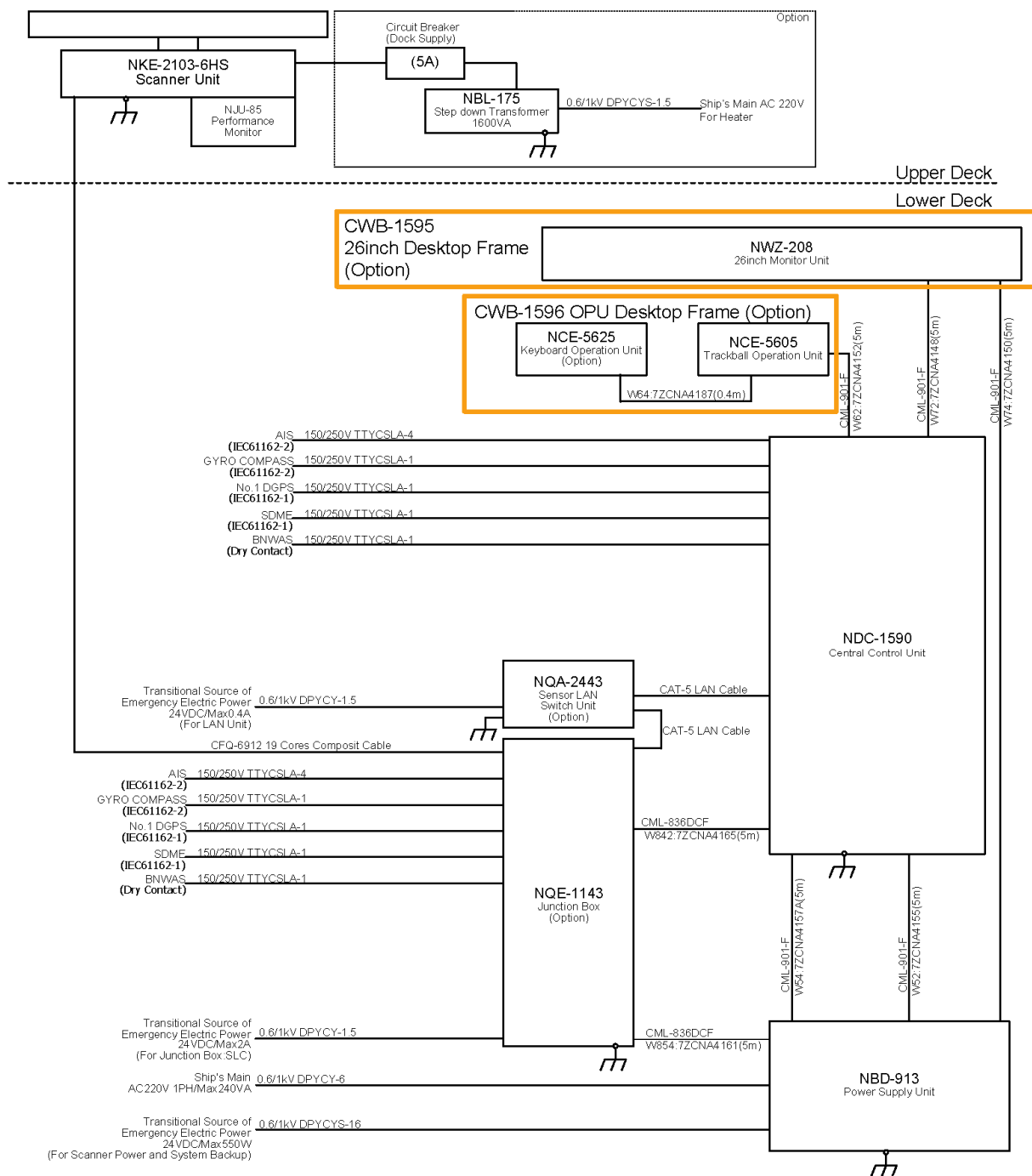

NOTE ELIMINATING THE INTERFERENCE ON FREQUENCIES USED FOR MARINE COMMUNICATIONS AND NAVIGATION DUE TO OPERATION OF THE RADAR.
 ALL CABLES OF THE RADAR ARE TO BE RUN AWAY FROM THE CABLES OF RADIO EQUIPMENT.
 (ex. RADIOTELEPHONE, COMMUNICATIONS RECEIVER and DIRECTION FINDER, etc.)
 ESPECIALLY INTER-WIRING CABLES BETWEEN SCANNER UNIT AND DISPLAY UNIT OF THE RADAR SHOULD NOT BE RUN PARALLEL WITH THE CABLES OF RADIO EQUIPMENT.

General System Diagram of JMR-9210-6XH RADAR

6.3.3 JMR-9225-6X

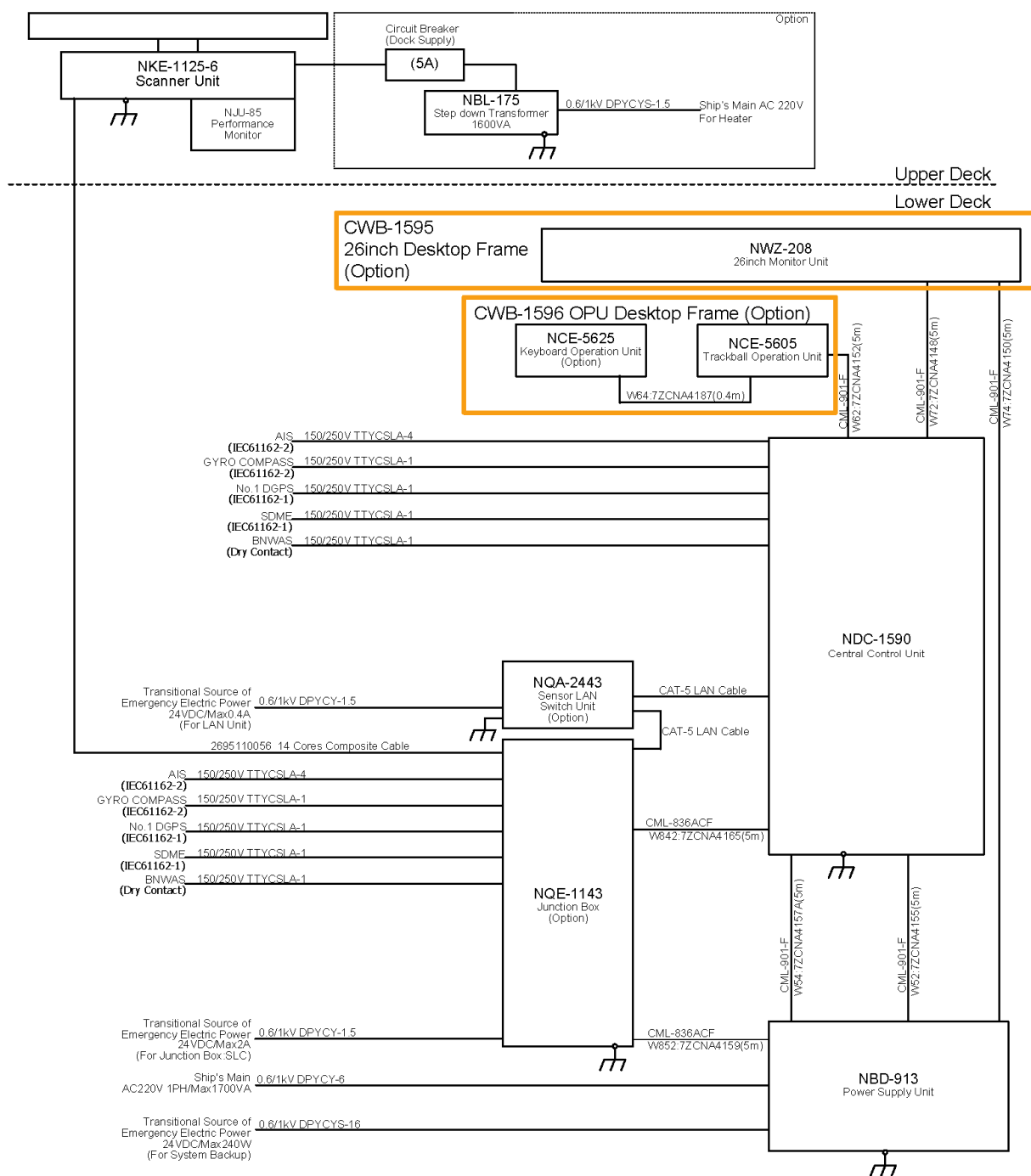

NOTE ELIMINATING THE INTERFERENCE ON FREQUENCIES USED FOR MARINE COMMUNICATIONS AND NAVIGATION DUE TO OPERATION OF THE RADAR.
 ALL CABLES OF THE RADAR ARE TO BE RUN AWAY FROM THE CABLES OF RADIO EQUIPMENT.
 (ex. RADIOTELEPHONE, COMMUNICATIONS RECEIVER and DIRECTION FINDER, etc.)
 ESPECIALLY INTER-WIRING CABLES BETWEEN SCANNER UNIT AND DISPLAY UNIT OF THE RADAR SHOULD NOT BE RUN PARALLEL WITH THE CABLES OF RADIO EQUIPMENT.

General System Diagram of JMR-9225-6X RADAR

6.3.4 JMR-9225-6XH

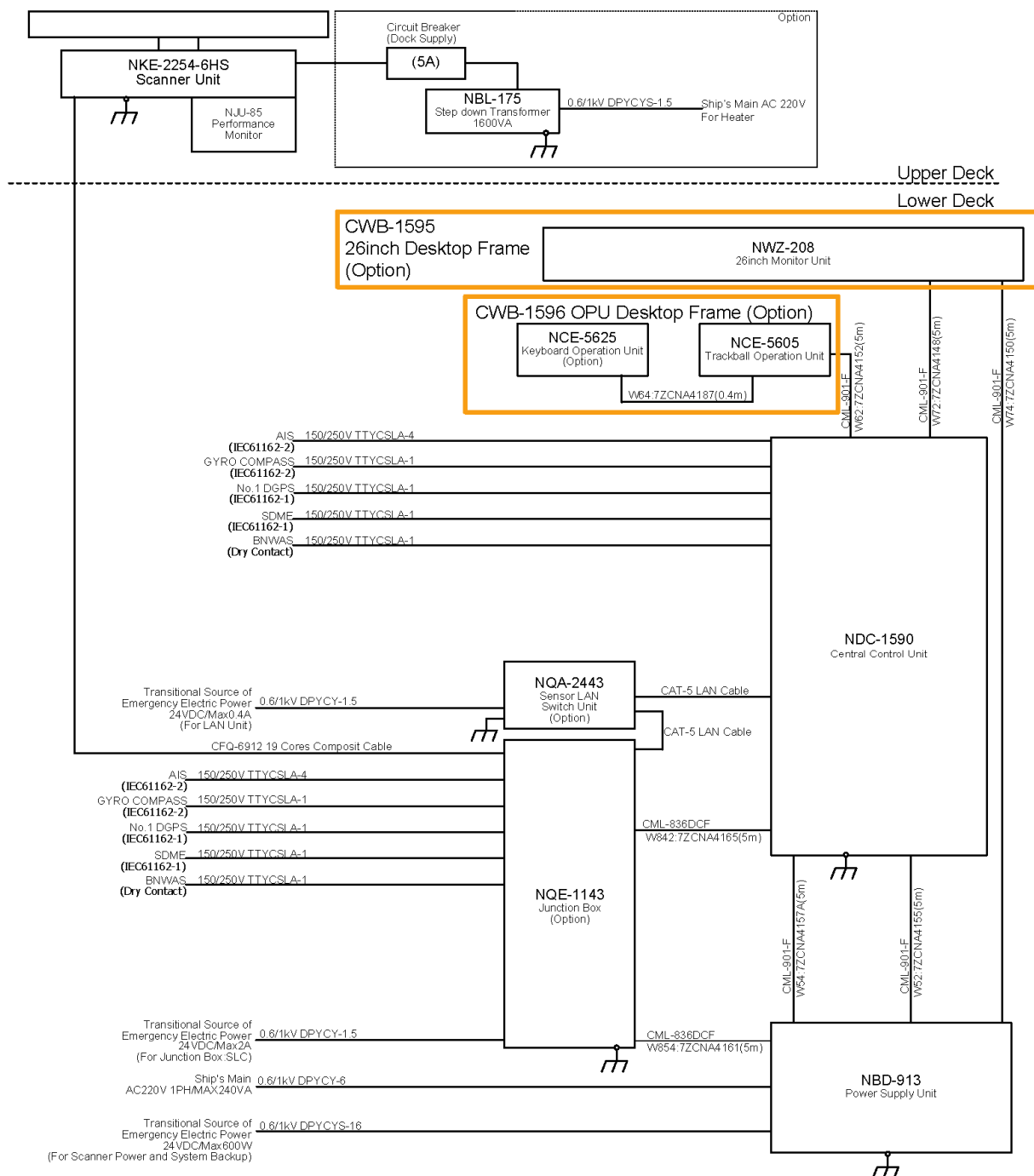

NOTE ELIMINATING THE INTERFERENCE ON FREQUENCIES USED FOR MARINE COMMUNICATIONS AND NAVIGATION DUE TO OPERATION OF THE RADAR.
 ALL CABLES OF THE RADAR ARE TO BE RUN AWAY FROM THE CABLES OF RADIO EQUIPMENT.
 (ex. RADIOTELEPHONE, COMMUNICATIONS RECEIVER and DIRECTION FINDER, etc.)
 ESPECIALLY INTER-WIRING CABLES BETWEEN SCANNER UNIT AND DISPLAY UNIT OF THE RADAR SHOULD NOT BE RUN PARALLEL WITH THE CABLES OF RADIO EQUIPMENT.

General System Diagram of JMR-9225-6XH RADAR

6.3.5 JMR-9225-9X

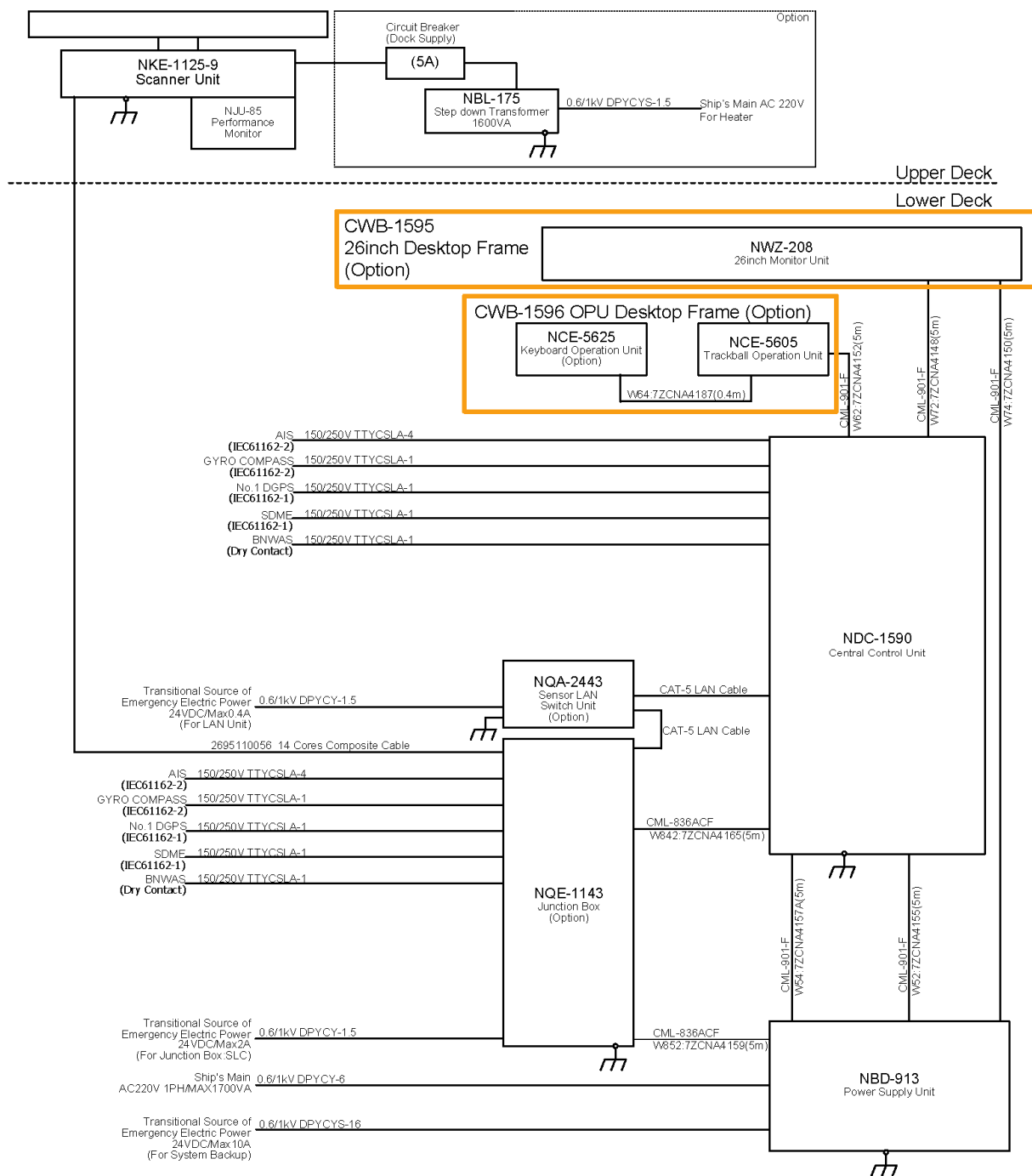

NOTE ELIMINATING THE INTERFERENCE ON FREQUENCIES USED FOR MARINE COMMUNICATIONS AND NAVIGATION DUE TO OPERATION OF THE RADAR.
 ALL CABLES OF THE RADAR ARE TO BE RUN AWAY FROM THE CABLES OF RADIO EQUIPMENT.
 (ex. RADIOTELEPHONE, COMMUNICATIONS RECEIVER and DIRECTION FINDER, etc.)
 ESPECIALLY INTER-WIRING CABLES BETWEEN SCANNER UNIT AND DISPLAY UNIT OF THE RADAR SHOULD NOT BE RUN PARALLEL WITH THE CABLES OF RADIO EQUIPMENT.

General System Diagram of JMR-9225-9X RADAR

6.3.6 JMR-9225-7X3

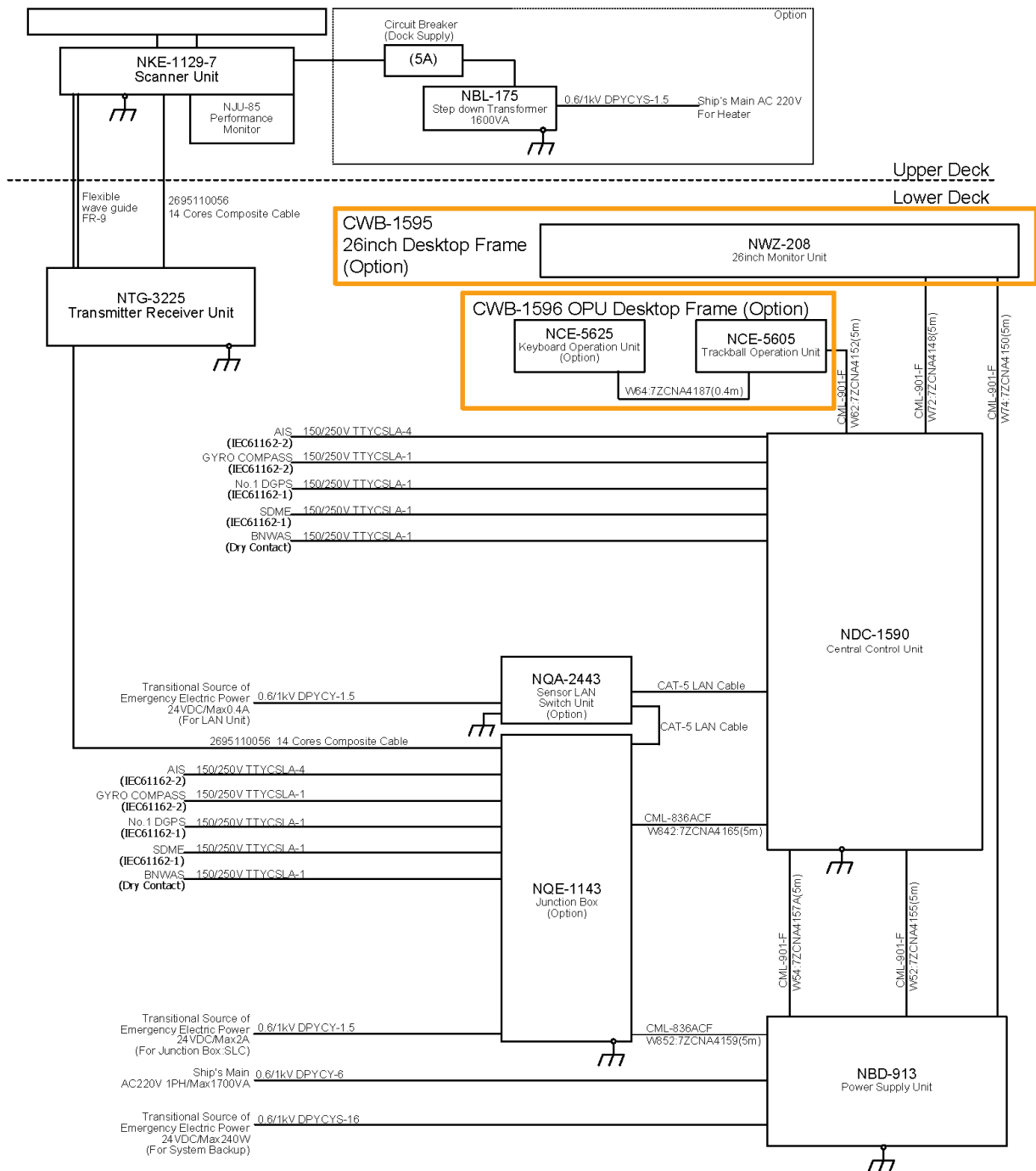

NOTE ELIMINATING THE INTERFERENCE ON FREQUENCIES USED FOR MARINE COMMUNICATIONS AND NAVIGATION DUE TO OPERATION OF THE RADAR.
 ALL CABLES OF THE RADAR ARE TO BE RUN AWAY FROM THE CABLES OF RADIO EQUIPMENT.
 (ex. RADIOTELEPHONE, COMMUNICATIONS RECEIVER and DIRECTION FINDER, etc.)
 ESPECIALLY INTER-WIRING CABLES BETWEEN SCANNER UNIT AND DISPLAY UNIT OF THE RADAR SHOULD NOT BE RUN PARALLEL WITH THE CABLES OF RADIO EQUIPMENT.

General System Diagram of JMR-9225-7X3 RADAR

6.3.7 JMR-9225-9X3

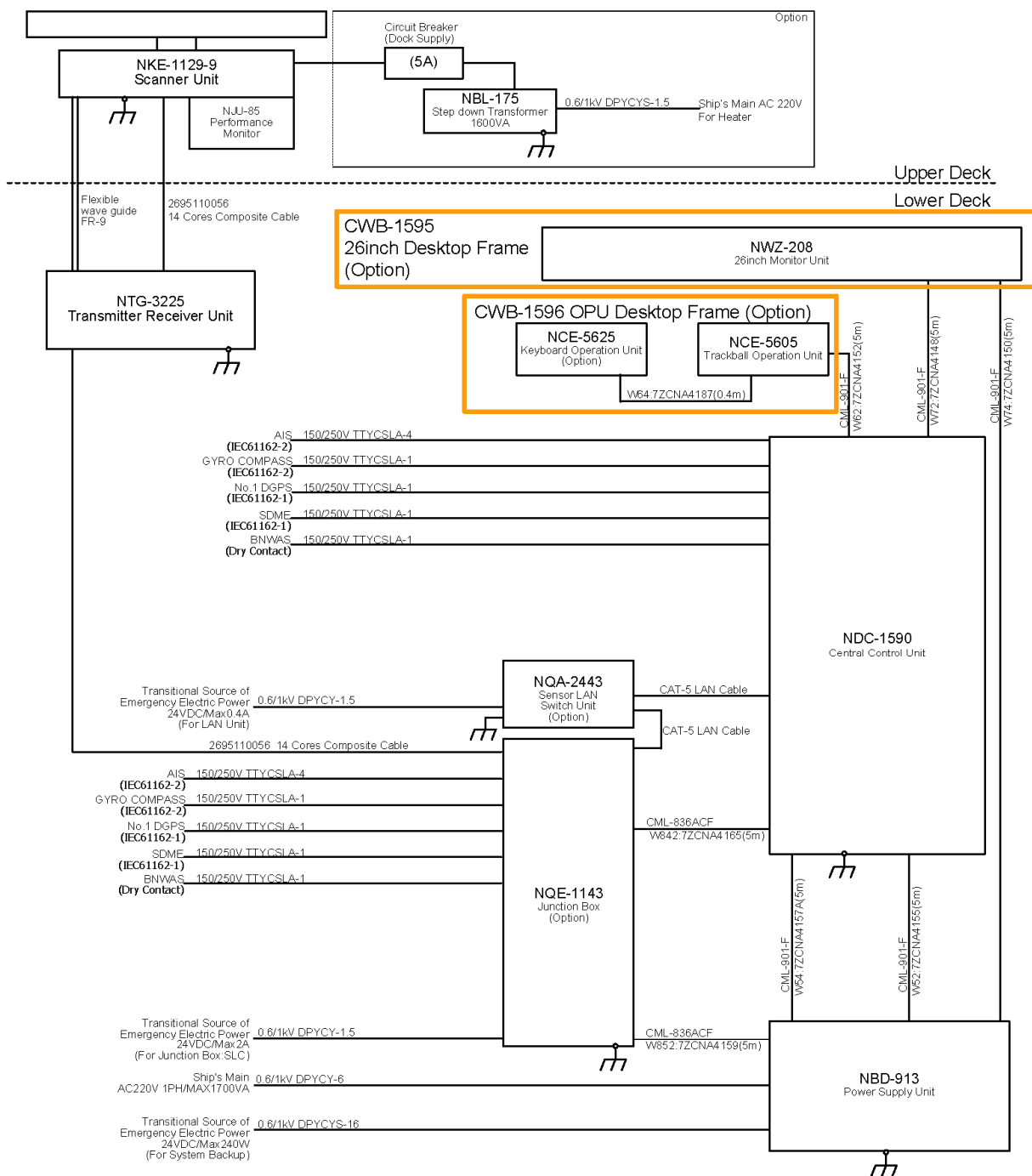

NOTE ELIMINATING THE INTERFERENCE ON FREQUENCIES USED FOR MARINE COMMUNICATIONS AND NAVIGATION DUE TO OPERATION OF THE RADAR.
 ALL CABLES OF THE RADAR ARE TO BE RUN AWAY FROM THE CABLES OF RADIO EQUIPMENT.
 (ex. RADIOTELEPHONE, COMMUNICATIONS RECEIVER and DIRECTION FINDER, etc.)
 ESPECIALLY INTER-WIRING CABLES BETWEEN SCANNER UNIT AND DISPLAY UNIT OF THE RADAR SHOULD NOT BE RUN PARALLEL WITH THE CABLES OF RADIO EQUIPMENT.

General System Diagram of JMR-9225-9X3 RADAR

6.3.8 JMR-9230-S

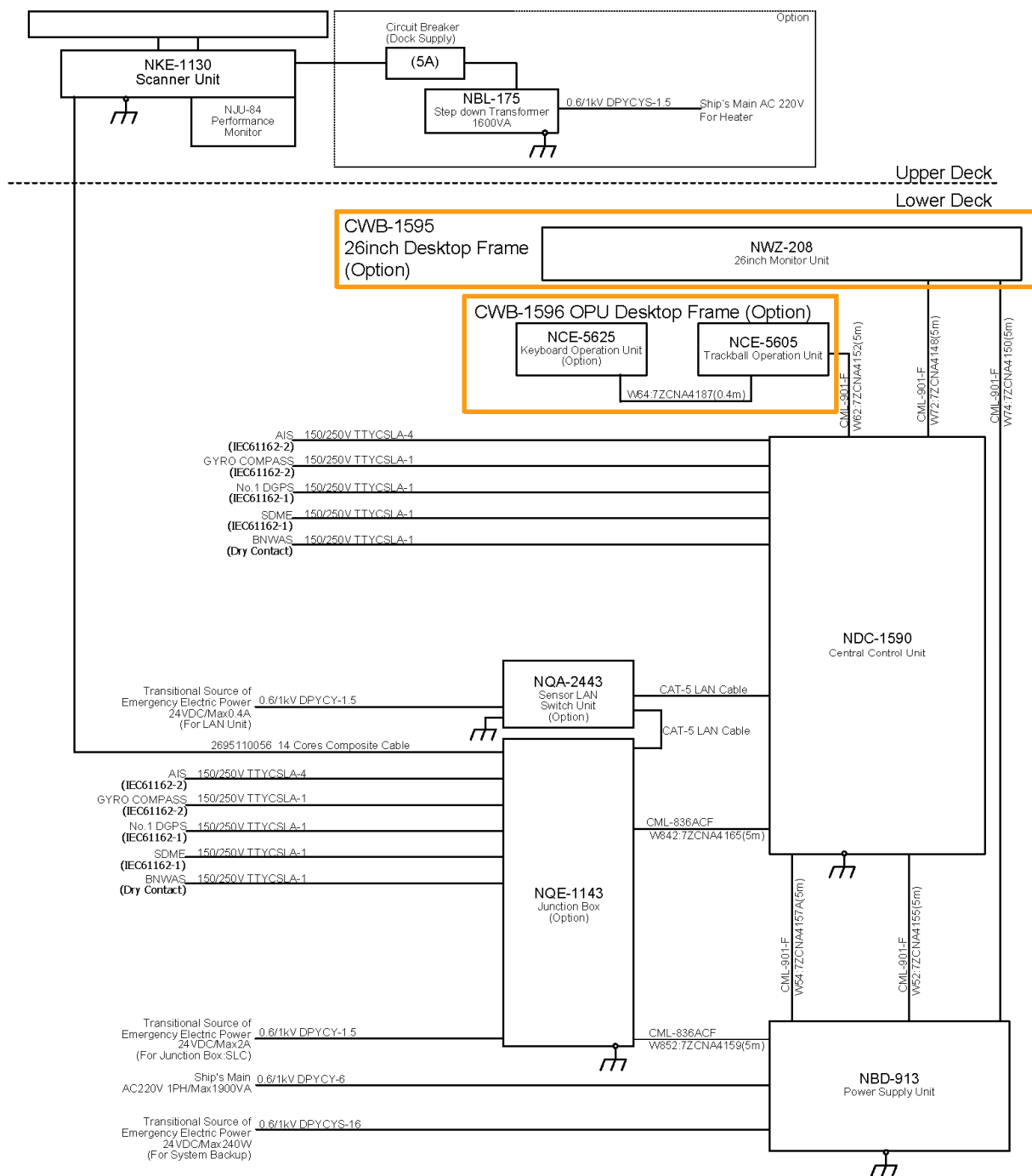

NOTE ELIMINATING THE INTERFERENCE ON FREQUENCIES USED FOR MARINE COMMUNICATIONS AND NAVIGATION DUE TO OPERATION OF THE RADAR.
 ALL CABLES OF THE RADAR ARE TO BE RUN AWAY FROM THE CABLES OF RADIO EQUIPMENT.
 (ex. RADIOTELEPHONE, COMMUNICATIONS RECEIVER and DIRECTION FINDER, etc.)
 ESPECIALLY INTER-WIRING CABLES BETWEEN SCANNER UNIT AND DISPLAY UNIT OF THE RADAR SHOULD NOT BE RUN PARALLEL WITH THE CABLES OF RADIO EQUIPMENT.

General System Diagram of JMR-9230-S RADAR

6.3.9 JMR-9230-S3

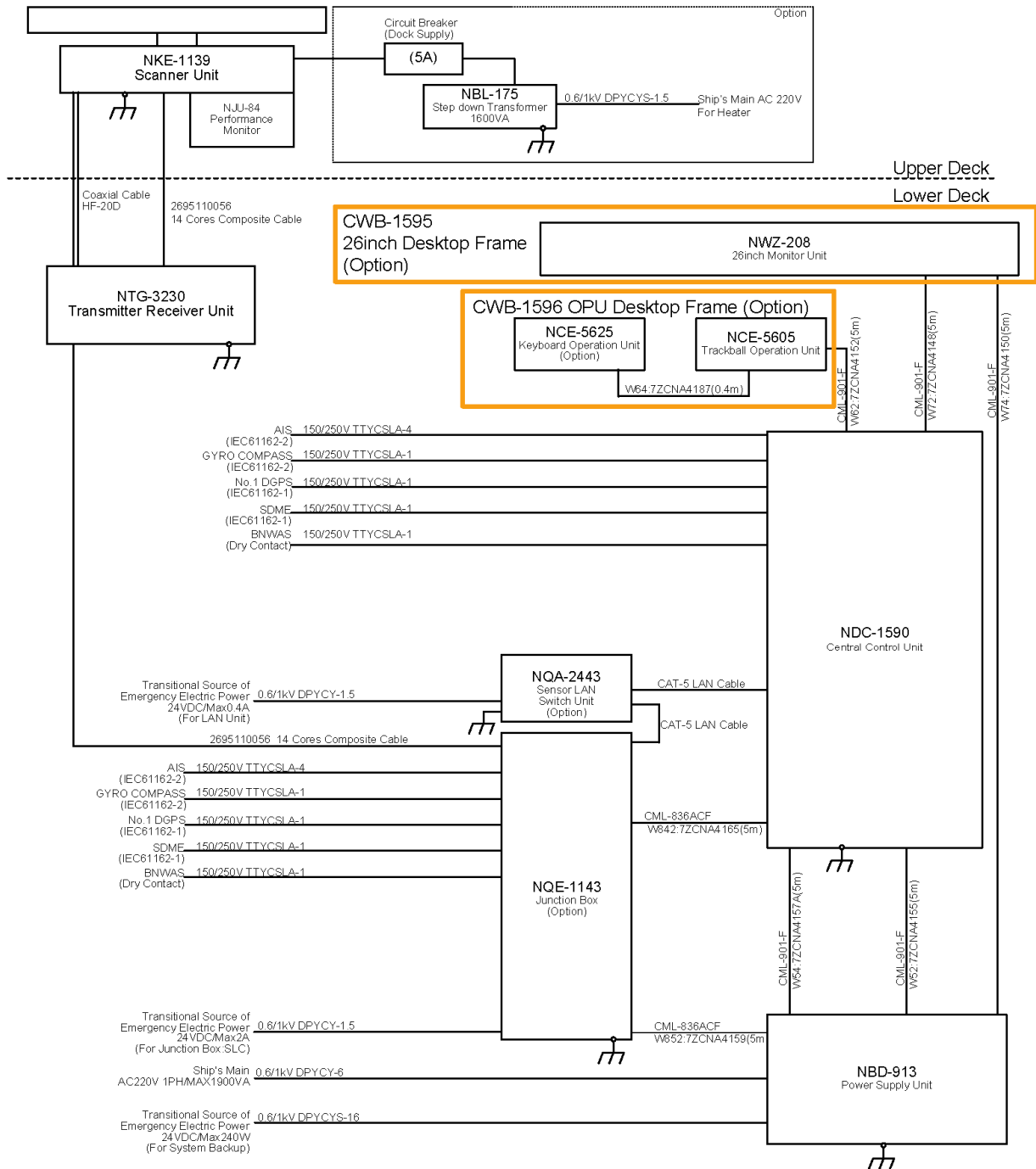

NOTE.ELIMINATING THE INTERFERENCE ON FREQUENCIES USED FOR MARINE COMMUNICATIONS AND NAVIGATION DUE TO OPERATION OF THE RADAR.
 ALL CABLES OF THE RADAR ARE TO BE RUN AWAY FROM THE CABLES OF RADIO EQUIPMENT.
 (ex. RADIOTELEPHONE, COMMUNICATIONS RECEIVER and DIRECTION FINDER, etc.)
 ESPECIALLY INTER-WIRING CABLES BETWEEN SCANNER UNIT AND DISPLAY UNIT OF THE RADAR SHOULD NOT BE RUN PARALLEL WITH THE CABLES OF RADIO EQUIPMENT.

General System Diagram of JMR-9230-S3 RADAR

6.3.10 JMR-9272-S

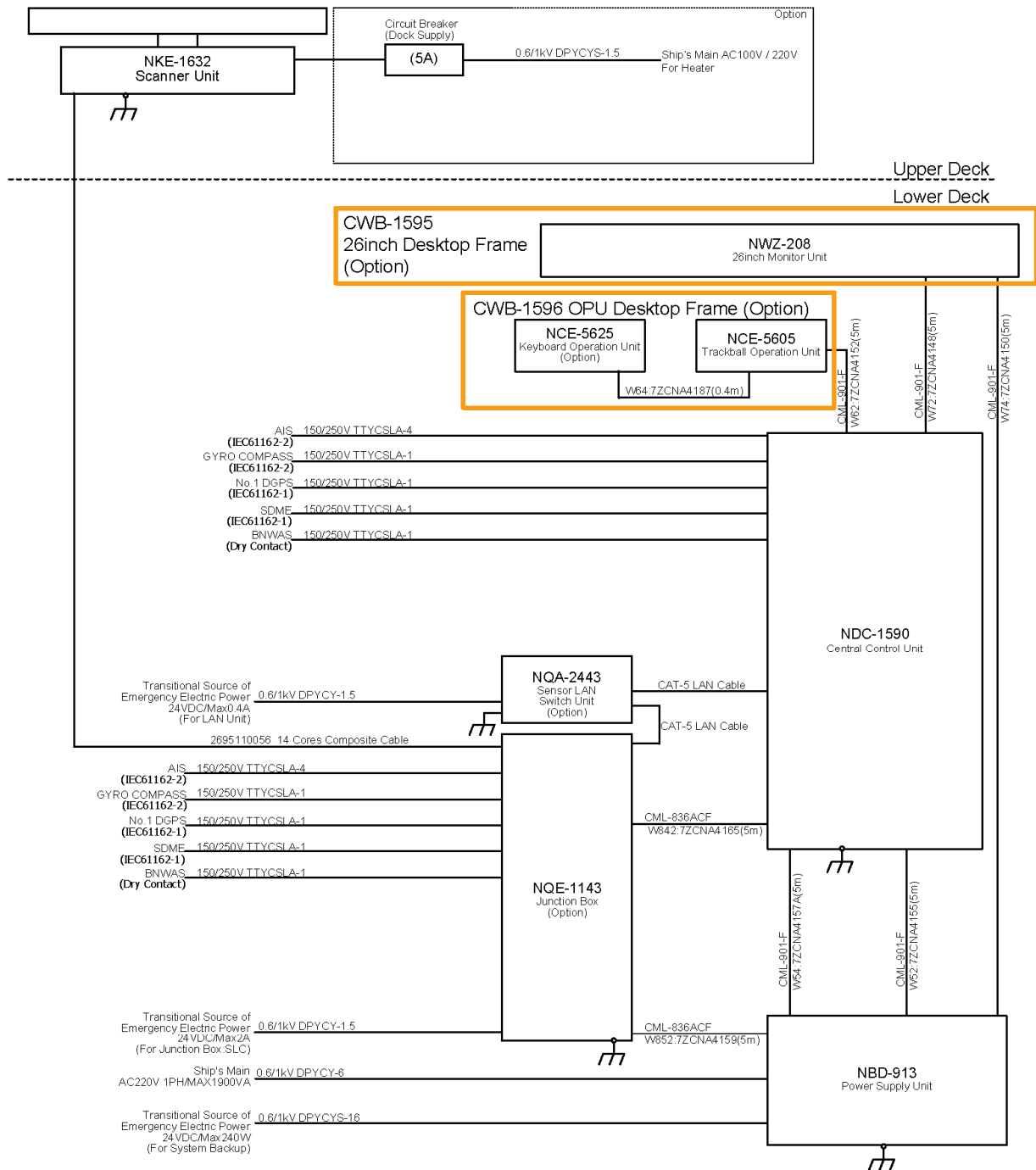

NOTE ELIMINATING THE INTERFERENCE ON FREQUENCIES USED FOR MARINE COMMUNICATIONS AND NAVIGATION DUE TO OPERATION OF THE RADAR.
 ALL CABLES OF THE RADAR ARE TO BE RUN AWAY FROM THE CABLES OF RADIO EQUIPMENT.
 (ex. RADIOTELEPHONE, COMMUNICATIONS RECEIVER and DIRECTION FINDER, etc.)
 ESPECIALLY INTER-WIRING CABLES BETWEEN SCANNER UNIT AND DISPLAY UNIT OF THE RADAR SHOULD NOT BE RUN PARALLEL WITH THE CABLES OF RADIO EQUIPMENT.

General System Diagram of JMR-9272-S RADAR

6.3.11 JMR-9282-S

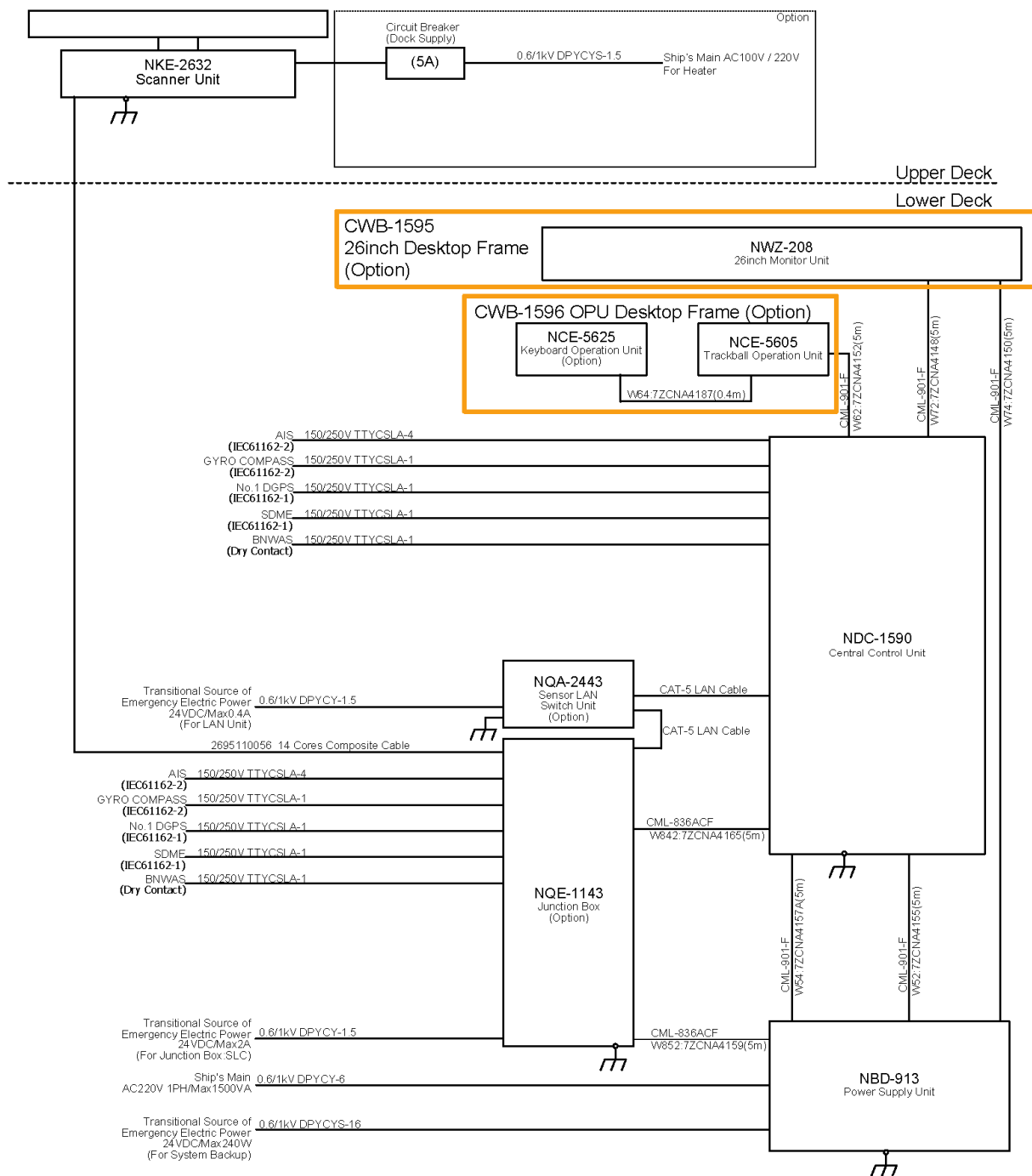

NOTE ELIMINATING THE INTERFERENCE ON FREQUENCIES USED FOR MARINE COMMUNICATIONS AND NAVIGATION DUE TO OPERATION OF THE RADAR.
 ALL CABLES OF THE RADAR ARE TO BE RUN AWAY FROM THE CABLES OF RADIO EQUIPMENT.
 (ex. RADIOTELEPHONE, COMMUNICATIONS RECEIVER and DIRECTION FINDER, etc.)
 ESPECIALLY INTER-WIRING CABLES BETWEEN SCANNER UNIT AND DISPLAY UNIT OF THE RADAR SHOULD NOT BE RUN PARALLEL WITH THE CABLES OF RADIO EQUIPMENT.

General System Diagram of JMR-9282-S RADAR

6.3.12 JMR-9282-SH

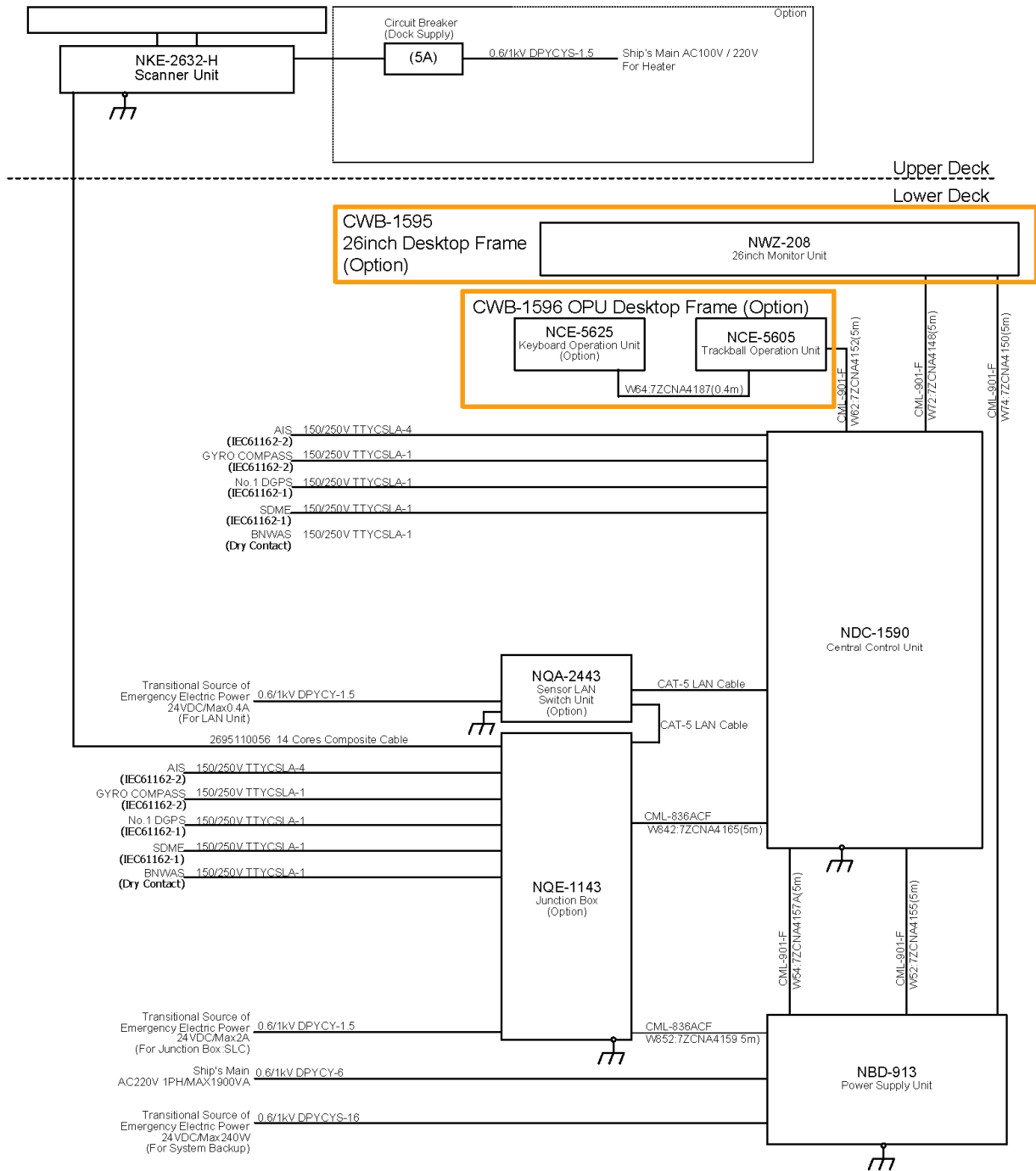

NOTE ELIMINATING THE INTERFERENCE ON FREQUENCIES USED FOR MARINE COMMUNICATIONS AND NAVIGATION DUE TO OPERATION OF THE RADAR.
 ALL CABLES OF THE RADAR ARE TO BE RUN AWAY FROM THE CABLES OF RADIO EQUIPMENT.
 (ex. RADIOTELEPHONE, COMMUNICATIONS RECEIVER and DIRECTION FINDER, etc.)
 ESPECIALLY INTER-WIRING CABLES BETWEEN SCANNER UNIT AND DISPLAY UNIT OF THE RADAR SHOULD NOT BE RUN PARALLEL WITH THE CABLES OF RADIO EQUIPMENT.

General System Diagram of JMR-9282-SH RADAR

6.3.13 JAN-9201

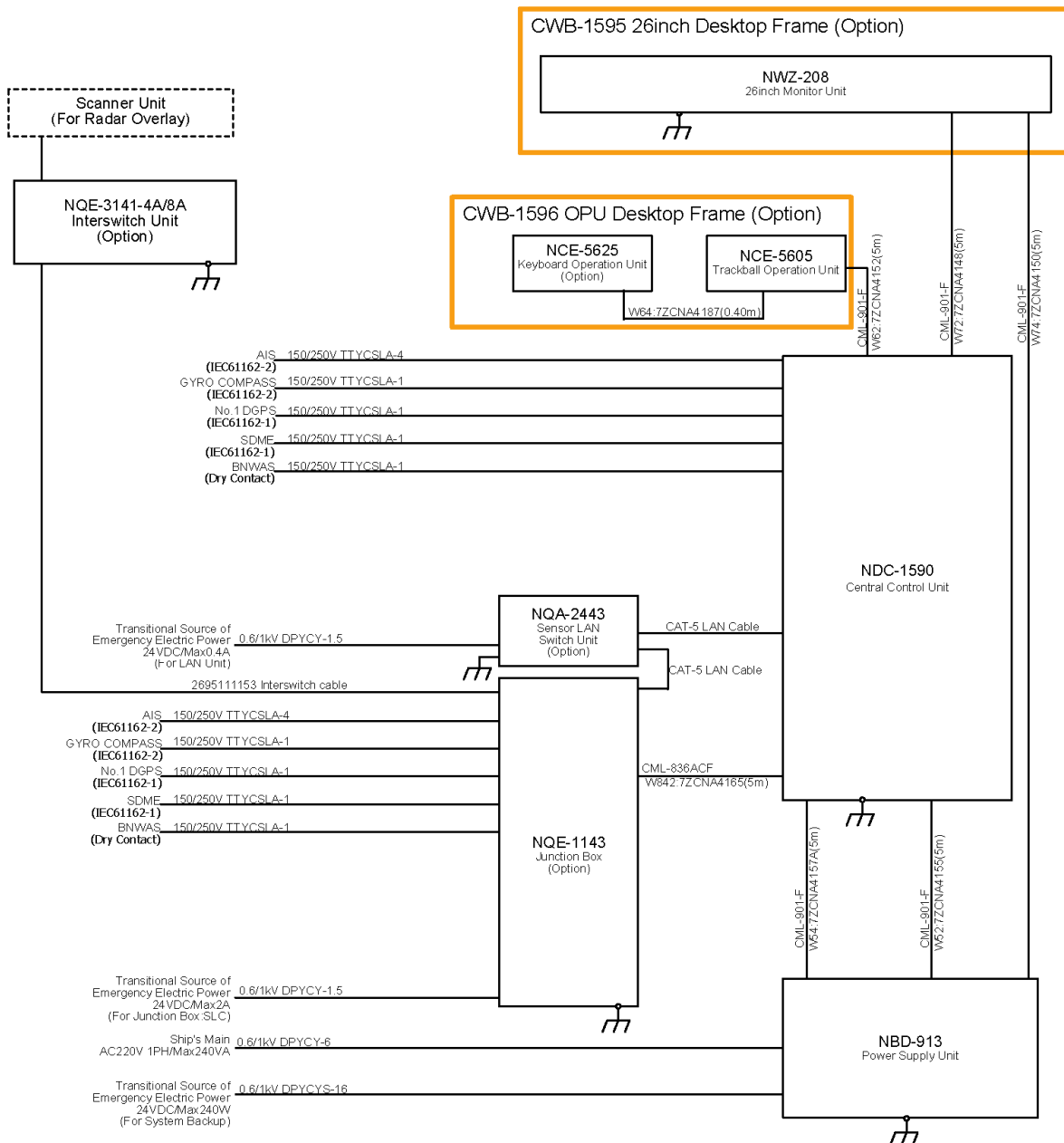

NOTE: ELIMINATING THE INTERFERENCE ON FREQUENCIES USED FOR MARINE COMMUNICATIONS AND NAVIGATION DUE TO OPERATION OF THE RADAR.
 ALL CABLES OF THE RADAR ARE TO BE RUN AWAY FROM THE CABLES OF RADIO EQUIPMENT.
 (ex. RADIOTELEPHONE, COMMUNICATIONS RECEIVER and DIRECTION FINDER, etc.)
 ESPECIALLY INTER-WIRING CABLES BETWEEN SCANNER UNIT AND DISPLAY UNIT OF THE RADAR SHOULD NOT BE RUN PARALLEL WITH THE CABLES OF RADIO EQUIPMENT.

General System Diagram of JAN-9201 ECDIS

6.3.14 JAN-9202

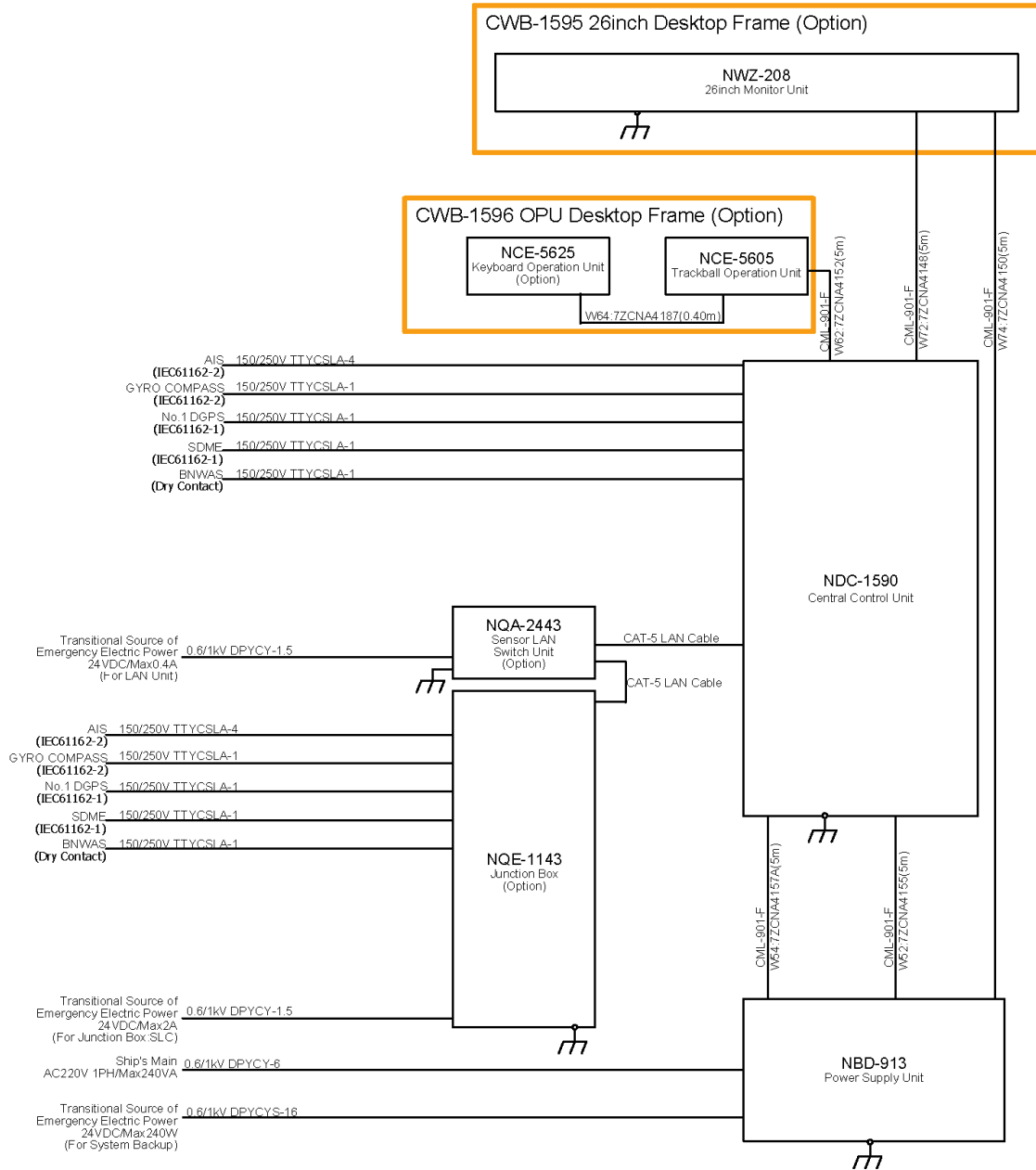

NOTE: ELIMINATING THE INTERFERENCE ON FREQUENCIES USED FOR MARINE COMMUNICATIONS AND NAVIGATION DUE TO OPERATION OF THE RADAR.
 ALL CABLES OF THE RADAR ARE TO BE RUN AWAY FROM THE CABLES OF RADIO EQUIPMENT.
 (ex. RADIOTELEPHONE, COMMUNICATIONS RECEIVER and DIRECTION FINDER, etc.)
 ESPECIALLY INTER-WIRING CABLES BETWEEN SCANNER UNIT AND DISPLAY UNIT OF THE RADAR SHOULD NOT BE RUN PARALLEL WITH THE CABLES OF RADIO EQUIPMENT.

General System Diagram of JAN-9202 CONNING

6.3.15 JMR-7210-6X

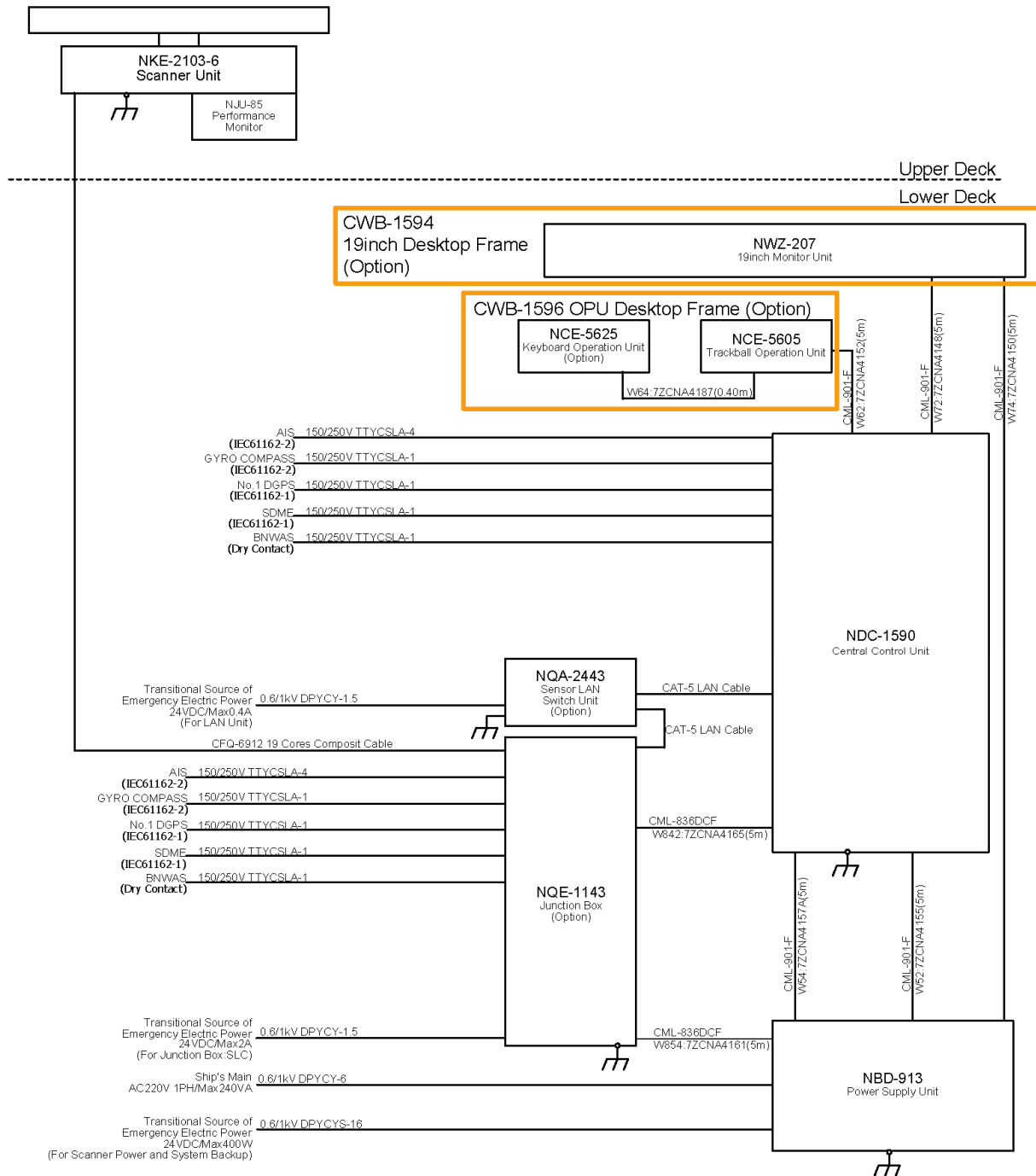

NOTE: ELIMINATING THE INTERFERENCE ON FREQUENCIES USED FOR MARINE COMMUNICATIONS AND NAVIGATION DUE TO OPERATION OF THE RADAR.
 ALL CABLES OF THE RADAR ARE TO BE RUN AWAY FROM THE CABLES OF RADIO EQUIPMENT.
 (ex. RADIOTELEPHONE, COMMUNICATIONS RECEIVER and DIRECTION FINDER, etc.)
 ESPECIALLY INTER-WIRING CABLES BETWEEN SCANNER UNIT AND DISPLAY UNIT OF THE RADAR SHOULD NOT BE RUN PARALLEL WITH THE CABLES OF RADIO EQUIPMENT.

General System Diagram of JMR-7210-6X RADAR

6.3.16 JMR-7210-6XH

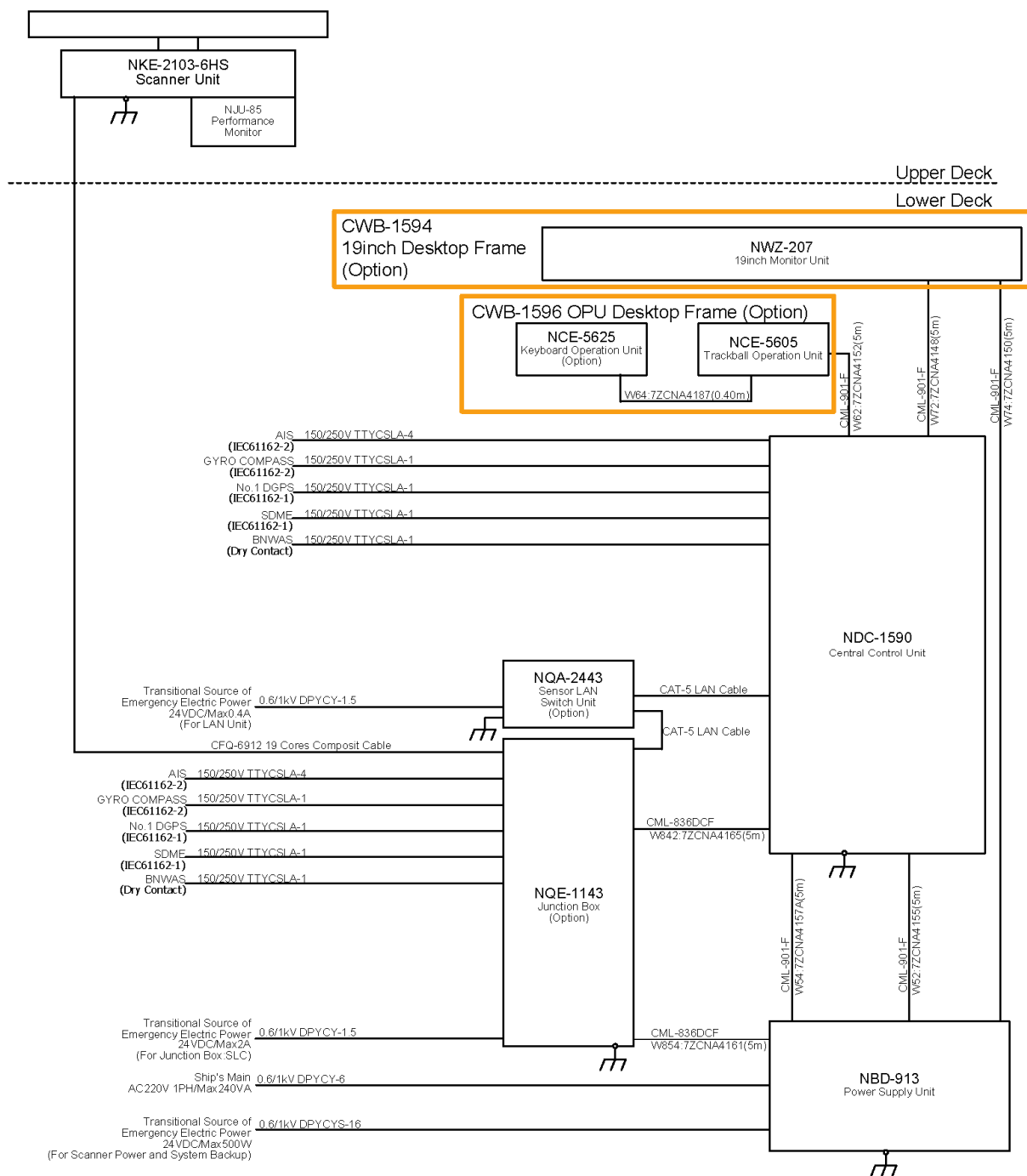

NOTE: ELIMINATING THE INTERFERENCE ON FREQUENCIES USED FOR MARINE COMMUNICATIONS AND NAVIGATION DUE TO OPERATION OF THE RADAR.
 ALL CABLES OF THE RADAR ARE TO BE RUN AWAY FROM THE CABLES OF RADIO EQUIPMENT.
 (ex. RADIOTELEPHONE, COMMUNICATIONS RECEIVER and DIRECTION FINDER, etc.)
 ESPECIALLY INTER-WIRING CABLES BETWEEN SCANNER UNIT AND DISPLAY UNIT OF THE RADAR SHOULD NOT BE RUN PARALLEL WITH THE CABLES OF RADIO EQUIPMENT.

General System Diagram of JMR-7210-6XH RADAR

6.3.17 JMR-7225-6X

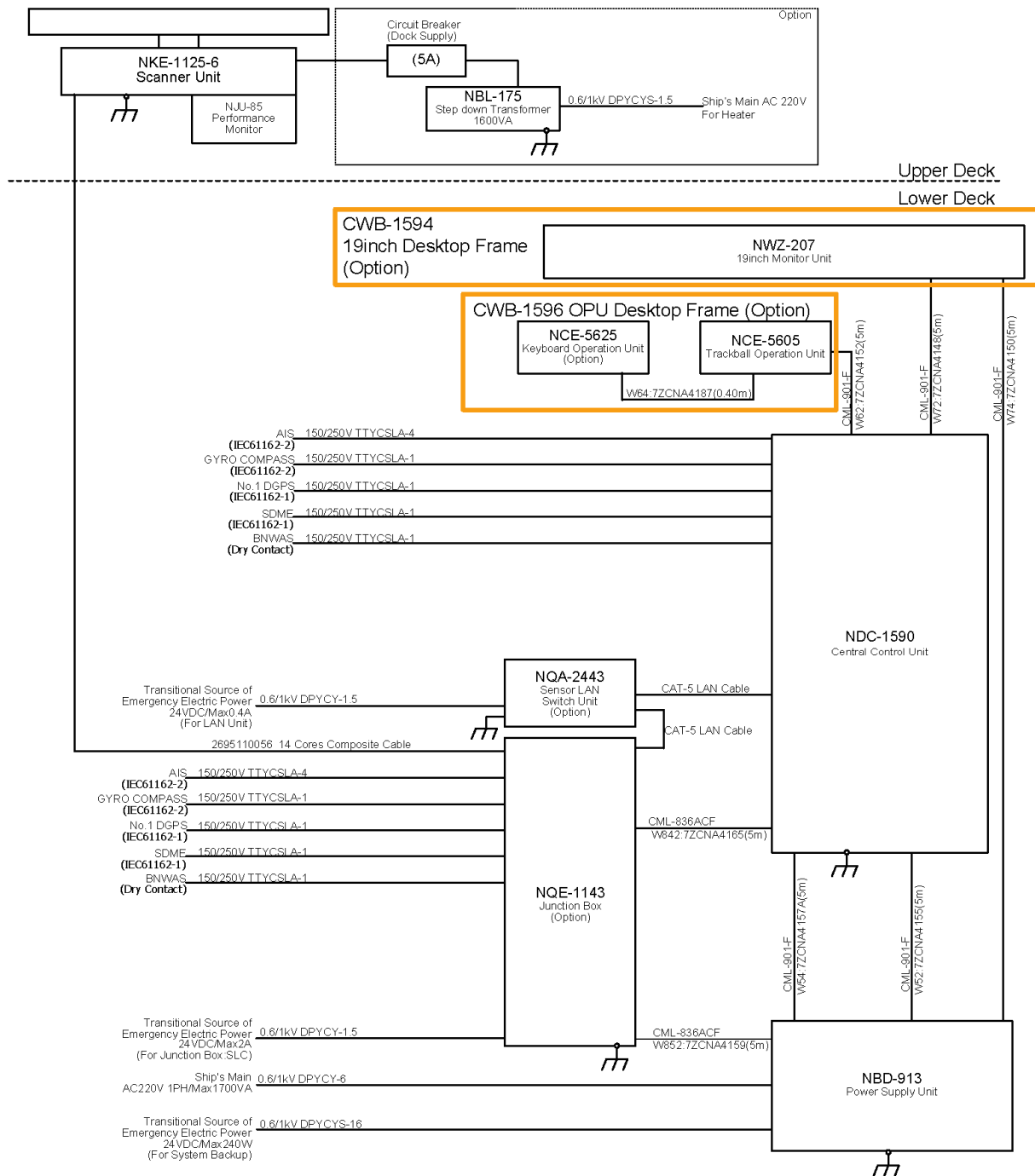

NOTE: ELIMINATING THE INTERFERENCE ON FREQUENCIES USED FOR MARINE COMMUNICATIONS AND NAVIGATION DUE TO OPERATION OF THE RADAR.
 ALL CABLES OF THE RADAR ARE TO BE RUN AWAY FROM THE CABLES OF RADIO EQUIPMENT.
 (ex. RADIOTELEPHONE, COMMUNICATIONS RECEIVER and DIRECTION FINDER, etc.)
 ESPECIALLY INTER-WIRING CABLES BETWEEN SCANNER UNIT AND DISPLAY UNIT OF THE RADAR
 SHOULD NOT BE RUN PARALLEL WITH THE CABLES OF RADIO EQUIPMENT.

General System Diagram of JMR-7225-6X RADAR

6.3.18 JMR-7225-6XH

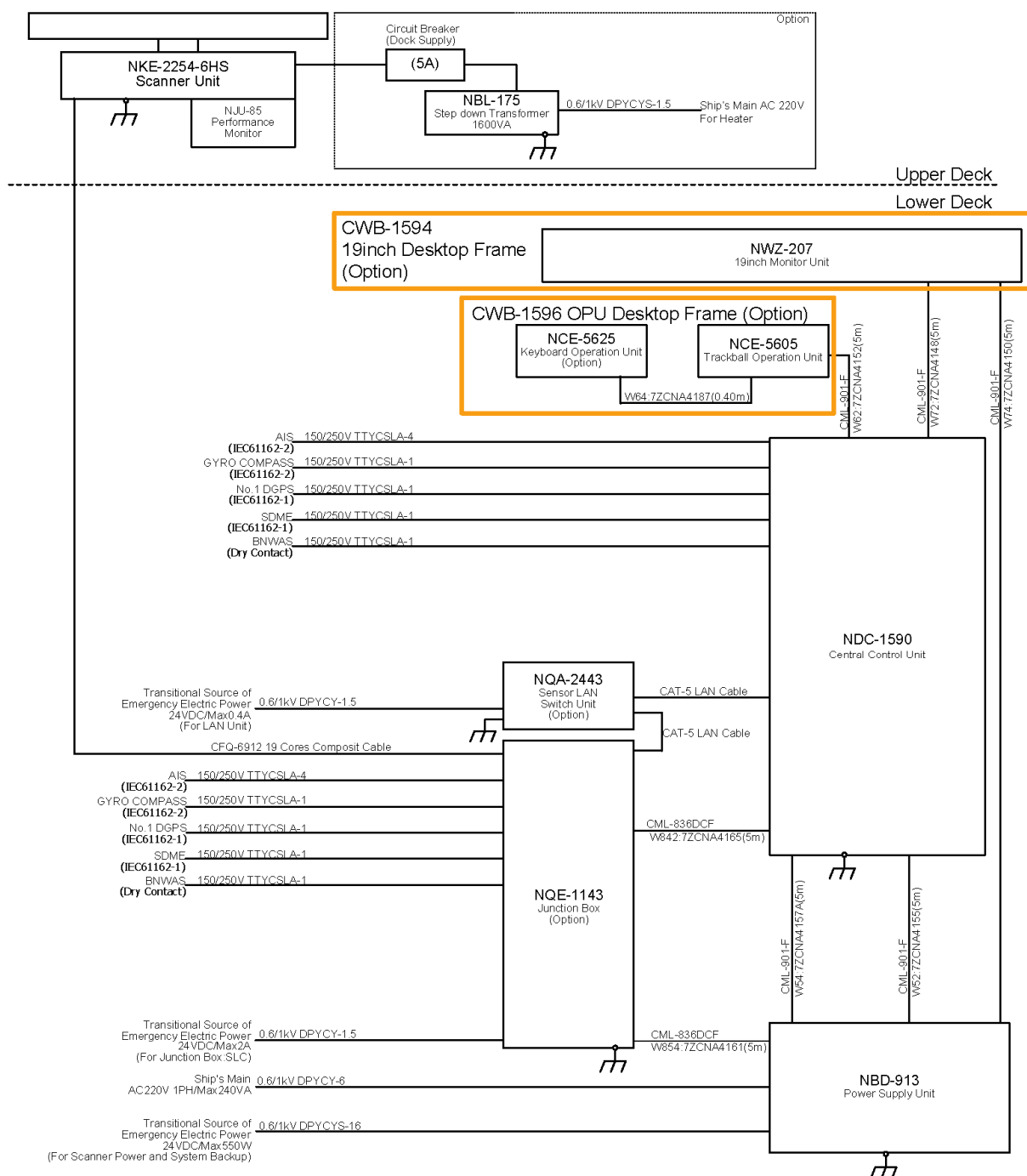

NOTE: ELIMINATING THE INTERFERENCE ON FREQUENCIES USED FOR MARINE COMMUNICATIONS AND NAVIGATION DUE TO OPERATION OF THE RADAR.
 ALL CABLES OF THE RADAR ARE TO BE RUN AWAY FROM THE CABLES OF RADIO EQUIPMENT.
 (ex. RADIOTELEPHONE, COMMUNICATIONS RECEIVER and DIRECTION FINDER, etc.)
 ESPECIALLY INTER-WIRING CABLES BETWEEN SCANNER UNIT AND DISPLAY UNIT OF THE RADAR SHOULD NOT BE RUN PARALLEL WITH THE CABLES OF RADIO EQUIPMENT.

General System Diagram of JMR-7225-6XH RADAR

6.3.19 JMR-7225-9X

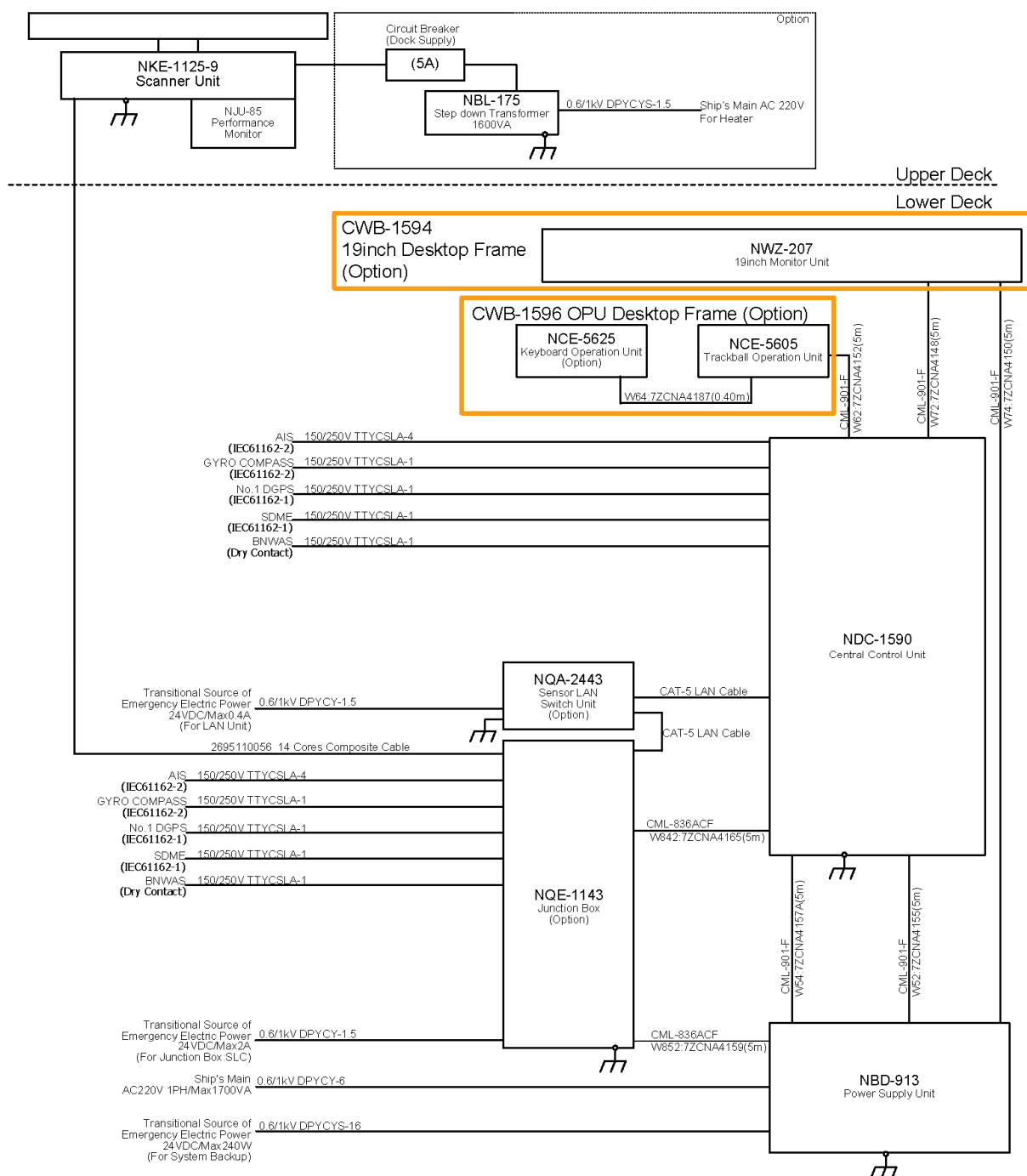

NOTE: ELIMINATING THE INTERFERENCE ON FREQUENCIES USED FOR MARINE COMMUNICATIONS AND NAVIGATION DUE TO OPERATION OF THE RADAR.
 ALL CABLES OF THE RADAR ARE TO BE RUN AWAY FROM THE CABLES OF RADIO EQUIPMENT.
 (ex. RADIOTELEPHONE, COMMUNICATIONS RECEIVER and DIRECTION FINDER, etc.)
 ESPECIALLY INTER-WIRING CABLES BETWEEN SCANNER UNIT AND DISPLAY UNIT OF THE RADAR SHOULD NOT BE RUN PARALLEL WITH THE CABLES OF RADIO EQUIPMENT.

General System Diagram of JMR-7225-9X RADAR

6.3.20 JMR-7225-7X3

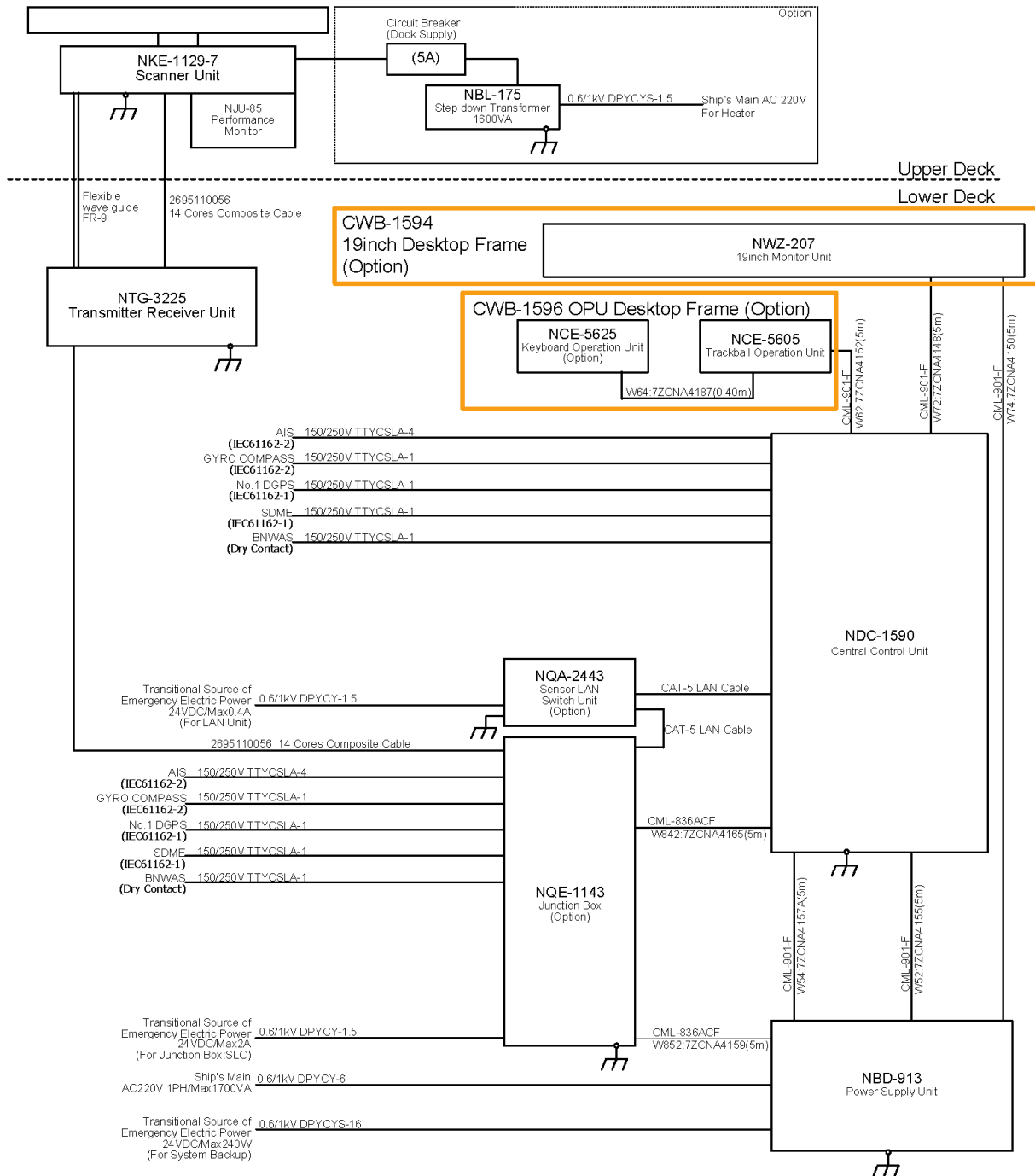

NOTE: ELIMINATING THE INTERFERENCE ON FREQUENCIES USED FOR MARINE COMMUNICATIONS AND NAVIGATION DUE TO OPERATION OF THE RADAR.
 ALL CABLES OF THE RADAR ARE TO BE RUN AWAY FROM THE CABLES OF RADIO EQUIPMENT.
 (ex. RADIOTELEPHONE, COMMUNICATIONS RECEIVER and DIRECTION FINDER, etc.)
 ESPECIALLY INTER-WIRING CABLES BETWEEN SCANNER UNIT AND DISPLAY UNIT OF THE RADAR
 SHOULD NOT BE RUN PARALLEL WITH THE CABLES OF RADIO EQUIPMENT.

General System Diagram of JMR-7225-7X3 RADAR

6.3.21 JMR-7225-9X3

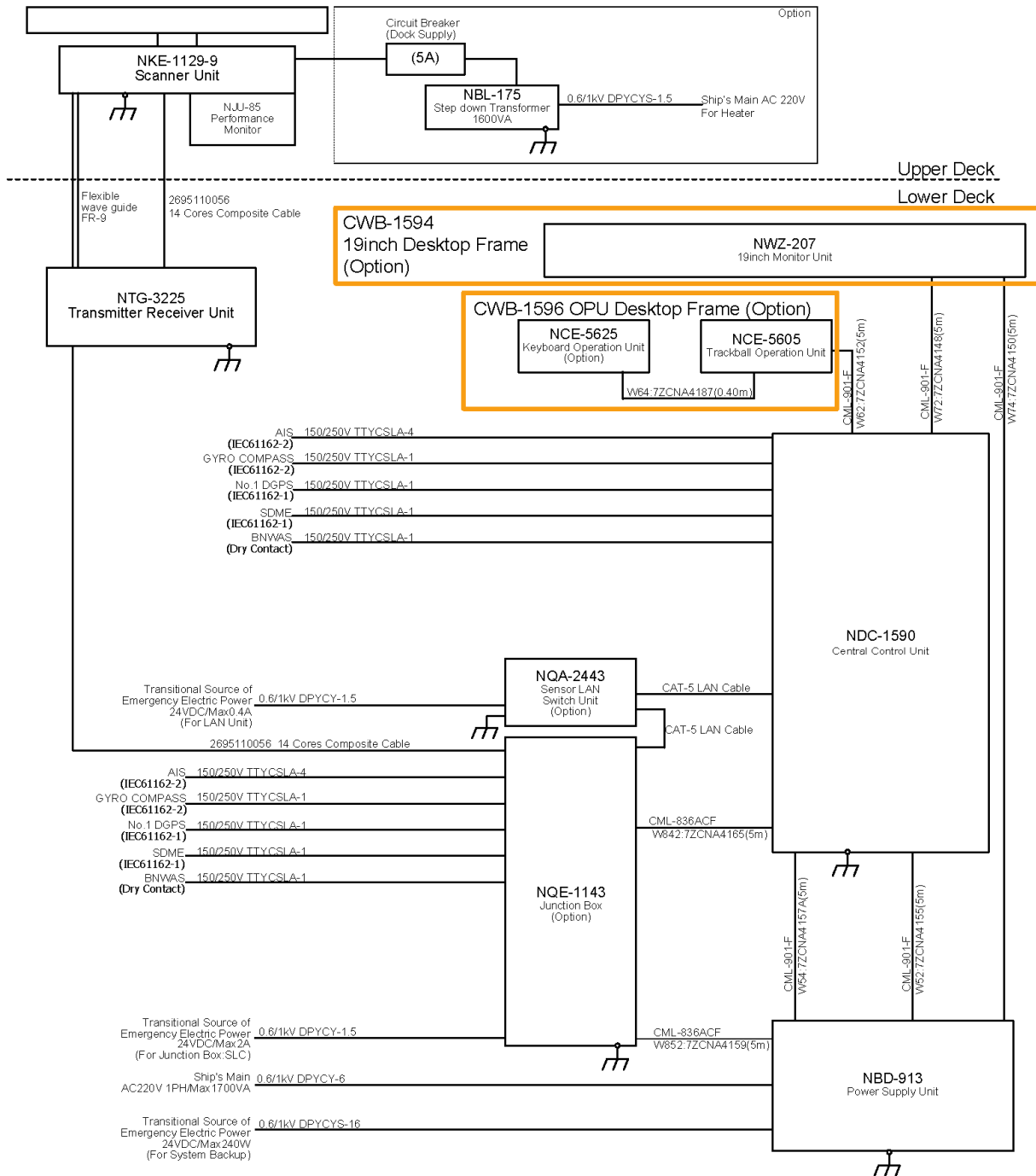

NOTE: ELIMINATING THE INTERFERENCE ON FREQUENCIES USED FOR MARINE COMMUNICATIONS AND NAVIGATION DUE TO OPERATION OF THE RADAR.
 ALL CABLES OF THE RADAR ARE TO BE RUN AWAY FROM THE CABLES OF RADIO EQUIPMENT.
 (ex. RADIOTELEPHONE, COMMUNICATIONS RECEIVER and DIRECTION FINDER, etc.)
 ESPECIALLY INTER-WIRING CABLES BETWEEN SCANNER UNIT AND DISPLAY UNIT OF THE RADAR SHOULD NOT BE RUN PARALLEL WITH THE CABLES OF RADIO EQUIPMENT.

General System Diagram of JMR-7225-9X3 RADAR

6.3.22 JMR-7230-S

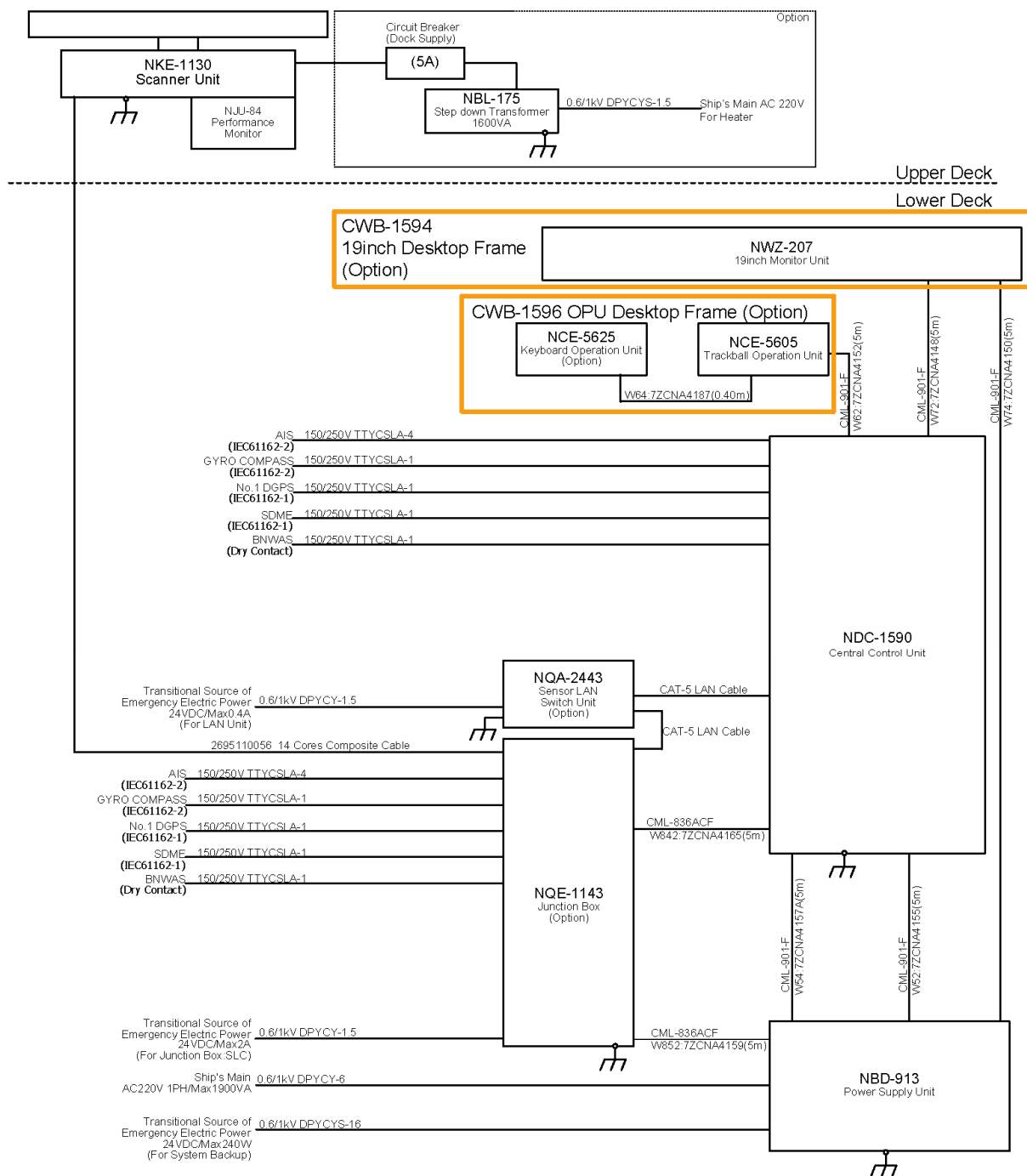

NOTE: ELIMINATING THE INTERFERENCE ON FREQUENCIES USED FOR MARINE COMMUNICATIONS AND NAVIGATION DUE TO OPERATION OF THE RADAR.
 ALL CABLES OF THE RADAR ARE TO BE RUN AWAY FROM THE CABLES OF RADIO EQUIPMENT.
 (ex. RADIOTELEPHONE, COMMUNICATIONS RECEIVER and DIRECTION FINDER, etc.)
 ESPECIALLY INTER-WIRING CABLES BETWEEN SCANNER UNIT AND DISPLAY UNIT OF THE RADAR SHOULD NOT BE RUN PARALLEL WITH THE CABLES OF RADIO EQUIPMENT.

General System Diagram of JMR-7230-S RADAR

6.3.23 JMR-7230-S3

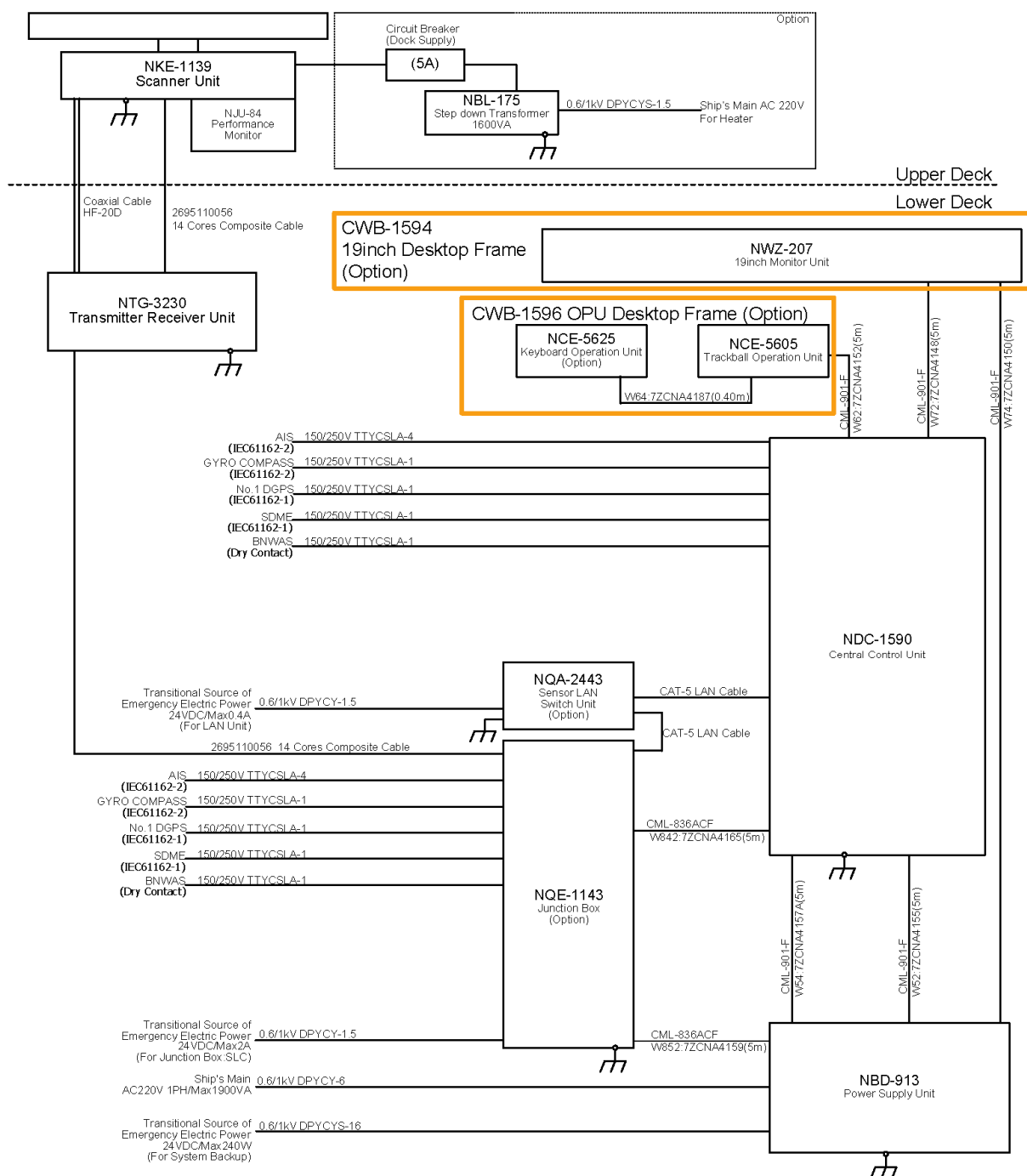

NOTE: ELIMINATING THE INTERFERENCE ON FREQUENCIES USED FOR MARINE COMMUNICATIONS AND NAVIGATION DUE TO OPERATION OF THE RADAR.
 ALL CABLES OF THE RADAR ARE TO BE RUN AWAY FROM THE CABLES OF RADIO EQUIPMENT.
 (ex. RADIOTELEPHONE, COMMUNICATIONS RECEIVER and DIRECTION FINDER, etc.)
 ESPECIALLY INTER-WIRING CABLES BETWEEN SCANNER UNIT AND DISPLAY UNIT OF THE RADAR SHOULD NOT BE RUN PARALLEL WITH THE CABLES OF RADIO EQUIPMENT.

General System Diagram of JMR-7230-S3 RADAR

6.3.24 JMR-7272-S

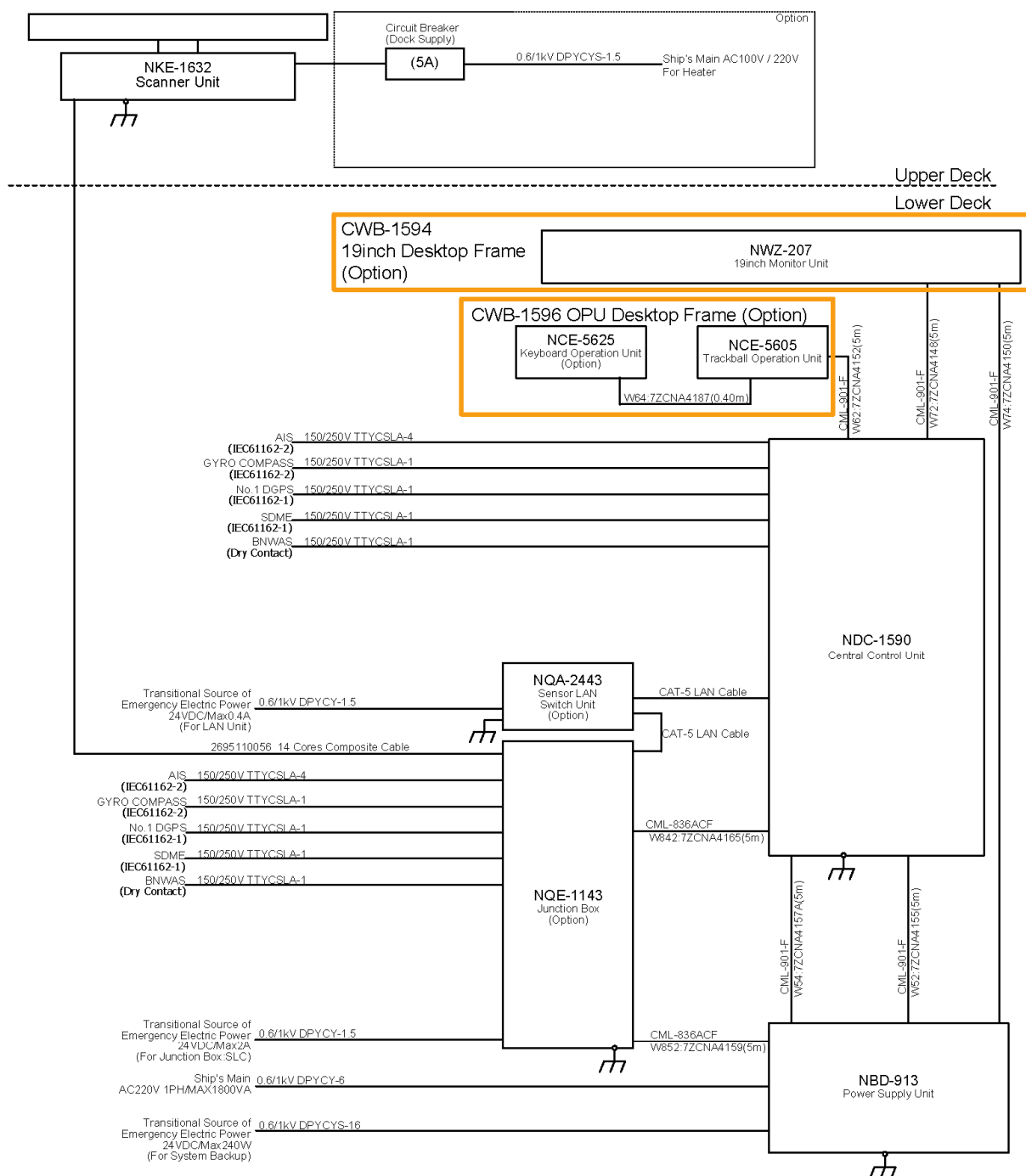

NOTE: ELIMINATING THE INTERFERENCE ON FREQUENCIES USED FOR MARINE COMMUNICATIONS AND NAVIGATION DUE TO OPERATION OF THE RADAR.
 ALL CABLES OF THE RADAR ARE TO BE RUN AWAY FROM THE CABLES OF RADIO EQUIPMENT.
 (ex. RADIOTELEPHONE, COMMUNICATIONS RECEIVER and DIRECTION FINDER, etc.)
 ESPECIALLY INTER-WIRING CABLES BETWEEN SCANNER UNIT AND DISPLAY UNIT OF THE RADAR SHOULD NOT BE RUN PARALLEL WITH THE CABLES OF RADIO EQUIPMENT.

General System Diagram of JMR-7272-S RADAR

6.3.25 JMR-7282-S

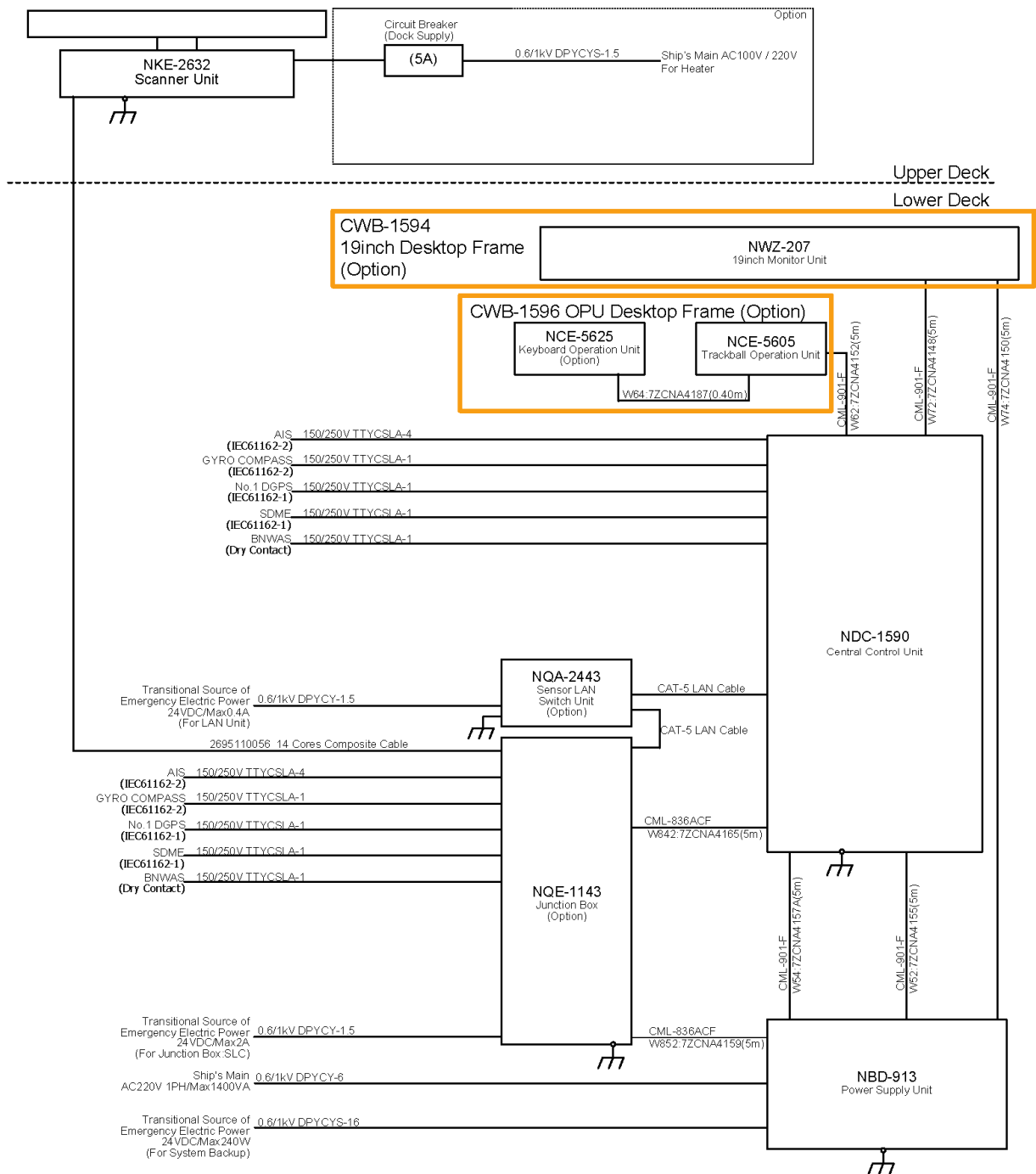

NOTE: ELIMINATING THE INTERFERENCE ON FREQUENCIES USED FOR MARINE COMMUNICATIONS AND NAVIGATION DUE TO OPERATION OF THE RADAR.
 ALL CABLES OF THE RADAR ARE TO BE RUN AWAY FROM THE CABLES OF RADIO EQUIPMENT.
 (ex. RADIOTELEPHONE, COMMUNICATIONS RECEIVER and DIRECTION FINDER, etc.)
 ESPECIALLY INTER-WIRING CABLES BETWEEN SCANNER UNIT AND DISPLAY UNIT OF THE RADAR SHOULD NOT BE RUN PARALLEL WITH THE CABLES OF RADIO EQUIPMENT.

General System Diagram of JMR-7282-S RADAR

6.3.26 JMR-7282-SH

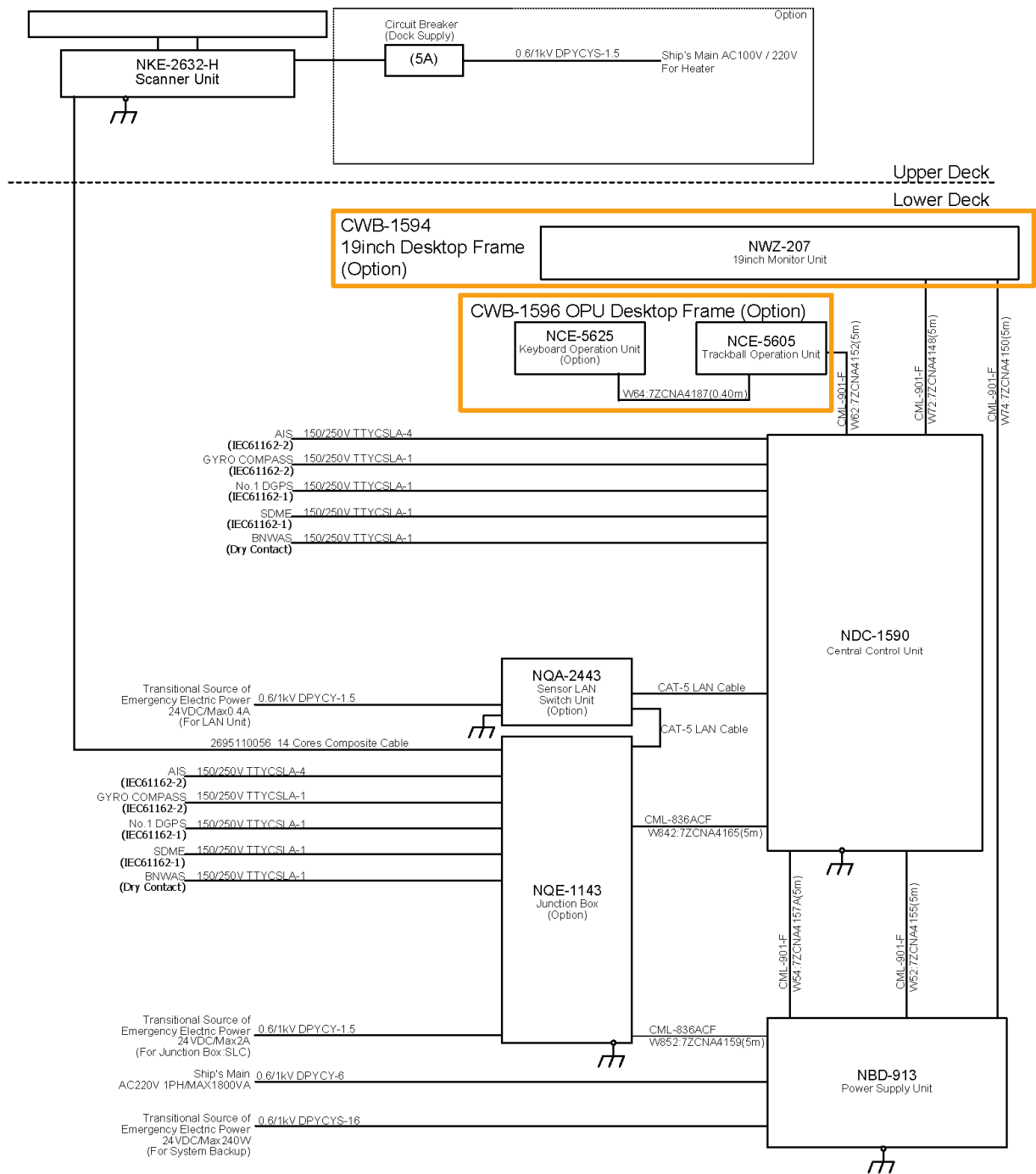

NOTE: ELIMINATING THE INTERFERENCE ON FREQUENCIES USED FOR MARINE COMMUNICATIONS AND NAVIGATION DUE TO OPERATION OF THE RADAR.
 ALL CABLES OF THE RADAR ARE TO BE RUN AWAY FROM THE CABLES OF RADIO EQUIPMENT.
 (ex. RADIOTELEPHONE, COMMUNICATIONS RECEIVER and DIRECTION FINDER, etc.)
 ESPECIALLY INTER-WIRING CABLES BETWEEN SCANNER UNIT AND DISPLAY UNIT OF THE RADAR SHOULD NOT BE RUN PARALLEL WITH THE CABLES OF RADIO EQUIPMENT.

General System Diagram of JMR-7282-SH RADAR

6.3.27 JAN-7201

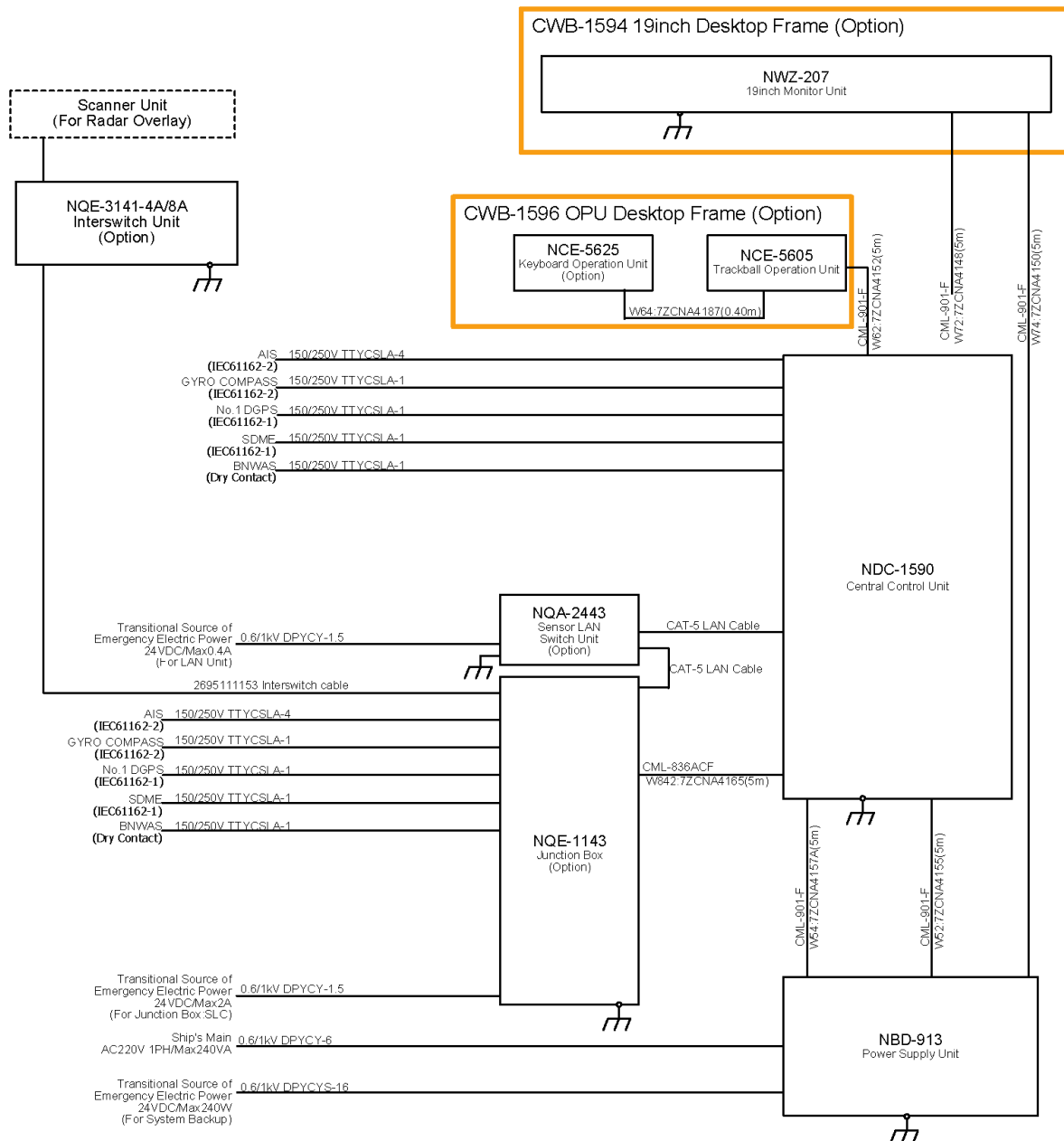

NOTE: ELIMINATING THE INTERFERENCE ON FREQUENCIES USED FOR MARINE COMMUNICATIONS AND NAVIGATION DUE TO OPERATION OF THE RADAR.
 ALL CABLES OF THE RADAR ARE TO BE RUN AWAY FROM THE CABLES OF RADIO EQUIPMENT.
 (ex. RADIOTELEPHONE, COMMUNICATIONS RECEIVER and DIRECTION FINDER, etc.)
 ESPECIALLY INTER-WIRING CABLES BETWEEN SCANNER UNIT AND DISPLAY UNIT OF THE RADAR SHOULD NOT BE RUN PARALLEL WITH THE CABLES OF RADIO EQUIPMENT.

General System Diagram of JAN-7201 ECDIS

6.3.28 JAN-7202

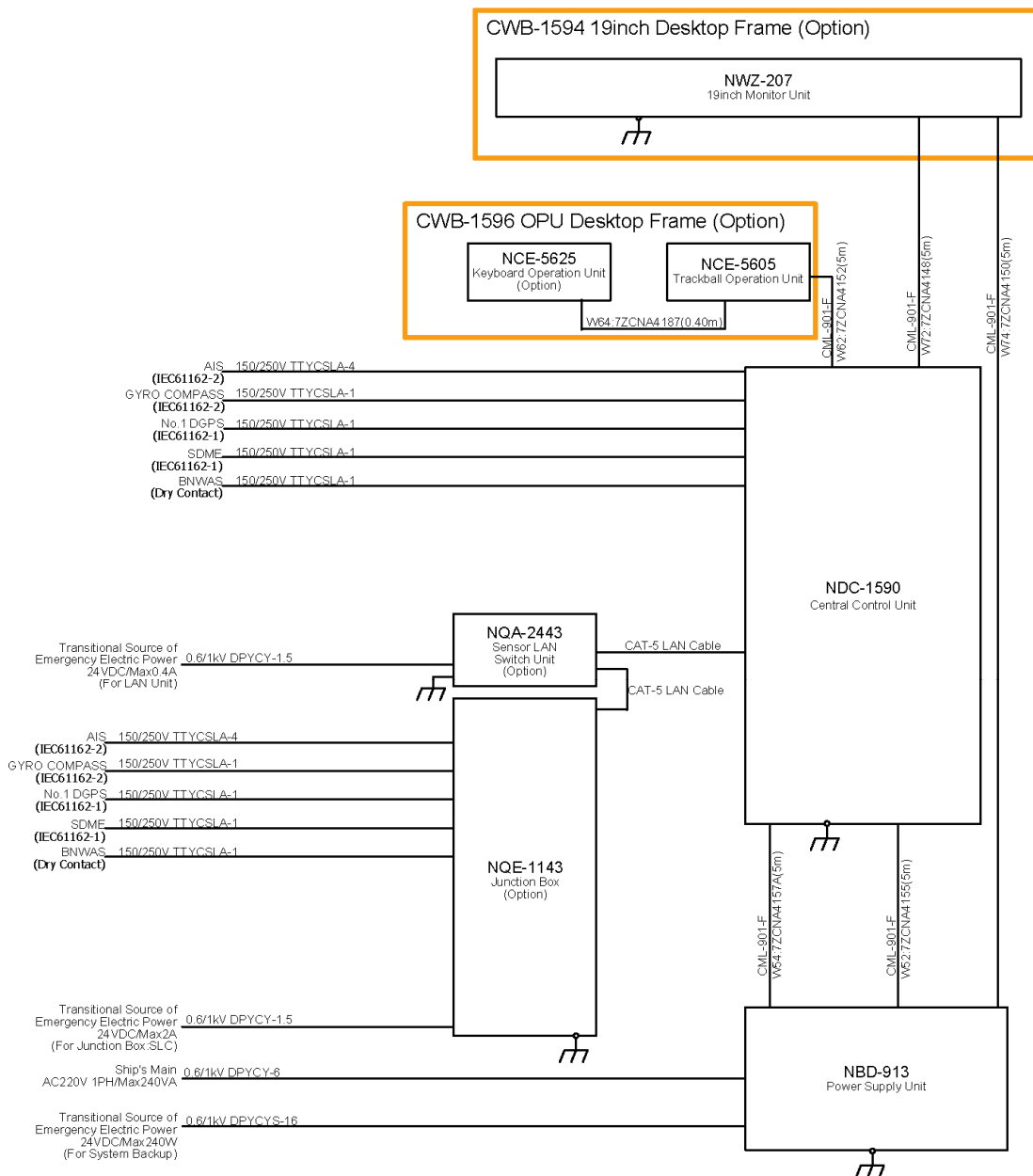

NOTE: ELIMINATING THE INTERFERENCE ON FREQUENCIES USED FOR MARINE COMMUNICATIONS AND NAVIGATION DUE TO OPERATION OF THE RADAR.
 ALL CABLES OF THE RADAR ARE TO BE RUN AWAY FROM THE CABLES OF RADIO EQUIPMENT.
 (ex. RADIOTELEPHONE, COMMUNICATIONS RECEIVER and DIRECTION FINDER, etc.)
 ESPECIALLY INTER-WIRING CABLES BETWEEN SCANNER UNIT AND DISPLAY UNIT OF THE RADAR SHOULD NOT BE RUN PARALLEL WITH THE CABLES OF RADIO EQUIPMENT.

General System Diagram of JAN-7202 CONNING

6.4 Interconnection Diagram of Standalone Type

6.4.1 JMR-9210-6X/6XH

CWA-246 26inch Display Unit Mount Kit

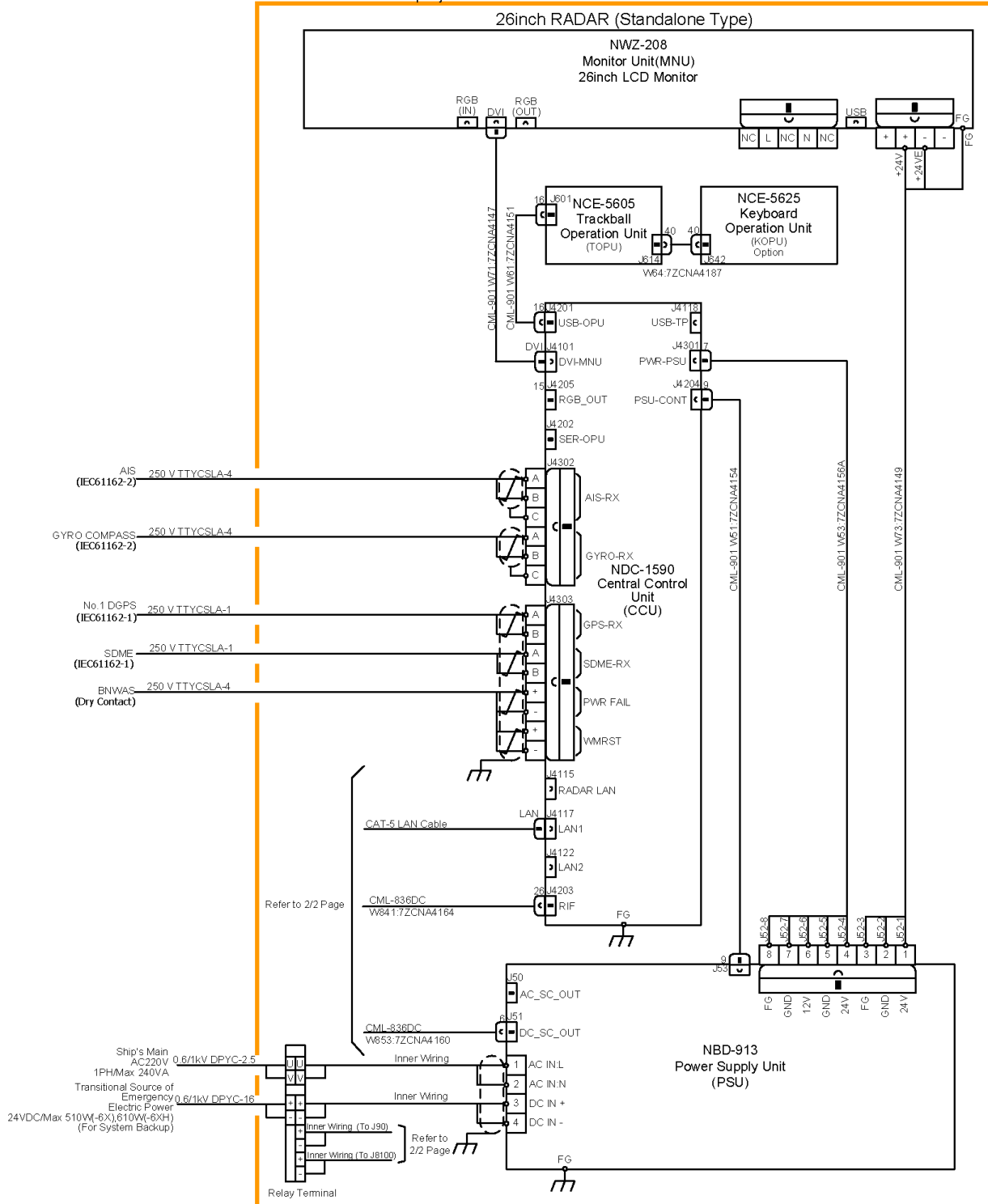

Interconnection Diagram of JMR-9210-6X/6XH RADAR (1/2)

CWA-246 26inch Display Unit Mount Kit

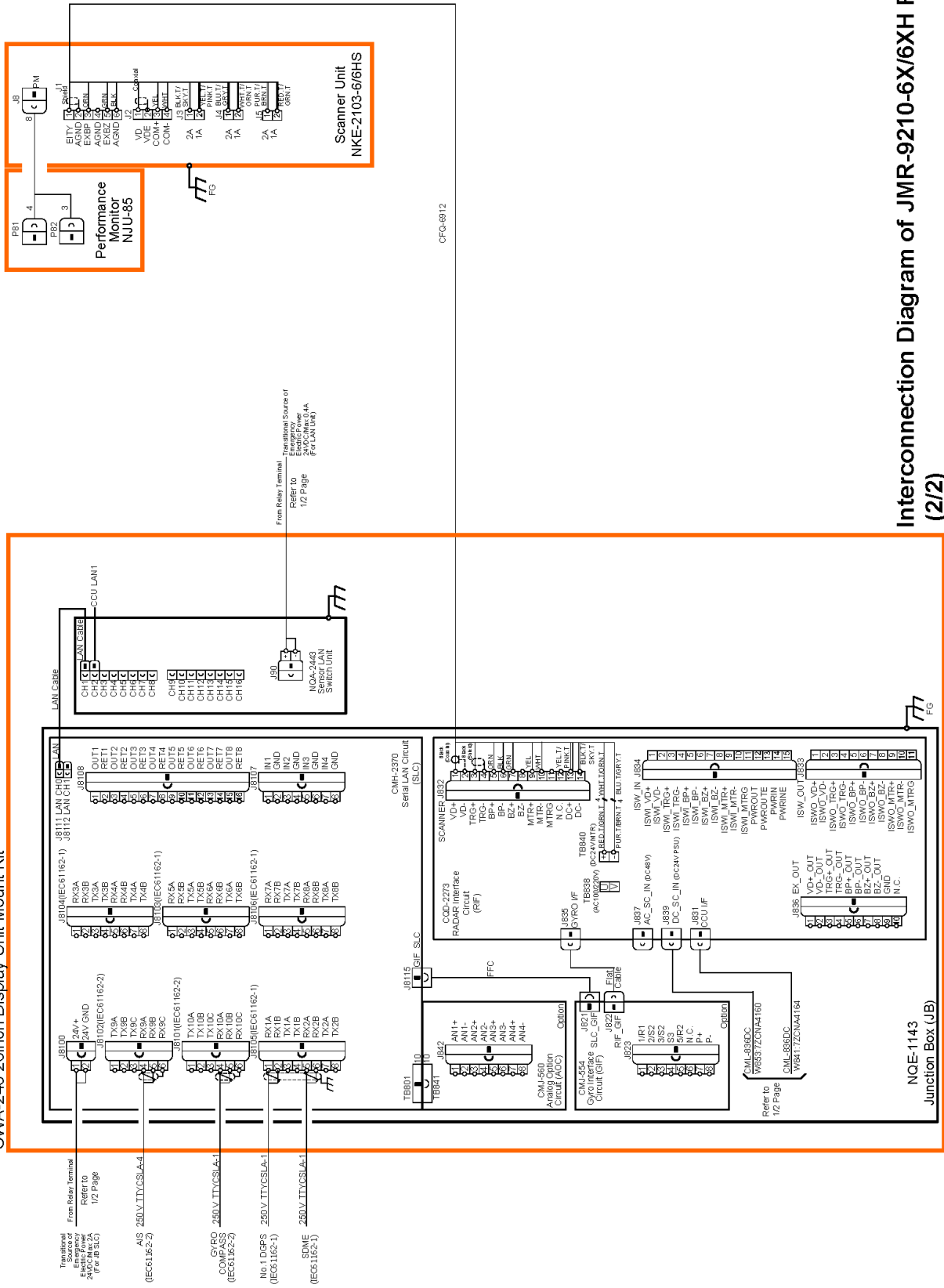

Interconnection Diagram of JMR-9210-6X/6XH RADAR (2/2)

6.4.2 JMR-9225-6X/9X

CWA-246 26inch Display Unit Mount Kit

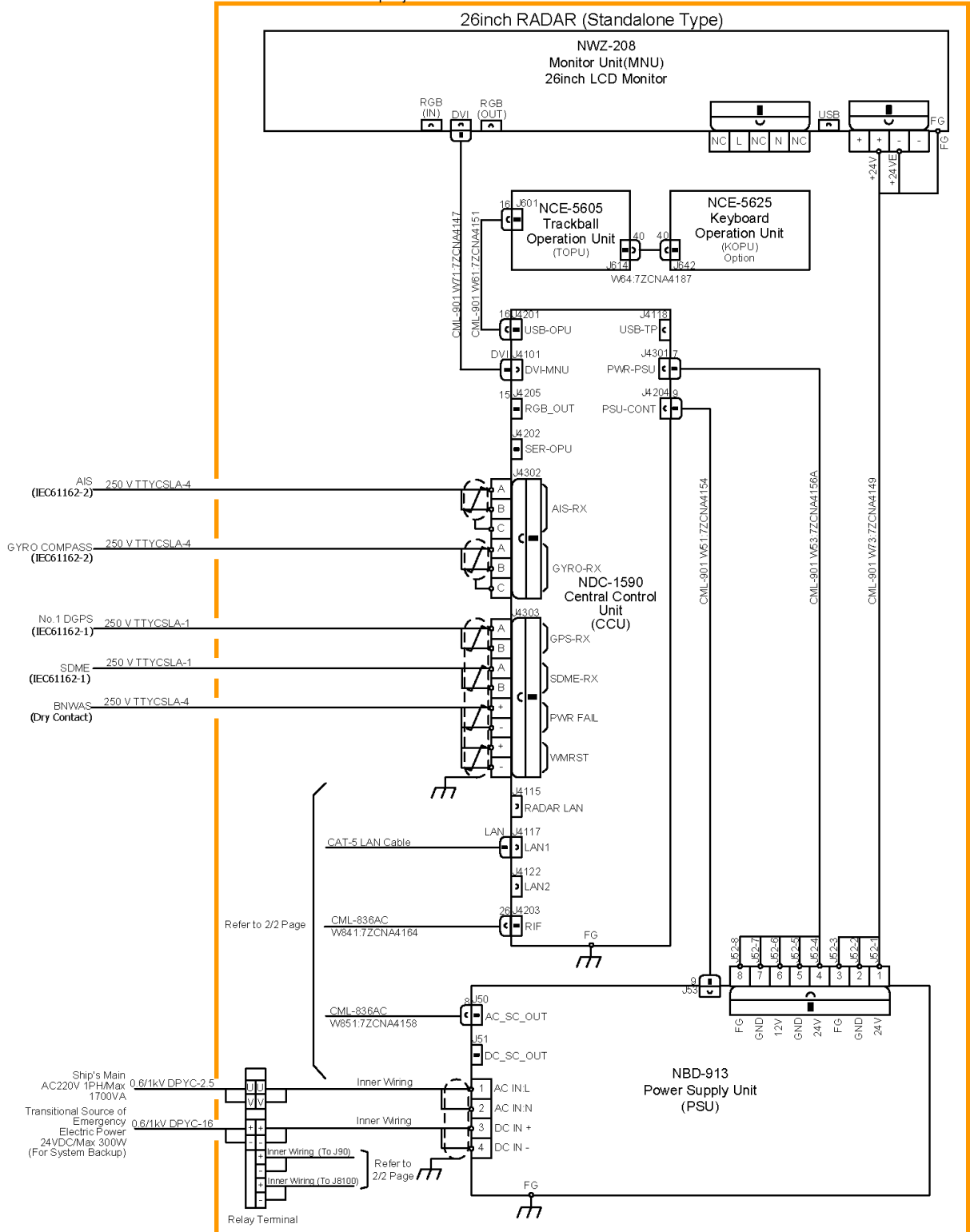

Interconnection Diagram of JMR-9225-6X/9X RADAR (1/2)

CWA-246 26inch Display Unit Mount Kit

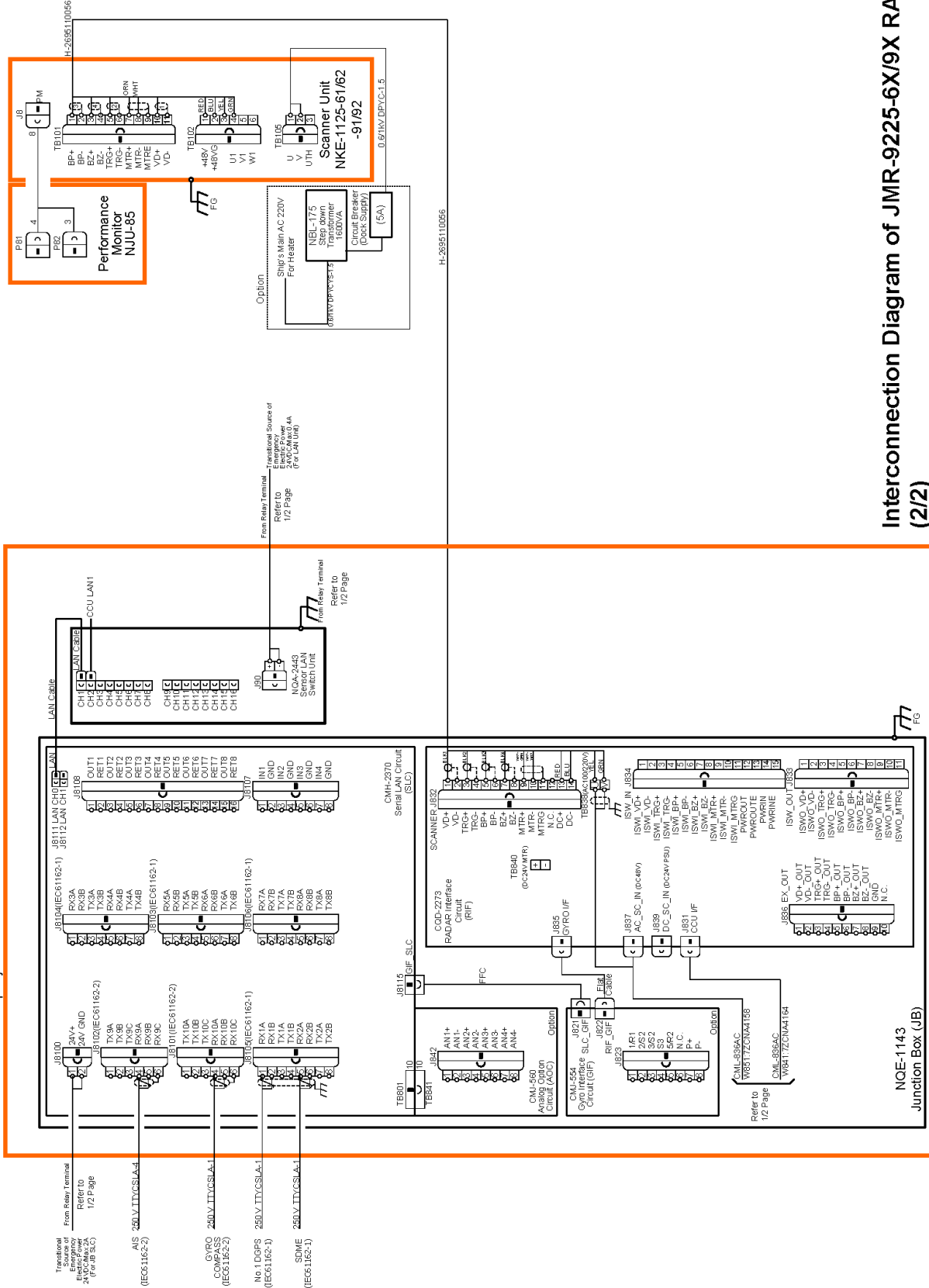

Interconnection Diagram of JMR-9225-6X/9X RADAR (2/2)

6.4.3 JMR-9225-6XH

CWA-246 26inch Display Unit Mount Kit

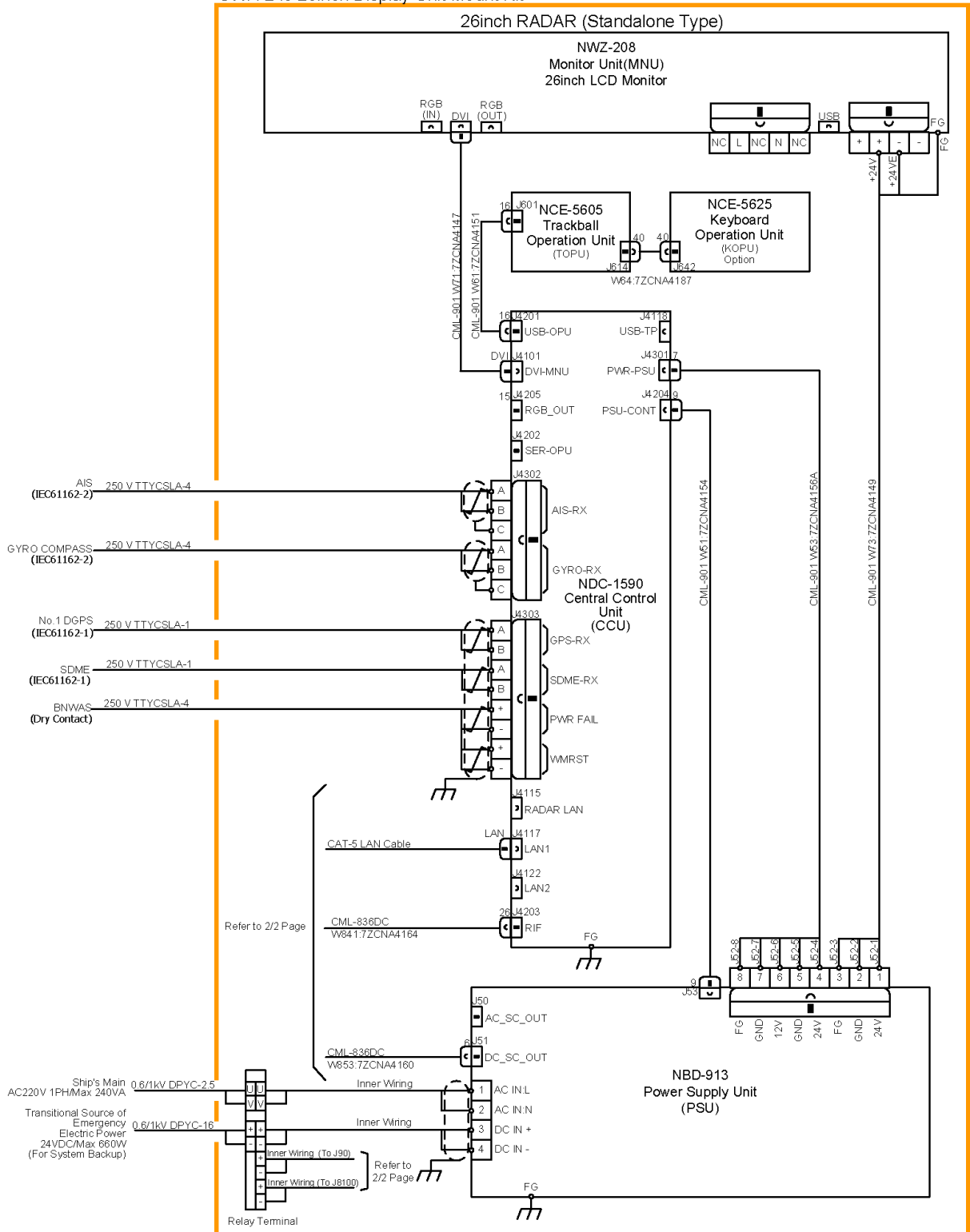

Interconnection Diagram of JMR-9225-6XH RADAR (1/2)

CWA-246 26inch Display Unit Mount Kit

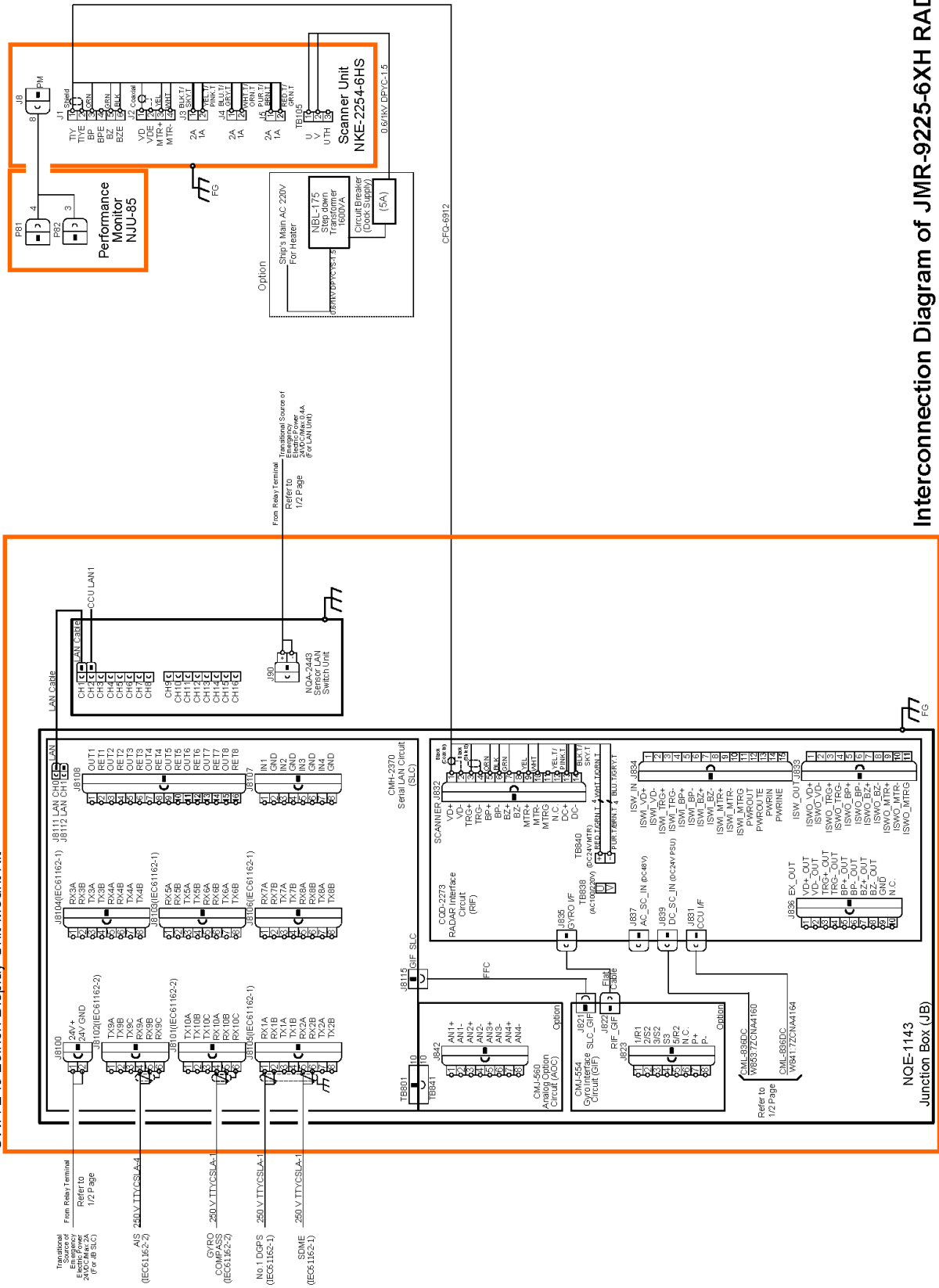

Interconnection Diagram of JMR-9225-6XH RADAR (2/2)

6.4.4 JMR-9225-7X3/9X3

CWA-246 26inch Display Unit Mount Kit

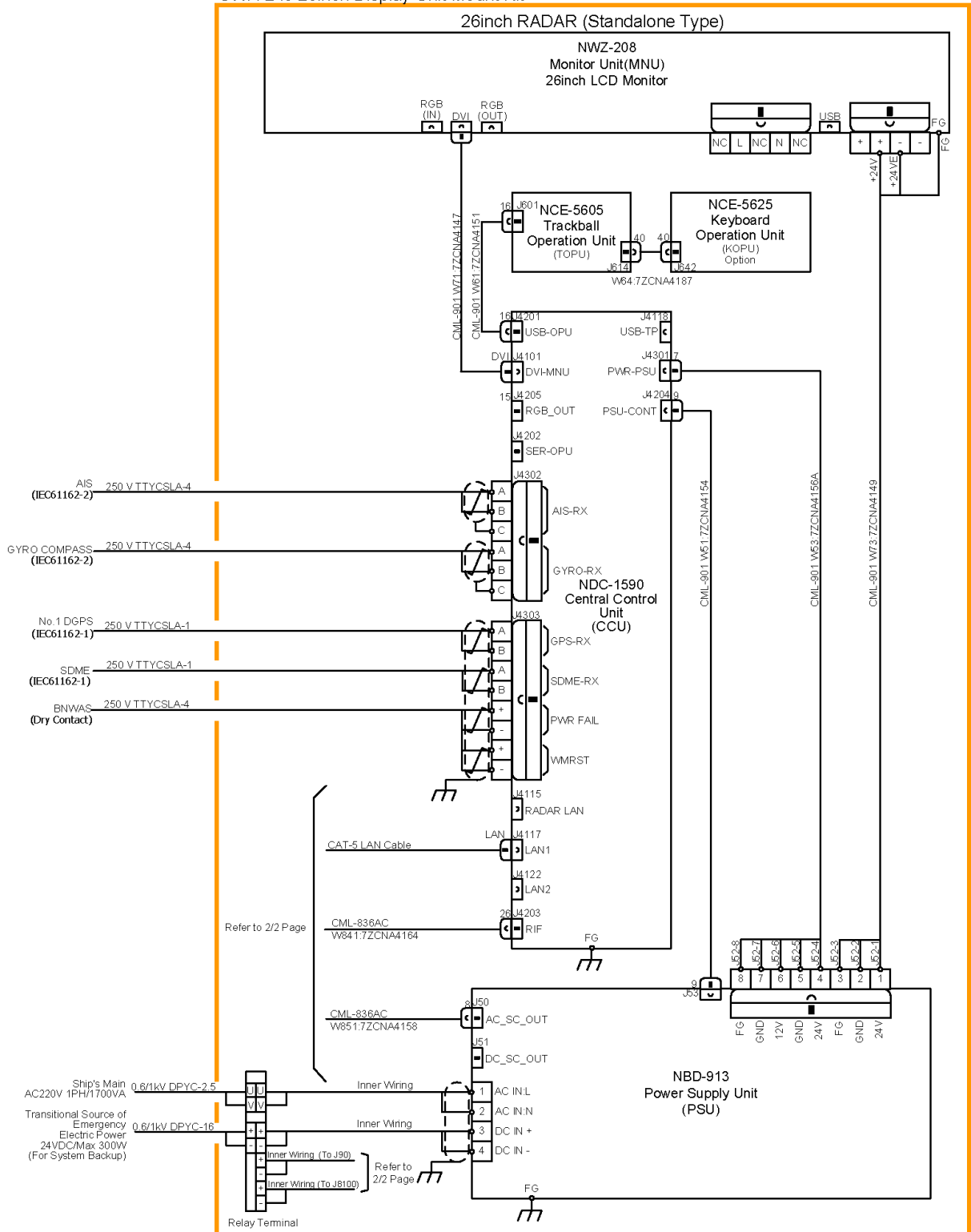

Interconnection Diagram of JMR-9225-7X3/9X3 RADAR (1/2)

CWA-246 26inch Display Unit Mount Kit

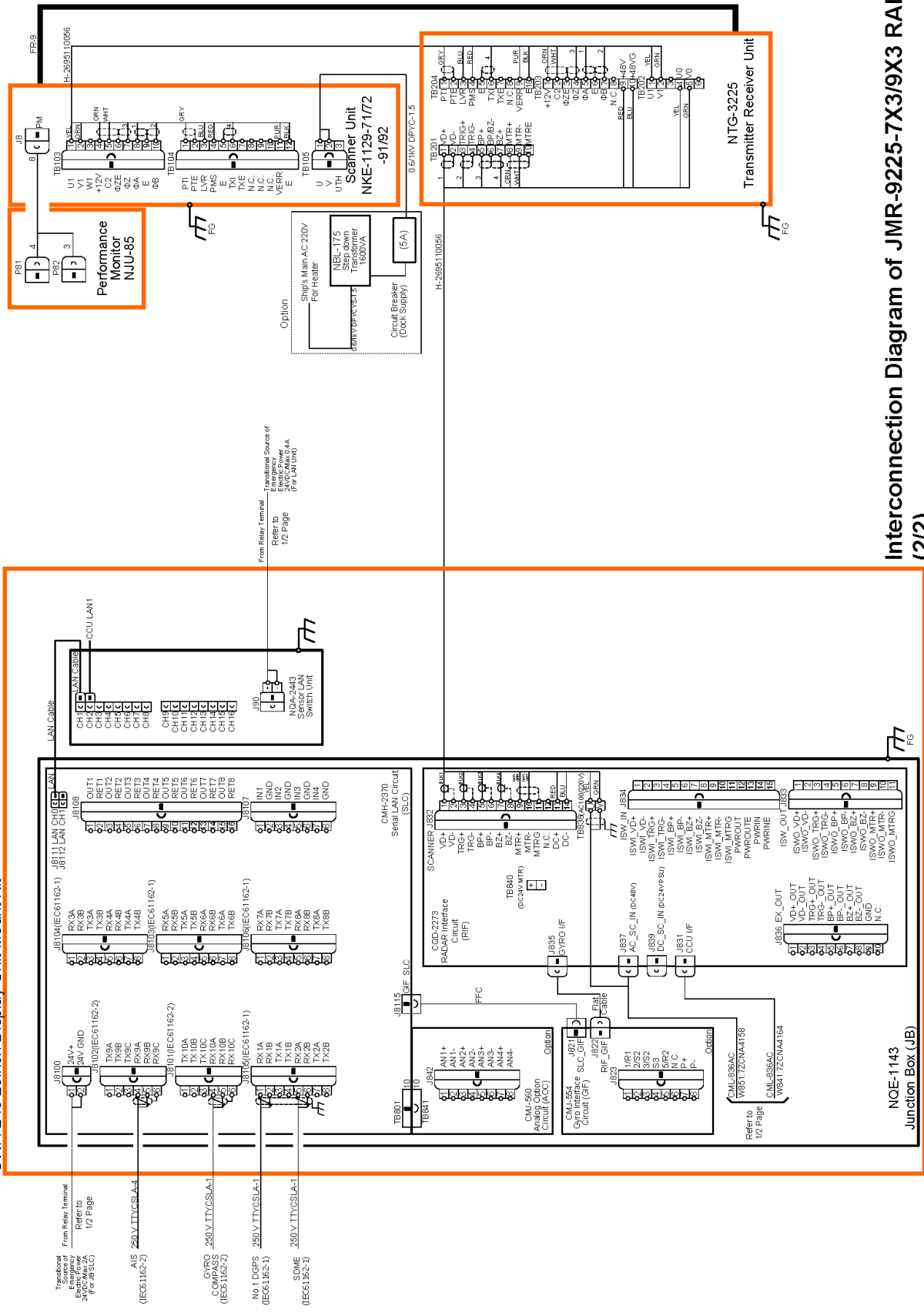

Interconnection Diagram of JMR-9225-7X3/9X3 RADAR (2/2)

6.4.5 JMR-9230-S

CWA-246 26inch Display Unit Mount Kit

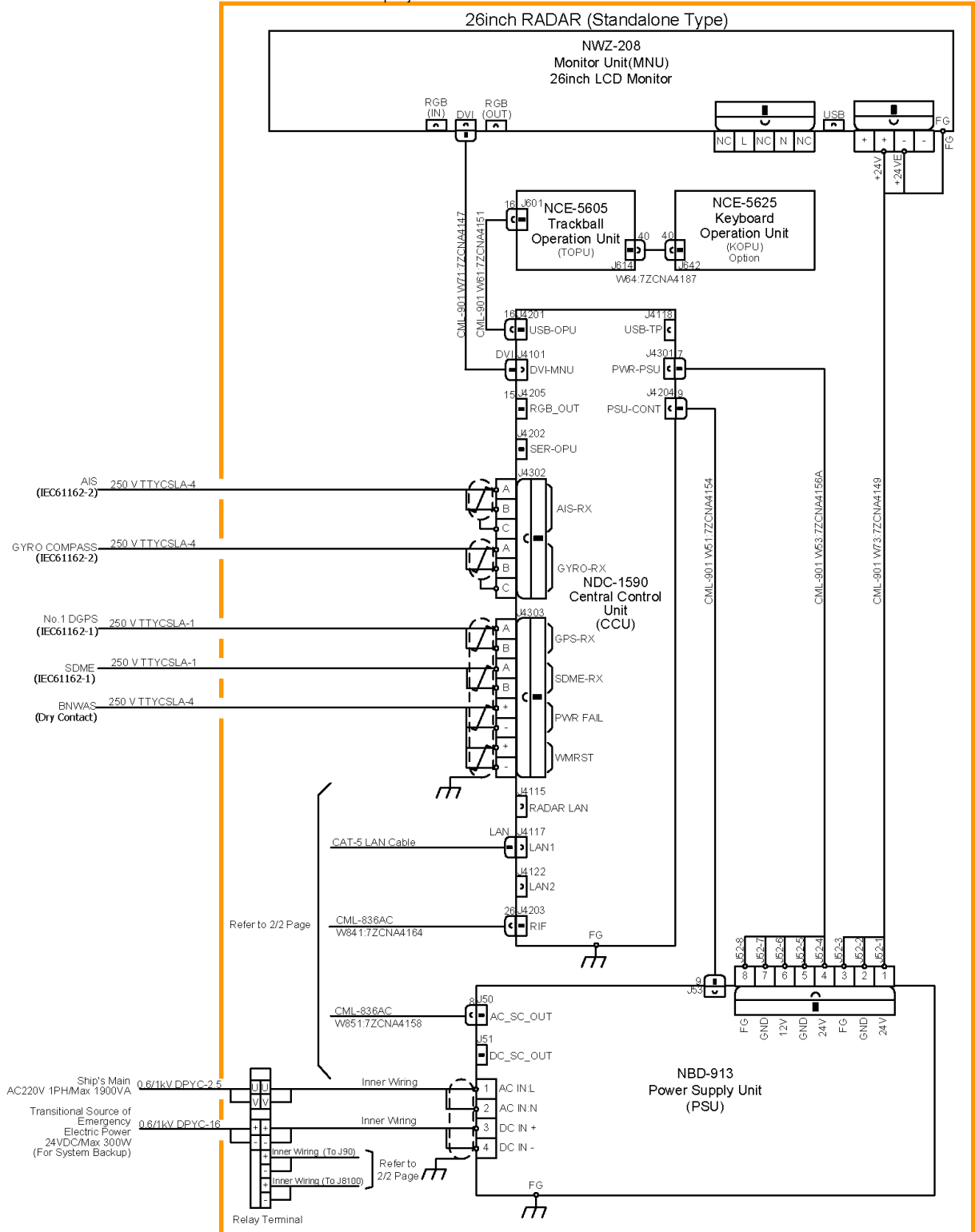

Interconnection Diagram of JMR-9230-S RADAR (1/2)

CWA-246 26inch Display Unit Mount Kit

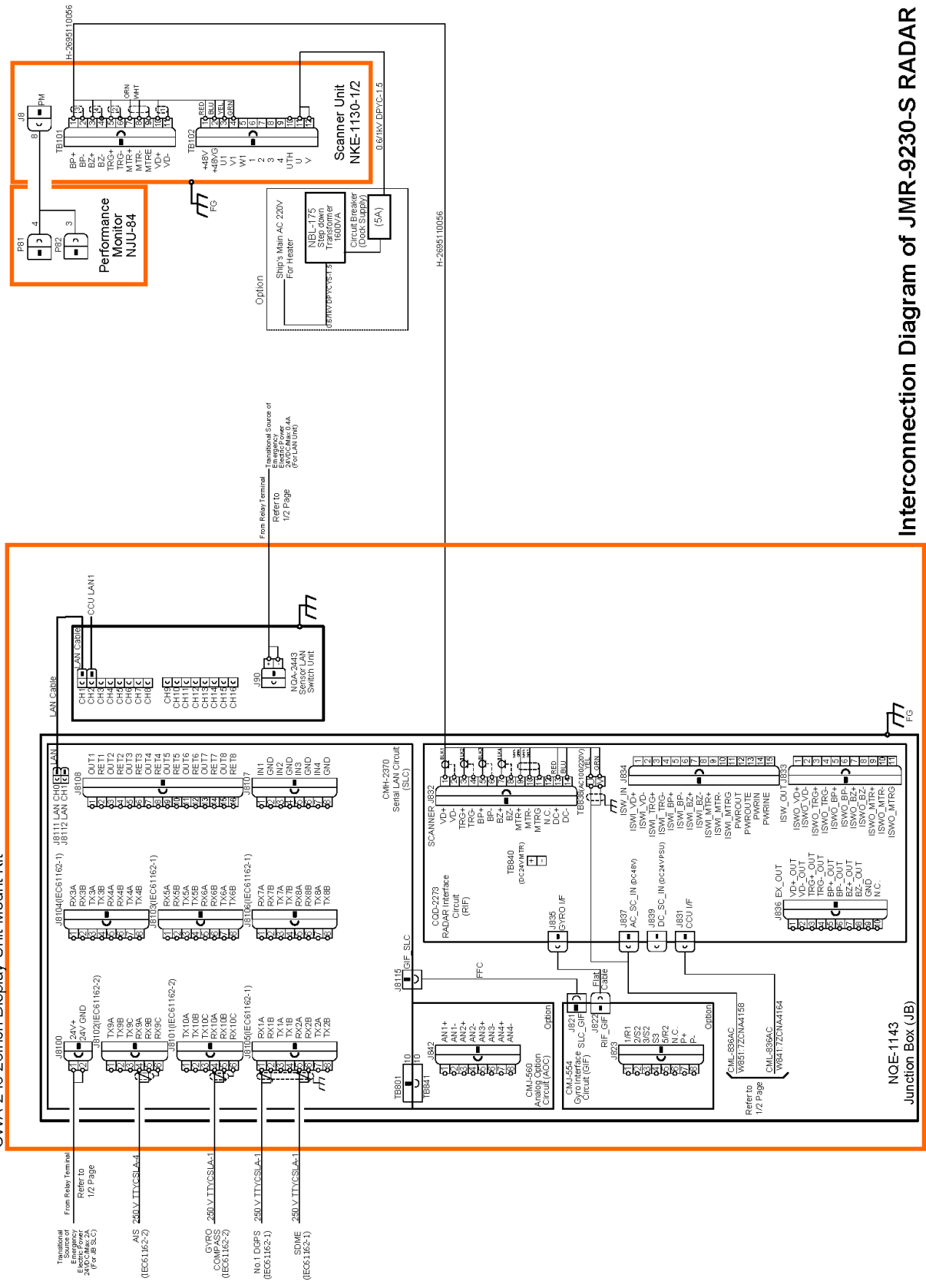

Interconnection Diagram of JMR-9230-S RADAR (2/2)

6.4.6 JMR-9230-S3

CWA-246 26inch Display Unit Mount Kit

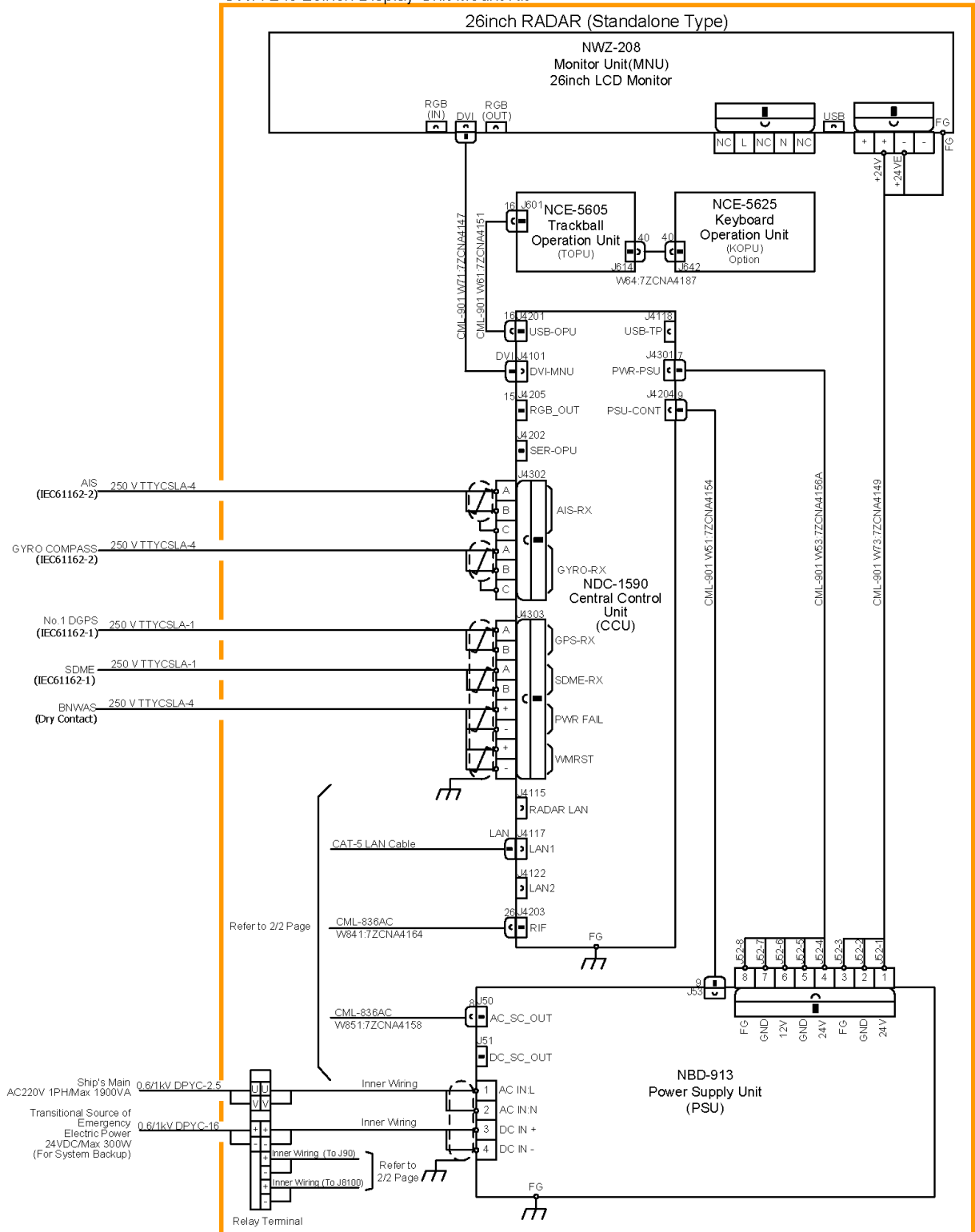

Interconnection Diagram of JMR-9230-S3 RADAR (1/2)

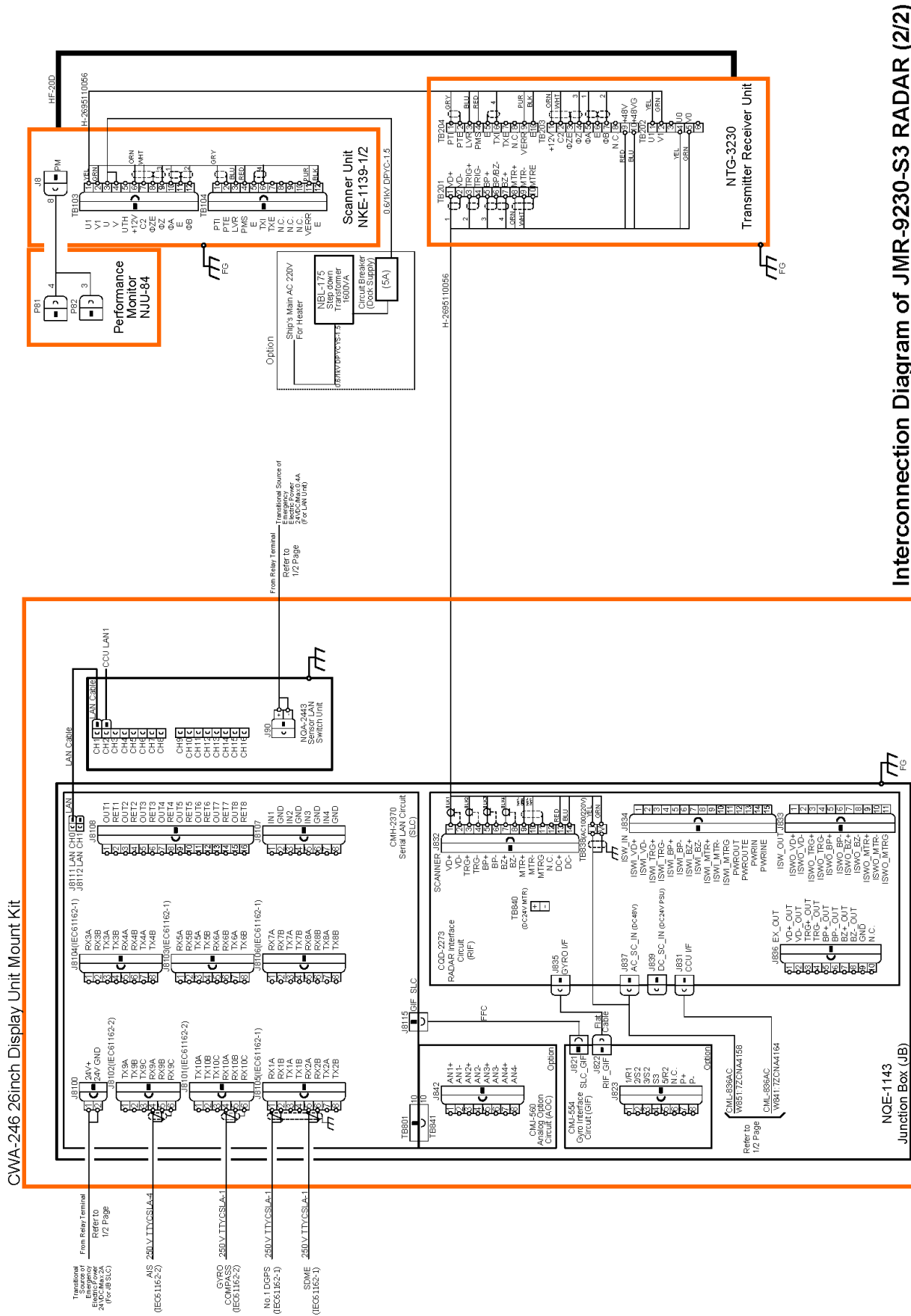

Interconnection Diagram of JMR-9230-S3 RADAR (2/2)

6.4.7 JMR-9272-S

CWA-246 26inch Display Unit Mount Kit

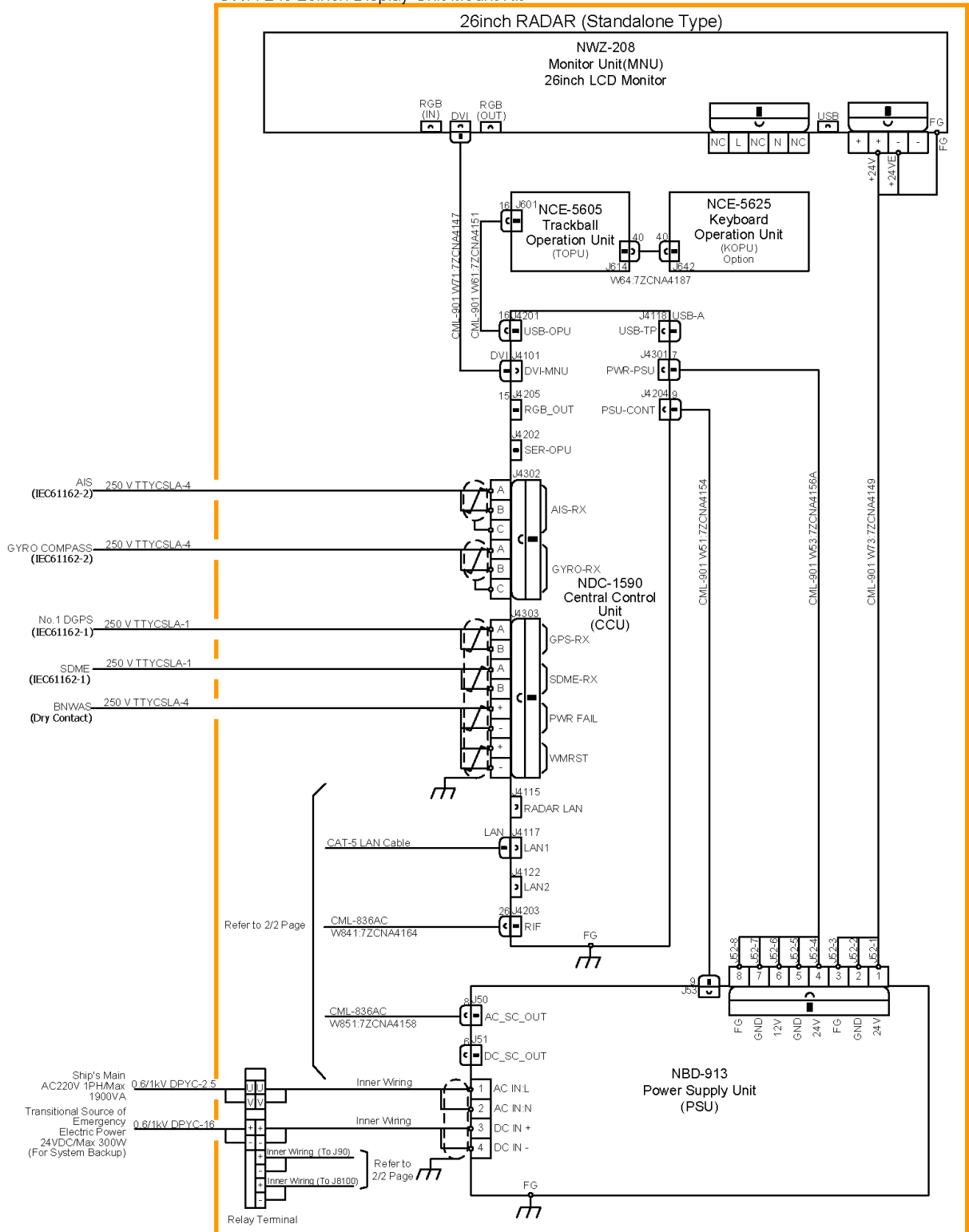

Interconnection Diagram of JMR-9272-S RADAR (1/2)

CWA-246 26inch Display Unit Mount Kit

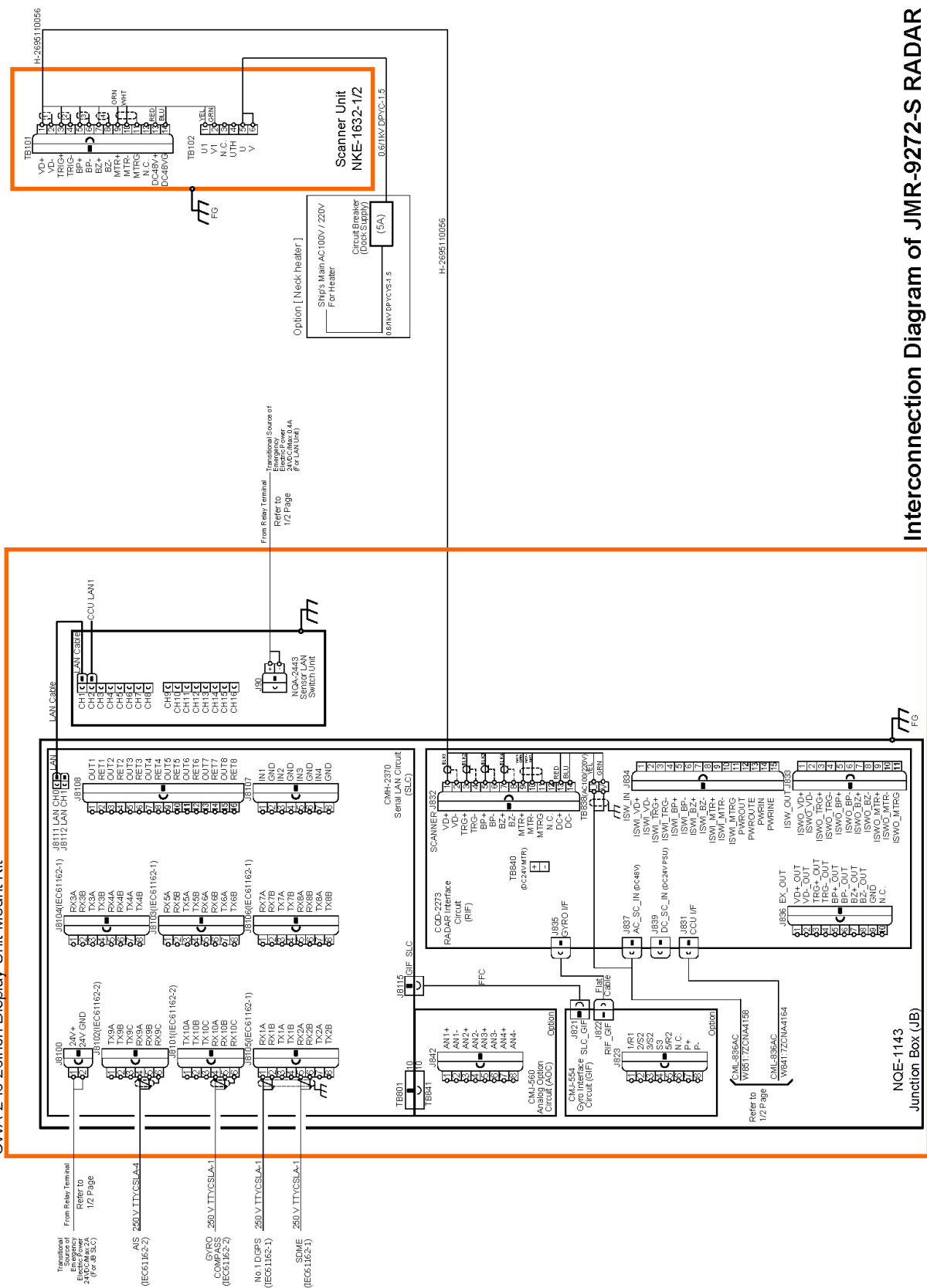

Interconnection Diagram of JMR-9272-S RADAR (2/2)

6.4.8 JMR-9282-S/SH

CWA-246 26inch Display Unit Mount Kit

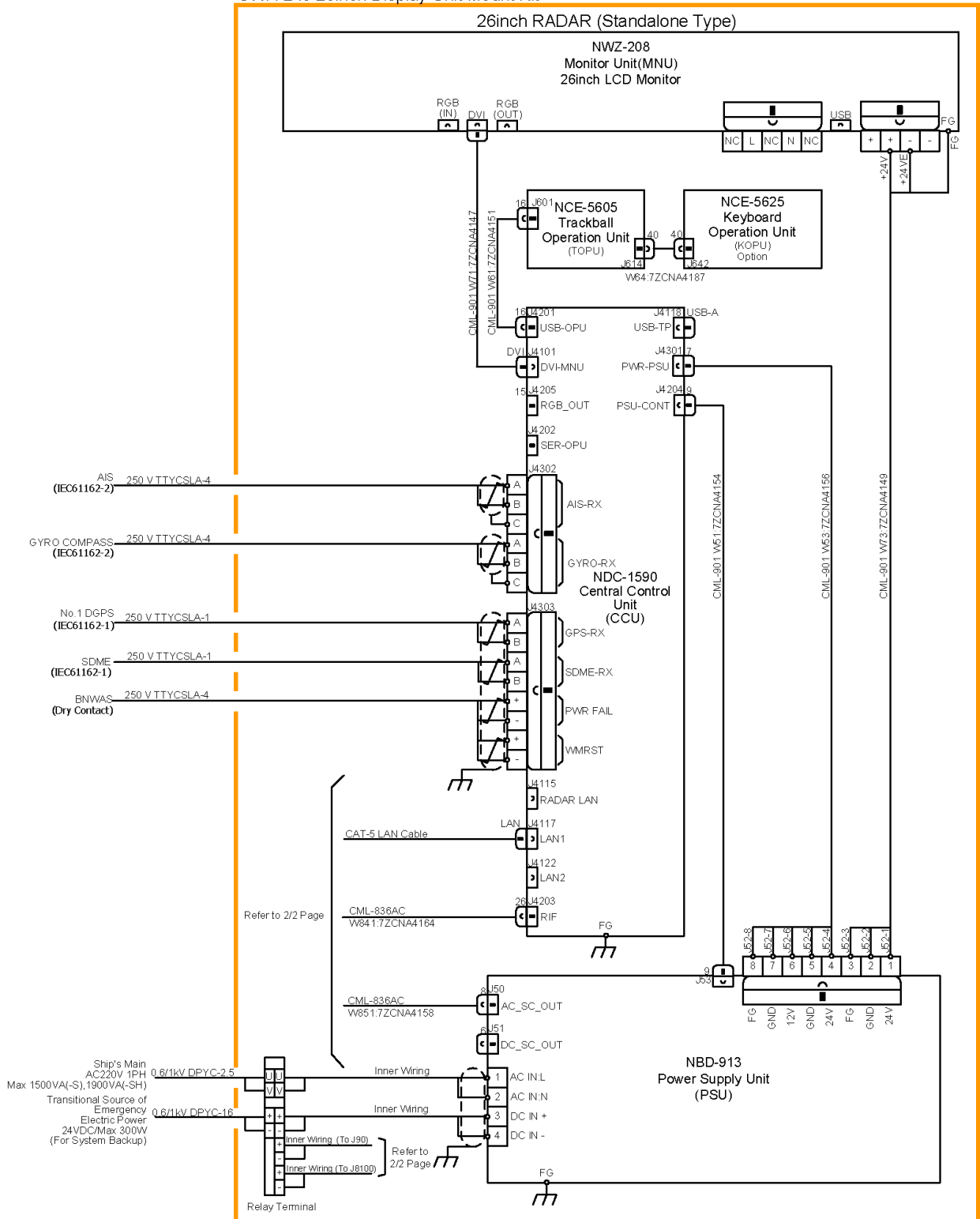

Interconnection Diagram of JMR-9282-S/SH RADAR (1/2)

CWA-246 26inch Display Unit Mount Kit

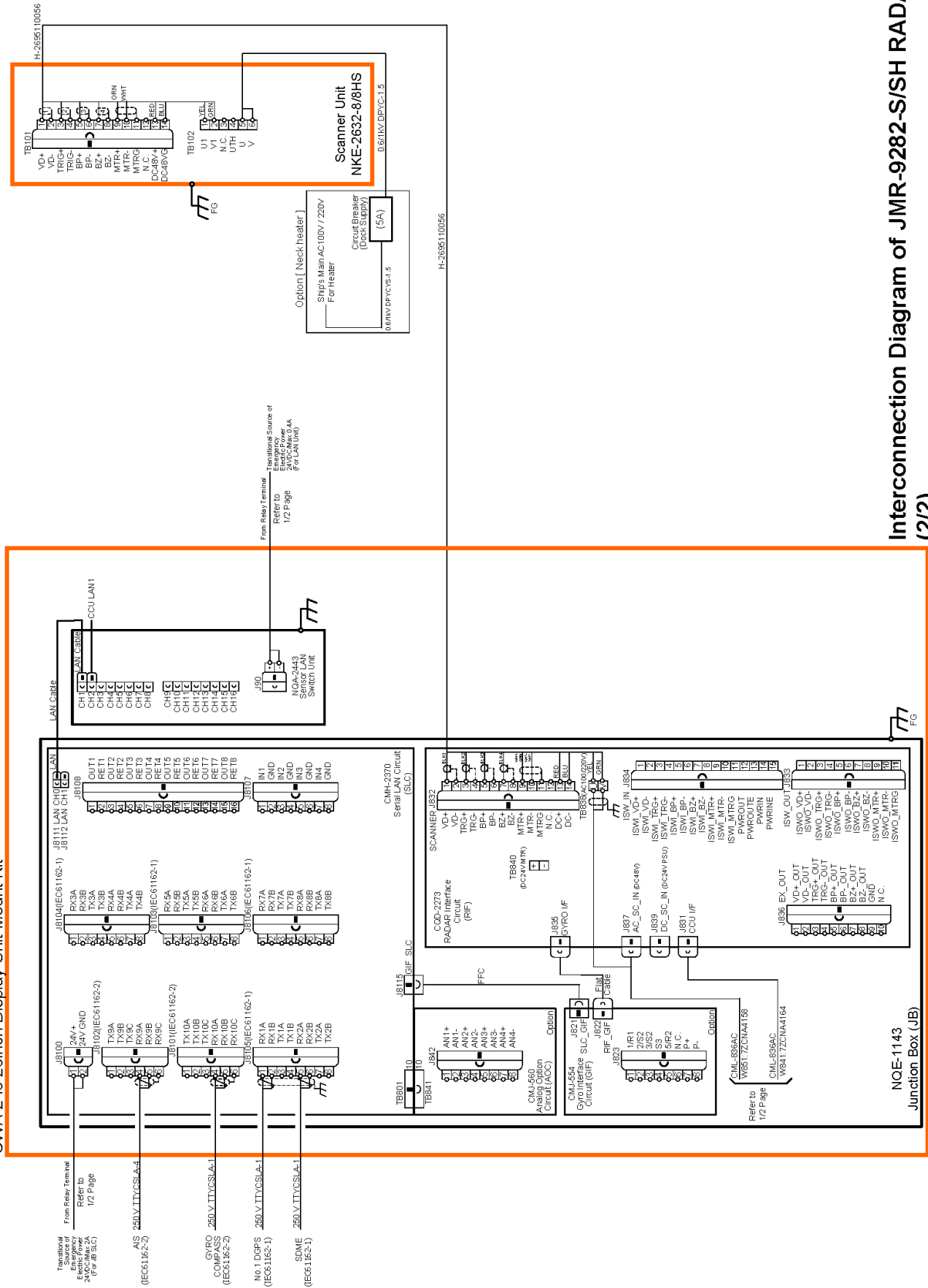

Interconnection Diagram of JMR-9282-S/SH RADAR (2/2)

6.4.9 JAN-9201

CWA-246 26inch Display Unit Mount Kit

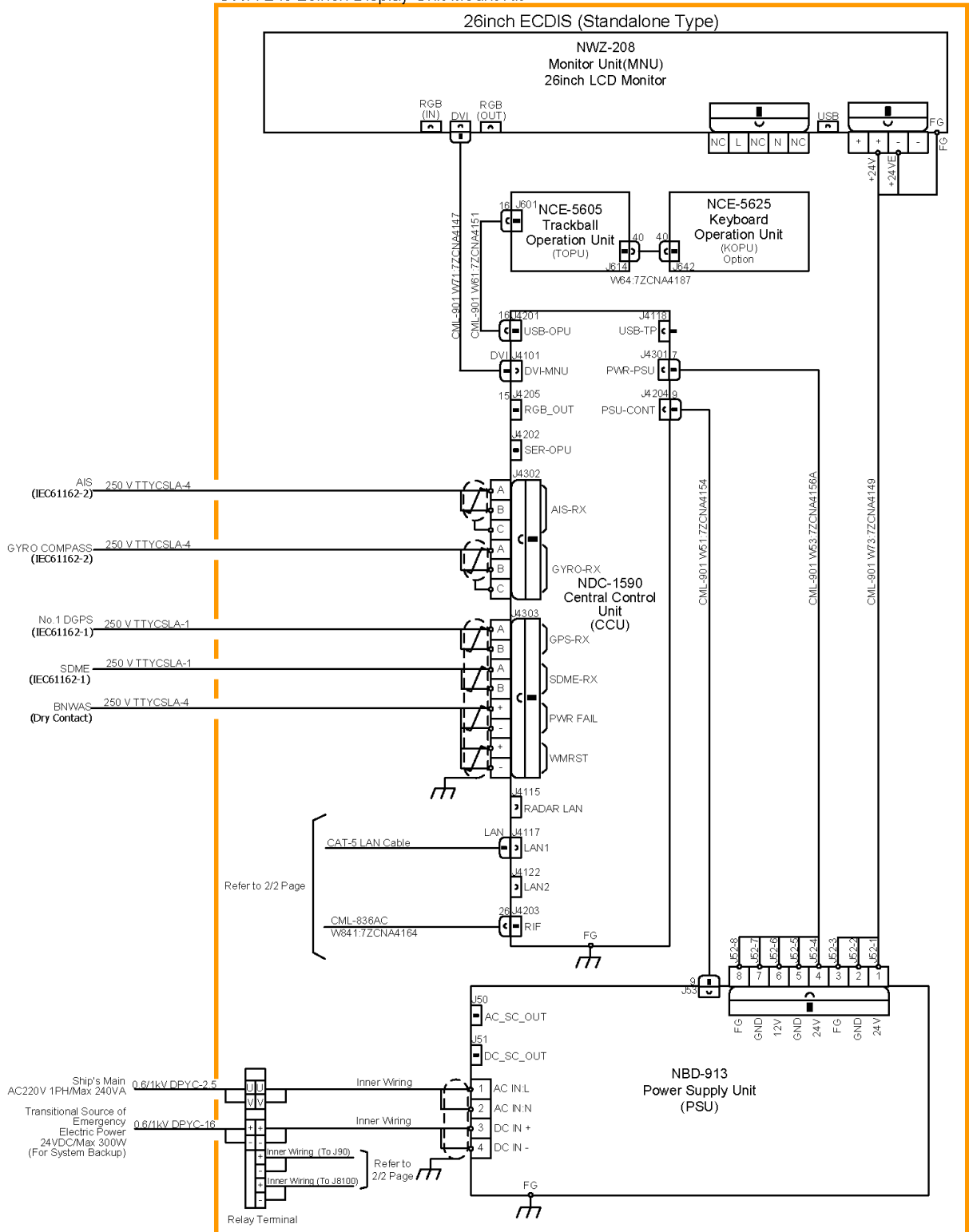

Interconnection Diagram of JAN-9201 ECDIS (1/2)