

1 ATTACHMENTS : PRODUCT DATA SHEET AND USER MANUAL
ATTACHMENT A – PRODUCT DATA SHEET

Simple industrial and for building automation radio remote control systems

UB series



Typical applications

- ◆ **Building automation**
 - access control /closing of doors, gates, barriers
 - light control
 - control of locks
- ◆ **On-board equipment**
 - control of winches, pipe laying
 - control of pumps
 - control of jacks
- ◆ **Industrial equipment**
 - ON / OFF controls
- ◆ **Handling systems**
 - hoists
 - monorails
 - bracket cranes

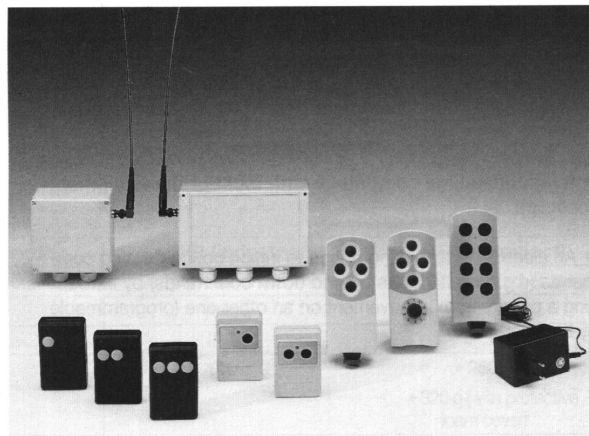

Description

1

The radio remote control system provides a number of important advantages:

- significant freedom of movement;
- ease of use;
- manoeuvring precision and quality;
- visibility.

With the new UB series of remote control systems, Jay Electronique provides solutions for a wide range of simple industrial and building automation applications.

The new series offers a large number of transmitters and receivers providing different types and numbers of functions designed to meet the wide range of user requirements.

The series also incorporates numerous features and significant technological advances:

- European frequencies in the 400 MHz band width
- FM radio link
- simultaneous commands
- programming of functions using jump switches or microswitches, thus ensuring numerous possibilities (identity codes, operating modes, command interlocking, relay number controlled by the transmitter, button number controlling the receiver) depending on model
- compact and light-weight transmitters and receivers.

CONTENTS

| | page |
|---------------------------------------|------|
| 1 Description | 1 |
| 2 Operating guidelines | 2 |
| 3 Transmitters characteristics | 3 |
| 4 Receivers characteristics | 4 |
| 5 Accessories characteristics | 5 |
| 6 Connections | 6 |
| 7 Radio approvals | 6 |
| 8 Dimensions | 7 |
| 9 Selection guide | 8 |

- **Radio approvals:**
 - Belgium, Denmark, Greece, Portugal, Switzerland, France, United Kingdom
 - Certification in process for other countries
- **Compliance with following European directives:**
 - Electromagnetic compatibility, CE type test certification Emitech
 - Low voltage



JAY
électronique

E 268 0399

ATTACHMENT B – User Manual

Télécommandes Radio Standard et industrielles simples

Notice technique d'installation et d'utilisation - page 2

Standard and Simple Industrial Radio Remote Control Systems

Installation and user technical manual - page 12

Standard und industrielle Funkfernsteuerungen

Technische Notiz und Bedienungsanleitung - Seite 22

série UB

CE

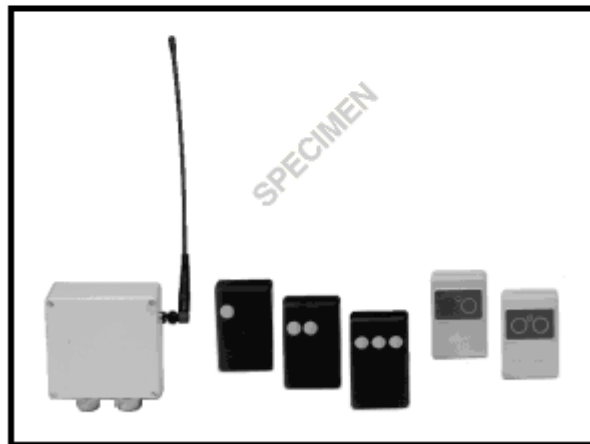

JAY
électronique



315464
F

TABLE OF CONTENTS

| | |
|--|-----------|
| 1 - TRANSMITTER | 13 |
| 1.1 Description | |
| 1.2 Common characteristics | |
| 1.3 Characteristics specific to each version | |
| 1.4 Clip mounting | |
| 2 - RECEIVER | 14 |
| 2.1 Description | |
| 2.2 Characteristics | |
| 2.3 Connection | |
| 2.4 Installation precautions | |
| 2.5 Risks of radio interference | |
| 3 - DIMENSIONS AND MOUNTING | 18 |
| 4 - MAINTENANCE | 19 |
| 5 - PRODUCTS REFERENCES | 19 |
| 5.1 Transmitter | |
| 5.2 Receiver | |
| 5.3 Miscellaneous accessories | |
| 6 - WARRANTY AND FCC COMPLIANCE | 21 |
| 7 - RADIOELECTRIC APPROVALS | 32 |

The UB radio remote control provides wireless transmission of one or several commands used to control a piece of moving equipment. On transmission of these commands, the output relays located in the receiver are closed.

1 - TRANSMITTER

1.1 - Description

The transmitter is supplied from a 9V battery provided with the unit.

The transmitter has a 3-state 8-digit identification code which is programmed by microswitches (6561 combinations).

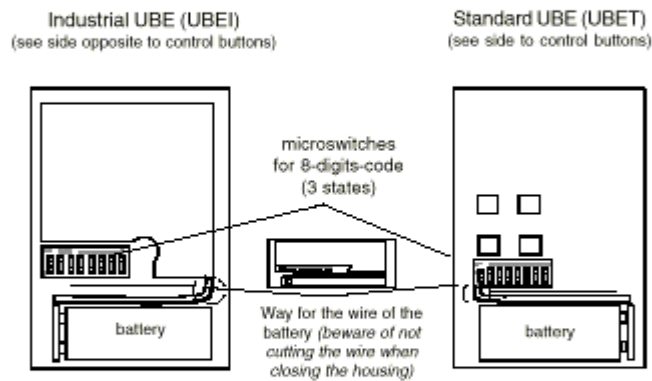

1.2 - Characteristics common to standard and industrial versions

Radio characteristics

- a momentary radio link (when pressing a command button)
- built-in antenna
- Frequency-modulated UHF carrier (FM)
- Radiofrequency 433,92 MHz for Europe and North America. (418 MHz for United Kingdom **only**)
- Power less than 1mW
- Range: UBET: 50 m with VUB160 and VUB150 antennas in obstacle-free space, variable according to environment conditions (range of 25m with a VUB140)
UBEI: 40 m with VUB160 and VUB150 antennas in obstacle-free space, variable according to environment conditions (range of 25m with a VUB140)

Other characteristics

- Autonomy: 1 year for a twice daily use. If the transmitter is not used for any extensive period of time, the battery should be removed.
- Operating temperature range: -10 °C to +50 °C
- Storage temperature range: -30 °C to +70 °C
- IK08 for UBEI / IK07 for UBET
- Red indicator on unit : lights on when a command is activated
- Accessories (to be ordered separately, see section 5 for product reference data)

1.3 - Characteristic specific to each version

| | Standard UBE | Industrial UBE |
|--|--------------|----------------|
| Housing | ABS | Polycarbonate |
| Tightness | IP40 | IP65 |
| Weight (with battery) | 120g | 140g |
| Number of commands (see also section 3) | 1 to 4 | 1 to 2 |

1.4 - Clip mounting (OPTIONAL)

for UBET: ref. UBWE10: mounting by the screws of the housing

for UBEI: ref. UBWE11: mounting by the two sticks; the hole of the clip must correspond to the screw of the housing

2 - RECEIVER

2.1 - Description

The receiver circuit is mounted in an ABS watertight housing. The receiver contains 1 to 4 relays each corresponding to a transmitter command. The relays use "NO" contacts connecting by screw terminals (2,5 mm²). A red led lights on when the contacts are closed.

The controls generated by the transmitter can be received in 2 modes programmed by jumpers (see jumper location below)

- Continuous mode: relay remains closed as long as the transmitter button command is maintained pressed.
- ON/OFF Mode: relay closes the first time the corresponding transmitter button is pressed and opens when the button is pressed a second time.

CAUTION: **In ON/OFF mode, there is a risk of triggering a command without being able to stop it if radio jamming conditions are present .**

Applications where a loss of control can cause damages are prohibited in ON/OFF mode.

The receiver is supplied configured for continuous mode by default.

In versions using several relays, the relays can be closed simultaneously if several control buttons on the transmitter are pressed. However, it is possible to prevent counter-acting functions (for example up/down or left/right movements). Priority is programmed using 4 microswitches (see microswitch locations below):

- microswitch 1 set to ON: relay 1 priority over relay 2
- microswitch 2 set to ON: relay 1 priority over relay 3
- microswitch 3 set to ON: relay 2 priority over relay 4
- microswitch 4 set to ON: relay 3 priority over relay 4

As for the transmitter, the receiver has an 8-digit identification code which is programmed by microswitches (see switch location below). Transmitter and receiver codes must be identical to set up the radio link. If the code is improperly programmed, only the green indicator (transmitter detection) lights on; The outputs aren't activated (red indicator lights stay off).

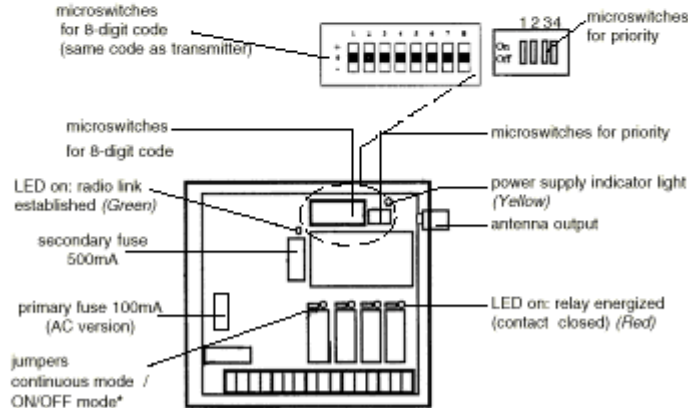

* Caution! RH jumpers: continuous mode
LH jumpers: ON/OFF mode

2.2 - Characteristics

- Weight: 500g
- Tightness: IP65
- Power supply: 12, 24 VDC (0/+30% battery only)
24 VAC (+/-15%), 48, 115, 230 VAC (+10/-15%)
- Maximum consumption: for 12 to 24 VDC: 180 mA
for 24 VAC: 7 VA
for 24, 48, 115, 230 VAC: 5 VA
- Response time on closing: 180 ms maximum
- Response time on opening: 350 ms maximum
- Operating temperature range: -10 °C to +50°C
- Storage temperature range: -30 °C à +70°C
- Insulation voltage (surge waves): 4000 V
- Complies with EMC and LV directives
- Protection against power supply inversion (for VDC power supply) except if the BNC mount of the antenna is connected with the ground
- Outputs: current min. 10mA / current max. 8A / Voltage max. 250VAC
- Switching categories: AC15 / 230VAC / 5A
DC13 / 24VDC / 2A

2.3 - Connection

Power supply connection:



- 12 VDC: terminals 3 (+) and 4 (-)
- 24 VDC: terminals 2 (+) and 4 (-)
- 24 VAC: terminals 1 and 4
- 48 VAC: terminals 2 and 3
- 115 VAC: terminals 2 and 3
- 230 VAC: terminals 2 and 3

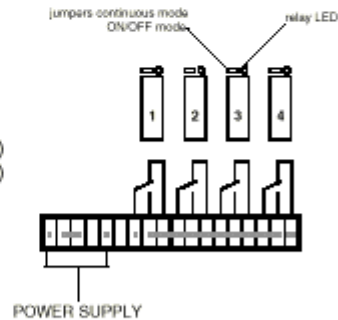

Relay connection:

Note 1: UB complies with Low Voltage Directive if very low voltage (12-24VDC, 24-48VAC) is not mixed with low voltage (115-230VAC) on relays outputs. Connection must be done for avoiding possible short-circuit between low voltage (12-48V) and low voltage (50-230V) parts.

Note 2: The lower the switched current the longer the relay life is:
10mA / 24VDC: 30.10⁶cycles (on resistive load)
8A / 250VAC: 50000 cycles (on resistive load)

In the case of controlling inductive load (relay, electrovalves...) the contact life is increased through the use of surge limiting circuits (diode in DC system, RC circuit in AC system) reducing the interference too.

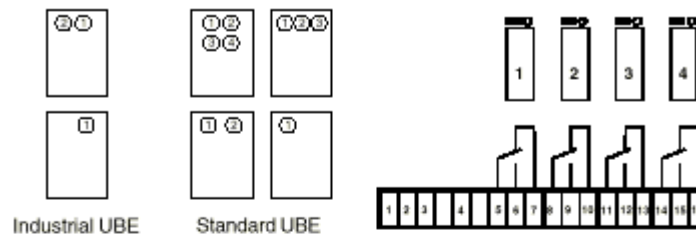

2.4 - Installation precautions

- A 1/2 wave antenna (VUB160) is supplied with the receiver.
 - UHF waves do not cross metal barriers. Antenna has not to be placed in an enclosure forming a shield (metal cabinet, reinforced concrete wall, metal structure or wall, ...)
 - As a general rule, any obstacle located between the transmitter and the antenna will reduce the transmitter's range.
 - Insofar as possible, antenna should be placed:
 - as close as possible to the source of transmission
 - as high as possible
 - with a direct line of sight or with as few obstacles as possible between the transmitter and receiver
- Antenna must never cross a wall, even an isolating wall.*

If these conditions cannot be observed, an external antenna can be used with an antenna extension. These can be ordered separately.

External antenna (with extension): VUB150, VUB100, VUB120

The external antenna significantly improves reception performance. For this purpose, the antenna must be located on a metallic ground plane and:

- in a position as free of obstacles as possible
- with a direct line of sight to the transmitter or, if not possible, with the minimum amount of obstacles between the transmitter and the antenna
- insofar as possible, cable lengths exceeding 5 meters should be avoided between the receiver and the antenna
- perpendicular to the metallic ground plane

Positioning the antenna:

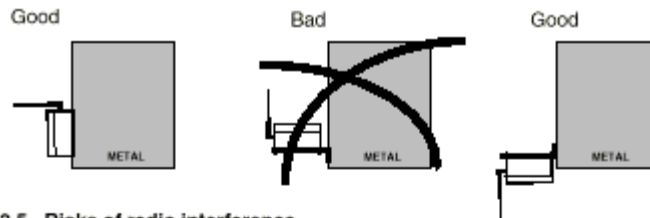

2.5 - Risks of radio interference

To avoid any risk of length interference inhibiting system operation, UB series systems must not be installed near or used at the same time as other radio systems that emit continuously within a frequency range of ± 500 kHz, with respect to the operating frequency of the UB series system.

3 - DIMENSIONS AND MOUNTING

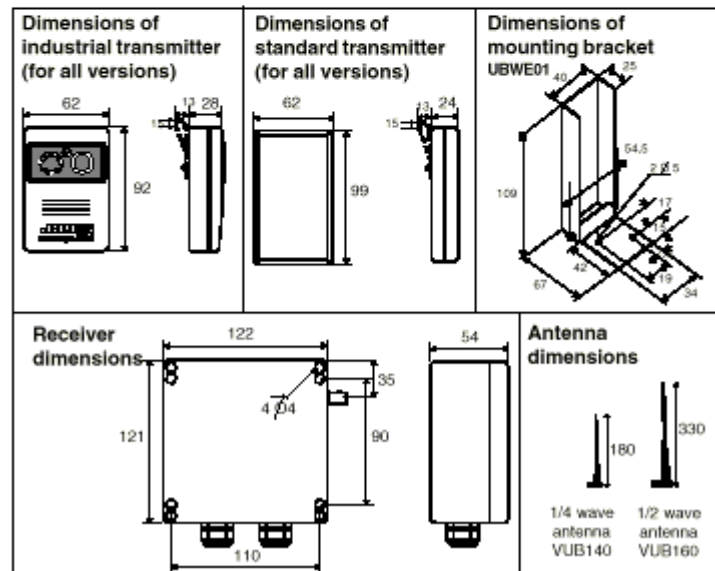

4 - MAINTENANCE

No internal parts of the transmitter or receiver are accessible for user maintenance.

User access is limited to the continuous - ON/OFF jumpers and the priority and encoding microswitches.

Should any malfunctions occur on the transmitter or receiver, the units must be returned to factory for maintenance.

5 - PRODUCTS REFERENCES

5.1 - Transmitter

| Reference | Frequency | Designation |
|-----------|------------|---|
| UBET11SL1 | 433,92 MHz | Standard Transm., 1 But., 1Vit., Standard |
| UBET21SL1 | 433,92 MHz | Standard Transm., 2 But., 1Vit., Standard |
| UBET31SL1 | 433,92 MHz | Standard Transm., 3 But., 1Vit., Standard |
| UBET41SL1 | 433,92 MHz | Standard Transm., 4 But., 1Vit., Standard |
| UBEI1SL1 | 433,92 MHz | Industrial Transm., 1 But., 1Vit., Standard |
| UBEI2SL1 | 433,92 MHz | Industrial Transm., 2 But., 1Vit., Standard |
| UBET11SK1 | 418 MHz | Standard Transm., 1 But., 1Vit., Standard |
| UBET21SK1 | 418 MHz | Standard Transm., 2 But., 1Vit., Standard |
| UBET31SK1 | 418 MHz | Standard Transm., 3 But., 1Vit., Standard |
| UBET41SK1 | 418 MHz | Standard Transm., 4 But., 1Vit., Standard |
| UBEI1SK1 | 418 MHz | Industrial Transm., 1 But., 1Vit., Standard |
| UBEI2SK1 | 418 MHz | Industrial Transm., 2 But., 1Vit., Standard |

The transmitters are provided with a 9V battery.

5.2 - Receiver

| Reference | Frequency | Designation |
|-----------|------------|---|
| UBRS1L1C | 433,92 MHz | 1-channel Receiv., Standard, 12 VDC- 24 VAC/VDC |
| UBRS1L1S | 433,92 MHz | 1-channel Receiv., Standard, 48 VAC |
| UBRS1L1U | 433,92 MHz | 1-channel Receiv., Standard, 230 VAC |
| UBRS2L1C | 433,92 MHz | 2-channel Receiv., Standard, 12 VDC- 24 VAC/VDC |
| UBRS2L1S | 433,92 MHz | 2-channel Receiv., Standard, 48 VAC |
| UBRS2L1U | 433,92 MHz | 2-channel Receiv., Standard, 230 VAC |
| UBRS3L1C | 433,92 MHz | 3-channel Receiv., Standard, 12 VDC- 24 VAC/VDC |
| UBRS3L1S | 433,92 MHz | 3-channel Receiv., Standard, 48 VAC |
| UBRS3L1U | 433,92 MHz | 3-channel Receiv., Standard, 230 VAC |
| UBRS4L1C | 433,92 MHz | 4-channel Receiv., Standard, 12 VDC- 24 VAC/VDC |
| UBRS4L1S | 433,92 MHz | 4-channel Receiv., Standard, 48 VAC |
| UBRS4L1U | 433,92 MHz | 4-channel Receiv., Standard, 230 VAC |
| UBRS1K1C | 418 MHz | 1-channel Receiv., Standard, 12 VDC- 24 VAC/VDC |
| UBRS1K1T | 418 MHz | 1-channel Receiv., Standard, 115 VAC |
| UBRS1K1U | 418 MHz | 1-channel Receiv., Standard, 230 VAC |
| UBRS2K1C | 418 MHz | 2-channel Receiv., Standard, 12 VDC- 24 VAC/VDC |
| UBRS2K1T | 418 MHz | 2-channel Receiv., Standard, 115 VAC |
| UBRS2K1U | 418 MHz | 2-channel Receiv., Standard, 230 VAC |
| UBRS3K1C | 418 MHz | 3-channel Receiv., Standard, 12 VDC- 24 VAC/VDC |
| UBRS3K1T | 418 MHz | 3-channel Receiv., Standard, 115 VAC |
| UBRS3K1U | 418 MHz | 3-channel Receiv., Standard, 230 VAC |
| UBRS4K1C | 418 MHz | 4-channel Receiv., Standard, 12 VDC- 24 VAC/VDC |
| UBRS4K1T | 418 MHz | 4-channel Receiv., Standard, 115 VAC |
| UBRS4K1U | 418 MHz | 4-channel Receiv., Standard, 230 VAC |

The receivers are provided with the 1/2 wave antenna (VUB 160).

5.3 - Miscellaneous accessories

| Reference | Designation |
|-----------|---|
| UBWE01 | Mounting bracket for UBE Transmitter |
| UBWE10 | Fastening clip for standard Transmitter |
| UBWE11 | Fastening clip for industrial Transmitter |
| UBWE12 | Storage case with clip for Standard transmitter |
| UBWE13 | Label 1 for standard Transmitter |
| UBWE14 | Label 2 for standard Transmitter |
| UBWE15 | Label 3 for standard Transmitter |
| VUB100 | extension (2m cable) for VUB160 + bracket |
| VUB120 | extension (5m cable) for VUB160 + bracket |
| VUB140 | 1/4 wave antenna |
| VUB150 | 1/4 wave antenna with 3m cable |
| VUB160 | 1/2 wave antenna |

6 - WARRANTY AND FCC COMPLIANCE

All of our units are guaranteed ONE YEAR starting from the day of shipment. Repair, modification or replacement of a unit during the warranty period will not give rise to extension of the period.

6.1 Limits of warranty :

The warranty does not cover defects resulting from :

- transport
- false maneuver or non-observance of connection diagrams when setting the equipment into service
- insufficient supervision or servicing, utilization not complying with the specifications detailed in the technical manual and, as a general rule, storage, operation or environment conditions (atmospheric, chemical, electrical or other conditions).
- Conditions not specified on order of the equipment

The warranty shall not apply subsequent to any modifications or additions to the equipment performed by the customer without written approval by JAY Electronique.

The JAY Electronique responsibility during the warranty period is limited to material and construction defects. This warranty comprises repair in the JAY workshops or replacement, free of charge, of parts recognized to be defective following expert inspection by the Jay Technical Department.

The warranty shall not give rise to any compensation for damage claims. Any disputes relative to a supply or settlement thereof shall be ruled by the COURT OF COMMERCE OF GRENOBLE, solely competent, even in the event of an Appeal or a plurality of defendants.

6.2 Limits of FCC Compliance

Only standard version UBET**SL1/UBRS*L1* have been submitted to FCC certification. These devices comply with part 15 of the FCC rules. Operation is subject to the following two conditions:

- (1) These devices may not cause harmful interference, and
- (2) These devices must accept any interference received, including interference that may cause undesired operation

The user that changes or modifications not expressly approved by the party responsible for FCC compliance could void the user's authority to operate the equipment.

This equipment has been tested and found to comply with the limits for a class B digital device, pursuant of part 15 of the FCC rules. These limits are designed to provide reasonable protection against harmful interference in a residential installation. This equipment generates, uses and can radiate radio frequency energy and, if not installed and used in accordance with the instructions, may cause harmful interference to radio communications. However, there is no guarantee that interference will not occur in a particular installation. If this equipment does cause harmful interference to radio or television reception, which can determine by turning the equipment off and on, the user is encouraged to try to correct the interference by one or more of the following measures :

- reorient or relocate the receiving antenna
- increase the separation between the equipment and receiver
- connect the equipment into an outlet on a circuit different from that to which the receiver is connected
- consult the dealer or an experienced radio/TV technician for help.

**7 - HOMOLOGATIONS RADIOELECTRIQUES
RADIOELECTRIC APPROVALS
FUNKTECHNISCHE ZULASSUNGEN**

**MPT 1340
W.T. LICENCE
EXEMPT**

**FCC Conditions :
See conditions page 21
voir conditions page 11**

Réalisation JAY PC315464 PM65 20 09 99

JAY
électronique



GRENOBLE - FRANCE
ZIRST 2 - B.P. 5 - F 38330 MONTBONNOT-SAINT-MARTIN
Tel : 04.76.41.44.00 (int. : 00.33.4.76.41.44.00)
Fax : 04.76.41.44.41 (int. : 00.33.4.76.41.44.41)
Web: <http://www.jay-electronique.fr>

