

JENSEN[®] audio

MODEL CD-545

**PORTABLE AM/FM STEREO CD
CASSETTE RECORDER**

INSTRUCTION MANUAL



Please read and follow this Instruction Manual carefully before using the unit and retain it for future reference

IMPORTANT SAFETY INSTRUCTIONS

WARNING:

TO REDUCE THE RISK OF FIRE OR ELECTRIC SHOCK, DO NOT EXPOSE THIS APPLIANCE TO RAIN OR MOISTURE. DANGEROUS HIGH VOLTAGES ARE PRESENT INSIDE THE ENCLOSURE. DO NOT OPEN THE CABINET REFER SERVICING TO QUALIFIED PERSONNEL ONLY.

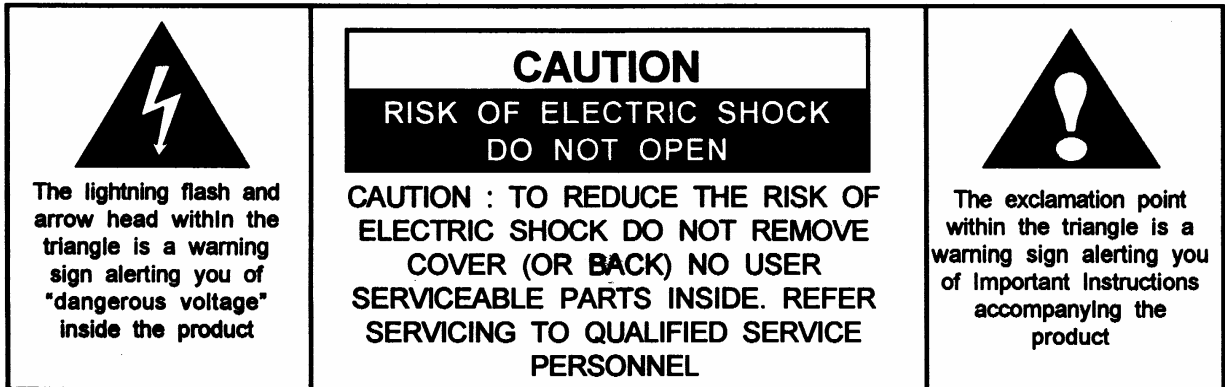

The Caution marking is located at the bottom of the unit

CAUTION:

PLEASE READ AND OBSERVE ALL WARNINGS AND INSTRUCTIONS GIVEN IN THIS OWNER'S MANUAL AND THOSE MARKED ON THE UNIT, KEEP THESE INSTRUCTIONS. RETAIN THIS BOOKLET FOR FUTURE REFERENCE.

This set has been designed and manufactured to assure personal safety. Improper use can result in electric shock or fire hazard. The safeguards incorporated in this unit will protect you if you observe the following procedures for installation, use and servicing. This unit does not contain any parts that can be repaired by the user.

DO NOT REMOVE THE CABINET COVER, OR YOU MAY BE EXPOSED TO DANGEROUS VOLTAGE. REFER SERVICING TO QUALIFIED SERVICE PERSONNEL ONLY.

SAFETY INSTRUCTIONS

Before using the unit, be sure to read all operating instructions carefully. Please note that these are general precautions and may not pertain to your unit. For example, this unit may not have the capability to be connected to an outdoor antenna.

1. **READ INSTRUCTIONS**
All the safety and operating instructions should be read before the product is operated.
2. **RETAIN INSTRUCTIONS**
The safety and operating instructions should be retained for future reference.
3. **HEED WARNINGS**
All warnings on the product and in the operating instructions should be adhered to.
4. **FOLLOW INSTRUCTIONS**
All operating and use instructions should be followed.
5. **CLEANING**
Unplug this product from the wall outlet before cleaning. Do not use liquid cleaners or aerosol cleaners. Use a dry cloth for cleaning.
6. **ATTACHMENTS**
Do not use attachments not recommended by the product's manufacturer as they may cause hazards.
7. **WATER AND MOISTURE**
Do not use this product near water for example: near a bathtub, washbowl, kitchen sink or laundry tub; in a wet basement; or near a swimming pool.
8. **ACCESSORIES**
Do not place this product on an unstable cart, stand, tripod, bracket or table. The product may fall, causing serious injury and serious damage to the product. Use only with a cart, stand, tripod, bracket or table recommended by the manufacturer or sold with the product. Any mounting of the product should follow the manufacturer's instructions, and should use a mounting accessory recommended by the manufacturer.
- 8A. An appliance and cart combination should be moved with care. Quick stops, excessive force and uneven surfaces may cause the appliance and cart combination to overturn.
9. **VENTILATION**
Slots and openings in the cabinet and in the back or bottom are provided for ventilation, to ensure reliable operation of the product and to protect it from overheating. These openings must not be blocked or covered. The openings should never be blocked by placing the product

PORTABLE CART WARNING
(symbol provided by RETAC)



on a bed, sofa, rug or other similar surface. This product should never be placed near or over a radiator or heat source. This product should not be placed in a built-in installation such as a bookcase or rack unless proper ventilation is provided or the manufacturer's instructions have been adhered to.

10. **POWER SOURCES**
This product should be operated only from the type of power source indicated on the marking label. If you are not sure of the type of power supply to your home, consult your appliance dealer or local power company. For products intended to operate from battery power, or other sources, refer to the operating instructions.
11. **GROUNDING OR POLARIZATION**
This product is equipped with a polarized alternating-current line plug (a plug having one blade wider than the other). This plug will fit into the power outlet only one way. This is a safety feature. If you are unable to insert the plug fully into the outlet, try reversing the plug. If the plug should still fail to fit, contact your electrician to replace your obsolete outlet. Do not defeat the safety purpose of the polarized plug.
12. **POWER-CORD PROTECTION**
Power-supply cords should be routed so that they are not likely to be walked on or pinched by items placed upon or against them, paying particular attention to cords at plugs, convenience receptacles, and the point where they exit from the appliance.
13. **LIGHTNING**
To protect your product from a lightning storm, or when it is left unattended and unused for long periods of time, unplug it from the wall outlet and disconnect the antenna or cable system. This will prevent damage to the product due to lightning and power-line surges.
14. **POWER LINES**
An outside antenna system should not be located in the vicinity of overhead power lines or other electric light or power circuits, or where it can fall into such power lines or circuits. When installing an outside antenna system, extreme care should be taken to keep from touching such power lines or circuits as contact with them might be fatal.
15. **OVERLOADING**
Do not overload wall outlets and extension cords as this can result in a risk of fire or electric shock.
16. **OBJECT AND LIQUID ENTRY**
Never push objects of any kind into this product through openings as they may touch dangerous

SAFETY INSTRUCTIONS

voltage points or short out parts that could result in fire or electric shock. Never spill or spray any type of liquid on the product.

17. OUTDOOR ANTENNA GROUNDING

If an outside antenna is connected to the product, be sure the antenna system is grounded so as to provide some protection against voltage surges and built-up static charges. Section 810 of the National Electric Code, ANSI/NFPA 70, provides information with respect to proper grounding of the mast and supporting structure, grounding of the lead-in wire to an antenna discharge product, size of grounding conductors, location of antenna discharge product, connection to grounding electrodes and requirements for grounding electrodes.

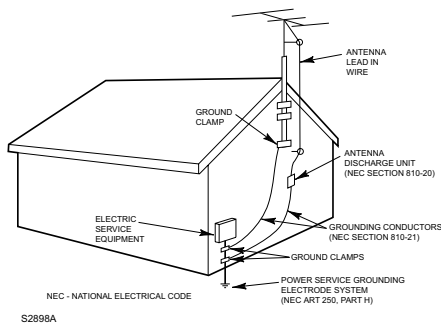

EXAMPLE OF ANTENNA GROUNDING AS PER NATIONAL ELECTRICAL CODE

18. SERVICING

Do not attempt to service this product yourself as opening or removing covers may expose you to dangerous voltage or other hazards. Refer all servicing to qualified service personnel.

19. REPLACEMENT PARTS

When replacement parts are required, be sure the service technician uses replacement parts specified by the manufacturer or those that have the same characteristics as the original part. Unauthorized substitutions may result in fire, electric shock or other hazards.

20. SAFETY CHECK

Upon completion of any service or repairs to this product, ask the service technician to perform safety checks to determine that the product is in proper operating condition.

21. WALL OR CEILING MOUNTING

The product should be mounted to a wall or ceiling only as recommended by the manufacturer.

22. DAMAGE REQUIRING SERVICE

Unplug the product from the wall outlet and refer servicing to qualified service personnel under the following conditions:

- a. When the power-supply cord or plug is damaged.
- b. If liquid has been spilled or objects have fallen into the product.
- c. If the product has been exposed to rain or water.
- d. If the product does not operate normally by following the operating instructions. Adjust only those controls that are covered by the operating instructions, as an adjustment of other controls may result in damage and will often require extensive work by a qualified technician to restore the product to its normal operation.
- e. If the product has been dropped or the cabinet has been damaged.
- f. When the product exhibits a distinct change in performance this indicates a need for service.

23. HEAT

The product should be situated away from heat sources such as radiators, heat registers, stoves or other products (including amplifiers) that produce heat.

24. NOTE TO CATV SYSTEM INSTALLER

This reminder is provided to call the CATV system installer's attention to Article 820-40 of the NEC that provides guidelines for proper grounding and, in particular, specifies that the cable ground shall be connected to the grounding system of the building, as close to the point of cable entry as practical.

FCC NOTICE

This equipment has been tested and found to comply with the limits for a Class B digital device, pursuant to Part 15 of the FCC Rules. These limits are designed to provide reasonable protection against harmful interference in a residential installation. This equipment generates, uses and can radiate radio frequency energy and, if not installed and used in accordance with the instructions, may cause harmful interference to radio communications.

However, there is no guarantee that interference will not occur in a particular installation. If this equipment does cause harmful interference to radio or television reception, which can be determined by turning the equipment off and on, the user is encouraged to try to correct the interference by one or more of the following measures:

- Reorient or relocate the receiving antenna.
- Increase the separation between the equipment and receiver.
- Connect the equipment into an outlet on a circuit different from that to which the receiver is needed.
- Consult the dealer or an experienced radio/TV technician for help.

WARNING:

Changes or modifications to this unit not expressly approved by the party responsible for compliance could void the user's authority to operate the equipment.

CAUTION

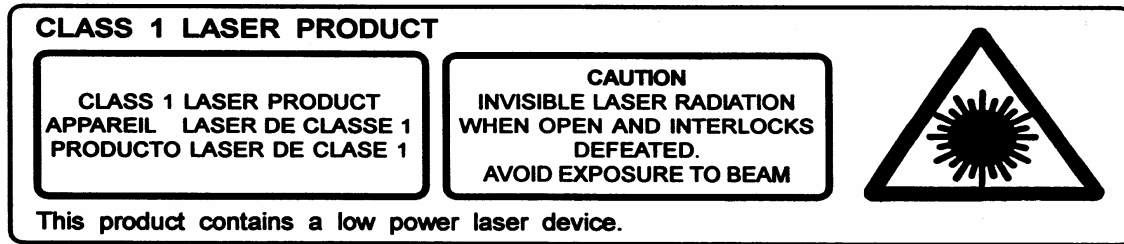

Follow the advice below for safe operations.

ON PROTECTION AGAINST LASER ENERGY EXPOSURE

- As the laser beam used in this compact disc player is harmful to the eyes, do not attempt to disassemble the casing.
- Stop operation immediately if any liquid or solid object should fall into the cabinet.
- Do not touch the lens or poke at it. If you do, you may damage the lens and the player may not operate properly.
- Do not put anything in the safety slot. If you do, the laser diode will be ON when the CD door is still open.
- If the unit is not to be used for a long period of time, make sure that all power sources are disconnected from the unit. Remove all batteries from the battery compartment, and unplug the AC cord from the wall outlet. Make it a practice to remove the AC cord by grasping the main body and not by pulling the cord.
- This unit employs a laser. The use of controls or adjustment or performance of procedures other than those specified here may result in exposure to hazardous radiation.

ON PLACEMENT

- Do not use the unit in places where are extremely hot, cold, dusty or humid.
- Place the unit on a flat and even surface.
- Do not restrict the air-flow of the unit by placing it in a place with poor ventilation, by covering it with a cloth or by placing it on a carpet.

ON CONDENSATION

- When left in a heated room where it is warm and damp, water droplets or condensation may form inside the unit.
- When there is condensation inside the unit, the unit may not function normally.
- Let it stand for 1 to 2 hours before turning the power on, or gradually heat the room up and dry the unit before use.

Should any trouble occur, remove the power source and refer servicing to qualified personnel.

FUNCTIONS AND CONTROLS

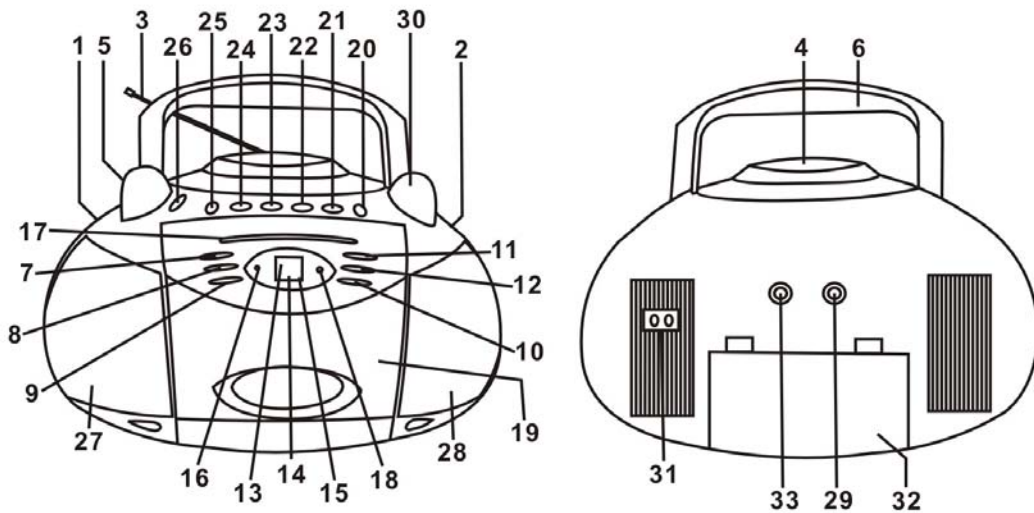

- | | | | |
|-----|--------------------------------|-----|------------------------------|
| 1. | Function Selector | 18. | FM STEREO Indicator |
| 2. | Band Selector | 19. | Cassette Compartment |
| 3. | Telescopic FM Antenna | 20. | Cassette Record Button |
| 4. | CD Door | 21. | Cassette Play Button |
| 5. | Volume Control Knob | 22. | Cassette Rewind Button |
| 6. | Carry Handle | 23. | Cassette Fast Forward Button |
| 7. | CD Skip/Search Forward Button | 24. | Cassette Stop/Eject Button |
| 8. | CD Skip/Search Backward Button | 25. | Cassette Pause Button |
| 9. | CD Program Button | 26. | Bass Boost Button |
| 10. | CD Repeat Button | 27. | Speaker Left |
| 11. | CD Stop Button | 28. | Speaker Right |
| 12. | CD Play/Pause Button | 29. | Stereo Phones Jack |
| 13. | LED Display | 30. | Tuning Knob |
| 14. | CD Repeat LED Indicator | 31. | AC Socket |
| 15. | CD Play/Pause LED Indicator | 32. | Battery Compartment |
| 16. | Power Indicator | 33. | AUX IN Jack |
| 17. | Dial Pointer | | |

LED DISPLAY

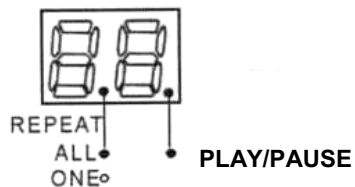

POWER SOURCE

This AM/FM CD Cassette Recorder operates on 8 X 'D' size (UM-1) batteries or from AC120V 60Hz line power supply.

A. BATTERY OPERATION

For best performance and longer operating time, we recommend the use of alkaline batteries.

1. Remove the Battery Door.
2. Following the polarity (+ and -) diagram as shown inside the battery compartment, insert 8 'D' size (UM-1) batteries.
3. Replace the Battery Door.

BATTERY WARNING

1. Be sure that the batteries are installed correctly. Wrong polarity may damage the unit.
2. (a) Do not mix old and new batteries.
(b) Do not mix alkaline, standard (carbon-zinc) or rechargeable (nickel-cadmium) batteries.
3. If the unit is not to be used for an extended period of time, remove the batteries. Any old or leaking batteries can cause damage to the unit and may void the warranty.
4. Do not dispose of batteries in fire, batteries may explode or leak.

B. AC POWER CONNECTION

1. Insert the power cord to the AC Socket (#31).
2. Connect the power cord to AC power source.
3. When the unit is operated from AC power source, the internal battery source will automatically be disconnected.

CAUTION:

TO PREVENT ELECTRIC SHOCK, MATCH WIDE BLADE OF PLUG TO WIDE SLOT. FULLY INSERT.

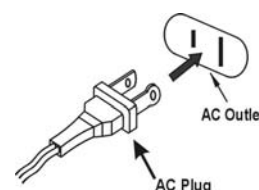

RADIO RECEPTION

1. Set the Function Selector (#1) to "RADIO".
2. Set the Band Selector (#2) to "AM" or "FM" for the desired radio band.
3. Turn the Tuning Knob (#30) to select the desired radio station.
4. Adjust the Volume Control (#5) to obtain the desired sound level the Built-in Speakers.
5. To enhance the bass effect, depress and release the BASS Button (#26) when a "click" is heard.
6. To turn the Radio off, set the Function Selector (#1) to the "TAPE" position.

TIPS FOR BEST RADIO RECEPTION





1. To insure maximum FM tuner reception, the Telescopic Antenna (#2) should be fully extended and rotated to obtain the best possible station reception. The FM Stereo Indicator (#18) will light steadily when a stereo program is being received.
2. The AM antenna is built into the unit. When tuning in AM reception, be sure to place the unit in a vertical position. To insure best AM reception, try repositioning the unit until the best station reception is obtained.

CD PLAYER OPERATION

Note: This CD player will not only play commercial CDs, but also self-compiled CD-R/RW discs. Do not attempt to play CD-ROM, CDI, VCD, DVD or computer CDs.

Notes on CD-R/RW Discs



- Because of non-standardized format definition/production of CD-R/RW, playback quality & performance are not guaranteed.
- Manufacturer is not responsible for the playability of CD-R/RW due to recording conditions such as PC performance, writing software, media ability, etc.
- Do not attach a label or seal to either side of the CD-R/RW disc. It may cause a malfunction.

1. Open the CD Door by pressing the CD Door (#4) where indicated *PUSH OPEN/CLOSE*.
2. Carefully place an audio CD with its label side upward in the CD compartment and close the CD Door by pressing on the CD Door (#4) where indicated *PUSH OPEN/CLOSE*.
3. Set the Function Selector (#1) to the "CD" position. The POWER Indicator (#16) will light. The LED Display (#13) will briefly display flashing "- -" and then the total number of tracks on the CD will appear in the LED Display (#13) after a few seconds. 
4. Press the CD PLPA/PAUSE ►|| Button (#12). The CD Play/Pause Indicator (#15) will light and the CD will start playing from the first track. 
5. Adjust the Volume Control (#5) to obtain the desired sound level from the Built-in Speakers.
6. To enhance the bass effect, depress and release the BASS Button (#26) when a "click" is heard.
7. To suspend playing, press the CD PLAY/PAUSE ►|| Button (#12) and the CD Play/Pause Indicator (#15) will flash. 
To resume playing, press the CD PLAY/PAUSE ►|| Button again.
8. You can choose to play your favorite track directly by pressing either the Skip Forward ►► Button (#7) or Skip Backward ◀◀ Button (#8). The LED Display (#13) will indicate the correct track number selected.
9. To locate a particular passage within a track, keep the CD Search Forward ►► Button (#7) or CD Search Backward ◀◀ Button (#8) depressed until it is found.
10. To repeat a particular track, press the CD REPEAT Button (#10) until the CD Repeat 1/All Indicator (#14) flashes. 
11. To repeat the entire CD, press the REPEAT Button (#10) until the CD Repeat 1/All Indicator (#14) lights steadily. 
12. To stop playing, press the CD STOP ■ Button (#11).
13. When you wish to turn off the CD Player, set the Function Selector (#1) to the "TAPE" position. The POWER Indicator will go off.

CD PROGRAMMED PLAY

This function allows the tracks to be played in a programmed sequence.

NOTE: Program can only be set in STOP mode.

1. In CD stop mode, press the PROGRAM Button (#9) once. Program No. "01" will appear and blink in the LED Display (#13). 
2. Press the CD Skip Forward ►► Button (#7) or CD Skip Backward ◀◀ Button (#8) to select the song to be programmed. For example track 5 is selected. 

3. Press the PROGRAM Button (#9) again to store selection. The LED Display (#13) will go to "02" and blink to prompt for input.
4. Press the CD Skip Forward ►► Button (#7) or CD Skip Backward ◀◀ Button (#8) to select the next song to be programmed and press the PROGRAM Button (#9) to store the second selection.
5. You may repeat steps #2 - #4 to program as many as 20 tracks. The programmed tracks will be shown in the LED Display (#13) one by one in the programmed sequence after the 20th selection has been stored.
6. To check the programmed tracks, press the PROGRAM Button (#9) repeatedly until the last Program No. appears and flashes in the Display and then press the PROGRAM Button (#9) once again. The programmed tracks will be displayed one by one in the programmed sequence.
7. Press the CD PLAY/PAUSE ►|| Button (#12) to start playing in the programmed sequence.
 - After all the programmed tracks have been played the player stops but the program remains in the memory.
 - Press the PLAY/PAUSE ►|| Button (#12) to begin programmed playback again.
8. To cancel programmed play, press the CD STOP ■ Button (#11).



CASSETTE RECORDER OPERATION

1. Open the Cassette Door and insert a pre-recorded cassette tape with the exposed tape facing upwards. Close the Cassette Door.
2. Press the Cassette Play Button (#21) to start playback and adjust the Rotary Volume Control (#5) to obtain the desired sound level.
3. Press the Cassette Pause Button (#25) to suspend play. Press same button again to resume.
4. Press the Cassette Fast Forward Button (#23) or the Cassette Rewind Button (#22) to rapidly advance or rewind the tape.
5. Press the Cassette Record Button (#20) to record either from the Radio, AUX IN or CD. Use the Function Selector (#1) to choose your signal source accordingly.
6. Press the Cassette Stop Button (#24) to stop operation.

AUTOMATIC STOP

To protect your cassette tapes and prevent unnecessary wear to the pinch roller of the cassette mechanism, this unit is equipped with an Automatic Stop System. When the tape ends during play, the Play Button (#9) will automatically release to stop the cassette from running.

CASSETTE TAPE OPERATING TIPS

1. High quality tapes are recommended to obtain maximum quality reproduction from recordings.
2. Tapes with playing time of 120 minutes (C-120) are not recommended because they contain thinner and longer tape that has a greater chance to malfunction and jam, which may damage the cassette mechanism.
3. To obtain good reproduction, the head should be cleaned after every 10 to 20 hours of use. It is also recommended that the cassette be kept away from excessive heat or cold.

4. If there is slack in the tape, remove the slack prior to inserting the cassette. To remove the slack, insert a pencil into the hub and rotate clockwise as shown below:

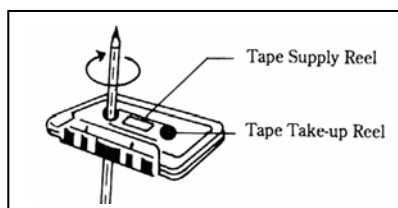

5. A leader tape is provided at the beginning on each cassette. There is no recording on this area, so it is necessary to let the tape run for about five seconds to clear the head.
6. Keep the tape head clean since a dirty head can cause distorted sound or improper tape speed. Depress the Cassette Play Button (#21) and use a small cotton swab with tape head cleaner or alcohol to clean the tape head, capstan and pinch roller as shown below:

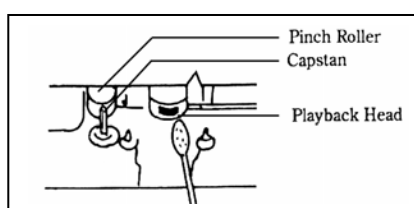

AUX IN OPERATION

You can play other music sources (MP3 or other digital audio players) through the speakers of this player by connecting the AUX IN Jack (#33) to your external player's audio out jack or headphone jack.

1. Plug one end of an audio cable (not included) into the AUX IN Jack (#33) and the other end of the cable to the headphone jack of your digital audio player.
2. Set the Function Selector (9) to "AUX".
3. Start playing the device you plugged into the AUX IN jack.
4. Adjust the VOLUME Control (#5) to a comfortable listening level.
5. To enhance the bass sound, press and release the BASS Button (#26) when a "click" is heard.
6. To turn the Radio off, set the Function Selector (#1) to the "TAPE" position.

USING HEADPHONES (NOT INCLUDED)

Inserting the plug of your headphones into the Stereo Headphone Jack (#29) will enable you to listen to the CD, Radio or Cassette music in private. When using headphones, the Built-in Speakers will be disconnected.

READ THIS IMPORTANT INFORMATION BEFORE USING YOUR HEADPHONES

1. Avoid extended play at very high volume as it may impair your hearing.
2. If you experience ringing in your ears, reduce the volume or shut off your unit.
3. Do not use while driving a motorized vehicle. This is dangerous and also illegal in some states.
4. Keep the volume at a reasonable level even if your headset is an open-air type designed to allow you to hear outside sounds. Please note excessive high volume may still block outside sounds.

CARE AND MAINTENANCE

1. Clean your unit with a damp (never wet) cloth. Solvent or detergent should never be used.
2. Avoid leaving your unit in direct sunlight or in hot, humid or dusty places.
3. Keep your unit away from heating appliances and sources of electrical noise such as fluorescent lamps or motors.
4. If drop-outs or interruptions occur in the music during CD play, or if the CD fails to play at all, its bottom surface may require cleaning. Before playing, wipe the disc from the center outwards with a good soft cleaning cloth.

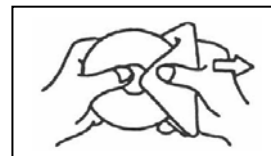

TROUBLE SHOOTING GUIDE

If you experience difficulties in the use of this music system, please check the following or call 1-800-777-5331 for Customer Service.

Symptom	Possible Cause	Solution
Noise or sound distorted on AM or FM broadcast	Station not tuned properly for AM or FM. FM: Telescopic antenna is not fully extended. AM: Internal antenna is not positioned correctly	Fine tune the AM or FM broadcast station. FM: Fully extend the FM Telescopic antenna. AM: Reposition the unit until the best reception is obtained.
AM or FM no sound	Unit not in Tuner mode, AM or FM band. Volume at minimum	Slide function selector to select AM or FM. Increase Volume
CD player will not play	Unit not in CD function mode. CD is installed incorrectly. If the CD is self-compiled, the media used may not be compatible with the player.	Select CD function mode. Insert CD with label side up. Use better quality blank media and retest.
CD skips while playing	Disc is dirty or scratched.	Wipe CD with clean cloth or use another disc.
Intermittent sound from CD Player	Dirty or defective disc. Dirty pick up lens. Player is subject to excessive shock or vibration	Clean or replace the defective disc. Use a CD-lens cleaning disc to clean the lens. Relocate the player away from shock or vibration
Cassette Player no sound	Unit not at TAPE function mode Volume at minimum	Slide function selector to TAPE Increase volume
Sound distorted	Dirty tape head	Clean the head
Speed varies	Tape old or worn Dirty roller and capstan	Replace the tape Clean roller and capstan
Cassette Recorder will not record	Prevention tab removed	Cover hole with tape
Distorted sound on playback	Defective tape or dirty tape head	Replace tape or clean tape head

SERVICE

Please refer to the instructions on the enclosed warranty card for returning your unit for service. When returning the unit, please remove batteries to prevent damage to the unit in transit and/or from possible battery leakage. We are not responsible for batteries returned with the product or for the cost of replacement.

Distributed by:

Spectra Merchandising International, Inc.

Chicago Industry Tech Park

4230 North Normandy Avenue

Chicago, IL 60634, U.S.A.

Please have model number ready, for Customer Service, call 1-800-777-5331

Printed in China