



Jetlun Gateway User Guide

User Guide

rev 0.3

Doc No: US-RD75606-0.3

88 PARKGROVE DRIVE | SO SAN FRANCISCO | CA | 94080 | USA
T: +1 866 498 2703 | F: +1 650 360 1977

© 2009-2010 Jetlun Corporation. All rights reserved.

Notice: No part of this publication may be reproduced or transmitted in any form or by any means, electronic or mechanical, including photocopying and recording, or stored in a database or retrieval system for any purpose without the express written permission of Jetlun Corporation.

Jetlun Corporation reserves the right to make changes to this user's guide at any time without notice and assumes no responsibility for its use. Jetlun products and services can only be ordered under the terms and conditions of Jetlun Corporation's applicable agreements. All of the features described in this user's guide may not be currently available. Refer to the most recent product announcement for information about feature and product availability.

This user's guide contains the most current information available at the time of publication. When new and/ or revised information becomes available, this entire user's guide is updated and distributed to all registered users.

Trademarks, Product Names, and Service Names

Jetlun, the stylized J logo, and the Jetlun logo are either trademarks or registered trademarks of Jetlun Corporation. All other product or service names are property of their respective owners.

<http://www.jetlun.com>

Table of Contents

1.0 ABOUT THIS GUIDE..... 5

 1.1 BECOMING FAMILIAR WITH THIS USER GUIDE..... 5

 1.1 *Quick Reference*..... 5

 1.2 *Icon Descriptions*..... 5

 1.3 GETTING ADDITIONAL HELP..... 5

 1.4 SENDING FEEDBACK REGARDING THIS DOCUMENTATION..... 5

2.0 PRODUCT OVERVIEW..... 6

 2.1 PACKAGE CONTENTS..... 6

 2.2 FRONT PANEL..... 6

 2.3 BACK PANEL..... 7

3.0 INSTALLING THE JETLUN GATEWAY..... 9

 3.1 CONNECTING THE JETLUN GATEWAY TO YOUR ROUTER..... 9

 3.2 CONNECTING TO THE JETLUN GATEWAY IN ABSENCE OF A ROUTER..... 9

 3.3 ACCESSING THE GATEWAY’S WEB UTILITY..... 10

4.0 CONFIGURING THE GATEWAY..... 11

 4.1 GATEWAY WEB-UTILITY NAVIGATION GUIDE..... 11

 4.2 CONFIGURATION AND MAINTENANCE..... 11

 4.2.1 Administration..... 11

 4.2.2 Setup..... 18

 4.2.3 Home Area Network..... 24

 4.2.4 Dashboard..... 26

 4.2.5 Trends..... 27

5.0 LEGAL AND REGULATORY NOTICES..... 30

 5.1 IMPORTANT NOTE OF MODIFICATIONS..... 30

 5.2 NATIONAL AND REGIONAL REGULATORY NOTICES..... 30

 5.2.1 U.S. Federal Communications Commission (FCC) Notifications..... 30

 5.2.2 Declarations of Conformity..... 31

 5.3 USER INFORMATION FOR CONSUMER PRODUCTS COVERED BY EU DIRECTIVE 2002/96/EC ON WASTE ELECTRIC AND ELECTRONIC EQUIPMENT (WEEE)..... 33

 5.4 LEGAL NOTICES..... 39

 5.4.1 *Software License Terms and Conditions*..... 39

 5.4.2 *Hardware Warranty in U.S.*..... 42

 5.4.3 *Limit of Liability*..... 42

6.0 TECHNICAL SPECIFICATIONS..... 44

List of Figures

Figure 1: Front Panel of the Gateway..... 6

Figure 2: Back Panel of the Gateway..... 7

Figure 3: Top menu screenshot	11
Figure 4: Administration > Management screenshot	12
Figure 5: Administration > Alerts screenshot	13
Figure 6: Administration > Logs screenshot	14
Figure 7: Administration > Factory Default screenshot	15
Figure 8: Administration > Firmware Upgrade screenshot	16
Figure 9: Administration > Configuration Management screenshot	17
Figure 10: Setup > Basic Setup screenshot	19
Figure 11: Setup > Network screenshot	20
Figure 12: Setup > Time screenshot	21
Figure 13: HomePlug AV NEK screenshot	22
Figure 14: HPPC Network screenshot	23
Figure 15: Home Area Network screenshot	24
Figure 16: Dashboard screenshot	27
Figure 17: Trends Snapshot	28

List of Tables

Table 1: Where to find information in this User Guide	5
Table 2: Icon descriptions	5
Table 3: Front Panel LED Description	6
Table 4: Back Panel of the Gateway Description	8

1.0 ABOUT THIS GUIDE

1.1 Becoming familiar with this User Guide

1.1.1 Quick Reference

The Jetlun Gateway (RD75606) User Guide describes the following:



Table 1: Where to find information in this User Guide

Planning and Installing the Jetlun Gateway	Chapter 2 and 3
Configuring and maintaining the Jetlun Gateway	Chapter 4 and 5

1.2 Icon Descriptions

While reading through the User Guide, you may see various icons that call attention to specific items. Below is a description of these icons:

Table 2: Icon descriptions

	NOTE: This mark indicates that there is a note of interest and is something that you should pay attention to while using the product.
	IMPORTANT: This mark identifies an indication that you should watch for, or reiterates something that you should always keep in mind.
	WARNING: This exclamation point indicates that there is a caution or warning and may be something that could damage your property or project.

1.3 Getting Additional Help

To get information or assistance for problems that you encounter, please contact Jetlun Technical Support by emailing support@jetlun.com.

Please always include with all inquiries the following information:

- Product name, model number, part number (if applicable) and serial number
- A description of the devices connected to your Gateway or a system configuration
- The circumstances surrounding the error or failure
- A detailed description of the problem and what has been done to try to resolve it

1.4 Sending Feedback regarding this Documentation

We welcome your feedback on Jetlun Gateway documentation. This includes feedback on the structure, content, accuracy, or completeness of our documents, and any other comments you may have. Please send your comments to docs@jetlun.com.

2.0 PRODUCT OVERVIEW

Thank you for choosing the Jetlun Gateway (RD75606). The Gateway collects and stores all the energy usage information collected from the other Jetlun devices on your network. You can also use the Gateway to centrally manage and control the Jetlun devices on your network. When the Gateway is connected to a residential router, it can be configured for remote access.

The Jetlun Gateway is a powerful energy management system that integrates four types of network connectivity technologies: (1) standard Ethernet operating up to 100 Mbps; (2) Zigbee® wireless operating at up to 250 Kbps; (3) HomePlug® Command and Control operating over the existing home wiring at up to 7.5 Kbps; and (4) HomePlug AV operating over the existing home wiring at up to 200 Mbps. By integrated these four network connectivity technologies, the Jetlun Gateway provides the utmost flexibility in installation and the most pervasive network solution for your home.

2.1 Package Contents

When you first open the box, please check and confirm that the following items are all included:

- 1x Gateway RD75606
- 1x Universal Power Supply
- 1x 6 ft Ethernet cable
- 1x Quick Installation Guide

If any of the parts are incorrect, missing or damaged, contact the retailer where you made your purchase. Keep the carton, including the original packaging materials in case you need to return the unit for repair.

2.2 Front Panel

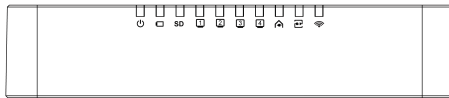







Figure 1: Front Panel of the Gateway

Table 3: Front Panel LED Description

	The Power LED lights up GREEN and will stay on while the Gateway is powered on. When the Gateway goes through its self-diagnostic mode during every boot-up, this LED will flash GREEN. When the diagnostic cycle is complete, the LED will be
---	--

	GREEN and solidly lit.
	The Battery LED lights up GREEN when you turn on the battery and the battery is full. When the Gateway has no external power and is operating on the battery power, this LED will flash RED. When the Gateway has external power and is recharging the battery, this LED will flash GREEN.
SD	The SD LED lights up GREEN when you have an SD memory card plugged into the memory slot located on the back of the Gateway. When there is no SD memory card plugged in, this LED will NOT be lit.
 1, 2, 3, 4	These numbered LEDs, corresponding with the numbered ports on the Gateway's back panel, serve two purposes. If the LED is continuously lit GREEN, the Gateway is successfully connected to a device through that port. A flashing LED indicates network activity over that port.
	The HPCC LED continuously lights up GREEN when the Gateway is successfully connected to another HPCC (narrowband powerline) device on the network. If the LED is flashing, the Gateway is actively sending or receiving data over the network. If the LED is flashing RED, the Gateway is experiencing collisions on the network.
	The HPAV LED continuously lights up GREEN when the Gateway is successfully connected to another HPAV (broadband powerline) device on the network. If the LED is flashing, the Gateway is actively sending or receiving data over the network. If the LED is flashing RED, the Gateway is experiencing collisions on the network.
	The Zigbee LED continuously lights up GREEN when the Gateway is successfully connected to another Zigbee device on the network. If the LED is flashing, the Gateway is actively sending or receiving data over the network. If the LED is flashing RED, the Gateway is experiencing collisions on the network.

2.3 Back Panel

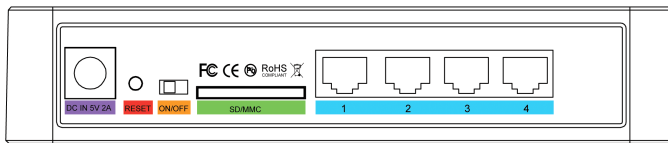







Figure 2: Back Panel of the Gateway

Table 4: Back Panel of the Gateway Description

	The Power port is where you will connect the power adapter.
	There are two ways to reset the Router's factory defaults. Either press and hold the Reset Button for approximately five seconds, or restore the defaults with your computer from Administration > Factory Defaults in the Gateway's web-based utility.
	The Battery switch is where you turn on/off the backup battery in the Gateway. By default, the Gateway battery is turned OFF. It is recommended that you turn the battery to the ON position during installation.
	The SD/MMC port is where you will plug in an SD memory card.
	These Ethernet ports (1, 2, 3, 4) connect the Gateway to PCs on your wired network and other Ethernet network devices.

3.0 INSTALLING THE JETLUN GATEWAY

Follow these quick steps to install your Jetlun Gateway.

3.1 Connecting the Jetlun Gateway to your Router

- **STEP 1:** Connect the supplied Ethernet cable to an available port on your router and connect the other end of the Ethernet cable to one of the four ports on the back of the Gateway.
- **STEP 2:** Turn off your PC or laptop. Then, using an Ethernet cable, connect your PC or laptop to one of the three other available ports on the back of the Gateway.
- **STEP 3:** Connect the Gateway Universal Power Supply to the Power port on the back of the Gateway and plug in to a nearby power outlet. Wait about 30 seconds for the lights to stop blinking.



IMPORTANT: Plug the Jetlun Gateway *directly* into an electrical outlet. Do not plug the Gateway into a UPS, power strip, or other similar device with surge protection. The Gateway has its own power filter for protection against surges.

- **STEP 4:** Now, you can turn on your PC or laptop.
- **STEP 5:** Locate the Gateway IP address from your Router Local Area Network (LAN) client list.
- **STEP 6:** To access the Gateway's web-based utility, launch the web browser on your computer, and enter the assigned IP address of the Gateway from your router in the Address field. Then, press Enter.

3.2 Connecting to the Jetlun Gateway in absence of a Router

- **STEP 1:** Turn off your PC or laptop. Then, using an Ethernet cable, connect your PC or laptop to one of the three other available ports on the back of the Gateway.
- **STEP 2:** Connect the Gateway Universal Power Supply to the Power port on the back of the Gateway and plug in to a nearby power outlet. Wait about 30 seconds for the lights to stop blinking.



IMPORTANT: Plug the Jetlun Gateway *directly* into an electrical outlet. Do not plug the Gateway into a UPS, power strip, or other similar device with surge protection. The Gateway has its own

power filter for protection against surges.

- **STEP 3:** Now, you can turn on your computer.
- **STEP 4:** Set a static IP address on your computer to **192.168.1.97**.
- **STEP 5:** To access the Gateway's web-based utility, launch the web browser and enter the following Gateway default IP address **192.168.1.230**, in the Address field. Then, press Enter.

3.3 Accessing the Gateway's Web Utility

- **STEP 1:** Upon bringing up the Gateway login page, enter your user ID and password. The first time you open the web-based utility, use the default user ID **admin** and the default password **admin**. (You can set a new password from the Administration tab's Management screen.) Click Login to continue.

When you first log in, the Dashboard screen will be displayed.

4.0 CONFIGURING THE GATEWAY

4.1 Gateway Web-Utility Navigation Guide

The user interface is divided into five main categories:

- **Dashboard.** The Dashboard tab provides an overview of your Jetlun Intelligent Management (JIM) System for the current day.
- **Trends.** The Trends tab provides a detailed view of your JIM system by device and provides an expanded view of your historical energy usage information.
- **Home Area Network.** The Home Area Network tab provides a list of Jetlun devices on the network. Its status and allows you to control it.
- **Setup.** The Setup tab allows you to change basic settings, set or change date and time information, and configure the network.
- **Administration.** The Administration tab allows you to change passwords, backup the settings, reboot the system, view log information, and upgrade the Gateway firmware.

At the top of each screen is a Reboot link to restart the Gateway, a Logout link to log out of the Gateway and a link to sign up for Google’s PowerMeter service.



Figure 3: Top menu screenshot

4.2 Configuration and Maintenance

4.2.1 Administration

4.2.1.1 Management

The Administration > Management screen allows you to change the login User Name and Password to the Gateway. Changing the Gateway User Name and Password ensures security to your Gateway. The default User Name is **admin** and the default Password is **admin**.

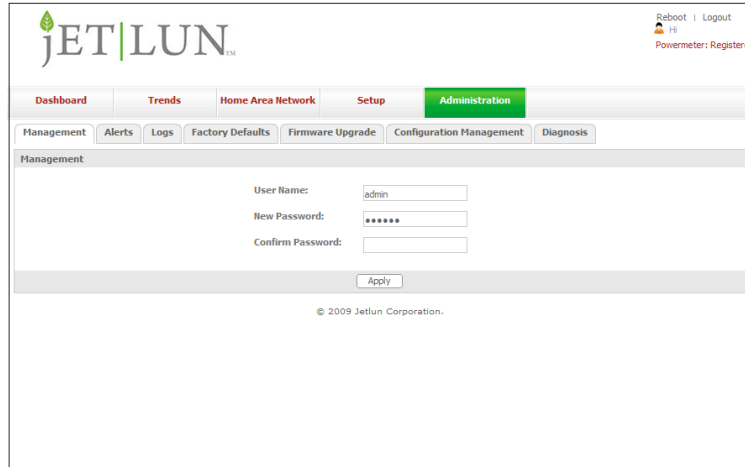



Figure 4: Administration > Management screenshot

	<p>NOTE: Please note that the User ID and Password to the web-utility is case sensitive.</p>
---	---

4.2.1.2 Alerts

The Administration > Alerts screen allows you to configure Alerts to receive an email or text message to your mobile phone based on an event.

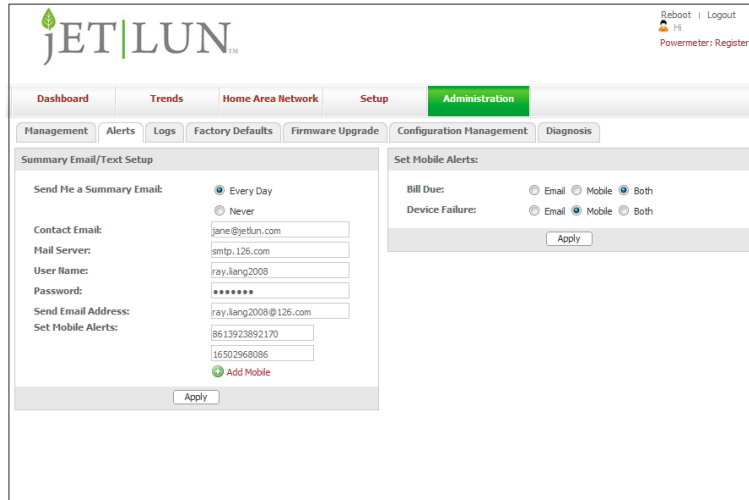

Figure 5: Administration > Alerts screenshot

To configure Alerts, follow these steps:

- ➔ **STEP 1:** Under Alert Frequency, select Every Day.
- ➔ **STEP 2:** Enter your email address.
- ➔ **STEP 3:** Enter your full Mail Server address.
- ➔ **STEP 4:** Enter your User Name for your email.
- ➔ **STEP 5:** Enter your Password to your email account.
- ➔ **STEP 6:** Enter your email address registered in the mail server.
- ➔ **STEP 7:** Click Apply.

Then, specify whether you would like to receive an email or a text message to your mobile phone according to an event, select either Email or Mobile or Both under each event.

4.2.1.3 Logs

The Administration > Logs screen keeps a record of your Gateway activities. It can be configured to email you copies of your log files directly if the Gateway is connected to the Internet.

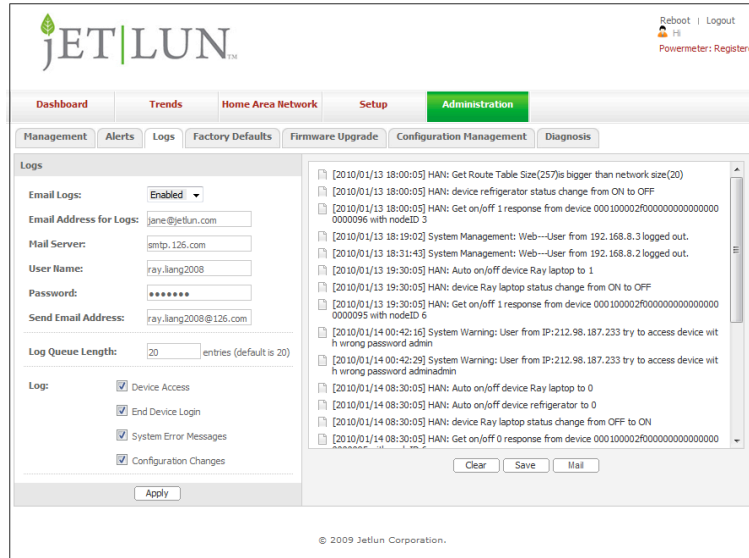



Figure 6: Administration > Logs screenshot

To configure logs to be emailed to you on a regular basis, follow these steps:

- ➡ **STEP 1:** Select Enabled from the Email Logs field.
- ➡ **STEP 2:** Enter your full email address under Email Address for Logs (i.e. **johndoe@gmail.com**)
- ➡ **STEP 3:** Enter your full Mail Server address.
- ➡ **STEP 4:** Enter your User Name for your email.
- ➡ **STEP 5:** Enter your Password to your email account.
- ➡ **STEP 6:** Enter your email address registered in the mail server.
- ➡ **STEP 7:** Enter the log queue length. By default, the log queue is set to 20.
- ➡ **STEP 8:** Select the type of logs you would like to keep a record of.
- ➡ **STEP 9:** Click Apply.

	NOTE: The email log function will not work if the Gateway is not connected to the Internet.
---	--

4.2.1.4 Factory Defaults

The Administration > Factory Defaults screen allows you to restore the Gateway’s configuration to its factory default settings.

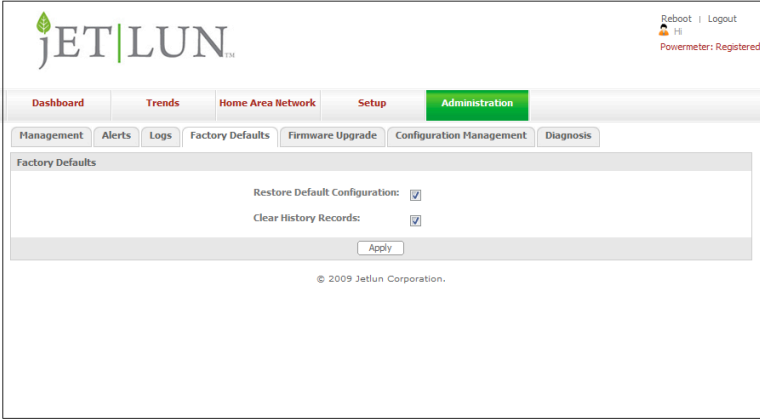



Figure 7: Administration > Factory Default screenshot

	NOTE: Do not restore the factory defaults unless you are having difficulties with the Gateway and have exhausted all other troubleshooting measures. Once the Gateway is reset, you will have to re-enter all of your configuration settings.
---	--

To restore to Factory Default settings, follow these steps:

- ➔ **STEP 1:** Check the box, Restore Default Configuration.
- ➔ **STEP 2:** Check the box, Clear Historical Records (optional).

	NOTE: Clear Historical Records will delete the energy usage information off your Gateway. Uncheck this box if you want to retain your usage information.
---	---

- ➔ **STEP 3:** Click on Apply.

4.2.1.5 Firmware Upgrade

The Administration > Firmware Upgrade screen allows you to upgrade the Gateway’s firmware. Do not upgrade the firmware unless you are

experiencing problems with the Gateway or the new firmware has a feature you want to use.

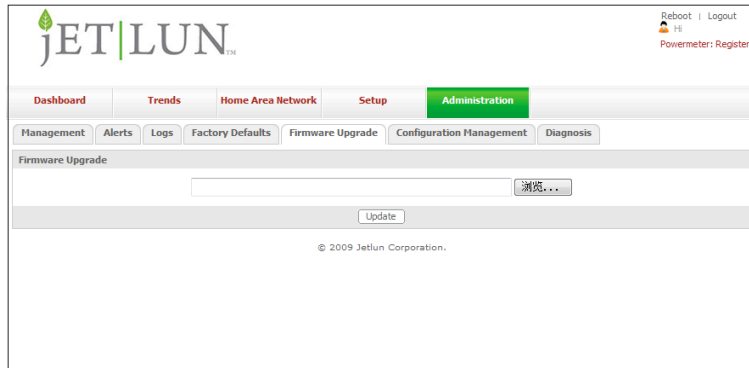



Figure 8: Administration > Firmware Upgrade screenshot

	<p>NOTE: Upgrading firmware may cause the Gateway to lose your custom settings. Before you upgrade firmware, write down all of your custom settings. After you upgrade firmware, you may have to re-enter some or all of your configuration settings.</p>
---	--

To upgrade Gateway's firmware, follow these steps:

- ➔ **STEP 1:** Download the Gateway's firmware upgrade file from Jetlun Technical Support by emailing support@jetlun.com.
- ➔ **STEP 2:** Click Browse and select the downloaded file.
- ➔ **STEP 3:** After you have selected the appropriate file, click Update, and follow the on-screen instructions.

4.2.1.6 Configuration Management

The Administration > Configuration Management screen allows you to save configuration settings and restore a saved configuration setting file.



Figure 9: Administration > Configuration Management screenshot

To save a configuration setting:

- ➡ **STEP 1:** Click Save, pop a dialog frame.
- ➡ **STEP 2:** Click Save in the dialog frame and click browse to locale where you want to save the configuration file.
- ➡ **STEP 3:** Name the file.
- ➡ **STEP 4:** Click save.

To restore a saved configuration setting file:

- ➡ **STEP 1:** Click Browse, to locate where your saved configuration file.
- ➡ **STEP 2:** Click Restore.

4.2.1.7 Diagnosis

The Administration > Diagnosis screen allows you to diagnosis the energy measurement for all devices in the network.

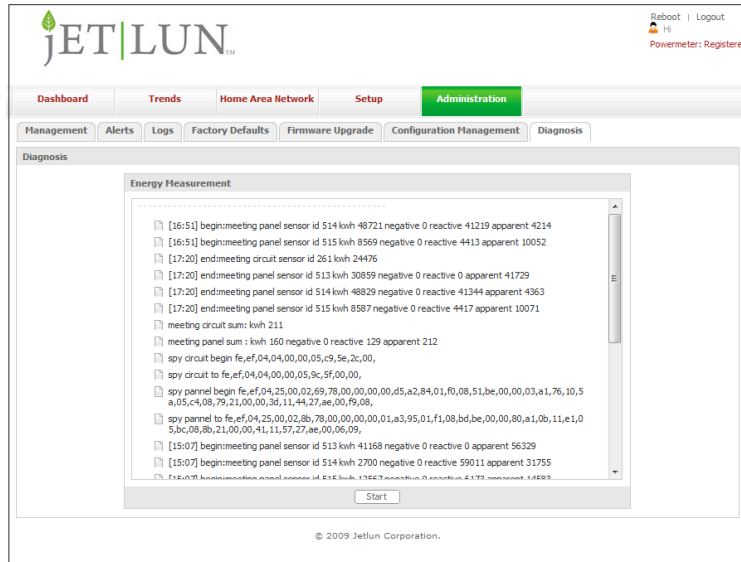

Figure 10: Administration > Diagnosis screenshot

To diagnose energy measurement:

- **STEP 1:** Click Start, begin the diagnosis and the result will be shown in the screen
- **STEP 2:** Click Stop to halt the diagnosis

4.2.2 Setup

4.2.2.1 Basic Setup

The Setup > Basic Setup screen allows you to configure basic information about your home setup.

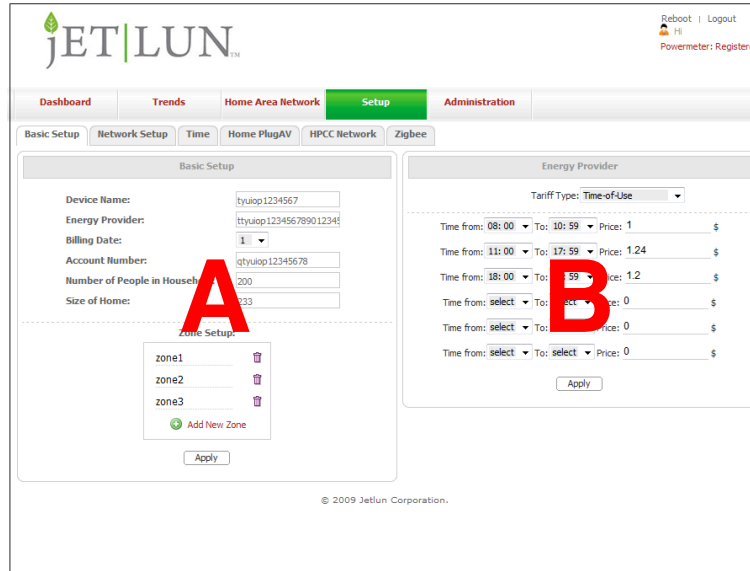



Figure 11: Setup > Basic Setup screenshot

The left column (A), allows you to specify:

- **Energy Provider.** Enter your current energy provider name (i.e. PG&E)
- **Billing Date.** Enter the day you receive your bill. (i.e. if you receive the bill for period between July 15 through August 14, put 15)
- **Account Number with your current energy providers.** Enter your account number with your current energy provider.
- **Number of People in your Household.** Enter the number of people living in your home.
- **Size of Home.** Enter the size of your home in square footage.
- **Zones Setup.** The Gateway allows you to divide your home into Zones (or rooms). You can add a Zone by click on the + icon, entering your Zone name and click Apply.

The right column (B), allows you to enter in your desired tariff (rate) from your energy provider. The Gateway gives you two types of customizable tariff settings: You can either configure by Time-Of-Use (a distinct period of time that you set yourself) or by Usage-Tier (based on a minimum amount of wattage used.) To configure by Time-Of-Use, select Time-Of-Use in the **Tariff Type** selection menu, and simply create your own customized time period using the **Time from** and **To** drop-down menus, enter the price and click Apply when complete. To configure by Usage-Tier, enter a wattage amount value (kWh) for each respective tier (you

may create up to 6 separate tiers, or minimum wattage levels, with tier 1 representing the lowest value and tier 6 the highest.)

	NOTE: Please note: the interface will not allow you to proceed- and a warning announcement will appear to this effect- if a higher tier has a lower value than any lower tier (or vice versa)
	NOTE: Please note: you must obtain rate information from your utility provider before entering into the fields.

4.2.2.2 Network Setup

The Setup > Network Setup screen allows you to configure the Gateway to use a Static IP or to obtain a Dynamic IP from your router. By default, the Gateway is configured to automatically obtain a Dynamic IP from your gateway.

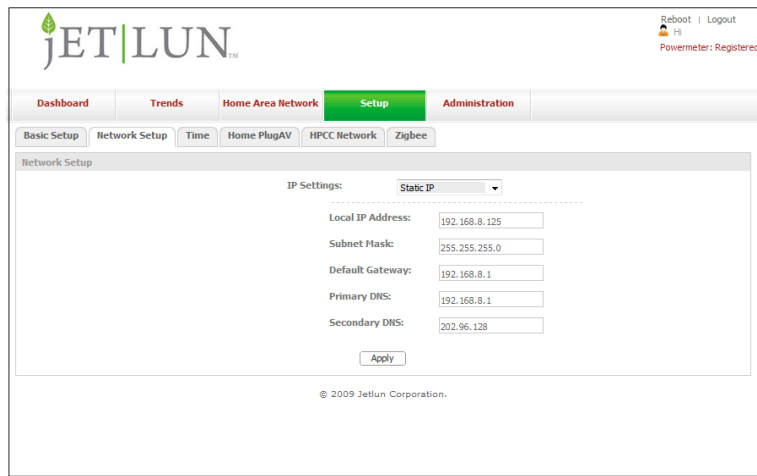



Figure 12: Setup > Network screenshot

To configure the Gateway with a Static IP, simply select Static IP under IP settings and enter in your IP Address, Subnet Mask, Default Gateway IP, and DNS. Then, click Apply.

	IMPORTANT: Please ensure your subnet mask matches the subnet of your network.
---	--

To switch to Dynamic IP, simply select Dynamic IP under IP Settings and click Apply.

4.2.2.3 Time

The Setup > Time screen allows you to configure the Timezone, DATE and TIME of the Gateway.

	NOTE: The Gateway uses a 24-hour time format.
---	--

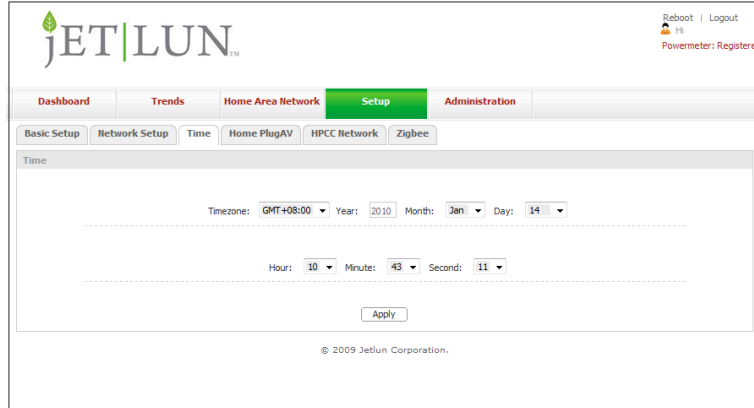



Figure 13: Setup > Time screenshot

To configure the date and time, simply enter the Year, select the Month, Day, Hour, Minute and Seconds.

	NOTE: The Gateway will automatically attempt to synchronize itself with the time on your computer and will automatically adjust for Daylight Savings only if your computer is configured to do so.
--	---

4.2.2.4 HomePlug AV

The Setup > HomePlug AV screen allows you to configure the network encryption key (NEK) for your broadband HomePlug AV Powerline network.

	NOTE: Encryption of the information you send over the Powerline helps keep it secure. The Powerline NEK is similar to the SSID and encryption key used in wireless networks.
---	---

	IMPORTANT: Powerline devices on the same network must use an identical encryption key. The Gateway's
---	---

default encrypted (case-sensitive!) password is **HomePlugAV**. If you do not set up security, anyone nearby with a Powerline network can use this to gain access to your network.

 **IMPORTANT:** The Setup > HomePlug AV screen provides an interface to configure the NEK on the Gateway *only*. To configure the NEK for other remote HomePlug AV devices, please follow the instructions that came with that HomePlug AV device.

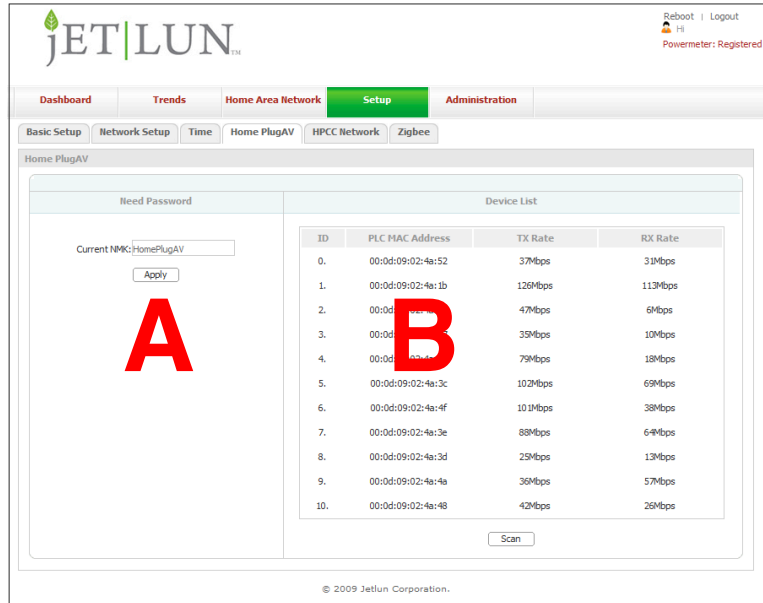

Figure 14: HomePlug AV NEK screenshot

To change the NEK on the Gateway, please enter the new NEK under the left column (A) and click Apply. The right column (B) identifies other HomePlug AV devices on the network with the same NEK.

4.2.2.5 HPCC Network

The Setup > HPCC Network screen allows you to configure the security of your HPCC network. If you want HPCC devices such as the Jetlun Appliance Module (RD75613) to join the network automatically, select Auto and click Apply. If you prefer to authenticate each device manually first, select Approval and click Apply.

Please note: Any device added manually (by clicking Approval) will NOT automatically show up in the Home Area Network Overview screen (see next section, 4.2.3.)

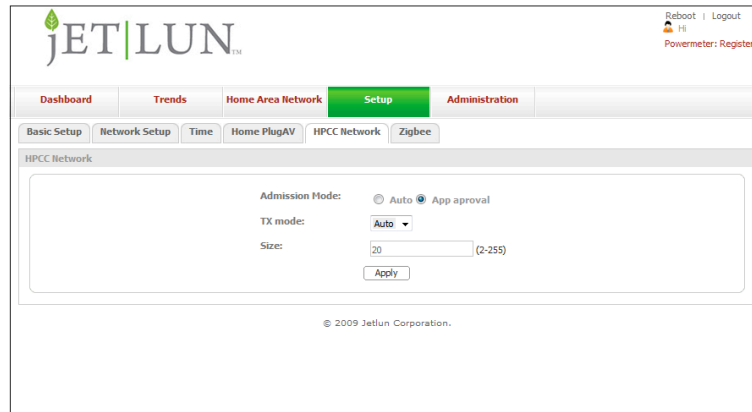

Figure 15: HPCC Network screenshot

4.2.2.6 Zigbee

The Setup > Zigbee screen allows you to configure permission for zigbee device joining your Zigbee Network.

Figure 16: Zigbee screenshot

To configure the permission

- **STEP 1:** Click the Leave, if there are devices in the zigbee network, they all leave the former network.
- **STEP 2:** Enter Channel ID, Power Level and Pan ID.

➔ **STEP 3:** Click the Form. All the zigbee devices join the same network will show up in the Home Area Network. (See 4.2.3)

4.2.3 Home Area Network

4.2.3.1 Network Overview

The Home Area Network > Network Overview screen provides a list of the devices connected to your Gateway. Devices should automatically appear on the table when they are connected on the network.

Please note: Any device that was added manually on the HPCC Network page will NOT automatically show up in the Home Area Network Overview screen. To add a device, click on Add, and then manually key in the serial number located on the back of the client device.

SN	Device Name	Zone	Sensors	Type	Status	Auth	Operate
000100002f00010000000000000000002d	meeting circuit	zone1	power	Circuit meter	ONLINE	DISABLE	[Icons]
000100002f000000000000000000000072	panel	zone1	power	Panel meter	ONLINE	ENABLE	[Icons]
000100002f000000000000000000000095	Ray laptop	zone5	power	Appliance module	ON	ENABLE	[Icons]
000100002f000000000000000000000096	refrigerator	zone4	power	Appliance module	ON	ENABLE	[Icons]
000d6f000050e8e9000000000000000000	test_aircon	zone2	N/A	Zigbee Aircon	OFFLINE	ENABLE	[Icons]
000d6f000050e929000000000000000000	test_H T	zone4	HSD	Zigbee HT	OFFLINE	ENABLE	[Icons]
000d6f000050e8ef0000000000000000000	N/A	N/A	occupancy	Zigbee Occupancy	OFFLINE	ENABLE	[Icons]
000d6f0000488473000000000000000000	ray	zone1	power	Zigbee Appliance	OFFLINE	ENABLE	[Icons]

Figure 17: Home Area Network screenshot

Each row in the table lists a device serial number (S/N), Device Name, Zone, Type of Sensor, Status* (ONLINE / OFFLINE, or ON / OFF), Authentication and Operate mode.

*In the Status column, ONLINE/OFFLINE refers to whether a device is connected to the Gateway or not. Devices that do not have remote command functionality will only show as either ONLINE (connected) or OFFLINE (disconnected.) Devices that support remote on/off command functions will show ON or OFF in the their Status column if they are

connected, and OFFLINE if they are not connected. If showing ON/OFF, clicking ON/OFF allows you to remotely switch that device either on or off.

Zigbee devices that support remote on/off command functions will show High or Medium or Low or OFF or ON in their Status column if they are connected and OFFLINE if they are not connected. If showing High/Medium/Low/OFF, click High/Medium/Low/OFF allows you to remotely switch that device off or high or medium or low.

Zigbee devices that do not have remote command functionality will show as OFFLINE(disconnected) or Humidity&Temperature(connected).

In the case of an OFFLINE status setting, make sure to check that the device is plugged *directly* into a power outlet. Ensure that no switching power supplies are nearby, as they can interfere with powerline connectivity.

When a device first joins the network but has not been authenticated, you will see it listed but grayed out, as illustrated in the top row (eg: Circuit Meter) of Figure 17. To authenticate onto the network, click on DISABLE (under the Auth column) and it will automatically change to say ENABLE in green text.

To customize each device on the Home Area Network, click on the [edit] icon in the Operate column. A pop-up window will appear and allow you to name the device, specify the device zone, and create a custom name for each sensor.

To remove or delete a device from the Home Area Network, click on the [delete] icon under the Operate column in that device's row.

	<p>WARNING: If the zigbee device is deleted, that device can not join the network anymore otherwise the network is rebuilt.</p>
--	--

zhyuehua 1/13/10 11:48 AM
Comment: New add

To configure device automatic service, click on the [auto service] icon in the Operate column. A pop-up window will appear and allow you to define the time, day and operation (on or off)

To configure zigbee device permission, click on the [zigbee network] icon in the Operate column. A pop-up window will appear and allow you to change the Channel ID, Power Level and Pan ID.

	<p>WARNING: If the zigbee device permission is not the same as that in the setup->zigbee, the zigbee device will leave the network</p>
---	--

zhyuehua 1/13/10 11:48 AM
Comment: New add

To configure the Thermostat, click on the [Thermostat] icon in the Operate column. A pop-up window will appear and allow you to select the option you want.

	NOTE: The Home Area Network > Network Overview screen automatically refreshes every 60 seconds. During initial setup, it may take a few minutes for the Gateway to register the devices on the network.
---	--

4.2.4 Dashboard

The Dashboard screen displays a summary of your gateway's status of the day.

In Figure 16 below, the section labeled A displays Date and Time, as well as the System Details of your Gateway, which includes Hardware Version, Software Version, how long the system has been up (System Uptime).

Section B displays your Energy Usage Overview for the current day in the form of a bar graph. (A day's duration is from 0:00 Midnight to 11:59pm of that date.) You can view your usage broken down by Hour, by 30 minute increments, by 15 minute increments, or even by single minute increments.

You can also view your energy usage in terms of kWh, kVARh, pf, Volts, Amps, Cost, and even calculated equivalents for Carbon Dioxide emissions, Miles Driven and Watt.

Section C provides a summary of your power usage, costs and environmental impact in terms of calculated carbon emissions due to energy usage for the current billing period. You can choose a broad overview (default view) of total usage and cost information, or you can view a summaries based on only the circuits that are being monitored, on the Panel Meter, on a sum of the Appliance Modules, or on a sum of the Zigbee Appliance Modules. Clicking on any of these choices in the top row will bring up summaries for each of these.

Section D provides a snapshot summary of your Home Area Network setup.

zhyuehua 1/13/10 1:22 PM
Comment: No current mode setting

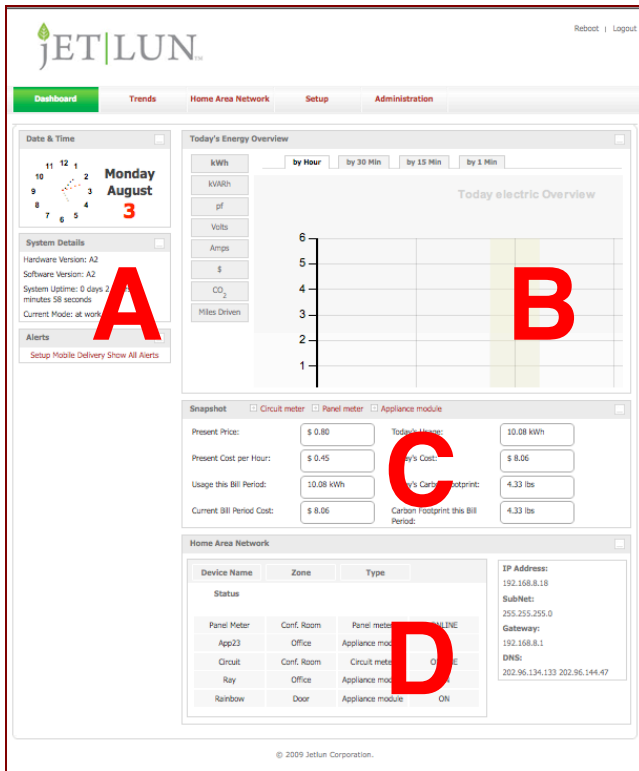

Figure 18: Dashboard screenshot

4.2.5 Trends

The Trends screen displays an historical overview of your energy usage trends in terms of kWh, kVARh, pf, Volts, Amps, Cost, and calculated equivalents for Carbon Dioxide emissions and Miles Driven. By defining the start date (green arrow icon) and end date (yellow arrow icon) fields, you can choose to view your energy usage trends over any length of time that your Gateway has been operational.

The trends screen also display the percentage of energy usage per device for historical data. You can view the details for kWh, Cost, and calculated equivalents for Carbon Dioxide emissions and Miles Driven by circuit, by phrase, by appliance, by zigbee appliance or by zone



Figure 19: Trends Snapshot

4.2.6 Powermeter

The powermeter is used to view the energy usage from the google web.

To configure the powermeter,

- ➔ **STEP 1:** Click the Powermeter link at the top of the screen
- ➔ **STEP 2:** Enter the sign in page, Click the Accept
- ➔ **STEP 3:** Enter the google powermeter page, input the username and password for igoogle, then click Sign in

	<p>NOTE: you should have an igoogle account or you can register an igoogle account follows the instruction in the web, otherwise you will fail to register powermeter.</p>
---	---

- ➔ **STEP 4:** Name your device and input your location, then click the Next

- ➔ STEP 5: Enter the google powermeter page, and name the measurement title;Click the Active this device
- ➔ STEP 6: Enter Finish page and click the Add the Google PowerMeter gadget to your iGoogle
- ➔ STEP 7: Enter the powermeter page and view the energy usage

If you have configured the powermeter,

- ➔ STEP 1: Click the Powermeter link, enter the sign in page
- ➔ STEP 2: Click the See your data in iGoogle and view the energy usage

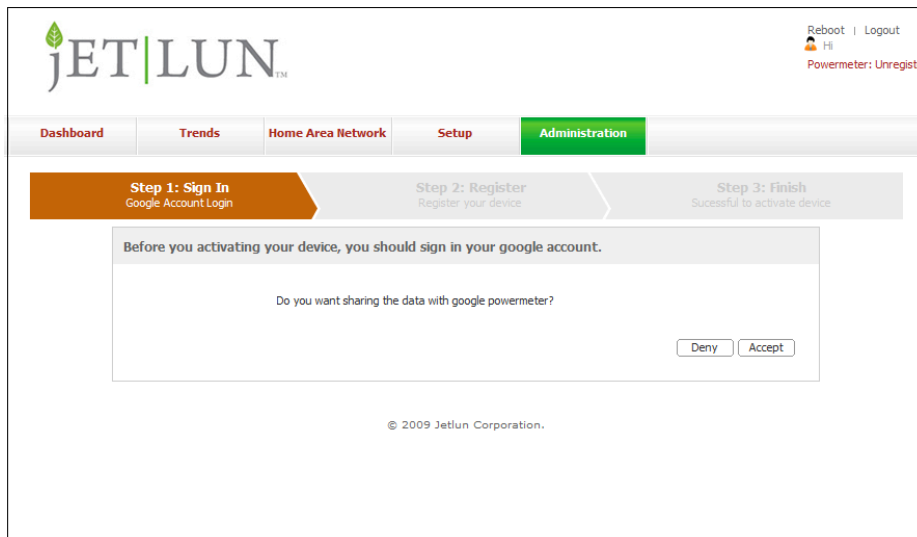

5.0 LEGAL AND REGULATORY NOTICES

5.1 Important Note of Modifications

Intentional or unintentional changes or modifications to the equipment must not be made unless under the express consent of the party responsible for compliance. Any such modifications could void the user's authority to operate the equipment and will void the manufacturer's warranty.

5.2 National and Regional Regulatory Notices

5.2.1 Federal Communications Commission (FCC) Notifications

This device complies with part 15 of the FCC Rules . Operation is subject to the following two conditions: (1) This device may not cause harmful interference, and (2) This device must accept any interference received, including interference that may cause undesired operation.

Note: This equipment has been tested and found to comply with the limits for a Class B digital device, pursuant to Part 15 of the FCC Rules. These limits are designed to provide reasonable protection against harmful interference in a residential installation. This equipment generates, uses, and can radiate radio-frequency energy and, if not installed and used in accordance with the instructions, may cause harmful interference to radio communications. However, there is no guarantee that interference will not occur in a particular installation. If this equipment does cause harmful interference to radio or television reception, which can be determined by turning the equipment off and on, the user is encouraged to try to correct the interference by one or more of the following measures:

- Reorient or relocate the receiving antenna;
- Increase the separation between the affected equipment and the receiver;
- Connect the affected equipment into an outlet on a circuit different from that to which the receiver is connected;
- Consult the dealer or experienced radio/TV technician for help.

FCC RF Radiation Exposure Statement

This equipment complies with FCC RF radiation exposure limits set forth for an uncontrolled environment. This equipment should be installed and operated with a minimum distance of 20 centimeters between the radiator and your body.

Note: The manufacturer is not responsible for any radio or TV interference caused by unauthorized modifications to this equipment. Such modifications could void the user's authority to operate the equipment.

5.2.2 Declarations of Conformity

A signed declaration of conformity to the requirements of the Council of the European Communities follows:

Deutsche [German]	Hiermit erklärt Jetlun, dass sich diese <i>Jetlun Gateway (RD75606)</i> , in Übereinstimmung mit den grundlegenden Anforderungen und den anderen relevanten Vorschriften der Richtlinie 1999/5/EG befindet. (BMWi)
	Hiermit erklärt Jetlun die Übereinstimmung des Gerätes <i>Jetlun Gateway (RD75606)</i> , mit den grundlegenden Anforderungen und den anderen relevanten Festlegungen der Richtlinie 1999/5/EG. (Wien)
English	Hereby, Jetlun, declares that this <i>Jetlun Gateway (RD75606)</i> , is in compliance with the essential requirements and other relevant provisions of Directive 1999/5/EC.
Español [Spanish]	Por medio de la presente Jetlun declara que le <i>Jetlun Gateway (RD75606)</i> , cumple con los requisitos esenciales y cualesquiera otras disposiciones aplicables o exigibles de la Directiva 1999/5/CE.
Français [French]	Par la présente Jetlun declare que l'appareil <i>Jetlun Gateway (RD75606)</i> , est conforme aux exigences essentielles et aux autres dispositions pertinentes de la directive 1999/5/CE.
	Par la présente, Jetlun declare que ce <i>Jetlun Gateway (RD75606)</i> , est conforme aux exigences essentielles et aux autres dispositions de la directive 1999/5/CE qui lui sont applicables.

DECLARATION OF CONFORMITY

Jetlun declares under its sole responsibility that the products, to which this declaration relates, conform to the applicable essential requirements of the following Directive(s) of the Council of the European Communities:

- 1999/5/EC of the European Parliament and of the Council of 9 March 1999 on the radio equipment and telecommunications terminal equipment and the mutual recognition of their conformity (R&TTE Directive).
- 89/336/EEC of 3 May 1989 on the approximation of the laws of the Member States relating to electromagnetic compatibility (EMC Directive).
- 72/23/EEC of 19 February 1973 on the harmonization of the laws of the Member States relating to electrical equipment designed for use within certain voltage limits (LV Directive).

Product: Jetlun Gateway **RD75606X**

Where "X" = "C", "G"

Model Number	Description
RD75606C	Jetlun Gateway Type C Plug – 2 round pin European
RD75606G	Jetlun Gateway Type G Plug – UK pin

Manufacturer: Jetlun Corporation

Conformity: Harmonized standards used to demonstrate conformity:

The products have been shown to meet the following requirements:

- a) Safety – certified to EN 60950-1:2001+A11:2004 First Edition
- b) EMC – certified to meet EN55022:1998+A1:2000+A2:2003 (class B), EN55024:1998+A1:2001+A2:2003, CISPR/1/xyz/DPAS CISPR 22 A2 f9 Ed 4.0 with T- ISN, EN 61000-3-2:2000+A2:2005, EN 61000-3-3+A1:2001+A2:2005

Year of first application of CE mark: 2009

Notified Body number: 0682

Notified Body address: CETECOM ICT Services GmbH, Untertürkheimer Straße 6-10, D-66117 Saarbrücken, Germany

Signature:

Name: TK Chan
Title: CTO
Date: MM/DD/YY

5.3 User Information for Consumer Products Covered by EU Directive 2002/96/EC on Waste Electric and Electronic Equipment (WEEE)

This document contains important information for users with regards to the proper disposal and recycling of Jetlun products. Consumers are required to comply with this notice for all electronic products bearing the following symbol:



Български (Bulgarian) - Информация относно опазването на околната среда за потребители в Европейския съюз

Европейска директива 2002/96/ЕС изисква уредите, носещи този символ върху изделието и/или опаковката му, да не се изхвърлят с несортирани битови отпадъци. Символът обозначава, че изделието трябва да се изхвърля отделно от сметосъбирането на обикновените битови отпадъци. Ваша е отговорността този и другите електрически и електронни уреди да се изхвърлят в предварително определени от държавните или общински органи специализирани пунктове за събиране. Правилното изхвърляне и рециклиране ще спомогнат да се предотвратят евентуални вредни за околната среда и здравето на населението последици. За по-подробна информация относно изхвърлянето на вашите стари уреди се обърнете към местните власти, службите за сметосъбиране или магазина, от който сте закупили уреда.

Ceština (Czech) - Informace o ochraně životního prostředí pro zákazníky v zemích Evropské unie

Evropská směrnice 2002/96/ES zakazuje, aby zařízení označené tímto symbolem na produktu anebo na obalu bylo likvidováno s neřádným komunálním odpadem. Tento symbol udává, že daný produkt musí být likvidován odděleně od běžného komunálního odpadu. Odpovídáte za likvidaci tohoto produktu a dalších elektrických a elektronických zařízení prostřednictvím určených sběrných míst stanovených vládou nebo místními úřady. Správná likvidace a recyklace pomáhá předcházet potenciálním negativním dopadům na životní prostředí a lidské zdraví. Podrobnější informace o likvidaci starého vybavení si laskavě vyžádejte od místních úřadů, podniku zabývajícího se likvidací komunálních odpadů nebo obchodu, kde jste produkt zakoupili.

Dansk (Danish) - Miljøinformation for kunder i EU

EU-direktiv 2002/96/EF kræver, at udstyr der bærer dette symbol på produktet og/eller emballagen ikke må bortskaffes som usorteret kommunalt affald. Symbolet betyder, at dette produkt skal bortskaffes adskilt fra det almindelige husholdningsaffald. Det er dit ansvar at bortskaffe dette og andet elektrisk og elektronisk udstyr via bestemte

indsamlingssteder udpeget af staten eller de lokale myndigheder. Korrekt bortskaffelse og genvinding vil hjælpe med til at undgå mulige skader for miljøet og menneskers sundhed. Kontakt venligst de lokale myndigheder, renovationstjenesten eller den butik, hvor du har købt produktet, angående mere detaljeret information om bortskaffelse af dit gamle udstyr.

Deutsch (German) - Umweltinformation für Kunden innerhalb der Europäischen Union

Die Europäische Richtlinie 2002/96/EC verlangt, dass technische Ausrüstung, die direkt am Gerät und/oder an der Verpackung mit diesem Symbol versehen ist, nicht zusammen mit unsortiertem Gemeindeabfall entsorgt werden darf. Das Symbol weist darauf hin, dass das Produkt von regulärem Haushaltsmüll getrennt entsorgt werden sollte. Es liegt in Ihrer Verantwortung, dieses Gerät und andere elektrische und elektronische Geräte über die dafür zuständigen und von der Regierung oder örtlichen Behörden dazu bestimmten Sammelstellen zu entsorgen. Ordnungsgemäßes Entsorgen und Recyceln trägt dazu bei, potentielle negative Folgen für Umwelt und die menschliche Gesundheit zu vermeiden. Wenn Sie weitere Informationen zur Entsorgung Ihrer Altgeräte benötigen, wenden Sie sich bitte an die örtlichen Behörden oder städtischen Entsorgungsdienste oder an den Händler, bei dem Sie das Produkt erworben haben.

English - Environmental Information for Customers in the European Union

European Directive 2002/96/EC requires that the equipment bearing this symbol on the product and/or its packaging must not be disposed of with unsorted municipal waste. The symbol indicates that this product should be disposed of separately from regular household waste streams. It is your responsibility to dispose of this and other electric and electronic equipment via designated collection facilities appointed by the government or local authorities. Correct disposal and recycling will help prevent potential negative consequences to the environment and human health. For more detailed information about the disposal of your old equipment, please contact your local authorities, waste disposal service, or the shop where you purchased the product.

Eesti (Estonian) - Keskkonnaalane informatsioon Euroopa Liidus asuvatele klientidele

Euroopa Liidu direktiivi 2002/96/EÜ nõuete kohaselt on seadmeid, millel on tootel või pakendil käesolev sümbol, keelatud kõrvaldada koos sorteerimata olmejäätmetega. See sümbol näitab, et toode tuleks kõrvaldada eraldi tavalistest olmejäätmevoogudest. Olete kohustatud kõrvaldama käesoleva ja ka muud elektri- ja elektroonikaseadmed riigi või kohalike ametiasutuste poolt ette nähtud kogumispunktide kaudu. Seadmete korrektna kõrvaldamine ja ringlussevõtt aitab vältida võimalikke negatiivseid tagajärgi keskkonnale ning inimeste tervisele. Vanade seadmete kõrvaldamise kohta täpsema informatsiooni saamiseks võtke palun ühendust kohalike ametiasutustega, jäätmekäitlusfirmaga või kauplusega, kust te toote ostsite.

Español (Spanish) - Información medioambiental para clientes de la Unión Europea

La Directiva 2002/96/CE de la UE exige que los equipos que lleven este símbolo en el propio aparato y/o en su embalaje no deben eliminarse junto con otros residuos urbanos

no seleccionados. El símbolo indica que el producto en cuestión debe separarse de los residuos domésticos convencionales con vistas a su eliminación. Es responsabilidad suya desechar este y cualesquiera otros aparatos eléctricos y electrónicos a través de los puntos de recogida que ponen a su disposición el gobierno y las autoridades locales. Al desechar y reciclar correctamente estos aparatos estará contribuyendo a evitar posibles consecuencias negativas para el medio ambiente y la salud de las personas. Si desea obtener información más detallada sobre la eliminación segura de su aparato usado, consulte a las autoridades locales, al servicio de recogida y eliminación de residuos de su zona o pregunte en la tienda donde adquirió el producto.

Ξλληνικά (Greek) - Στοιχεία περιβαλλοντικής προστασίας για πελάτες εντός της Ευρωπαϊκής Ένωσης

Η Κοινοτική Οδηγία 2002/96/EC απαιτεί ότι ο εξοπλισμός ο οποίος φέρει αυτό το σύμβολο στο προϊόν και/ή στη συσκευασία του δεν πρέπει να απορρίπτεται μαζί με τα μικτά κοινοτικά απορρίμματα. Το σύμβολο υποδεικνύει ότι αυτό το προϊόν θα πρέπει να απορρίπτεται ξεχωριστά από τα συνήθη οικιακά απορρίμματα. Είστε υπεύθυνος για την απόρριψη του παρόντος και άλλου ηλεκτρικού και ηλεκτρονικού εξοπλισμού μέσω των καθορισμένων εγκαταστάσεων συγκέντρωσης απορριμμάτων οι οποίες παρέχονται από το κράτος ή τις αρμόδιες τοπικές αρχές. Η σωστή απόρριψη και ανακύκλωση συμβάλλει στην πρόληψη πιθανών αρνητικών συνεπειών για το περιβάλλον και την υγεία. Για περισσότερες πληροφορίες σχετικά με την απόρριψη του παλιού σας εξοπλισμού, παρακαλώ επικοινωνήστε με τις τοπικές αρχές, τις υπηρεσίες απόρριψης ή το κατάστημα από το οποίο αγοράσατε το προϊόν.

Français (French) - Informations environnementales pour les clients de l'Union européenne

La directive européenne 2002/96/CE exige que l'équipement sur lequel est apposé ce symbole sur le produit et/ou son emballage ne soit pas jeté avec les autres ordures ménagères. Ce symbole indique que le produit doit être éliminé dans un circuit distinct de celui pour les déchets des ménages. Il est de votre responsabilité de jeter ce matériel ainsi que tout autre matériel électrique ou électronique par les moyens de collecte indiqués par le gouvernement et les pouvoirs publics des collectivités territoriales. L'élimination et le recyclage en bonne et due forme ont pour but de lutter contre l'impact néfaste potentiel de ce type de produits sur l'environnement et la santé publique. Pour plus d'informations sur le mode d'élimination de votre ancien équipement, veuillez prendre contact avec les pouvoirs publics locaux, le service de traitement des déchets, ou l'endroit où vous avez acheté le produit.

Italiano (Italian) - Informazioni relative all'ambiente per i clienti residenti nell'Unione Europea

La direttiva europea 2002/96/EC richiede che le apparecchiature contrassegnate con questo simbolo sul prodotto e/o sull'imballaggio non siano smaltite insieme ai rifiuti urbani non differenziati. Il simbolo indica che questo prodotto non deve essere smaltito insieme ai normali rifiuti domestici. È responsabilità del proprietario smaltire sia questi prodotti sia le altre apparecchiature elettriche ed elettroniche mediante le specifiche

strutture di raccolta indicate dal governo o dagli enti pubblici locali. Il corretto smaltimento ed il riciclaggio aiuteranno a prevenire conseguenze potenzialmente negative per l'ambiente e per la salute dell'essere umano. Per ricevere informazioni più dettagliate circa lo smaltimento delle vecchie apparecchiature in Vostro possesso, Vi invitiamo a contattare gli enti pubblici di competenza, il servizio di smaltimento rifiuti o il negozio nel quale avete acquistato il prodotto.

Latviešu valoda (Latvian) - Ekoloģiska informācija klientiem Eiropas Savienības jurisdikcijā

Direktīvā 2002/96/EK ir prasība, ka aprīkojumu, kam pievienota zīme uz paša izstrādājuma vai uz tā iesaiņojuma, nedrīkst izmest nešķīrotā veidā kopā ar komunālajiem atkritumiem (tiem, ko rada vietēji iedzīvotāji un uzņēmumi). Šī zīme nozīmē to, ka šī ierīce ir jāizmet atkritumos tā, lai tā nenonāktu kopā ar parastiem mājsaimniecības atkritumiem. Jūsu pienākums ir šo un citas elektriskas un elektroniskas ierīces izmest atkritumos, izmantojot īpašus atkritumu savākšanas veidus un līdzekļus, ko nodrošina valsts un pašvaldību iestādes. Ja izmešana atkritumos un pārstrāde tiek veikta pareizi, tad mazinās iespējamais kaitējums dabai un cilvēku veselībai. Sīkākas ziņas par novecojuša aprīkojuma izmešanu atkritumos jūs varat saņemt vietējā pašvaldībā, atkritumu savākšanas dienestā, kā arī veikalā, kur iegādājāties šo izstrādājumu.

Lietuvškai (Lithuanian) - Aplinkosaugos informacija, skirta Europos Sąjungos vartotojams

Europos direktyva 2002/96/EC numato, kad įrangos, kuri ir kurios pakuotė yra pažymėta šiuo simboliu (įveskite simbolį), negalima šalinti kartu su nerūšiuotomis komunalinėmis atliekomis. Šis simbolis rodo, kad gaminį reikia šalinti atskirai nuo bendro buitinių atliekų srauto. Jūs privalote užtikrinti, kad ši ir kita elektros ar elektroninė įranga būtų šalinama per tam tikras nacionalinės ar vietinės valdžios nustatytas atliekų rinkimo sistemas. Tinkamai šalinant ir perdirbant atliekas, bus išvengta galimos žalos aplinkai ir žmonių sveikatai. Daugiau informacijos apie jūsų senos įrangos šalinimą gali pateikti vietinės valdžios institucijos, atliekų šalinimo tarnybos arba parduotuvės, kuriose įsigijote tą gaminį.

Malti (Maltese) - Informazzjoni Ambjentali għal Kliġenti fl-Unjoni Ewropea

Id-Direttiva Ewropea 2002/96/KE titlob li t-tagħmir li jkun fih issimbolu fuq il-prodott u/jew fuq l-ippakkjar ma jistax jintrema ma' skart municipali li ma ġiex isseparat. Is-simbolu jindika li dan il-prodott għandu jintrema separatament minn ma' liskart domestiku regolari. Hija responsabbiltà tiegħek li tarmi dan it-tagħmir u kull tagħmir iehor ta' l-elettriku u elettroniku permezz ta' faċilitajiet ta' ġbir appuntati apposta mill-gvern jew mill-awtoritajiet lokali. Ir-rimi b'mod korrett u r-riċiklaġġ għin jipprevjeni konsegwenzi negattivi potenzjali għall-ambjent u għas-saħħa tal-bniedem. Għal aktar informazzjoni dettaljata dwar ir-rimi tat-tagħmir antik tiegħek, jekk jogħġbok ikkuntattja lill-awtoritajiet lokali tiegħek, is-servizzi għar-rimi ta' l-iskart, jew il-ħanut minn fejn xtrajt il-prodott.

Magyar (Hungarian) - Környezetvédelmi információ az európai uniós vásárlók

számára

A 2002/96/EC számú európai uniós irányelv megkívánja, hogy azokat a termékeket, amelyeken, és/vagy amelyek csomagolásán az alábbi címke megjelenik, tilos a többi szelektálatlan lakossági hulladékkal együtt kidobni. A címke azt jelöli, hogy az adott termék kidobásakor a szokványos háztartási hulladékelszállítási rendszerektől elkülönített eljárást kell alkalmazni. Az Ön felelőssége, hogy ezt, és más elektromos és elektronikus berendezéseit a kormányzati vagy a helyi hatóságok által kijelölt gyűjtőrendszeren keresztül számolja fel. A megfelelő hulladékfeldolgozás segít a környezetre és az emberi egészségre potenciálisan ártalmas negatív hatások megelőzésében. Ha elavult berendezéseinek felszámolásához további részletes információra van szüksége, kérjük, lépjen kapcsolatba a helyi hatóságokkal, a hulladékfeldolgozási szolgálattal, vagy azzal üzlettel, ahol a terméket vásárolta.

Nederlands (Dutch) - Milieu-informatie voor klanten in de Europese Unie

De Europese Richtlijn 2002/96/EC schrijft voor dat apparatuur die is voorzien van dit symbool op het product of de verpakking, niet mag worden ingezameld met niet-gescheiden huishoudelijk afval. Dit symbool geeft aan dat het product apart moet worden ingezameld. U bent zelf verantwoordelijk voor de vernietiging van deze en andere elektrische en elektronische apparatuur via de daarvoor door de landelijke of plaatselijke overheid aangewezen inzamelingskanalen. De juiste vernietiging en recycling van deze apparatuur voorkomt mogelijke negatieve gevolgen voor het milieu en de gezondheid. Voor meer informatie over het vernietigen van uw oude apparatuur neemt u contact op met de plaatselijke autoriteiten of afvalverwerkingsdienst, of met de winkel waar u het product hebt aangeschaft.

Norsk (Norwegian) - Miljøinformasjon for kunder i EU

EU-direktiv 2002/96/EF krever at utstyr med følgende symbol avbildet på produktet og/eller pakningen, ikke må kastes sammen med usortert avfall. Symbolet indikerer at dette produktet skal håndteres atskilt fra ordinær avfallsinnsamling for husholdningsavfall. Det er ditt ansvar å kvitte deg med dette produktet og annet elektrisk og elektronisk avfall via egne innsamlingsordninger slik myndighetene eller kommunene bestemmer. Korrekt avfallshåndtering og gjenvinning vil være med på å forhindre mulige negative konsekvenser for miljø og helse. For nærmere informasjon om håndtering av det kasserte utstyret ditt, kan du ta kontakt med kommunen, en innsamlingsstasjon for avfall eller butikken der du kjøpte produktet.

Polski (Polish) - Informacja dla klientów w Unii Europejskiej o przepisach dotyczących ochrony środowiska

Dyrektywa Europejska 2002/96/EC wymaga, aby sprzęt oznaczony symbolem znajdującym się na produkcie i/lub jego opakowaniu nie był wyrzucany razem z innymi niesortowanymi odpadami komunalnymi. Symbol ten wskazuje, że produkt nie powinien być usuwany razem ze zwykłymi odpadami z gospodarstw domowych. Na Państwu spoczywa obowiązek wyrzucania tego i innych urządzeń elektrycznych oraz elektronicznych w punktach odbioru wyznaczonych przez władze krajowe lub lokalne.

Pozbywanie się sprzętu we właściwy sposób i jego recykling pomogą zapobiec potencjalnie negatywnym konsekwencjom dla środowiska i zdrowia ludzkiego. W celu uzyskania szczegółowych informacji o usuwaniu starego sprzętu, prosimy zwrócić się do lokalnych władz, służb oczyszczania miasta lub sklepu, w którym produkt został nabyty.

Português (Portuguese) - Informação ambiental para clientes da União Europeia

A Directiva Europeia 2002/96/CE exige que o equipamento que exhibe este símbolo no produto e/ou na sua embalagem não seja eliminado junto com os resíduos municipais não separados. O símbolo indica que este produto deve ser eliminado separadamente dos resíduos domésticos regulares. É da sua responsabilidade eliminar este e qualquer outro equipamento eléctrico e electrónico através das instalações de recolha designadas pelas autoridades governamentais ou locais. A eliminação e reciclagem correctas ajudarão a prevenir as consequências negativas para o ambiente e para a saúde humana. Para obter informações mais detalhadas sobre a forma de eliminar o seu equipamento antigo, contacte as autoridades locais, os serviços de eliminação de resíduos ou o estabelecimento comercial onde adquiriu o produto.

Română (Romanian) - Informații de mediu pentru clienții din Uniunea Europeană

Directiva europeană 2002/96/CE impune ca echipamentele care prezintă acest simbol pe produs și/sau pe ambalajul acestuia să nu fie casate împreună cu gunoiul menajer municipal. Simbolul indică faptul că acest produs trebuie să fie casat separat de gunoiul menajer obișnuit. Este responsabilitatea dvs. să cașati acest produs și alte echipamente electrice și electronice prin intermediul unităților de colectare special desemnate de guvern sau de autoritățile locale. Casarea și reciclarea corecte vor ajuta la prevenirea potențialelor consecințe negative asupra sănătății mediului și a oamenilor. Pentru mai multe informații detaliate cu privire la casarea acestui echipament vechi, contactați autoritățile locale, serviciul de salubritate sau magazinul de la care ați achiziționat produsul.

Slovenčina (Slovak) - Informácie o ochrane životného prostredia pre zákazníkov v Európskej únii

Podľa európskej smernice 2002/96/ES zariadenie s týmto symbolom na produkte a/alebo jeho balení nesmie byť likvidované spolu s netriedeným komunálnym odpadom. Symbol znamená, že produkt by sa mal likvidovať oddelene od bežného odpadu z domácností. Je vašou povinnosťou likvidovať toto i ostatné elektrické a elektronické zariadenia prostredníctvom špecializovaných zberných zariadení určených vládou alebo miestnymi orgánmi. Správna likvidácia a recyklácia pomôže zabrániť priľpadným negatívnym dopadom na životné prostredie a zdravie ľudí. Ak máte záujem o podrobnejšie informácie o likvidácii starého zariadenia, obráťte sa, prosím, na miestne orgány, organizácie zaoberajúce sa likvidáciou odpadov alebo obchod, v ktorom ste si produkt zakúpili.

Slovenčina (Slovene) - Okoljske informacije za stranke v Evropski uniji

Evropska direktiva 2002/96/EC prepoveduje odlaganje opreme, označene s tem

simbolom – na izdelku in/ali na embalaži – med običajne, nerazvrščene odpadke. Ta simbol opozarja, da je treba izdelek odvreči ločeno od preostalih gospodinjskih odpadkov. Vaša odgovornost je, da to in preostalo električno in elektronsko opremo odnesete na posebna zbirališča, ki jih določijo državne ustanove ali lokalna uprava. S pravilnim odlaganjem in recikliranjem boste preprečili morebitne škodljive vplive na okolje in zdravje ljudi. Če želite izvedeti več o odlaganju stare opreme, se obrnite na lokalno upravo, odpad ali trgovino, kjer ste izdelek kupili.

Suomi (Finnish) - Ympäristöä koskevia tietoja EUalueen asiakkaille

EU-direktiivi 2002/96/EY edellyttää, että jos laitteistossa on tämä symboli itse tuotteessa ja/tai sen pakkauksessa, laitteistoa ei saa hävittää lajittelemattoman yhdyskuntajätteen mukana. Symboli merkitsee sitä, että tämä tuote on hävitettävä erillään tavallisesta kotitalousjätteestä. Sinun vastuullasi on hävittää tämä elektroniikkatuote ja muut vastaavat elektroniikkatuotteet viemällä tuote tai tuotteet viranomaisten määräämään keräyspisteeseen. Laitteiston oikea hävittäminen estää mahdolliset kielteiset vaikutukset ympäristöön ja ihmisten terveyteen. Lisätietoja vanhan laitteiston oikeasta hävitystavasta saa paikallisilta viranomaisilta, jätteenhävityspalvelusta tai siitä myymälästä, josta ostit tuotteen.

Svenska (Swedish) - Miljöinformation för kunder i Europeiska unionen

Det europeiska direktivet 2002/96/EC kräver att utrustning med denna symbol på produkten och/eller förpackningen inte får kastas med osorterat kommunalt avfall. Symbolen visar att denna produkt bör kastas efter att den avskiljts från vanligt hushållsavfall. Det faller på ditt ansvar att kasta denna och annan elektrisk och elektronisk utrustning på fastställda insamlingsplatser utsedda av regeringen eller lokala myndigheter. Korrekt kassering och återvinning skyddar mot eventuella negativa konsekvenser för miljön och personhälsa. För mer detaljerad information om kassering av din gamla utrustning kontaktar du dina lokala myndigheter, avfallshantering eller butiken där du köpte produkten.

5.4 Legal Notices

5.4.1 Software License Terms and Conditions

ONLY OPEN THE PACKAGE, OR USE THE SOFTWARE AND RELATED PRODUCT IF YOU ACCEPT THE TERMS OF THIS LICENSE. BY BREAKING THE SEAL ON THIS DISK KIT /CDROM, OR IF YOU USE THE SOFTWARE OR RELATED PRODUCT, YOU ACCEPT THE TERMS OF THIS LICENSE AGREEMENT. IF YOU DO NOT AGREE TO THESE TERMS, DO NOT USE THE SOFTWARE OR RELATED PRODUCT; INSTEAD, RETURN THE SOFTWARE TO PLACE OF PURCHASE FOR A FULL REFUND. THE FOLLOWING AGREEMENT IS A LEGAL AGREEMENT BETWEEN YOU (EITHER AN INDIVIDUAL OR ENTITY), AND JETLUN CORPORATION (FOR ITSELF AND ITS LICENSORS). THE RIGHT TO USE THIS PRODUCT IS LICENSED ONLY ON THE CONDITION THAT YOU AGREE TO THE FOLLOWING TERMS.

Now, therefore, in consideration of the promises and mutual obligations contained

herein, and for other good and valuable consideration, the receipt and sufficiency of which are hereby mutually acknowledged, you and Jetlun agree as follows:

Grant of License. Subject to the following terms and conditions, Jetlun Corporation, grants to you a personal, revocable, non-assignable, non-transferable, non-exclusive and limited license to use on a single piece of equipment only one copy of the software contained on this disk (which may have been pre-loaded on the equipment)(Software). You may make two copies of the Software, but only for backup, archival, or disaster recovery purposes. On any copy you make of the Software, you must reproduce and include the copyright and other proprietary rights notice contained on the copy we have furnished you of the Software.

Ownership. Jetlun retains all title, ownership and intellectual property rights to the Software and any copies, including translations, compilations, derivative works (including images) partial copies and portions of updated works. The Software is Jetlun's confidential proprietary information. This Software License Agreement does not convey to you any interest in or to the Software, but only a limited right of use. You agree not to disclose it or make it available to anyone without Jetlun's written authorization. You will exercise no less than reasonable care to protect the Software from unauthorized disclosure. You agree not to disassemble, decompile or reverse engineer, or create derivative works of the Software, except and only to the extent that such activity is expressly permitted by applicable law.

Termination. This License is effective until terminated. This License will terminate immediately without notice from Jetlun or judicial resolution if you fail to comply with any provision of this License. Upon such termination you must destroy the Software, all accompanying written materials and all copies thereof, and the sections entitled Limited Warranty, Limitation of Remedies and Damages, and General will survive any termination.

Limited Warranty. Jetlun warrants for a period of ninety (90) days from Jetlun's shipment of the Software to you that (i) the disk(s) on which the Software is recorded will be free from defects in materials and workmanship under normal use and (ii) the Software, under normal use, will perform substantially in accordance with Jetlun's published specifications for that release level of the Software. The written materials are provided "AS IS" and without warranty of any kind. Jetlun's entire liability and your sole and exclusive remedy for any breach of the foregoing limited warranty will be, at Jetlun's option, replacement of the disk(s), provision of downloadable patch or replacement code, or refund of the unused portion of your bargained for contractual benefit up to the amount paid for this Software License.

THIS LIMITED WARRANTY IS THE ONLY WARRANTY PROVIDED BY JETLUN, AND ITS LICENSORS EXPRESSLY DISCLAIM ALL OTHER WARRANTIES, EITHER EXPRESS OF IMPLIED, INCLUDING BUT NOT LIMITED TO IMPLIED WARRANTIES OF MERCHANTABILITY AND FITNESS FOR A PARTICULAR PURPOSE AND NONINFRINGEMENT. JETLUN DOES NOT WARRANT THAT THE OPERATION OF THE SOFTWARE WILL BE UNINTERRUPTED OR ERROR-FREE, OR THAT DEFECTS IN THE SOFTWARE WILL BE CORRECTED. NO ORAL OR WRITTEN

REPRESENTATIONS MADE BY MOTOROLA OR AN AGENT THEREOF SHALL CREATE A WARRANTY OR IN ANY WAY INCREASE THE SCOPE OF THIS WARRANTY. JETLUN DOES NOT WARRANT ANY SOFTWARE THAT HAS BEEN OPERATED IN EXCESS OF SPECIFICATIONS, DAMAGED, MISUSED, NEGLECTED, OR IMPROPERLY INSTALLED. BECAUSE SOME JURISDICTIONS DO NOT ALLOW THE EXCLUSION OR LIMITATION OF IMPLIED WARRANTIES, THE ABOVE LIMITATIONS MAY NOT APPLY TO YOU.

Limitation of Remedies and Damages. Regardless of whether any remedy set forth herein fails of its essential purpose, IN NO EVENT SHALL JETLUN OR ANY OF THE LICENSORS, DIRECTORS, OFFICERS, EMPLOYEES OR AFFILIATES OF THE FOREGOING BE LIABLE TO YOU FOR ANY CONSEQUENTIAL, INCIDENTAL, INDIRECT, SPECIAL OR SIMILAR DAMAGES WHATSOEVER (including, without limitation, damages for loss of business profits, business interruption, loss of business information and the like), whether foreseeable or unforeseeable, arising out of the use or inability to use the Software or accompanying written materials, regardless of the basis of the claim and even if Motorola or a Motorola representative has been advised of the possibility of such damage. Motorola's liability to you for direct damages for any cause whatsoever, regardless of the basis of the form of the action, will be limited to the price paid for the Software that caused the damages. THIS LIMITATION WILL NOT APPLY IN CASE OF PERSONAL INJURY ONLY WHERE AND TO THE EXTENT THAT APPLICABLE LAW REQUIRES SUCH LIABILITY. BECAUSE SOME JURISDICTIONS DO NOT ALLOW THE EXCLUSION OR LIMITATION OF LIABILITY FOR CONSEQUENTIAL OR INCIDENTAL DAMAGES, THE ABOVE LIMITATION MAY NOT APPLY TO YOU.

Maintenance and Support. Jetlun shall not be responsible for maintenance or support of the software. By accepting the license granted under this agreement, you agree that Jetlun will be under no obligation to provide any support, maintenance or service in connection with the Software or any application developed by you. Any maintenance and support of the Related Product will be provided under the terms of the agreement for the Related Product.

Transfer. In the case of software designed to operate on Jetlun equipment, you may not transfer the Software to another party except: (1) if you are an end-user, when you are transferring the Software together with the Jetlun equipment on which it operates; or 2) if you are a Jetlun licensed distributor, when you are transferring the Software either together with such Jetlun equipment or are transferring the Software as a licensed duly paid for upgrade, update, patch, new release, enhancement or replacement of a prior version of the Software. If you are a Jetlun licensed distributor, when you are transferring the Software as permitted herein, you agree to transfer the Software with a license agreement having terms and conditions no less restrictive than those contained herein. You may transfer all other Software, not otherwise having an agreed restriction on transfer, to another party. However, all such transfers of Software are strictly subject to the conditions precedent that the other party agrees to accept the terms and conditions of this License, and you destroy any copy of the Software you do not transfer to that party. You may not sublicense or otherwise transfer, rent or lease the Software without our written consent. You may not transfer the Software in violation of any laws,

regulations, export controls or economic sanctions imposed by the US Government.

Right to Audit. Jetlun shall have the right to audit annually, upon reasonable advance notice and during normal business hours, your records and accounts to determine compliance with the terms of this Agreement.

Export Controls. You specifically acknowledge that the software may be subject to United States and other country export control laws. You shall comply strictly with all requirements of all applicable export control laws and regulations with respect to all such software and materials.

US Government Users. If you are a US Government user, then the Software is provided with "RESTRICTED RIGHTS" as set forth in subparagraphs (c)(1) and (2) of the Commercial Computer Software-Restricted Rights clause at FAR 52 227-19 or subparagraph (c)(1)(ii) of the Rights in Technical Data and Computer Software clause at DFARS 252.227-7013, as applicable.

Disputes. You and Jetlun hereby agree that any dispute, controversy or claim, except for any dispute, controversy or claim involving intellectual property, prior to initiation of any formal legal process, will be submitted for non-binding mediation, prior to initiation of any formal legal process. Cost of mediation will be shared equally. Nothing in this Section will prevent either party from resorting to judicial proceedings, if (i) good faith efforts to resolve the dispute under these procedures have been unsuccessful, (ii) the dispute, claim or controversy involves intellectual property, or (iii) interim relief from a court is necessary to prevent serious and irreparable injury to that party or to others.

General. California law governs this license. The terms of this license are supplemental to any written agreement executed by both parties regarding this subject and the Software Jetlun is to license you under it, and supersedes all previous oral or written communications between us regarding the subject except for such executed agreement. It may not be modified or waived except in writing and signed by an officer or other authorized representative of each party. If any provision is held invalid, all other provisions shall remain valid, unless such invalidity would frustrate the purpose of our agreement. The failure of either party to enforce any rights granted hereunder or to take action against the other party in the event of any breach hereunder shall not be deemed a waiver by that party as to subsequent enforcement of rights or subsequent action in the event of future breaches.

5.4.2 Hardware Warranty in U.S.

Jetlun offers a warranty covering a period of one year from the date of purchase by the customer. If a product is found defective during the warranty period, Jetlun will repair or replace the product with the same or a similar model, which may be a reconditioned unit, without charge for parts or labor.

5.4.3 Limit of Liability

IN NO EVENT SHALL JETLUN BE LIABLE TO YOU OR ANY OTHER PARTY FOR ANY DIRECT, INDIRECT, GENERAL, SPECIAL, INCIDENTAL, CONSEQUENTIAL, EXEMPLARY OR OTHER DAMAGE ARISING OUT OF THE USE OR INABILITY TO USE THE PRODUCT (INCLUDING, WITHOUT LIMITATION, DAMAGES FOR LOSS OF BUSINESS PROFITS, BUSINESS INTERRUPTION, LOSS OF BUSINESS INFORMATION OR ANY OTHER PECUNIARY LOSS, OR FROM ANY BREACH OF WARRANTY, EVEN IF JETLUN HAS BEEN ADVISED OF THE POSSIBILITY OF SUCH DAMAGES. (Some states do not allow the exclusion or limitation of incidental or consequential damages, so the above exclusion or limitation may not apply to you.) IN NO CASE SHALL JETLUN'S LIABILITY EXCEED THE AMOUNT YOU PAID FOR THE PRODUCT.

6.0 TECHNICAL SPECIFICATIONS

Part Number	Type A (US) Plug: RD75606A Type C (EU) Plug: RD75606C Type G (UK) Plug: RD75606G Type I (AU) Plug: RD75606I
Product Name	Jetlun Gateway
Description	An integrated HomePlug and Zigbee energy management controller
Standard Compliance	IEEE 802.3 Zigbee SE/HA HomePlug Command and Control (HPCC) HomePlug AV (HPAV)
Interface	4-port Ethernet Switch
Frequency Band	Zigbee: 2.4 GHz HPCC: US/Japan 100-400 kHz (FCC/ARIB) EU Outdoor 18-19 kHz (CENELEC A) EU Outdoor 70-95 kHz (CENELEC A+) EU Indoor 95-125 kHz (CENELEC B) HPAV: 1-30 MHz
Transport Mode	Zigbee: Up to 206 kbps HPCC: Up to 7.5 kbps HPAV: Up to 200 mbps
Range	Zigbee: Up to 100 ft (30 m) HPCC: Up to 1,800 ft (600 m) HPAV: Up to 1,000 ft (300 m)
Zigbee Antenna	Rx: -99dBm (normal mode), -100dBm (burst mode) Tx: -32dBm to +3dBm (normal mode), -23dBm to +5dBm (burst mode)
Modulation	HPCC: Differential Code Shift Keying (DCSK) HPAV: Orthogonal Frequency Division Multiplexing (OFDM)
Security	128-bit AES Encryption
LEDs	Power, Zigbee Link/ Activity, Zigbee Security Link, HPCC Link/ Activity, HPAV Link/ Activity, 4-Ethernet Link/ Activity, 1-SD card Link,
Accuracy	+/- 1.0%
Operating Temp	-32°F to 113°F (0°C to 45°C)
Operating Humidity	10 to 85% non-condensing
Storage Temp	-4°F to 158°F (-20°C to 70°C)
Storage Humidity	5 to 90% non-condensing
Dimensions	160 x 185 x 56 (LxWxH)
Weight	0.85 kg (1.8 lbs)
Operating Voltage	100-240 VAC, 50-60 Hz
Consumption	Maximum 6W
Safety and EMI	FCC/UL/cUL/CE pending
WEEE	RoHS Compliant

Glossary

HomePlug Command and Control ("HPCC") is a one of the three published standards from the HomePlug Powerline Alliance. HPCC is a low speed, low powered, highly robust powerline carrier technologies ideal for remote monitoring and control that delivers convenience through remote accessibility; safety and security products that protect from fire, theft and natural hazards; power management solutions that save money and conserve energy; and healthcare monitoring solutions that save lives and bring peace of mind. For more information, visit www.homeplug.org. 7

Zigbee is a low-speed, low powered 802.15.4 wireless mesh standard established by the Zigbee Alliance. The Zigbee Alliance is a non-profit Standard organization made up 300+ companies driving development of ZigBee wireless technology. For more information, visit www.zigbee.org. Zigbee is the only wireless technology standard that has been listed under NIST as 1 of the 13 Smart Grid interoperability standards. For more information about NIST, please visit www.nist.gov. 7, 21, 22

Notes



Jetlun Corporation
88 Parkgrove Drive
So San Francisco CA 94080 USA
www.jetlun.com
sales@jetlun.com
866-498-2703