



User Manual DL-210 Label & Barcode Printer



Important Safety Instructions (English)

Read the following instructions thoroughly before starting up your printer.

- The device and mains-socket must all times be easily accessible.
- Never carry out maintenance or repair work yourself. Always contact a qualified service technician.
- Keep this user guide in a place which is easily accessible at all times.
- Place the printer on a solid and even base so that it cannot fall.
- Never place the printer in the vicinity of inflammable gas or explosive substances.
- Ensure the printer is connected to a socket with the correct voltage.
- Always disconnect the printer from the power before opening the device to perform maintenance work or remedy errors.
- Do not expose the printer to high temperatures, direct sunlight or dust.
- Keep all liquids away from the printer.
- Protect the printer from shock, impact and vibration.
- Make sure that both the printer and the computer is switched off before connecting the data cable.
- The print head will become very hot during printing; avoid contact with the print head after printing has finished.
- Do not perform any operation or action in any way other than those provided in this manual. When in doubt, contact your dealer or your customer support.

Wichtige Sicherheitshinweise (German)

Lesen Sie bitte diese Sicherheitshinweise durch, bevor Sie den Drucker in Betrieb nehmen.

- Das Gerät und die Netzsteckdose müssen jeder Zeit leicht zugänglich sein.
- Führen Sie Wartungsarbeiten und Reparaturen keinesfalls selbst aus, sondern verständigen Sie immer einen qualifizierten Servicetechniker.
- Bewahren Sie diese Dokumentation an einem jederzeit zugänglichen Ort auf.
- Den Drucker auf stabilem und ebenem Untergrund so aufstellen, dass er nicht zu Boden fallen kann.
- Stellen Sie den Drucker keinesfalls in der Nähe von leicht entzündlichen Gasen oder explosiven Stoffen auf.
- Den Drucker nur an eine Steckdose mit der richtigen Spannung anschließen.
- Wenn Sie den Drucker vom Netz trennen wollen, den Drucker ausschalten und immer den Netzstecker an der Steckdose ziehen.
- Den Drucker weder hohen Temperaturen noch direktem Sonnenlicht und Staub aussetzen.
- Keine Flüssigkeiten mit dem Drucker in Berührung bringen.
- Den Drucker keinen Erschütterungen, Stößen oder Vibrationen aussetzen.
- Sicherstellen, dass der Drucker und der Computer ausgeschaltet sind, bevor das Datenkabel angeschlossen wird.
- Der Druckkopf wird während des Druckens heiß. Vor dem Berühren deshalb einige Zeit abkühlen lassen.
- Weichen Sie bei der Bedienung des Druckers nicht von den Anweisungen in der Dokumentation ab. Bei Unklarheiten wenden Sie sich bitte an Ihren Händler oder Ihren Kundendienst.

Consignes importantes de sécurité (French)

Lire attentivement les instructions suivantes avant de mettre l'imprimante en service.

- Le dispositif et la prise principale doivent toujours être accessibles facilement.
- Ne jamais effectuer soi-même les travaux d'entretien et de réparations. Contacter toujours un dépanneur qualifié.
- Placer l'imprimante sur un support stable de façon à ce qu'elle ne puisse pas tomber.
- Ne jamais placer l'imprimante à proximité de sources de gaz aisément inflammables ou de substances explosives.
- Ne connecter l'imprimante à une prise que lorsque la tension est correcte.
- Pour déconnecter l'imprimante de l'alimentation principale, mettre l'imprimante hors tension et toujours débrancher le connecteur secteur de la prise murale.
- Ne pas exposer l'imprimante à des températures élevées, à la lumière directe du soleil ou à la poussière.
- Ne pas mettre l'imprimante en contact avec des liquides.
- Ne pas exposer l'imprimante à des chocs, impacts ou vibrations.
- S'assurer que l'imprimante et l'ordinateur sont hors tension avant de connecter le câble de données.
- La tête d'impression est brûlante pendant l'impression. C'est pourquoi laissez-la refroidir quelques instants avant d'y toucher.
- N'exécutez aucune opération ni action d'une autre manière que celle indiquée dans ce manuel. En cas de doute, veuillez contacter votre distributeur ou service après-vente.

Indicazioni di sicurezza importanti (Italian)

Prima di mettere in funzione la stampante, leggere attentamente le seguenti indicazioni.

- Il dispositivo e la presa di corrente devono essere sempre facilmente accessibili.
- Non eseguire mai da sé gli interventi di manutenzione e riparazione, ma rivolgersi sempre a un tecnico di assistenza qualificato.
- Conservare le presenti istruzioni per l'uso in un luogo sempre accessibile.
- Collocare la stampante su una superficie stabile, per evitare che cada a terra.
- Non collocare la stampante in prossimità di gas facilmente infiammabili o di sostanze esplosive.
- Collegare la stampante a una presa di corrente con tensione adeguata.
- Per scollegare la stampante dalla rete di alimentazione, spegnere la stampante e disinserire sempre il connettore di rete dalla presa.
- Non esporre la stampante ad elevate temperature né alla luce solare diretta e alla polvere.
- Evitare il contatto della stampante con liquidi.
- Non esporre la stampante a colpi, scosse o vibrazioni.
- Verificare che la stampante e il computer siano spenti prima di collegare il cavo di trasmissione dati.
- Durante la stampa, la testina si surriscalda notevolmente. Prima di toccarla, se necessario opportuno quindi lasciarla raffreddare qualche istante.
- Non eseguire alcuna operazione o azione se non nella maniera descritta nel presente manuale. In caso di dubbio, contattare il rivenditore o dalla società incaricata dell'assistenza.

Instrucciones de seguridad importantes (Spanish)

Lea las siguientes instrucciones con esmero antes de poner la impresora en servicio.

- El dispositivo y la toma de corriente deben estar ubicados de forma que sea fácil acceder a ellos.
- Nunca lleve a cabo trabajos de mantenimiento o reparación Ud. mismo, sino consulte a un técnico de servicio calificado.
- Guarde las presentes instrucciones de servicio en un lugar de fácil acceso en cualquier momento.
- Ponga la impresora sobre un base estable de manera que no pueda caer al suelo.
- Nunca coloque la impresora en la vecindad de gases de fácil inflamabilidad o sustancias explosivas.
- Asegure conectar la impresora sólo a un enchufe con un voltaje correcto.
- Cuando quiera desconectar la impresora de la red, apague la impresora y siempre tire la clavija de alimentación del enchufe.
- No exponga la impresora a temperaturas altas, a la luz solar directa y al polvo.
- No ponga la impresora en contacto con fluidos.
- Nunca exponga la impresora a sacudidas, choques o vibraciones.
- Asegúrese de que la impresora y el ordenador estén apagados antes de conectar el cable de datos.
- La cabeza de impresión se pone muy caliente durante la impresión. Por lo tanto, deje enfriarlo algún tiempo antes de tocarla.
- No permita que se realice cualquier operación o acción de una forma diferente a lo que se señala en el manual. En caso de duda, póngase en contacto con su comerciante o con su servicio post-venta.

Правила по технике безопасности. (Russian)

Прочитайте, пожалуйста, инструкцию по технике безопасности перед включением в работу принтера.

- Устройство и розетка должны быть всегда легко доступна.
- Не выполняйте технические работы и ремонт техники самостоятельно, но сообщайте о неисправностях квалифицированным сервисным техникам.
- Данная инструкция должна быть всегда доступна каждому пользователю.
- Установите принтер на ровном и стабильном месте так, чтобы он не смог упасть на пол.
- Ни в коем случае не ставьте принтер вблизи легко воспламеняющихся газов и взрывчатых веществ.
- Включайте принтер в розетку только с соответствующим напряжением.
- Если Вы хотите отключить принтер от напряжения, сначала выключите принтер сам и затем выньте штекер из розетки.
- Берегите принтер от нагревания, от попадания на него прямых солнечных лучей и пыли.
- Не допускайте попадания жидкости на принтер.
- Нельзя подвергать принтер тряске, ударам и вибрации.
- Убедитесь, что принтер и компьютер выключены, только после этого соедините принтер с компьютером.
- Печатающая головка нагревается во время работы принтера. Поэтому подождите какое-то время, прежде чем дотронуться до нее.
- Пользуйтесь принтером так, как это написано в документации. Если у Вас возникают неясности, обращайтесь с вопросами к Вашим продавцам или в сервисный центр.

Instruções Importantes sobre Segurança (Portuguese)

Leia as instruções de segurança antes de usar a impressora.

- A impressora e a tomada devem ser facilmente em todos os momentos acessíveis.
- Consulte sempre um técnico qualificado para executar uma reparação .
- Coloque a impressora sobre uma base sólida e nivelada, para que ela não sofra quedas.
- Jamais instale a impressora nas proximidades de lugares onde haja gás inflamável ou substâncias explosivas.
- Assegure-se de conectar a impressora à tomada elétrica com a voltagem apropriada.
- Quando desligar a impressora da rede, desligue sempre a impressora e retire o cabo da tomada.
- Não exponha a impressora a temperaturas altas ou luz solar direta.
- Não aproxime substâncias líquidas da impressora.
- Proteja a impressora de choques, impactos e vibrações.
- Desligue a impressora e o computador antes de conectar o cabo da rede.
- A cabeça da impressora pode ficar muito quente . Portanto, espere algum tempo antes de tocá-la.
- Não faça nenhuma operação ou ação além das recomendadas neste manual. Em caso de dúvida, contate seu revendedor ou companhia de serviço.

Önemli Güvenlik Talimatları (Turkish)

Lütfen, yazıcıyı işleme geçirmeden önce bu güvenlik talimatlarını bütünüyle dikkatle okuyun.

- Cihaz ve elektrik prizinin her zaman kolayca erişilebilir olması gerekir.
- Bakım ve tamir çalışmalarını kesinlikle ve hiçbir surette kendi başınıza yapmayın; her zaman kalifiye bir uzman servis-teknişyenine haber verin.
- Yazıcıyı, üzerinden yere düşmesi mümkün olmayacak sabit ve düz bir zemine yerleştirin.
- Yazıcıyı kesinlikle ve hiçbir surette kolayca yanabilecek gaz veya patlayıcı maddeler içeren nesnelere yakınına koymayın.
- Yazıcı akım kablosunu sadece doğru gerilime sahip bir prize takın.
- Yazıcıyı şebeke ağından ayırmak istediğinizde, yazıcıyı kapatın ve ağ-fişini her zaman prizden çıkartın.
- Yazıcıyı ne yüksek ısı ne de doğrudan güneş ışığına ve toza mârüz kalan mekânlarda bulundurun.
- Yazıcı hiçbir sıvı maddeyle temasta olmamalıdır.
- Yazıcı hiçbir sarsıntıya, darbeye veya titreşime mârüz kalmamalıdır.
- Veri kablosu bağlanmadan önce hem yazıcının hem de bilgisayarın kapalı olduklarından emin olmalısınız.
- Yazıcının başı basma esnasında yüksek ısıya ulaşıyor. Bu yüzden lütfen dokunmadan önce kısa süre soğumasını bekleyin.
- Yazıcının işletimi ve kullanımında bu dokümantasyondaki talimatların hiç dışına çıkmayın. Sorunlu görünen hususlarda lütfen imâlatçınıza veya müşteri hizmetleri servisimize başvurun.

TRADEMARK ACKNOWLEDGEMENTS

“IBM” is a trademark of International Business Machines Corporation.

“EPSON” is a trademark of Epson America Incorporated.

“DEC” is a trademark of Digital Equipment Corporation.

“Centronics” is a trademark of Centronics Data Computer Corporation.

“DOS” is a trademark of Microsoft Corporation.

“SAP” is a trademark of SAP AG.

“Windows”, “Windows 7”, “Windows 8”, “Windows 95”, “Windows 98”, “Windows NT”, “Windows 2000”, “Windows 2003/2008/2012/2012R2 Server”, “Windows XP” and “Windows Vista” are trademarks of Microsoft Corporation.

All other product names and company names appearing in this manual are the registered trademarks or trademarks of the individual companies.

About This Manual

This manual provides information to operators of the DL-210 to describe basic operations to enable safe and correct use of the printer.

Symbols Description

The symbols in this manual are identified by their level of importance, as defined below. Read the following carefully before handling the product.



CAUTION: Provides information that must be observed to prevent damage to the equipment or loss of data.



NOTE: Advises you of information that is essential to complete a task.

Related Software and Documents

Related Software and Documents

Software/document name	Description
DL-210 User Manual	This manual.
DL-210 Maintenance Manual	This manual provides developer/ engineers with all the necessary information.

TABLE OF CONTENTS

About This Manual	X
1 INTRODUCTION	1
1.1 Features.....	1
1.2 Printer specification	2
1.3 Print Media Types	3
1.4 External Dimension and Mass.....	5
1.5 Unpacking	6
1.6 Product Configuration.....	8
1.7 Printer Components.....	9
1.8 Control Panel.....	12
1.8.1 LEDs Behavior.....	12
1.8.2 Feed Key Operation.....	12
2 SETUP	13
2.1 Flow of Setup	13
2.2 Placing the Printer.....	13
2.3 Attaching Power	14
2.4 Calibrate Sensor	15
2.4.1 Calibrate Gap Sensor	15
2.4.2 Calibrate Reflective Sensor	15
2.5 Loading Roll Media.....	16
2.6 Loading Transfer Ribbon	18
2.7 Connecting to Computer.....	21
2.7.1 Connecting USB interface	22
2.7.2 Connecting serial interface	22
2.7.3 Connecting parallel interface	23
2.7.4 Connecting Ethernet interface.....	23
2.7.5 Connecting Wlan Interface	24
3 NETWORK SETUP AND CONFIGURATION	25
3.1 Installing Driver.....	25
3.2 Installing Setup Tool.....	31
3.3 Setup Tool Application	35
3.3.1 Model and Interface Setting	35
3.3.2 Configuring Printer.....	36
3.4 LAN Interface Setup.....	38
3.5 Update Firmware.....	40
4 SETTING/CHECKING MODES	42
4.1 Print a Parameter Setting Page (Self-test Page)	42
4.2 Hexadecimal Dumping Mode	44
4.3 Auto Calibrate Label	45
5 TROUBLESHOOTING AND MAINTENANCE	46
5.1 Common Issues	46

5.2 Resetting the Factory Default Values	47
5.3 Removing Jammed Label	47
5.4 Cleaning Thermal Print Head.....	48
5.5 Maintenance.....	48
6 COMMUNICATION INTERFACES SPECIFICATIONS	49
6.1 USB interface	49
6.3 Bluetooth Interface.....	49
6.4 Ethernet interface.....	49
6.5 Serial interface.....	50
6.6 Parallel interface.....	51
6.7 Power Supply.....	52
7 CHARACTER CODE PAGES	53
7.1 Common to all pages (International Character Set: USA)	53
7.2 International Character Sets.....	54
7.3 [User-defined page].....	55
7.4 [PC437: USA, Standard Europe].....	56
7.5 [PC850: Multilingual]	57
7.6 [PC852: Latin2]	58
7.7 [PC858: Euro].....	59
7.8 [PC860: Portuguese].....	60
7.9 [PC863: Canadian-French]	61
7.10 [PC865: Nordic].....	62
7.11 [PC866: Cyrillic #2].....	63
7.12 [PC720: Arabic]	64
8 COMMAND SETS	65
8.1 ESC/POS Command Sets.....	65
8.2 ZPL Command Sets	67
8.3 EPL Command Sets	73
Appendix: Installing the Cutter	74
Removing the Tear Bar	74
Installing the Auto Cutter	75
Appendix: FCC STATEMENT.....	78
Appendix: DASCOS REPRESENTATIVES.....	79

1 INTRODUCTION

The Dascom® DL-210 model is the best value in a desktop thermal printer. The DL-210 printer provides thermal transfer and direct thermal printing at speeds up to 6 ips (inches per second) at a 203 dpi (dots per inch) print density.

1.1 Features

- Easy to switch printer language between ZPL, EPL and TSC programming and label formats.
- Easy operation. With open structure users can easily change paper roll and ribbon.
- Large media compartment. Ribbon as long as 300m and paper roll of Max. OD ϕ 127mm can be used. Therefore users can change the ribbon and paper roll less often so as to work more efficiently.
- Wide range of connectivity. The USB interface is standard interface. Serial/parallel/Ethernet/Bluetooth are optional interfaces. Various interface choices suit all needs.

The DL-210 printers offer these basic printer options:

- Auto cutter.

This user guide provides all the information you need to operate your printer on a daily basis.

1.2 Printer specification

Print Parameter	Print method	Direct thermal/Thermal transfer printing
	Print width	108mm
	Print speed	6IPS
	Print head	Dot pitch: 0.125mm
	Resolution	203DPIx203DPI
Fonts	Chinese	GB18030 24x24 (Simplified/Traditional Chinese)
	Alphanumeric	Resident single byte (ZPL): Font A, Font B, Font D, Font E, Font F, Font G, Font H, Font V0, Font GS, Font P, Font Q, Font R, Font S, Font T, Font U, Font V
	User-defined	User-defined fonts can be downloaded into FLASH, SDRAM.
	Code Pages	EPL: PC437;PC850;PC852;PC860;PC863;PC865;PC857;PC861;PC862;PC855;PC866; PC737;PC851;PC869;Windows 1252;Windows 1250;Windows 1251; Windows 1253;Windows 1254;Windows 1255 ZPL: PC850, windows 1250, windows 1252, windows 1251, windows 1253, windows 1254, windows 1256
Scalable/Rotation	Zoom in 1~8 times in vertical or horizontal, rotate by 0°, 90°, 180°, 270°.	
Graphics		Graphics (Monochrome PCX, BMP) can be downloaded into SDRAM.
Barcodes	1D	ZPL: Code11;Interleaved 2 of 5;Code 39;Code 49;Planet Code; EAN-8;EAN-13;UPC-E;UPC-A;Code 93;Code 128; Industrial 2 of 5;Standard 2 of 5;Codabar;MSI;Plessey EPL: EAN-8;EAN-13;UPC-E;UPC-A;Code 39;Code 93;Code 128; Interleaved 2 of 5
	2D	ZPL: PDF417;CODABLOCK;Maxicode;Aztec;QR Code; Data Matrix; EPL: PDF417;Maxicode;QR Code; Data Matrix;
Ribbon	ID	φ25.4mm
	OD	φ68mm
	Length	300m
	Width	33~110mm
Media Handling	Media Spec.	Thickness 0.06~0.18mm
		Width 25~118mm
		Length 8.9~400mm
		Max. OD φ127mm
	Min. ID φ25.4/38.1mm	
Media cut	Tear bar, auto-cutter, peeler	
Media type	Roll paper, fold paper (continuous, non-continuous, continuous tag, wrist-band, normal media and all sorts of receipts)	
Control Panel	Key	One key: Feed
	LED indicator	Three LEDs: Power, Error, Status (Paper out/Ribbon out)
Detect Function	Standard sensors	Black mark sensor, Media sensor, Ribbon sensor, Machinery sensor
	Optional kit sensor	Label taken sensor
Emulation	Zebra, EPSON	ZPL, EPL, TSC

Power Supply		External power adapter
	Input	AC 100V-240V, 50-60Hz
	Output	24V DC, 3A
Memory	SDRAM	8MB
	FLASH	8MB
Interface	Standard	USB (2.0 Full-Speed)
	Optional	Serial (RS-232, DB25)
		Parallel Centronics (IEEE-1284)
		Ethernet: 10M/100M
	Bluetooth: SPP	
Software		Driver (Windows 32bit/64bit), Bartender, SDK system
Physical Spec.	Dimensions	230(W)×290(D)×176(H)mm
	Casing Color	Black
	Weight	Approx 3kg
	Operating condition	5~40°C/20~95%RH (non-condensing)
	Storage condition	-20~60°C/≤95%RH (non-condensing)
Safety Standard	Safety	UL, CE, FCC, CCC
	EMC	Class B
	Certificate	CCC, CE, FCC, UL, Energy star
Optional kit		Cutter, Peeler
Reliability	TPH lifetime	150km (Condition: use specific thermal roll paper and the print rate is 12%)

1.3 Print Media Types



Important • Dascom strongly recommends the use of Dascom-brand supplies for continuous high-quality printing.

Your printer can use various types of media:

- Standard media—Most standard (non-continuous) media uses an adhesive backing that sticks individual labels or a continuous length of labels to a liner.
- Continuous roll media—Most continuous roll media is direct thermal media (similar to FAX paper) and is used for receipt or ticket style printing.
- Linerless media—Linerless labels have an adhesive backing, but they are wound onto a core without a liner. The media typically is perforated and may have black marks on the bottom surface of the media to indicate label separations. The top surface of linerless media labels have a special coating that keeps the labels from sticking to each other. The printer must be equipped with a special Linerless option to be able to use linerless media to keep the media from sticking to the printer.
- Tag stock—Tags are usually made from a heavy paper (up to 0.0075in./0.19mm thick). Tag stock does not have adhesive or a liner, and it is typically perforated between tags.

For more information on basic media types, see the following table.

The printer typically uses roll media, but you can use fan-fold or other continuous media too. Use the correct media for the type of printing you require. You must use direct thermal media. When printing without a ribbon, you must use direct thermal media. When using ribbon, you must use thermal transfer media.

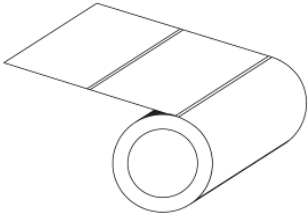
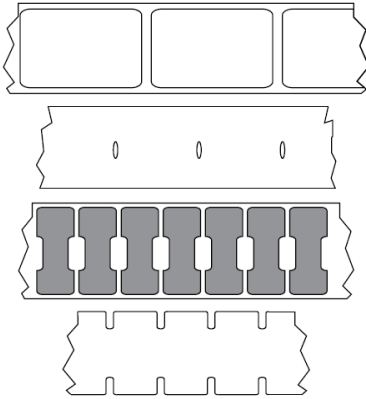
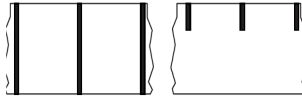
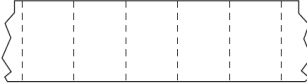
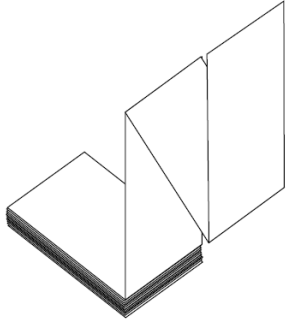
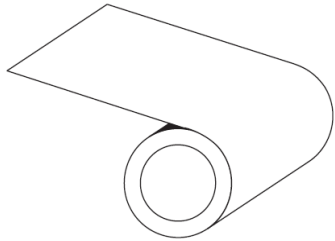
Media Type	How it looks	Description
<p>Non-Continuous Roll Media</p>		<p>Roll media is wound on a core that can be 0.5 to 1.5 in. (12.7 to 38.1 mm) in diameter. Labels have adhesive backing that sticks them to a liner, and they are separated by gaps, holes, notches, or black marks. Tags are separated by perforations. Individual labels are separated by one or more of the following methods:</p> <ul style="list-style-type: none"> • Web media separates labels by gaps, holes, or notches.  <ul style="list-style-type: none"> • Black mark media uses pre-printed black marks on the back side of the media to indicate label separations.  <ul style="list-style-type: none"> • Perforated media has perforations that allow the labels or tags to be separated from each other easily. The media may also have black marks or other separations between labels or tags. 
<p>Non-Continuous Fanfold Media</p>		<p>Fan-Fold media is folded in a zigzag pattern. Fanfold media can have the same label separations as non-continuous roll media. The separations would fall on or near the folds.</p>
<p>Continuous Roll Media</p>		<p>Roll media is wound on a core that can be 0.5 to 1.5 in. (12.7 to 38.1 mm) in diameter. Continuous roll media does not have gaps, holes, notches, or black marks to indicate label separations. This allows the image to be printed anywhere on the label. A cutter can be used to cut apart individual labels. With continuous media, use the transmissive (gap) sensor so the printer can detect when the media runs out.</p>

1.4 External Dimension and Mass

- Width: Approximately 230 mm
- Depth: Approximately 290 mm
- Height: Approximately 179.5 mm
- Mass: Approx. 3 kg (excluding power adapter)



Front View



Back view



Side view

1.5 Unpacking

When you receive the printer, please check for possible shipping damage:

1. Inspect the outside of both the box and the printer for possible damage.
2. Open the top cover of the printer to see if the media compartments are in order.

If you discover shipping damage upon inspection:

- Immediately notify the shipping company and file a damage report.
- Keep all packaging material for shipping company inspection.
- Notify your authorized Tally Dascom reseller.

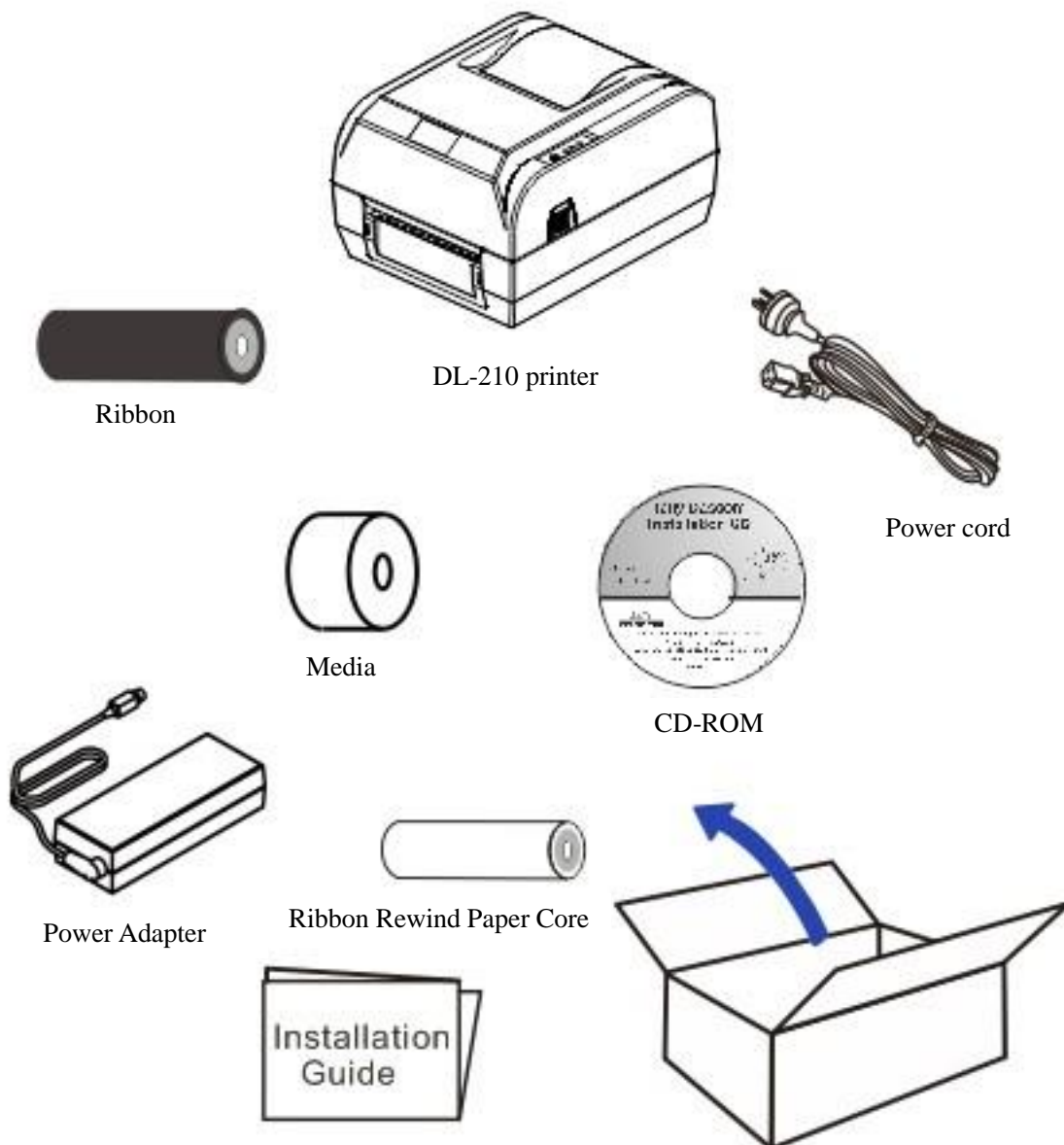

The package contents vary with different customized order requirements.

Package Contents:

Standard	Printer	1 unit	
	Ribbon rewind paper core	1 piece	
	Ribbon sample	1 piece	Wax
	Ribbon spindle	2 pieces	
	Media sample	1 piece	Thermal transfer
	Media fixer	2 pieces	
	Media spindle	1 piece	
	Power adapter	1 piece	EU/UK/US
	Power cord	1 piece	
	Graphic installation guide	1 piece	
	CD-ROM	1 piece	Including user guide, Driver, setup tool, graphic installation guide
Optional	Peeler	1 set	
	Cutter	1 set	

1.6 Product Configuration

Interface Types



- USB interface (USB2.0, Full speed)
- Serial interface: Serial port (RS-232, DB25)
- Parallel interface: Bidirectional parallel port (IEEE1284)
- LAN interface: Ethernet (10Base-T, 100Base-TX)
- Bluetooth interface (BT 2.1+EDR, SPP)

Model	Interfaces						Power Cord	Paper Cut		Sensor
	USB	PAR	SER	ETH		Bluetooth	EN/UK/EU	Cutter	Tear Bar	Black Mark
DL-210	√	O	O	O		O	√	O	√	√

Remarks: “√” indicates standard configuration, “O” indicates optional configuration.

PAR=Parallel interface; SER= Serial interface; ETH=Ethernet interface.

1.7 Printer Components

Printer components and their functions are shown as below:



Component Name		Function
Media window		Monitor the media status via this window
Top cover		Open this cover for loading ribbon and media
Control Panel	Power LED	Indicate the power status
	Status LED	Indicate the status of media, ribbon and label-taken
	Error LED	Indicate print head temperature and Print head mechanism open or not
	Feed key	Press this key for feeding media
Power socket		Connect power cord to the printer
Power switch		For switching on/off printer
USB interface		Connect USB interface cable from host
Optional interface (Serial/ Parallel/ Ethernet/ Bluetooth)		Connect optional interface cable from host (interface type is on request)

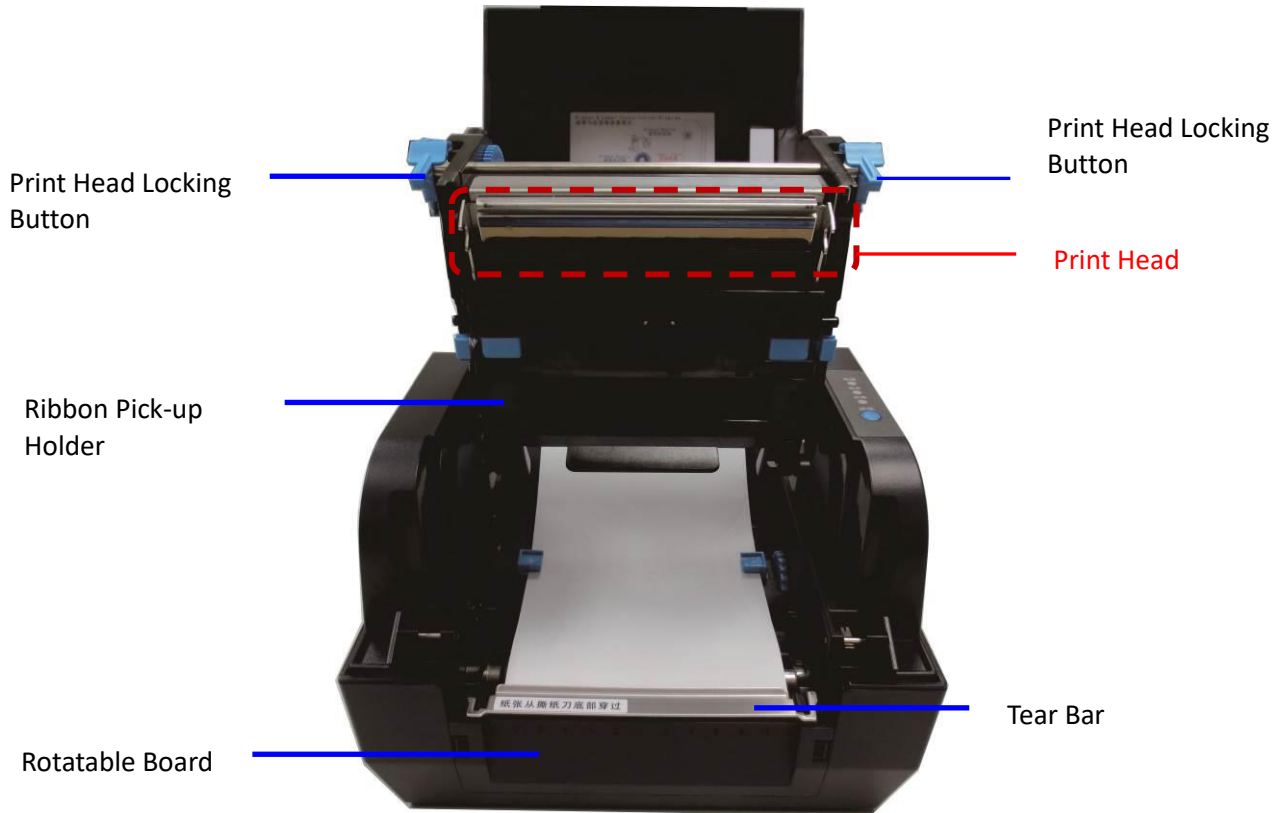
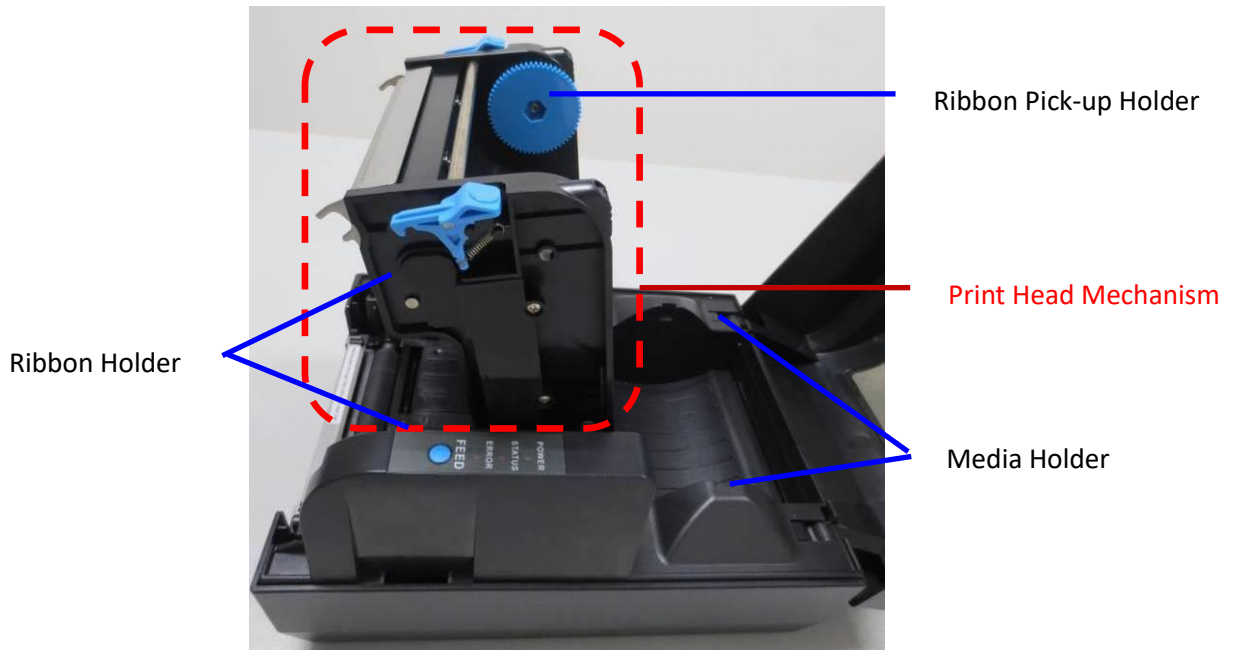

Component Name		Function
Print Head Mechanism	Ribbon Holder	For placing ribbon, lower seat for new ribbon, top seat for used ribbon.
	Print Head	Heat the ribbon and transfer imaging components to the media
Ribbon Pick-up Holder		Turn the adjustor for stretching ribbon
Media Holder		For placing media
Print Head Locking Button		For closing or opening the print head mechanism
Tear Bar		For tearing the media
Rotatable Board		Disassemble the rotatable board for installing optional kit: peeler or cutter

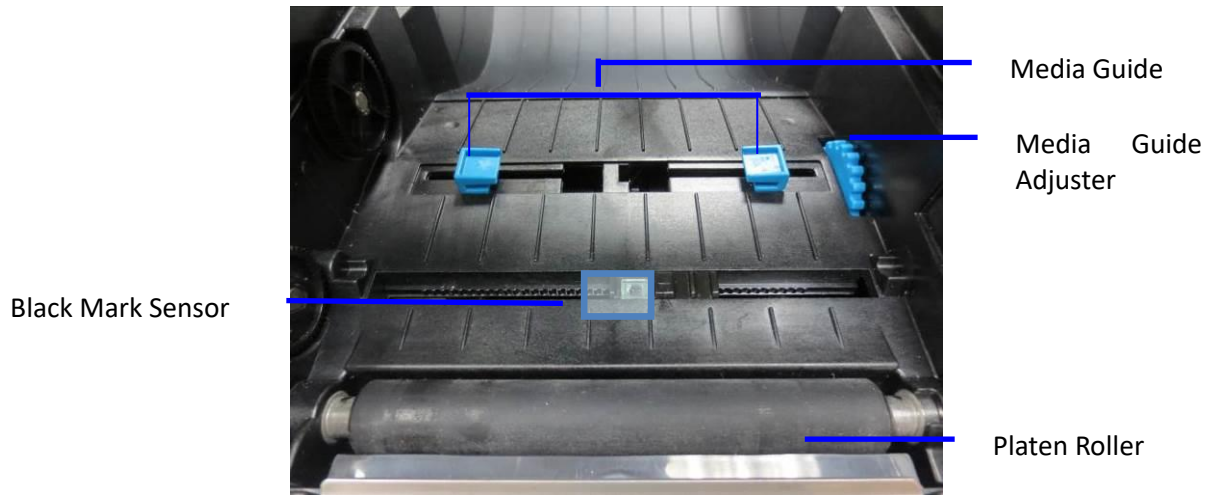

Component Name	Function
Media Guide	Align the media in the center of media path
Media Guide Adjustor	Adjust the space between the two media guides
Black Mark Sensor	For detecting black mark. The sensor position can be adjusted according to the black mark position.
Platen Roller	For feeding paper

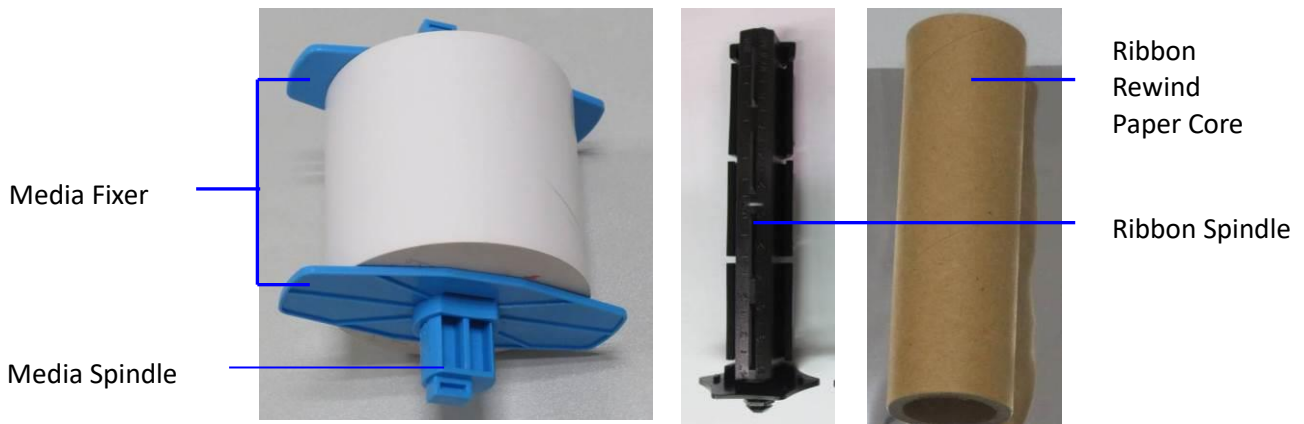

Component Name	Function
Media Spindle	Insert it into media core for supporting media
Media Fixer	For fixing media (as the above figure shown)
Ribbon Spindle	Install it in ribbon holder for supporting ribbon or ribbon rewind pipe
Ribbon Rewind Paper Core	Stick the used end of ribbon to the pipe, rewind ribbon while the pipe is turning

1.8 Control Panel

1.8.1 LEDs Behavior

	LEDs	LEDs' behavior	Status
	Power	On ○	Power on.
		Off ●	Error or power off.
	Status	On ○	Paper end.
		Off ●	Normal.
		Fast blink ○●○●○●○	Label remains in peeler.
		Slow blink ○●●○●●○	Ribbon end.
	Error	On ○	Print head mechanism is opened.
		Off ●	Normal.
		Fast blink ○●○●○●○	Print head is over-heated.

1.8.2 Feed Key Operation

- **Feed Paper**

Under ZPL/EPL mode, press Feed Key once, feed one piece of label;

Under ZPL/EPL mode, hold down Feed Key without release, feed labels continuously.

2 SETUP

1.1 Flow of Setup

This chapter consists of the following sections along with the setup flow of the product and peripherals.

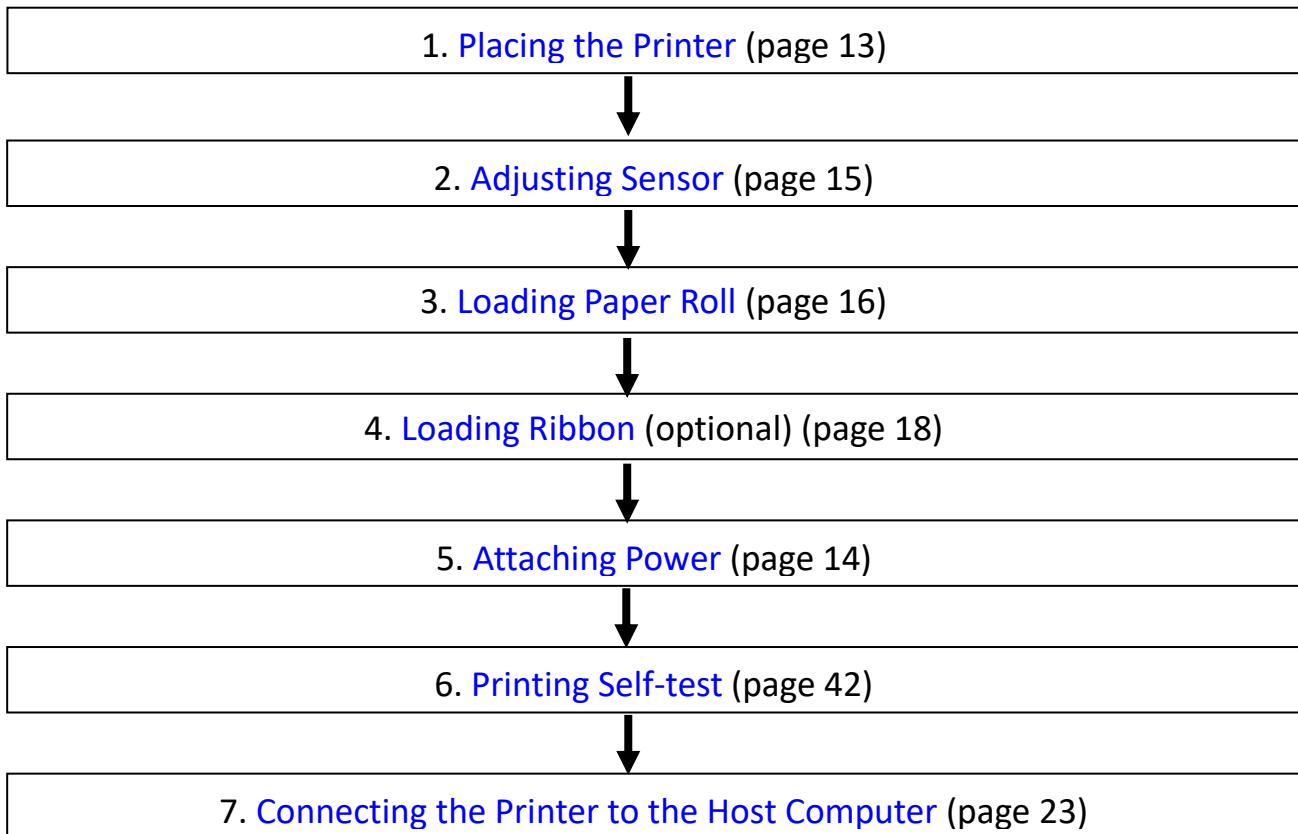

2.1 Placing the Printer

You can install this printer horizontally. Place the printer on a solid, flat, stable surface; ensure the printer is placed in a stable position and there is easy access for users to the control panel and roll paper holder. Also ensure there is enough space for sufficient ventilation and for the printout.

When selecting the placement position, be aware of the following advice:

- Never place the printer near to any flammable gas or explosive substances.
- Do not expose the printer to direct sunlight. If you cannot avoid placing the printer near a window, protect it from the sunlight with a curtain.
- When connecting a computer to the printer, make sure the maximum recommended cable length is not exceeded.
- Ensure sufficient distance between the printer and any heating devices or radiators.
- Avoid exposing the printer to extreme temperature or air humidity fluctuations. Avoid exposure to dusty environments.
- It is recommended the printer is installed in a position which reduces noise exposure to the work place during printing.

2.2 Attaching Power

Checking the voltage of the power adapter



Before you connect the power adapter to the power socket check if the voltage is correct. If you connect the power adapter to power with incorrect voltage this may result in electrical damage to adapter and printer.

1. Make sure the printer and the computer are powered off.
2. Connect the power cord to the power adapter.
3. Connect the power adapter to the power supply interface at the rear of the printer.
4. Ensure the power cord is securely connected. Connect the power cord plug to a mains socket on the wall.

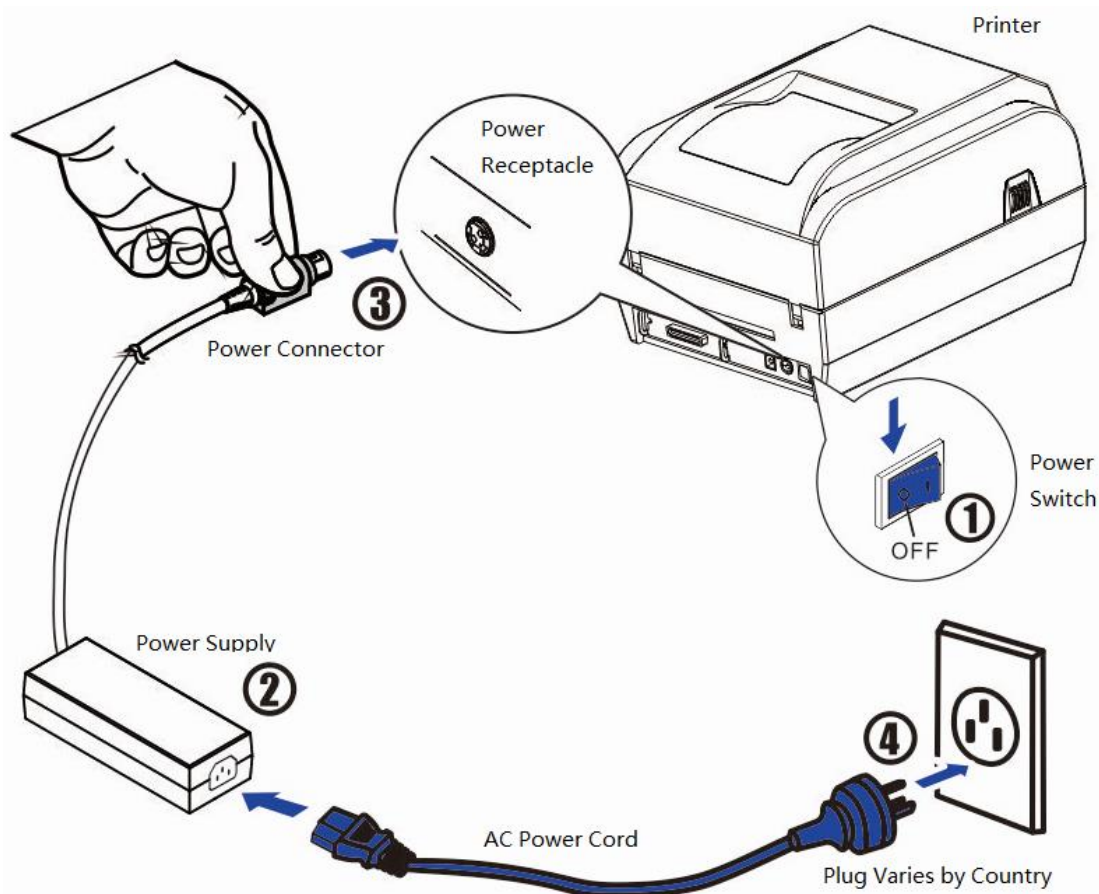

- 1) Please only use the power adapter are recommended by supplied or equivalent products;
- 2) When disconnecting the AC adapter plug, handheld plug connector housing, to avoid the pulling on the cable in force;
- 3) Avoid drag the power adapter cable, otherwise it will damage the cables, causing fire and shock;
- 4) Avoid put power adapter around a heating device, otherwise the cable may melt, causing fire and shock;
- 5) If you do not use the printer in a long time, disconnect the power supply of printer power adapter.



2.3 Calibrate Sensor

Gap sensor and reflective sensor should be calibrated separately.

First of all, please open the setup tool, enter "Printer Setup", choose paper sensor: gap sensor by default. You could switch to reflective sensor according to your need.

2.3.1 Calibrate Gap Sensor

- (1) Make sure gap sensor is selected through the setup tool.
- (2) Lift the top cover to expose the media holder and the print head mechanism.
- (3) Move around the sensor support so as to align its triangle with another triangle on the center housing. As it is shown below:

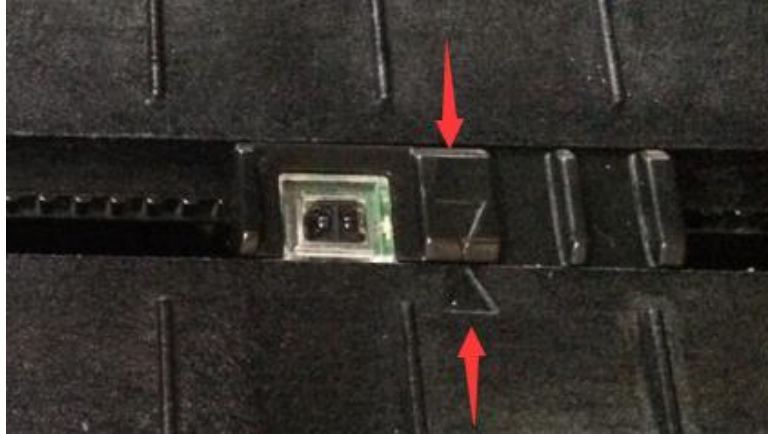

2.3.2 Calibrate Reflective Sensor

- (1) Select Reflective Sensor in the setup tool.
- (2) Lift the top cover to expose the media holder and the print head mechanism.
- (3) Align the black mark sign with the black mark sensor.

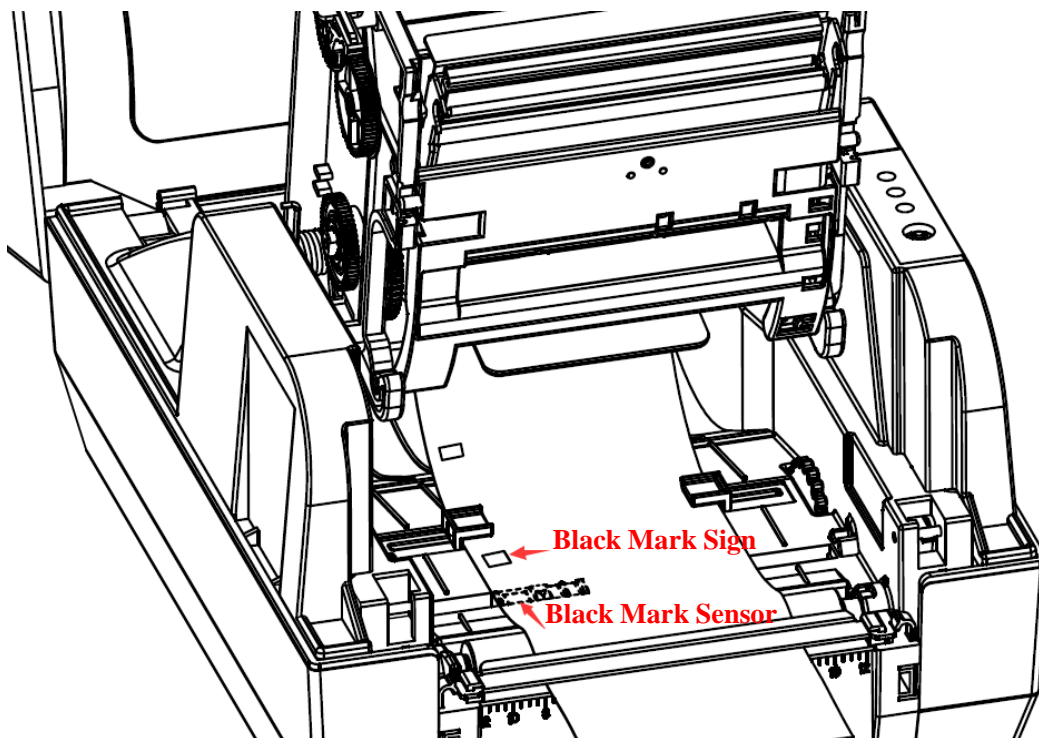

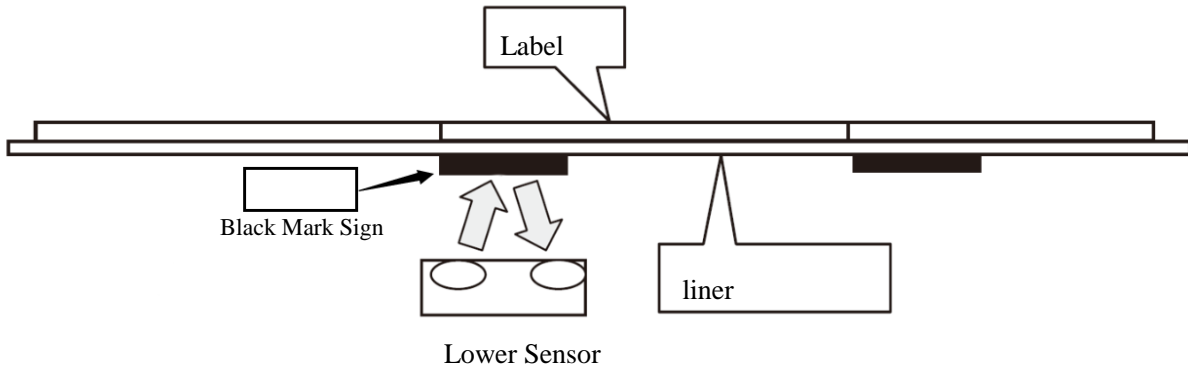

(4) Put the media between the media compartment and the tear bar. And then close the mechanism and the top cover.

2.4 Loading Roll Media



- Must use thermal media in case of no ribbon in the printer. If using ribbon, you have to use thermal transfer media.
- **Tips for avoiding media jam:** Make sure the media is aligned in the center of the printer and the media fixers are firmly pressed against both sides of the roll.

Before printing, it is necessary to check whether the media you use is appropriate or not. You can scratch the media surface, if the scratch turns black, it is direct thermal media. In this case, you do not need to load ribbon. Otherwise, it is thermal transfer media, you have to use a ribbon.



(1) Lift the top cover to expose the media holder and the print head mechanism.

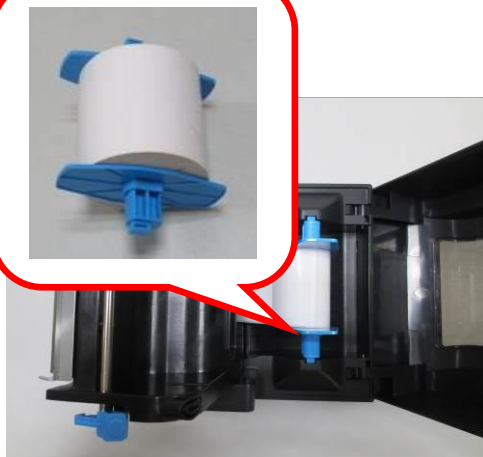

(2) Load the media roll onto the spindle from left to right.

(3) Put the fixers on and move from right to left until they lean against the media.

(4) Click the media spindle back into the media holder.



Print surface must be upward.

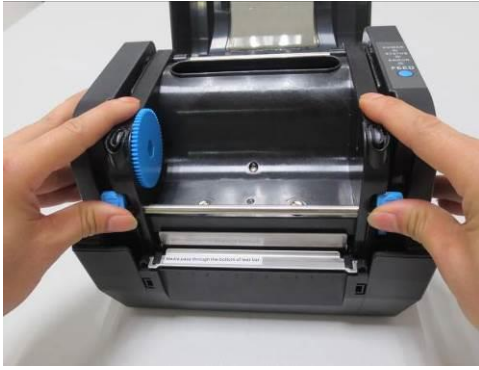

(5) Unlatch the print head mechanism by pushing the two blue locking buttons on the sides toward the rear.

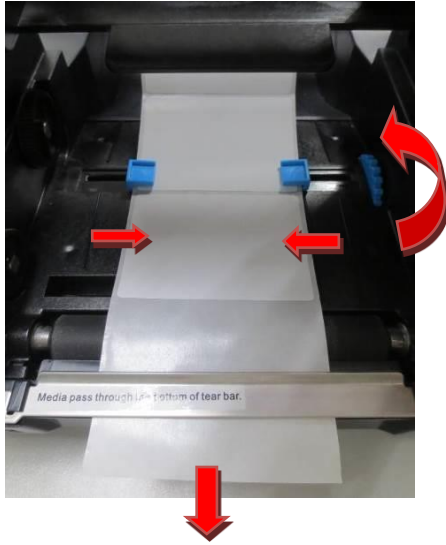

(6) Lead the media under the print head mechanism through the media guides.
 (7) Control the blue media guide adjustor so as to align the media in the central path.
 (8) Lead the media over the platen roller and through the tear bar.



(9) Put the print head mechanism down and press down firmly until you hear a snap.
 (10) Close the top cover and turn on the printer or press the "FEED" button if the printer is already on.

(11) In order to make sure the data is printed within the label area, it is necessary to execute Label Calibration: Hold down Feed Key and switch on printer simultaneously, release Feed Key after the buzzer beeps twice. Then the label will be positioned automatically.

Label calibration should be executed in the following situations:



- Use printer for printing label first time.
 - Replace different size of labels.
 - Printer skips labels
 - Printer feeds blank labels.
 - Refill with new roll of labels.
-

2.5 Loading Transfer Ribbon

Transfer ribbons come in several varieties and in some cases colors to match your application needs. The media and ribbon types should be matched to provide you with optimal print results. Always use ribbon that is wider than the media to protect the printhead from wear.



For direct thermal printing, do not load ribbon in the printer.



Do not use ribbon while using direct thermal media. Otherwise, barcode and graph will be distorted.



(1) Lift the top cover to expose the media holder and the print head mechanism.



(2) Unlatch the print head mechanism by pushing the two blue locking buttons on the sides toward the rear.



(3) Unwrap the ribbon roll pack and separate the ribbon roll and the bare paper core.

(4) Insert the spindles into the core and the ribbon respectively.

(5) Attach the edge of the ribbon on the bare paper core and wind it a little onto the core.

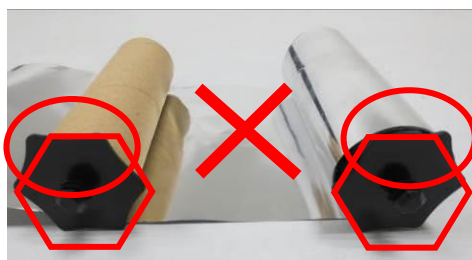

Do not rip the ribbon leader on ribbon rewind pipe.



Do observe the direction of hexagon.



(6) Open the sensor support.

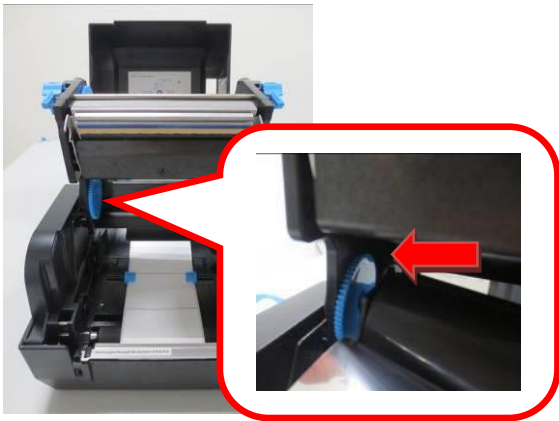

(7) Insert the ribbon roll into the ribbon holder (lower seat of the print head mechanism): Insert the hexagon end onto the ribbon adjustor (blue gear), then insert the other end into the slot of the ribbon holder.



(8) Turn back the print head mechanism and then insert the ribbon rewind paper core into the pick-up holder (top seat): Wind the ribbon through print head, and insert the spindle hexagon end onto the ribbon adjustor (blue gear), then insert the other end into the slot of the pick-up holder.

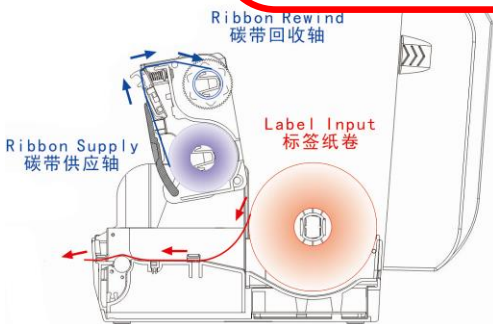

Keep the brighter surface of ribbon inside while winding the print head.



(9) Turn the wheel of the print head mechanism to ensure the ribbon is tightly wound.

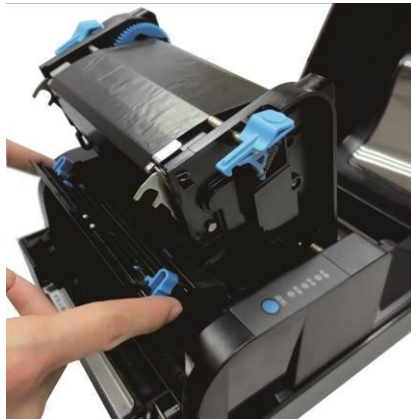

(10) Close the sensor support.



(11) Press down the print head mechanism on both sides firmly until you hear a snap.

2.6 Connecting to Computer



NOTE!

Be sure to install the driver before connecting the printer to the host computer.

Before installing, disconnect the Power Unit from the printer (as well as turning the power switch off). Even when the power switch is off, voltage is still present at some points on the circuit board. Changing components while the power unit is connected can cause damage to the interface board and the printer.

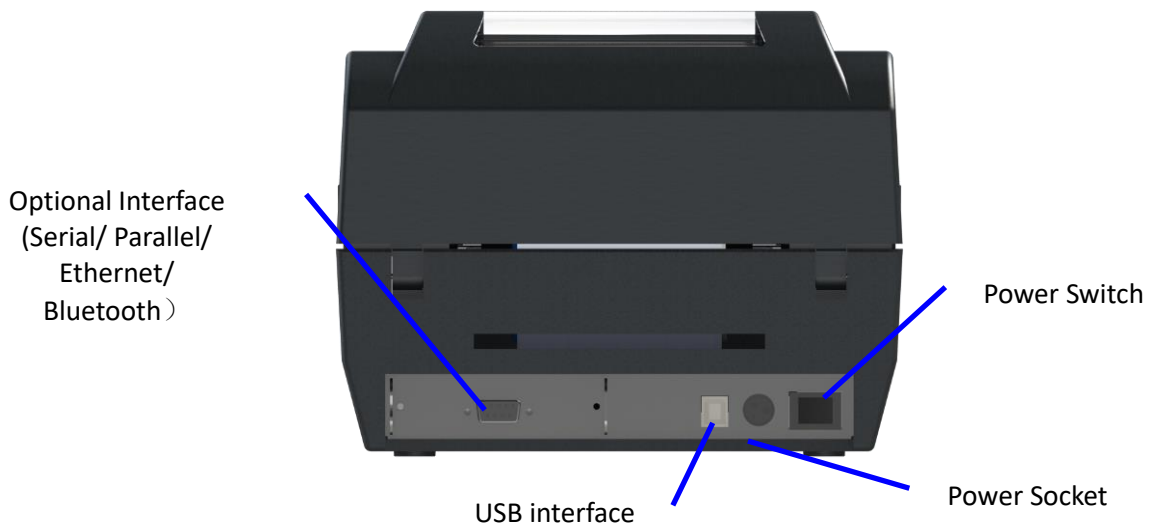

Component Name	Function
Power socket	Connect power cord to the printer
Power switch	For switching on/off printer
USB interface	Connect USB interface cable from host
Optional interface (Serial/ Parallel/ Ethernet)	Connect optional interface cable from host (interface type is on request)

Connection cable must comply with the following requirements:

Connection Type	Specifications
USB	USB 1.1/2.0 compatible
Serial	RS232
Parallel	IEEE 1284.4
Ethernet	10 Base-T/100 Base-TX compatible

2.7.1 Connecting USB interface

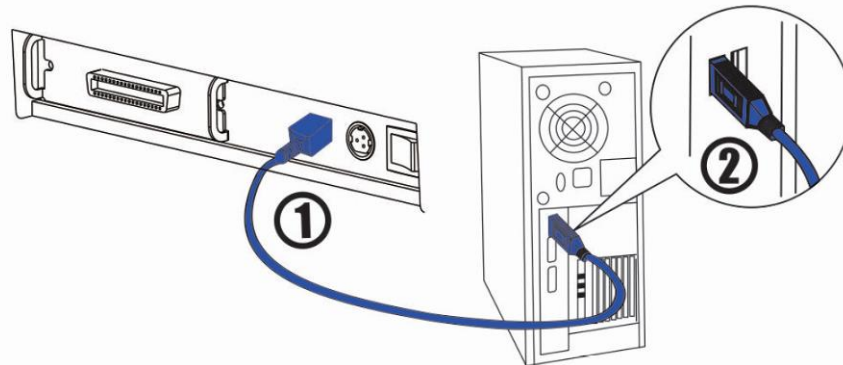
**CAUTION!**

Be careful not to insert the USB interface cable into the cash drawer kick-out connector.

2.7.2 Connecting serial interface

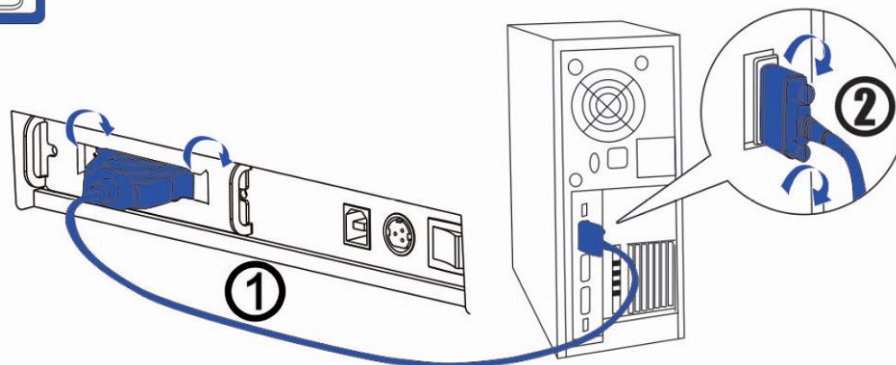
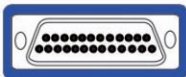
**WARNING!**

Be sure to turn off the power supply for both the printer and host computer before connecting the cables.

1. Insert the interface cable connector firmly into the interface connector on the connector panel.
2. When using the connectors equipped with screws, tighten them to secure the connectors firmly.

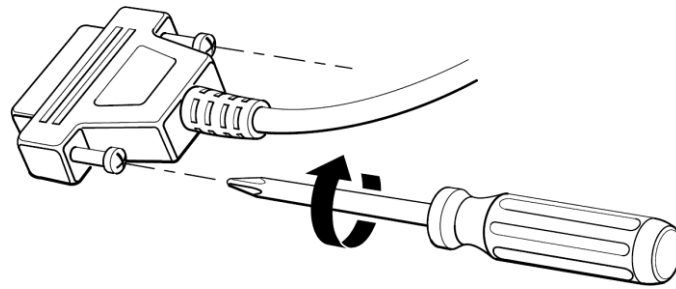

3. When using interface cables equipped with a grounding line, attach the ground line to the screw hole marked "FG" on the printer.
4. Connect the other end of the interface cable to the host computer.

2.7.3 Connecting parallel interface

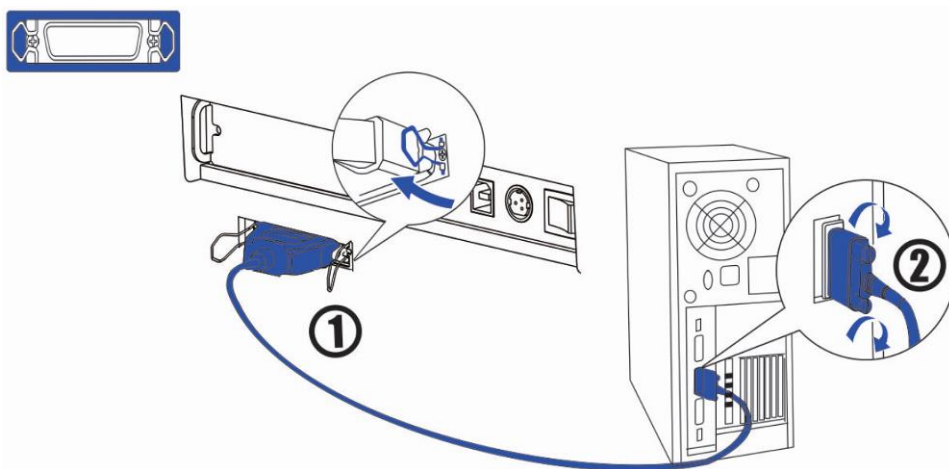

1. Insert the interface cable connector firmly into the interface connector on the connector panel.
2. Press down the clips on either side of the connector to lock it in place.
3. When using interface cables equipped with a grounding line, attach the ground line to the screw hole marked "FG" on the printer.
4. Connect the other end of the interface cable to the host computer.

2.7.4 Connecting Ethernet interface

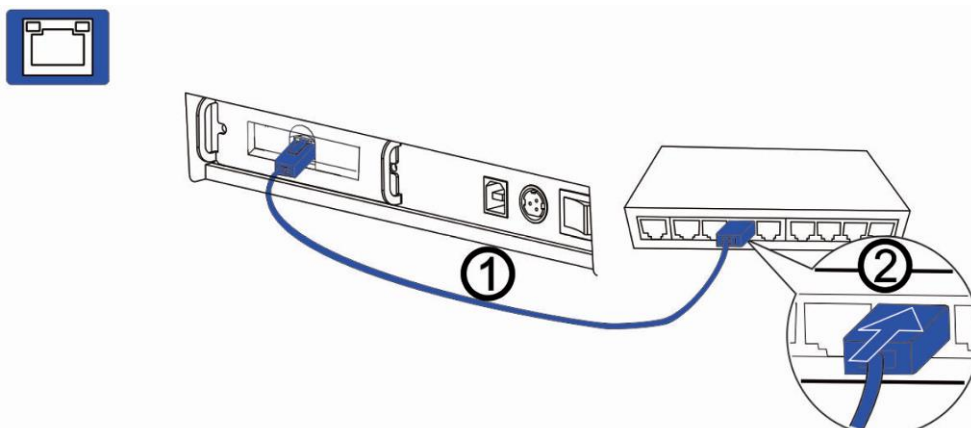



- Before installation, make you have installed the driver and the driver for Ethernet interface (see Installing Driver on page 17)
- When LAN cables are installed outdoors, make sure devices without proper surge protection are cushioned by being connected through devices that do have surge protection. Otherwise, the devices can be damaged by lightning.
- Never attempt to connect the customer display cable, drawer kick-out cable, or the standard telephone line cable to the 10/100BASE-T LAN connector.

Connect the printer to a network by a LAN cable via a switch.

Connect a 10/100BASE-T cable to the 10/100BASE-T LAN connector by pressing firmly until the connector clicks into place.

2.7.5 Connecting Wlan Interface

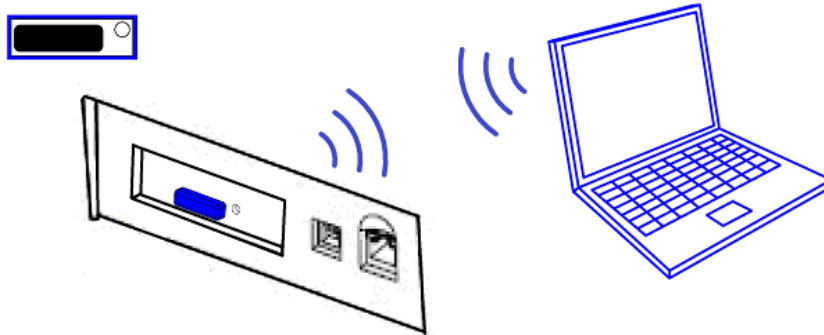

3 NETWORK SETUP AND CONFIGURATION

3.1 Installing Driver



Switch off the printer before running the printer driver setup.

Your printer CD-ROM comes with Windows Driver. Go to the Driver folder and run the installer. Please check the website www.dascom.com for the latest version of driver.

(1) Click "Next".

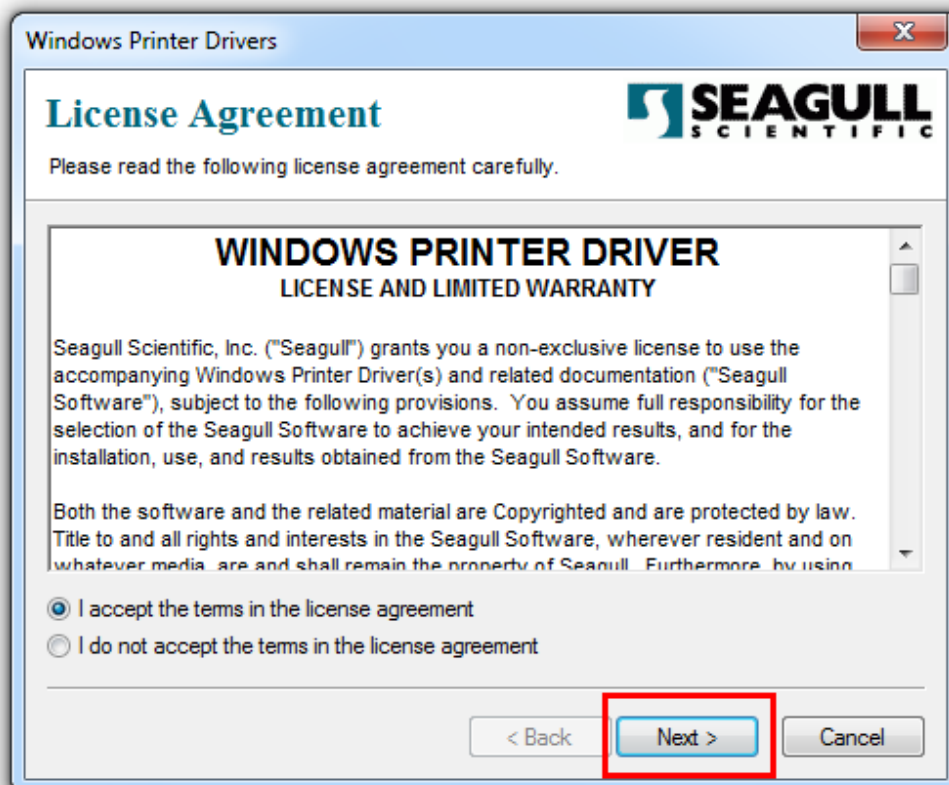

(3) Select the installation path to the Driver.

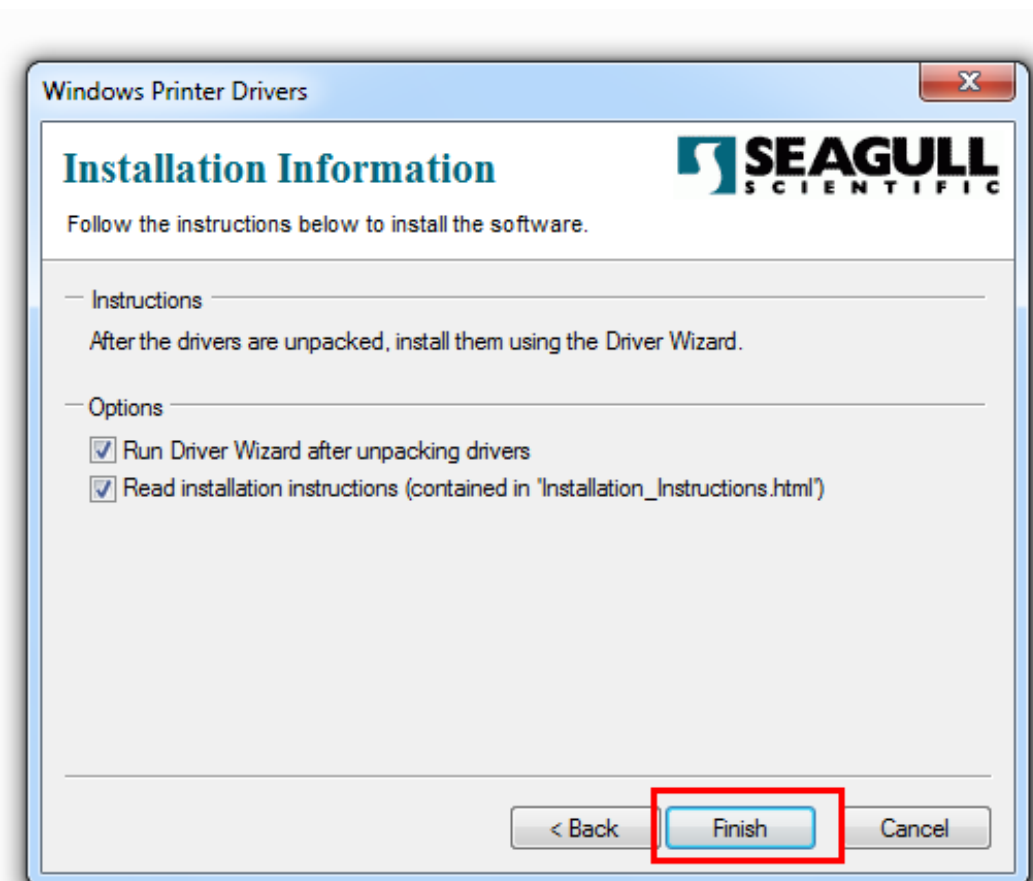
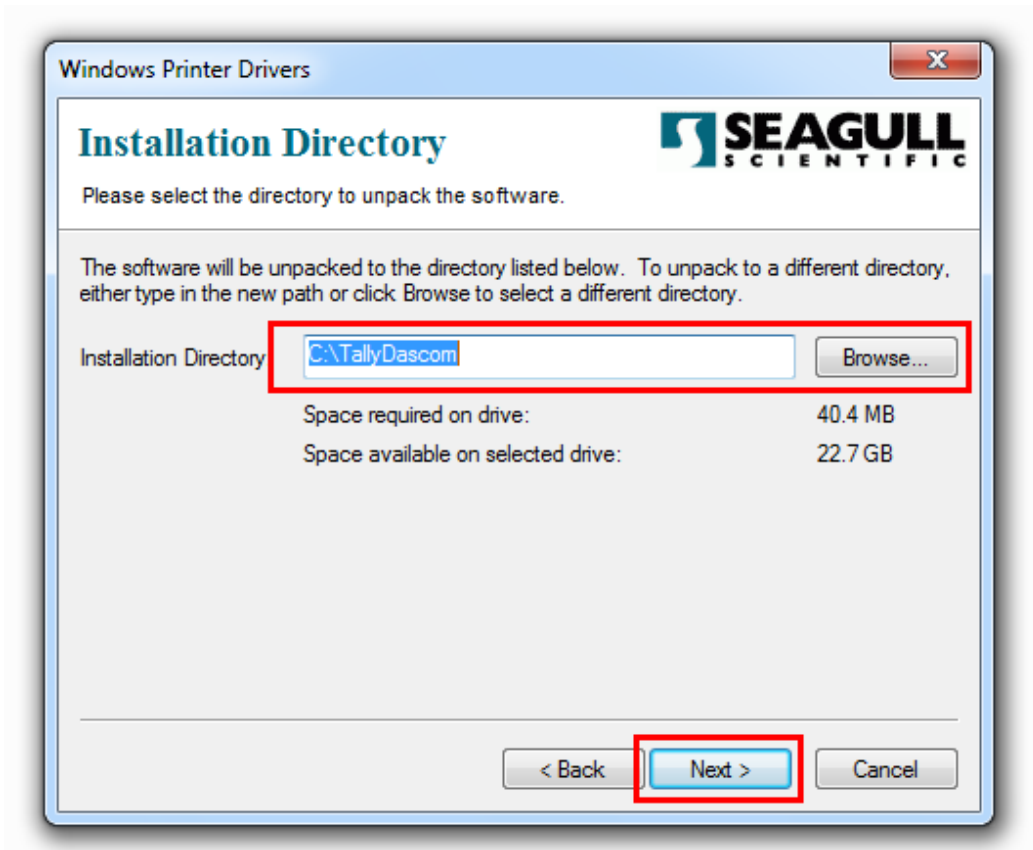

(4) Click “Yes”.

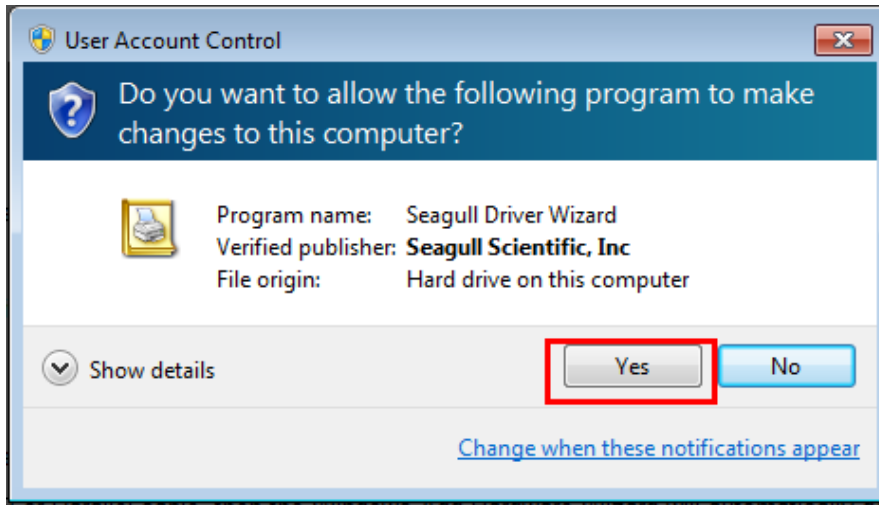

(5) Click “Next”.

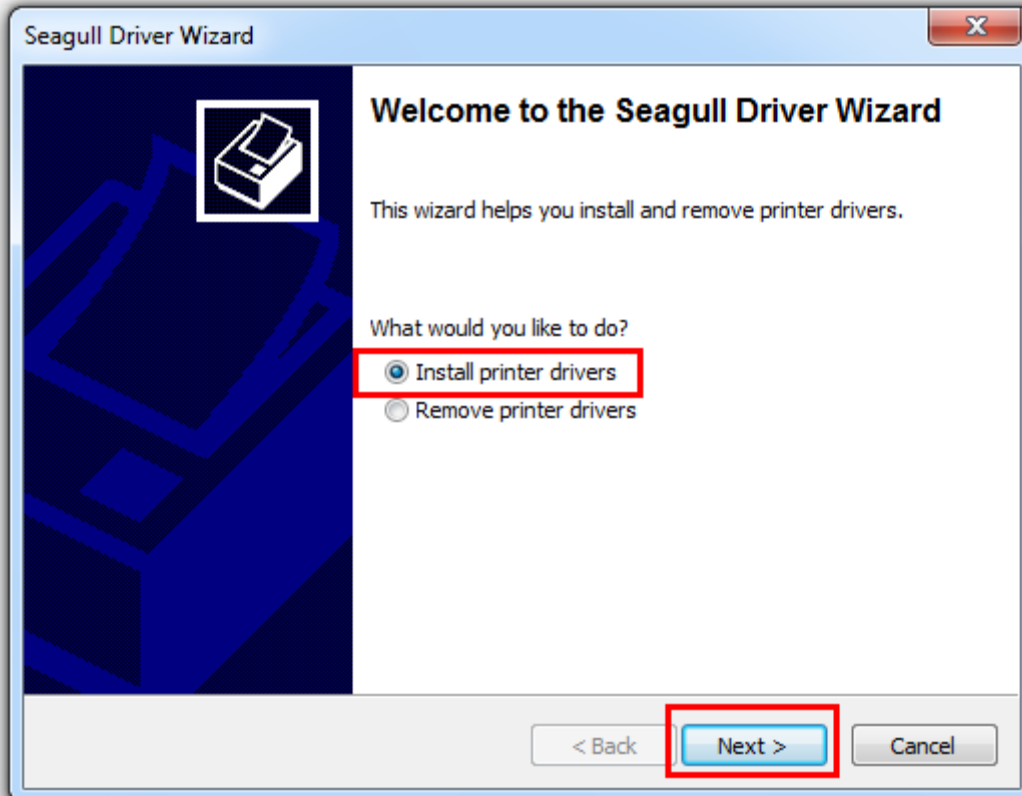

(6) Choose interface.

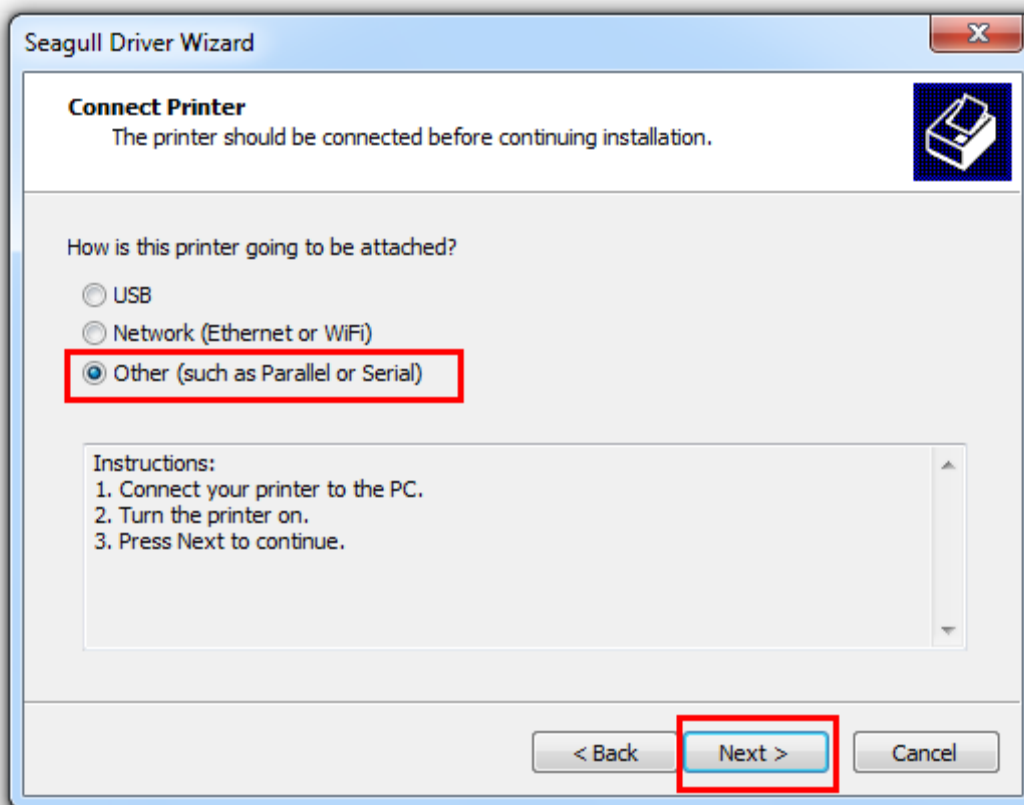

(7) Choose printer model "Tally Dascom DL-210Z" or "Tally Dascom DL-210E", and the installation path. Then click "Next".

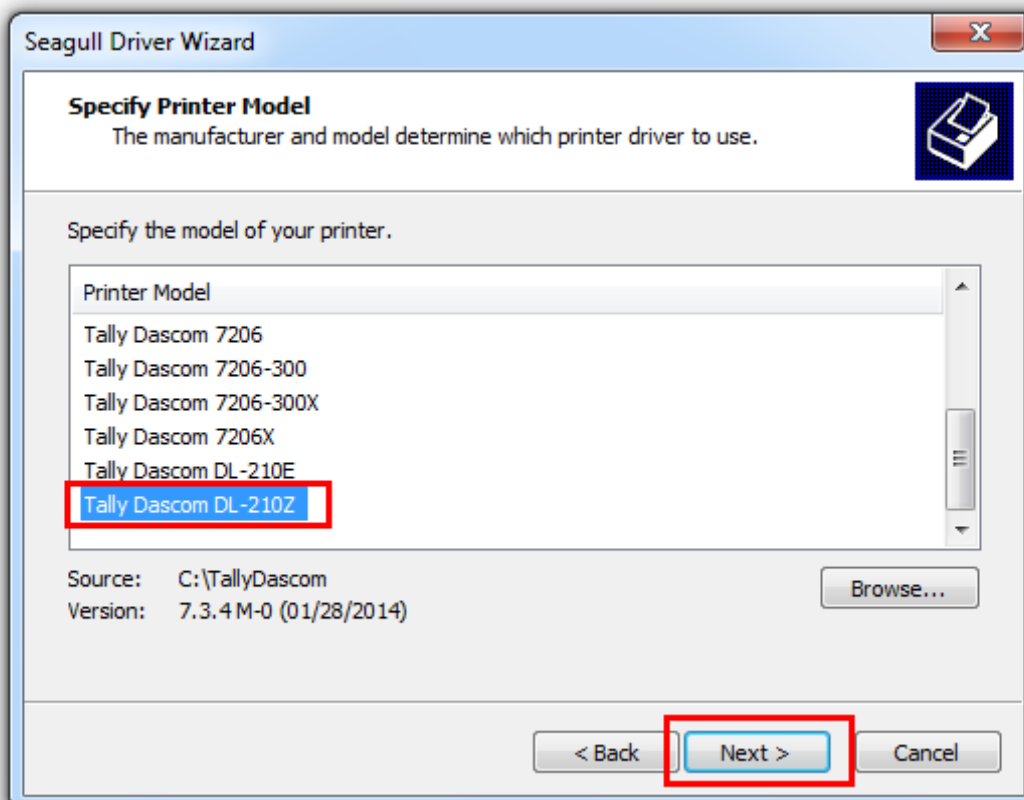

(8) Click “Next”.

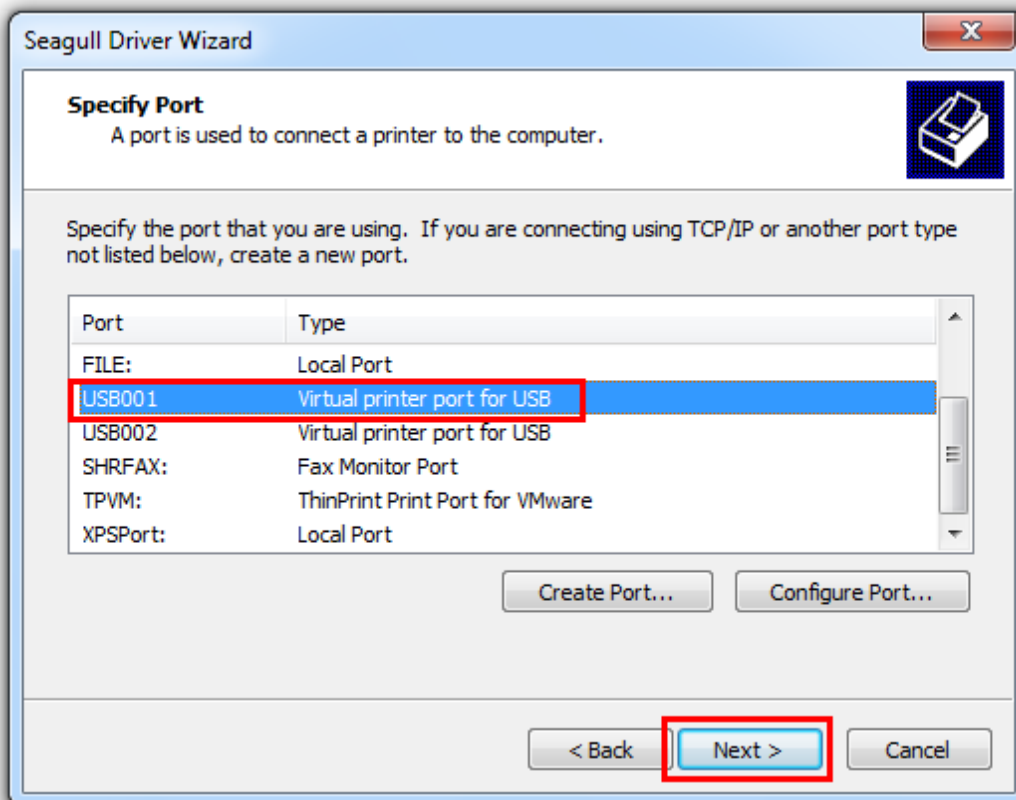

(9) Enter printer name. Click “Next”.

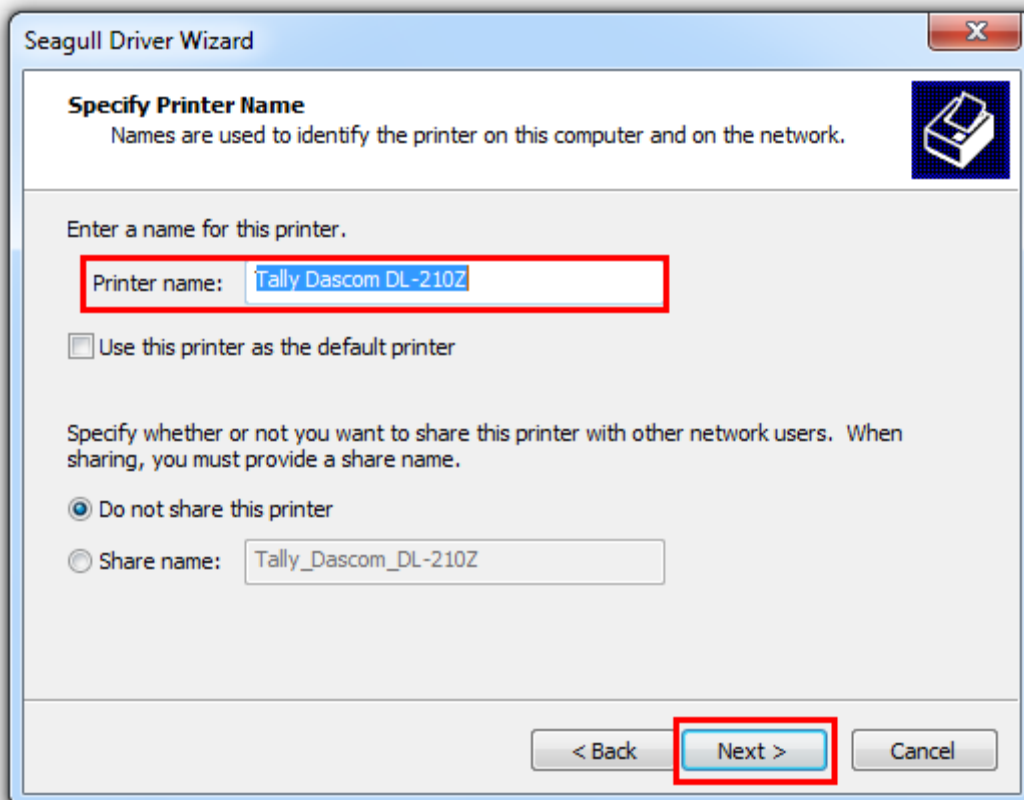

(10) Click "Finish".

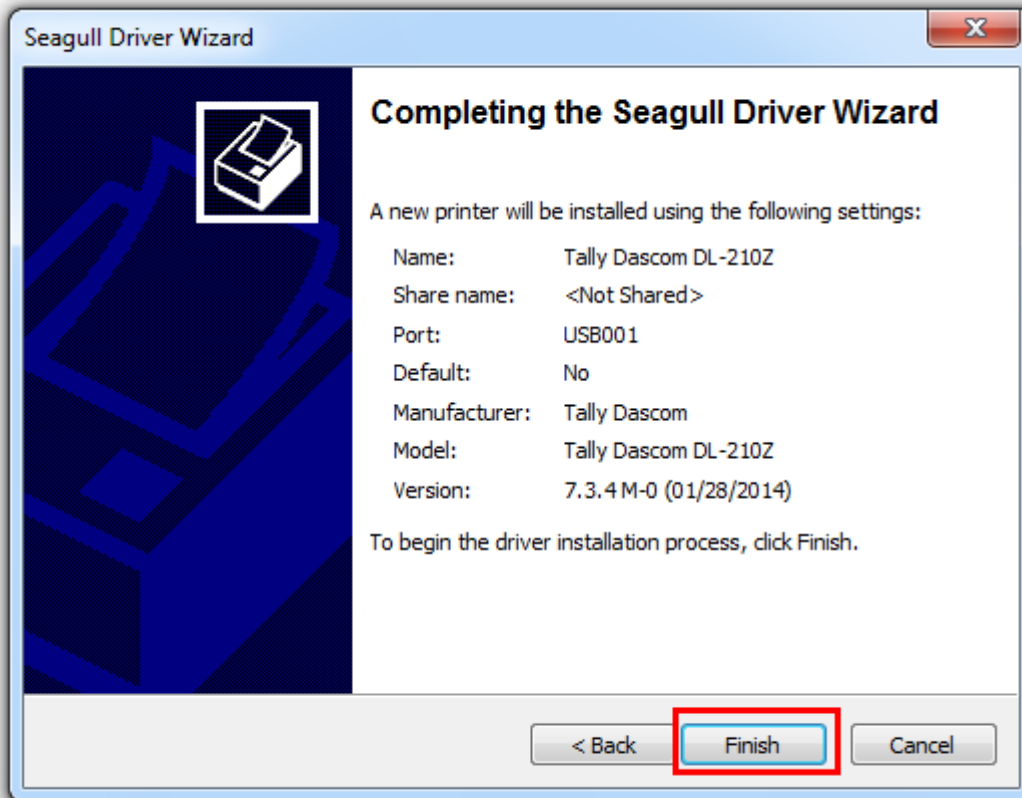

(11) Then the driver is installed successfully.

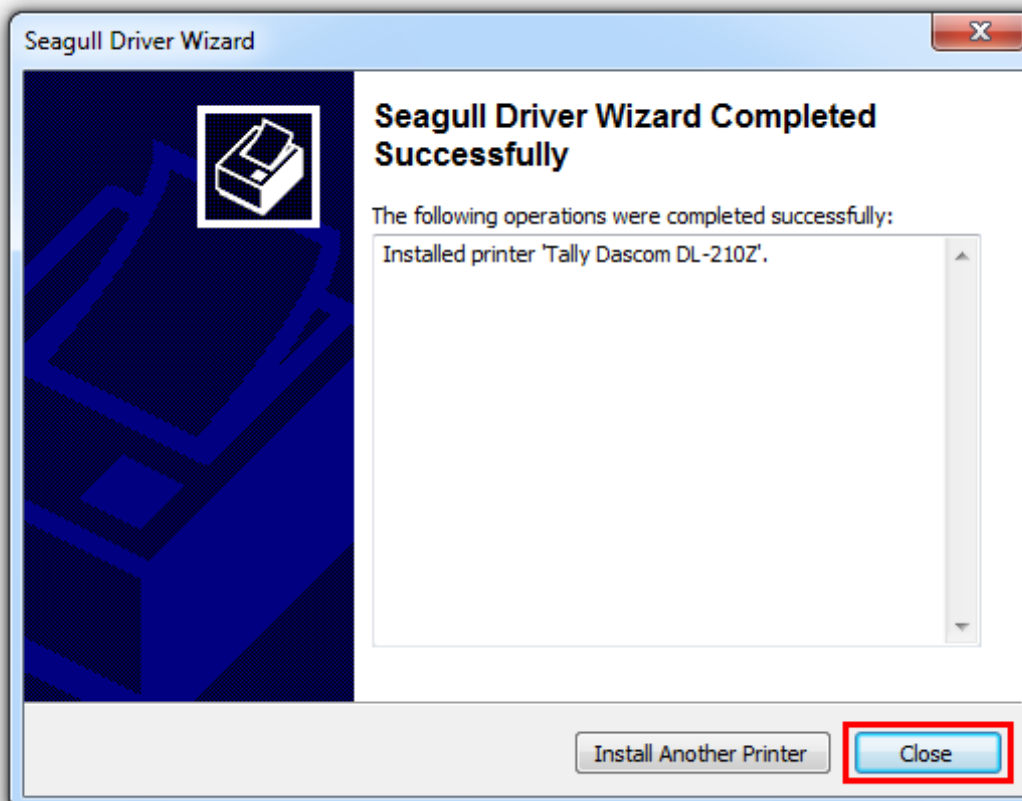

3.2 Installing Setup Tool

Your printer CD-ROM comes with Tally Dascom Setup Tool. Go to the folder and run the installer. Please check the website www.dascom.com for the latest version of setup tool.

(1) Choose setup language.

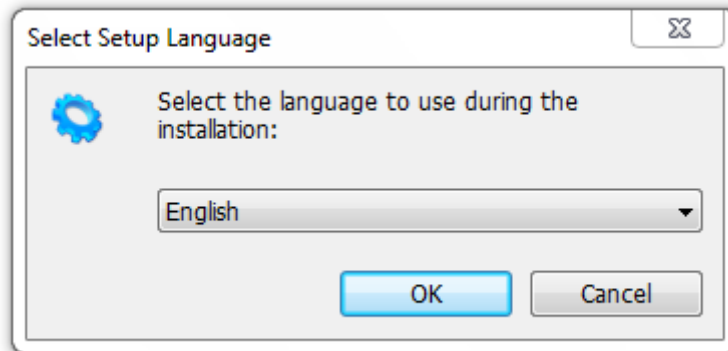

(2) Click next.

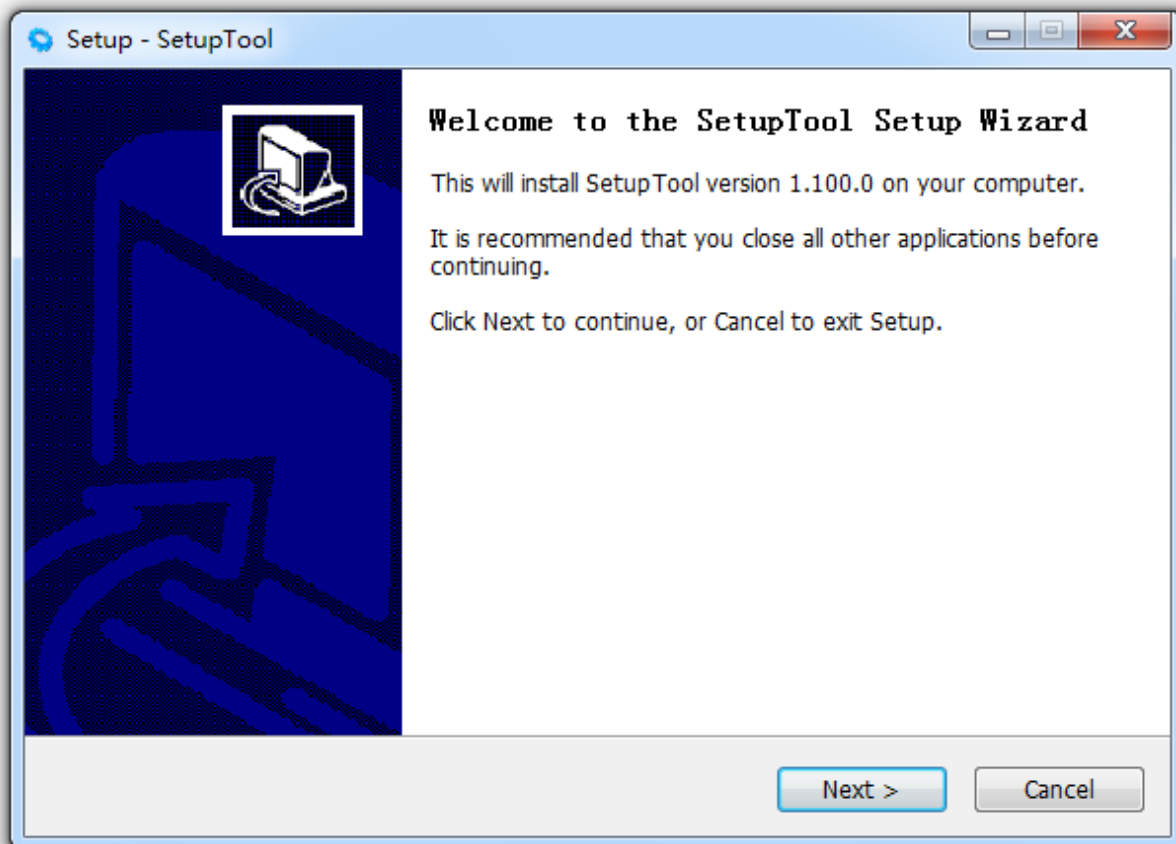

(3) Select the installation path to the tool.

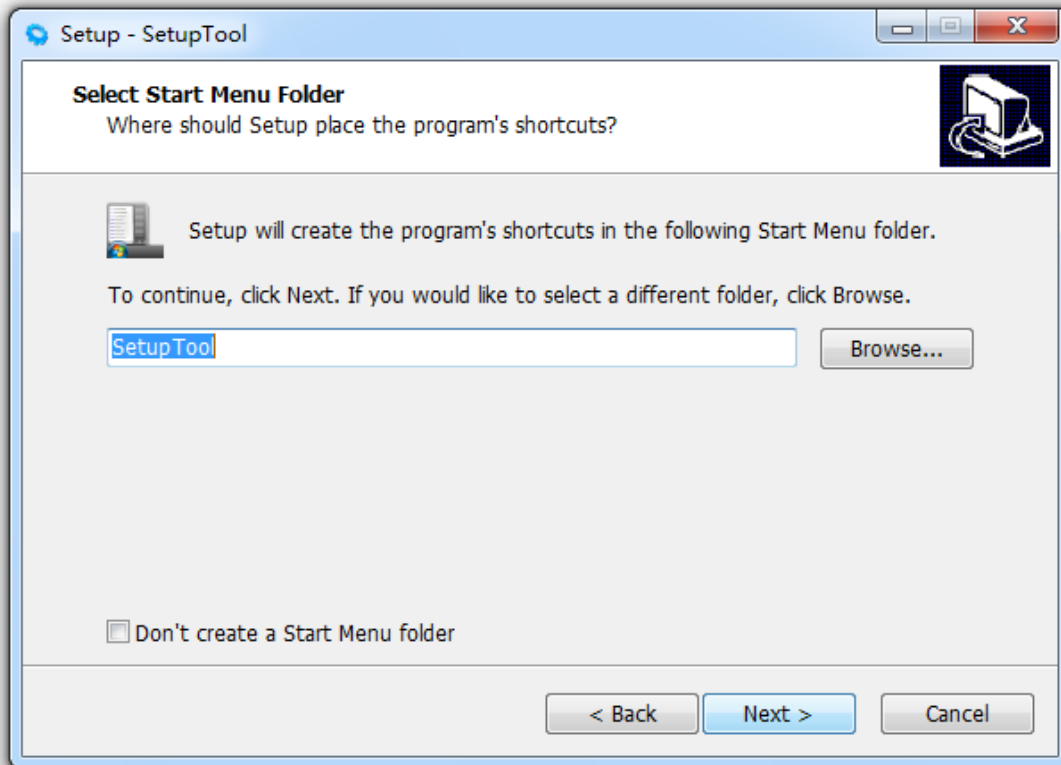

(4) Click "Finish".

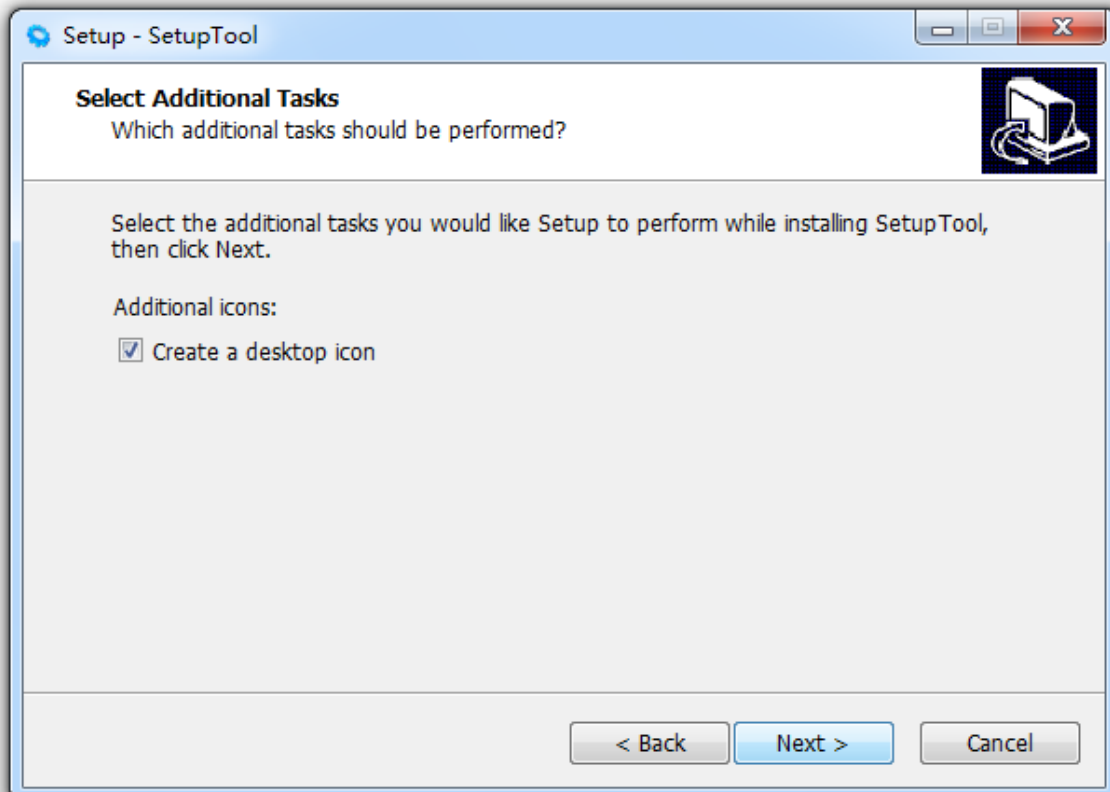

(5) Click "Install".

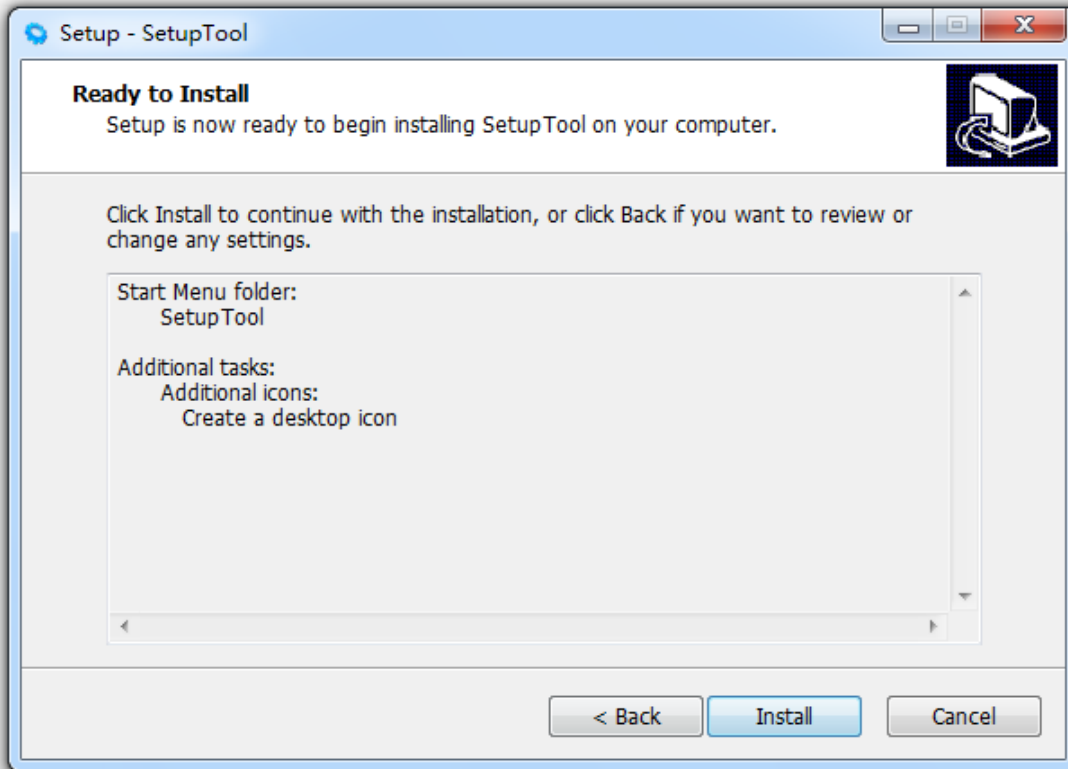

(6) Click "Install".

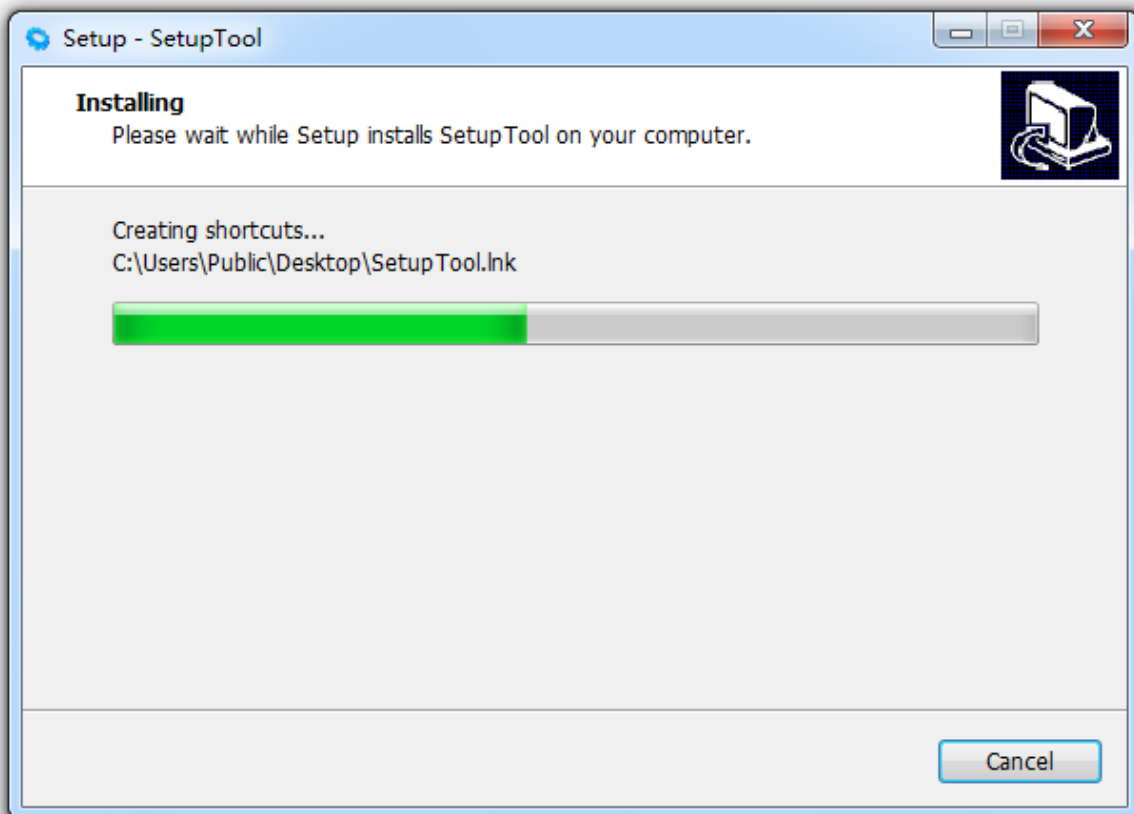

(7) Installation complete. Click "Finish".

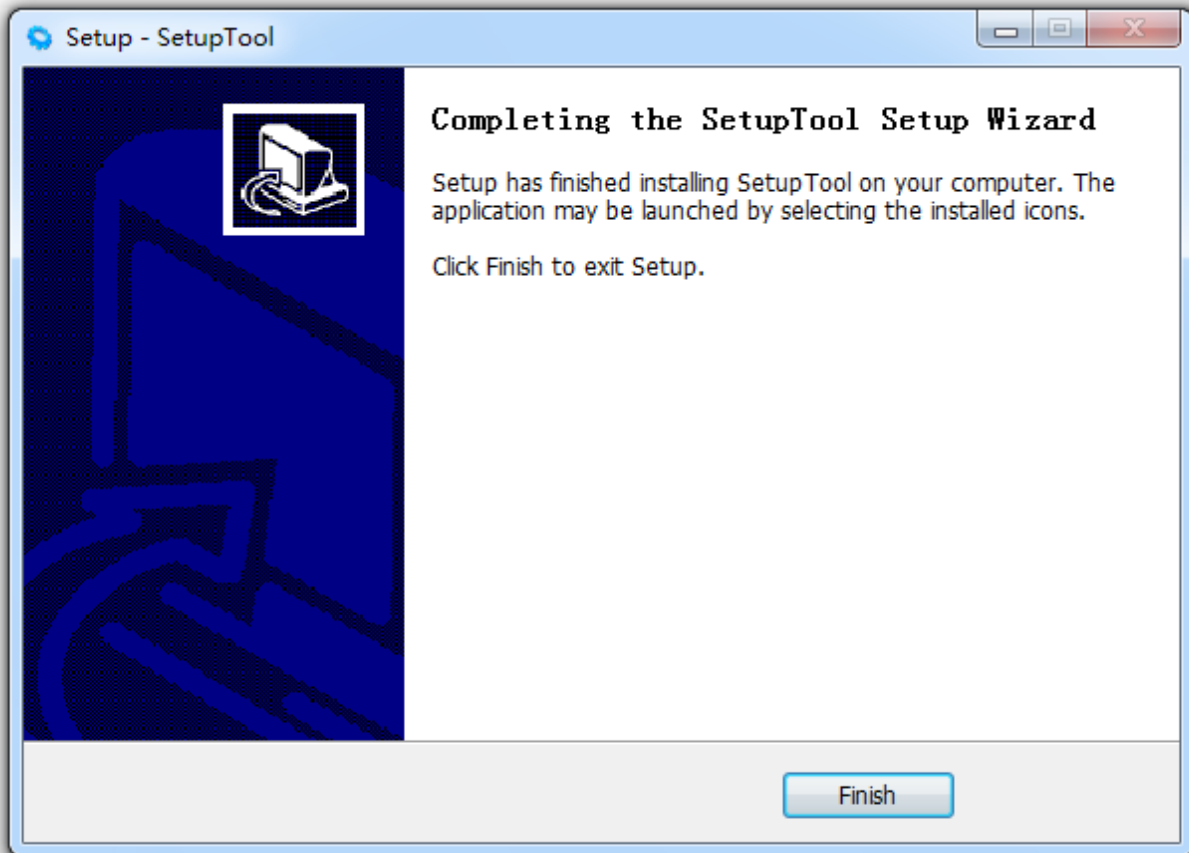

3.3 Setup Tool Application

A CD comes along with printer. The CD contains POS & label printer setup tool for configuring printer.

Or, please find the latest setup tool on Dascom website: www.dascom.com

Read the help file carefully before using the setup tool. Please click “Help” button below for more information.

3.3.1 Model and Interface Setting

Select the printer model and the suitable interface before configuring printer.

Click “setting” for setting serial interface or parallel interface. For serial interface and emulation setting, the setting won’t be valid unless you restart the printer.

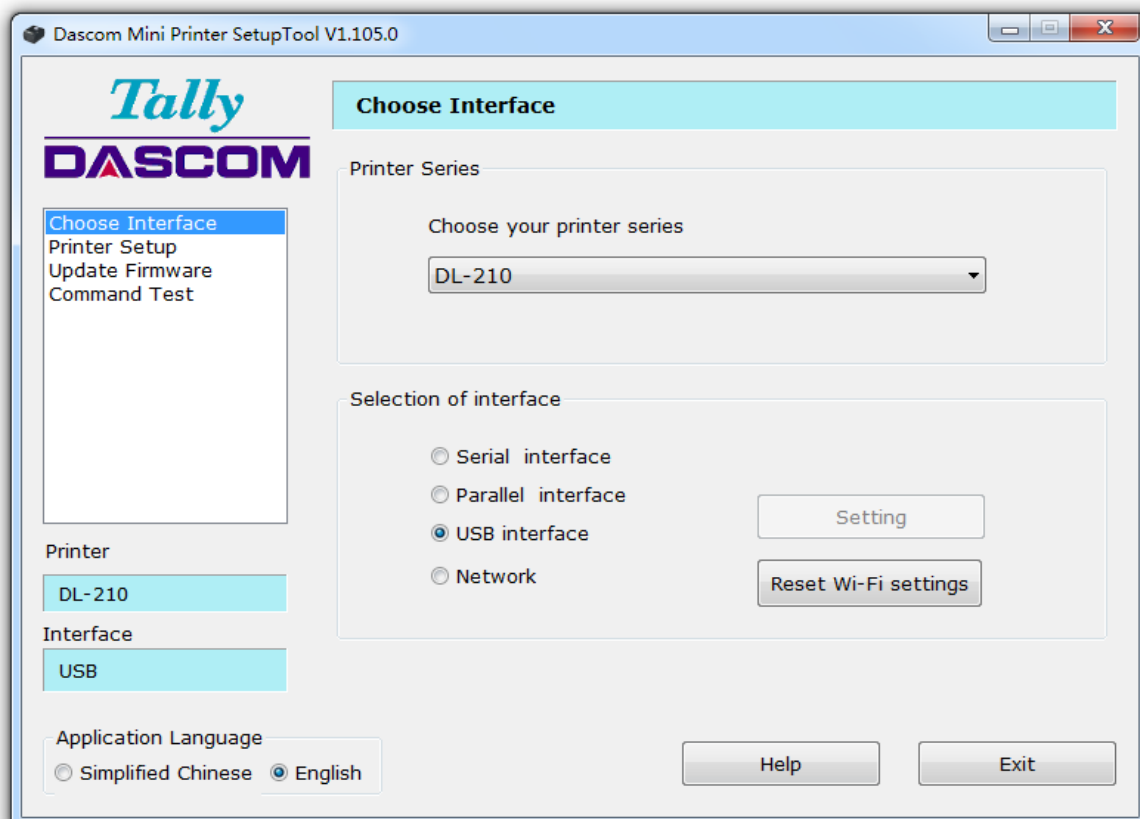

3.3.2 Configuring Printer

After model and interface setting, select “Printer Setup” tab for configurations.

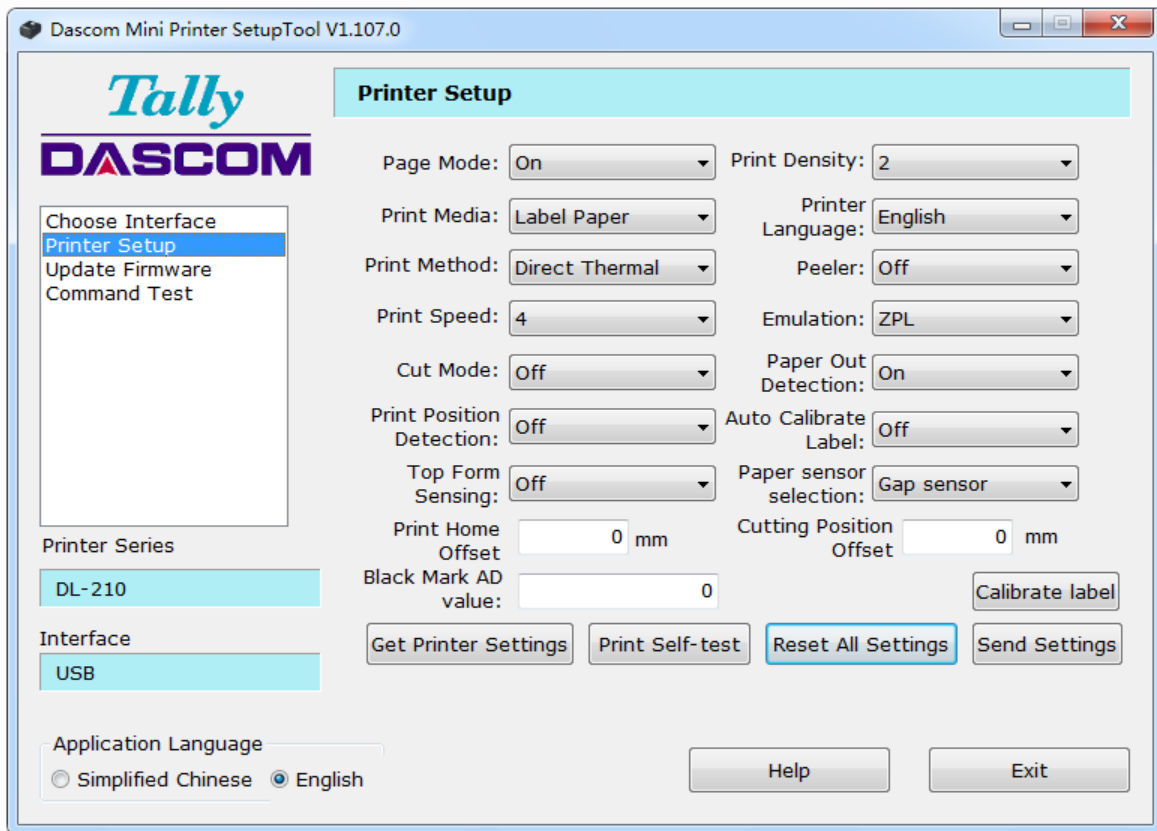

➤ Setup Items Explanation

Setup Items	Options	Default	Description
Page Mode	On, Off	On	Use un-continuous paper set to on; Use continuous paper set to off.
Print Density	1, 2, 3, 4, 5, 6	2	Adjust print density. Level 1 is lowest, Level 6 is highest.
Print Media	Label Paper, Continuous Paper	Label Paper	Select the actual media type.
Printer Language	English, Chinese	English	Set the printer’s system language, Chinese or English.
Print Method	Thermal Transfer, Direct Thermal	Thermal Transfer	Use ribbon select thermal transfer; Use thermal paper select direct thermal
Peeler	Off, On	Off	Enable peeler or not
Print Speed	1, 2, 3, 4	4	Adjust the print speed. Level 1 is lowest, Level 4 is highest.
Emulation	ESC/POS, ZPL, EPL	ZPL	Select ZPL/EPL while using un-continuous paper; Select ESC/POS while using continuous paper.
Cut Mode	Off, Full Cut, Partial Cut	Off	Set the printer’s cutting mode.
Paper Out Detection	On, Off	On	On: Detect the printer's paper is empty or not. Off: Disable paper end detection.

Print Position Detection	On, Off	Off	Enable print position detection or not
Auto Calibrate Label	On, Off	Off	On: It will auto calibrate the label when you use a different size/format of label. Off: Disable auto calibrate label
Top Form Sensing	On, Off	Off	Before the printer begins to detect the label length, it will feed and print based on the printing data so as to avoid unnecessary waste of media during length detection.
Paper Sensor Selection	Gap sensor, Reference sensor	Gap sensor	Choose between the gap sensor and the reference sensor.
Print Home Offset	User-defined	0	Set the vertical distance between print home position and the top of black mark. When the value is positive, the media moves inward towards the printer, and vice versa. Range: -5~+5 (mm)
Cutting position offset	User-defined	0	Set the vertical distance of the tearing position. When the value is positive, the media moves inward towards the printer, and vice versa. Range: -5~+5 (mm)
Black mark AD value	User-defined	0	Adjust the black mark detection accuracy.

➤ **Explanation for Buttons**

Button	Description
Get Printer Setting	When printer is powering on, click this button for acquiring the current setup menu. It will display on the screen.
Print Self-test	Click this button for printing current settings for the printer.
Restore All Setting	Click this button for restore to default setting.
Send Setting	Make the new settings effective.
Calibrate label	Click this button to calibrate label.



- After setting, the printer will beep once, then the setting become valid.
- In order to enhance print head lifetime, it is recommended that set the low print density if the printing quality is acceptable.

3.4 LAN Interface Setup

(1) Select Network interface in the setup tool. And then click “Setting”.

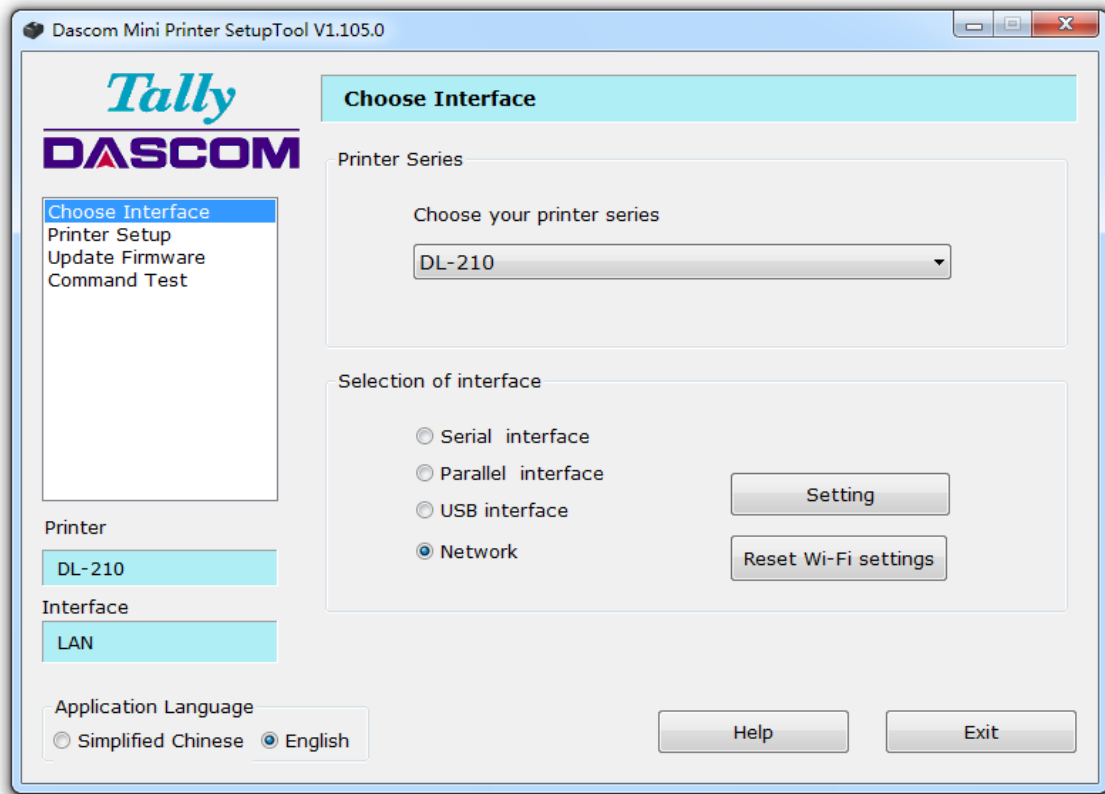

(2) Click “Setup Printer”.

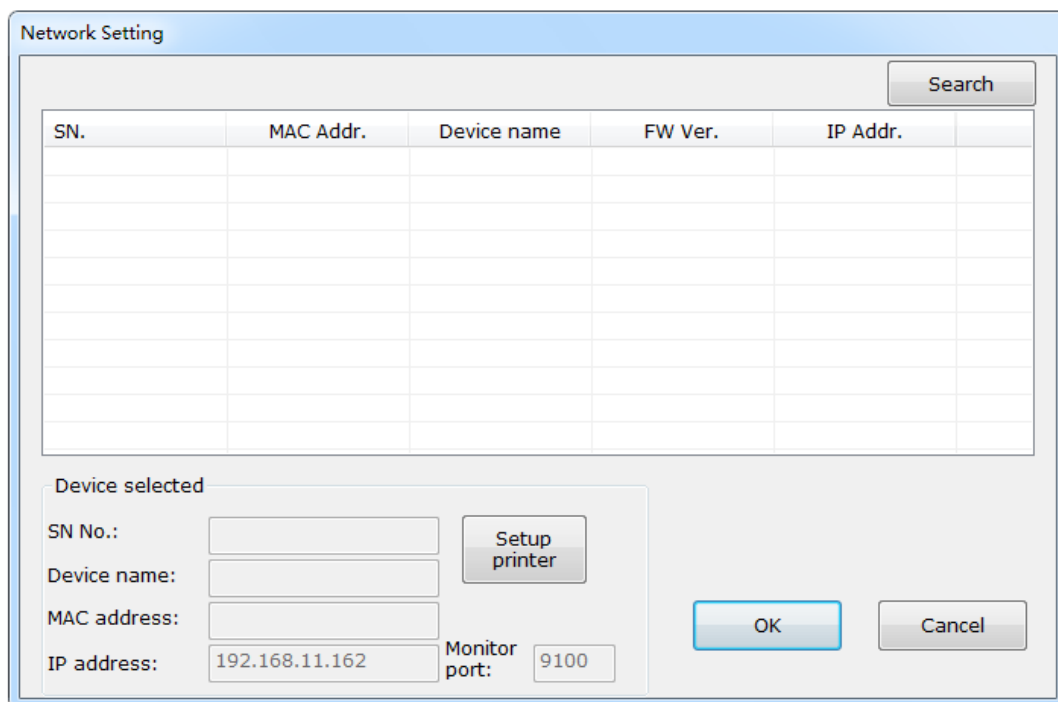

(3) You could change DHCP, IP address or other settings. And then enter OK.

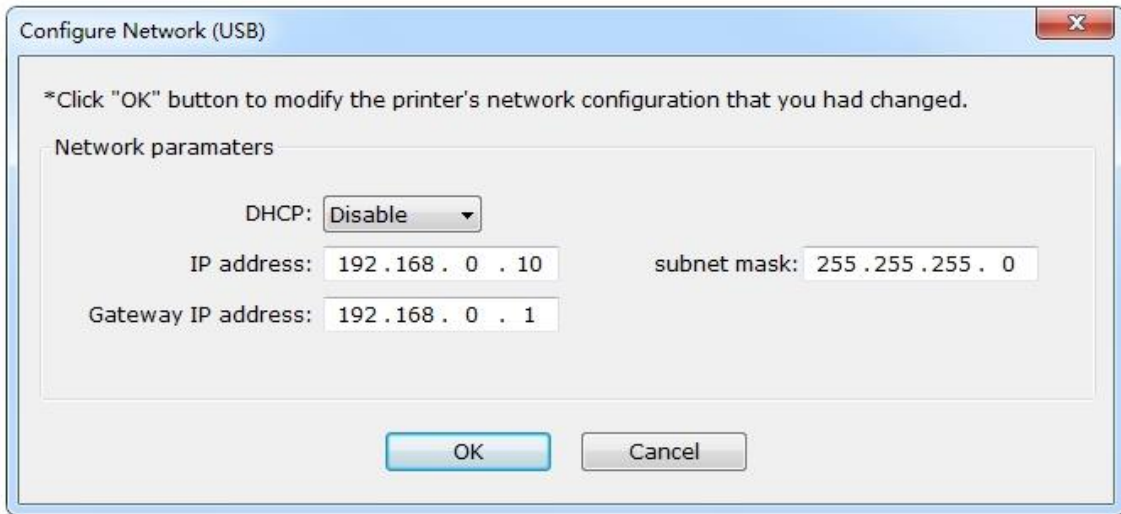

(4) At the end, click OK to implement the change.

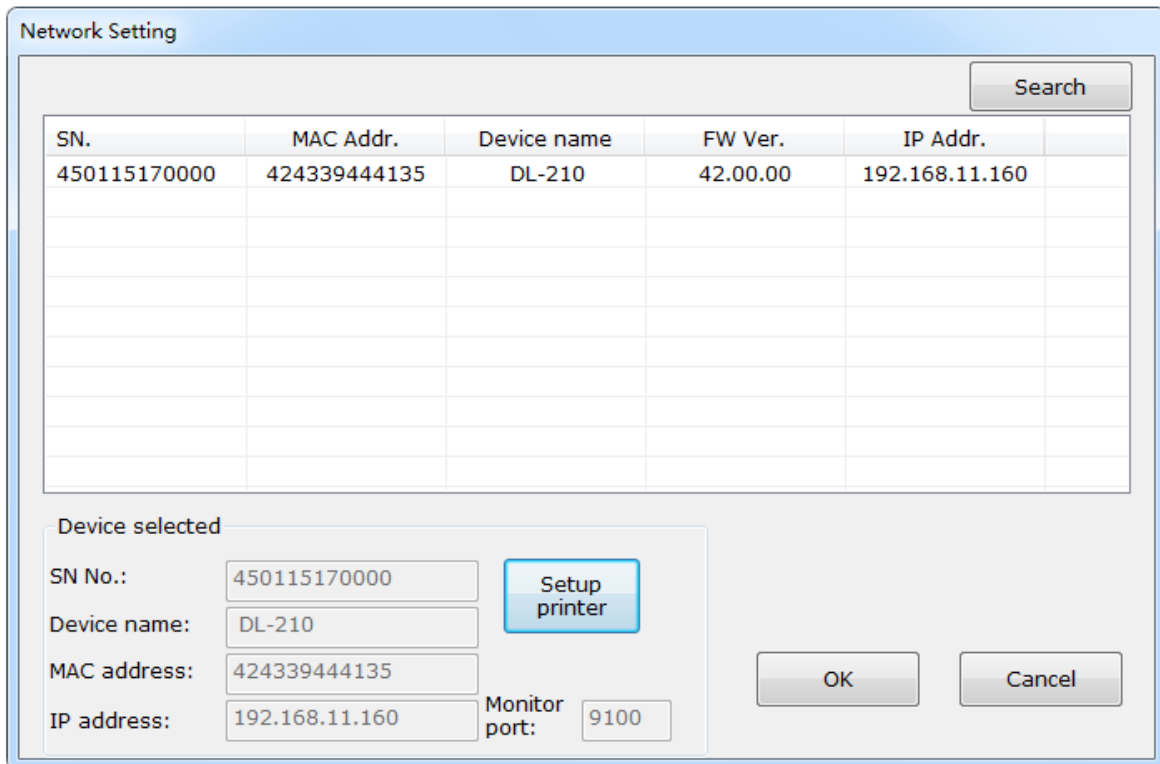

3.6 Update Firmware



Dascom is not liable if customers are doing a firmware update by themselves. If power is switched off during the process, the printer may be damaged afterwards.

(1) Preparation

USB cable, 24V power adapter, DL-210 setup tool, firmware file.

(2) Connection

Connect printer and host with USB cable firmly. Check the Device Manager, if connection is successful, “USB printing support” will display under “universal serial Bus Controllers” directory. Otherwise, please check the connection between printer and USB interface, please check whether the Driver installation is successful or not.

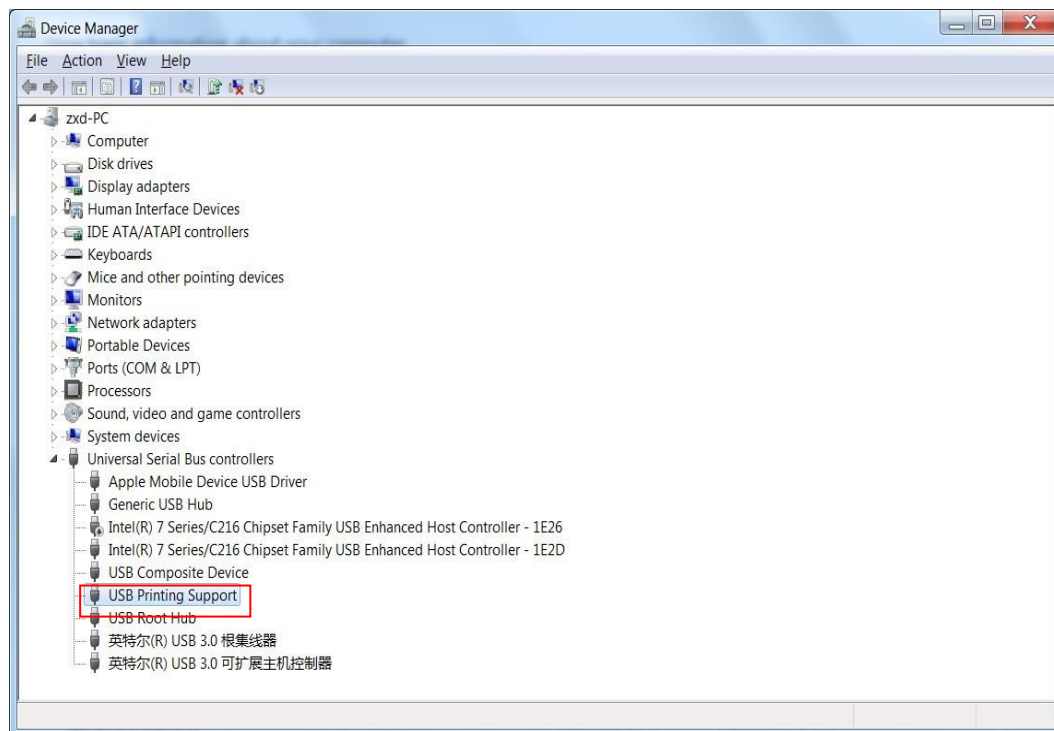

(3) Enter Update Mode

- ① Lift up top cover and turn up print head mechanism

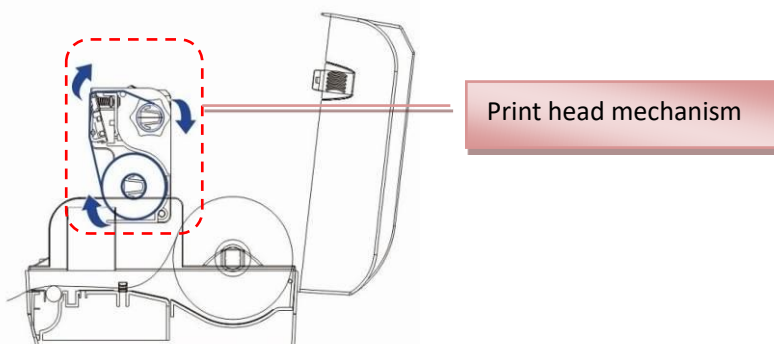

- ② Hold down Feed Key and switch on printer simultaneously. Release Feed Key once powering on, the printer will beep once.
- ③ Status LED on, printer enter upgrade mode.

(4) Upgrade Firmware

- ① Run Dascom setup tool, select model Label Printer and USB interface.
- ② Select “Update Firmware” tab, then click “Browse” to locate the firmware/CG file, and then click “Update”. May take about 20 seconds.

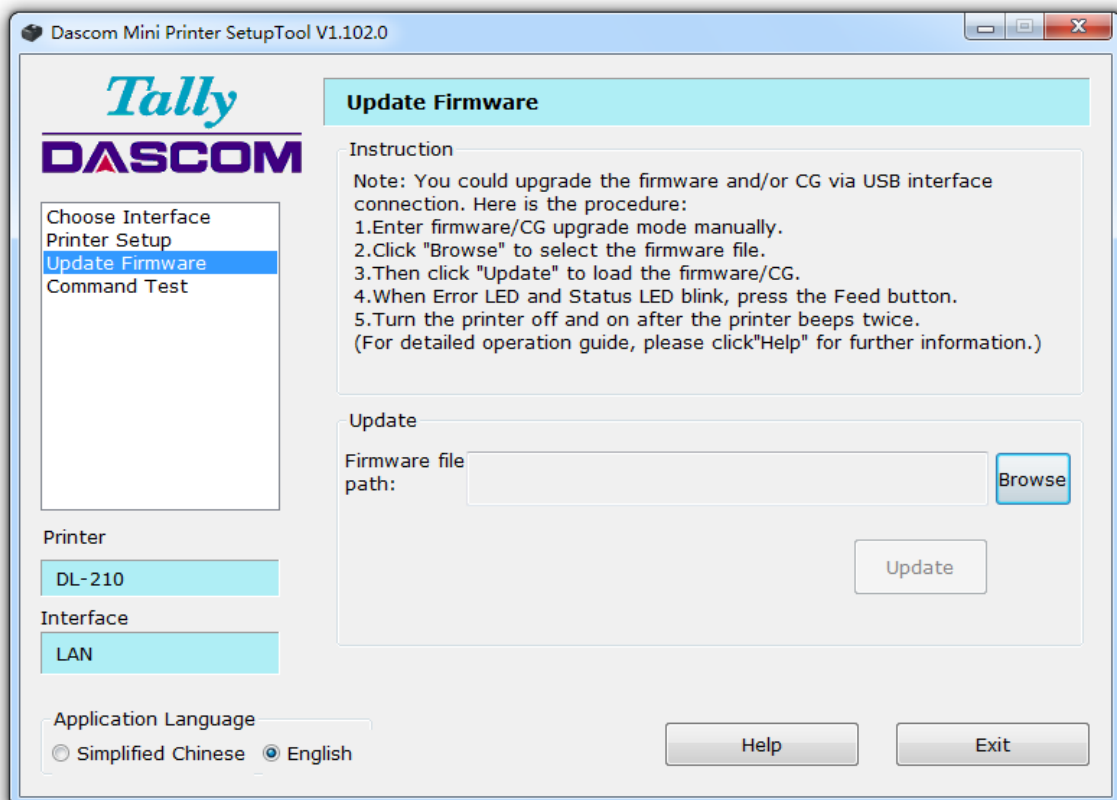

- ③ After loading the firmware, the Power LED, Error LED and Status LED blink.
- ④ When the printer beeps twice, and the three LEDs are on, turn the printer off.
- ⑤ Mission complete.

4 SETTING/CHECKING MODES

Besides the ordinary print mode, the printer has the following modes to set or to check settings of the printer.

- Self-test Mode
- Hexadecimal Dumping Mode

4.1 Print a Parameter Setting Page (Self-test Page)

Before you connect the printer to the computer, make sure that the printer is in proper working order.

You can do this by printing a configuration status label.

1. Make sure the media is properly loaded, the top cover of the printer is closed and the printer is power off. Then, press and hold the Feed button once you are ready.
2. Hold down Feed Key and then switch on printer till Power LED blinks once, buzzer beeps once.
3. The printer will print out a parameter setting page.

Here is the self-test status page and its explanation. The printout is an example. It may differ depending of installed options or interfaces:

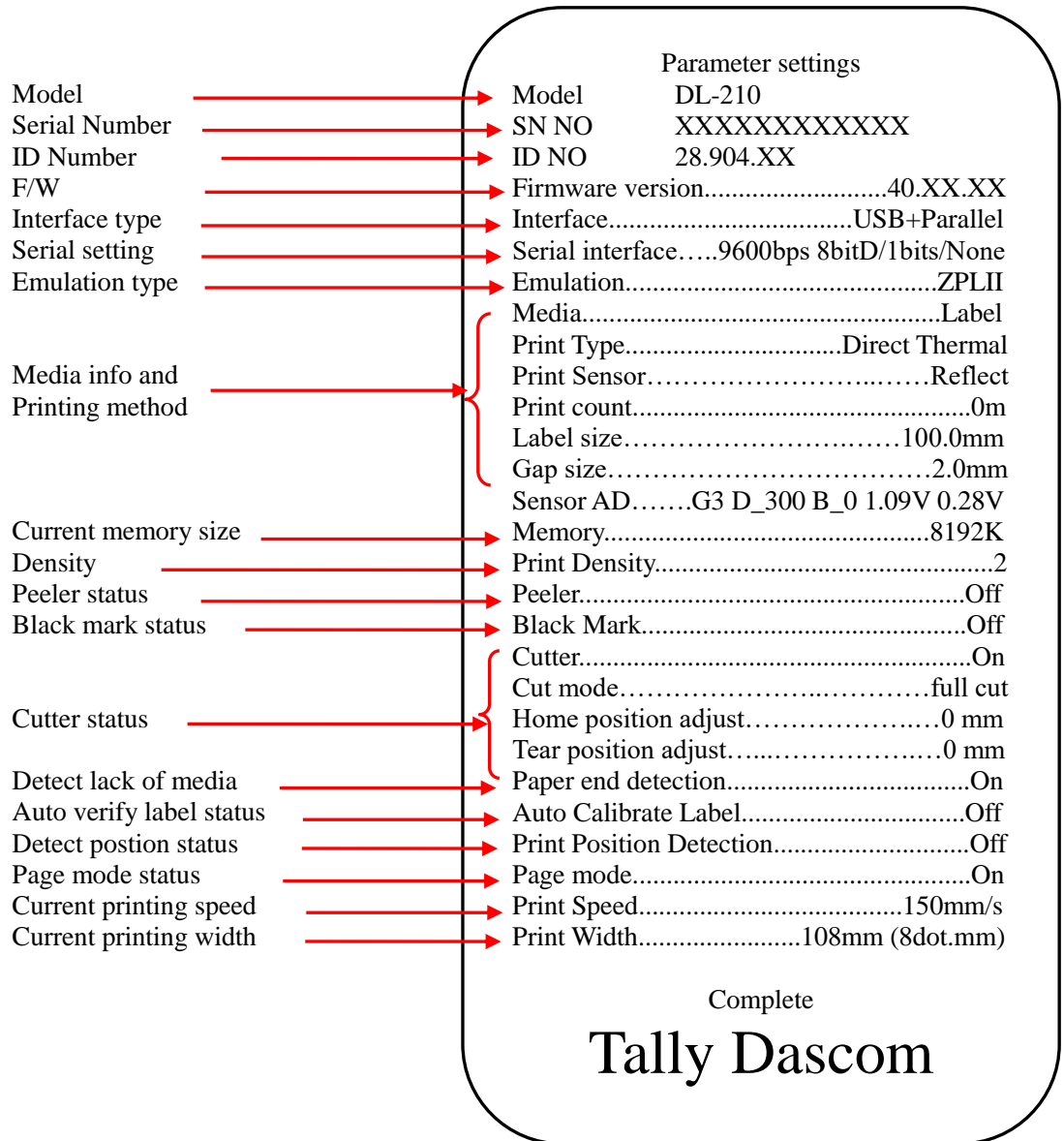

4.2 Hexadecimal Dumping Mode

Hold down Feed Key and switch on printer till Power LED blinks three times, buzzer beeps three times.

When self-test is OK but on-line printing error occurs, you can check the communication between PC and program via Hexadecimal Dump mode. In Hexadecimal Dump mode, the printer will print out hexadecimal data once it receives the signal from host. You can ask technical service for analysis.

The printer starts printing "HEX DUMP PRINT MODE" followed by the received data printed in hexadecimal numbers and some characters.

CAUTION!



- The printer prints "." if there is no characters corresponding to data.
 - During hexadecimal dump, functions except some command will be disabled.
 - If print data does not cover a line, press the FEED switch to print the line.
-

Printing example:

0123456789abcdefghijklmnopqrstuvwxyzABCDEFGHIJKLMNOPQRSTUVWXYZ

```
Hexadecimal Dump
To terminate hexadecimal dump,
press FEED button.

30 31 32 33 34 35 36 37 38 39 61 62 63 64 65 66:0123456789abcdef
67 68 69 6A 6B 6C 6D 6E 6F 70 71 72 73 74 75 76:ghijklmnopqrstuv
77 78 79 7A 41 42 43 44 45 46 47 48 49 4A 4B 4C:xyzABCDEFGHIJKL

4D 4E 4F 50 51 52 53 54 55 56 57 58 59 5A      :MNOPQRSTUVWXYZ

*** Completed ***
```

Press the FEED button one time to feed the last line after the printer stops printing so as to return to the normal mode.

4.3 Auto Calibrate Label

DL-210 can calibrate label automatically. Hold down Feed Key and switch on printer till Power LED blinks twice, buzzer beeps twice.

Label calibration should be executed in the following situations:



- Use printer for printing label first time.
 - Replace different size of labels.
 - Printer skips labels
 - Printer feeds blank labels.
 - Refill with new roll of labels.
-

5 TROUBLESHOOTING AND MAINTENANCE

Your printer is extremely reliable, but occasionally problems may occur. This chapter provides information on some of the common problems you may encounter and how you may solve them. If you encounter problems that you cannot resolve, please contact your dealer for assistance.

Read the following instructions before maintenance and avoid incorrect operation, so as to prevent injury to you and damage to the printer.

5.1 Common Issues

- LED Indication and Buzzer Alarm

Condition	Possible Cause	What to do?
No LEDs on	Unplug power cord	Check power cord and plug it properly
	Turn off printer	Turn on printer
	PCB damaged	Contact service representatives
	Power source unavailable	Check the cable and adapter, or change another cable or/and adapter.
	Shut down	Check the cable and adapter, or change another cable or/and adapter.
Status LED always on	Media end	Re-load media
Error LED always on	Print head mechanism open	Close the print head mechanism
Status LED blinks	Label remains in peeler	Remove label
	Ribbon end	Replace ribbon
Error LED blinks and buzzer alarms	Thermal print head overheated	Turn the printer off and wait some minutes before resume
	Over-voltage	Print with specified voltage
	Low-voltage	Print with specified voltage
Power LED and Error LED fast blink three time, buzzer alarms three times	Gap sensor error alarm. The black mark sensor does not align with the receiving sensor, that it, two triangles do not align.	Move around the black mark sensor, so that the its triangle aligns with another on the center housing.
Press feed button after power on, Error LED slowly blinks once and then fast blinks three times; buzzer alarms four times	Cutter error alarm. Enable cutter function but without cutter installation.	Disable the cutter in the tool.
Error LED fast blinks	Gap detection error.	1. Use continuous paper but set label in the tool. Change to "label paper" in the tool.
		2. Due to sensor error or other problems, the sensor could not detect the gap. Clean or/and adjust the media sensor.

- **Printing Error**

Condition	Possible Cause	What to do?
Blurred or spot printing	Incorrect media roll installation	Check media roll and re-load it properly
	Media is out of specification	Use recommended media
	Dirty thermal print head or platen	Clean print head or platen
	Ribbon is out of specification	Use recommended ribbon
	Low print density	Increase the print density (heat)
	Print with Ribbon on Direct Thermal paper	Remove ribbon
Self-test fail	Hardware problem	Contact service representatives
Media jam	Label stuck	Check media path and clean jammed label, refer to Chapter 5 Section 5.3
Printer skips labels	Label positioning problem or label size setting exceeds the physical size.	Execute label calibration (refer to Chapter 4 section 4.3).If it doesn't work, you have to verify the label size setting is correct or not.
Printer feeds blank labels	Print without ribbon on transfer thermal paper	Install ribbon
Paper size setting correct but the printout is crooked, skewed, or off-center.	Label did not calibrate correctly	Execute label calibration (refer to Chapter 4 section 4.3).

5.2 Resetting the Factory Default Values

Sometimes, resetting the printer to the factory defaults may solve some problems.

There are two methods to set to factory setting:

Method one: Hold down Feed Key and switch on printer till Power LED blinks four times, buzzer beeps four times.

Method two: through setup tool, choose restore all setting on printer setup page.

5.3 Removing Jammed Label



Printhead may be hot, please do not touch!

- (1) Turn printer off, open top cover and turn up print head mechanism.
- (2) Remove the jammed label and ribbon, clean the print head with a cotton swab with alcohol in case of ribbon paste on print head and cause poor print quality.
- (3) Reload media.
- (4) Reload ribbon and turn the ribbon adjustor for rewinding the sticky part.

5.4 Cleaning Thermal Print Head



- After printing, the print head becomes very hot. Be careful not to touch it and to let it cool before you clean it.
 - Do not damage the print head by touching it with your fingers or any hard object.
-
- Turn off the printer, open the top cover and remove ribbon, clean the thermal elements of the print head with a cotton swab moistened with alcohol solvent (ethanol, methanol, or isopropyl).
 - Be gentle with the cleaning so as not to damage the printhead.
 - We recommend cleaning the thermal print head periodically (generally every 3 months) to maintain print quality.

5.5 Maintenance

DL-210 is designed for a long and reliable lifetime. But periodic maintenance is recommended in order to assure error free working. This also would guarantee the good print quality over the life time. It is recommended to clean the printer once every six months or after 300 hours duty. Before cleaning, switch off the printer, wait a few seconds and unplug the power cord.

- Open the cover and remove the dust, paper shreds and other debris from inside by using a soft vacuum cleaner or a brush.
- In order to remove the dirt, you can wipe clean the machine with a soft cloth dipped in alcohol instead of the ketone or TEC solvent which may cause damage to the plastic parts. Please be aware that excessive moisture will lead to the improper functioning of electronic parts.
- Clean the platen roller with soft cloth.

While you are cleaning the printer, in order to avoid short circuit, do not damage or loose the cable or electronic parts, do not drop metal material inside, such as Paper Clips or Pins.

6 COMMUNICATION INTERFACES SPECIFICATIONS

6.1 USB interface

- **USB interface pin assignment**

PIN No.	Description	Classic wire color
1	VBUS	Red
2	D-	White
3	D+	Green
4	GND	Black

- **USB interface connector diagram**

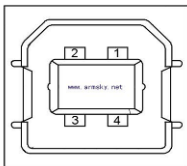

6.3 Bluetooth Interface

Bluetooth version: Standard BT2.1+EDR

Communication protocol: SPP

Radio frequency: 2.4GHz

Transmission distance: 10m

6.4 Ethernet interface

- **Ethernet interface pin assignment**

Pin. No.	Name	Description
1	TX+	Tranceive Data+
2	TX-	Tranceive Data-
3	RX+	Receive Data+
4	n/c	Not connected
5	n/c	Not connected
6	RX-	Receive Data-
7	n/c	Not connected
8	n/c	Not connected

- Ethernet interface connector diagram

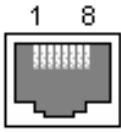

6.5 Serial interface

- Serial interface pin assignment

Serial interface compatible with RS-232 standard, with 25 pin (D hole type) socket.

PIN No.	Description
PIN 1	Frame Ground
PIN 2	TXD
PIN 3	RXD
PIN 4	RTS
PIN 5	Unconnected
PIN 6	DSR
PIN 7	Signal Ground
PIN 8~19	Unconnected
PIN 20	DTR
PIN 21~25	Unconnected

User can view the setting of interface via printing configuration sample.

The default setting of serial interface is as follow, 38400 bps (baud rates), 8 bit (data bit), 1 bit (stop bit), no parity, support RTS/CTS handshaking protocol.

- Serial interface connector diagram

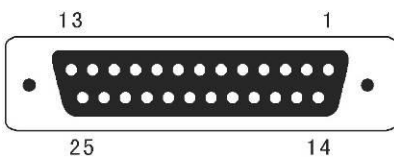

6.6 Parallel interface

- Parallel interface pin assignment

Parallel interface with 36 pin CENTRONICS socket.

Pin No.	Signal From	Description
1	H	Strobe Signal; Data latch pulse, latch the data to the printer at the rising edge of the negative pulse.
2	H	Data 0 (The lowest bit)
3	H	Data 1
4	H	Data 2
5	H	Data 3
6	H	Data 4
7	H	Data 5
8	H	Data 6
9	H	Data 7 (The highest bit)
10	P	ACK Signal; Printer response signal, indicates that the printer has received a Data byte.
11	P	Busy Signal; The printer is busy; High level indicates that the printer can't receive data.
12	P	PE Signal; Paper end signal; High level indicates that the printer is out of paper.
13	—	Unconnected
14	—	Unconnected
15	—	Unconnected
16	Logic Ground	
17	Frame Ground, separated from logic ground.	
18	—	5V/500mA power output
19~30	Logic Ground	
31	—	Initialization signal
32	P	Printer error signal. Low level indicates that an error occurs in the printer. It will come with paper end.
33	Logic Ground	
34~35	—	Unconnected
36	Unconnected	

Remarks:

H indicates that signal comes from Host computer; P indicates that signal comes from Printer.

- Parallel interface connector diagram

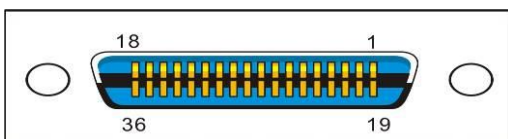

6.7 Power Supply

(1) Power adapter

Input: AC 100V-240V~ 1.5A 50-60Hz

Output: DC 24V \pm 5%, 2.1A, A-1009-3P interface

(2) Power Supply connector diagram

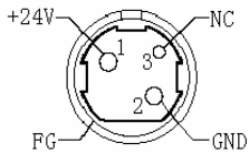

(3) Power Socket pin assignment

Pin Number	Signal Name
1	+24 V
2	GND
3	N.C
SHELL	F.G.

(4) Power Supply interface type

Printer - Unetop DC-002 or similar products

Computer - Unetop DP-002 or similar products

7 CHARACTER CODE PAGES



- The character code tables show only character configurations. They do not show the actual print pattern.
- “SP” in the table shows a space.

7.1 Common to all pages (International Character Set: USA)

HEX	0	1	2	3	4	5	6	7
0	NUL 00	DLE 16	SP 32	0 48	@ 64	P 80	` 96	p 112
1		XON 17	! 33	1 49	A 65	Q 81	a 97	q 113
2			“ 34	2 50	B 66	R 82	b 98	R 114
3		XOFF 19	# 35	3 51	C 67	S 83	c 99	s 115
4	EOT 04	DC4 20	\$ 36	4 52	D 68	T 84	d 100	t 116
5	ENQ 05	NAK 21	% 37	5 53	E 69	U 85	e 101	u 117
6	ACK 06		& 38	6 54	F 70	V 86	f 102	V 118
7		CAN 23	' 39	7 55	G 71	W 87	g 103	w 119
8			(40	8 56	H 72	X 88	h 104	x 120
9	HT 09) 41	9 57	I 73	Y 89	i 105	y 121
A	LF 10		* 42	: 58	J 74	Z 90	j 106	Z 122
B		ESC 27	+ 43	; 59	K 75	[91	k 107	{ 123
C	FF 12	FS 28	, 44	< 60	L 76	\ 92	l 108	 124
D	CR 13	GS 29	- 45	= 61	M 77] 93	m 109	} 125
E		RS 30	. 46	> 62	N 78	^ 94	n 110	~ 126
F			/ 47	? 63	O 79	_ 95	o 111	SP 127

7.2 International Character Sets

Country	ASCII code (Hex)											
	23	24	40	5B	5C	5D	5E	60	7B	7C	7D	7E
USA	#	\$	@	[\]	^	`	{		}	~
France	#	\$	à	°	ç	§	^	`	é	ù	è	¨
Germany	#	\$	§	Ä	Ö	Ü	^	`	ä	ö	ü	ß
U.K.	£	\$	@	[\]	^	`	{		}	~
Denmark I	#	\$	@	Æ	Ø	Å	^	`	æ	ø	å	~
Sweden	#	¤	É	Ä	Ö	Å	Ü	é	ä	ö	å	ü
Italy	#	\$	@	°	\	é	^	ù	à	ò	è	ì
Spain I	Pt	\$	@	i	Ñ	¿	^	`	¨	ñ	}	~
Japan	#	\$	@	[¥]	^	`	{		}	~
Norway	#	¤	É	Æ	Ø	Å	Ü	é	æ	ø	å	ü
Denmark II	#	\$	É	Æ	Ø	Å	Ü	é	æ	ø	å	ü
Spain II	#	\$	á	i	Ñ	¿	é	`	í	ñ	ó	ú
Latin America	#	\$	á	i	Ñ	¿	é	ü	í	ñ	ó	ú
Korea	#	\$	@	[₩]	^	`	{		}	~
Slovenia/ Croatia	#	\$	Ž	Š	Đ	Ć	Č	ž	š	đ	ć	č
China	#	¥	@	[\]	^	`	{		}	~

7.3 [User-defined page]

HEX	8	9	A	B	C	D	E	F
0	SP 128	SP 144	SP 160	SP 176	SP 192	SP 208	SP 224	SP 240
1	SP 129	SP 145	SP 161	SP 177	SP 193	SP 209	SP 225	SP 241
2	SP 130	SP 146	SP 162	SP 178	SP 194	SP 210	SP 226	SP 242
3	SP 131	SP 147	SP 163	SP 179	SP 195	SP 211	SP 227	SP 243
4	SP 132	SP 148	SP 164	SP 180	SP 196	SP 212	SP 228	SP 244
5	SP 133	SP 149	SP 165	SP 181	SP 197	SP 213	SP 229	SP 245
6	SP 134	SP 150	SP 166	SP 182	SP 198	SP 214	SP 230	SP 246
7	SP 135	SP 151	SP 167	SP 183	SP 199	SP 215	SP 231	SP 247
8	SP 136	SP 152	SP 168	SP 184	SP 200	SP 216	SP 232	SP 248
9	SP 137	SP 153	SP 169	SP 185	SP 201	SP 217	SP 233	SP 249
A	SP 138	SP 154	SP 170	SP 186	SP 202	SP 218	SP 234	SP 250
B	SP 139	SP 155	SP 171	SP 187	SP 203	SP 219	SP 235	SP 251
C	SP 140	SP 156	SP 172	SP 188	SP 204	SP 220	SP 236	SP 252
D	SP 141	SP 157	SP 173	SP 189	SP 205	SP 221	SP 237	SP 253
E	SP 142	SP 158	SP 174	SP 190	SP 206	SP 222	SP 238	SP 254
F	SP 143	SP 159	SP 175	SP 191	SP 207	SP 223	SP 239	SP 255

7.4 [PC437: USA, Standard Europe]

HEX	8	9	A	B	C	D	E	F
0	Ç 128	É 144	á 160	☐ 176	Ł 192	⏏ 208	α 224	≡ 240
1	ü 129	æ 145	í 161	☐ 177	⌞ 193	⏏ 209	β 225	± 241
2	é 130	Æ 146	ó 162	☐ 178	⌞ 194	π 210	Γ 226	≥ 242
3	â 131	ô 147	ú 163	 179	⌞ 195	⏏ 211	π 227	≤ 243
4	ä 132	ö 148	ñ 164	⌞ 180	— 196	⏏ 212	Σ 228	 244
5	à 133	ò 149	Ñ 165	⌞ 181	† 197	ƒ 213	σ 229	∫ 245
6	â 134	û 150	ä 166	⏏ 182	ƒ 198	π 214	μ 230	÷ 246
7	ç 135	ù 151	œ 167	π 183	⏏ 199	⏏ 215	τ 231	≈ 247
8	ê 136	ÿ 152	ç 168	⌞ 184	⏏ 200	⏏ 216	Φ 232	° 248
9	ë 137	Ö 153	Γ 169	⏏ 185	⏏ 201	⏏ 217	Θ 233	• 249
A	è 138	Ü 154	⌞ 170	⏏ 186	⏏ 202	Γ 218	Ω 234	• 250
B	ï 139	ø 155	½ 171	⏏ 187	⏏ 203	☐ 219	δ 235	√ 251
C	î 140	£ 156	¼ 172	⏏ 188	⏏ 204	☐ 220	∞ 236	n 252
D	ì 141	¥ 157	ı 173	⏏ 189	= 205	☐ 221	Φ 237	² 253
E	Ä 142	Pt 158	« 174	⏏ 190	⏏ 206	☐ 222	ε 238	■ 254
F	Å 143	f 159	» 175	⌞ 191	⏏ 207	☐ 223	∩ 239	SP 255

7.5 [PC850: Multilingual]

HEX	8	9	A	B	C	D	E	F
0	Ç 128	É 144	á 160	⌘ 176	Ł 192	ð 208	Ó 224	- 240
1	ü 129	æ 145	í 161	⌘ 177	ł 193	Ð 209	β 225	± 241
2	é 130	Æ 146	ó 162	⌘ 178	Ṭ 194	Ê 210	Ô 226	= 242
3	â 131	ô 147	ú 163	 179	ƒ 195	Ë 211	Ò 227	¾ 243
4	ä 132	ö 148	ñ 164	† 180	- 196	È 212	õ 228	¶ 244
5	à 133	ò 149	Ñ 165	Á 181	† 197	ı 213	Õ 229	§ 245
6	â 134	û 150	ä 166	Â 182	ã 198	Í 214	μ 230	÷ 246
7	ç 135	ù 151	ę 167	À 183	Ã 199	Î 215	þ 231	˙ 247
8	ê 136	ÿ 152	ı 168	© 184	Ł 200	Ï 216	ƒ 232	° 248
9	ë 137	Ö 153	® 169	‡ 185	ƒ 201	Ĵ 217	Ú 233	“ 249
A	è 138	Ü 154	¬ 170	 186	Ł 202	ŕ 218	Û 234	• 250
B	ï 139	ø 155	½ 171	¶ 187	ƒ 203	■ 219	Ù 235	¹ 251
C	î 140	£ 156	¼ 172	¶ 188	ƒ 204	■ 220	ý 236	³ 252
D	ì 141	Ø 157	ı 173	¢ 189	= 205	ı 221	Ý 237	² 253
E	Ä 142	× 158	« 174	¥ 190	‡ 206	İ 222	- 238	■ 254
F	Å 143	f 159	» 175	ƒ 191	α 207	■ 223	' 239	SP 255

7.6 [PC852: Latin2]

HEX	8	9	A	B	C	D	E	F
0	Ç 128	É 144	á 160	⋯ 176	Ł 192	đ 208	Ó 224	- 240
1	ü 129	Í 145	í 161	⋮ 177	Ł̄ 193	Đ 209	β 225	“ 241
2	é 130	Í 146	ó 162	⋮ 178	Ƨ 194	Ǿ 210	Ô 226	‘ 242
3	â 131	ô 147	ú 163	 179	Ƨ̄ 195	Ě 211	Ń 227	ˇ 243
4	ä 132	ö 148	Ą 164	† 180	– 196	ď 212	ń 228	˘ 244
5	û 133	Ĺ 149	ą 165	Á 181	† 197	Ň 213	ň 229	§ 245
6	ć 134	Ĳ 150	ż 166	Â 182	Ǻ 198	Í 214	Š 230	÷ 246
7	ç 135	Ś 151	ż 167	Ě 183	ǻ 199	Î 215	š 231	˙ 247
8	ł 136	ś 152	Ę 168	Ş 184	Ł̄ 200	ě 216	Ŕ 232	° 248
9	ë 137	Ö 153	ę 169	Ƨ̄ 185	Ƨ̄ 201	Ƨ̄ 217	Ú 233	“ 249
A	Ö 138	Ü 154	SP 170	 186	Ł̄ 202	Ƨ̄ 218	ř 234	• 250
B	ő 139	ť 155	ż 171	Ƨ̄ 187	Ƨ̄ 203	■ 219	Ů 235	ů 251
C	î 140	ť 156	č 172	Ƨ̄ 188	Ƨ̄ 204	■ 220	ý 236	Ř 252
D	ž 141	ł 157	ş 173	Ž 189	= 205	Ƨ̄ 221	Ý 237	ř 253
E	Ä 142	x 158	« 174	ž 190	Ƨ̄ 206	Ů 222	ţ 238	■ 254
F	Ć 143	č 159	» 175	Ƨ̄ 191	α 207	■ 223	’ 239	SP 255

7.7 [PC858: Euro]

HEX	8	9	A	B	C	D	E	F
0	Ç 128	É 144	á 160	☐ 176	Ł 192	ö 208	Ó 224	- 240
1	ü 129	æ 145	í 161	☐ 177	ł 193	Ð 209	β 225	± 241
2	é 130	Æ 146	ó 162	☐ 178	ṽ 194	Ê 210	Ô 226	= 242
3	â 131	ô 147	ú 163	 179	ƒ 195	Ë 211	Ò 227	¾ 243
4	ä 132	ö 148	ñ 164	† 180	- 196	È 212	õ 228	¶ 244
5	à 133	ò 149	Ñ 165	Á 181	† 197	€ 213	Õ 229	§ 245
6	â 134	û 150	ä 166	Â 182	ã 198	Í 214	μ 230	÷ 246
7	ç 135	ù 151	ä 167	À 183	Ã 199	Î 215	þ 231	· 247
8	ê 136	ÿ 152	ı 168	© 184	ℒ 200	Ï 216	þ 232	° 248
9	ë 137	Ö 153	® 169	¶ 185	ƒ 201	Ɔ 217	Ú 233	“ 249
A	è 138	Ü 154	¬ 170	 186	ℒ 202	ƒ 218	Û 234	• 250
B	ï 139	ø 155	½ 171	¶ 187	ƒ 203	■ 219	Ü 235	¹ 251
C	î 140	£ 156	¼ 172	¶ 188	ƒ 204	■ 220	Ý 236	³ 252
D	ì 141	Ø 157	ı 173	¢ 189	= 205	ı 221	Ý 237	² 253
E	Ä 142	× 158	« 174	¥ 190	ƒ 206	İ 222	- 238	■ 254
F	Å 143	f 159	» 175	ƒ 191	α 207	■ 223	' 239	SP 255



7.8 [PC860: Portuguese]

HEX	8	9	A	B	C	D	E	F
0	Ç 128	É 144	á 160	☐ 176	Ł 192	⏏ 208	α 224	≡ 240
1	ü 129	À 145	í 161	☐ 177	⌞ 193	⏏ 209	β 225	± 241
2	é 130	È 146	ó 162	☐ 178	⌞ 194	π 210	Γ 226	≥ 242
3	â 131	ô 147	ú 163	 179	⏏ 195	⏏ 211	π 227	≤ 243
4	ã 132	õ 148	ñ 164	⏏ 180	— 196	⏏ 212	Σ 228	 244
5	à 133	ò 149	Ñ 165	⏏ 181	† 197	F 213	σ 229	∫ 245
6	Á 134	Ú 150	ã 166	⏏ 182	⏏ 198	π 214	μ 230	÷ 246
7	ç 135	ù 151	◌ 167	π 183	⏏ 199	⏏ 215	τ 231	≈ 247
8	ê 136	Ï 152	ç 168	⏏ 184	⏏ 200	⏏ 216	Φ 232	° 248
9	Ê 137	Õ 153	Ò 169	⏏ 185	⏏ 201	⏏ 217	Θ 233	• 249
A	è 138	Ü 154	¬ 170	⏏ 186	⏏ 202	⏏ 218	Ω 234	• 250
B	Í 139	ç 155	½ 171	⏏ 187	⏏ 203	■ 219	δ 235	√ 251
C	Ô 140	£ 156	¼ 172	⏏ 188	⏏ 204	■ 220	∞ 236	n 252
D	ì 141	Ù 157	ì 173	⏏ 189	= 205	■ 221	Φ 237	² 253
E	Ã 142	Pt 158	« 174	⏏ 190	⏏ 206	■ 222	ε 238	■ 254
F	Ä 143	Ó 159	» 175	⏏ 191	⏏ 207	■ 223	∩ 239	SP 255

7.9 [PC863: Canadian-French]

HEX	8	9	A	B	C	D	E	F
0	Ç 128	É 144	ı 160	⋮ 176	Ł 192	⋮ 208	α 224	≡ 240
1	ü 129	È 145	´ 161	⋮ 177	⊥ 193	⌈ 209	β 225	± 241
2	é 130	Ê 146	ó 162	⋮ 178	⌈ 194	π 210	Γ 226	≥ 242
3	â 131	ô 147	ú 163	 179	⌈ 195	⋮ 211	π 227	≤ 243
4	Â 132	Ë 148	¨ 164	⌈ 180	— 196	⌈ 212	Σ 228	 244
5	à 133	Ï 149	¸ 165	⌈ 181	† 197	ƒ 213	σ 229	∫ 245
6	¶ 134	û 150	³ 166	⌈ 182	ƒ 198	π 214	μ 230	÷ 246
7	ç 135	ù 151	˘ 167	π 183	⌈ 199	⌈ 215	τ 231	≈ 247
8	ê 136	α 152	Î 168	⌈ 184	⋮ 200	⌈ 216	Φ 232	° 248
9	ë 137	Ô 153	Г 169	⌈ 185	ƒ 201	∫ 217	Θ 233	• 249
A	è 138	Ü 154	¬ 170	⋮ 186	⋮ 202	Г 218	Ω 234	· 250
B	ï 139	ø 155	½ 171	⌈ 187	⌈ 203	■ 219	δ 235	√ 251
C	î 140	£ 156	¼ 172	⌈ 188	⌈ 204	■ 220	∞ 236	n 252
D	= 141	Ù 157	¾ 173	⌈ 189	= 205	■ 221	Φ 237	² 253
E	À 142	Û 158	« 174	⌈ 190	⌈ 206	■ 222	ε 238	■ 254
F	§ 143	f 159	» 175	⌈ 191	⌈ 207	■ 223	∩ 239	SP 255

7.10 [PC865: Nordic]

HEX	8	9	A	B	C	D	E	F
0	Ç 128	É 144	á 160	 176	Ł 192	Ⓔ 208	α 224	≡ 240
1	ü 129	æ 145	í 161	 177	⊥ 193	⏚ 209	β 225	± 241
2	é 130	Æ 146	ó 162	 178	⏚ 194	π 210	Γ 226	≥ 242
3	â 131	ô 147	ú 163	 179	⏚ 195	Ⓔ 211	π 227	≤ 243
4	ä 132	ö 148	ñ 164	⏚ 180	— 196	Ⓔ 212	Σ 228	∫ 244
5	à 133	ò 149	Ñ 165	⏚ 181	⏚ 197	Ⓔ 213	σ 229	∫ 245
6	â 134	û 150	ä 166	⏚ 182	⏚ 198	π 214	μ 230	÷ 246
7	ç 135	ù 151	º 167	π 183	⏚ 199	⏚ 215	τ 231	≈ 247
8	ê 136	ÿ 152	¿ 168	⏚ 184	Ⓔ 200	⏚ 216	Φ 232	° 248
9	ë 137	Ö 153	Г 169	⏚ 185	⏚ 201	⏚ 217	Θ 233	• 249
A	è 138	Ü 154	Г 170	⏚ 186	⏚ 202	⏚ 218	Ω 234	• 250
B	ï 139	ø 155	½ 171	⏚ 187	⏚ 203	■ 219	δ 235	√ 251
C	î 140	£ 156	¼ 172	⏚ 188	⏚ 204	■ 220	∞ 236	ⁿ 252
D	ì 141	Ø 157	í 173	⏚ 189	= 205	■ 221	Φ 237	² 253
E	Ä 142	Pt 158	« 174	⏚ 190	⏚ 206	■ 222	ε 238	■ 254
F	Å 143	f 159	¤ 175	⏚ 191	⏚ 207	■ 223	∩ 239	SP 255

7.11 [PC866: Cyrillic #2]

HEX	8	9	A	B	C	D	E	F
0	А 128	Р 144	а 160	▒ 176	Л 192	л 208	р 224	Ё 240
1	Б 129	С 145	б 161	▒ 177	Л 193	л 209	с 225	ё 241
2	В 130	Т 146	в 162	▒ 178	Т 194	т 210	т 226	Є 242
3	Г 131	У 147	г 163	 179	Г 195	Г 211	у 227	є 243
4	Д 132	Ф 148	д 164	Г 180	— 196	Г 212	ф 228	ї 244
5	Е 133	Х 149	е 165	Г 181	Г 197	Г 213	х 229	і 245
6	Ж 134	Ц 150	ж 166	Г 182	Г 198	Г 214	ц 230	ÿ 246
7	З 135	Ч 151	з 167	Г 183	Г 199	Г 215	ч 231	ÿ 247
8	И 136	Ш 152	и 168	Г 184	Г 200	Г 216	ш 232	° 248
9	Й 137	Щ 153	й 169	Г 185	Г 201	Г 217	щ 233	• 249
A	К 138	Ъ 154	к 170	Г 186	Г 202	Г 218	ъ 234	• 250
B	Л 139	Ы 155	л 171	Г 187	Г 203	■ 219	ы 235	√ 251
C	М 140	Ь 156	м 172	Г 188	Г 204	■ 220	ь 236	№ 252
D	Н 141	Э 157	н 173	Г 189	= 205	■ 221	э 237	¤ 253
E	О 142	Ю 158	о 174	Г 190	Г 206	■ 222	ю 238	■ 254
F	П 143	Я 159	п 175	Г 191	Г 207	■ 223	я 239	SP 255

7.12 [PC720: Arabic]

HEX	8	9	A	B	C	D	E	F
0	SP 128	SP 144	ب 160	ٲ 176	ل 192	ل 208	ض 224	≡ 240
1	SP 129	ء 145	ة 161	ٲ 177	ل 193	ٲ 209	ط 225	ٲ 241
2	é 130	° 146	ت 162	ٲ 178	ٲ 194	ٲ 210	ظ 226	ٲ 242
3	a 131	ô 147	ث 163	 179	ٲ 195	ل 211	ع 227	ٲ 243
4	SP 132	ٲ 148	ج 164	ٲ 180	- 196	ٲ 212	غ 228	ٲ 244
5	à 133	- 149	ح 165	ٲ 181	ٲ 197	ٲ 213	ف 229	ٲ 245
6	SP 134	û 150	خ 166	ٲ 182	ٲ 198	ٲ 214	ٲ 230	ٲ 246
7	ç 135	ù 151	د 167	ٲ 183	ٲ 199	ٲ 215	ق 231	≈ 247
8	ê 136	ء 152	ذ 168	ٲ 184	ل 200	ٲ 216	ك 232	° 248
9	ë 137	أ 153	ر 169	ٲ 185	ٲ 201	ل 217	ل 233	° 249
A	è 138	أ 154	ز 170	ٲ 186	ل 202	ٲ 218	م 234	° 250
B	ï 139	ؤ 155	س 171	ٲ 187	ٲ 203	■ 219	ن 235	√ 251
C	î 140	ع 156	ش 172	ك 188	ٲ 204	■ 220	ه 236	n 252
D	SP 141	! 157	ص 173	ل 189	ٲ 205	■ 221	و 237	2 253
E	SP 142	ى 158	« 174	ل 190	ٲ 206	■ 222	ى 238	■ 254
F	SP 143	ا 159	» 175	ٲ 191	SP 207	■ 223	ي 239	SP 255

8 COMMAND SETS

8.1 ESC/POS Command Sets

Category	Commands	Function
Print commands	LF	Print and line feed
	FF	Print and feed paper to the head of next page (in page mode)
	CR	Print and carriage return
	ESC J n	Print and feed paper
Print position commands	HT	Horizontal tab
	ESC \$ nL nH	Set absolute print position
	ESC D n1...nk NUL	Set horizontal tab positions
	ESC \ nL nH	Set relative print position
	ESC a n	Select justification
	ESC d n	Print and feed <i>n</i> lines
	ESC t n	Select character code table
	GS L nL nH	Set left margin
	GS W nL nH	Set print area width
Miscellaneous Function Commands	ESC = n	Select printer
	ESC @	Initialize printer
	GS P x y	Set horizontal and vertical motion units
Chinese Character control commands	FS ! n	Set Chinese character mode
	FS &	Select Chinese character mode
	FS - n	Turn on/off Chinese character underline mode
	FS	Cancel Chinese character mode
	FS 2 c1 c2 d1...dk	Define user-defined Chinese character
	FS C n	Select Chinese character code system
	FS S n1 n2	Set Chinese character left and right spacing
	FS W n	Turn on/off Chinese double height and double width
Space commands	ESC 2	Select default line spacing
	ESC 3 n	Set line spacing
Control panel commands	ESC c 5 n	Enable/disable panel buttons

Category	Commands	Function
Character control commands	ESC SP n	Set right-side character spacing
	ESC ! n	Select print mode(s)
	ESC % n	Select/cancel user-defined character set
	ESC & y c1 c2 [x1 d1...d(y × x1)]...[xk d1...d(y × xk)]	Define user-defined characters
	ESC - n	Turn on/off underline mode
	ESC ? n	Cancel user-defined characters
	ESC E n	Turn emphasized mode on/off
	ESC G n	Turn double-strike mode on/off
	ESC M n	Select character font
	ESC R n	Select an international character set
	ESC V n	Turn on/off 90 degrees clockwise rotation mode
	ESC { n	Turn on/off upside-down print mode
	GS ! n	Select character size
	GS B n	Turn white/black reverse print mode on/off
Barcode commands	GS H n	Select print position of HRI characters
	GS f n	Select font for HRI characters
	GS h n	Set bar code height
	①GS k m d1...dk NUL ②GS k m n d1...dn	Print bar code
	GS w n	Set barcode width
	ESC Z m n k dL dH d1 ...dn	Print 2D barcode
	GS Z n	Select 2D barcode type
	①GS k m v r d1...dn NUL ②GS k m v r nL nH d1...dn	Print 2D barcode
Bit image commands	ESC * m nL nH d1... Dk	Select bit-image mode
	FS P n	Print NV bit image
	GS * x y d1...d(x × y × 8)	Define downloaded bit image

8.2 ZPL Command Sets

Commands	Function
^A	Scalable/Bitmapped Font
^A@	Use Font Name to Call Font
^B0	Aztec Bar Code Parameters
^B1	Code 11 Bar Code
^B2	Interleaved 2 of 5 Bar Code
^B3	Code 39 Bar Code
^B4	Code 49 Bar Code
^B5	Planet Code bar code
^B7	PDF417 Bar Code
^B8	EAN-8 Bar Code
^B9	UPC-E Bar Code
^BA	Code 93 Bar Code
^BB	CODABLOCK Bar Code
^BC	Code 128 Bar Code (Subsets A, B, and C)
^BD	UPS MaxiCode Bar Code
^BE	EAN-13 Bar Code
^BF	MicroPDF417 Bar Code
^BI	Industrial 2 of 5 Bar Codes
^BJ	Standard 2 of 5 Bar Code
^BK	ANSI Codabar Bar Code
^BL	LOGMARS Bar Code
^BM	MSI Bar Code
^B0	Aztec Bar Code Parameters
^BP	Plessey Bar Code
^BQ	QR Code Bar Code
^BR	GS1 Databar (formerly Reduced Space Symbology)
^BS	UPC/EAN Extensions
^BT	TLC39 Bar Code
^BU	UPC-A Bar Code
^BX	Data Matrix Bar Code
^BY	Bar Code Field Default
^CC ~CC	Change Caret
^BZ	POSTAL Bar Code

Commands	Function
^CD	~CD Change Delimiter
^CF	Change Alphanumeric Default Font
^CI	Change International Font/Encoding
^CM	Change Memory Letter Designation
^CO	Cache On
^CP	Remove Label
^CV	Code Validation
^CW	Font Identifier
~DB	Download Bitmap Font
~DE	Download Encoding
^DF	Download Format
~DG	Download Graphics
~DN	Abort Download Graphic
~DS	Download Intellifont (Scalable Font)
~DT	Download Bounded TrueType Font
~DU	Download Unbounded TrueType Font
~DY	Download Objects
~EG	Erase Download Graphics
^FB	Field Block
^FC	Field Clock
^FD	Field Data
^FH	Field Hexadecimal Indicator
^FL	Font Linking
^FM	Multiple Field Origin Locations
^FN	Field Number
^FO	Field Origin
^FP	Field Parameter
^FR	Field Reverse Print
^FS	Field Separator
^FT	Field Typeset
^FV	Field Variable
^FW	Field Orientation
^FX	Comment
^GB	Graphic Box

Commands	Function
^GC	Graphic Circle
^GD	Graphic Diagonal Line
^GE	Graphic Ellipse
^GF	Graphic Field
^GS	Graphic Symbol
~HB	Battery Status
~HD	Head Diagnostic
^HF	Host Format
^HG	Host Graphic
^HH	Configuration Label Return
~HI	Host Identification
~HM	Host RAM Status
~HQ	Host Query
~HQ	Examples
~HS	Host Status Return
^HT	Host Linked Fonts List
~HU	Return ZebraNet Alert Configuration
^HV	Host Verification
^HW	Host Directory List
^HY	Upload Graphics
^HZ	Display Description Information
^ID	Object Delete
^IL	Image Load
^IM	Image Move
^IS	Image Save
~JA	Cancel All
^JB	Initialize Flash Memory
~JB	Reset Optional Memory
~JC	Set Media Sensor Calibration
~JD	Enable Communications Diagnostics
~JE	Disable Diagnostics
~JF	Set Battery Condition
~JG	Graphing Sensor Calibration
^JH	Early Warning Settings

Commands	Function
^JI	Start ZBI (Zebra BASIC Interpreter)
~JI	Start ZBI (Zebra BASIC Interpreter)
^JJ	Set Auxiliary Port
~JL	Set Label Length
^JM	Set Dots per Millimeter
~JN	Head Test Fatal
~JO	Head Test Non-Fatal
~JP	Pause and Cancel Format
~JQ	Terminate Zebra BASIC Interpreter
~JR	Power On Reset
^JS	Sensor Select
~JS	Change Backfeed Sequence
^JT	Head Test Interval
^JU	Configuration Update
^JW	Set Ribbon Tension
~JX	Cancel Current Partially Input Format
^JZ	Reprint After Error
~KB	Kill Battery (Battery Discharge Mode)
^KD	Select Date and Time Format (for Real Time Clock)
^KL	Define Language
^KN	Define Printer Name
^KV	Kiosk Values
^LF	List Font Links
^LH	Label Home
^LL	Label Length
^LR	Label Reverse Print
^LS	Label Shift
^LT	Label Top
^MA	Set Maintenance Alerts
^MC	Map Clear
^MD	Media Darkness
^MF	Media Feed
^ML	Maximum Label Length
^MM	Print Mode

Commands	Function
^MN	Media Tracking
^MP	Mode Protection
^MT	Media Type
^MU	Set Units of Measurement
^MW	Modify Head Cold Warning
^NC	Select the Primary Network Device
~NC	Network Connect
^ND	Change Network Settings
^NI	Network ID Number
~NR	Set All Network Printers Transparent
^NS	Change Wired Networking Settings
~NT	Set Currently Connected Printer Transparent
^PA	Advanced Text Properties
^PF	Slew Given Number of Dot Rows
^PH ~PH	Slew to Home Position
~PL	Present Length Addition
^PM	Printing Mirror Image of Label
^PN	Present Now
^PO	Print Orientation
^PP ~PP	Programmable Pause
^PQ	Print Quantity
^PR	Print Rate
~PR	Applicator Reprint
~PS	Print Start
^PW	Print Width
~RO	Reset Advanced Counters
^SC	Set Serial Communications
~SD	Set Darkness
^SE	Select Encoding Table
^SF	Serialization Field (with a Standard ^FD String)
^SI	Set Sensor Intensity
^SN	Serialization Data
^SP	Start Print
^SQ	Halt ZebraNet Alert

Commands	Function
^SR	Set Print head Resistance
^SS	Set Media Sensors
^SZ	Set ZPL
^TB	Text Blocks
^TO	Transfer Object
~WC	Print Configuration Label
^WD	Print Directory Label
~WQ	Write Query
~WQ	Examples
^XA	Start Format
^XB	Suppress Backfeed
^XF	Recall Format
^XG	Recall Graphic
^XS	Set Dynamic Media Calibration
^XZ	End Format
^ZZ	Printer Sleep

8.3 EPL Command Sets

Commands	Function
A	ASCII text
B	Bar Code (EAN-8 / EAN-13 / UPC-A / Interleaved 25 / Codabar / UPC-E / Code39 / Code 128)
b	MaxCode (Data Matrix / PDF417 / QR Code)
C	Cut Immediate
D	Density
EI	Print Soft Font Info.
EK	Delete Soft Font
ES	Store Soft Font
f	Cut/peel position
GG	Tetrieve Graphics
GI	Print Graphics Info.
GK	Delete Graphic
GM	Store Graphic
I	Character Set Selection
JF	Enable Top of Form Backup
LO	Line Draw Black
LS	Line Draw Diagonal
N	Clear Image Buffer
O	Options Select
P	Print
q	Set Label Width
Q	Set Form Width
R	Set Reference Point
S	Speed Select
X	Box Draw
Z	Print Direction
;	Code Anotation
^@	Reset Printer
^default	Set Printer to Factory Defaults

Appendix I: Installing the Cutter

Removing the Tear Bar

(1) Turn off the printer power and open the top cover and the print head mechanism, and then pull the tear bar to your side.



(2) Lift the tear bar up and it can be easily removed.

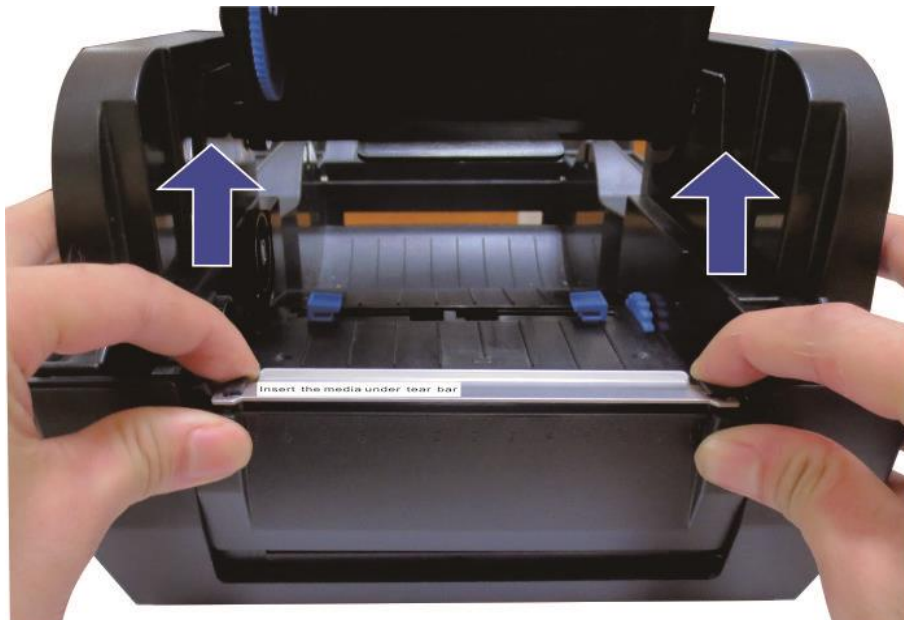

(3) The tear bar is removed.

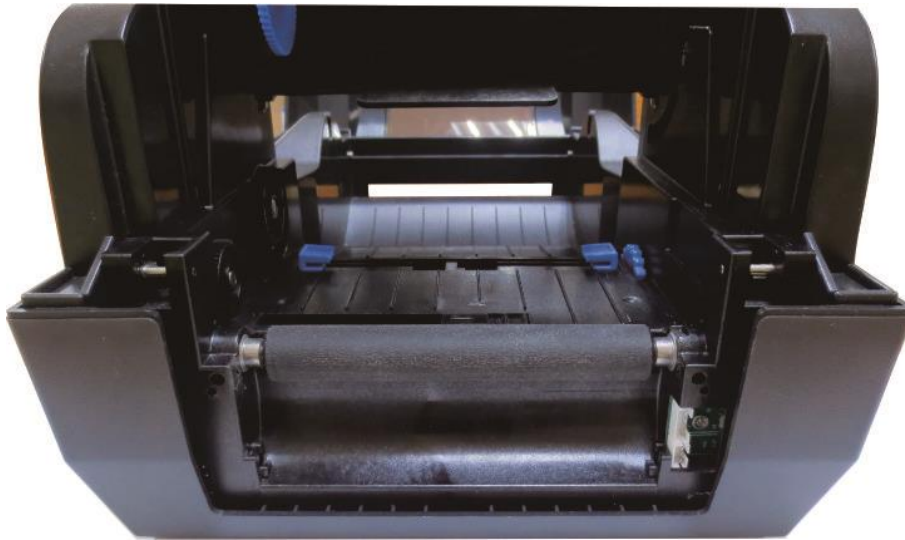

Note: Do it in reverse steps so as to install the tear bar.

Installing the Auto Cutter

(1) Power down the printer before installing the cutter. Plug in the cutter connector to the printer.

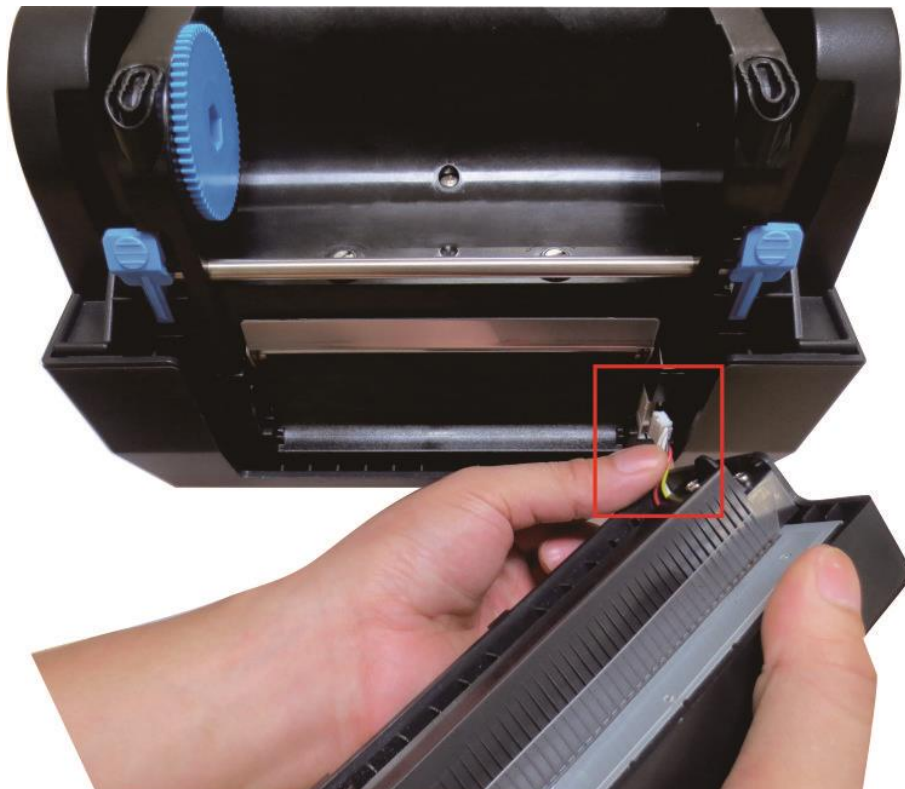

(2) Put the auto cutter onto the slot of the low casing.

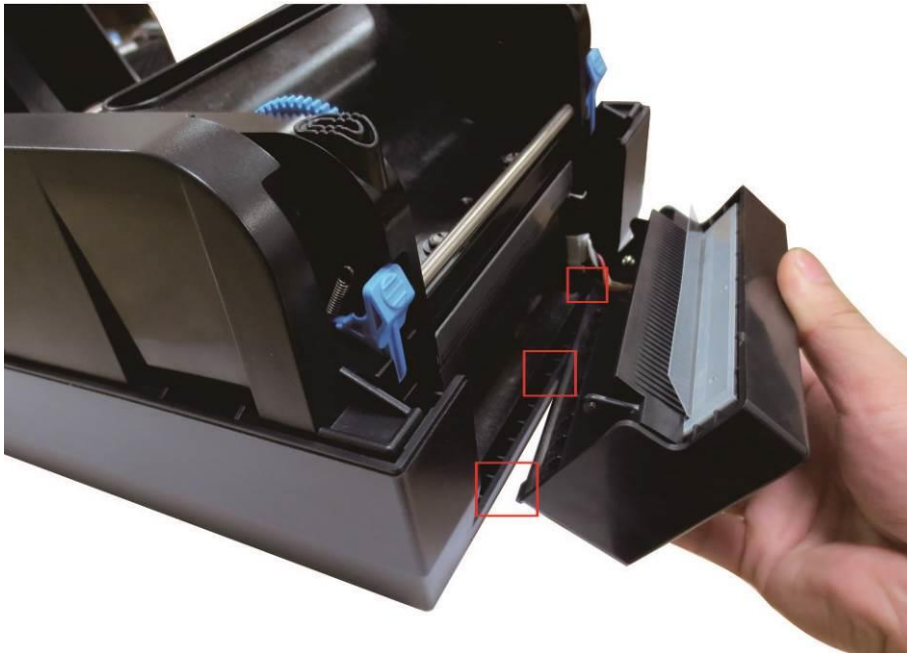

(3) Move the auto cutter gently to the reverse board till you hear the click sound.

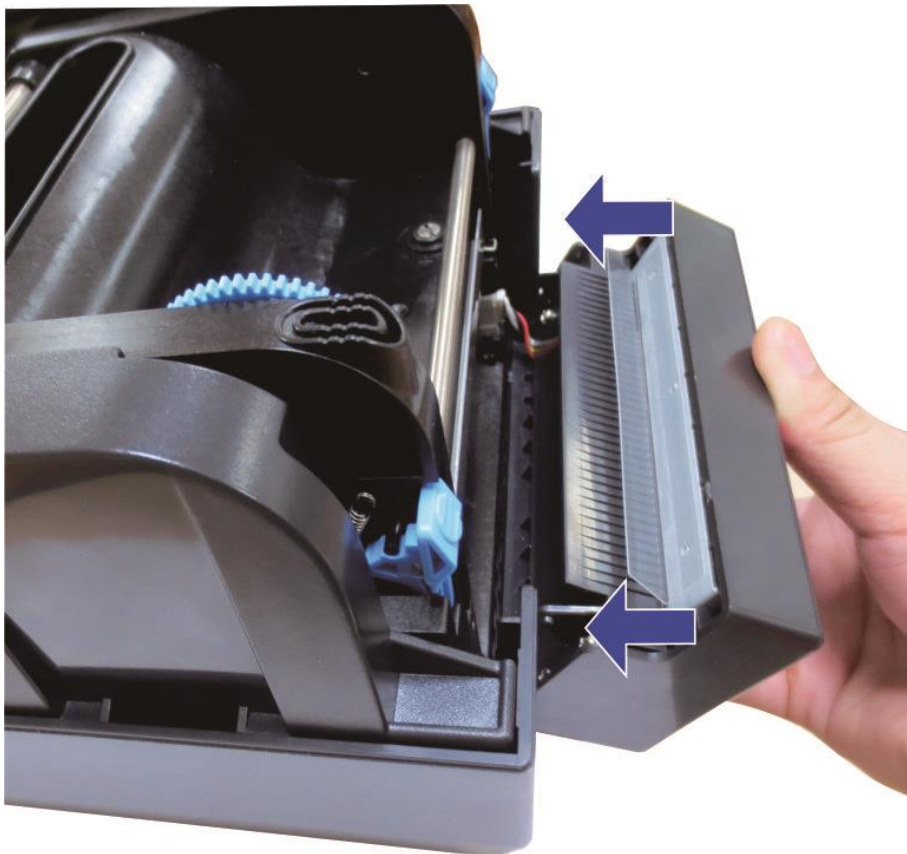

(4) After installation you can use the auto cutter.



(5) Enable the cutter in the setup tool.

Appendix: FCC STATEMENT

1. This device complies with Part 15 of the FCC Rules. Operation is subject to the following two conditions:

- 1) This device may not cause harmful interference. and
- 2) This device must accept any interference received, including interference that may cause undesired operation.

2. Changes or modifications not expressly approved by the party responsible for compliance could void the user's authority to operate the equipment.



This equipment has been tested and found to comply with the limits for a Class B digital device, pursuant to Part 15 of the FCC Rules. These limits are designed to provide reasonable protection against harmful interference in a residential installation.

This equipment generates uses and can radiate radio frequency energy and, if not installed and used in accordance with the instructions, may cause harmful interference to radio communications. However, there is no guarantee that interference will not occur in a particular installation. If this equipment does cause harmful interference to radio or television reception, which can be determined by turning the equipment off and on, the user is encouraged to try to correct the interference by one or more of the following measures:

- Re-orientate or relocate the receiving antenna.
- Increase the separation between the equipment and receiver.
- Connect the equipment into an outlet on a circuit different from that to which the receiver is connected.
- Consult the dealer or an experienced radio/TV technician for help.

FCC Radiation Exposure Statement

This equipment complies with FCC radiation exposure limits set forth for an uncontrolled environment. This equipment should be installed and operated with minimum distance 20cm between the radiator & your body.

CE 2200

Appendix III: DASCUM REPRESENTATIVES

GERMANY

DASCUM Europe GmbH
Heuweg 3
D-89079 Ulm
Deutschland
Tel.: +49 (0) 731 2075 0
Fax: +49 (0) 731 2075 100
www.dascom.com

SINGAPORE (ASIA PACIFIC)

DASCUM AP Pte Ltd
21 Bukit Batok Crescent
#29-81, WCEGA Tower
Singapore 658065
Phone: +65 6760 8833
Fax: +65 6760 1066
www.dascom.com

AMERICAS

DASCUM Americas Corporation
34 Lakeview Court
Verona, VA 24482
USA
Phone: +1 (877) 434 13 77
Fax: +1 (540) 242 7221
www.dascom.com

UNITED KINGDOM

DASCUM GB Ltd
Hart House, Priestley Road
Basingstoke, Hampshire
RG24 9PU, England
Phone: +44 (0) 1256 481481
Fax: +44 (0) 1256 481400
www.dascom.com

FRANCE

DASCUM Europe GmbH
117 Avenue Victor Hugo
92100 Boulogne-Billancourt
France
Phone: +33 (1) 73 02 51 98
www.dascom.com

CHINA

JIANGMEN DASCUM COMPUTER
PERIPHERALS CO., LTD
No. 399, Jinxing Road, Jianghai District,
Jiangmen, Guangdong P.R. China
www.dascom.com.cn

“All rights reserved. Translations, reprinting or copying by any means of this manual complete or in part or in any different form requires our explicit approval. We reserve the right to make changes to this manual without notice. All care has been taken to ensure accuracy of information contained in this manual. However, we cannot accept responsibility for any errors or damages resulting from errors or inaccuracies of information herein.”