

# FP-530si, DP-530si

## Operator's Manual

*Tally*

**DASCOM**

 **PRINTEK™**

**DASCOM®**

Printek, LLC  
2515 Lakeshore Drive  
Saint Joseph, MI 49085-2977  
269-925-3200  
[www.printek.com](http://www.printek.com)

## **FCC Part 15 Class B**

This device complies with Part 15 of the FCC Rules. Operation is subject to the following two conditions: (1) this device may not cause harmful interference, and (2) this device must accept any interference received, including interference that may cause undesired operation.

This equipment has been tested and found to comply with the limits for a Class B digital device, pursuant to Part 15 of the FCC rules. These limits are designed to provide reasonable protection against harmful interference in a residential installation. This equipment generates, uses, and can radiate radio frequency energy and, if not installed and used in accordance with the instructions, may cause harmful interference to radio communications. However, there is no guarantee that interference will not occur in a particular installation. If this equipment does cause harmful interference to radio or television reception, which can be determined by turning the equipment off and on, the user is encouraged to try to correct the interference by one or more of the following measures:

- Reorient or relocate the receiving antenna.
- Increase the separation between the equipment and the receiver.
- Connect the equipment into an outlet on a circuit different from that to which the receiver is connected.
- Consult the dealer or an experienced radio/TV technician for help.

This equipment complies with Canadian and FCC radiation exposure limits set forth for an uncontrolled environment. This transmitter must not be co-located or operating in conjunction with any other antenna or transmitter.

Part 15.21 Caution: Changes or modifications not expressly approved by Printek, LLC could void the user's authority to operate the equipment.

## **Canadian Department of Communications Radio Interference Statement**

This device complies with Industry Canada license-exempt RSS standard(s). Operation is subject to the following two conditions: 1) this device may not cause interference; 2) this device must accept any interference, including interference that may cause undesired operation of the device. Under Industry Canada regulations, this radio transmitter may only operate using an antenna of a type and maximum (or lesser) gain approved for the transmitter by Industry Canada. To reduce potential radio interference to other users, the antenna type and its gain should be so chosen that the equivalent isotropically radiated power (e.i.r.p.) is not more than that necessary for successful communication. Maximum power output plus maximum antenna gain of the EUT is:  $4.5W/m^2$ , Limit is  $10W/m^2$ .

*Le présent appareil est conforme aux CNR d'Industrie Canada applicables aux appareils radio exempts de licence. L'exploitation est autorisée aux deux conditions suivantes : (1) l'appareil ne doit pas produire de brouillage, et (2) l'utilisateur de l'appareil doit accepter tout brouillage radioélectrique subi, même si le brouillage est susceptible d'en compromettre le fonctionnement. Conformément à la réglementation d'Industrie Canada, le présent émetteur radio peut fonctionner avec une antenne d'un type et d'un gain maximal (ou inférieur) approuvé pour l'émetteur par Industrie Canada.*

*Dans le but de réduire les risques de brouillage radioélectrique à l'intention des autres utilisateurs, il faut choisir le type d'antenne et son gain de sorte que la puissance isotrope rayonnée équivalente (p.i.r.e.) ne dépasse pas l'intensité nécessaire à l'établissement d'une communication satisfaisante. La puissance de sortie maximale plus gain d'antenne maximal du EUT est :  $4.5W/m^2$  Limite est  $10W/m^2$*

## RF Exposure Warning Statements:

This equipment complies with FCC radiation exposure limits set forth for an uncontrolled environment. This equipment shall be installed and operated with minimum distance 20cm between the radiator & body.

### Acknowledgments:

Printek is a registered trademark of Printek, LLC

Zebra, CPCL and ZPLare registered trademarks of Zebra Technologies

Wi-Fi is a registered trademark of the Wi-Fi Alliance

Windows is a registered trademark of Microsoft Corporation

All other trademarks are the property of their respective owners.

© 2015 By Printek LLC, 1517 Townline Road, Benton Harbor, MI 49022. All rights reserved.



Read all set up and operating instructions before proceeding with operation. Do not operate in an enclosure unless properly ventilated. Do not operate near a heat source.



Lesen Sie vor der Inbetriebnahme die Aufbau- und Bedienungsanleitung. Betreiben Sie den Drucker nicht in einem kleinen, geschlossenen Raum, es sei denn dieser wird ordnungsgemäß belüftet. Nehmen Sie den Drucker nicht in der Nähe einer Wärmequelle in Betrieb.



No user-serviceable parts inside. Refer service or repairs to a qualified service professional. Use of genuine Printek replacement parts is required to warrant proper, safe operation. Any alteration or modification of this device voids the user warranty and may make the product unsafe to operate. The print head and motors get hot during use. Wait until they cool before touching them. Make certain the printer is disconnected from AC power before removing any covers or performing any required cleaning or maintenance. Connecting this printer to an ungrounded receptacle can result in electrical shock. Never place the printer near inflammable or explosive substances. Do not operate near liquid or spill liquid into the printer at any time.



Enthält keine Teile, die vom Bediener instandgesetzt werden können. Bitte wenden Sie sich bei Instandsetzung oder Reparatur an qualifiziertes Kundendienstpersonal. Die Verwendung von echten Printek Ersatzteilen ist notwendig, um ordnungsgemäßen, sicheren Betrieb zu gewährleisten. Änderungen oder Modifikationen dieses Geräts machen die Garantie ungültig und können den sicheren Betrieb des Produkts gefährden. Während des Druckens werden Druckerkopf und Motoren heiß. Warten Sie, bis sich die Teile abgekühlt haben, bevor Sie sie berühren. Vergewissern Sie sich, dass der Drucker nicht mehr an die Stromquelle angeschlossen ist, bevor Sie Abdeckungen abnehmen oder das Gerät reinigen bzw. warten. Schließen Sie diesen Drucker nicht an eine ungeerdete Steckdose an; dies kann zum Elektroschock führen. Setzen Sie den Drucker niemals in die Nähe von feuer- oder explosionsgefährlichen Stoffen. Betreiben Sie den Drucker nicht in der Nähe von Flüssigkeiten und lassen Sie keine Flüssigkeiten in den Drucker gelangen.

**Specifications are subject to change without notice.**

# Table of Contents

---

<b>Introduction</b> .....	<b>1</b>
<b>Printer Features</b> .....	<b>3</b>
<b>Quick Start Instructions</b> .....	<b>4</b>
A. Paper Load .....	4
B. 9 Pin D-Connector Pin Out .....	5
C. Power On .....	5
D. Control Panel .....	5
E. Performing a Printer Self-Test .....	6
<b>Configuration</b> .....	<b>7</b>
A. Connectivity Parameters.....	9
<b>WI-FI Config:</b> .....	<b>11</b>
B. Image Parameters .....	14
C. Device Config.....	16
D. Fonts .....	17
E. Graphics.....	19
F. Update Printer Firmware, Upload Files to Printer Memory.....	20
G. Reset Printer Configuration to Factory Defaults (Safe Mode) .....	20
<b>Printing Modes</b> .....	<b>21</b>
A. ASCII Based Print Jobs .....	21
B. Graphic Based Print Jobs .....	21
<b>Integrating the Printer into your Business Applications</b> .....	<b>22</b>
<b>Step by Step – Creating a Link from Host to Printer</b> .....	<b>22</b>
A. Windows Desktop Computers .....	22
Print Drivers.....	22
I. SERIAL .....	22
II. USB.....	22
III. Wi-Fi.....	23
B. Windows Tablets and Smartphones .....	23
C. Android Tablets & Smart phones .....	24
I. Wi- Fi.....	24
D. Apple™ Tablets & Smartphones .....	24
I. Wi-Fi.....	24
<b>Media</b> .....	<b>25</b>
A. Standard Media.....	25
B. Black Mark Media Position.....	25
<b>Maintenance and Troubleshooting</b> .....	<b>26</b>
A. Cleaning.....	26
B. Troubleshooting .....	26
I. General Error Conditions .....	27
II. Fault Description and Resolution .....	27
C. Obtaining Service.....	27
<b>APPENDIX</b> .....	<b>28</b>
A. Appendix A – FieldPro 530si Printer Specifications .....	28
<b>Glossary of Terms</b> .....	<b>29</b>
<b>Index</b> .....	<b>31</b>

## Introduction

---

Thank you for purchasing the Printek FieldPro 530si Series mobile thermal printer. The FP530si series prints on special thermal media supplied in roll form up to 3.125 inches wide. All models are equipped with a USB port which supports printer configuration. All models support an optional internal Wi-Fi interface. Complete specifications may be found in [Appendix A – FieldPro 530si Printer Specifications](#).

The remainder of this manual focuses on preparing the printer for initial use and performing tasks that will be encountered during daily use.

[Maintenance and Troubleshooting](#) describes how to maintain the printer for optimal performance and has information on how to diagnose any problems that may occur.

Printek recommends using genuine Printek supplied media and accessories. For detailed lists and contact information, please see [Appendix B – Supplies and Accessories](#) & [Appendix C – Media](#).

# Printer Features

---

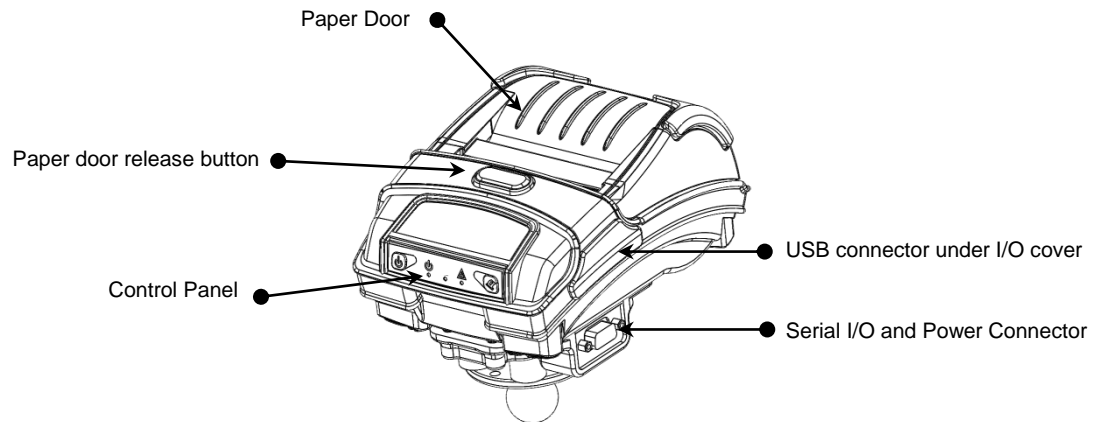

Your FieldPro 530si features:

- Easy-to-read control face and simple drop-in paper loading
- Quickly prints a wide variety of tickets, receipts, and labels.
- IP54 rated for water and dust resistance... plus rated for repeated 6-foot drops to concrete
- Print speeds up to 5 ips
- Extensive fonts, character sets, bar codes and graphic capabilities
- Printer configuration is quick and easy with a web based interface
- Compatible with Windows, Windows Mobile and Android
- Emulations that allow the printer to be a drop-in replacement for nearly any mobile printer

For detailed specifications reference [Appendix A – FieldPro 530si Printer Specifications](#).

# Quick Start Instructions

---

## A. Paper Load

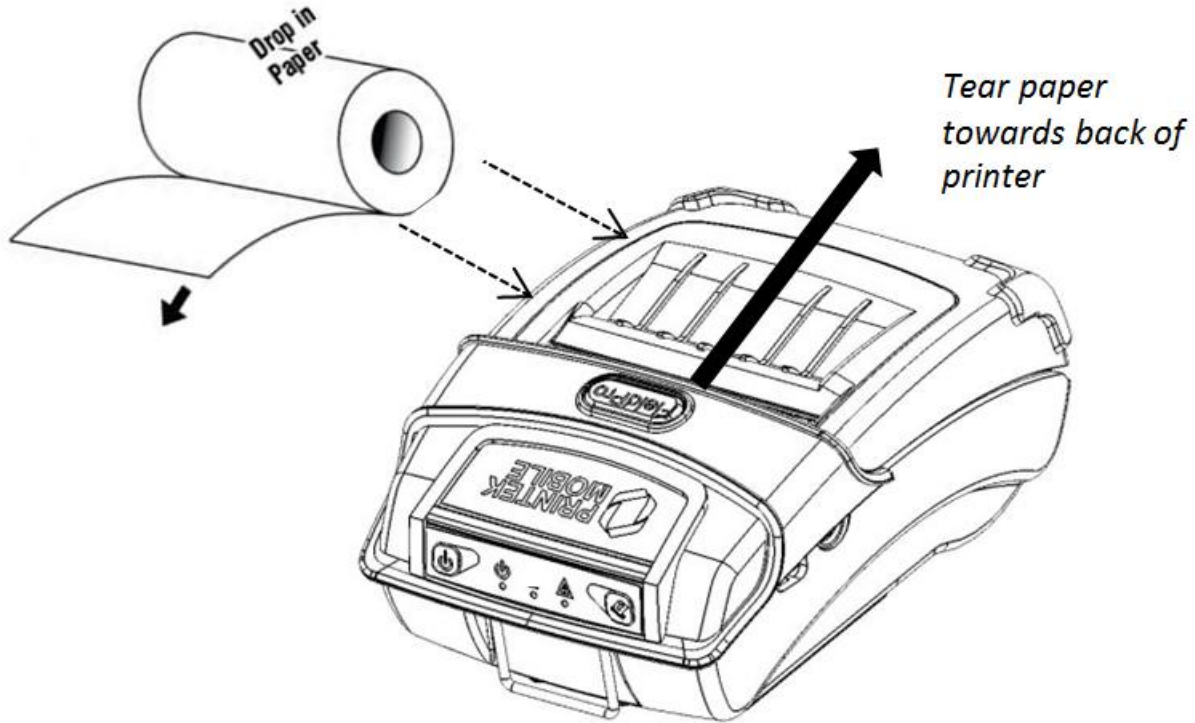

Press Paper door release button to open the paper compartment door. Pull small leader of paper out and close paper door. "Clicks" when properly closed.

**NOTE:**  
When using  
2" paper,  
install spacer  
P/N: 93194

## B. 9 Pin D-Connector Pin Out



Use table to connect Power and RS232 serial communication:



Pin	Color	Description
1	-	NC
2	White	Receive data (From Host)
3	Green	Transmit data (From Printer)
4	-	NC
5	Black	Ground
6	-	NC
7	-	NC
8	Red	Power (8-32 VDC)
9	-	NC
	Shell	Drain wire

## C. Power On

Printer automatically turns on when power is applied.

## D. Control Panel

Control Panel		
 Power Button	Power Up Power Down Toggle IP over USB on/off	Press & Release Press & Hold Press twice
 Paper Feed Button	Advance paper Print Setup Report	Press once Press twice

Power & Status (Green/Red) 	Alert (Red) 	Indication
On	On	Booting up
On	Off	Ready
On	Flashing	Paper Error/Lid Open
Flashing	Off	Job is arriving
Flashing	Off	Job is printing
Flashing	Flashing	IP over USB active
Solid, Flashes Off Every 2 Seconds	Off	Wireless Personal Area Network active



## E. Performing a Printer Self-Test



With power on, press the paper feed button twice quickly.

# Configuration

---

Configuration of the FP530si printer is done through a built-in web page. This allows you to configure the printer from any device that has a browser and is compatible with your FP530si communication capabilities.

1. Turn the printer ON.
2. Connect a USB cable between the printer and a PC.
3. To access the FP530si web page, push the Power button twice rapidly. This will put the printer into Configuration mode.
4. When the printer is in Configuration mode the POWER and FAULT LEDs will flash together.
  - a. Open browser on your PC and type **169.254.200.1** into the address bar of the browser and hit Enter - A login box should appear:
  - b. Use the dropdown box to select a language other than English.
  - c. Type "0000" and hit Enter- you should now be at the home page for FP530si Configuration.

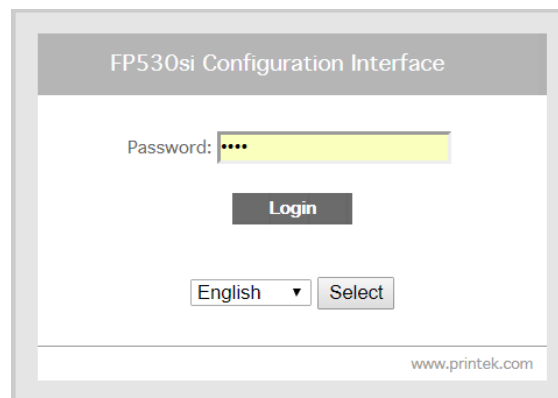

5. The main configuration screen of the FP530si:

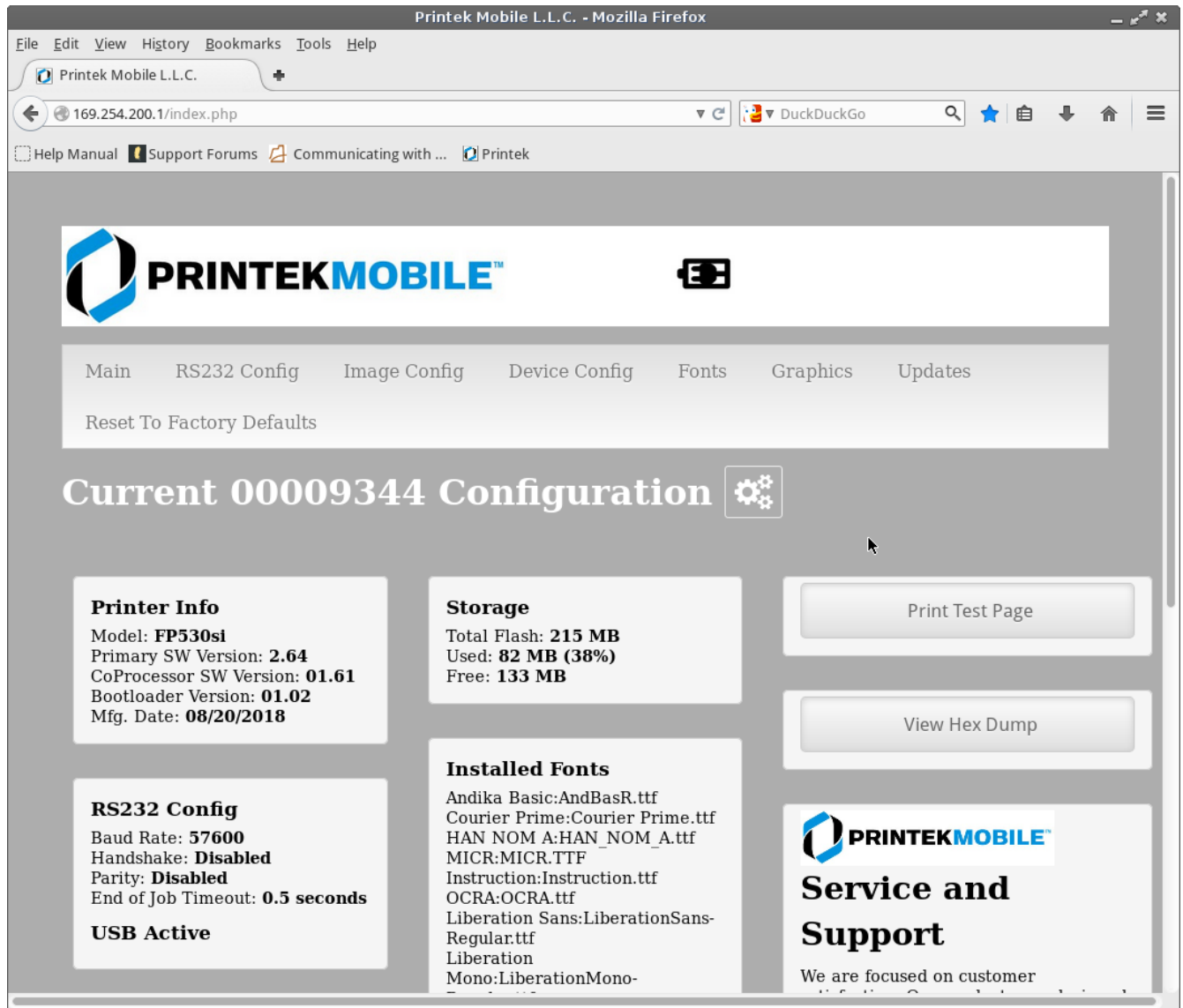

This is an overview of the printer configuration. An AC plug will appear in the battery icon when the printer is plugged into an external power source.

To return the printer to normal operating mode, double-click the Power button. The POWER LED will be returned to a solid light.

At the top of the Main Page are selections to access the sub-menus.



Wherever the book icon appears in the printer configuration pages, click it to access the user manual pages for help.

## A. Connectivity Parameters

This page allows you to setup the connection to your printer. Depending on the optional interface installed, you will see either Bluetooth Config or WI-FI Config. In the detailed descriptions, an asterisk (\*) indicates the factory default value.

### RS-232 Config:

Note: these values must match the host system serial port interface.

Baud Rate	57600
Handshake	Disabled
Parity	Disabled
End of Job Timeout	0.5 seconds

Note: Submit Changes will force restart.

Submit Changes   Discard Changes

#### Baud Rate:

Possible values: 9600, 19200, 38400, 57600\*, 115200

Sets communication speed between the printer and host.

**Handshake:**

Possible values: Disabled\*, Xon/Xoff  
Sets the handshaking protocol.

**Parity:**

Possible values: Disable\*, Even, Odd  
Sets the Parity bit.

**End of Job Timeout:**

Possible values: 0.5 through 9.5 seconds at .5 intervals  
Sets the time the printer will wait to receive data before considering the print job complete.

## WI-FI Config:

The screenshot shows the Printek Mobile WiFi Configuration page. At the top, there is a navigation menu with links for Main, WIFI Config, Image Config, Device Config, Fonts, Graphics, Updates, and Reset To Factory Defaults. The main content area is titled "Wireless Configuration" and contains a form with the following fields:

IP Address	<input type="text" value="0"/> <input type="text" value="0"/> <input type="text" value="0"/> <input type="text" value="0"/>
SubnetMask	<input type="text" value="0"/> <input type="text" value="0"/> <input type="text" value="0"/> <input type="text" value="0"/>
Gateway	<input type="text" value="0"/> <input type="text" value="0"/> <input type="text" value="0"/> <input type="text" value="0"/>
Wifi Port	<input type="text" value="8023"/>

Below the form are two buttons: "Submit Changes" and "Discard Changes". At the bottom, there is a section for "Address Method" with a note: "(Note: Submit Changes will force restart.)". The options are:

- Static
- DHCP
- Personal Area Network

A "Submit Address Method Change" button is located to the right of the radio buttons.

### Wireless Configuration

This will display the current Wi-Fi configuration:

**IP Address** – user defined. If Static Address Method is selected, type in the address the printer will use on the network.

**SubNetMask** – user defined. If Static Address Method is selected, type in the subnet mark of the network.

**GateWay** – user defined. If Static Address Method is selected, type in the gateway address of the network.

**WiFi Port** – user defined. Type in the IP port to be used by the printer. (default value = 8023)

**Address Method** – user selectable

Static – printer will always connect to the network using the IP address defined.

DHCP – printer will acquire an IP address from your network DHCP server

Personal Area Network –The printer will broadcast itself as a network connection. The Power LED will flash off every two seconds while in this mode. The SSID will be the serial number of the printer. When connecting to the printer, the passphrase is the printer's serial number.

Personal Area Network mode can also be activated outside of the printer web page. To enter Personal Area Network mode, press and hold the Power and Paper Feed buttons until the Power and Alert LEDs light. Release both buttons, and the printer will restart in Personal Area Network mode. To exit Personal Area Network mode, press and hold the Power and Paper Feed buttons until the Power and Alert LEDs light. Release both buttons, and the printer will restart in normal WiFi mode.

**Available Networks** 

BSSID	Frequency	Signal Level	Flags	SSID	Add/Connect
c8:b3:73:5a:2d:67	2412	183	[WPA2-EAP-CCMP-preauth][ESS]	EngineeringTest	Add/Connect
c0:56:27:71:e8:98	2412	210	[WPA-PSK-TKIP][WPA2-PSK-CCMP][WPS][ESS]	Printek3	Add/Connect
00:25:9c:77:d4:57	2437	184	[WPA-PSK-TKIP][ESS]	Printek2	Add/Connect

**Previously Connected Networks** 

Network ID	SSID	BSSID	Status	Connect/Disconnect	Remove
0	Testing	any		Connect	Remove

**Currently Configured Networks** 

SSID	Remove
Testing	Remove

**Set Date** 

Year 2016	Submit
--------------	--------

**Available Networks** – access points detected by the printer will be displayed. Select Add/Connect to use one of these access points.

**Previously Connected Networks** – access points detected by the printer or added through Add/Edit Network will be displayed. Select Connect to use one of these access points, or Remove to delete it from printer.

**Currently Configured Networks** – access points added through Add/Edit. They may not have been connected yet. Select Remove to delete access point from printer.

**Set Date** – Some Enterprise network connections require this setting. Simply enter the current year.

### Add/Edit Network

Enter the SSID of a network connection. If authentication is used select the authentication type. Click Next. The following form will change depending on the authentication type:

#### WPA-PSK

Enter the password for the network connection.

**Add/Edit Network** 

Key Management Protocol WPA-PSK	Network Name Test1	Next
Password <input type="password"/>		
Submit Changes	Discard Changes	

## WPA-EAP or IEEE8021X

These are Enterprise network settings. Consult your server manual for recommended settings.

**Add/Edit Network** [?](#)

Key Management Protocol IEEE8021X ▼	Network Name Test2	Next
EAP TTLS ▼		
Phase1 ▼	Phase2 ▼	
Identity <input type="text"/>	Anonymous Identity <input type="text"/>	
Password <input type="text"/>		
Private Key Password <input type="text"/>	Private Key2 Password <input type="text"/>	
CA Certificate File ▼	Client Certificate File ▼	Private Key ▼
CA2 Certificate File ▼	Client2 Certificate File ▼	Private Key2 ▼

Submit Changes   Discard Changes

## Upload Digital Certificate

If your enterprise network uses digital certificates as another form of authentication, you can upload the certificates here.



## B. Image Parameters

This page allows you to make selections about the image to be printed.

Current Emulation	PRINTEK
Default Font	Liberation Mono:LiberationMono-Regular.ttf
Chars Per Inch	10.7
Default Text Line Spacing	5
Line Wrapping	<input checked="" type="radio"/> OFF <input type="radio"/> ON
Input File Size	<input type="radio"/> 3 Inch <input type="radio"/> 4 Inch

Submit Changes   Discard Changes

### Current Emulation:

Possible Values: PRINTEK\*, ZPL, CPCL, ESCPOS, IPL, AUTOIMAGE, PDF, POSTSCRIPT, IMAGE

The FP530si printer is capable of using several different emulation modes. This feature sets the family of printer commands that may be used by a host application program to control the various capabilities of the printer. The printer will only respond to commands valid for the currently selected emulation. For more information, please refer to the *Integrator's Guide*.

Besides the popular printer languages to choose from, the following selections allow the FP530si to print many other file formats directly, without the need for a driver.

**AUTOIMAGE** – selected when mixed PDF and POSTSCRIPT images are sent to the printer. The printer will determine which type of file has been sent. This can increase printer response time.

**PDF** – When in this mode the printer will directly print Portable Document Files (PDF).

**POSTSCRIPT** – When in this mode the printer will directly print Postscript formatted files (.ps). You can also use a generic Postscript driver to print when in this mode.

**IMAGE** – selected if just image files are being sent to the printer. When in this mode the printer will directly print the following file types: .png, .jpg, .bmp, .pbm, .svg, .tiff

### Default Font:

The FP530si has the ability to use True Type Fonts. All True Type Fonts loaded into printer memory are listed here. When using emulations that do not specify the font for each line of text, select the font you would like to use as the default font. All print jobs will use the default font unless a command is sent to the printer to use another font.

## **Chars Per Inch and Default Text Line Spacing:**

**NOTE:** These settings only function in Printek Emulation

This determines how large the characters are and how many characters will print in a one inch space. The higher the number, the greater the number of lines per vertical inch of print.

## **Line Wrapping:**

Possible Values: OFF\*, ON

Determines how a line of text is handled.

OFF – data that is longer than the line length will be truncated

ON – data that is longer than the line length will be printed on the next line.

## **Input File Size:**

Possible values: 3 inch\*, 4 inch

If your print job was originally written to print to 4” printer, select 4 inch and the printer will automatically scale the print job to print on the 3” printer.

## C. Device Config

This page allows you to set certain hardware parameters on the printer.

Units	inches <small>NOTE: Select Units before changing other settings.</small>
Max Paper Speed	5.5 <small>inches per sec.</small>
Mark Seek	Off <input type="checkbox"/> Front
Sensor Brightness	Front=[75%]
Front Paper Sensor Threshold	30 <small>% range 0-100%</small>
Rear Paper Sensor Threshold	15 <small>% range 0-100%</small>
Gap Paper Sensor Threshold	90 <small>% range 0-100%</small>
Backup Distance Before Printing	0.35 <small>inches</small>
Feed Distance After Printing	0.35 <small>inches</small>
Stop Distance after Mark	0.75 <small>inches</small>
Mark Seek Distance	6.0 <small>inches</small>
Mark Width	0.20 <small>inches</small>
Left Margin	0.0 <small>inches</small>
Contrast	5 <small>1 - 10</small>

### Login Password

This allows the printer webpage password to be changed.

### Units

Select between inches or millimeters. If you change units, do so before entering other settings.

### Max Paper Speed

Possible values: 1.0 to 5.5 ips, Default = 5.0

When using labels or heavy paper stock, you may need to decrease the paper speed to prevent paper jams.

### Mark Seeking

Possible values: Off\*, Front, Rear, Gap. (Note: Rear and Gap are available only on 530siL models). Set the value when using regular or label media with black alignment marks or label media with gaps between the labels

## Sensor Brightness

Possible values 0-100%. This displays the reflectivity or light transmission of the media, depending on the setting for Mark Seeking. This value is updated once per second.

**Note: Before adjusting black mark thresholds, set Mark Width to match the width of the black mark or label gap on your media.**

## Front Paper Sensor Threshold

When using paper with a black on the front adjust this setting to insure the paper stops at the black mark.

1. With the lid closed and the black mark not over the front paper sensor, note the Sensor Brightness.
2. Open the paper lid and hold the paper against the front paper sensor so that the black mark is over the sensor. Note the Sensor Brightness.
3. Set Threshold = black mark brightness + ((paper brightness – black mark brightness) / 2) and click Submit Changes. *Example: black mark brightness = 10%, paper brightness = 80%.  
Threshold = 10% + ((80% - 10%) / 2) = 45%.*
4. Close lid and press paper feed. The paper should stop with the bottom of the form at the tearbar.

## Rear Paper Sensor Threshold (FP530siL models only)

This is set the same as the front paper threshold, but using the rear (in lid) paper sensor and the Rear Sensor Brightness.

## Gap Paper Sensor Threshold (FP530siL models only)

When using labels without a Black Mark, adjust this setting to insure the label stops at the gap in between labels.

1. Remove 2 labels from the backing paper, and close the lid so the backing is over the paper sensor. Note Sensor Brightness for Gap.
2. Open the lid and close it so a label is over the paper sensor. Note Sensor Brightness for Gap.
3. Set Gap Threshold = label brightness + ((backing brightness – label brightness) / 2) and click Submit Changes.
4. Close lid and press paper feed. The paper should stop with the bottom of the form at the tearbar.

## Backup Distance Before Printing

Used with Mark Seek. User defined. This is the distance the printer will pull in the paper before starting to print.

## Max Mark Search Distance

Used with Mark Seek. User defined. This is the distance the printer will advance paper to seek the mark before displaying a Paper Out condition.

## Stop Distance after Mark

Use with Mark Seeking. User defined. This is the distance the printer will advance the paper after the mark is detected.

## Left Margin

Setting this value will tell the printer how far from the left edge of the paper to start the print job.

## Contrast

Possible values 0 – 10. Default value is 5

The lower the value the lighter the print. The higher the value the darker the print.

## Paper Energy Values

This is a locked value. These settings are supplied by the paper manufacturer. The default settings cover most grades of paper. If you are using non-standard paper consult the paper manufacturer for recommended settings.

## Auto Off Timer

Possible values 0 – 1440 minutes. Default value is 60.

This timer will turn the printer off if it has not been used for the time set. Disable this feature by setting the time at 0. The printer will give a 1 minute warning before shutting off.

## D. Fonts

**PRINTEKMOBILE™**

Main    WIFI Config    Image Config    Device Config    **Fonts**    Graphics    Updates    Reset To Factory Defaults

### Fonts

**Upload Font File**

Choose File    No file chosen

Upload

**Remove Font File**

Select

Remove

### Current Font Mapping

Font Family Name	Index
Liberation Mono	A
Roboto Condensed	B
Dancing Script	C
MICR	D
Liberation Serif	E
OCRA	F
HAN NOM A	G
Instruction	H
Andika Basic	I
OCR B Std	J
Liberation Sans	K
Atrian 3	L
VCR OSD Mono	M

Note: may need to refresh page to update mapping after upload or removal.

### Font Aliases

Font Family Name	Alias
------------------	-------

## Upload Font File

Truetype Fonts (.ttf, .otf, .ttc and .bdf) can be uploaded here.

Languages like ZPL and CPCL can use the fonts by referring to them by their Font Family Name.

Printek emulation uses the Index value when selecting a font.

## Font Aliases

Languages like ZPL and CPCL can use an uploaded Font Alias Table so legacy jobs can have their font names mapped to other uploaded fonts. Contact Printek Technical Support at (800) 368-4636 for more information.

## E. Graphics

This menu will allow you to load a graphics file into printer memory for use in creating your output. For instance, logos can be stored for recall and use by your host program (see *Integrator's Guide* for more details).

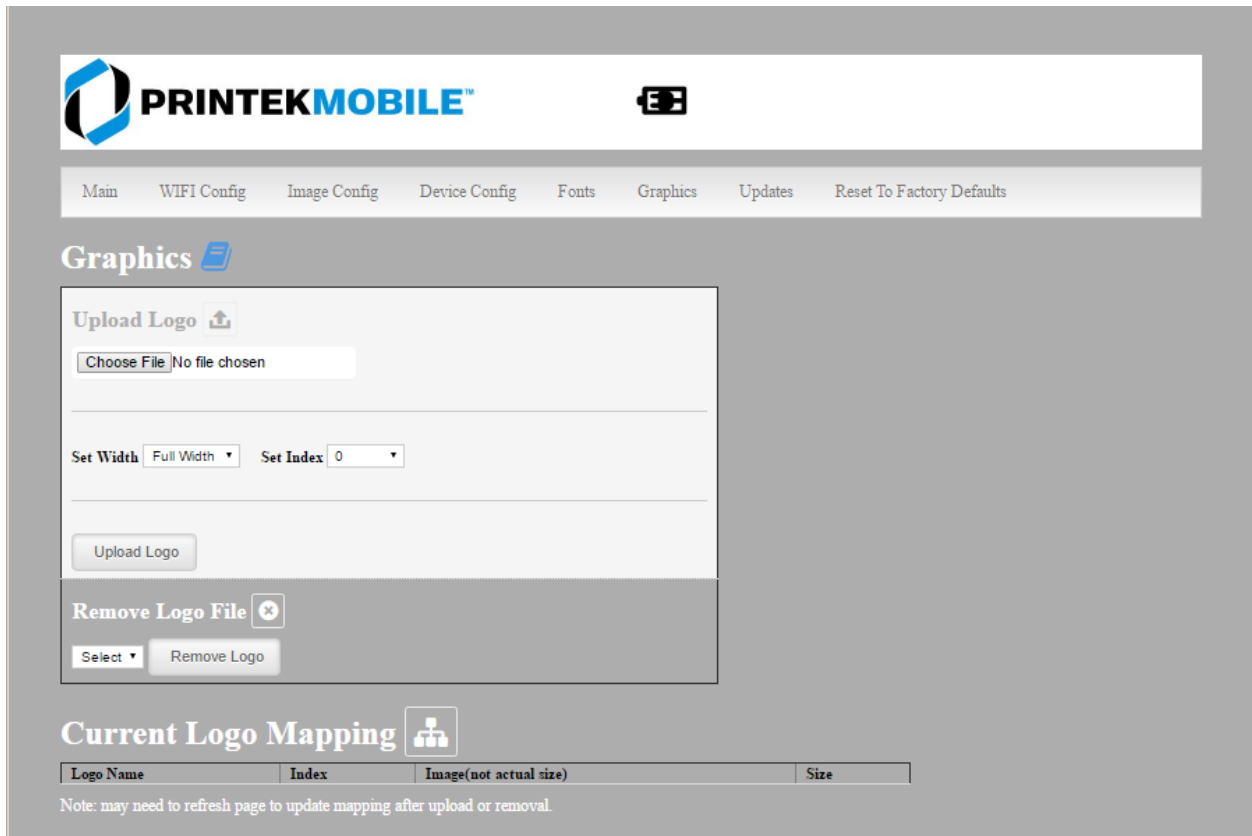

**PRINTEKMOBILE™**

Main   WIFI Config   Image Config   Device Config   Fonts   Graphics   Updates   Reset To Factory Defaults

### Graphics

Upload Logo 

Choose File No file chosen

Set Width Full Width   Set Index 0

Upload Logo

Remove Logo File 

Select Remove Logo

### Current Logo Mapping

Logo Name	Index	Image(not actual size)	Size
-----------	-------	------------------------	------

Note: may need to refresh page to update mapping after upload or removal.

### Upload File

Select the graphics file to load into printer memory. Acceptable graphics formats are .jpeg, .pbm, .pcx, .bmp, .png and .svg.

### Set Width

Select the width you want to use to display your logo: full width, half width, or quarter width.

### Set index

Depending on the Index value used, you can automatically print the graphics file as a header (prints at the beginning of the print job), footer (prints at the end of a print job) or use the graphics print command to print anywhere on your receipt or label. See *Integrator's Guide* for more information on graphics commands.

When selecting header, the graphics file will automatically print the logo at the beginning of each print job. When selecting footer, the graphics file will automatically print the logo at the end of each print job.

You must set each of these values before selecting Upload Logo or the default values will be associated with your image.

### Current Logo Mapping

Once uploaded into the printer memory, your image and settings will be displayed here.

## F. Update Printer Firmware, Upload Files to Printer Memory

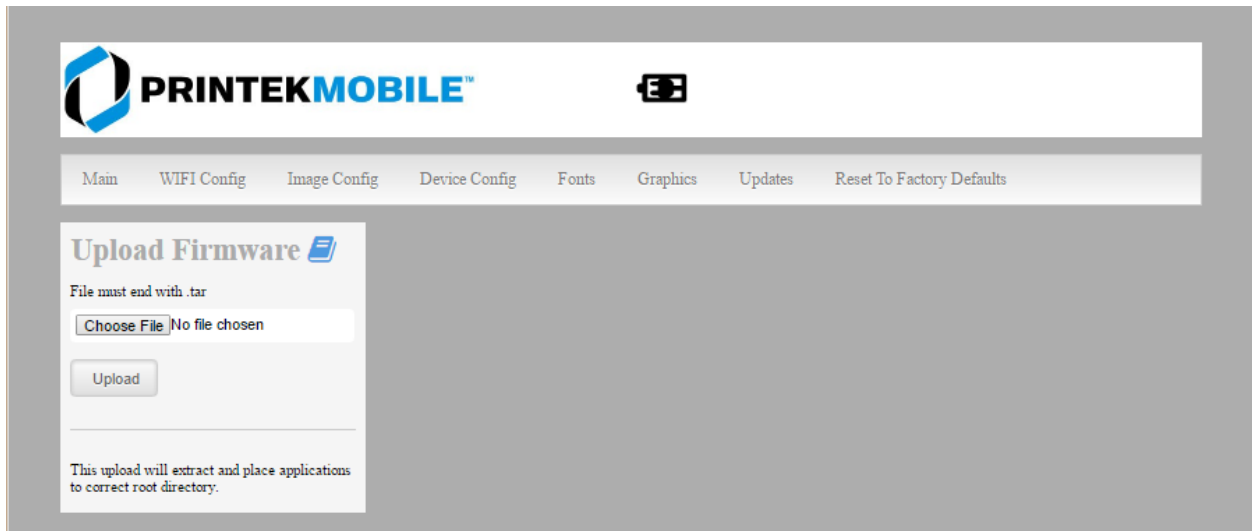

Printer Application Updates, OEM information and Manuals and more can be uploaded here. Contact Printek Technical Support at (800) 368-4636 for more information.

## G. Reset Printer Configuration to Factory Defaults (Safe Mode)

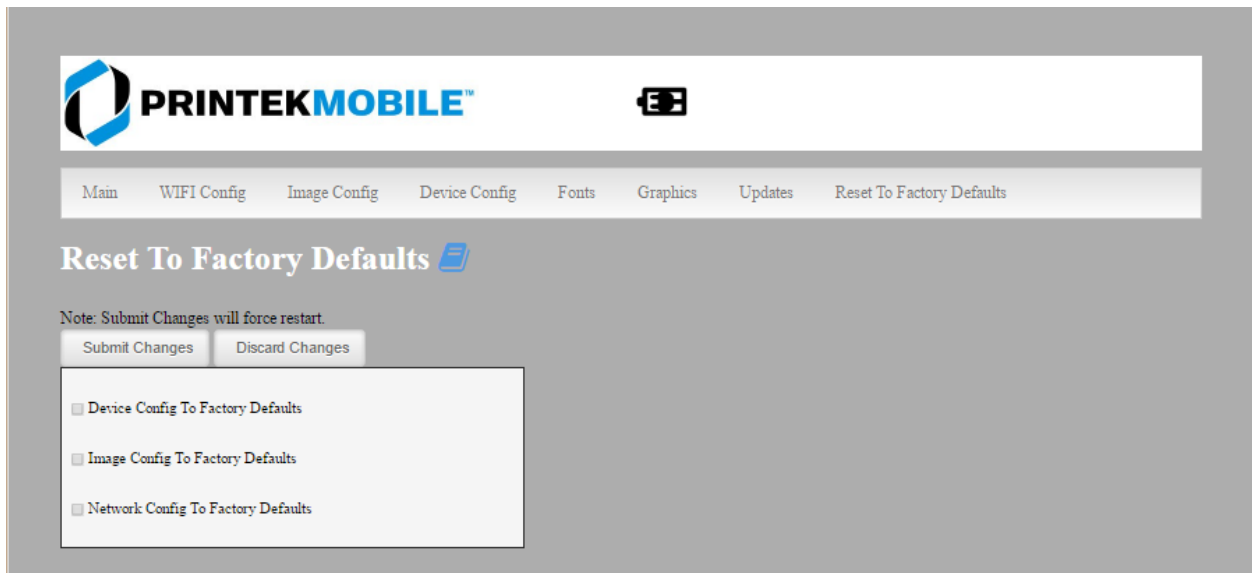

Printer settings can be restored to factory configurations. Note that WIFI network configurations will be lost when Network Config to Factory Defaults is checked.

# Printing Modes

---

There are two fundamental printing modes with mobile printers.

## A. ASCII Based Print Jobs

The host sends the print job as a series of lines of characters, some of which represent the text to be printed, while other portions are command codes which tell the printer which font to use, where to locate the text, what barcodes to use, etc. These text-based files are encoded in a print language specific to the target printer.

The FP530si understands ASCII based jobs in several different print languages. Refer to the [Appendix](#) or the *Integrator's Guide* for the list of print languages supported.

## B. Graphic Based Print Jobs

The host assembles the printed image as a series of lines of dots, and transmits this image as a sequence of data bytes that represent the dot patterns assembled. Often these jobs or files have some control characters on the front end and / or rear end of the dot pattern bytes to define their format, help control pagination, etc.

Windows drivers in particular encode the image as a graphic based print job before it is passed along to the printer.

In addition to accepting graphic jobs from its Windows driver, the FP530si can accept and print directly many other graphic image file types. This opens up the option to print job images from a variety of devices for which drivers or print utilities don't exist, such as some tablets and smartphones.

Please see the *Integrator's Guide* or your system integrator for more details.



# Integrating the Printer into your Business Applications

## Step by Step – Creating a Link from Host to Printer

---

### A. Windows Desktop Computers

#### Print Drivers

You may download the appropriate Windows driver from our website. Install the printer driver by the standard method for your version of Windows.

#### I. SERIAL

- a) Install the printer driver onto your host before connecting the printer. Follow prompts displayed during installation.
- b) Plug the printer into a serial port on your host system using data/power cable.
- c) Using the “Add Printer” wizard, install the printer using the driver file obtained from Printek and the serial COM port number that the printer is connected to.
- d) After the printer driver installs, the printer will appear as “Printek 3-inch printer” under the “Printers and Faxes” heading of your Windows “Devices and Printers” screen.

#### II. USB

- e) Install the printer driver onto your host before connecting the printer. Follow prompts displayed during installation.
- f) Plug the printer into a USB port on your host system using a mini-USB cable.
- g) The printer will appear in the “Unspecified” devices section. Right click on the icon.
- h) In the popup window, select the Hardware tab. Note the USB port number displayed.
- i) Using the “Add Printer” wizard, install the printer using the driver file obtained from Printek and the USB port number noted above.
- j) After the printer driver installs, the printer will appear as “Printek 3-inch printer” under the “Printers and Faxes” heading of your Windows “Devices and Printers” screen.
- a) Install the printer driver. Using the “Add Printer” wizard, install the printer using the driver file obtained from Printek and the COM port number noted above.
- b) After the printer driver installs, the printer will appear as “FP530si-serial #” under the “Printers and Faxes” heading of your Windows “Devices and Printers” screen.

#### III. Wi-Fi

**Note:** The following instructions are fundamentally the same for an Infrastructure or Wi-Fi Direct (peer to peer) setup. They also assume that you have already configured your Wi-Fi interface via the FP530si printer web page (see the section on Configuration).

- a) Perform a configuration printout to verify the printer Wi-Fi setup and to record the IP address assigned and the Port number.
- b) Install the printer as a local printer using the USB instructions above.
- c) In the “Devices and Printers” screen, right click the printer icon representing your mobile printer.
- d) Under Printer Properties, select the Ports tab, then select “Add a Port”

- e) In the new dialog box which appears, select “Standard TCP/IP ports”; this will open the Standard TCP/IP Printer Port wizard.
- f) Follow the on-screen prompts in this wizard. You’ll use the IP address recorded above to set up the port. In the same screen you can also name the port something familiar and relevant, and this will appear as the name of the printer to the user.
- g) After the port is detected, it will be displayed as a “generic network card” – accept this by clicking Next / Finish.
- h) After you are finished adding the port, Windows will report it as a “Standard TCP/IP port”; click OK to accept this.
- i) Close the Printer Port window.
- j) Now in the Printer Properties dialog box your IP address (or the familiar name you assigned above) will appear in the list of ports available. Select it to configure the port.
- k) Windows defaults standard TCP/IP ports to port number 9100. The FP530si Wi-Fi port number is internally set to 8023. Change the port number to 8023 in the Windows screen and click OK.
- l) Click “Apply” in the Printer Properties box.
- m) Your FP530si printer driver should now be properly coupled to the Wi-Fi parameters you have chosen.

## **B. Windows Tablets and Smartphones**

This feature and/or specific directions for use were not available as of this printing.

## **C. Android Tablets & Smart phones**

### **I. Wi-Fi**

This feature and/or specific directions for use were not available as of this printing.

## **D. Apple™ Tablets & Smartphones**

### **I. Wi-Fi**

This feature and/or specific directions for use were not available as of this printing.

# Media

---

## A. Standard Media

Printek offers a variety of media types. See [Appendix D](#) for detailed descriptions and ordering information. You may also visit our website or contact your PrintekMobile sales representative for a complete and up to date description of our consumables and accessory products.

## B. Black Mark Media Position

For automatic ticket printing, the Black Mark should be positioned as shown in the figure below. When using Mark Sensing mode (see [Configuration](#), earlier in this document), FieldPro printers will automatically position the output for tear-off and printing following a Form Feed command or by pressing the Paper Feed button.

For non-automatic paper positioning, refer to the *Integrator's Guide* for sensing and positioning commands.

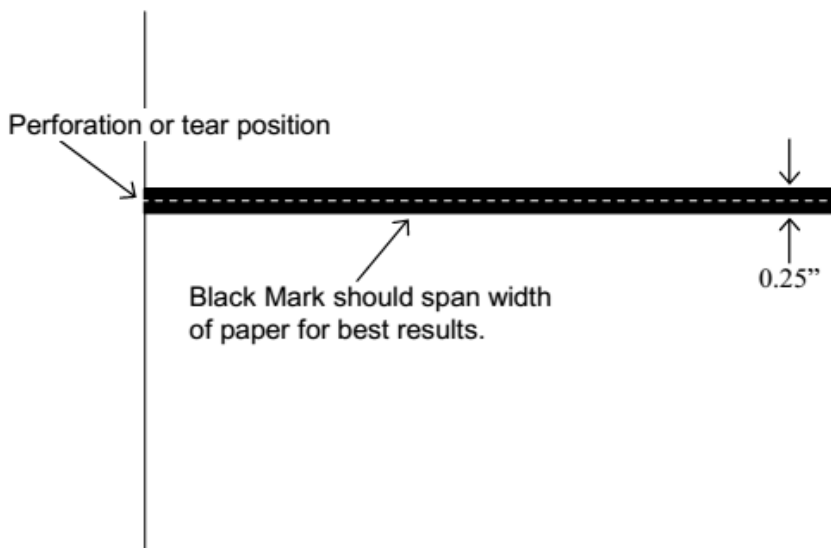

**Optimum Black Mark Position**

# Maintenance and Troubleshooting

---

## A. Cleaning

In normal environments, the printer should be cleaned after printing a few rolls of paper or if there are voids in the printout. For optimum performance and life, you should clean the Print Head and Platen Roller whenever you load new paper.

To clean the printer areas as described below, use a Thermal Head Cleaning Pen and MCR Cleaning Card available from Printek, or you may use cotton swabs moistened with isopropyl alcohol.

- Turn the printer off. Open the Paper Door and remove the paper.
- Using a Thermal Head Cleaning Pen, clean the white ceramic surface on the Print Head.  
**Caution:** Do not use sharp objects to clean the print head. This may damage the printer and require service. Such damage is not covered under warranty.
- Clean the Black Mark Sensor below the print head.
- Clean the Tear Bar.
- Clean the Platen Roller. Turn the Platen Roller with your finger to clean the entire surface.
- If a Magnetic Card Reader is installed, pass an MCR Cleaning Card through the MCR slot to clean the head.

You may also experience a buildup of paper dust in the printer. This may be removed using a can of compressed air or by vacuuming.

To clean the exterior of the printer, turn the printer off and use a soft cloth moistened with a mild detergent.

## B. Troubleshooting

When encountering problems, the cause may be the printer or may sometimes be due to other problems with your system. Please review the following tables to solve common problems you may encounter with your printer. You may also visit [www.printek.com](http://www.printek.com) for additional "FAQ's" that may assist you.

If you are still unable to solve your problem, please contact the company from whom you purchased your printer since they are most familiar with your systems. If they are unable to help you, please contact Printek Technical Support at (800) 368-4636.

## I. General Error Conditions

Whenever the printer detects an error condition the Alert (red) Indicator will either flash or stay on. In some cases the audible alarm will also sound. Please refer to the following table for a list of what causes these conditions and how they may be corrected.

Error Indicator	Possible Cause	Solution
Flashes	Paper Out or Paper Door not fully closed	Make sure the door is fully closed by opening the door and closing it again until the door “clicks” closed. Check the platen roller for damage.
Stays On, With Alarm	Print job too large for printer memory	Divide long documents into individual pages. Printer power must be cycled to clear error.

## II. Fault Description and Resolution

Problem	Possible Cause	Solution
Printer will not turn on.	D-connector not plugged in	Remove and reinstall the 9-pin D-connector on the side of the printer
	No power	Check pin 8 of the D-connector for positive voltage.
Printer turns itself off.	Not enough power is being supplied to the printer.	Check pin 8 of the D-connector for positive voltage.
	Electrostatic discharge	May occur in extreme low humidity conditions. Turn printer back on with power button.
Poor print quality.	Print head dirty	Clean print head. Refer to “ <a href="#">Maintenance</a> ” section of this document.
	Poor quality or “old” paper	Verify paper from approved source. Try new roll of paper.
	Obstruction in paper path, or paper improperly installed	Check paper path and reinstall paper (see “ <a href="#">Quick Start Instructions</a> ”).
Paper not feeding.	Poor quality paper	Verify paper from approved source.
	Paper Door not fully closed	Verify door is closed.
	Dirty Black Mark/Paper Sensor	Clean Sensor as described in “ <a href="#">Maintenance</a> ” section of this document.

<b>Problem</b>	<b>Possible Cause</b>	<b>Solution</b>
Paper does not advance to black mark reliably.	Black Mark density/contrast	Adjust Mark Sensitivity as described in Device Settings Menu .
	Poor quality paper	Verify paper from approved source.
Paper not feeding reliably or print is compressed vertically	Heavy or thick forms; specialty paper with slick finish	Lower the Max Paper Speed as described in Device Config Menu .
	Paper Door not fully closed	Verify door is closed.
Print Garbled.	Improper Interface configuration	Verify printer and host settings match.
	Paper Door not fully closed	Verify door is closed.
Printer will not print.	Paper not loaded correctly	Check paper path and reinstall paper (see " <a href="#">Quick Start Instructions</a> ").
	Improper Interface configuration	Verify printer and host settings match. Print a self-test to verify printer settings and to verify printer is functioning properly.

## C. Obtaining Service

If service is required for your printer, please contact the company where you purchased your printer.

If they are unable to assist you, contact Printek Customer Service at (800) 368-4636 to obtain a Return Authorization Number. Printers without Return Authorization will not be accepted.

# APPENDIX

---

## A. Appendix A – FieldPro 530si Printer Specifications

### Printing Specifications

Printing Method: Direct thermal.  
Printing Resolution: 203 dpi (8 dots per mm).  
Printing Speed: Up to 5 ips.  
Printing Width: Up to 2.8 inches (72 mm).

### Fonts/Characters/Bar Codes

Fonts: Virtually all TrueType fonts, from 6 cpi to 34 cpi depending on emulation chosen, plus scaling.  
International Characters: Most common sets available.  
Unicode support.  
Bar Codes: Virtually all 1D and 2D codes supported, depending on emulation chosen.  
Downloadable firmware, fonts, graphics, and logos.

### Connectivity

Standard (All Units): USB 2.0 PNP, (-pin serial connection).  
Wireless Options:

#### Wi-Fi 802.11b/g/n compatible

### Software

Drivers and Utilities: Drivers for XP, WIN 7, WIN 8, WIN 10.  
Compatible with Windows CE/Pocket PC, Windows Mobile and Android.  
Print utilities and SDK's for all platforms. Native App and Web printing.

Printer Setup via internal web page, access with browser from any host (tablets and smartphones included).  
Emulations: Emulates many popular printer brands and languages including: Zebra CPCL and ZPL, and ESC POS. Firmware can be upgraded as new emulations become available.  
Supports direct printing of Postscript, PDF, PBM, JPG, PNG, BMP, SVG, & TIFF files.

### Print Media

Paper Type: Direct Thermal Roll.  
Roll Size: Maximum roll diameter 2.0" (51 mm), roll widths up to 3.125" (80 mm).  
Roll Capacity: Approx. 94' 28.6 m), creating 188 6" long receipts.  
Core Size: 0.75" Recommended (19 mm).

### Physical Specifications

L x W x H: 6.1" x 4.6" x 3.6" (15.5 x 11.7 x 9.3 cm).  
Weight: 21.9 ounces

### Environmental Specifications

Operating Temp: 0° to 122°F (-18° to 40°C).  
Storage Temp: -4° to 140°F (-20° to 60°C).  
Humidity: 10% to 90% RH (non-condensing).  
Rated IP54 per IEC 529

### Operator Controls and Indicators

3 LED indicators for general fault, power status indication. Buttons for power and paper feed. Sensors for paper out, black mark detection, and door open. "Gas gauge" on battery door.

### Memory Capacity

256 MB Flash, 512 MB DDR2.  
Standard memory supports large and graphic intensive print jobs.

### Durability and Reliability

Survives multiple 6 foot drops to concrete (each face) per IEC 68-2.  
MTBF: 10,000 hours in normal use.

### Regulatory Approvals

FCC Class B, CE mark, RoHS, UL listed AC adapters, e-mark.

### Warranty

2-year printer warranty on the entire printer—case and print head included.

### Options and Accessories

- Universal Port, 3-Track Simultaneous Read MCR, barcode scanners, biometrics, RFID.
- In-Vehicle Power Adapter, 12 to 24 VDC
- Shoulder Strap
- Data Cables; USB
- Media in Case Quantities
- Popular Mounting Systems
  - In-Vehicle Systems
  - Cart Mounting Systems

## Glossary of Terms

---

802.11	Wireless networking communication standards created by IEEE.
Ad-Hoc	A Wi-Fi network consisting of only stations (no access point). Same as Peer-to-Peer.
authentication	The process a Wi-Fi station uses to identify itself to another station.
baud rate	The rate at which characters are transmitted over a serial interface. This is also often referred to as bits per second.
Bluetooth	A definition for short range radio frequency communications.
client	Any node on a network that requests services from another node (server).
character pitch	The horizontal spacing of characters. Measured in cpi.
cpi	Characters per inch.
default	Value or configuration assumed when the printer is powered on or reset.
DHCP	Dynamic Host Configuration Protocol. A method used to centrally control the assignment of IP addresses on a network.
dpi	Dots per inch. Generally used to refer to graphics density or resolution.
font	A group of characters of a given shape or style.
infrastructure	A Wi-Fi network consisting of stations connecting to a wired network or other stations via an access point.
interface	The connection between the printer and the host computer.
IP	Internet Protocol. A specification for packets, or datagrams, of data and an addressing method to allow the exchange of data with another system. Must be combined with another protocol such as TCP to create a complete connection with the other system.
LAN	Local Area Network.
LED	Light emitting diode.
lpi	Lines per inch.
margin	An area along any edge of a form where data may not be printed.
Peer-to-Peer	A network consisting of only stations (no access point or central server). Same as Ad-Hoc.



reset	Initialization of various operating features of the printer to the value or state assumed when the printer is powered on.
server	Any node on a network that provides services to another node (client).
SSID	Service Set Identifier. An identifier attached to packets on a Wi-Fi network that identify the particular network the packets are intended for.
TCP	Transmission Control Protocol. A specification that controls the connection between systems on a network.
top of form	The vertical position where the first line is printed on the paper. Also the position the paper is advanced to when a form feed (FF) character is received from the host or the Form Feed button is pressed on the printer's control panel.
USB	Universal Serial Bus.
WAN	Wide Area Network. Refers to connections that allow one LAN to communicate with another LAN(s).
WEP	Wired Equivalent Privacy. A security protocol for wireless LANs designed to provide data security similar to a wired LAN.
Wi-Fi	Refers to any of the IEEE 802.11 standards.
WLAN	Wireless Local Area Network. A LAN made up of wireless nodes.

# Index

---

- 802.11, 28
- Add Enterprise Network, 9
- Add Personal Network, 9
- Address Method, 9
- Ad-Hoc, 28
- Alert, 6
- Android, 3, 17
- Android Tablets & Smart phones, 17
- Apple, 3, 18
- authentication, 28
- Available Networks, 9
- Backup Distance Before Printing, 12
- battery, 3, 5, 7, 20, 21, 22, 23
- Battery Care, 20
- Battery Disposal, ii
- Battery Installation, 5
- baud rate, 28
- Bluetooth, ii, 2, 8, 9, 16, 17, 18, 28
- Canadian Department of Communications Radio Interference Statement, i
- character pitch, 28
- Charge Battery, 5
- Charging the Battery, 20
- Cleaning, 20, 27
- client, 28
- Com Port, 16
- Configuration, 7, 19, 28
- Connectivity Parameters, 8
- Contrast, 12
- Control Panel, 6
- CPCL, ii, 10
- cpi, 28
- Current Emulation, 10
- Current Logo Mapping, 13
- Current Printer Config, 9
- default, 28
- Default Font, 10
- Default Text Line Spacing, 10
- Device Config, 11
- DHCP, 28
- discover name, 16, 18
- Discoverability, 9
- dpi, 28
- driver, 16
- Drivers, 16
- Fault Description and Resolution, 22
- FCC Part 15 Class B, i
- features, 29
- form, 29
- Front Paper Sensor Threshold, 11
- Gap Paper Sensor Threshold, 12
- GateWay, 9
- General Error Conditions, 22
- Graphics, 13
- IMAGE, 10
- Image Parameters, 10
- infrastructure, 28
- interface, 28
- IP Address, 9
- IP54, 3
- LAN, 28
- LED, 28
- Left Margin, 12
- lpi, 28
- Maintenance, 2, 20, 23, 24
- margin, 28
- Mark Seeking, 11, 12
- Max Mark Search Distance, 12
- Max Paper Speed, 11, 23
- Maximum Battery Life, 20
- Media, 2, 19, 25, 26, 27
- Mounting Options, 27
- MT3, 10
- Obtaining Service, 24
- Paired Mode, 8
- pairing code, 16
- Paper Energy Values, 12
- Paper Feed Button, 6
- Paper Load, 4
- passkey, 16, 18
- PDF, 10
- Peer-to-Peer, 28
- PIN, 8, 9
- POSTSCRIPT, 10
- power, i, ii
- Power Button, 6
- Power On, 5
- Quick Start Instructions, 4
- Rear Paper Sensor Threshold, 12
- reset, 29
- Role Policy, 8
- Safety Information, 21
- Security, 8
- Self-Test, 6, 21
- server, 29
- Set index, 13
- Set Width, 13
- Specifications, 2, 3, 25, 26
- SSID, 29
- Stop Distance after Mark, 12
- SubNetMask, 9
- Supplies and Accessories, 2, 27
- TCP, 29
- Testing the Power Adapter and Battery, 21
- Troubleshooting, 2, 20, 21, 22
- Units, 11
- Upload Digital Certificate, 9
- Upload File, 13
- USB, 16, 29
- USB port, 2, 16
- WAN, 29
- web page, 7
- WEP, 29
- Wi-Fi, ii, 2, 17, 28, 29
- WI-FI Config, 8, 9
- Wifi Port, 9
- Windows, ii, 3, 15, 16, 17
- WLAN, 29