

USER'S MANUAL

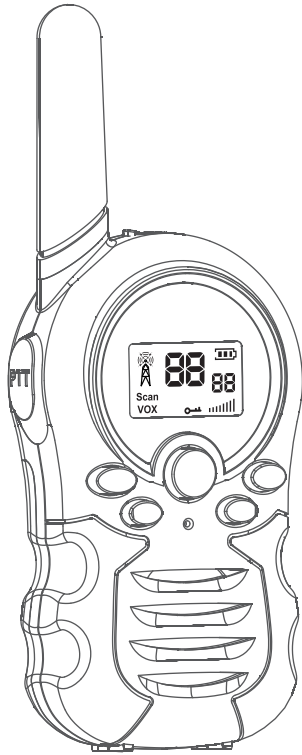

Product

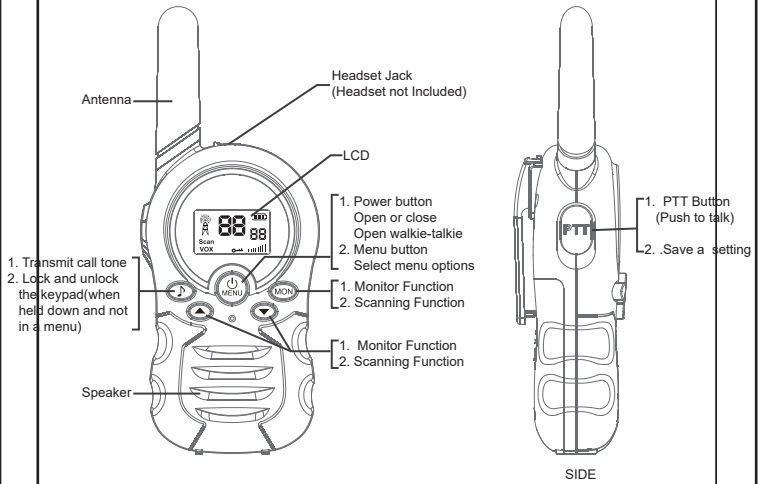
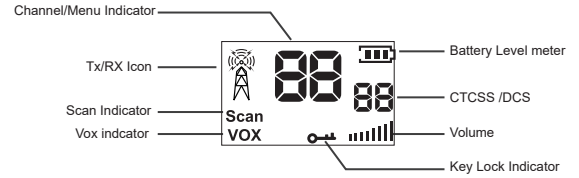

Start Guide

Installation the battery

1. Make sure your radio is turned OFF.
2. Remove the battery compartment door.
3. Install the 4 NiMH rechargeable battery or 4 AAA Alkaline batteries into the battery compartment.
4. Replace the battery compartment door.

Basic radio operations

1. Press **POWER** to turn on.
2. Press **MENU** to enter the channel settings, the channel display pattern starts flashing, with **▲/▼** to select. Press **PTT** to confirm and exit.
3. Press **MENU** twice to enter the setting. OFF for no code, 01~38 for CTCSS code, 39-99 for DCS code.
4. Press **MENU** for 3 times to enter the Vox function selection. there are OFF, 1,2,3 these 3 gear sensitivity optional.
5. Press **MENU** for 4 times to enter the CALL tone selection function. They are 01 to 10 sounds available.
6. Press **MENU** for 5 times to enter the key tone selection function, select the button when the ON button will beep a tone, select the OFF button when there is no tone.
7. Press **▲/▼** for 6 times to enter the launch end of the tone selection function, with **MENU** to select. select ON to release the **PTT** will have a tone, the opposite choice of OFF there is no tone.
8. Press **MENU** for 7 times and exit can also press **PTT** to confirm the exit menu.

Note:

It doesn't has charging function, it can't be charged directly through charger base and so on, it only can be charged by a NiMH rechargeable battery. When installing the battery, please pay attention to the corresponding positive and negative placement!

Battery Meter

	Indicates that the battery is fully.
	Indicates that the battery is Low.
	The LCD appears icon please replace batteries immediately.

Turning Your Radio ON / OFF

1. To turn your radio ON, press and hold **POWER** button 3 seconds.
2. To turn your radio OFF, press and hold **POWER** button 3 seconds again.



Adjusting the Volume

1. Press the **▲** button to increase the speaker volume.
2. Press the **▼** button to decrease the speaker volume.
3. The speaker volume level is indicated on the LCD displayed (1~8 Level).

Setting a Channel

1. With the radio on, press **MENU** the current channel flashes.
2. Press **▲/▼** to set the channel.
3. Press **PTT** to save the channel setting.

Talking and Listening

To communicate, all radios in your group must be set to the same channel and interference Eliminator Code.
To talk, press and hold **PTT** Hold the radio 2~3 inches away from your mouth and speak directly into the microphone. Do not cover the microphone while talking.
When you finish speaking, release **PTT** (press to talk, release to listen).

Monitor Function (Enables you to listen for weak signals on the current channel)

1. **TO turn the Monitor Mode ON:** Press the **MON** button for continuous listening. The icon appears.
2. **TO turn the Monitor Mode OFF:** Press the **MON** button to "Normal" mode.

Special Features

Interference Eliminator Code

Interference Eliminator Codes help minimize interference by providing you with a choice of code combinations. To set the code for a channel:

1. Press **MENU** until the code starts to flash.
2. Press **▲/▼** to select the code 0-99 OR 99-0.
3. Press **PTT** to save the code setting.

You can set a different code for each channel using this procedure.



Note: You must set the Interference Eliminator Codes to 0 on an FRS radio that uses Interference Eliminator Codes to communicate with other FRS radios that do not have Interference Eliminator Codes.



TOT (TIME OUT Timer)

In order to prevent the use of the channel and save power, walkie-talkie has emission limit function, then the launch time is less than 180 seconds.

When reached the default time , the radio stops launching with "beep" tone.

Locking the Keypad

To avoid accidentally changing your radio settings, press  for 3 seconds or until  displays and there is a "beep" tone. You can turn the radio on and off, you can't adjust the volume, menu, and monitor channels. All other functions are locked.

To unlock the radio, press  for 3 seconds or until  is no longer displayed. And there is a "beep" tone.

Note: When locking , only the **PTT** and  are valid.

Setting and Transmitting Call Tones

Your radio can transmit different call tones to other radios in your group so you can alert them that you want to talk.

4

To set a call tone:

Your radio can transmit different call tones to other radios in your group so you can alert them that you want to talk. Your radio has 10 call tones from which choose.

1. Press **MENU** button until  icon appears. The current call tone setting will flash.
2. Press **▲/▼** to change and hear the call tone.
3. Press **PTT** to save .

Voice Operated Transmission (Vox)

Transmission is initiated by speaking into the microphone of the radio instead of the pushing the PTT button.

Note: Note Level "N"(OFF) disables VOX Levels 1-3 set the sensitivity of the VOX circuit Use level 1 in quiet environments, and use level 3 in very noisy environments. You can find the appropriate sensitivity level by speaking into the microphone.

Scanning Channels

Features your radio to scan for active channels .when activity is detected, your radio lands (stays) on that channel for 5 seconds. To transmit on that channel ends, your radio continues scanning to other channels.

To turn the channel scan ON:

1. press **MON** to enter Scan mode.
2. press **MON** or **PTT** to turn off Scan mode.

Note:

During scanning , press the **▲/▼** key to change the direction of the scan.

Safety and General Information

1. If you carry any kind of personal medical device, consult a doctor before use.
2. To avoid the risk of burns, do not use the device if the aerial is damaged in any way.
3. Never use the device in close proximity to a radio to avoid interference.
4. Position the transmitter and antenna at least 25 mm from your mouth.
5. The device cannot be used to contact the emergency services.

5

Technical specifications

Device Type:	Portable
Exposure Category:	General Population/Uncontrolled Exposure
Antenna Type(s):	External Antenna
Body-Worn Accessories:	Belt Clip
Face-Head Accessories:	None
Modulation Type:	FM
Frequency Band:	462.55- 467.7125 MHz
Target ERP Power:	462 MHz band:20 dBm; 467 MHz band: 19 dBm
Power Source:	DC 6.0V by AAA*4 Alkaline battery
Dimensions (L*W*H):	14.6 cm (L) x 5.8 cm (W) x 3.6 cm (H)
Normal Operation:	Face Up and Body-worn

WARNING

This device complies with part 15 of the FCC Rules. Operation is subject to the following two conditions: (1) This device may not cause harmful interference, and (2) this device must accept any interference received, including interference that may cause undesired operation.

IMPORTANT NOTE:

Note: This equipment has been tested and found to comply with the limits for a Class B digital device, pursuant to part 15 of the FCC Rules. These limits are designed to provide reasonable protection against harmful interference in a residential installation. This equipment generates, uses and can radiate radio frequency energy and, if not installed and used in accordance with the instructions, may cause harmful interference to radio communications. However, there is no guarantee that interference will not occur in a particular installation. If this equipment does cause harmful interference to radio or television reception, which can be determined by turning the equipment off and on, the user is encouraged to try to correct the interference by one or more of the following measures:

- Reorient or relocate the receiving antenna.
- Increase the separation between the equipment and receiver.
- Connect the equipment into an outlet on a circuit different from that to which the receiver is connected.
- Consult the dealer or an experienced radio/TV technician for help.

6



WARNING

SAFETY INFORMATION

Your wireless hand-held portable transceiver contains a low power transmitter. This product sends out radio frequency (RF) signals when the Push-to-Talk (PTT) button is pressed. The device is authorized to operate at a duty factor not to exceed 50%. In August 1996, the Federal Communications Commissions (FCC) adopted RF exposure guidelines with safety levels for hand-held wireless devices. To control your exposure and ensure compliance with the general population or uncontrolled environment exposure limits, keep the radio at 2.5 cm away from the face, use non-approved accessories may cause the radio to exceed RF exposure limits.

Any Changes or modifications not expressly approved by the party responsible for compliance could void the user's authority to operate the equipment and should not be made. To comply with FCC requirements, transmitter adjustments should be made only by or under the supervision of a person certified as technically qualified to perform transmitter maintenance and repairs in the private land mobile and fixed services as certified by an organization representative of the user of those services. Replacement of any transmitter component (crystal, semiconductor, etc) not authorized by the FCC equipment authorization for this radio could violate FCC rules.

Note: Use of this radio outside the country where it was intended to be distributed is subject to government regulations and may be prohibited.

7