

5103E, 5103, 5103S, 5203, 5104 And 5204 Tractors

OPERATOR'S MANUAL 5103E, 5103, 5103S, 5203, 5104 And 5204 Tractors

OMRE73705 Issue A7 (ENGLISH)

CALIFORNIA
Proposition 65 Warning

Diesel engine exhaust and some of its constituents are known to the State of California to cause cancer, birth defects, and other reproductive harm.

If this product contains a gasoline engine:

 **WARNING**

The engine exhaust from this product contains chemicals known to the State of California to cause cancer, birth defects or other reproductive harm.

The State of California requires the above two warnings.

Introduction

Foreword

READ THIS MANUAL carefully to learn how to operate and service your machine correctly. Failure to do so could result in personal injury or equipment damage. This manual and safety signs on your machine may also be available in other languages (see your John Deere dealer to order).

THIS MANUAL SHOULD BE CONSIDERED a permanent part of your machine and should remain with the machine.

MEASUREMENTS in this manual are given in both metric and customary U.S. unit equivalents. Use only correct replacement parts and fasteners. Metric and inch fasteners may require a specific metric or inch wrench.

RIGHT-HAND AND LEFT-HAND sides are determined by facing the direction of forward travel.

WRITE TRACTOR SERIAL (CHASSIS) NUMBER in the Specification or Identification Numbers section. Accurately record all the numbers to help in tracing the machine should it be stolen. Your dealer also needs these numbers when you order parts. File the identification numbers in a secure place off the machine.

SETTING FUEL DELIVERY BEYOND PUBLISHED factory specifications or otherwise overpowering will result in loss of warranty protection for this machine.

BEFORE DELIVERING THIS MACHINE, your dealer performed a predelivery inspection. After operating for the first 100 hours, schedule an after-sale inspection with your dealer to ensure best performance.

THIS TRACTOR IS DESIGNED SOLELY for use in customary agricultural or similar operations ("INTENDED USE"). Use in any other way is considered as contrary to the intended use. The manufacturer accepts no liability for damage or injury resulting from this misuse, and these risks must be borne solely by the user. Compliance with and strict adherence to the conditions of operation, service and repair as specified by the manufacturer also constitute essential elements for the intended use.

THIS TRACTOR SHOULD BE OPERATED, serviced and repaired only by persons familiar with all its particular characteristics and acquainted with the relevant safety rules (accident prevention). The accident prevention regulations, all other generally recognized regulations on safety and occupational medicine and the road traffic regulations must be observed at all times. Any arbitrary modifications carried out on this tractor will relieve the manufacturer of all liability for any resulting damage or injury.

NR25796,0000344 -19-17JAN07-1/2

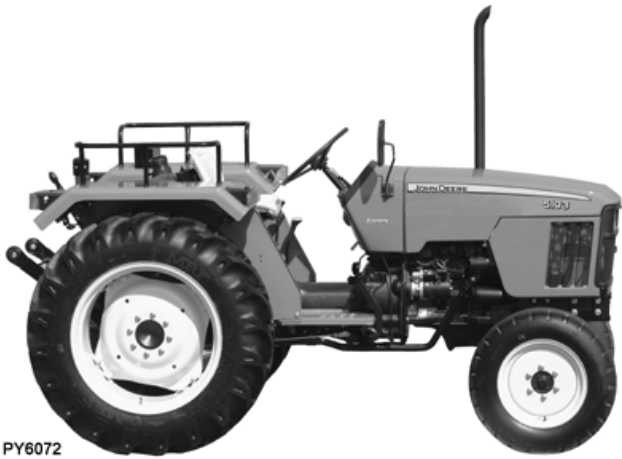

PY6072

John Deere 5103E Tractor

PY6072 -UN-06AUG06



PY6069

John Deere 5103 Tractor

PY6069 -UN-06AUG06



PY6071

John Deere 5103S Tractor

PY6071 -UN-06AUG06



PY6077

John Deere 5203 Tractor

PY6077 -UN-06AUG06



PY6839

John Deere 5104 Tractor

PY6839 -UN-11JAN07



PY6840

John Deere 5204 Tractor

PY6840 -UN-11JAN07

NOTE: Tractor shown may have optional equipment.

Contents

	Page		Page
Safety	05-1	Restart Stalled Engine	45-8
Safety Signs	10-1	Avoid Idling the Engine	45-8
Controls and Instruments		Observe Engine Work and Idle Speeds	45-9
Tractor Controls	15-1	Working With Speed/Hour Meter	45-9
Instrument Panel	15-3	Stopping the Engine	45-10
Instrument Panel (5103E Tractor)	15-3	Using Booster Battery	45-11
Lights		Driving the Tractor	
Light Switch Positions	20-1	Operator Training Required	50-1
Using Headlights	20-2	Driving on Public Roads	50-1
Using High Beam Indicator	20-2	Operating Transmission	50-3
Using Tail Lights	20-3	Shifting Transmission	50-3
Using Turn Signals	20-4	Operating Transmission	50-4
Using Hazard Lights	20-5	Selecting a Gear	50-5
Using Flood Lamp	20-6	Using Brakes	50-6
Seven-Terminal Outlet	20-6	Using Differential Lock (Optional For 5103E Tractor)	50-7
Operator's Platform		Stopping Tractor	50-8
Selecting Seat Position	25-1	Rockshaft and 3-Point Hitch	
Adjusting Ride Comfort	25-1	Match Tractor Power to Implement	55-1
Break-In Period		3-Point Hitch Components	55-1
Observe Engine Operation Closely	35-1	Rockshaft Control Levers	55-2
Break-In Service	35-2	Setting Position Control Lever Stop	55-2
Prestarting Checks		Using Rockshaft Position Control	55-3
Service Daily Before Start-Up	40-1	Using Draft Control	55-4
Operating the Engine		Adjusting Rockshaft Rate-of-Drop/ Implement lock	55-5
Before Starting the Engine	45-1	Attaching Tipping Trailer	55-5
Starting the Engine	45-2	Preparing Implement	55-6
Check Instruments After Starting	45-3	Positioning Center Link	55-7
Oil Pressure Indicator	45-3	Attaching Implements to 3-Point Hitch	55-8
Charging System Indicator	45-4	Adjusting Hitch Side Sway	55-9
Air Restriction Sensor	45-4	Leveling the Hitch	55-10
Air Restriction Sensor (5103E Tractor)	45-5	Adjusting Lateral Float	55-11
Coolant Temperature Gauge	45-5	Adjusting Rockshaft Control Lever Friction ...	55-11
Watch Fuel Level	45-6	Warming Hydraulic System Oil	55-12
Watch Fuel Level (5103E Tractor)	45-6	Drawbar and PTO	
Changing Engine Speeds	45-7	Observe Drawbar Load Limitations	65-1
Warming Up the Engine	45-7	Stay Clear of Rotating Drivelines	65-1

Continued on next page

All information, illustrations and specifications in this manual are based on the latest information available at the time of publication. The right is reserved to make changes at any time without notice.

COPYRIGHT © 2006
DEERE & COMPANY
Moline, Illinois
All rights reserved
A John Deere ILLUSTRATION® Manual
Previous Editions
Copyright © 2004

Page	Page		
Attaching PTO-Driven Implement	65-2	Lubricant Storage	85-4
Operating Tractor PTO	65-3	Diesel Engine Oil	85-4
Adjusting PTO Clutch Operating Rod	65-5	Diesel Engine Coolant	85-5
Ballast		Use Correct Transmission-Hydraulic Filter Element	85-6
Planning for Maximum Productivity	70-1	Transmission and Hydraulic Oil	85-6
Selecting Ballast Carefully	70-1	Grease	85-7
Matching Ballast to Load Work	70-1	Service and Maintenance	
Measuring Wheel Slip—Manually	70-2	Observe Service Intervals	90-1
Ballast Limitations	70-3	Break-In Service	90-1
Ballasting Front End for Transport	70-3	Service Intervals	90-2
Ballasting Front End for Transport (5103E Tractor)	70-4	Service—Every 10 Hours	
Ballasting Tractor	70-4	Check Engine Oil Level	95-1
Determining Maximum Rear Ballast	70-5	Check Coolant Level	95-1
Determining Maximum Front Ballast	70-5	Drain Water and Sediment From Fuel Filter	95-2
Using Cast Iron Weights	70-5	Lubricate as Necessary	95-2
Installing Rear Cast Iron Weights	70-6	Service—Every 50 Hours	
Using Liquid Weight	70-6	Check Transmission-Hydraulic System Oil Level	100-1
Wheels, Tyres and Treads		Clean and Check Battery	100-1
Service Tyres Safely	75-1	Lubricate Front Axle Pivot Pin	100-2
Check Implement-to-Tyre Clearance	75-1	Lubricate Steering Spindles	100-2
Check Tyre Inflation Pressure	75-2	Lubricate Clutch Pedal and Brake Pedal	100-3
Tyre Inflation Pressure Chart	75-3	Inspect Tyres and Loose Hardwares	100-4
Tighten Wheel/Axle Hardware Correctly	75-3	Service—Every 250 Hours	
Tighten Bolts— Front Axle	75-3	Change Engine Oil and Filter	110-1
Tighten Bolt Adjustable Front Axle—If Equipped	75-4	Service Air Cleaner	110-1
Tighten Bolts—Rear Axle (M-14 Bolts)	75-5	Replace Fuel Filter Inserts	110-2
Tighten Bolts—Rear Axle (M-20 Stud)	75-6	Inspect and Adjust Alternator/Fan Belt	110-2
Observe Rear Wheel Tread Width Limitations	75-6	Lubricate 3-Point Hitch	110-3
Tread Settings—Multi-Position Rear Wheels	75-7	Check Neutral Start System	110-3
Tread Settings—Adjustable Front Axle—If Equipped	75-8	Check and Adjust Clutch Pedal Free Play	110-4
Checking Toe-In	75-9	Check and Adjust Brake Pedal Free Play	110-5
Adjusting Toe-In	75-10	Service—Every 500 Hours	
Adjusting Toe-In - Adjustable Front Axle— IF Equipped	75-11	Replace Transmission-Hydraulic Filter	112-1
Transporting		Service—Every 600 Hours	
Use Safety Lights and Devices	80-1	Clean Engine Crankcase Vent Tube	115-1
Driving Tractor on Roads	80-1	Pack Front Wheel Bearings (Only For Carraro Front Axle)	115-1
Transport on Carrier	80-4	Check Hoses and Hose Clamps for Tightness	115-2
Towing Tractor	80-4	Lubricate Rear Axle Bearings	115-3
Fuels, Lubricants and Coolant		Check Engine Idle Speeds	115-4
Handle Fuel Safely—Avoid Fires	85-1	Check Front Axle Pivot Pin	115-4
Handle Fluids Safely—Avoid Fires	85-1	Adjust Engine Valve Clearance	115-5
Fuel Storage	85-2		
Diesel Fuel	85-2		
Diesel Fuel Filters	85-2		
Fill Fuel Tank	85-3		

Continued on next page

	Page		Page
Service—Every 1250 Hours			
Change Transmission-Hydraulic Oil and Filter	120-1	Connecting Alternator Wiring For (5103E) . . .	140-21
Clean Transmission-Hydraulic Pickup Screen	120-2	Connecting Alternator Wiring For (5103, 5103S, 5203)	140-22
Service—Annually			
Replace Air Cleaner Elements	125-1	Locating Fusible Link	140-22
Service—2 Years/2000 Hours			
Flush Cooling System.	130-1	Locating Fuses	140-23
Service—As Required			
Service Air Cleaner	135-1	Fuse Size and Function	140-24
Adjust Throttle Friction	135-1	Fuse Size and Function (5103E Tractor) . . .	140-25
Service			
Additional Service Information	140-1	Aiming Headlights.	140-26
Service Tractor Safely	140-2	Adjusting Headlights.	140-27
Engine Break-In Oil	140-3	Replace Headlight Bulb	140-28
Work In Ventilated Area	140-3	Replace Tail Light and Warning Light Bulbs	140-29
Using High-Pressure Washers	140-3	Replace Flood Lamp Bulb	140-29
Opening Hood	140-4	Checking Tyres	140-30
Removing Side Screens	140-4	Troubleshooting	
Removing Hood	140-5	Engine Troubleshooting	145-1
Air Intake System Components	140-5	Transmission Troubleshooting	145-4
Service Air Cleaner at Regular Intervals.	140-6	Hydraulic System Troubleshooting	145-5
Service Air Cleaner at Regular Intervals (5103E Tractor).	140-6	Brakes Troubleshooting	145-5
Checking Air Intake System	140-7	Rockshaft and 3-Point Hitch Troubleshooting	145-6
Removing Primary Air Cleaner Element	140-8	Electrical System Troubleshooting	145-8
Cleaning Primary Element	140-8	Tractor Storage	
Washing Primary Element	140-9	Storing Tractor	150-1
Inspecting Element.	140-9	Removing Tractor From Storage	150-4
Storing Element	140-10	Specifications	
Replacing Alternator/Fan Belt.	140-10	John Deere 5103E Tractor	155-1
Fuel System Components	140-11	John Deere 5103 Tractor	155-2
Do Not Modify Fuel System	140-11	John Deere 5103S Tractor	155-3
Bleeding Fuel System.	140-12	John Deere 5203 Tractor	155-4
Bleed Fuel System At Fuel Injection Nozzles.	140-12	John Deere 5104 Tractor	155-5
Engine Cooling System	140-13	John Deere 5204 Tractor	155-6
Cleaning Grille, Screens, Radiator and Oil Cooler	140-14	Ground Speed at Rated Engine Speed (2300 rpm)	155-7
Prevent Battery Explosions.	140-14	Metric Bolt and Cap Screw Torque Values . . .	155-8
Observe Electrical Service Precautions	140-15	Unified Inch Bolt and Cap Screw Torque Values.	155-9
Battery Access	140-15	Identification Numbers	
Removing Battery.	140-16	Identification Plates	160-1
Checking Battery Condition	140-17	Record Tractor Serial (Chassis) Number	160-1
Servicing Battery	140-18	Record Front Axle Serial Number.	160-2
Charging Battery	140-20	Record Engine Serial Number	160-2
Battery Replacement Specifications	140-20	Record Transmission Serial Number	160-3
Connecting Starter Wiring.	140-21	Lubrication Maintenance Record Charts	
		50, 250 Hour Service Chart	165-1
		500,600 Hour Service Chart.	165-2

Continued on next page

Page

1000, 1250 Hour Service Chart 165-3
Annual Service Chart 165-4
2000 Hour Service Chart 165-5
As Required Service Chart 165-6

John Deere Service

John Deere Parts 170-1
The Right Tools 170-1
Well Trained Technician 170-1
Prompt Service 170-1

Safety

Recognize Safety Information

This is a safety-alert symbol. When you see this symbol on your machine or in this manual, be alert to the potential for personal injury.

Follow recommended precautions and safe operating practices.



DX,ALERT -19-29SEP98-1/1

TS1389 -UN-07DEC88

Understand Signal Words

A signal word—DANGER, WARNING, or CAUTION—is used with the safety-alert symbol. DANGER identifies the most serious hazards.

DANGER or WARNING safety signs are located near specific hazards. General precautions are listed on CAUTION safety signs. CAUTION also calls attention to safety messages in this manual.



▲ WARNING

▲ CAUTION

DX,SIGNAL -19-03MAR93-1/1

TS187 -19-30SEP88

Follow Safety Instructions

Carefully read all safety messages in this manual and on your machine safety signs. Keep safety signs in good condition. Replace missing or damaged safety signs. Be sure new equipment components and repair parts include the current safety signs. Replacement safety signs are available from your John Deere dealer.

Learn how to operate the machine and how to use controls properly. Do not let anyone operate without instruction.

Keep your machine in proper working condition. Unauthorized modifications to the machine may impair the function and/or safety and affect machine life.

If you do not understand any part of this manual and need assistance, contact your John Deere dealer.



DX,READ -19-03MAR93-1/1

TS201 -UN-23AUG88

Prevent Machine Runaway

Avoid possible injury or death from machinery runaway.

Do not start engine by shorting across starter terminals. Machine will start in gear if normal circuitry is bypassed.

NEVER start engine while standing on ground. Start engine only from operator's seat, with transmission in neutral.

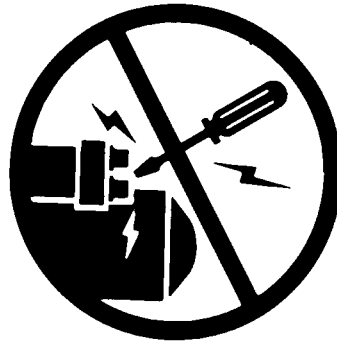

CED,OUO1032,2778 -19-15OCT99-1/1

TS177 -JUN-11JAN89

Operate Tractor Safely

Features designed into your tractor make operation safer and let it perform a wide variety of jobs. Use your tractor only for specified jobs it was designed to perform: implement carrier, load mover, remote power source, or transport unit—not a recreational vehicle.

Careless use or misuse can result in unnecessary accidents. Be alert to hazards of tractor operation. Understand causes of accidents and take every precaution to avoid them. Most common accidents are caused from:

- Tractor upsets
- Improper starting procedures
- Crushing and pinching during hitching
- Collisions with other motor vehicles
- Getting entangled in PTO shafts
- Falls from tractors

Avoid accidents by taking the following precautions:

- Put transmission in neutral (N) and set brakes before dismounting. Leaving transmission in gear with engine stopped will NOT prevent the tractor from moving.
- Be sure everyone is clear of tractor and attached equipment before starting engine.
- Never try to get on or off a moving tractor.
- When tractor is left unattended, place in neutral (N), set brakes, lower implements to the ground, stop the engine, and remove the key.

⚠ CAUTION

- | | |
|---|---|
| <ol style="list-style-type: none"> 1. Read Operator's Manual before operating this tractor. 2. Keep all shields in place. 3. Hitch towed loads only to drawbar to avoid rearward upset. 4. Make certain everyone is clear of machine before starting engine or operation. 5. Keep all riders off tractor and equipment. 6. Keep hands, feet and clothing away from power-driven parts. 7. Reduce speed when turning or applying individual | <ol style="list-style-type: none"> brakes or operating around hazards, on rough ground or steep slopes. 8. Couple brake pedals together for road travel. 9. Use flashing warning lights on highway unless prohibited by law. 10. Stop engine, lower implement to ground and shift to "PARK" or set brakes(s) securely before dismounting. 11. Wait for all movement to stop before servicing machinery. 12. Remove key if leaving tractor unattended. |
|---|---|



IM47224A -19-02JUN97

TS276 -JUN-23AUG88

AG,OUO6035,84 -19-18MAY00-1/1

Use Caution on Hillsides

Avoid holes, ditches, and obstructions which cause the tractor to tip, especially on hillsides. Avoid sharp, uphill turns.

Never drive near the edge of a gully or steep embankment -- it might cave in.

Driving forward out of a ditch or mired condition or up a steep slope could cause tractor to tip over rearward. Back out of these situations if possible.

Danger of overturn increases greatly with narrow tread setting, at high speed.

Hitch towed loads only to drawbar. When using a chain, take up the slack slowly.

AG,OUO6035.65 -19-17MAY00-1/1

Shift to Low Gear on Hills

Shift to a low gear before descending a steep hill to improve your control of the tractor with little or no braking. Use engine braking to reduce speed before applying tractor brakes. Run-away tractors often tip over. Never coast downhill.

When driving on icy, wet or graveled surfaces, reduce speed and be sure tractor is properly ballasted to avoid skidding and loss of steering control.

Additional ballast may be needed for transporting heavy hitch mounted implements. When implement is raised, drive slowly over rough ground, regardless of how much ballast is used.

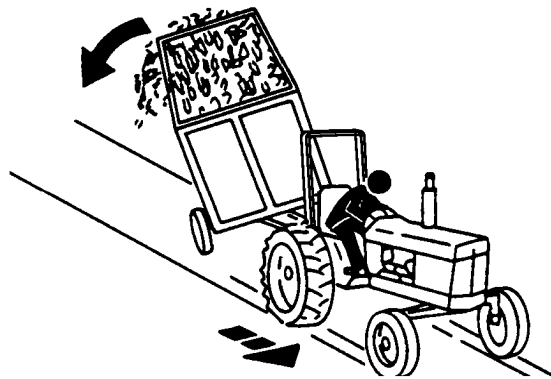

LV4042 -UN-09JUL99

AG,OUO6035.83 -19-17MAY00-1/1

Avoid Tipping

Do not drive where machine could slip or tip.

Stay alert for holes, rocks, and roots in the terrain, and other hidden hazards. Keep away from drop-offs.

Slow down before you make a sharp turn.

Use care when pulling loads or using heavy equipment:

- Use only approved drawbar hitch points.
- Limit loads to those you can safely control.
- Use counterweights or wheel weights when suggested in this operator's manual.

Reduce speed and exercise extreme caution on slopes and in sharp turns to prevent tipping or loss of control. Be especially cautious when changing direction on slopes.

Do not stop or start suddenly when going uphill or downhill.

If machine stops going up hill:

- STOP the PTO.
- Back down slowly.

MX,AVOIDTIP1A1 -19-22JUL94-1/1

Freeing a Mired Machine

Attempting to free a mired machine can involve safety hazards such as the mired tractor tipping rearward, the towing tractor overturning, and the tow chain or tow bar (a cable is not recommended) failing and recoiling from its stretched condition.

Back your tractor out if it gets mired down in mud. Unhitch any towed implements. Dig mud from behind the rear wheels. Place boards behind the wheels to provide a solid base and try to back out slowly. If necessary, dig mud from the front of all wheels and drive slowly ahead.

If necessary to tow with another unit, use a tow bar or a long chain (a cable is not recommended). Inspect the chain for flaws. Make sure all parts of towing devices are of adequate size and strong enough to handle the load.

Always hitch to the drawbar of the towing unit. Do not hitch to the front pushbar attachment point. Before moving, clear the area of people. Apply power smoothly to take up the slack: a sudden pull could snap any towing device causing it to whip or recoil dangerously.

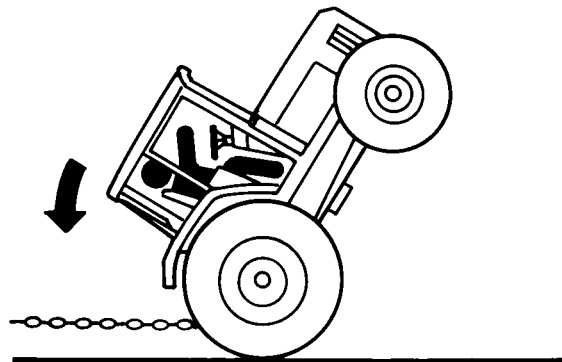

TS1645 -UN-16SEP95



TS263 -UN-23AUG88

DX,MIREDD -19-07JUL99-1/1

Park Tractor Safely

To park tractor safely:

- Disengage PTO.
- Lower equipment to the ground.
- Put gear shift lever in NEUTRAL.
- Set brakes.
- STOP the engine.
- Remove key.

Before you leave the operator's seat, wait for engine and attachment parts to stop moving.

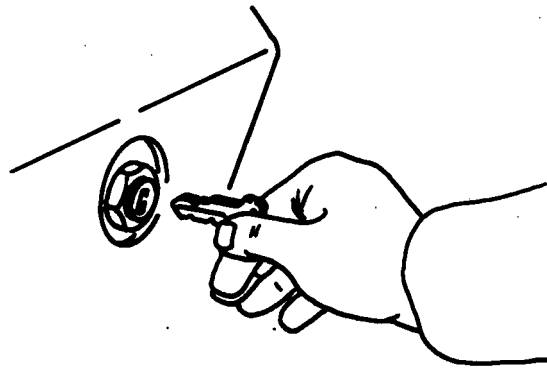

MS5691 -UN-26APR89

MX,SAIP,AAA1 -19-21AUG99-1/1

Keep Riders Off Machine

Only allow the operator on the machine. Keep riders off.

Riders on machine are subject to injury such as being struck by foreign objects and being thrown off of the machine. Riders also obstruct the operator's view resulting in the machine being operated in an unsafe manner.

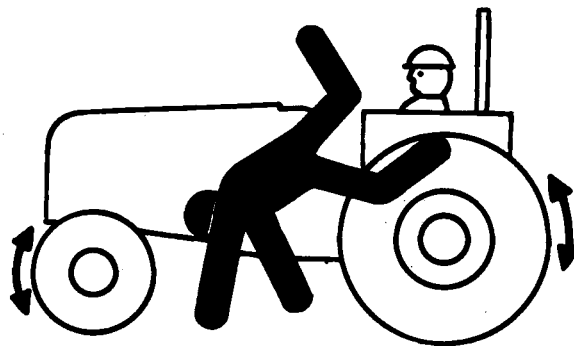

TS290 -UN-23AUG88

DX,RIDER -19-03MAR93-1/1

Handle Fuel Safely—Avoid Fires

Handle fuel with care: it is highly flammable. Do not refuel the machine while smoking or when near open flame or sparks.

Always stop engine before refueling machine. Fill fuel tank outdoors.

Prevent fires by keeping machine clean of accumulated trash, grease, and debris. Always clean up spilled fuel.



TS202 -UN-23AUG88

DX,FIRE1 -19-03MAR93-1/1

Prepare for Emergencies

Be prepared if a fire starts.

Keep a first aid kit and fire extinguisher handy.

Keep emergency numbers for doctors, ambulance service, hospital, and fire department near your telephone.

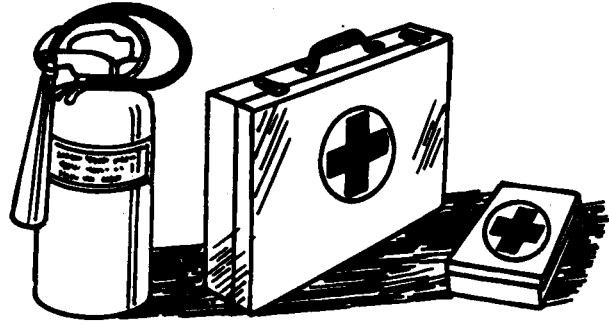

TS291 -UN-23AUG88

DX,FIRE2 -19-03MAR93-1/1

Wear Protective Clothing

Wear close fitting clothing and safety equipment appropriate to the job.

Prolonged exposure to loud noise can cause impairment or loss of hearing.

Wear a suitable hearing protective device such as earmuffs or earplugs to protect against objectionable or uncomfortable loud noises.

Operating equipment safely requires the full attention of the operator. Do not wear radio or music headphones while operating machine.

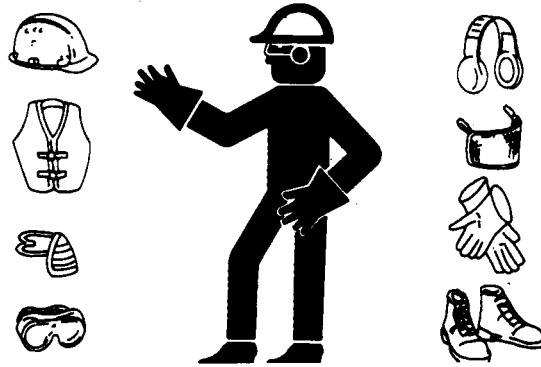

TS206 -UN-23AUG88

DX,WEAR -19-10SEP90-1/1

Protect Against Noise

Prolonged exposure to loud noise can cause impairment or loss of hearing.

Wear a suitable hearing protective device such as earmuffs or earplugs to protect against objectionable or uncomfortable loud noises.

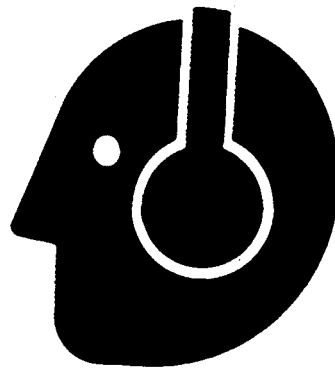

TS207 -UN-23AUG88

DX,NOISE -19-03MAR93-1/1

Stay Clear of Rotating Drivelines

Entanglement in rotating driveline can cause serious injury or death.

Keep tractor master shield and driveline shields in place at all times. Make sure rotating shields turn freely.

Wear close fitting clothing. Stop the engine and be sure PTO driveline is stopped before making adjustments, connections, or cleaning out PTO driven equipment.



TSS1644 -JUN-22AUG95

DX,PTO -19-12SEP95-1/1

Use Safety Lights and Devices

Prevent collisions between other road users, slow moving tractors with attachments or towed equipment, and self-propelled machines on public roads. Frequently check for traffic from the rear, especially in turns, and use turn signal lights.

Use headlights, flashing warning lights, and turn signals day and night. Follow local regulations for equipment lighting and marking. Keep lighting and marking visible, clean, and in good working order. Replace or repair lighting and marking that has been damaged or lost. An implement safety lighting kit is available from your John Deere dealer.

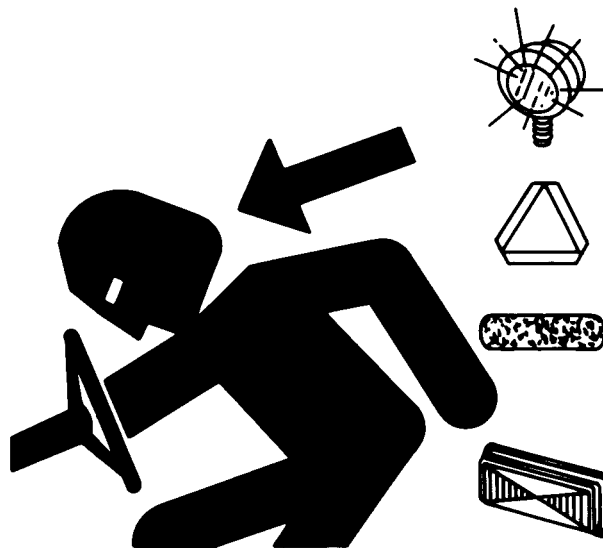

TSS951 -JUN-12APR90

DX,FLASH -19-07JUL99-1/1

Safely Transporting the Tractor

A disabled tractor is best transported on a flatbed carrier. Use chains to secure the tractor to the carrier.

Never tow a tractor at a speed greater than 16 km/h (10 mph). An operator must steer and brake the tractor under tow.

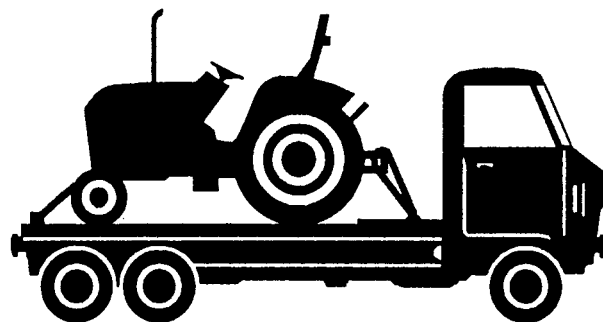

LV610 -JUN-22APR94

MX,SAIP,LA1 -19-29JUL94-1/1

Tow Loads Safely

Stopping distance increases with speed and weight of towed loads, and on slopes. Towed loads with or without brakes that are too heavy for the tractor or are towed too fast can cause loss of control. Consider the total weight of the equipment and its load.

Observe these recommended maximum road speeds, or local speed limits which may be lower:

- If towed equipment does not have brakes, do not travel more than 32 km/h (20 mph) and do not tow loads more than 1.5 times the tractor weight.
- If towed equipment has brakes, do not travel more than 40 km/h (25 mph) and do not tow loads more than 4.5 times the tractor weight.

Ensure the load does not exceed the recommended weight ratio. Add ballast to recommended maximum for tractor, lighten the load, or get a heavier towing unit. The tractor must be heavy and powerful enough with adequate braking power for the towed load. Use additional caution when towing loads under adverse surface conditions, when turning, and on inclines.

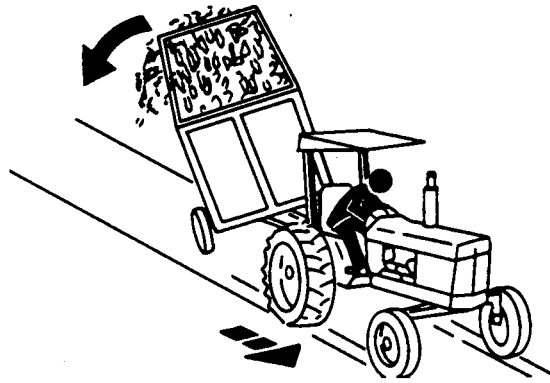

TSS216 -JUN-23AUG88

DX,TOW -19-02OCT95-1/1

Practice Safe Maintenance

Understand service procedure before doing work. Keep area clean and dry.

Never lubricate, service, or adjust machine while it is moving. Keep hands, feet, and clothing from power-driven parts. Disengage all power and operate controls to relieve pressure. Lower equipment to the ground. Stop the engine. Remove the key. Allow machine to cool.

Securely support any machine elements that must be raised for service work.

Keep all parts in good condition and properly installed. Fix damage immediately. Replace worn or broken parts. Remove any buildup of grease, oil, or debris.

On self-propelled equipment, disconnect battery ground cable (-) before making adjustments on electrical systems or welding on machine.

On towed implements, disconnect wiring harnesses from tractor before servicing electrical system components or welding on machine.



TS218 -UN-23AUG88

DX,SERV -19-17FEB99-1/1

Service Tractor Safely

Do not service the tractor while it is in motion or while the engine is running.

Tighten wheel hardware to correct torque as specified in Wheels, Tyres and Tread section. Torque at intervals shown in Break-In Period and Lubrication and Maintenance sections, to ensure that wheel hardware does not loosen.

Reinstall shields removed during service.

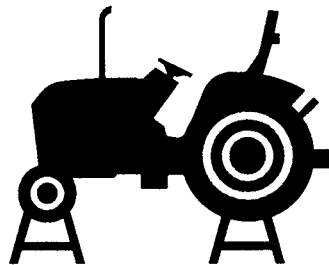

LV828 -UN-08AUG94

AG,OUO6035,70 -19-17MAY00-1/1

Support Machine Properly

Always lower the attachment or implement to the ground before you work on the machine. If the work requires that the machine or attachment be lifted, provide secure support for them. If left in a raised position, hydraulically supported devices can settle or leak down.

Do not support the machine on cinder blocks, hollow tiles, or props that may crumble under continuous load. Do not work under a machine that is supported solely by a jack. Follow recommended procedures in this manual.

When implements or attachments are used with a machine, always follow safety precautions listed in the implement or attachment operator's manual.

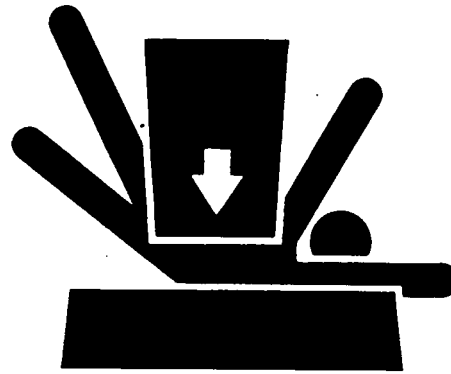

TS229 -JUN-23AUG88

DX,LOWER -19-24FEB00-1/1

Avoid Heating Near Pressurized Fluid Lines

Flammable spray can be generated by heating near pressurized fluid lines, resulting in severe burns to yourself and bystanders. Do not heat by welding, soldering, or using a torch near pressurized fluid lines or other flammable materials. Pressurized lines can accidentally burst when heat goes beyond the immediate flame area.



TS963 -JUN-15MAY90

DX,TORCH -19-10DEC04-1/1

Avoid High-Pressure Fluids

Escaping fluid under pressure can penetrate the skin causing serious injury.

Avoid the hazard by relieving pressure before disconnecting hydraulic or other lines. Tighten all connections before applying pressure.

Search for leaks with a piece of cardboard. Protect hands and body from high pressure fluids.

If an accident occurs, see a doctor immediately. Any fluid injected into the skin must be surgically removed within a few hours or gangrene may result. Doctors unfamiliar with this type of injury should reference a knowledgeable medical source. Such information is available from Deere & Company Medical Department in Moline, Illinois, U.S.A.

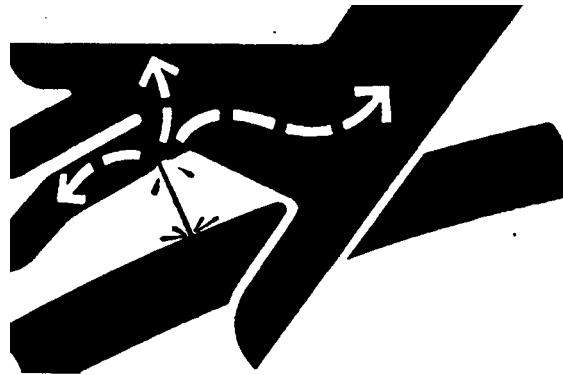

X9811 -UN-23AUG88

DX,FLUID -19-03MAR93-1/1

Service Cooling System Safely

Explosive release of fluids from pressurized cooling system can cause serious burns.

If radiator cap must be removed, do not remove when engine is hot. Shut engine off and wait until cap is cool enough to touch with bare hands. Slowly loosen cap to first stop to relieve pressure before removing completely.

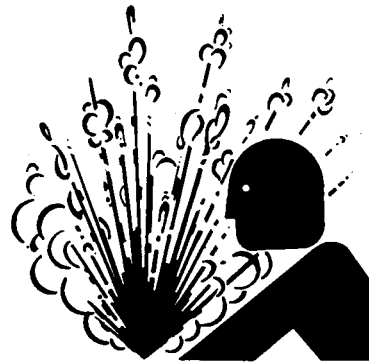

TS281 -UN-23AUG88

AG,OUO1032,2682 -19-30SEP99-1/1

Store Attachments Safely

Stored attachments such as dual wheels, cage wheels, and loaders can fall and cause serious injury or death.

Securely store attachments and implements to prevent falling. Keep playing children and bystanders away from storage area.



TS219 -UN-23AUG88

DX,STORE -19-03MAR93-1/1

Prevent Acid Burns

Sulfuric acid in battery electrolyte is poisonous. It is strong enough to burn skin, eat holes in clothing, and cause blindness if splashed into eyes.

Avoid the hazard by:

1. Filling batteries in a well-ventilated area.
2. Wearing eye protection and rubber gloves.
3. Avoiding breathing fumes when electrolyte is added.
4. Avoiding spilling or dripping electrolyte.
5. Use proper jump start procedure.

If you spill acid on yourself:

1. Flush your skin with water.
2. Apply baking soda or lime to help neutralize the acid.
3. Flush your eyes with water for 15—30 minutes. Get medical attention immediately.

If acid is swallowed:

1. Do not induce vomiting.
2. Drink large amounts of water or milk, but do not exceed 2 L (2 quarts).
3. Get medical attention immediately.

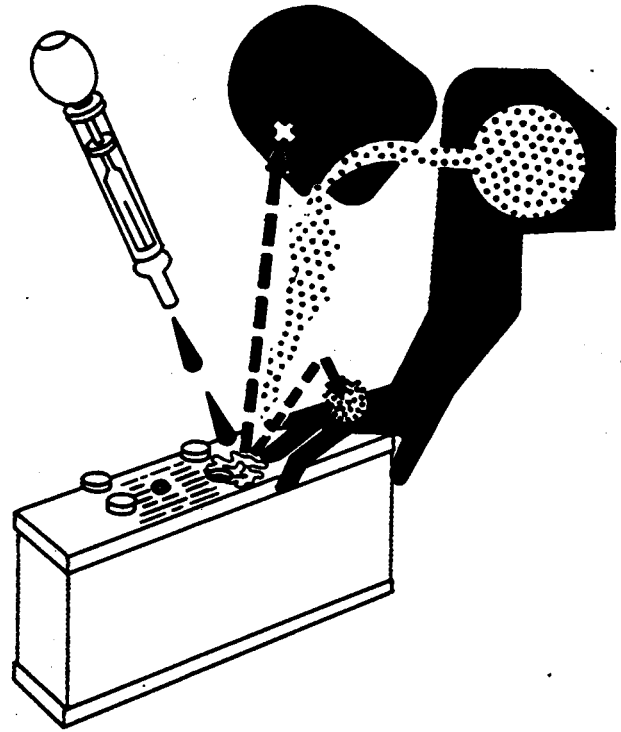

TS203 -JUN-23AUG88

DX,POISON -19-21APR93-1/1

Service Tires Safely

Explosive separation of a tire and rim parts can cause serious injury or death.

Do not attempt to mount a tire unless you have the proper equipment and experience to perform the job.

Always maintain the correct tire pressure. Do not inflate the tires above the recommended pressure. Never weld or heat a wheel and tire assembly. The heat can cause an increase in air pressure resulting in a tire explosion. Welding can structurally weaken or deform the wheel.

When inflating tires, use a clip-on chuck and extension hose long enough to allow you to stand to one side and NOT in front of or over the tire assembly. Use a safety cage if available.

Check wheels for low pressure, cuts, bubbles, damaged rims or missing lug bolts and nuts.

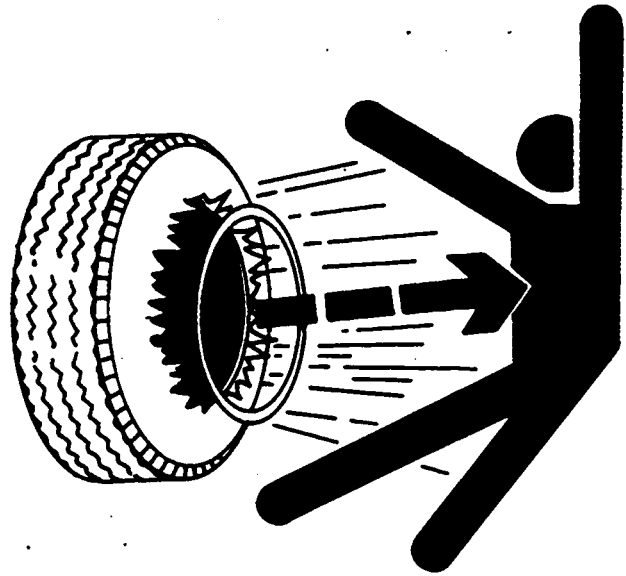

TS211 -JUN-23AUG88

DX,RIM -19-24AUG90-1/1

Dispose of Waste Properly

Improperly disposing of waste can threaten the environment and ecology. Potentially harmful waste used with John Deere equipment include such items as oil, fuel, coolant, brake fluid, filters, and batteries.

Use leakproof containers when draining fluids. Do not use food or beverage containers that may mislead someone into drinking from them.

Do not pour waste onto the ground, down a drain, or into any water source.

Inquire on the proper way to recycle or dispose of waste from your local environmental or recycling center, or from your John Deere dealer.

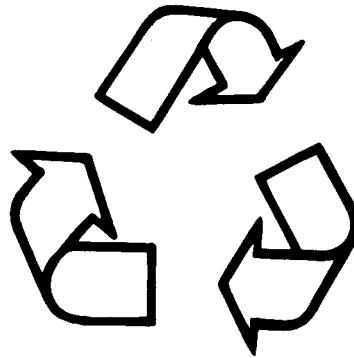

TS1133 -JUN-26NOV90

AG,OUO1032,2683 -19-30SEP99-1/1

Safety Signs

Warning Labels

Keep warning labels in good condition, replace if not in readable condition.

PY80265,05GO801 -19-12JUN06-1/3

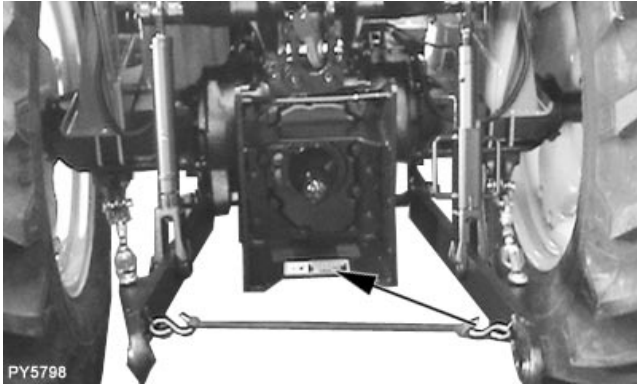

PY5798

-UN-11JUL06

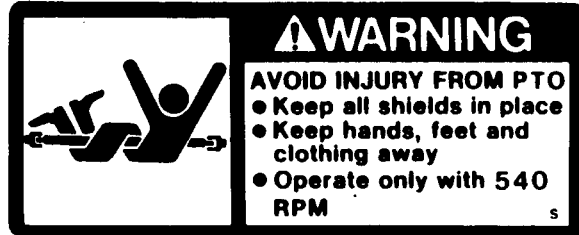

M71026 -19-02JUL90

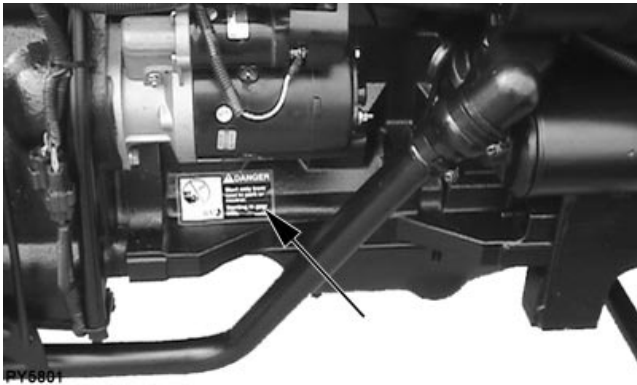

PY5801

-UN-11JUL06



LV1932 -19-02JUN97



PY4880

-UN-06DEC05

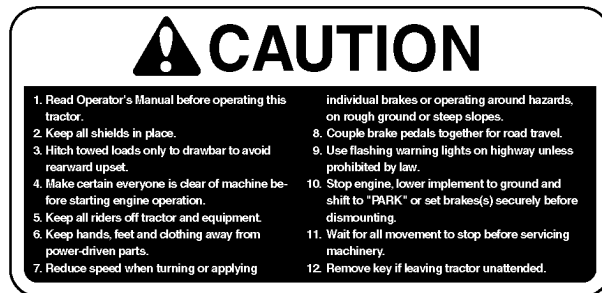

LV4307 -19-04NOV05

Continued on next page

PY80265,05GO801 -19-12JUN06-2/3



PY4879 -UN-06DEC05

Inflation Pressure In Tyres (psi)		
टायर में हवा का प्रेशर (पी.एस.आई.)		
Tyre Size (Ply Rating)	With Little or No Ballast	With Heavy Ballast or Heavy Implement
टायर का साइज (प्लाई रेटिंग)	बहुत कम या अतिरिक्त वजन न होने पर	अधिकतम वजन या बहुत भारी उपकरण लगा होने पर
Front Tyres (आगे के टायर्स)		
6.50-20 (8 Ply)	20	29
7.50-16 (6 Ply)	20	40
6.00-16 (8 Ply)	23	40
Rear Tyres (पीछे के टायर्स)		
16.9-28 (12 Ply)	14	19
14.9-28 (12 Ply)	12	20
13.6-28 (12 Ply)	13	18
12.4-28 (12 Ply)	12	20

PY1667 -UN-06DEC05



PY1089 -UN-16JUL01

• This battery generates Hydrogen gas. Keep sparks, flames, cigarettes away.
 • Charge this battery only at well ventilated places. Avoid shorts or sparks.
 • Battery filled with acid. Do not spill.
 • Read instruction manual of vehicle or battery before fitting / checking the battery.

PY5353 -UN-06DEC05



PY4140 -UN-26AUG04

DRY AIR CLEANER

- If equipped with automatic dust unloader valve; periodically clear valve by squeezing, or if equipped with dust cup, service daily.
- If tractor is equipped with an air cleaner restriction Indicator, clean the primary element at the next refueling or daily service period if:
 - Indicator light on the instrument panel glows with the engine running, or
 - Manual Indicator on the outlet of the air cleaner shows red.
- If tractor is not equipped with restriction Indicator, service the filter element every 250 hours or when engine loses power or smokes excessively.
- Stop engine before removing filter element.
- Service according to Instructions on primary element.
- Replace primary element yearly or if damaged or when it no longer responds to cleaning, whichever occurs first.
- If equipped with safety air cleaner or safety element, replace yearly or as required. **DO NOT ATTEMPT TO CLEAN SAFETY CLEANER OR ELEMENT.**

DO NOT USE OIL

PY4141 -UN-26AUG04

PY80265,05GO801 -19-12JUN06-3/3

Controls and Instruments

Tractor Controls

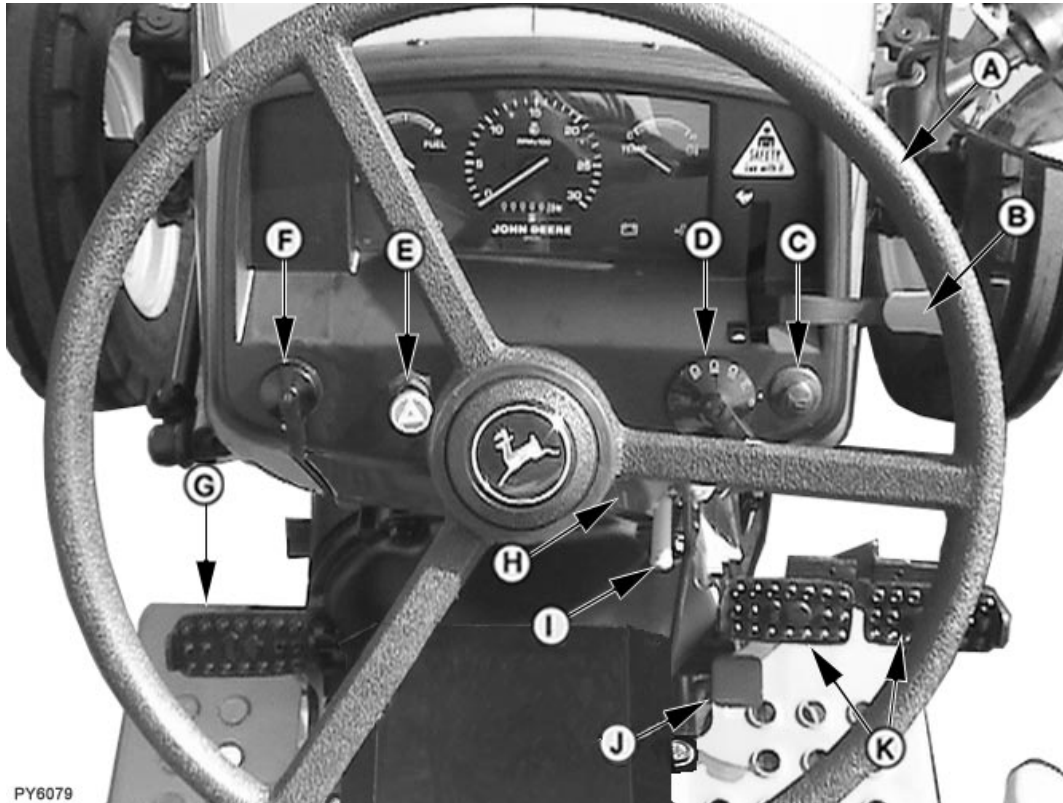

A—Steering Wheel
B—Hand Throttle
C—Horn

D—Light Switch
E—Hazard Switch
F—Turn Signal Switch

G—Clutch Pedal
H—Key Switch
I—Hand Brake Lever

J—Foot Throttle
K—Brake Pedals

Continued on next page

NR25796,0000345 -19-10AUG06-1/2

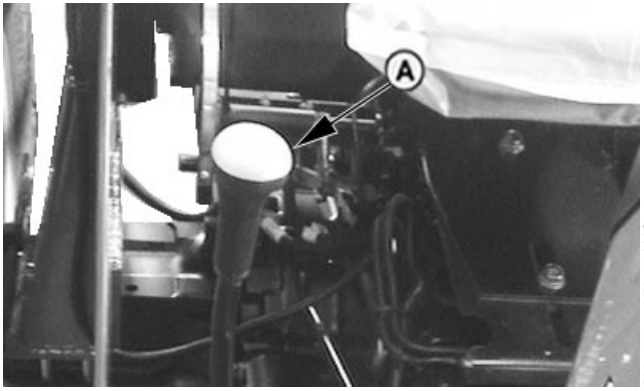

PY6080 -UN-06AUG06

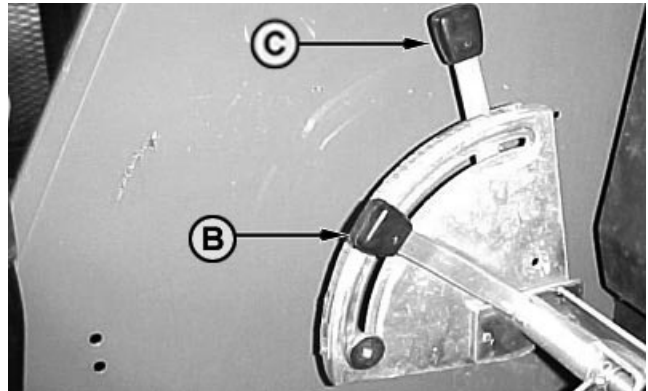

PY4127 -UN-26AUG04

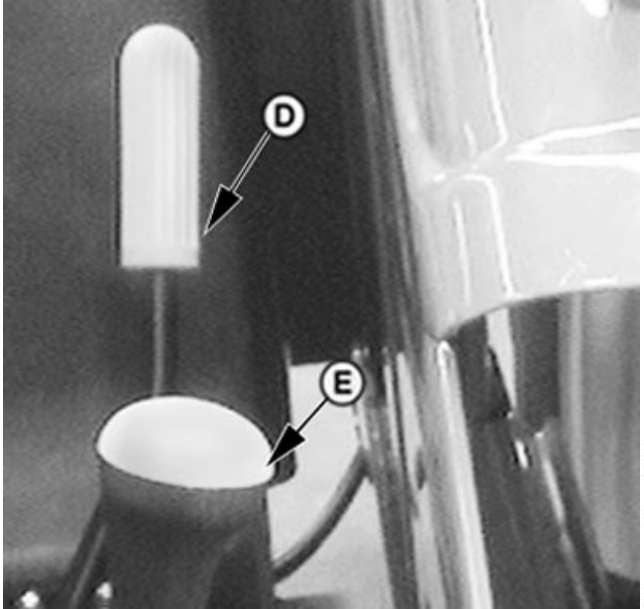

PY4947 -UN-19MAY05



PY6081 -UN-06AUG06

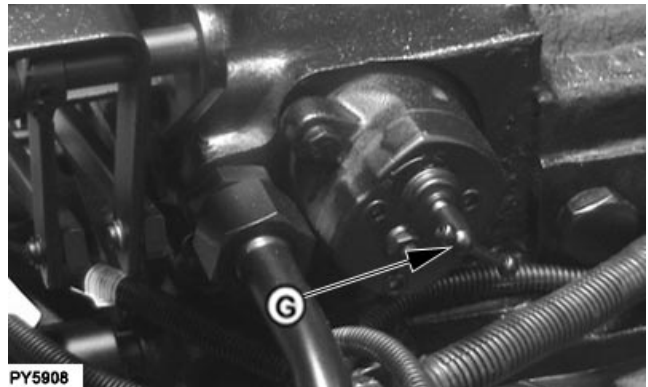

PY5908 -UN-11JUL06

- A—Gear Shift Lever
- B—Rockshaft Draft Control Lever
- C—Rockshaft Position Control Lever
- D—PTO Lever
- E—Range Shift Lever
- F—Differential Lock
- G—Rate of Drop of Knob

Instrument Panel

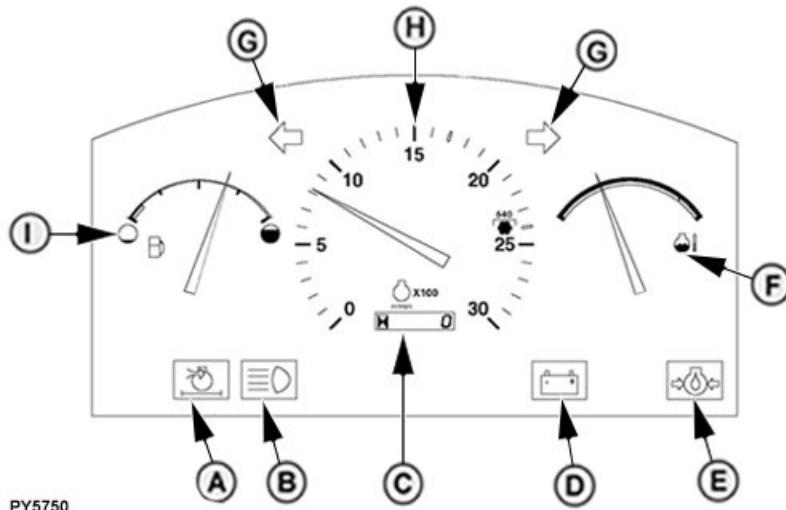

PY5750

For 5103, 5103S, 5203, 5104 and 5204 Tractor

PY5750 -UN-01JUN06

- | | | | |
|-----------------------------|---------------------------------|------------------------------------|--------------|
| A—Air Restriction Indicator | D—Charging System Indicator | F—Coolant Temperature Gauge | H—Tachometer |
| B—High Beam Indicator | E—Engine Oil Pressure Indicator | G—Turn Signal Direction Indicators | I—Fuel Gauge |

PY80265.05GO804 -19-29DEC06-1/1

Instrument Panel (5103E Tractor)

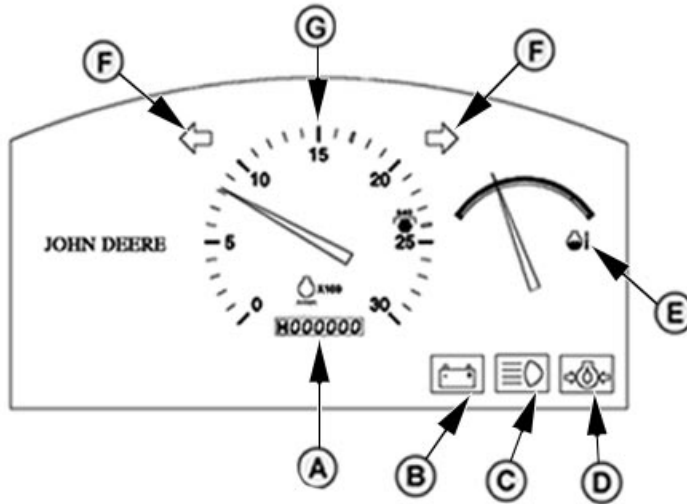

PY5751

For 5103E Tractor

PY5751 -UN-08JUN06

- | | | | |
|-----------------------------|---------------------------------|------------------------------------|--------------|
| A—Hour Meter | D—Engine Oil Pressure Indicator | F—Turn Signal Direction Indicators | G—Tachometer |
| B—Charging System Indicator | E—Coolant Temperature Gauge | | |

PY80265.05GO805 -19-08JUN06-1/1

Lights

Light Switch Positions

Tractor light switch has five positions:

A—Turns off all lights.

B—Turns on warning lights only. Use for parking the vehicle

C—Turns on dim headlights,tail lights, and warning lights.Turn switch to this position before meeting other vehicles.

D—Turns on bright headlights, tail lights, and warning lights. For highway driving during night time

E—Turns on high beamlight.

F— Switch on flood lamp (plough lamp). For field use only. Do not use on roads. Flood light might blind or confuse other drivers

- A—Lights Off
- B—Warning Lights Position
- C—Dim Headlights, Tail Lights, and Warning Light Position
- D—Bright Headlights, Tail Lights and Warning Lights Position
- E—High Beamlight
- F—Flood Light Switch

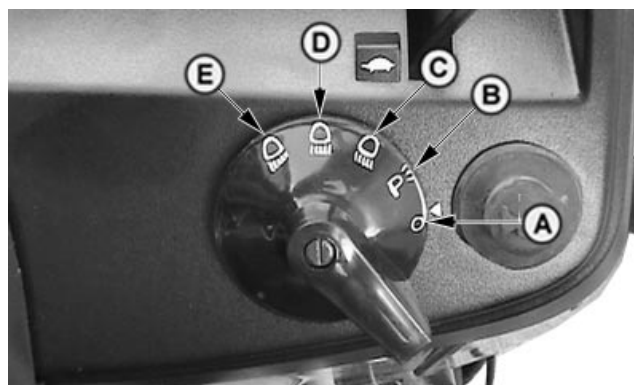

PY4106 -UN-23FEB06



PY4107 -UN-21AUG04

PY80265,05GO806 -19-03JUL06-1/1

Using Headlights

Dual-beam headlights (F) are switched on by either “High Beamlight” (E), “Bright Headlight” (D), or “Dim Headlight” (C) light switch positions.

Always dim lights before meeting another vehicle.

Keep headlights adjusted properly, (see Adjusting Headlights in Service section).

- A—Lights Off
- B—Warning Lights Position
- C—Dim Headlights, Tail Lights, and Warning Light Position
- D—Bright Headlights, Tail Lights and Warning Lights Position
- E—High Beamlight
- F— Headlights

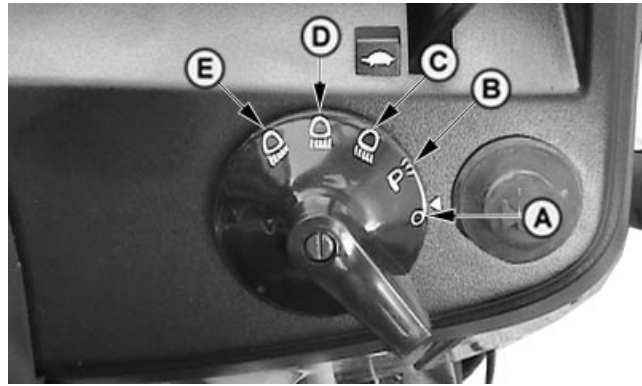

PY4106 -UN-23FEB06

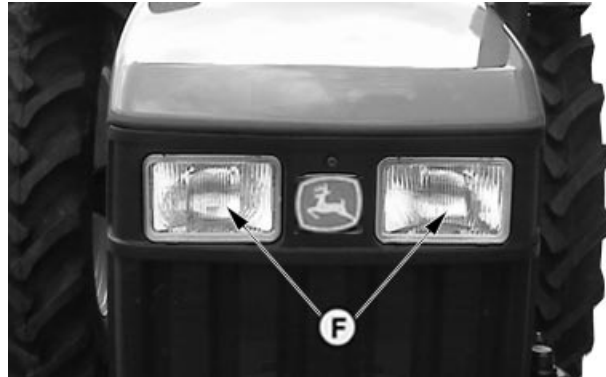

PY5148 -UN-23FEB06

PY80265.05GO807 -19-10SEP05-1/1

Using High Beam Indicator

High beam indicator (A) should glow when light switch is turned to “Bright Headlight” position or “Flood Light” position. Bright headlights, tail lights, flood light and warning lights should be on.

- A—High Beam Indicator

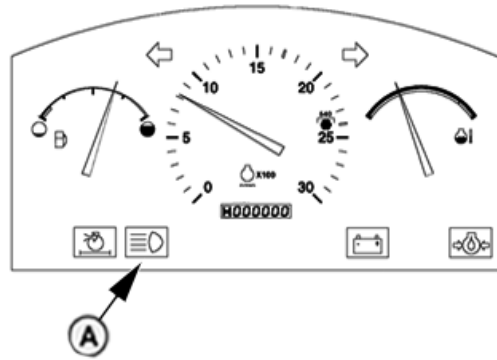

PY5726

For 5103, 5103S, 5203, 5104 and 5204 Tractor

PY5726 -UN-02JUN06

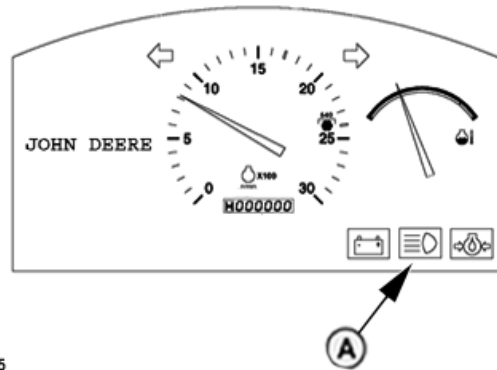

PY5725

For 5103E Tractor

PY80265.05GO808 -19-29DEC06-1/1

PY5752 -UN-01JUN06

Using Tail Lights

Red tail lights (F) are switched on by either bright headlight or dim headlight light switch position.

Be sure tail light lenses are clean before driving on a road, so other drivers can see it easily.

CAUTION: Prevent collisions between other road users, slow moving tractors with attachments or towed equipment, and self-propelled machines on public roads. Frequently check for traffic from the rear, especially in turns, and use hand signals or turn signal lights.

Use headlights, flashing warning lights, and turn signals day and night. Follow local regulations for equipment lighting and marking. Keep lighting and marking visible and in good working order. Replace or repair lighting and marking that has been damaged or lost. An implement safety lighting kit is available from your John Deere dealer.

- F— Tail Lights
- G—Turn Signal Lights
- H—Reflex Reflector
- I—Flood Light Switch

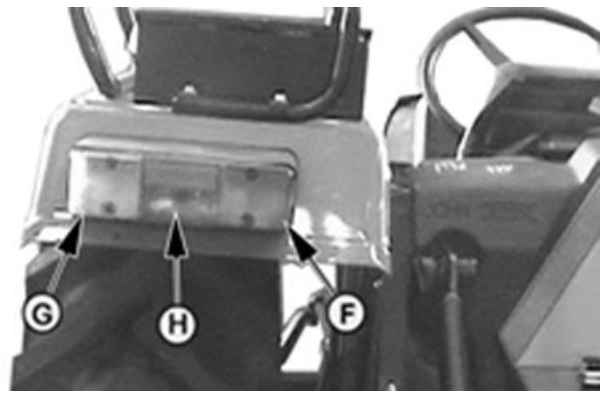

PY5005 -UN-08JAN06

For 5103, 5103S, 5203, 5104 and 5204 Tractor

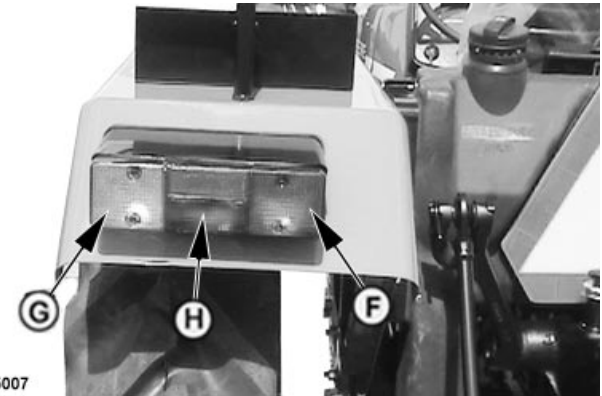

PY5007 -UN-09JUN06

PY5007

For 5103E Tractor

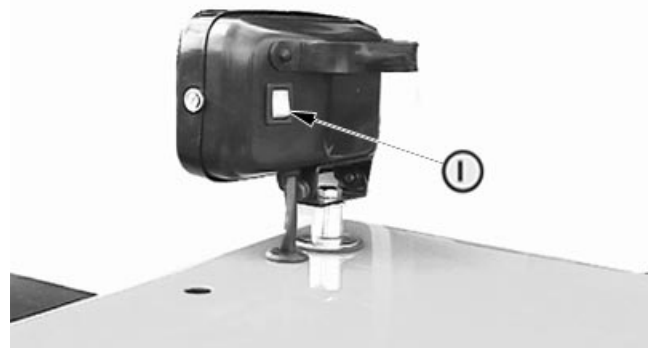

PY4128 -UN-26AUG04

PY80265,05GO809 -19-29DEC06-1/1

Using Turn Signals



PY4114 -UN-23FEB06



PY5008

PY5008 -UN-09JUN06

For 5103, 5103S, 5203, 5104 and 5204 Tractor

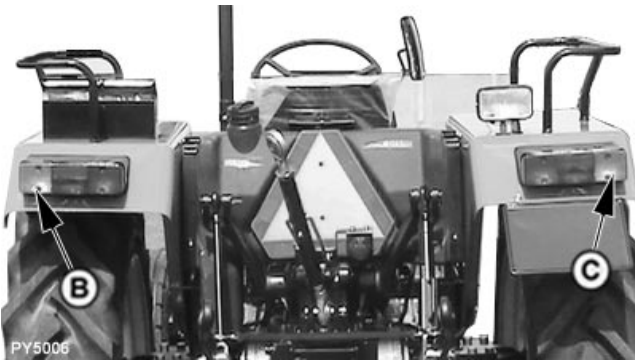

PY5006 -UN-09JUN06

PY5006

For 5103E Tractor

Move turn signal lever (A) down to indicate left-hand turn or up for right-hand turn. Indicator lights (D) will flash to signal turn direction.

When lever is up, front and rear facing lights on right-hand side (C) will flash while left-hand lights (B) glow steady. Left-hand lights (B) flash and right-hand lights (C) glow steady when lever is down.

NOTE: Be sure to manually return lever to center position after turning.

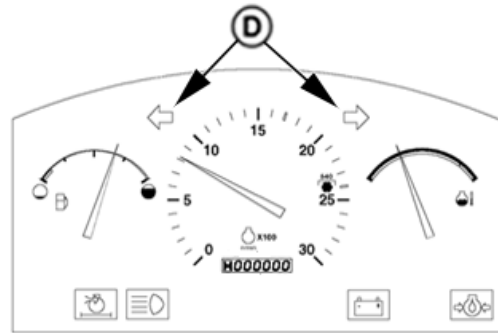

PY5727

For 5103, 5103S, 5203, 5104 and 5204 Tractor

PY5727 -UN-02JUN06

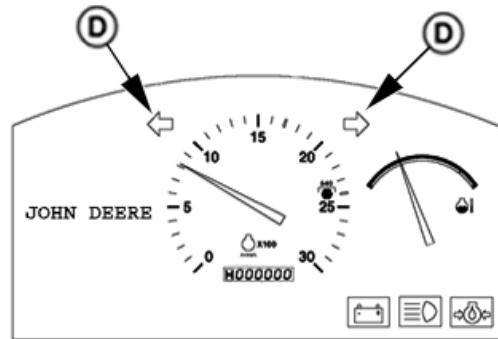

PY5753

5103E Tractor

PY5753 -UN-01JUN06

- A—Turn Signal Lever
- B—Left-Hand Lights
- C—Right-Hand Lights
- D—Dash Indicator Lights

Using Hazard Lights



PY5009

For 5103, 5103S, 5203, 5104 and 5204 Tractor

PY5009 -UN-09JUN06

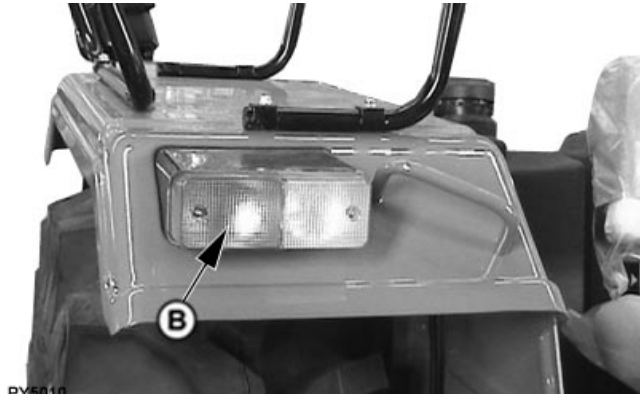

PY5010

For 5103, 5103S, 5203, 5104 and 5204 Tractor

PY5010 -UN-09JUN06

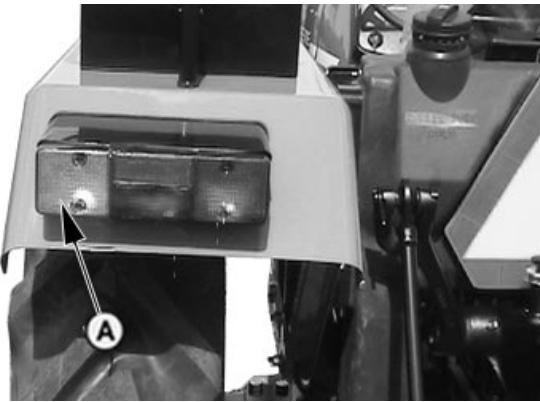

PY5011

For 5103E Tractor

PY5011 -UN-13JUN06

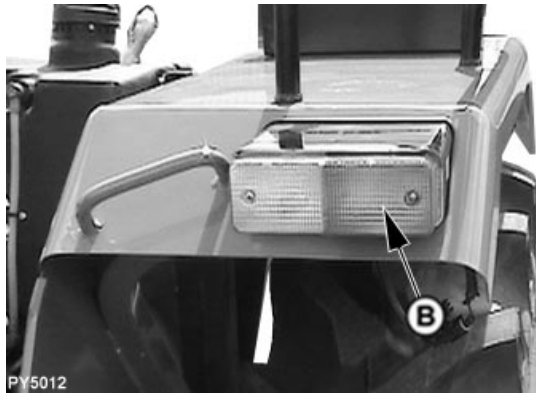

PY5012

For 5103E Tractor

PY5012 -UN-09JUN06

All 4 turn signal lights (2 front and 2 rear) start to blink when hazard light switch (C) is pushed out. Use hazard lights to warn incoming vehicles when tractor is stopped on the road

- A—Turn Signal Light on Rear Side
- B— Turn Signal Light on Front Side
- C— Hazard Light Switch

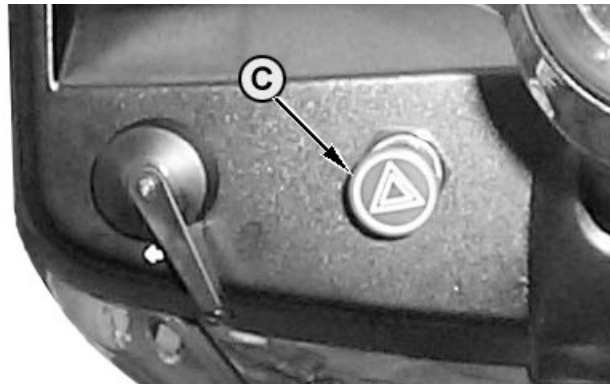

PY1072 -UN-16FEB06

PY80265,05GO811 -19-29DEC06-1/1

Using Flood Lamp

Flood lamp (G) is switched on by flood light switch (H).

CAUTION: When operating on a road, move light switch to either “Bright or Dim Head Lamp” positions. Never use flood lamp when transporting. A clear, bright light at the rear of the tractor could confuse drivers of other vehicles as they approach from the rear.

- A—Lights Off
- B—Warning Lights Position
- C—Dim Headlights, Tail Lights and Warning Light Position
- D—Bright Headlights, Tail Lights and Warning Lights Position
- E—High Beamlight
- F—Horn
- G—Flood Lamp
- H—Flood Light switch

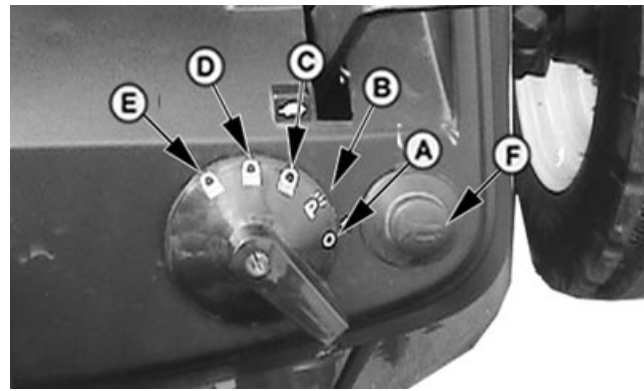

PY5365 -UN-20FEB06

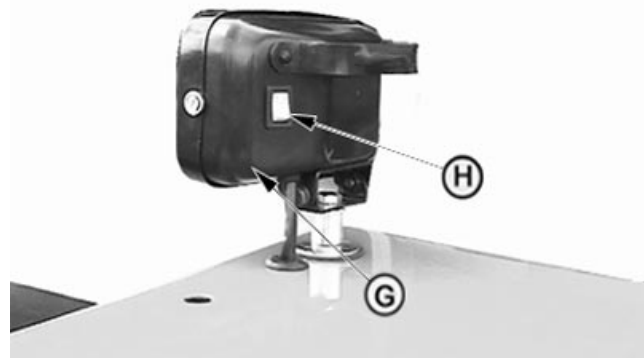

PY4150 -UN-20FEB06

PY80265.05GO812 -19-04JUL06-1/1

Seven-Terminal Outlet

Outlet (A) is used to connect lights, turn signals and remote electrical equipment on trailers or implements. Always use auxiliary light on towed implement when tractor rear signals and other lights are obscured.

NOTE: Matching plug is available through your John Deere dealer.

Terminal	Function	Wire Color
1	Ground	Black
2	Flood Lamp	Purple
3	Left Turn	Dark Green
4	Accessory	Red
5	Right Turn	Dark Green
6	Tail Lamp	Gray
7	Accessory	Red

A—Seven-Terminal Outlet



PY1432 -UN-09DEC05

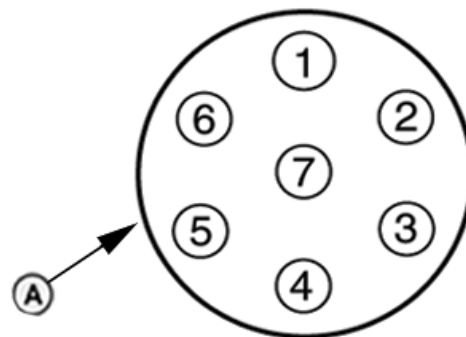

PY5526

PY5526 -UN-11JUL06

PY80265.05GO813 -19-11JUL06-1/1

Operator's Platform

Selecting Seat Position

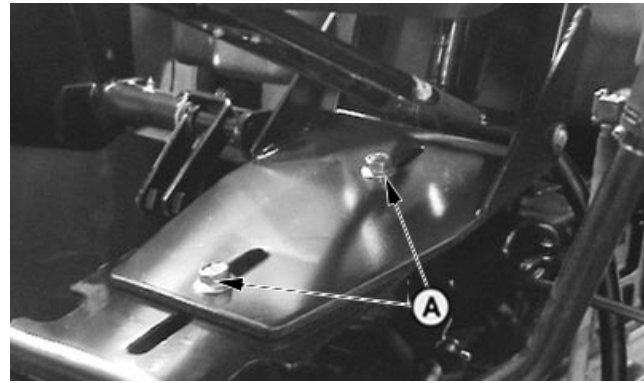

A—Cap Screws

Standard Seat

Loosen two cap screws (A) and move seat forward or backward depending on operator's requirement. After getting right position, tighten both cap screws.

PY80265.05GO814 -19-10SEP05-1/2

Delux Seat

Seat can be moved forward or backward depending on operator's requirement. To move seat on either side, just lift lever (A) and push the seat.

A—Seat Adjustment Lever

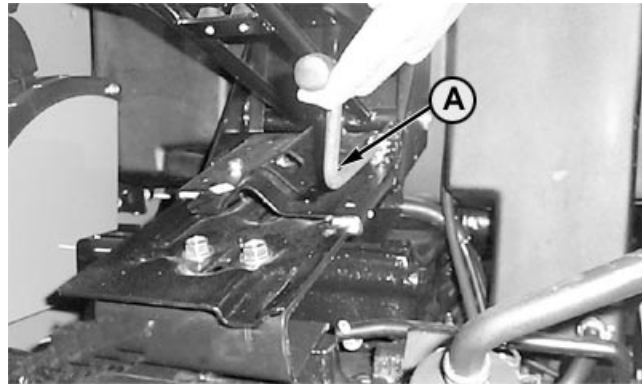

PY80265.05GO814 -19-10SEP05-2/2

Adjusting Ride Comfort

Adjustment knob is located behind seat.

Weight markings are given on the rear of seat. Turn adjustment knob (A) for a firm or soft ride. Seat suspension will function properly relative to operator's weight.

A—Weight Adjustment Knob

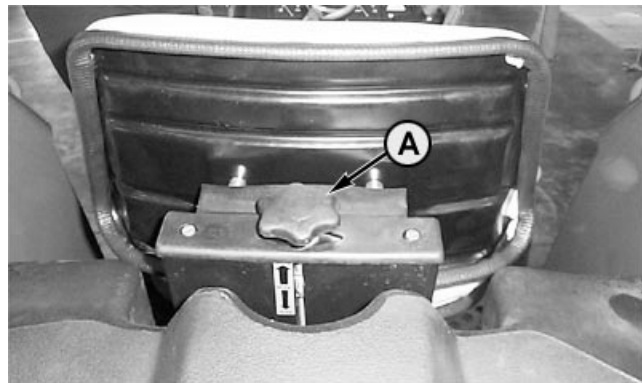

PY80265.05GO815 -19-10SEP05-1/1

Break-In Period

Observe Engine Operation Closely

IMPORTANT: The engine is ready for normal operation. Be extra cautious during the first 100 hours, until you become thoroughly familiar with the sound and feel of your new tractor. Stay extra attentive and alert.

Warm up tractor carefully. Check charging (A) and oil pressure (B) warning indicator lights and coolant temperature gauge (C).

Avoid unnecessary engine idling.

Check engine oil, coolant and transmission/hydraulic fluid levels frequently. Watch for fluid leaks.

NOTE: If engine oil must be added, use seasonal viscosity grade oil. Use only lubricants meeting specifications given in the Fuels, Lubricants and Coolant section.

- A—Charging Indicator
- B—Oil Pressure Indicator
- C—Coolant Temperature Indicator

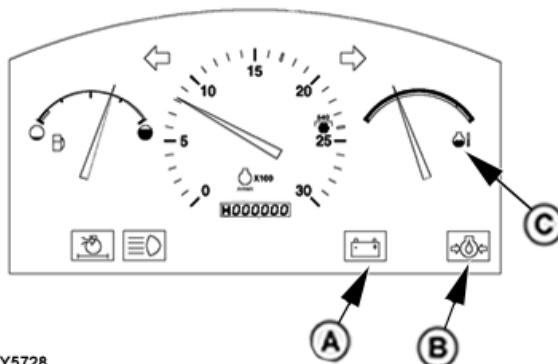

PY5728

For 5103, 5103S, 5203, 5104 and 5204 Tractor

PY5728 -UN-31MAY06

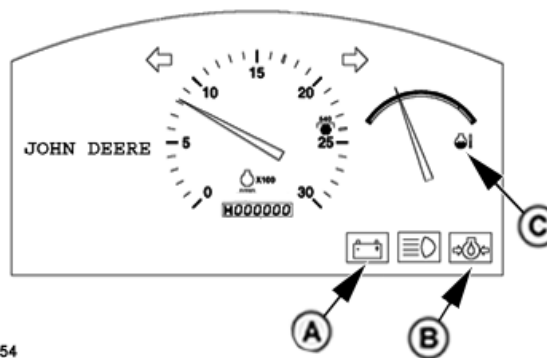

PY5754

For 5103E Tractor

PY5754 -UN-01JUN06

PY80265,05GO816 -19-29DEC06-1/1

Break-In Service

IMPORTANT: Keep wheel hardware tight to avoid tractor damage. Check wheel hardware torque before operating, twice during first ten hours of operation, after fifty hours of operation, and periodically thereafter.

During the First 10 Hours of Operation:

Perform daily or 10 hours service. (See Service Intervals in Lubrication and Maintenance section)

Tighten wheel hardware. (See Wheels, tyres, and Treads section)

After the First 50 Hours of Operation:

Tighten wheel hardware. (See Wheels, tyres, and Treads section)

Check alternator/fan belt tension and tighten air intake and cooling system hose clamps

Perform 50 Hours Service

After the First 100 Hours of Operation:

Replace transmission-hydraulic filter element

Change engine oil and filter¹

¹See Engine Break-In Oil in Service section for additional information.

Prestarting Checks

Service Daily Before Start-Up

1. Check the engine oil level. Wipe dipstick (B) off and reinsert it fully. Remove and locate oil level.

Safe operating range is between two marks on dipstick. Do not operate engine when oil level is below lower mark on dipstick. Add seasonal viscosity grade oil through filler hole (A). (See Fuel, Lubricants, and Coolant section for oil specifications.)

2. Drain water and sediment from fuel filter drain (C). (See Drain Water and Sediment from Fuel Filter in Service—10 Hours.)

CAUTION: DO NOT remove radiator cap or drain coolant until coolant is cold. Always loosen radiator cap slowly to relieve any excess pressure.

3. Check coolant level in recovery tank (D). If engine is COOL and level is below “LOW” mark, add coolant to recovery tank to bring level to “LOW” mark.

NOTE: Coolant level with a cold engine should be at the “LOW” mark. A tractor at operating temperature should have a coolant level at the “FULL” mark.

4. Lubricate the following items at 10 hour intervals if operating in extremely wet or muddy conditions.

- Front axle pivot pin(s)
- Steering spindles
- Tie rod ends

Use multipurpose grease. For detailed information see Lubrication and Maintenance section.

- A—Engine Oil Filler Cap
- B—Engine Oil Dipstick
- C—Fuel Filter Drain
- D—Recovery Tank
- E—Radiator Cap

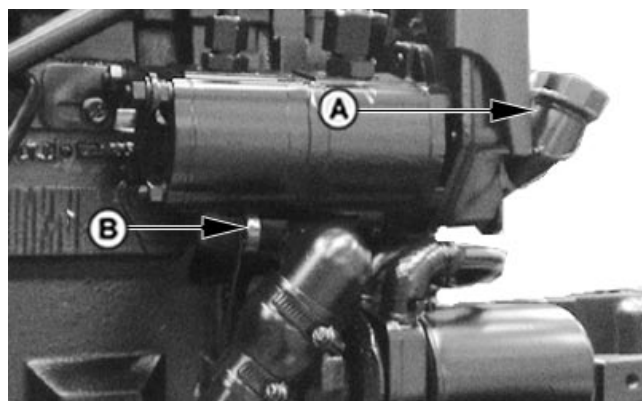

PY5366 -UN-09DEC05

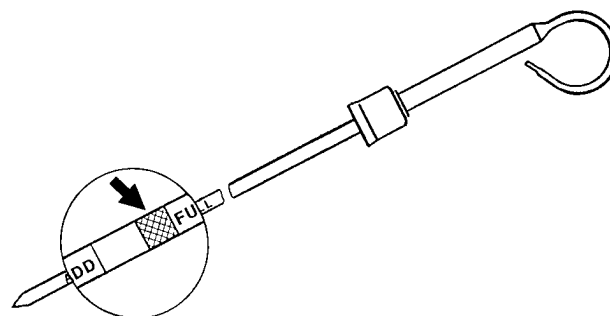

FD000047

FD000047 -UN-13MAR96

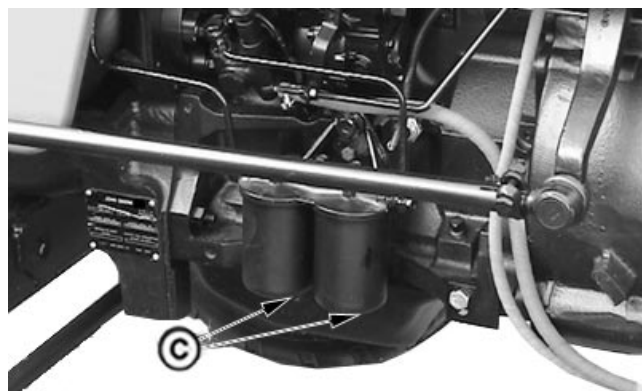

PY5369 -UN-09DEC05

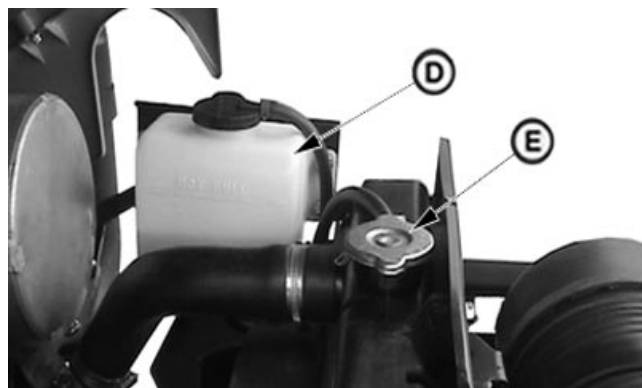

PY5370 -UN-09DEC05

PY80265.05GO818 -19-11JUL06-1/1

Operating the Engine

Before Starting the Engine

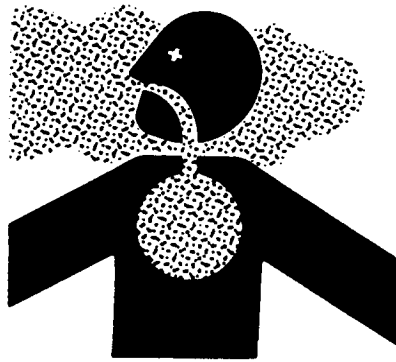

TSS220 -JUN-23AUG88

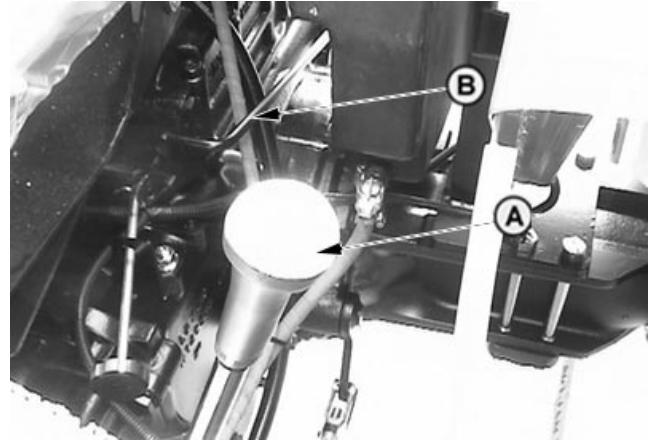

PY4108 -JUN-21AUG04

Single Clutch Tractor

CAUTION: Prevent asphyxiation. Engine exhaust fumes can cause sickness or death to you or someone else.

If you must operate engine in a building, be positive there is adequate ventilation. Either use an exhaust pipe extension to remove the exhaust fumes or open doors and windows to bring enough outside air into the area.

1. Check fuel gauge to be sure tractor has plenty of fuel.
2. Place range shift lever (A) in neutral (N) position. Starter will not operate if range shift lever is not in this position.
3. Place rockshaft control levers (C and D) in lowered position.
4. Check indicator lights. Indicators should illuminate when key switch is turned to the "ON" position.

If any indicator does not function properly, see your John Deere dealer.

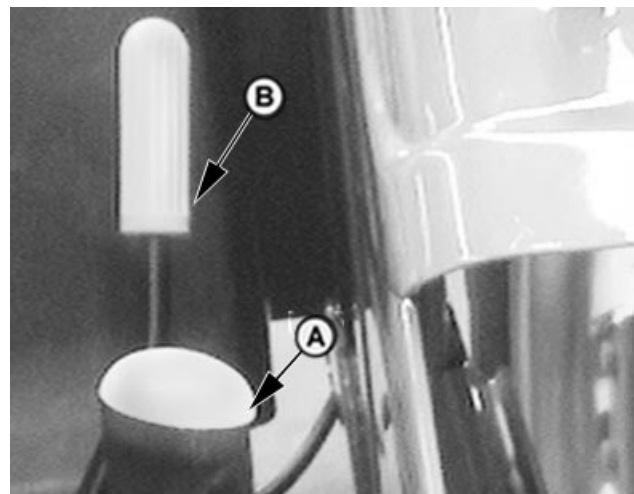

PY4953 -JUN-27MAY05

Dual Clutch Tractor

- A—Range Shift Lever
- B—PTO Lever
- C—Rockshaft Position Control Lever
- D—Rockshaft Draft Control Lever

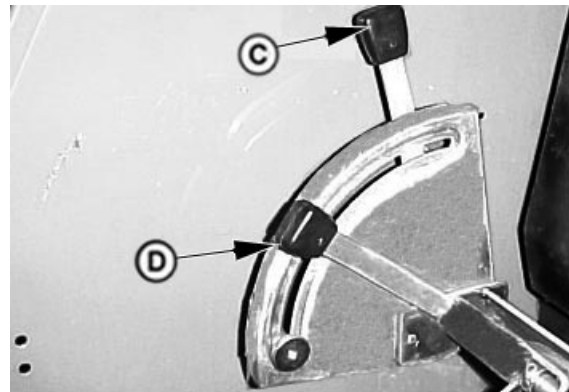

PY4964 -JUN-22APR05

PY80265.05GO819 -19-04JUL06-1/1

Starting the Engine

1. Push hand throttle (A) forward off idle position (approximately 1/3 of full throttle). Engine may not start with throttle pulled completely down.
2. Make sure fuel shut-off knob (C) is pushed in.

CAUTION: Avoid possible injury or death from a machine runaway.

Do not start engine by shorting across starter terminals. Machine will start in gear and move if normal circuitry is bypassed.

Start engine only from operator's seat with transmission in NEUTRAL.

NEVER start engine while standing on ground.

IMPORTANT: DO NOT run a cold engine at full throttle.

3. Depress clutch pedal and turn key switch fully clockwise (B) to engage starter. Release key when engine starts. If key is released before engine starts, wait until starter and engine stop turning before trying again.

IMPORTANT: DO NOT operate starter more than 20 seconds at a time. If engine does not start, wait at least two minutes for the starter motor to cool before trying again. If engine does not start in four attempts, refer to "Troubleshooting" section.

A—Hand Throttle
B—Key Switch On
C—Fuel Shut Off Knob

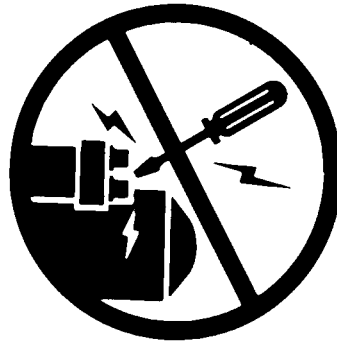

Machinery Runaway



Hand Throttle and Key Switch

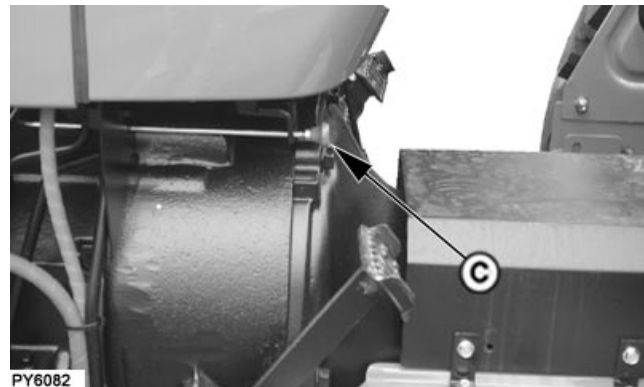

Fuel Shut-off Knob

TS177 -UN-1JAN89

PY4497 -UN-13JAN05

PY6082 -UN-06AUG06

NR25796,0000346 -19-29DEC06-1/1

Check Instruments After Starting

IMPORTANT: If charging system (A) or oil pressure (B) indicators fail to go out, or temperature gauge (C) indicates hot, stop engine and determine the cause.

- A—Charging System Indicator
- B—Oil Pressure Indicator
- C—Coolant Temperature Gauge

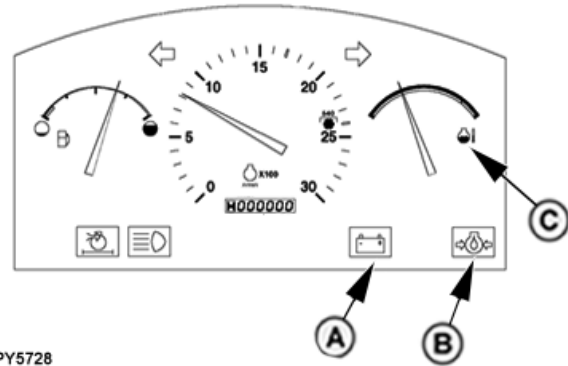

PY5728

For 5103, 5103S, 5203, 5104 and 5204 Tractor

PY5728 -UN-31MAY06

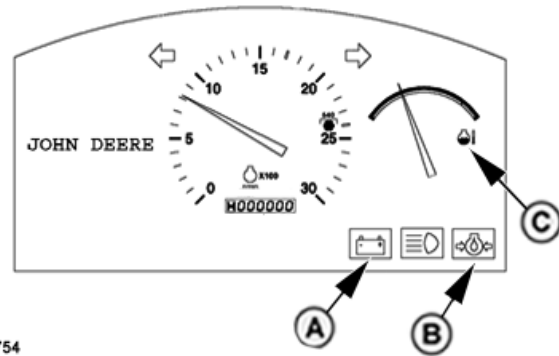

PY5754

For 5103E Tractor

PY80265.05GO821 -19-29DEC06-1/1

PY5754 -UN-01JUN06

Oil Pressure Indicator

Oil pressure indicator (A) will light if engine oil pressure is low. Indicator should light when key is turned to engage starter and go out when engine starts.

IMPORTANT: NEVER operate engine without sufficient oil pressure. If indicator stays lit for longer than five seconds under normal operating conditions, stop engine and check for cause.

If low oil level is not the problem, see your John Deere dealer.

- A—Oil Pressure Indicator

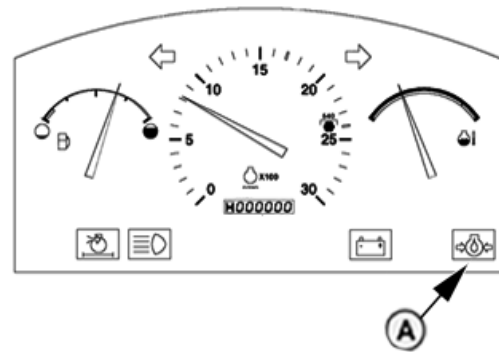

PY5729

For 5103, 5103S, 5203, 5104 and 5204 Tractor

PY5729 -UN-31MAY06

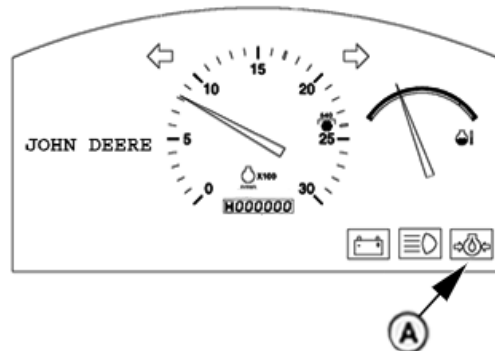

PY5755

For 5103E Tractor

PY80265.05GO822 -19-29DEC06-1/1

PY5755 -UN-01JUN06

Charging System Indicator

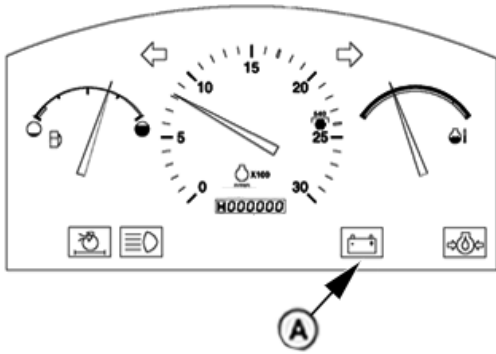

PY5730

For 5103, 5103S, 5203, 5104 and 5204 Tractor

PY5730 -UN-31MAY06

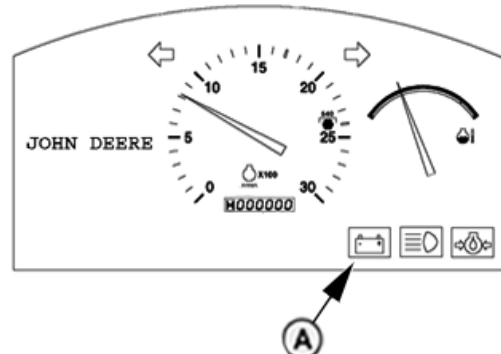

PY5756

For 5103E Tractor

PY5756 -UN-01JUN06

A—Charging System Indicator

Charging system indicator (A) will light when alternator output is low. Indicator should light when key is turned to engage starter, and go out when engine starts.

loose or broken fan belt is not the cause, see your John Deere dealer.

If indicator stays lit for longer than five seconds in normal operation, stop engine and check for cause. If

PY80265.05GO823 -19-29DEC06-1/1

Air Restriction Sensor

Air restriction indicator (A) will light if air cleaner becomes plugged. Service air cleaner as soon as possible.

Indicator should light momentarily when key is turned slowly to starter engagement position.

A—Air Restriction Indicator

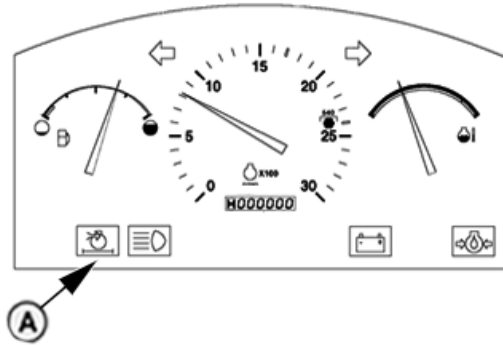

PY5731

For 5103, 5103S, 5203, 5104 and 5204 Tractor

PY5731 -UN-31MAY06

PY80265.05GO824 -19-29DEC06-1/1

Air Restriction Sensor (5103E Tractor)

When red indicator is seen in transparent area of air restriction sensor (A). Service air cleaner as soon as possible.

After servicing the air cleaner, reset the sensor by pressing top of the sensor (B).

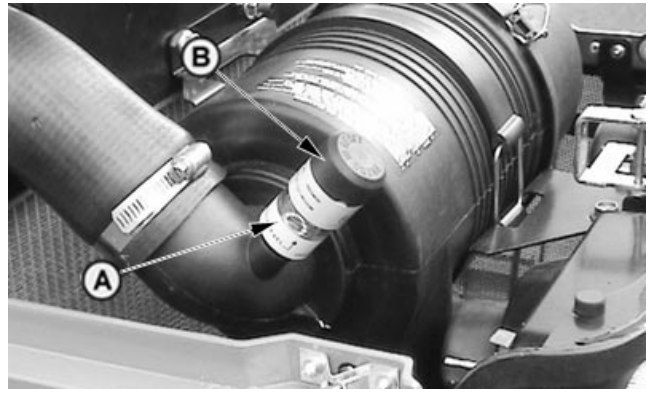

PY80265,05GO825 -19-04JUL06-1/1

PY4093 -UN-25AUG04

Coolant Temperature Gauge

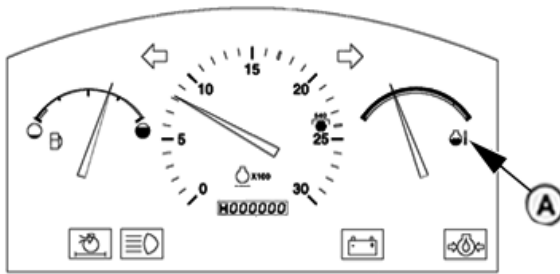

PY5732

For 5103, 5103S, 5203, 5104 and 5204 Tractor

PY5732 -UN-31MAY06

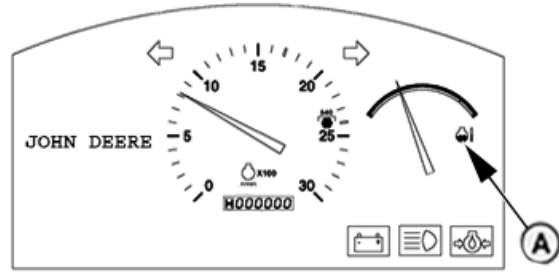

PY5757

For 5103E Tractor

PY5757 -UN-01JUN06

A—Coolant Temperature Gauge

The needle on the temperature gauge (A) rises as engine warms up. If needle reaches red zone, stop engine and determine the cause.

Check coolant level in radiator when engine cools. Also check grille, radiator and radiator side screens for plugging. Check fan belt tension. If problem is not corrected, see your John Deere dealer.

CAUTION: DO NOT remove radiator cap or drain coolant until coolant is cold. Always loosen radiator cap slowly to relieve any excess pressure.

PY80265,05GO826 -19-29DEC06-1/1

Watch Fuel Level

Stop to refuel before gauge (A) reaches empty mark.

IMPORTANT: Use diesel fuel only. See Fuel and Lubricants section for fuel specifications.

Should tractor run out of fuel and not start in several tries, air must be bled from fuel system. (See Bleeding Fuel System in Service section).

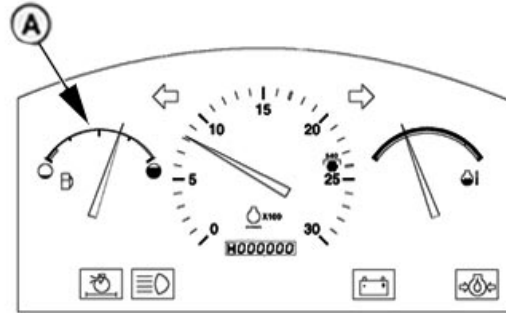

PY5733

For 5103, 5103S, 5203, 5104 and 5204 Tractor

PY5733 -UN-31MAY06

A—Fuel Gauge

PY80265,05GO827 -19-29DEC06-1/1

Watch Fuel Level (5103E Tractor)

Watch level indicator (A) for fuel level, while refilling tank.

IMPORTANT: Use diesel fuel only. See Fuel and Lubricants section for fuel specifications.

Should tractor run out of fuel and not start in several tries, air must be bled from fuel system. (See Bleeding Fuel System in Service section).



PY4094 -UN-20AUG04

A—Level Indicator

PY80265,05GO828 -19-04JUL06-1/1

Changing Engine Speeds



Hand Throttle

PY4111 -UN-21AUG04

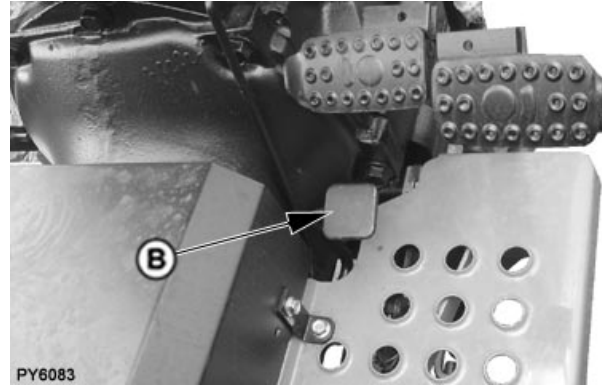

Foot Throttle

PY6083 -UN-06AUG06

A—Hand Throttle

B—Foot Throttle

To increase speed, push hand throttle (A) forward.

To temporarily increase engine speed above hand throttle setting, depress foot throttle (B).

NR25796,0000347 -19-04AUG06-1/1

Warming Up the Engine



PY5734

For 5103, 5103S, 5203, 5104 and 5204 Tractor

PY5734 -UN-31MAY06



PY5758

For 5103E Tractor

PY5758 -UN-01JUN06

Do not place tractor under full load until it is properly warmed up.

1. Idle engine at about 1500 rpm for several minutes.

2. Run engine at about 1900 rpm and under light load until engine reaches normal operation condition.

PY80265,05GO830 -19-29DEC06-1/1

Restart Stalled Engine

Should the engine stall when operating under load, depress clutch pedal (A) and restart it immediately to prevent abnormal heat build up and continue with normal operation or operate at slow idle for one or two minutes before stopping.

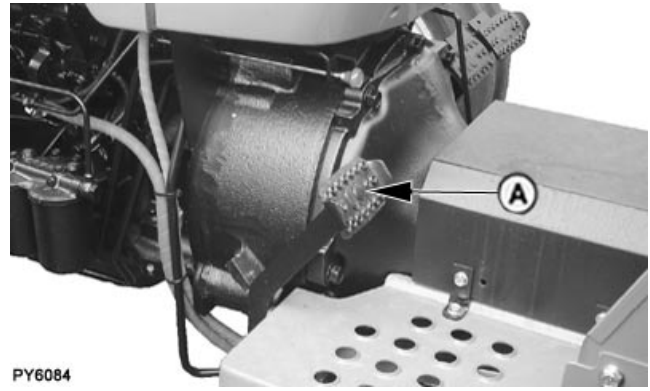

PY6084

PY6084 -UN-06AUG06

NR25796,0000348 -19-04AUG06-1/1

Avoid Idling the Engine



PY5734

For 5103, 5103S, 5203, 5104 and 5204 Tractor

PY5734 -UN-31MAY06



PY5758

For 5103E Tractor

PY5758 -UN-01JUN06

Allowing engine to idle at low rpm uses fuel inefficiently, and can cause a build-up of carbon in the engine.

If tractor must be left with the engine running more than three or four minutes, minimum engine speed should be 1200 rpm.

PY80265,05GO832 -19-29DEC06-1/1

Observe Engine Work and Idle Speeds



PY5734 -UN-31MAY06

PY5734

For 5103, 5103S, 5203, 5104 and 5204 Tractor

Slow idle speed should be 850 ± 75 rpm. At light or no load, full throttle speed will increase to 2500 rpm.

Normal working speed is 1400—2300 rpm rated speed. Within these limits engine can be put under full load.

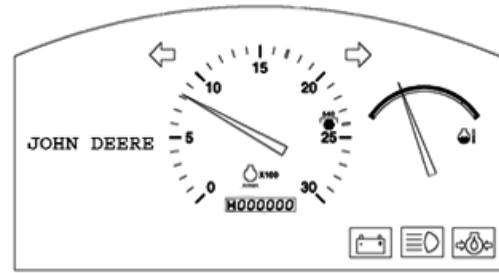

PY5758 -UN-01JUN06

PY5758

For 5103E Tractor

For correct PTO speed, run engine at 2200 rpm for standard 540 rpm operation (load requiring full engine power).

PY80265.05GO833 -19-29DEC06-1/1

Working With Speed/Hour Meter

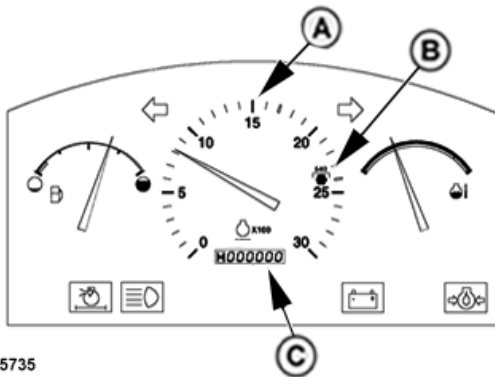

PY5735 -UN-31MAY06

PY5735

For 5103, 5103S, 5203, 5104 and 5204 Tractor

A—Tachometer

B—2200 RPM Mark (540)

C—Hour Meter

Tachometer (A) shows engine rpm, read in hundreds.

For 540 rpm PTO speed, increase engine speed until tachometer needle is aligned with 2200 rpm mark (B).

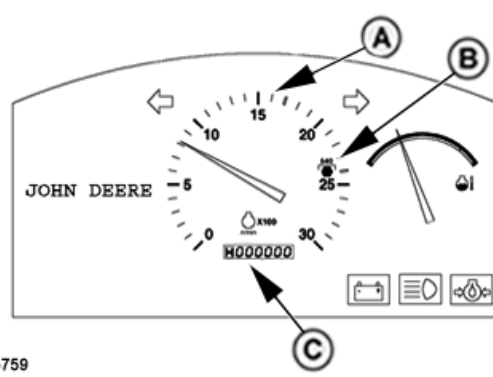

PY5759 -UN-01JUN06

PY5759

For 5103E tractor

Hour meter (C) shows hours of operation in full hours and tenths.

PY80265.05GO834 -19-29DEC06-1/1

Stopping the Engine

1. Pull hand throttle (A) down to slow idle position. Allow engine to idle for one to two minutes.
2. Put range shift lever in neutral (N) and set brakes.

IMPORTANT: Cooling of certain engine parts is provided by engine oil. Stopping a hot engine suddenly could cause damage to these parts by overheating or lack of lubrication.

3. Turn key switch to the OFF position (B).
4. Pull manual fuel shut-off knob (C) (at lower left side of control support) rearward and hold until engine has completely stopped.

CAUTION: Remove key from key switch to prevent operation by untrained personnel.

A—Hand Throttle
B—Key Switch OFF Position
C—Fuel Shut Off Knob



PY4501 -UN-13JAN05

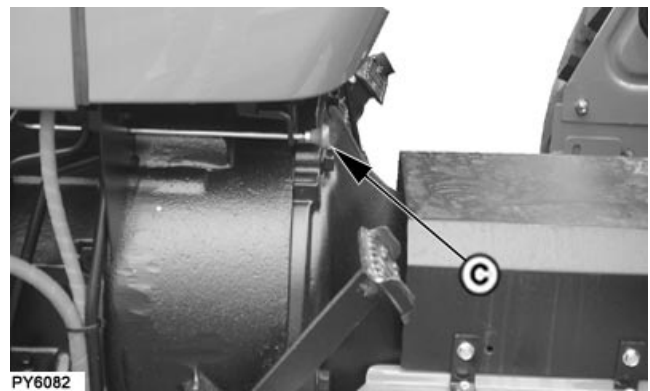

PY6082

PY6082 -UN-06AUG06

NR25796,0000349 -19-04AUG06-1/1

Using Booster Battery

Battery gas is explosive:

- DO NOT smoke while charging battery.
- Keep all flames and sparks away.
- DO NOT charge frozen battery.
- DO NOT connect booster battery negative (—) cable to starting vehicle negative (—) terminal.

1. Access battery. (See procedure in Service section.)
2. Connect positive (+) booster cable to booster battery positive (+) post (D).
3. Connect the other end of positive (+) booster cable to tractor battery positive (+) post (A).
4. Connect negative (—) booster cable to booster battery negative (—) post (C).
5. Connect the other end of negative (—) booster cable to engine ground (B), away from battery and starter.

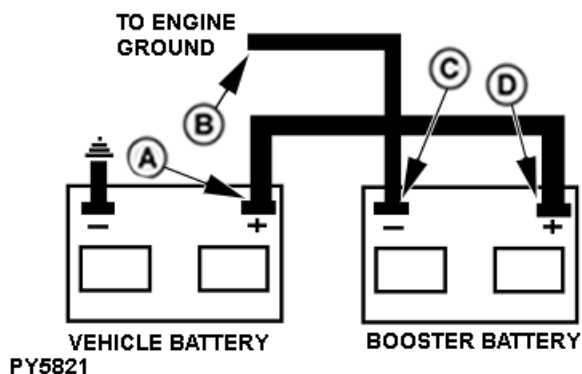

- A—Tractor Battery Positive (+) Post
 B—Engine Ground
 C—Booster Battery Negative (—) Post
 D—Booster Battery Positive (+) Post

PY5821 —UN—12JUL06

PY80265,05GO836 —19—11JUL06—1/1

Driving the Tractor

Operator Training Required

- Study the Operation section of this manual before operating tractor.
- Operate tractor in an open, unobstructed area under direction of an experienced operator.
- Learn use of all controls.
- Operator experience is required to learn moving, stopping, turning and other operating characteristics of tractor.

NR25796,000034A -19-04AUG06-1/1

Driving on Public Roads

CAUTION: When transporting on a public road or highway, use accessory lights and devices for adequate warning to operators of other vehicles. Check local governmental regulations. Various safety devices are available from your John Deere dealer. Keep safety items in good condition. Replace missing or damaged items.

Observe the following precautions when operating the tractor on the road:

CAUTION: Before operating tractor on a road, lock brake pedals together. Use brake lightly and cautiously at transport speeds.

1. Couple brake pedals together using brake locking bar (A). Avoid hard applications of brakes. Reduce speed if towed load weighs more than the tractor and is not equipped with brakes.

Use additional caution when transporting towed loads under adverse surface conditions and when turning or braking on inclines. Be sure wheel tread is adjusted wide to provide maximum stability.

IMPORTANT: To prevent unnecessary wear, never ride the brakes by resting a foot on the pedals.

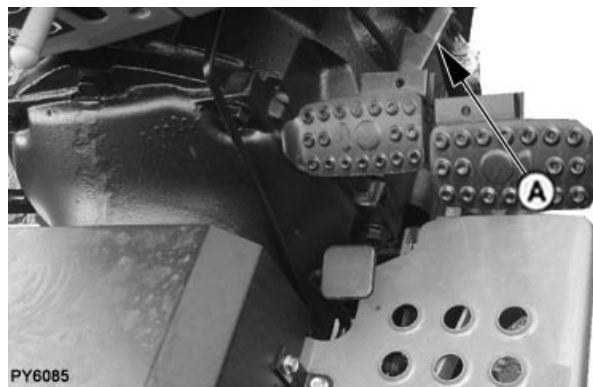

Brake pedals

A—Brake Pedals Locking Plate

Continued on next page

NR25796,000034B -19-29DEC06-1/2

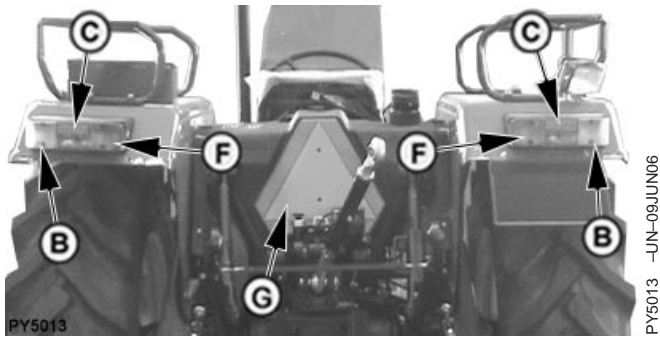

For 5103, 5103S, 5203, 5104 and 5204 Tractor

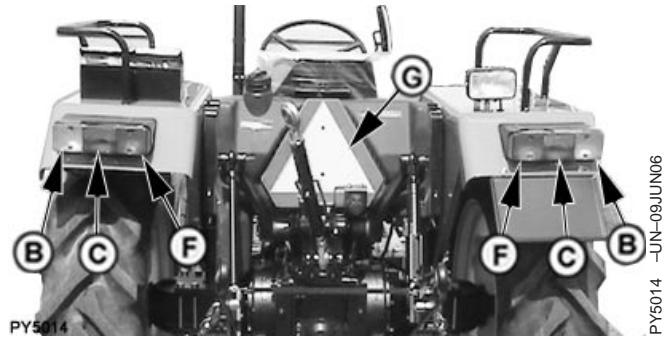

For 5103E Tractor

2. Check local laws and regulations for lighting requirements. Be sure Slow Moving vehicle (SMV) emblem (G), turn signal lights (B) and tail lights (F) are clean and visible. If towed or rear-mounted equipment obstructs these safety devices, install SMV emblem and warning lamps on equipment. (See your John Deere dealer)

3. Turn light switch to position (D).

Always turn light switch to dim lights position (A) when meeting another vehicle. Never use flood lamps or any other lights which could blind or confuse other drivers.

4. Use turn signal when turning. Be sure to return lever (E) to center position after turning.

5. Drive slowly enough to maintain safe control at all times. Before descending a hill, shift to a gear low enough to control speed without using brakes. Slow down for rough ground, and sharp turns, especially when transporting heavy, rear mounted equipment.



- A—Dim Headlight Switch Position
- B—Turn Signal Light
- C—Reflex Reflector
- D—Bright Headlight Switch Position
- E—Turn Signal Lever
- F—Tail Light
- G—SMV Emblem

Operating Transmission

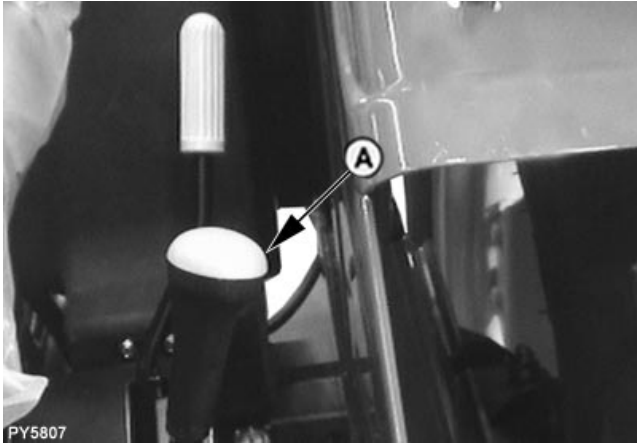

Range Shift Lever

A—Range Shift Lever

Range shift lever (A) provides two forward speed ranges, (A and B) and one reverse range (R).

Speed shift lever (B) provides four travel speeds.

Using range and speed shift levers in different combinations, eight forward speeds and four reverse speeds can be obtained.

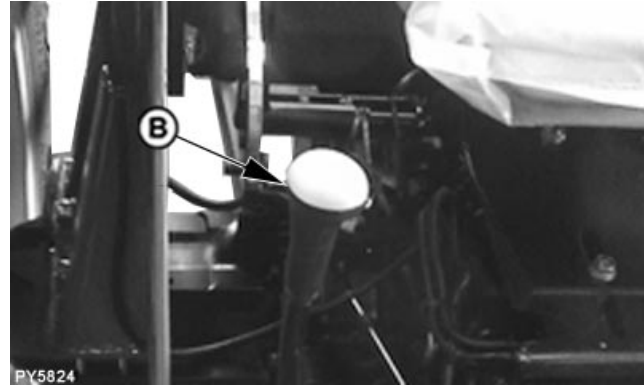

Speed Shift Lever

B—Speed Shift Lever

Range shift must be in neutral for the engine to be started.

NR25796,000034C -19-04AUG06-1/1

Shifting Transmission

IMPORTANT: To prevent transmission damage, do not use speed shift on-the-go. To prevent unnecessary wear, never “ride” the clutch by resting a foot on the pedal.

Depress clutch pedal (A) and stop tractor before shifting either range shift lever or speed shift lever. Release clutch pedal gradually to take up load smoothly.

A—Clutch Pedal

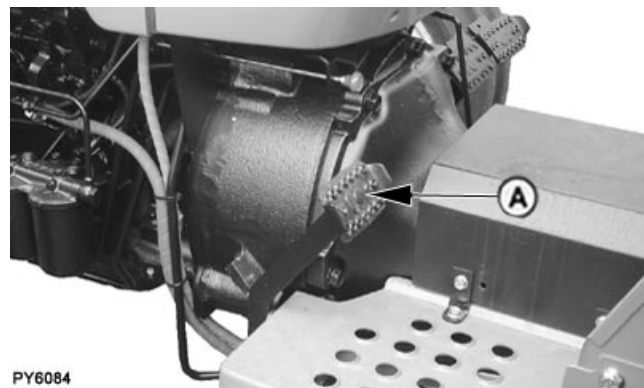

NR25796,000034D -19-04AUG06-1/1

Operating Transmission

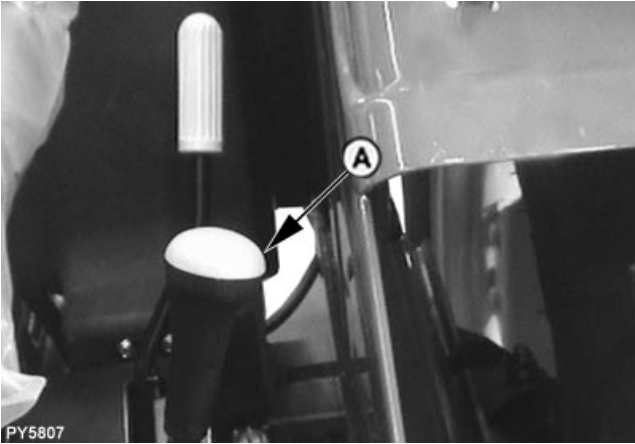

Range Shift Lever

A—Range Shift Lever

Range shift lever (A) provides two forward speed ranges, (A and B) and one reverse range (R).

Speed shift lever (B) provides four travel speeds.

Using range and speed shift levers in different combinations, eight forward speeds and four reverse speeds can be obtained.

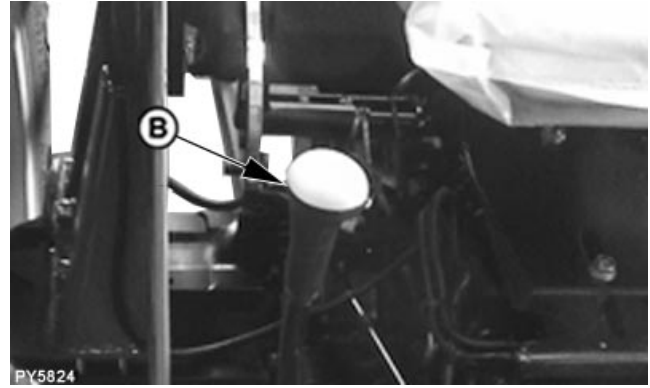

Speed Shift Lever

B—Speed Shift Lever

Range shift must be in neutral for the engine to be started.

PY80265,05GO839 -19-20JUN06-1/1

Selecting a Gear



PY5734 -UN-31MAY06

PY5734

For 5103, 5103S, 5203, 5104 and 5204 Tractor

IMPORTANT: To extend drive train life and avoid excessive soil compaction and rolling resistance when using ballast, operate one gear lower than normal.

The tractor may be operated in any gear with engine speeds between 1400 rpm and 2300 rated engine rpm.

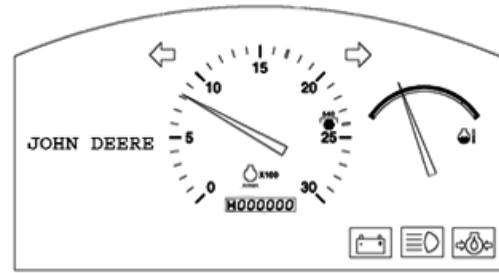

PY5758 -UN-01JUN06

PY5758

For 5103E Tractor

Within these limits the engine can be put under full load. For light load operation, use a higher gear and lower engine speed. This saves fuel and reduces wear.

Ground Speed Estimates for different tyre sizes are located in Specifications section.

PY80265.05GO841 -19-29DEC06-1/1

Using Brakes

CAUTION: Before operating tractor on a road, lock pedals together. Use brake lightly and cautiously at transport speeds.

Use individual brakes to assist in making sharp turns. Disengage brake pedal locking bar (A) and depress only one brake pedal.

To stop tractor, depress both brake pedals.

IMPORTANT: To prevent unnecessary wear, never ride the brakes by resting a foot on the pedals.

Reduce speed if towed load is not equipped with brakes and weighs more than the tractor. Avoid hard braking applications. Consult implement operators manual for recommended transport speeds.

Use additional caution when transporting towed loads under adverse conditions, when turning or stopping on inclines.

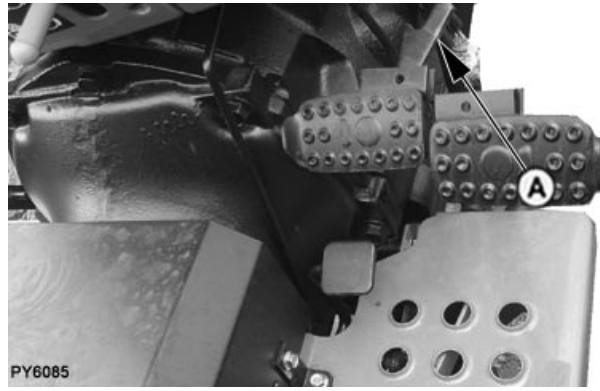

Brake Pedals

A—Brake Pedal Locking Bar

PY6085 -UN-06AUG06

NR25796,000034E -19-04AUG06-1/1

Using Differential Lock (Optional For 5103E Tractor)



CAUTION: DO NOT operate tractor at high speed or attempt to turn with differential lock engaged.

IMPORTANT: To prevent damage to drive train, DO NOT engage differential lock when one wheel is spinning and the other is completely stopped.

When one wheel starts to lose traction, engage differential lock by depressing pedal (A) down.

Unequal traction will keep the lock engaged. When traction equalizes, lock will disengage itself by spring action. If lock does not disengage, depress one brake pedal and then the other.

If tyres repeatedly slip, then get traction, then slip again, hold pedal in the engaged position.

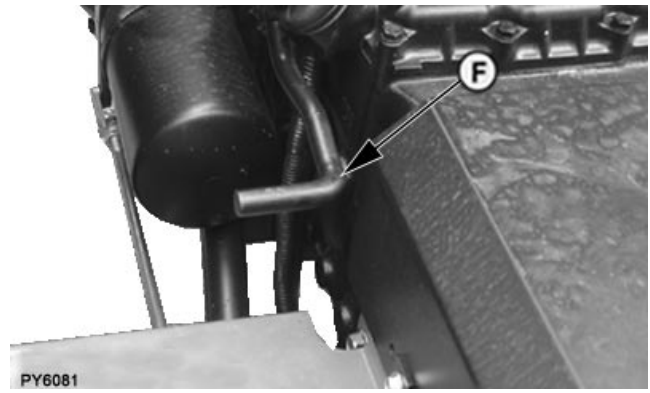

PY6081 -UN-06AUG06

Differential Lock Pedal

A—Differential Lock Pedal

NR25796,000034F -19-04AUG06-1/1

Stopping Tractor

CAUTION: Always place the range shift lever in neutral (N) and set brakes before dismounting. Leaving transmission in gear with engine off **MAY NOT** prevent tractor from moving.

1. Stop the tractor and place range shift lever (A) in neutral.
2. Apply brakes.
3. Lower all equipment to ground using rockshaft position control lever (D) and rockshaft draft control lever (C),
4. Pull hand throttle (B) down to slow idle position. Allow engine to idle for one to two minutes.

IMPORTANT: Cooling of certain engine parts is provided by engine oil. Stopping a hot engine suddenly could cause damage to these parts by overheating or lack of lubrication.

CAUTION: Remove the key from key switch to prevent operation by untrained personnel.

5. Turn key switch to OFF position.
6. Pull manual fuel shut-off knob (E) (at lower left side of control support) rearward and hold until engine has completely stopped.

- A—Range Shift Lever
- B—Hand Throttle Lever
- C—Rockshaft Draft Control Lever
- D—Rockshaft Position Control Lever
- E—Fuel Shut Off Knob

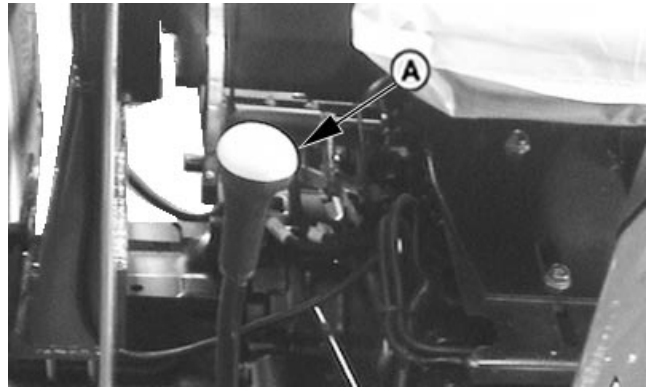

PY6080 -UN-06AUG06



PY4911 -UN-14APR05

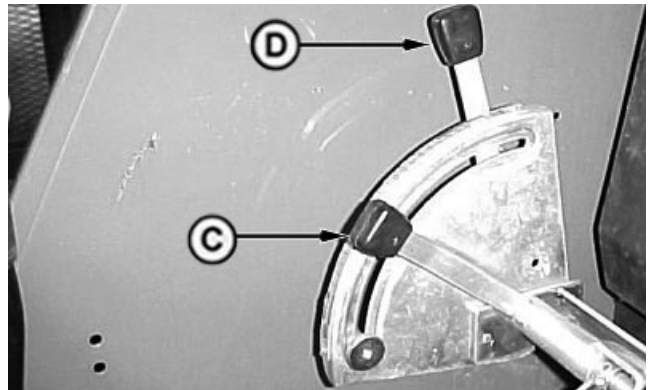

PY4138 -UN-26AUG04

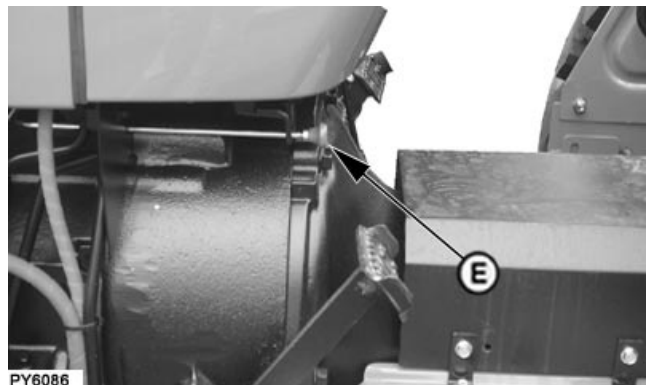

PY6086

PY6086 -UN-06AUG06

NR25796,0000351 -19-04AUG06-1/1

Rockshaft and 3-Point Hitch

Match Tractor Power to Implement

IMPORTANT: Tractor power should be matched to the size of certain implements. Excessive power can damage an implement, and too large an implement can damage the tractor. (Refer to your implement operator's manual for minimum and maximum power requirements before attaching an implement.)

PY80265,05GO845 -19-10SEP05-1/1

3-Point Hitch Components

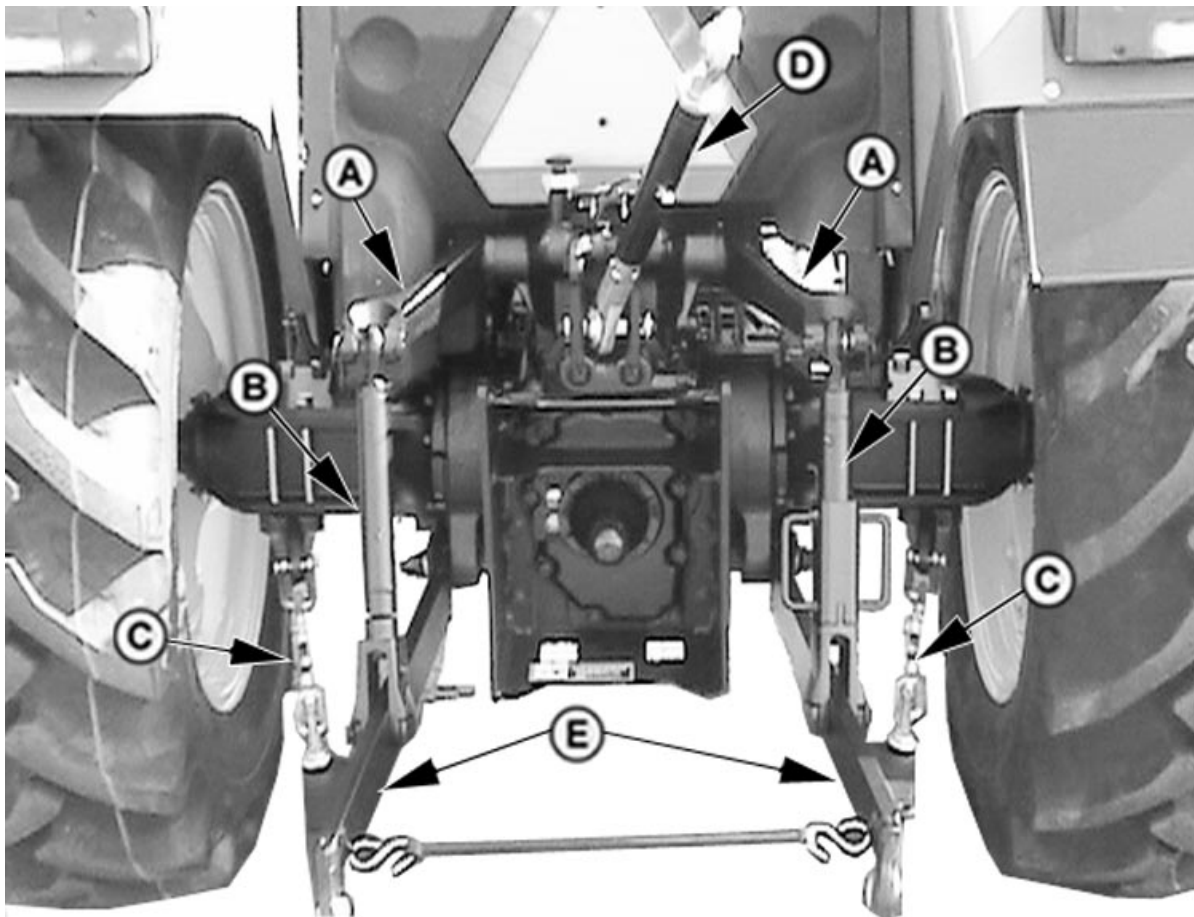

PY4959 -UN-27APR05

A—Lift Arms
B—Lift Links

C—Sway Chains

D—Center Link

E— Draft Links

PY80265,05GO846 -19-12JUN06-1/1

Rockshaft Control Levers

The rockshaft position is controlled by two levers, the rockshaft position control lever (A) and the rockshaft draft control lever (B)

The rockshaft position control lever (A) raises the hitch when pulled rearward, and lowers the hitch when moved forward. See Using Rockshaft Position Control in this section for more information.

The rockshaft draft control lever (B) controls hitch position relative to draft loads. See Using Draft Control in this section for more information.

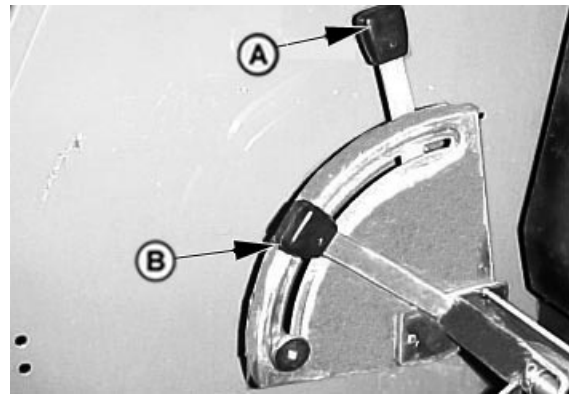

A—Rockshaft Position Control Lever
B—Rockshaft Draft Control Lever

PY80265,05GO848 -19-04JUL06-1/1

Setting Position Control Lever Stop

NOTE: Position control lever stop is used when operating depth or height needs to be repeated.

1. Operate implement for a few minutes to determine proper depth or height.
2. Loosen lever stop (A), and slide against position control lever. Lock stop in position by turning in a clockwise direction. Rockshaft will now lower to same position each time control lever is pushed forward to the stop.

A—Lever Stop

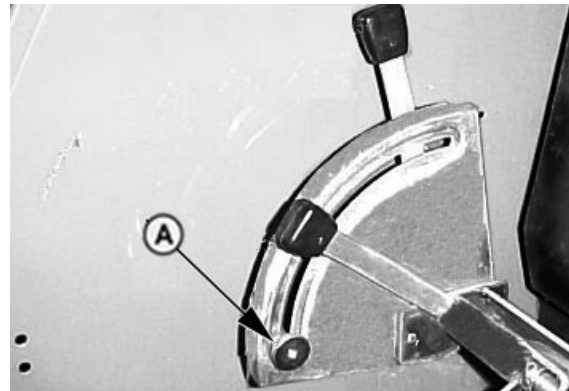

PY80265,05GO849 -19-10SEP05-1/1

Using Rockshaft Position Control

CAUTION: To prevent unexpected movement of rockshaft, place draft control lever (B) in a full forward position before attaching an implement.

Put draft control lever (B) forward when you DO NOT want rockshaft to adjust automatically to draft load, such as attaching implement to tractor.

Use position control lever (A) to control hitch movement and depth. Position control should be used for the following applications:

TRANSPORT of implements and end of field turn-around. Position control lever should be moved fully rearward (C) for transport for both load and non-load sensing usage.

CONSTANT DEPTH of implements on level terrain and for non-ground engaging implements such as spreaders or sprayers. Place position control lever at depth desired (D).

FLOAT operation for implements with skids or depth gauge wheels designed to carry full implement weight. Push both levers all the way forward (E) so implement can follow the ground contour.

NOTE: Lift links can be adjusted for lateral float. (See Lateral Float in this section.)

- A—Rockshaft Position Control Lever
- B—Rockshaft Draft Control Lever
- C—Position Control Lever in Rearward Position
- D—Position Control Lever in Desired Depth Position
- E—Position Control Lever and Draft Control Lever in Float Position

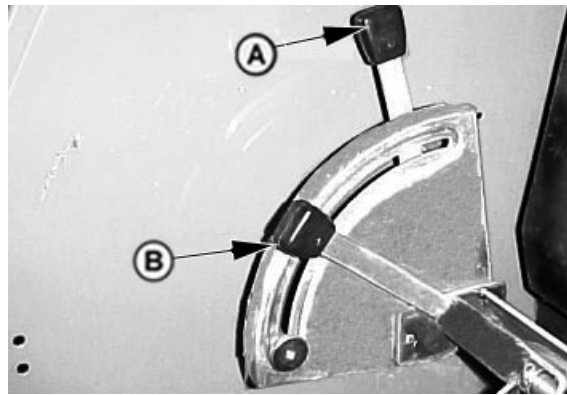

PY4960 -UN-22APR05

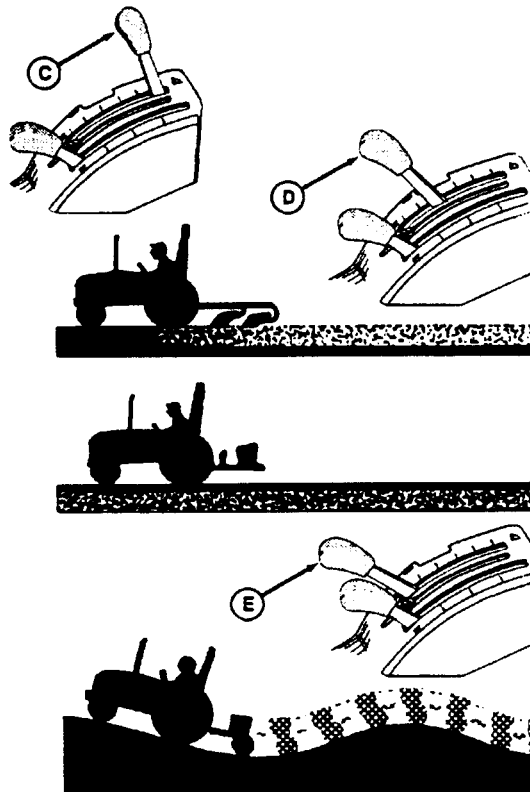

M47168 -UN-31JAN92

PY80265.05GO850 -19-10SEP05-1/1

Using Draft Control

The rockshaft may be equipped with variable draft control system.

Use draft load sensing when:

- Operating with a fully mounted implement in hill and swale terrain. The implement will raise and lower to follow the ground contours while maintaining a nearly constant depth.
- Operating in varying soil conditions. The implement is raised slightly to get through tough spots so you do not have to shift to a lower gear.

Draft control lever (B) controls amount of load required before hitch responds. With lever placed fully forward to the position marked "off" (C), there is no draft sensing. Placing the lever toward the rear position reduces the amount of draft load required to override the position setting set by the position control lever (A) and raise the rockshaft.

Draft sensitivity ranges can be changed by repositioning the center link. (See Positioning Center Link in this section for additional information.)

For draft load sensing operation:

- Initially place position control lever (A) in its fully rearward position and the draft control lever (B) in the fully forward (least draft) position.
- With tractor moving, push position control lever (A) forward to set implement operating depth. Set position control lever stop (D) so control lever can be brought back to the same position. The operating depth set-up will prevent the rockshaft from lowering all the way when the tractor begins to slip. Then pull draft sensing lever (B) rearward until desired draft sensing sensitivity is obtained.
- The position control lever (A) can also be raised slightly to override the draft control setting to help get through slippery spots without getting stuck.
- The position control lever (A) can be moved fully rearward to raise the hitch at the end of the field.

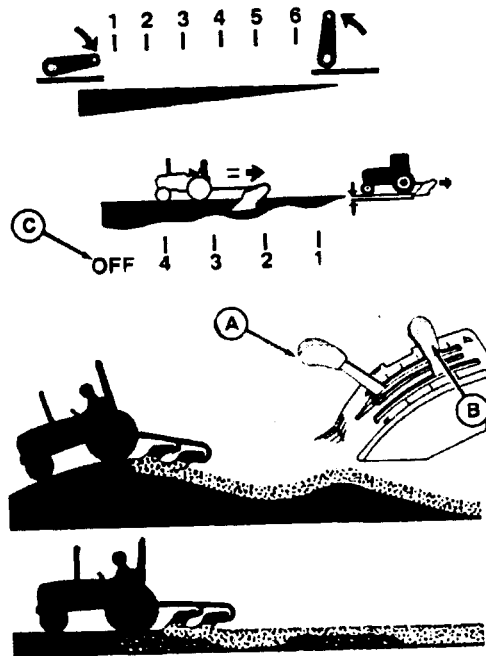
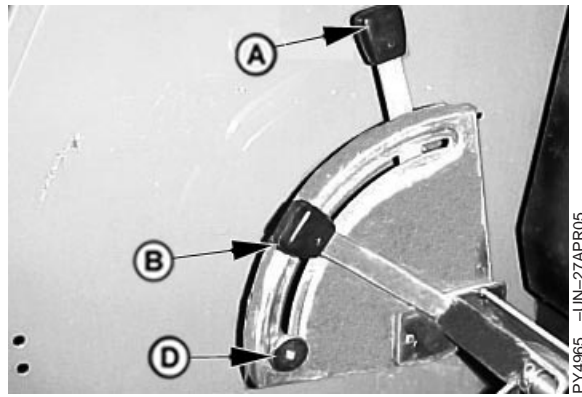

A—Rockshaft Position Control Lever
 B—Rockshaft Draft Control Lever
 C—Draft Sensing OFF Position
 D—Position Control Lever Stop

Adjusting Rockshaft Rate-of-Drop/ Implement lock

CAUTION: Excessive rate-of-drop may cause damage or injury. Fully lowering implement should require at least two seconds.

Rockshaft drops faster when a heavy implement is attached. Adjust rate-of-drop knob so that it is slow enough to be safe and prevent implement damage.

Turn rockshaft rate-of-drop knob (A), located under the seat, clockwise to slow rockshaft drop.

Turn knob counterclockwise to increase rate-of-drop.

Rate-of-drop knob is also called implement lock. When knob is fully screw in, implement will not lower down even if position control lever is fully down. Use implement lock while transporting implement.

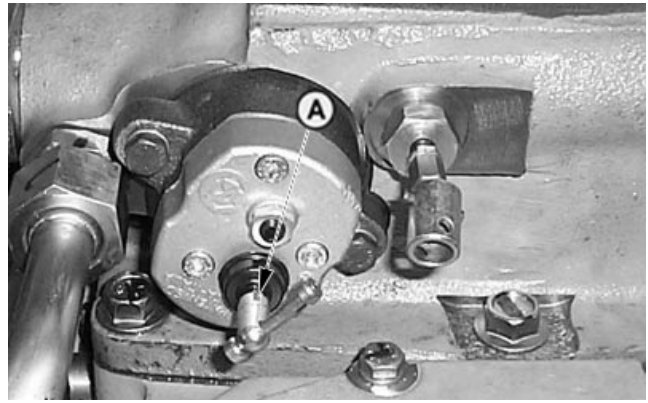

PY4076 -UN-11AUG04

A—Rockshaft Rate-of-Drop Knob cum Implement Lock

PY80265.05GO852 -19-10SEP05-1/1

Attaching Tipping Trailer

Hydraulic power can be extended to tipping trailer through auxiliary port (A). When preselector (B) is fully screwed-in, hydraulic oil will move to tipping trailer. Use draft control lever for lowering or raising of trailer.

NOTE: When tipping trailer is not attached to tractor, fully screw-out preselector knob, otherwise rockshaft will not function.

A—Auxiliary Port
B—Preselector Knob

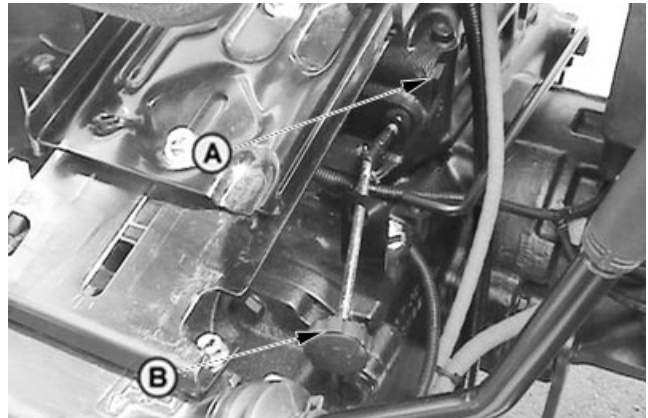

PY4096 -UN-21AUG04

PY80265.05GO853 -19-10SEP05-1/1

Preparing Implement

Category II implements should have the top hole of the implement mast located 610 mm (24 in.) above the lower pins. Drill another hole in top mast or extend top mast if necessary.

Category	Mast Height	Width Between Lower Pins	Pin Size	
			Lower	Upper
II	610 mm (24 in.)	824 mm (32-7/16 in.)	28.7 mm (1-1/8 in.)	25.5 mm (1 in.)

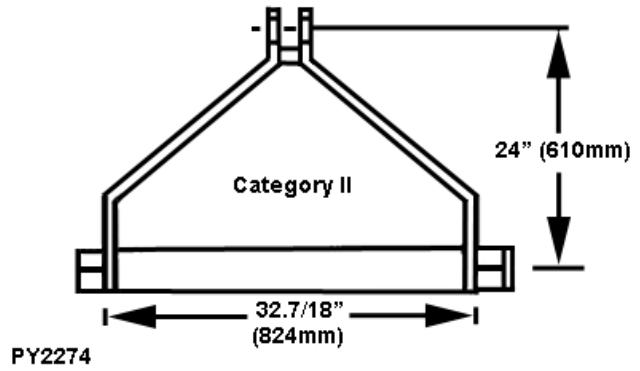

PY2274 -UN-07JUN06

PY80265,05GO854 -19-10SEP05-1/1

Positioning Center Link

The draft sensing rockshaft center link attaching bracket has holes which allow three different positions for attaching the center link. The position effects the draft sensing sensitivity.

Standard position is (C).

Move the center link attachment to holes (B) if:

- Excessive hitch activity or hunting occurs in draft control operation.
- The rear of the implement raises too much when lifted. The implement weight which can be lifted is reduced slightly with the center link attachment in the lower holes.
- The draft control lever range is too small.

Move the center link attachment to holes (C) if:

- The hitch seems unresponsive in draft control operation and allows the engine speed to drop too far before raising the rockshaft.
- The rear of the implement droops and drags the ground as the implement is lifted.

Upper hole (A) eliminates nearly all draft sensing.

NOTE: *Implements with Category II mast height 610 mm (24 in.) will use the upper two holes.*

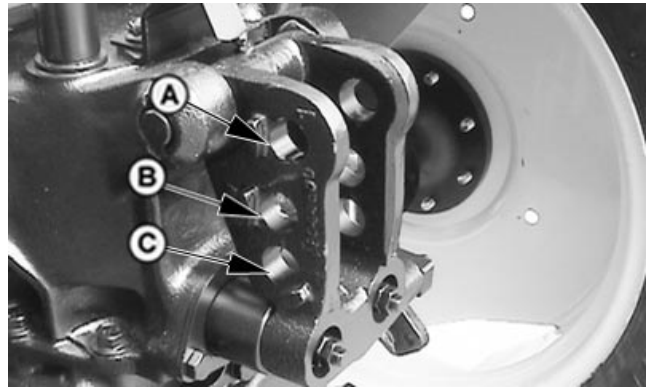

A—Upper Hole
B—Middle Hole
C—Lower Hole

PY4967 -UN-11DEC05

Attaching Implements to 3-Point Hitch

1. Be sure drawbar will not interfere. If necessary, move drawbar ahead, or remove it. Check for any other potential interference.

CAUTION: Prevent unexpected movement of rockshaft by placing draft sensing lever in the forward or OFF position before attaching implement to hitch.

2. Back tractor up to implement (A) so hitch points (B) align. Place transmission in neutral (N), stop the engine and engage brakes BEFORE leaving the tractor seat.
3. Slip draft links over implement hitch pins (B), and retain with quick-lock pins.

NOTE: Locking pins can be stored on draft links (through holes in sway chain ears) when not in use.

4. To remove center-link from transport hook, lift center link locking clip (C), and rotate tab (D) to rear of center link clip.
5. Attach center link to implement top mast.
6. Adjust center link and lift links as necessary. (See Leveling the Hitch in this section.)

CAUTION: To avoid bodily injury or machine damage whenever an implement, implement quick coupler, or other attachment is connected to the tractor 3-Point Hitch, check full range of operation for interference, binding or PTO separation.

7. Using rockshaft position control lever (E), lower and raise implement slowly and check for any point of interference.

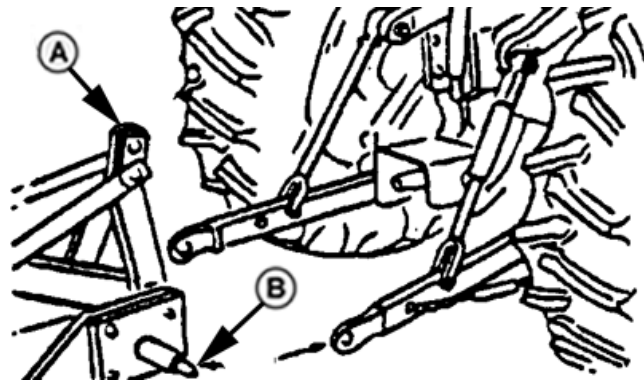

PY5374 -UN-09DEC05

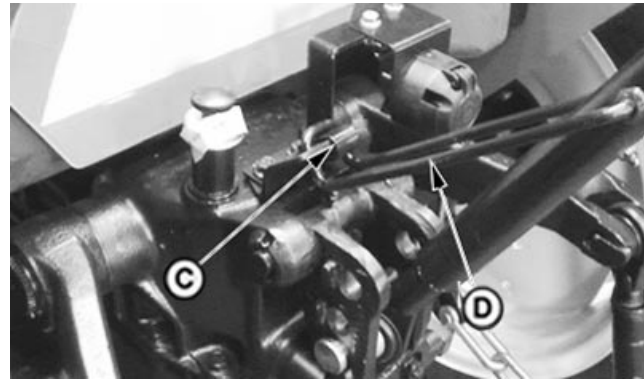

PY5375 -UN-09DEC05

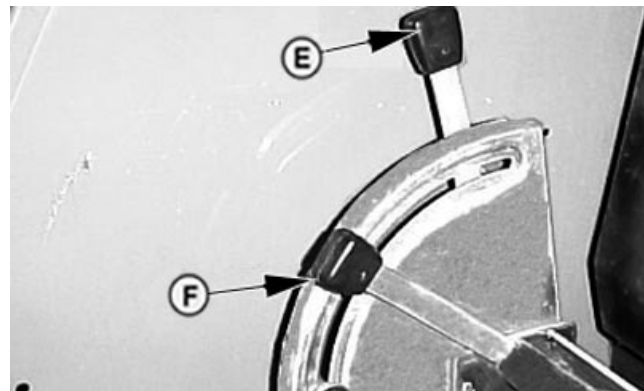

PY5376 -UN-11DEC05

- A—Implement
- B—Implement Hitch Pins
- C—Center Link Locking Clip
- D—Tab
- E—Rockshaft Position Control Lever
- F—Rockshaft Draft Control Lever

Adjusting Hitch Side Sway

NOTE: Check implement operator's manual for instruction on whether to allow side sway.

NOTE: Use spring or rubber strap to keep draft links out of rear tyres when draft links are not attached to implement.

Implement side sway should be adjusted when the rockshaft is raised for transport by loosening the jam nut on the threaded link (A) and turning the center rod to increase or decrease the length of chain. Tighten jam nut again when adjusted.

A—Threaded Link

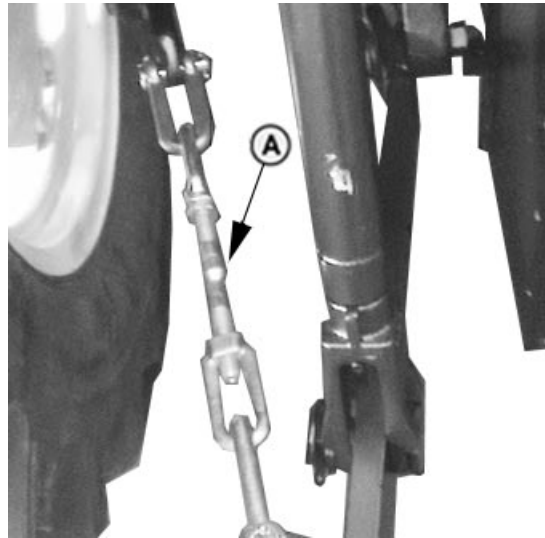

PY4970 -UN-10DEC05

For 5103, 5103S, 5203, 5104 and 5204 Tractor

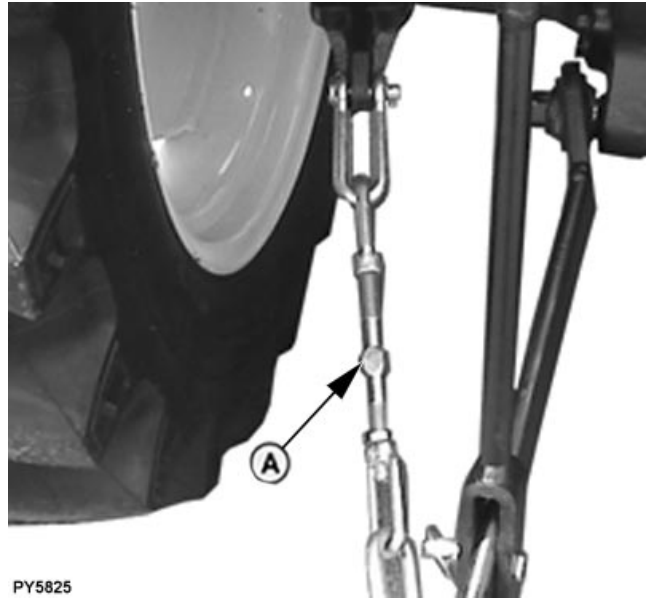

PY5825

PY5825 -UN-20JUN06

For 5103E Tractor

PY80265,05GO857 -19-29DEC06-1/1

Leveling the Hitch

1. Lower implement to take weight off hitch.

IMPORTANT: DO NOT attempt to overextend center link beyond limits of locking clip or lift links past the stops. Link body threads could be damaged.

NOTE: Maximum adjustment range of the center link can only be obtained if the ends are positioned equally within the body when attached to an implement.

2. Adjust center link to level implement front-to-rear. Unlatch locking clip (A). Rotate center link body clockwise to lengthen center link or counterclockwise to shorten it. Be sure to latch the locking clip.

3. Adjust right-hand link to level implement side-to-side. Lift locking handle (C) and turn 1/4 turn to engage slot (D) onto roll-pin in the center portion of the lift link.

Turn crank handle (C) clockwise to raise draft link.

Turn crank handle (C) counterclockwise to lower draft link.

After adjustment, lift handle (C) and turn to engage slot (D) onto the lower body to prevent change of adjustment during operation.

4. The left-hand lift link is also adjustable in length to accommodate different tyre sizes.

To change the left-hand lift link length, remove the upper lift link pin and rotate the upper end assembly clockwise to shorten or counterclockwise to lengthen, and then reinstall the upper pin and locking pin.

Adjust left and right lift links to accommodate various tyre sizes. Set the lift links to have fully-lowered draft link balls approximately seven inches off the ground for greatest range of usable hitch motion.

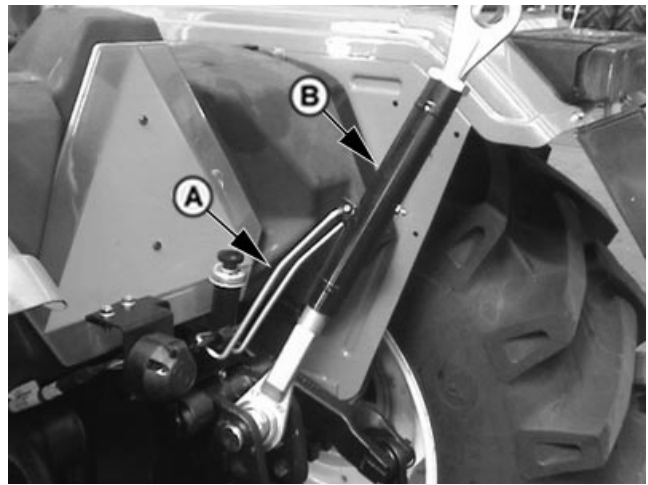

PY4968 -UN-23APR05

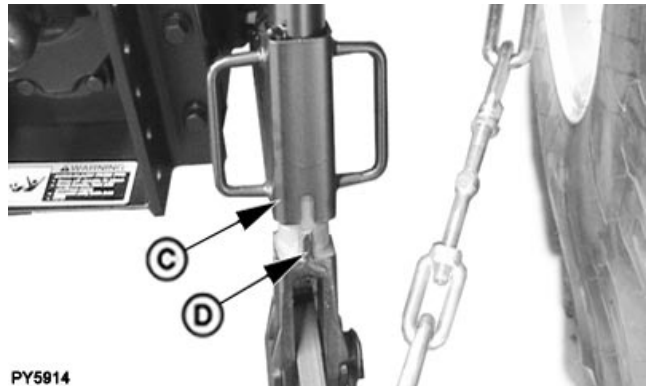

PY5914

For 5103, 5103S, 5203, 5104 and 5204 Tractor

-UN-12JUL06

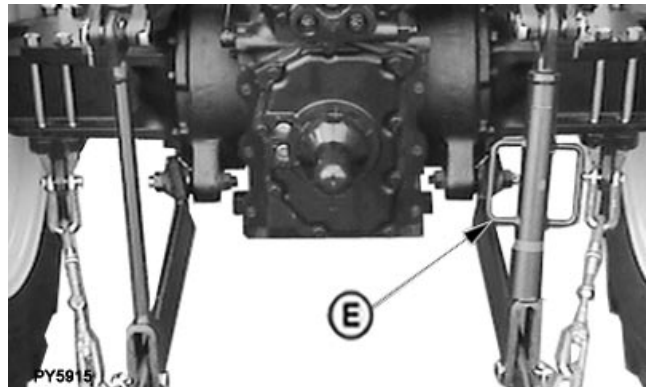

PY5915

For 5103E Tractor

-UN-12JUL06

- A—Locking Clip
- B—Center Link Body
- C—Locking Handle
- D—Slot

Adjusting Lateral Float

To allow the draft link to raise slightly as implement follows ground contour, place head of float pin and the rectangular washer on the inside end of the pin in a vertical position (A).

To hold implement rigid, place head of float pin and the rectangular washer in the horizontal position (B).

Use lift link pins in the float position for hitch-mounted implements such as a cultivator or mower, which have ground gauging skids or wheels which may cause the implement to twist relative to the tractor.

Use the rigid position for implements such as plows and ground engaging implements that should not twist relative to the tractor.

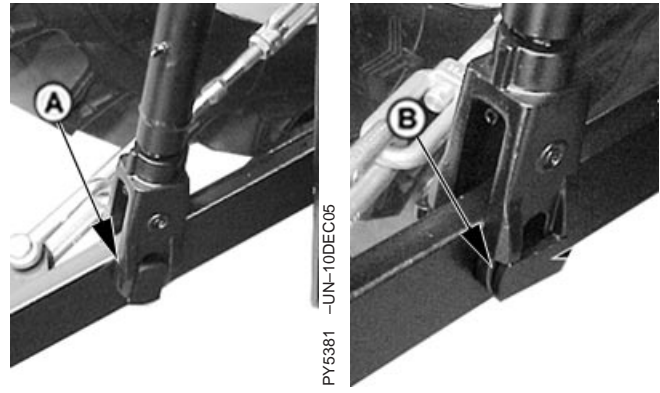

A—Pin in Vertical Position
B—Pin in Horizontal Position

PY80265.05GO859 -19-10SEP05-1/1

Adjusting Rockshaft Control Lever Friction

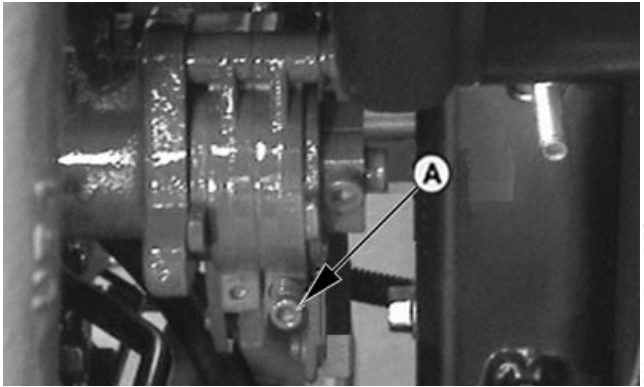

A—Adjustment Set Screws
Back Side Of Control Lever

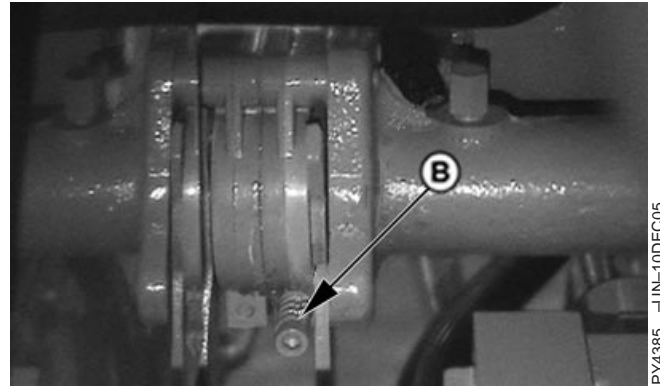

B—Adjustment Set Screws
Front Side Of Control
Lever

If the rockshaft position control lever or rockshaft draft control lever do not stay in set position, increase lever

friction by tightening the set screws (A) for the appropriate lever until the proper friction is obtained.

PY80265.05GO860 -19-10SEP05-1/1

Warming Hydraulic System Oil

Hydraulic system may be slow to function when tractor is started in cold weather. This is because cold oil will not flow as easily through the hydraulic system filter (A).

Steering may be slow until system warms up.

Hydraulic system will function normally when oil warms up.

A—Hydraulic Oil Filter

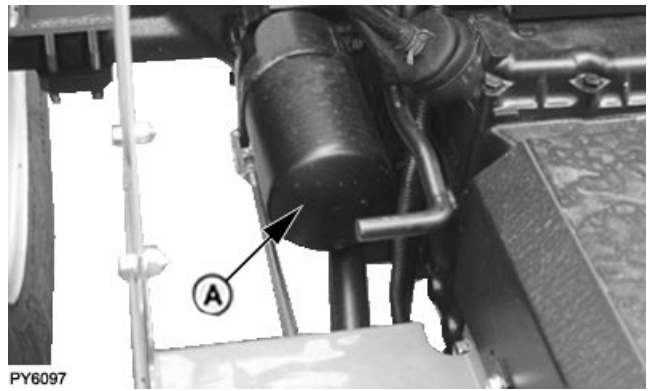

PY6097

Right Side of Transmission

PY6097 -UN-06AUG06

NR25796,0000352 -19-29DEC06-1/2

IMPORTANT: To prevent damaging hydraulic pump or relief valve, **DO NOT** exceed two to three minutes warm-up time with steering wheel held in full left or full right turn position.

1. Depress clutch pedal, start engine and idle at about 1000 rpm.
2. Turn and hold steering wheel in full left or right turn.



PY5734

For 5103, 5103S, 5203, 5104 and 5204 Tractor

PY5734 -UN-31MAY06



PY5758

For 5103E Tractor

NR25796,0000352 -19-29DEC06-2/2

PY5758 -UN-01JUN06

Drawbar and PTO

Observe Drawbar Load Limitations

IMPORTANT: Certain heavy equipment, such as a loaded single-axle trailer, can place excessive strain on drawbar. Strain is greatly increased by speed and rough ground.

Static vertical load on drawbar should not exceed 556 kg (1225 lb).

Drive slowly with heavy loads.

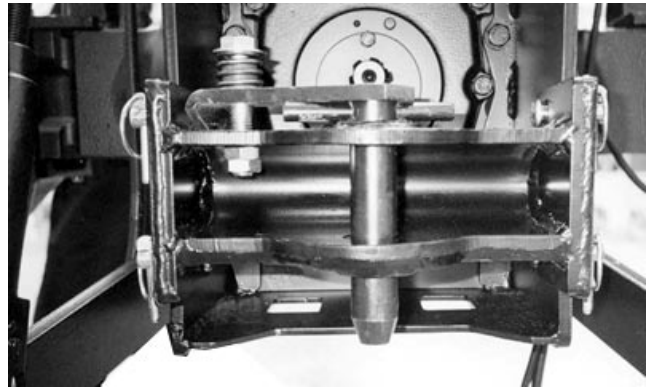

PY1094 -UN-10APR05

Drawbar

Specification

Drawbar Static Vertical Load—
Capacity..... 556 kg (1225 lb) Maximum

NR25796,0000257 -19-11JUL06-1/1

Stay Clear of Rotating Drivelines

Entanglement in rotating driveline can cause serious injury or death.

Keep tractor master shield and driveline shields in place at all times. Make sure rotating shields turn freely.

Wear close fitting clothing. Stop the engine and be sure PTO driveline is stopped before making adjustments, connections, or cleaning out PTO driven equipment.



TS1644 -UN-22AUG95

PY80265,05GO862 -19-10SEP05-1/1

Attaching PTO-Driven Implement

CAUTION: Stop engine before attaching implement or working in area of implement hitch.

1. Attach implement to tractor before connecting PTO drive line. Raise hitch to upward position if it is not to be used.
2. Range shift lever in neutral (N), key to OFF position to stop engine and set brakes.
3. If PTO driven implement will be attached to drawbar (A), the drawbar must be positioned so there is 355 mm (14 in.) between end of PTO shaft and center of drawbar pin hole. Make sure drawbar locking pins and spring pins are in place. If implement will be connected to 3-Point Hitch, be sure drawbar will not interfere. Remove it if necessary.

NOTE: *There are two holes at the front of the drawbar. Place the drawbar pin in the second hole for the proper 355 mm (14 in.) length.*

4. Rotate PTO shield upward for clearance. With engine off, turn shaft slightly by hand if necessary to line up splines. Connect drive line to PTO shaft. Pull out on shaft to be sure drive line is locked to PTO shaft. Place PTO shield in downward position.
5. Be sure all shields are in place and in good condition. Never operate PTO unless master shield is properly installed. WITH ENGINE STOPPED, check integral shields on drive line by making sure they rotate freely on shaft. Lubricate or repair as necessary.
6. Check carefully for any interference, make sure hitch is raised to the upper position if it is not used.

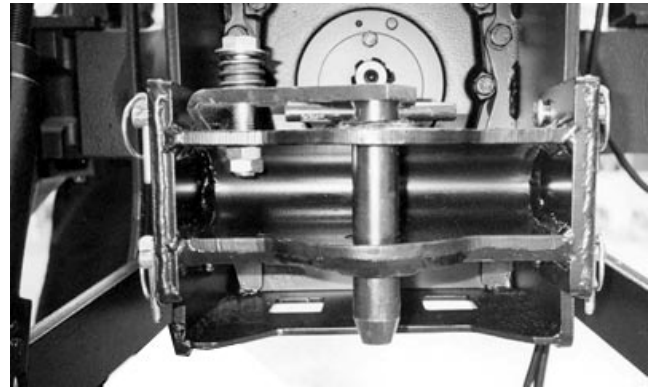

A—Drawbar

Operating Tractor PTO



Hand Throttle Lever

PY4485 -UN-16FEB06

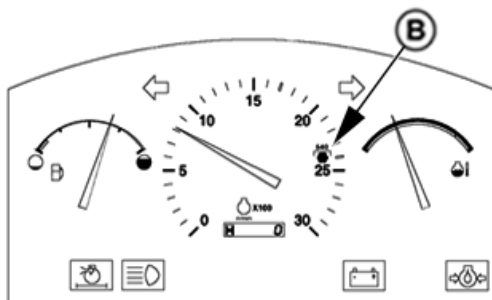

PY5736

For 5103, 5103S, 5203, 5104 and 5204 Tractor

PY5736 -UN-31MAY06

1. Depress clutch pedal, start engine and push hand throttle lever (A) forward until engine speed is sufficient to start PTO implement. Engine speed must be less than 2200 rpm (B).
2. Move control lever (A) forward to engage PTO. PTO indicator (B) will light when PTO is engaged.
3. Increase engine speed to rated PTO speed of 2200 rpm for 540 operation.

A—Hand Throttle Lever
 B—540 Operation Speed

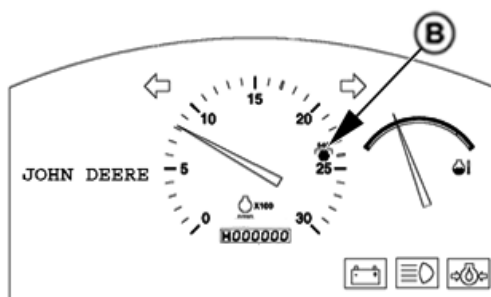

PY5760

For 5103E Tractor

PY5760 -UN-01JUN06

Continued on next page

PY80265,05GO864 -19-29DEC06-1/2

⚠ CAUTION: Turn key OFF and pull Fuel Shut-off Knob to stop engine, set brakes and make sure all mechanisms have stopped before cleaning out machine or making any adjustments to PTO driven implement.

4. Pull control lever back to disengage PTO.

C—PTO Control Lever

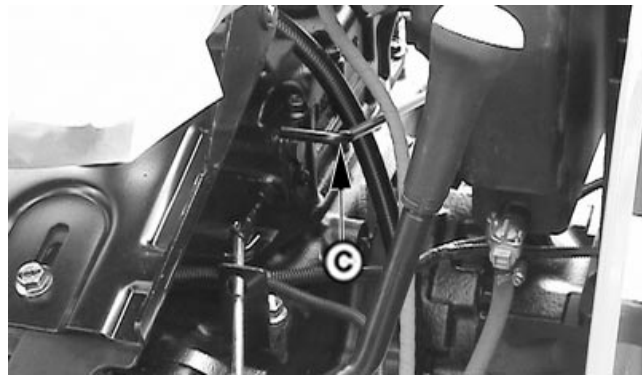

Dual Clutch



Single Clutch

PY80265.05GO864 -19-29DEC06-2/2

Adjusting PTO Clutch Operating Rod



1. Move PTO lever (A) to rearward (disengaged) position.
2. Remove clip pin (B) from forward end of PTO clutch rod.
3. Check for equal thread engagement at turnbuckle (G). Loosen jam nuts (F) and (C). Turn rod (D) until threads on each side of turnbuckle are equal. Tighten jam nut (F).
4. Loosen jam nut (C) from rear of front clevis (E).
5. Adjust length of arm (D) so the clip pin (B) can be inserted with the rod pulled forward and the arm pulled rearward to eliminate free play. Lengthen rod by turn of the clevis to provide PTO clutch lever free play and PTO clutch rod travel in fully engaged position to specification.

Specification

PTO Clutch Lever—Free Play	15 mm
PTO Clutch Rod (In Fully Engaged Position)—Travel.....	14 mm -16 mm

NOTE: Adjust turnbuckle (G) if you cannot make proper adjustment with clevis.

6. Reinstall clip pin (B) in clevis (E) and arm (D).
7. Tighten jam nut (C) at clevis.

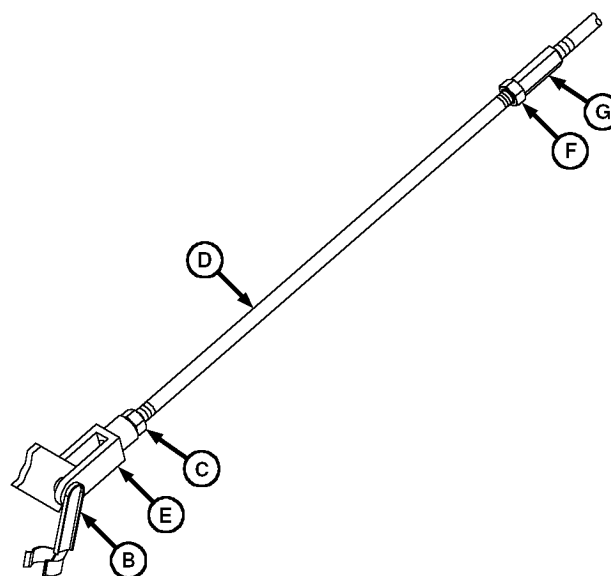

LV4082 -UN-02NOV99

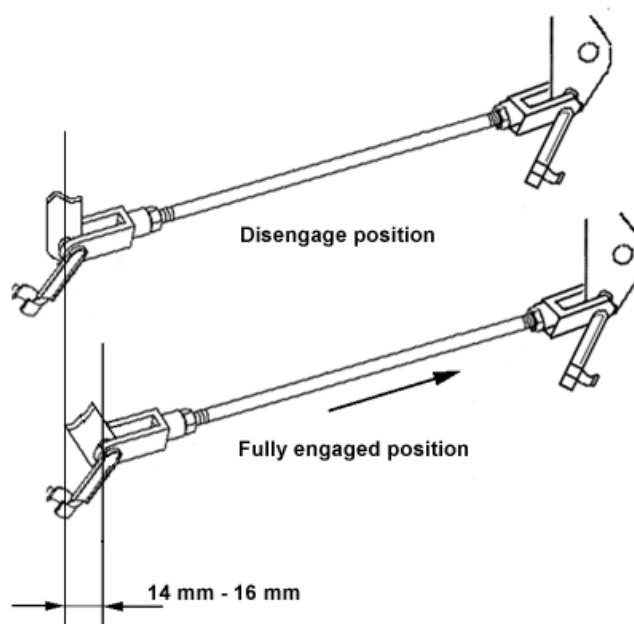

PY5019 -UN-21MAY05

- A—PTO Clutch Lever
- B—Clip Pin
- C—Jam Nut
- D—Arm
- E—Clevis
- F—Jam Nut
- G—Turnbuckle

Ballast

Planning for Maximum Productivity

Proper ballasting is an important factor in tractor performance. maximum productivity can be achieved only if tractor weight is appropriate for the job.

John Deere FMO (Fundamentals of Machine Operations) Tractors, discusses methods of determining correct tractor weight and ballast selection.

FMO-Machinery Management includes information on tractor and implement matching and increasing productivity. .

Your John Deere dealer can assist you with information on these subjects.

PY80265.05GO866 -19-10SEP05-1/1

Selecting Ballast Carefully

Match amount of ballast needed for each job. What is right for one job may be wrong for another job. Ballast for traction and stability.

Factors determining amount of ballast:

- Soil surface-loose or firm.
- Type of implement-integral/semi-integral or towed.
- Travel speed-slow or fast.
- Tractor power output-partial or full load.
- tyres-single, oversize, or dual.

PY80265.05GO867 -19-10SEP05-1/1

Matching Ballast to Load Work

Use no more ballast than necessary, and remove ballast when it is no longer needed.

Rather than weighing tractor down to pull heavy loads, try to reduce load. Pulling a lighter load at a higher speed is more economical and more efficient.

The best way to check for correct ballast is to measure amount of travel reduction (% slip) of the drive wheels. Under normal field conditions, travel reduction should be 10—15 percent.

Add more weight to drive wheels if slip is excessive. If there is less than 10 percent slip, weight should be removed.

Too Little Ballast		Too Much Ballast	
1.	Excessive wheel slip	1.	Increased load
2.	Power loss due to churning soil	2.	Power loss due to carrying extra weight
3.	tyre wear	3.	tyre strain
4.	Fuel waste	4.	Soil compaction
5.	Lower productivity	5.	Fuel waste
		6.	Lower productivity

PY80265.05GO868 -19-10SEP05-1/1

Measuring Wheel Slip—Manually

1. Place a mark (A) on a rear tyre which is easily observed (a chalk mark is recommended).
2. With tractor working and implement lowered, mark a starting point (B) on the ground at the place where the tyre mark (A) meets the ground.
3. Mark the ground again where the tyre mark (A) completes 10 full revolutions (C).
4. With implement raised return in the opposite direction. At the second mark on the ground (C) remark the tyre (D).
5. While driving the tractor along the same path (implement raised), count the tyre revolutions required to reach the starting point (B).
6. Use the return tyre revolutions count and “Wheel Slippage Chart” to determine slippage. 10—15 percent is ideal.
7. Adjust ballast or load to give correct slippage.

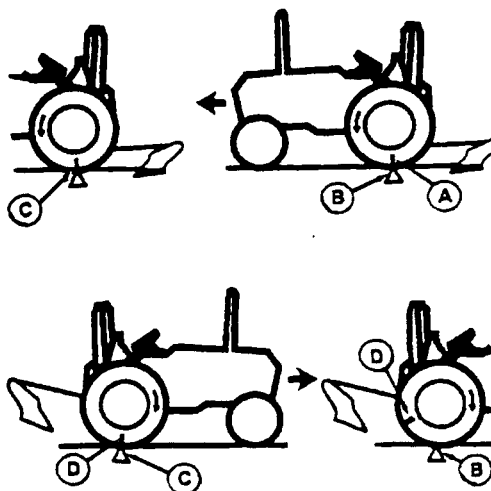

NOTE: Available horsepower is greatly reduced when wheel slip drops below 10 percent.

WHEEL SLIPPAGE CHART		
Non-Loaded Wheel Revolutions (Step 5)	Estimated % Slip	Recommended Action
10	0	Remove Ballast
9-1/2	5	Remove Ballast
9	10	Proper Ballast
8-1/2	15	Proper Ballast
8	20	Add Ballast
7-1/2	25	Add Ballast
7	30	Add Ballast

M47166 -JUN-31JAN92

PY80265.05GO869 -19-10SEP05-1/1

Ballast Limitations

Ballast should be limited by either tyre capacity or tractor capacity. Each tyre has a recommended carrying capacity which should not be exceeded (see Wheels, tyres and Treads section). If a greater amount

of weight is needed for traction, a larger tyre should be considered.

Ballast can be added as either liquid or cast iron.

PY80265.05GO870 -19-10SEP05-1/1

Ballasting Front End for Transport

CAUTION: Additional front ballast may be needed for transporting rear-mounted implements. When implement is raised, drive slowly over rough ground, regardless of how much ballast is used.

CAUTION: Weights are heavy. Use proper lifting equipment. Approximate weight of starter weight (C) is : 49 kg (109 lb). Approximate weight of QUIK-TATCH™ weights (D) are 45 kg (99 lb).

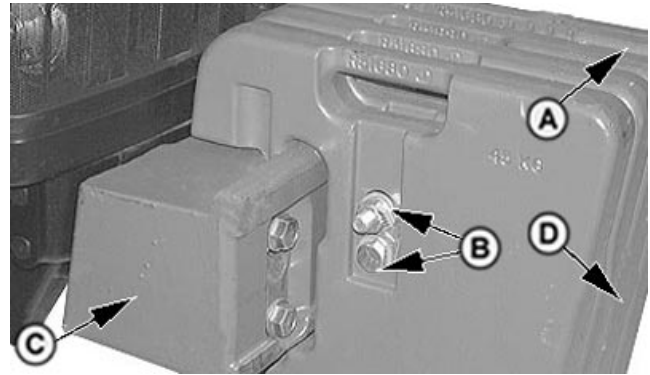

A—Ballast Center
B—Ballast Retaining Bolts
C—Starter Weight
D—QUIK-TATCH Weights

Specification

Starter Weight (Ballast)—Weight	49 kg (109 lb)
QUIK-TATCH™ Weight (Ballast)—Weight.....	45 kg (99 lb) Each

Installing QUIK-TATCH™ Weights: QUIK-TATCH™ weights can be installed on the front of the tractor.

One starter weight and up to 8 QUIK-TATCH™ weights can be installed.

1. Install weights in pairs, one on each side of center (A).
2. To hold weights in place, run retaining bolts (B) through holes from side-to-side. Tighten to specification.

Specification

Ballast Weights Retaining Bolts—	
Torque	230 N•m (170 lb-ft)

Ballasting Front End for Transport (5103E Tractor)

CAUTION: Additional front ballast may be needed for transporting rear-mounted implements. When implement is raised, drive slowly over rough ground, regardless of how much ballast is used.

CAUTION: Weights are heavy. Use proper lifting equipment. Approximate weight of Front Bumper (A) is : 61 kg (135 lb). Approximate weight of each Ballast weight (C) is 23 kg (51 lb).

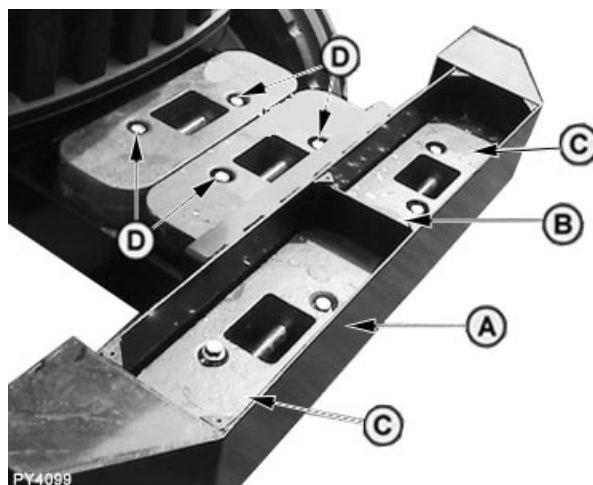

Front Bumper

- A—Front Bumper
- B—Ballast Center
- C—Ballast Weight
- D—Ballast Retaining Bolt

Specification

Front Bumper—Weight.....	61 kg (135 lb)
Ballast Weight—Weight.....	23 kg (51 lb)

Installing Weights: Upto 8 weights can be installed on the front bumper of the tractor as per requirement.

1. Install weights in pairs, one on each side of ballast center (B).
2. To hold weights in place, run retaining bolts (D) through holes. Tighten to specification.

Specification

Ballast Weights Retaining Bolts—	
Torque	130 N•m (96 lb-ft)

PY4099 -UN-12JUN06

PY80265,05GO872 -19-12JUN06-1/1

Ballasting Tractor

Add weight to front end if needed for stability. Heavy pulling and heavy rear-mounted implements tend to lift front wheels. Add enough ballast to maintain steering control and prevent tip-over.

Refer to the implement operator’s manual, along with “Using Implement Codes” in this section, to determine the minimum number of front weights that are required for your tractor model.

PY80265,05GO873 -19-10SEP05-1/1

Determining Maximum Rear Ballast

IMPORTANT: DO NOT overload tyres. If maximum weight shown in chart is not enough for safety, reduce load or install heavier ply tyres.

pulling heavy loads in the first three gears.

To extend drive train life, avoid excessive soil compaction and rolling resistance, avoid adding too much ballast. Ballast should never exceed the weight required to provide traction for continuous full power loads in 3rd gear. Remove ballast if tractor engine labors when

Chart shows carrying capacity per tyre.

MAXIMUM LOAD PER WHEEL		
Tyre Size Bias Ply tyres	Ply Rating	Capacity kg (lb)
14.9-28	12	1545 (3406)
13.6-28	12	1329 (2930)
12.4-28	12	1211 (2670)

PY80265.05GO874 -19-10SEP05-1/1

Determining Maximum Front Ballast

Use appropriate front ballast for a particular operating condition. Two-wheel drive tractors should only have enough ballast to maintain safe steering control. Remove ballast when it is no longer needed.

Chart shows carrying capacity per tyre.

IMPORTANT: DO NOT overload tyres. If maximum weight shown in chart is not enough for safety, reduce load or install tyres with a higher load rating.

MAXIMUM LOAD PER WHEEL		
2-WD		
Tyre Size	Ply Rating	Capacity kg (lb)
6.00-16	8	534 (1177)
6.50-20	8	725 (1599)

PY80265.05GO875 -19-17JAN07-1/1

Using Cast Iron Weights

Cast iron weights are available in a 48 kg (106 lb) size. Weights can be installed on the inside or outside of wheel. See your John Deere dealer for more information and recommendations on weight use and placement.

Specification

Cast Iron Weights—Weight..... 48 kg (106 lb)

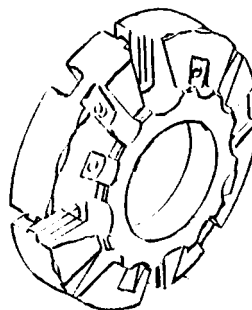

M47215 -UN-29JAN92

PY80265.05GO876 -19-10SEP05-1/1

Installing Rear Cast Iron Weights

CAUTION: Optional cast iron weight weighs 48 kg (106 lb). Handle with care! Use appropriate equipment or have the job done by your John Deere dealer.

1. Attach first weight to wheel disks.
2. To install additional weights (A), install bolts in previous weight (B). Rotate the added weight to align bolts with weight holes (C).
3. Tighten attaching bolts securely. Tighten again after a few hours service. Check tightness regularly.

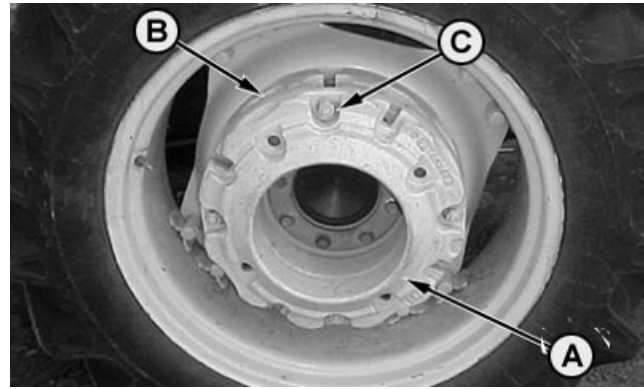

PY1635 -UN-17FEB06

A—Additional Weight
 B—Weight
 C—Weight Holes

PY80265,05GO877 -19-10SEP05-1/1

Using Liquid Weight

CAUTION: Installing liquid ballast requires special equipment and training. Have the job done by your John Deere dealer or a tyre service store.

IMPORTANT: NEVER fill tyre to more than 75% full. More solution would leave too little air space to absorb shocks. Damage to tyre could occur.

A solution of water and calcium chloride provides safe, economical ballast. Used properly, it will not damage tyres, tubes, or rims.

Use calcium chloride to prevent water from freezing. A mixture of 0.6 kg per liter (5.0 lb of calcium chloride per gal) will not freeze solid above -45°C (-53°F).

Charts on this page show how much each tyre size holds if filled to 75 percent full.

LIQUID WEIGHT FOR FRONT TYRES With 0.6 kg/L (5 lb/gal) Calcium Chloride Solution	
Tyre Size	Liquid Weight per tyre kg (lb)—75% Full
6.00-16	30 (67)

LIQUID WEIGHT FOR REAR TYRES With 0.6 kg/L (5 lb/gal) Calcium Chloride Solution	
Tyre Size	Liquid weight per Tyre kg (lb)—75% Full
12.4-28	216 (478)
13.6-28	237 (524)
14.9-28	339 (747)

PY80265,05GO878 -19-17JAN07-1/1

Wheels, Tyres and Treads

Service Tyres Safely

Explosive separation of a tyre and rim parts can cause serious injury or death.

Do not attempt to mount a tyre unless you have the proper equipment and experience to perform the job.

Always maintain the correct tyre pressure. Do not inflate the tyres above the recommended pressure. Never weld or heat a wheel and tyre assembly. The heat can cause an increase in air pressure resulting in a tyre explosion. Welding can structurally weaken or deform the wheel.

When inflating tyres, use a clip-on chuck and extension hose long enough to allow you to stand to one side and NOT in front of or over the tyre assembly. Use a safety cage if available.

Check wheels for low pressure, cuts, bubbles, damaged rims or missing lug bolts and nuts.

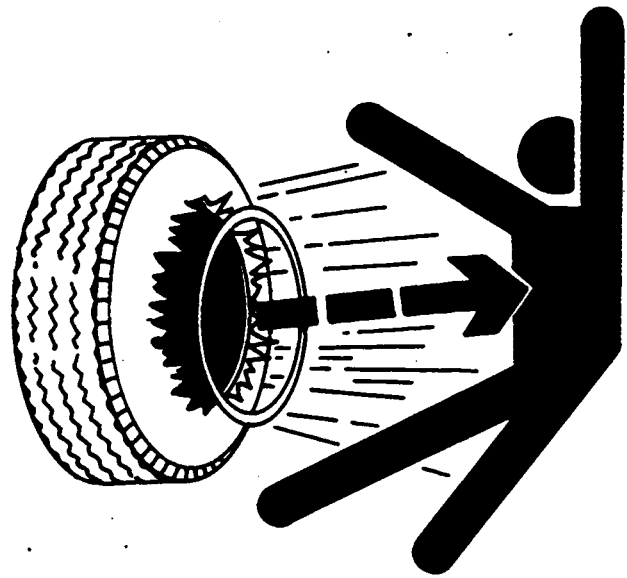

TS211 -UN-23AUG88

PY80265.05GO879 -19-10SEP05-1/1

Check Implement-to-Tyre Clearance

IMPORTANT: Check for adequate clearance (A) between outside diameter of the tyre and implement with hitch in raised position.

When large diameter rear tyres are installed on a tractor with a 3-Point Hitch, a quick coupler or similar device may be required to provide adequate implement-to-tyre clearance.

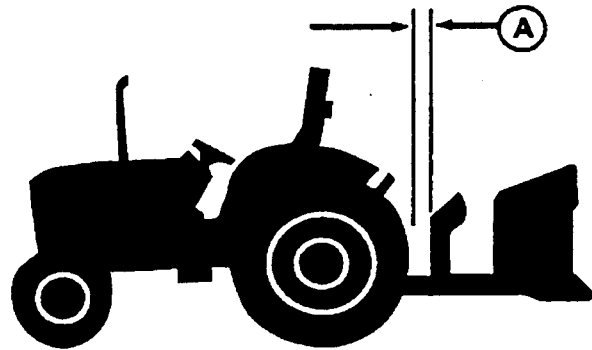

M47177 -UN-31JAN92

A—Clearance

PY80265.05GO880 -19-10SEP05-1/1

Check Tyre Inflation Pressure

Check tyres daily for damage or noticeably low pressure.

At least every 100 hours of operation, check inflation pressure with a gauge. Use an accurate gauge having 10 kPa (0.1 bar) (1 psi) graduations.

If tyres contain liquid ballast, use a special air-water gauge and measure with valve stem at bottom.

NOTE: When furrow plowing or during hillside operation, tyre pressure can be increased 28 kPa (0.28 bar) (4 psi) ABOVE maximum to prevent tyre wrinkling or buckling.

IMPORTANT: Always check inflation pressure with an accurate tyre gauge to prevent over-inflation. Over-inflation reduces performance and increases strain of both tyre and rim.

NOTE: Following inflation information applies to both front and rear tyres and Tyre Inflation Pressure Chart.

1. All inflation pressures are calculated for 29 km/h (18 mph) travel speeds for both diagonal (bias) ply and radial ply tyres.
2. Operation of tyres at the inflation pressures listed on chart will result in optimum tractive performance of the tyre/vehicle system. Correctly inflated radial tyres will show a large deflection of the sidewall or "cheeks". This is normal and will not hurt the tyre if the inflation pressure is maintained.
3. Inflation pressures less than 80 kPa (12 psi) should be monitored regularly because of the increased risk of low pressure air leaks (especially due to leaking valve cores).
4. Tractors operating on steep side slopes should increase inflation pressures 28 kPa (4 psi) above the values listed to compensate for lateral weight transfer.
5. Tyres run as singles in high traction conditions sometimes experience bead slip if the bead was not fully seated or if too much lubricant was used to mount the tyre. Increasing the inflation pressure will compensate for this condition but will not cause reduced traction. Consult your tyre dealer if this problem occurs.
6. If higher load capacities are needed, contact your John Deere dealer for tyre manufacturers load and inflation table information.

Tyre Inflation Pressure Chart

Front Tyres			With Little or No Added Weight			With Maximum Ballast or Heavy Mounted Implement		
Tyre Size	Ply Rating	Tread	kPa	(bar)	(psi)	kPa	(bar)	(psi)
6.00-16	8	F2	160	(1.6)	(23)	280	(2.8)	(40)
Rear Tyres			With Little or No Added Weight			With Maximum Ballast or Heavy Mounted Implement		
Tyre Size	Ply Rating	Tread	kPa	(bar)	(psi)	kPa	(bar)	(psi)
12.4-28	12	R1	80	(0.8)	(12)	140	(1.4)	(20)
13.6-28	12	R1, R3, R4	90	(0.9)	(13)	120	(1.2)	(18)
14.9-28	12	R1	80	(0.8)	(12)	140	(1.4)	(20)

PY80265.05GO882 -19-17JAN07-1/1

Tighten Wheel/Axle Hardware Correctly

CAUTION: NEVER operate tractor with a loose rim, wheel, hub, or axle.

Any time hardware is loosened, tighten to specified torque.

NOTE: Follow checking procedure when a new tractor is first used, or wheels have been off.

1. After driving tractor about 100 m (109 yd), and before placing it under load, tighten hardware to specified torque.
2. Check hardware after working three hours and again after 10 hours.
3. Check all hardware frequently and keep it tight.

PY80265.05GO883 -19-10SEP05-1/1

Tighten Bolts— Front Axle

Tighten bolts in the following locations to specifications:

	Specification
Front Axle—Axle-to-Knee Bolts—Torque	480 N•m (350 lb-ft)
Front Axle—Disk-to-Flange Bolts—Torque.....	210 N•m (130 lb-ft)

B—Disk-to-Flange



PY4526 -UN-21JAN05

PY80265.05GO884 -19-10SEP05-1/1

Tighten Bolt Adjustable Front Axle—If Equipped

Tighten bolts in the following locations to specifications:

	Specification
Adjustable Front Axle-to-Knee	
Bolts—Torque	480 N•m
Adjustable Front Axle	
Disk-to-Flange Bolts—Torque	210 N•m

- A—Axle-to-Knee
- B—Disk-to-Flange

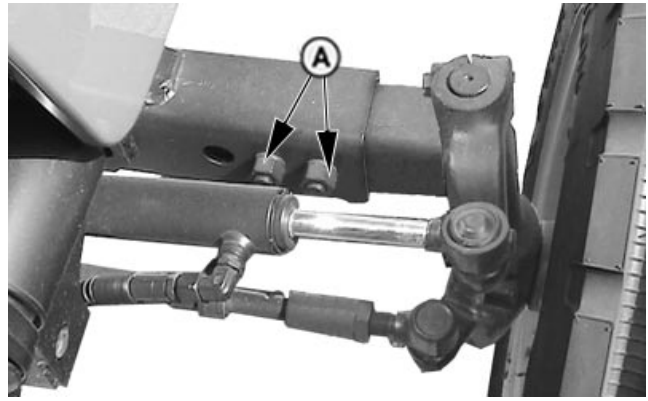

PY5021 -UN-21MAY05

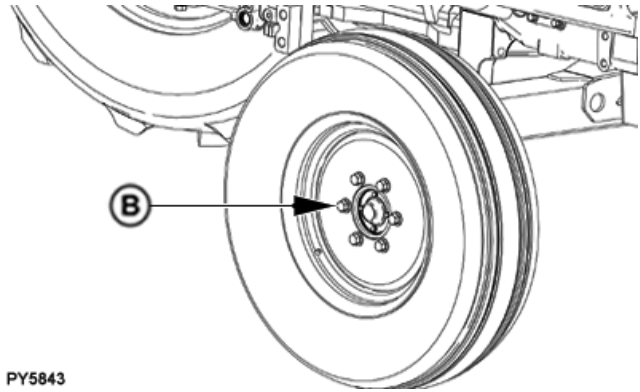

PY5844 -UN-21JUN06

PY5843

NR25796.0000683 -19-15JAN07-1/1

Tighten Bolts—Rear Axle (M-14 Bolts)

Tighten bolts in the following locations to specifications:

	Specification
Rear Axle Rim-to-Disk (Steel	
Disk)—Torque.....	245 N•m (180 lb-ft)
Rear Axle Disk-to-Flange (Steel	
Disk)—Torque.....	210 N•m (155 lb-ft)

- A—Rim-to-Disk Bolts**
- B—Disk-to-Flange Bolts**
- C—M-14 Bolt**

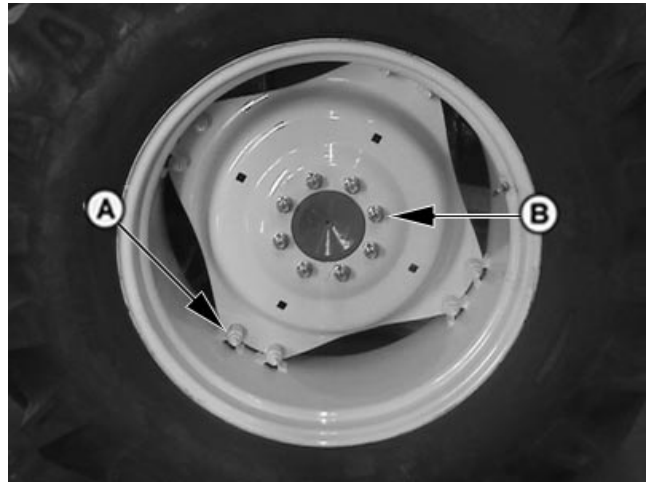

PY4282 -UN-06DEC04

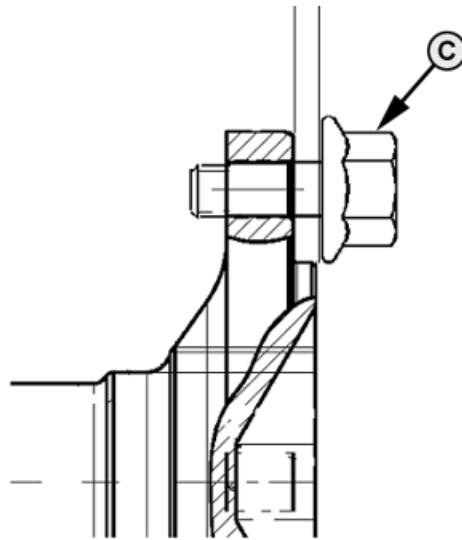

Current Arrangement with M-14 Bolt

PY1955 -UN-12JAN04

PY80265,05GO885 -19-10SEP05-1/1

Tighten Bolts—Rear Axle (M-20 Stud)

Tighten bolts in the following locations to specifications:

	Specification
Rear Axle Rim-to-Disk (Steel Disk)—Torque.....	245 N•m (180 lb-ft)
Rear Axle Disk-to-Flange (Steel Disk)—Torque.....	550 N•m (406 lb-ft)

- A—Rim-to-Disk Bolts
- B—Disk-to-Flange Bolts
- C—Stud
- D—Nut

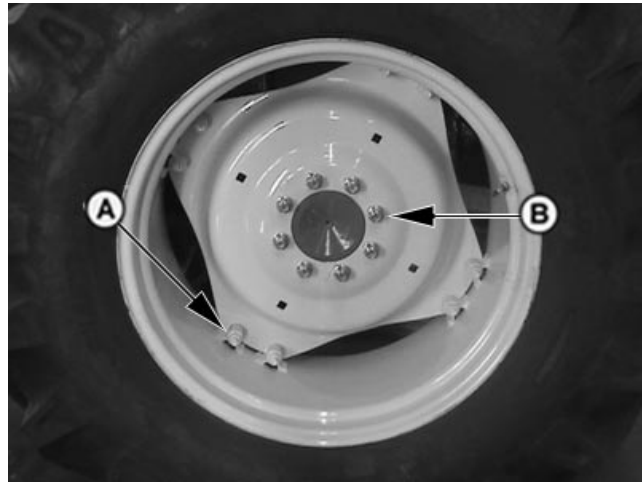

PY4282 -UN-06DEC04

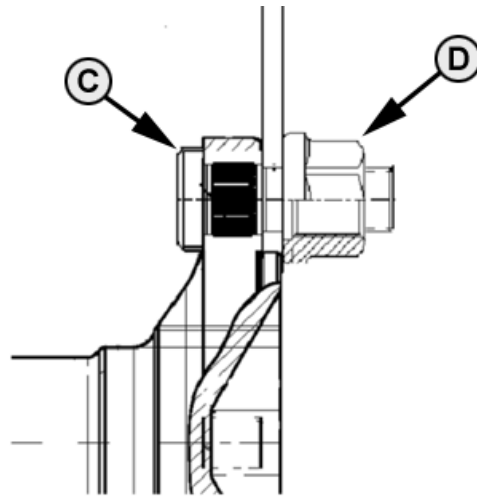

New Arrangement with M-20 Stud and Nut

PY1956 -UN-12/JAN04

PY80265.05GO886 -19-10SEP05-1/1

Observe Rear Wheel Tread Width Limitations

IMPORTANT: Tyres must have at least 25 mm (1 in.) clearance with fenders (A) and fuel tank. When large diameter rear tyres are installed, check clearance between tyre and fenders and fuel tank.

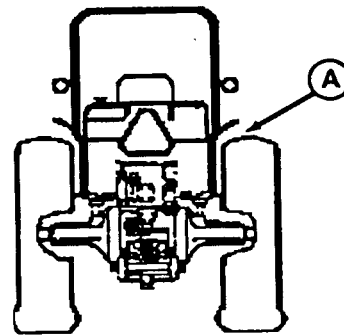

M47179 -UN-31/JAN82

PY80265.05GO887 -19-10SEP05-1/1

Tread Settings—Multi-Position Rear Wheels

Wheel tread on rear axle with multi-position wheels can be adjusted by repositioning or exchanging the rims or by reversing the wheel disks.

Wheel tread can also be adjusted by exchanging the complete wheel to the opposite side of the tractor (This maneuver permits the change from disk-dished-in to disk-dished-out operations without disassembling the wheel). When changing rear wheels from one side to the other, the arrow on side wall of tyre points in the direction of forward rotation.

The relationship of the wheel disk and rim in obtaining the different tread settings is shown in the diagrams on the facing page.

A study of these diagrams, before attempting to change tread settings, will save unnecessary labor.

IMPORTANT: After setting wheel spacing, tighten rim-to-disk and disk-to-flange bolts. Drive tractor 100 m (109 yd) and tighten again.

Specification

Multi-Position Rear Wheels Rim-to-Disk (Steel Disk)— Torque.....	245 N•m (180 lb-ft)
Multi-Position Rear Wheels Disk-to-Flange (Steel Disk)— Torque.....	175 N•m (130 lb-ft)

NOTE: Tread settings are measured at bottom of centerline.

STEEL DISKS REAR TREAD WIDTH Centerline-to-Centerline	
Diagram	Tyre Sizes
	13.6-28 12.4-28
A	1417 mm (55.8 in.)
B	1513 mm (59.6 in.)
C	1617 mm (63.7 in.)
D	1716 mm (67.6 in.)
E	1820 mm (71.7 in.)

PY80265.05GO888 -19-10SEP05-1/2

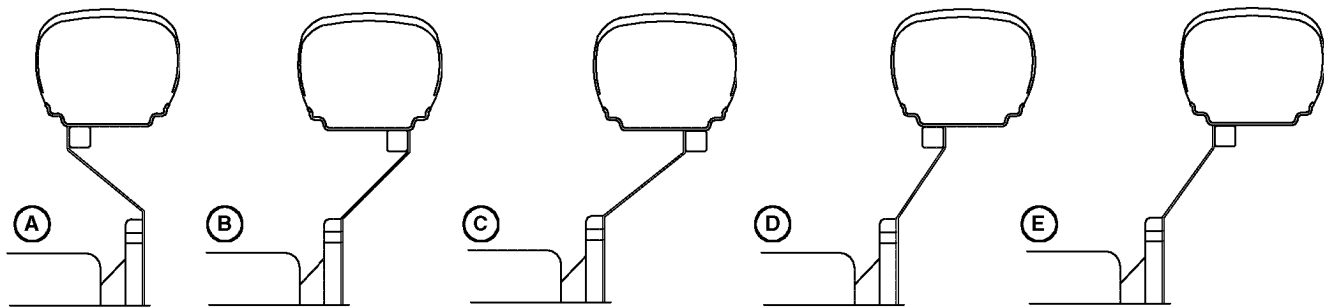

IN 227 -UN-24MAY00

PY80265.05GO888 -19-10SEP05-2/2

Tread Settings—Adjustable Front Axle—If Equipped

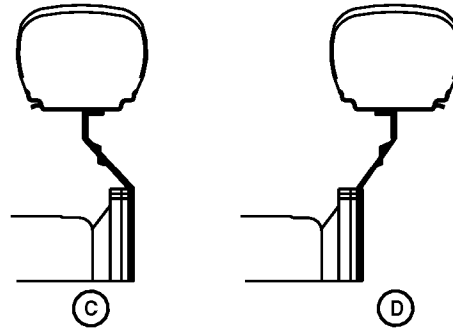
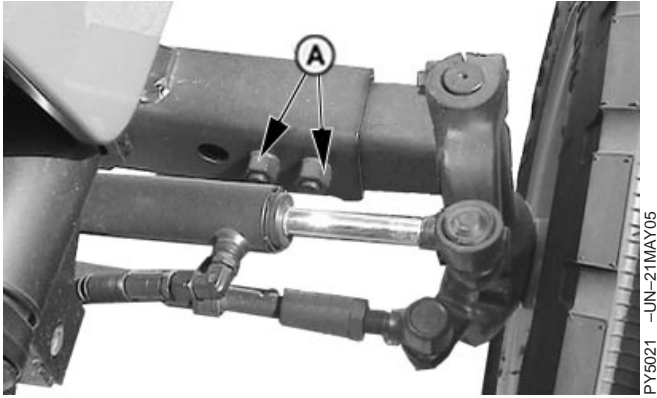

Front rims are offset. With some tires, this provides two tread spacings, at each axle setting.

ADJUSTABLE FRONT AXLE TREAD SETTINGS						
Diagram C						
Centerline-to-centerline						
Tread Position ^a For 2 WD						
Tire	1	2	3	4	5	6
7.5-16	1449 mm (57.0 in.)	1549 (61.0 in.)	1649 (64.9 in.)	1749 (68.9 in)	1849 (72.8 in.)	1949 (76.7 in.)
6.0-16	1435 mm (56.5 in.)	1535 mm (60.4 in.)	1635 mm (64.4 in.)	1735 mm (68.3 in.)	1835 mm (72.2 in.)	1935 mm (76.2 in.)

^aTread position 1 is with axle adjustment at its most inward location. See adjust Front Axle Tread Width in this section.

ADJUSTABLE FRONT AXLE TREAD SETTINGS						
Diagram D						
Centerline-to-centerline						
Tread Position ^a						
Tire	1	2	3	4	5	6
7.5-16	1583 (62.3 in.)	1683 mm (66.3 in.)	1783 mm (70.2 in.)	1883 mm (74.1 in.)	1983 mm (78.1 in.)	2083 mm (82.0 in.)

^aTread position 1 is with axle adjustment at its most inward location. See adjust Front Axle Tread Width in this section.

NR25796,0000684 -19-15JAN07-1/1

Checking Toe-In



PY5170 -UN-25AUG05

A—Front Axle Toe-In Distance

1. Park machine on level surface.
2. Turn steering wheel so front wheels are in the straight-ahead position. Stop engine.
3. Measure distance (A) between tyres at hub level in front of axle. Record measurement and mark the tyres.
4. Move tractor back about 1 m (3 ft), so mark is at hub level behind the axle. Again, measure distance between tyres at same point on tyre. Record measurement.
5. Determine the difference between front and rear measurements. If the front measurement is smaller, toe is “in”. If the rear is smaller, toe is “out”.
6. Distance (A) at front of tyres should be 3—6 mm less than distance measured at rear of tyres for CARRARO front axle and 0—2 mm for DANA front axle. Adjust toe-in if necessary. (See procedure in this section.)

Toe-In Value Chart	
Make	Toe-In Value
DANA FRONT AXLE	0-2 mm
CARRARO FRONT AXLE	3-6 mm

Adjusting Toe-In

1. Loosen lock nut (A) on tie rod.
2. Adjust tie rod equally by rotating tube (B) to lengthen or shorten tie rod. Adjust toe-in to 3 to 6 mm for CARRARO front axle and 0—2 mm for DANA front axle.
3. Tighten bolt to specification. Do not overtighten as damage to the tube may occur.

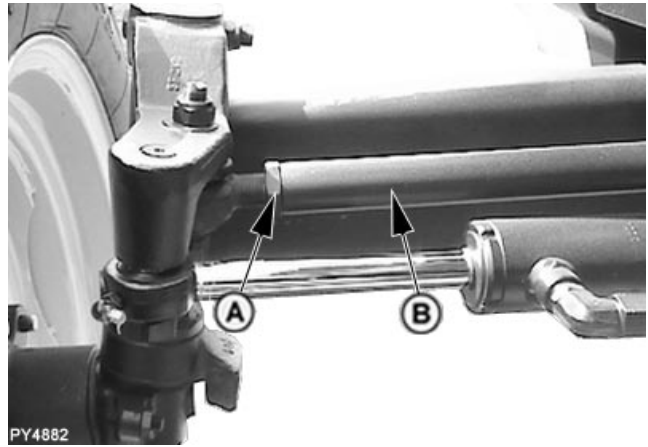

Powered Axle

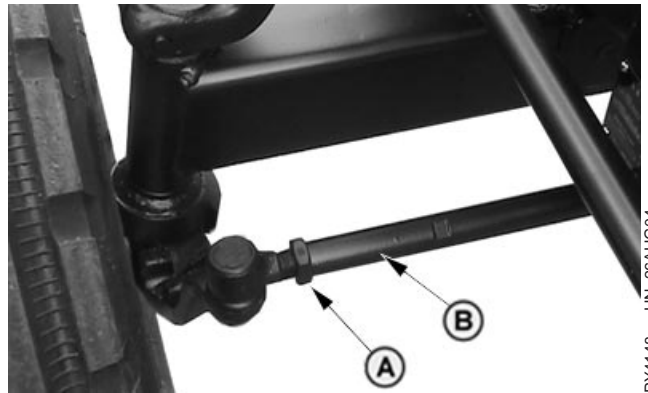

Non-Powered Axle

Specification

Tie Rod Jam Nut—Torque 90 N•m (66 lb-ft)

Toe-In Value Chart	
Make	Toe-In Value
DANA FRONT AXLE	0-2 mm
CARRARO FRONT AXLE	3-6 mm

A—Tie Rod Lock Nut
B—Tie Rod Tube

PY80265,05GO890 -19-04JUL06-1/1

Adjusting Toe-In - Adjustable Front Axle—IF Equipped

1. Loosen locker nuts (A) on locker (B).
2. Loose ball joint lock nut (E).
3. Adjust tie rods on both sides of the tractor equally by the extensioner to lengthen or shorten. Adjust toe-in to 3 to 6 mm (1/8 to 1/4 in.)
4. Tighten nut on locker (A) to specification.

Specification

Locker Nut—Torque 40 N•m

5. Tighten the ball joint lock nuts (E) to specification.

Specification

Extensioner Lock Nut—Torque 160 N•m

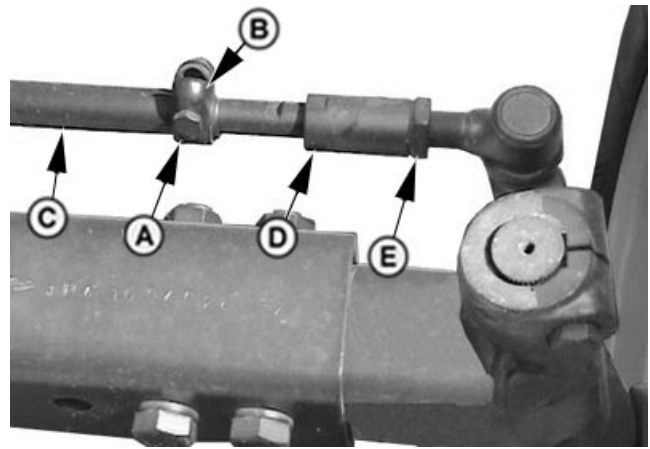

PY5025 -UN-25MAY05

- A—Locker Nut
- B—Locker
- C—Tie Rod
- D—Extensioner
- E—Lock Nut

NR25796.0000686 -19-15JAN07-1/1

Transporting

Use Safety Lights and Devices

Prevent collisions between other road users, slow moving tractors with attachments or towed equipment, and self-propelled machines on public roads. Frequently check for traffic from the rear, especially in turns, and use hand signals or turn signal lights.

Use headlights, flashing warning lights, and turn signals day and night. Follow local regulations for equipment lighting and marking. Keep lighting and marking visible and in good working order. Replace or repair lighting and marking that has been damaged or lost.

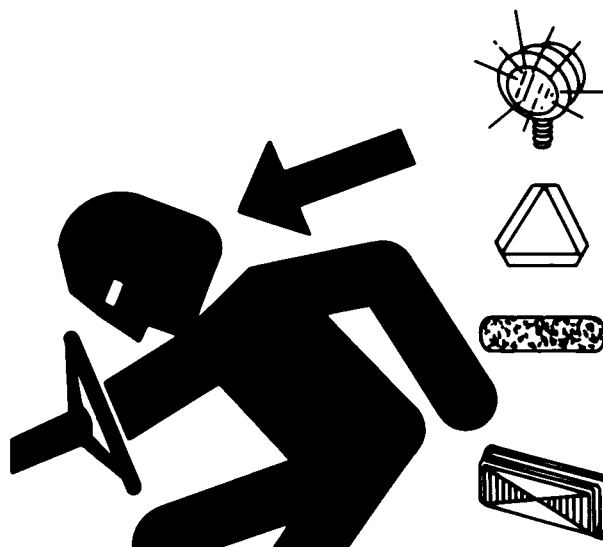

T5951 -UN-12APR90

PY80265.05GO891 -19-10SEP05-1/1

Driving Tractor on Roads

CAUTION: Observe the following precautions when operating on a road.

1. Before operating tractor on highway be sure tail lights (A) and flashing turning lights (B) work properly. Install and use auxiliary lighting to equipment as required for safety and by local regulations.

A—Tail light
B—Turning Lights
C—Reflex Reflector

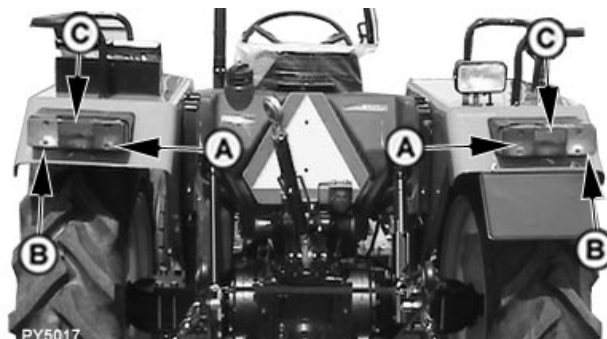

For 5103E Tractor

PY5017 -UN-12JUN06

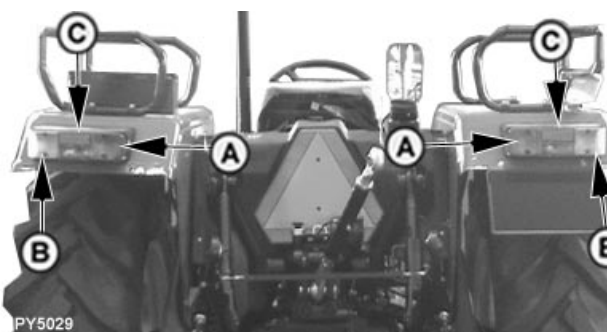

For 5103, 5103S, 5203, 5104 and 5204 Tractor

PY5029 -UN-12JUN06

Continued on next page

NR25796.0000353 -19-11JAN07-1/5

CAUTION: NEVER operate flood lamp when transporting tractor. Clear bright light at the rear of the tractor could confuse drivers of other vehicles as they approach from the rear.

IMPORTANT: Refer to Lights section for detailed descriptions of lighting operations and functions.

2. Turn light switch to high beam headlights or low beam headlights position. Never use bright lights which are visible from the rear. Always dim headlights before meeting another vehicle. Keep headlights properly adjusted.

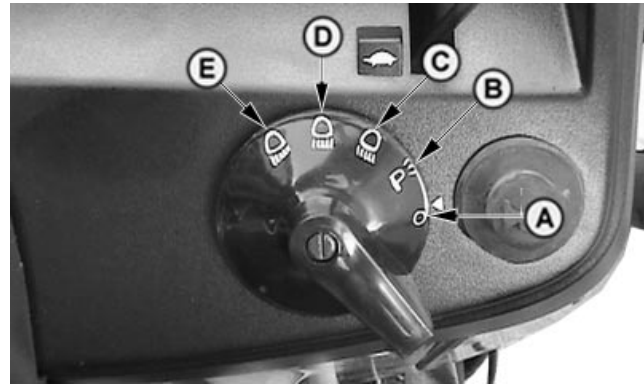

A—Lights OFF
 B—Parking Lights
 C—Dim Headlights
 D—Bright Headlights
 E—High Beamlight

PY4106 -UN-23FEB06

NR25796,0000353 -19-11JAN07-2/5

3. Use turn signals when turning. Be sure to return turn signal lever (A) to center position after turning.

A—Turn Signal Lever



PY4114 -UN-23FEB06

NR25796,0000353 -19-11JAN07-3/5

4. Couple brake pedals (A) together before driving on a road. Avoid hard applications of brakes.

5. Drive slowly enough to maintain safe control at all times. Slow down for hillsides, rough ground, and sharp turns, especially when transporting heavy, rear-mounted equipment.

6. Before going down a hill, shift to a gear low enough to control speed without using brakes. Never coast down hill.

7. When transporting downhill on icy or graveled grades, be alert for skids which could result in loss of steering control. To decrease chance of skids, reduce speed and be sure tractor has proper ballast.

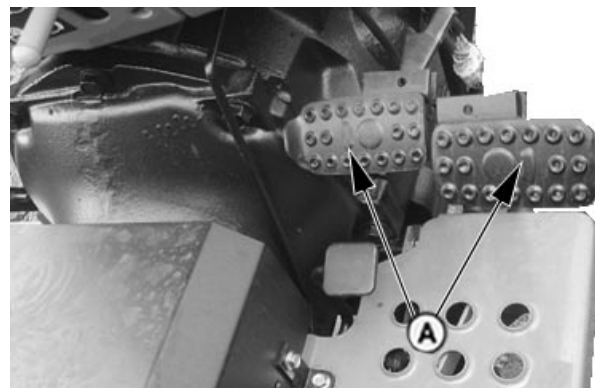

Brake Pedals

A—Brake Pedals

PY6098 -UN-06AUG06

Continued on next page

NR25796,0000353 -19-11JAN07-4/5

CAUTION: Stopping distance increases with speed and weight of towed loads, and on slopes. Towed loads with or without brakes that are too heavy for the tractor or are towed too fast can cause loss of control. Consider the total weight of the equipment and its load.

Observe these recommended maximum road speeds, or local speed limits which may be lower:

If towed equipment does not have brakes, do not travel more than 32 km/h (20 mph) and do not tow loads more than 1.5 times the tractor weight.

If towed equipment has brakes, do not travel more than 40 km/h (25 mph) and do not tow loads more than 4.5 times the tractor weight.

Ensure the load does not exceed the recommended weight ratio. Add ballast to recommended maximum for tractor, lighten the load, or get a heavier towing unit. The tractor must be heavy and powerful enough with adequate braking power for the towed load. Use additional caution when towing loads under adverse surface conditions, when turning, and on inclines.

8. Use caution when operating tractor at transport speeds. Reduce speed if towed load weighs more than tractor and is not equipped with brakes. (See Towed Equipment operator's manual for recommended transport speeds.)
9. Use additional caution when transporting towed loads under adverse surface conditions, when turning and on inclines.
10. Heavy towed or rear mounted implements may start swaying in transport. Excessive swaying will result in loss of steering control. Drive slowly and avoid quick turns of steering wheel. Refer to your implement operator's manual regarding maximum travel speed limitations.

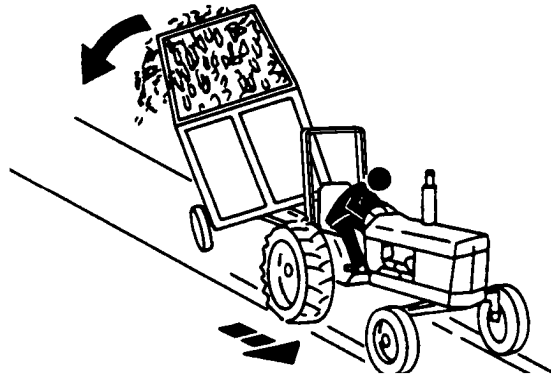

LV4042 -UN-03JUL99

Transport on Carrier

CAUTION: Chain tractor to carrier securely. Drive carrier slowly.

The best method of transporting a disabled tractor is to haul it on a flatbed carrier.

IMPORTANT: Seal exhaust to prevent dirt from entering and damaging engine.

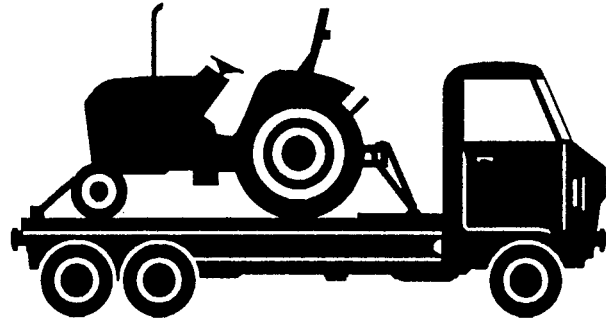

LV610 -UN-22APR94

PY80265.05GO893 -19-10SEP05-1/1

Towing Tractor

CAUTION: NEVER tow tractor faster than 16 km/h (10 mph). Have an operator steer and brake tractor.

IMPORTANT: To avoid damaging transmission-hydraulic system, observe the following precautions:

1. Be sure transmission-hydraulic system oil is to the full level line on sight gauge (A). If the tractor is to be towed with the front wheels raised, add 1 liter of oil to hydraulic fill port (C) for each 90 mm (3-1/2 in.) the wheels are raised. DO NOT raise front wheels more than 305 mm (12 in.) above ground.

NOTE: After transporting tractor, drain oil that was added for towing.

2. Make sure the differential lock is disengaged.
3. Make sure range lever is in neutral and gear lever is in 4th gear.

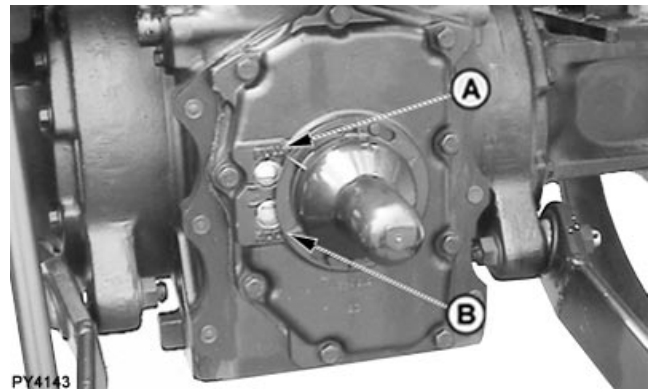

For 5103E Tractor

PY4143 -UN-12JUN06

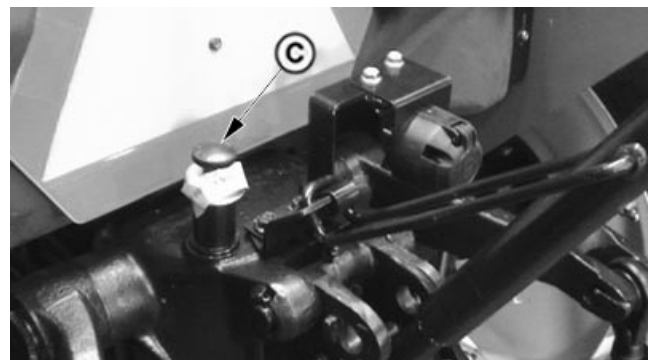

For 5103, 5103S, 5203, 5104 and 5204 Tractor

PY4142 -UN-12DEC05

A—Full Level Mark
B—Low Level Mark
C—Hydraulic Oil Filler Port

NR25796.0000354 -19-12JAN07-1/1

Fuels, Lubricants and Coolant

Handle Fuel Safely—Avoid Fires

Use only diesel fuel.

Handle fuel with care, it is highly flammable.

DO NOT refuel machine:

- While you smoke.
- When machine is near open flame or sparks.
- When engine is running. STOP engine.

Fill fuel tank outdoors.

Help prevent fires:

- Clean oil, grease and dirt from machine.
- Clean up spilled fuel immediately.

Do not store machine with fuel in tank in a building where fumes may reach an open flame or spark.

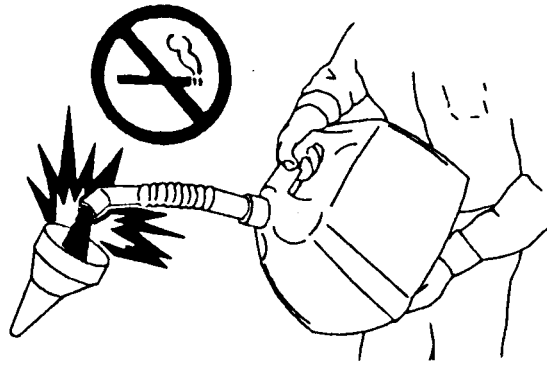

MT73115 -UN-09MAR90

PY80265.05GO895 -19-10SEP05-1/1

Handle Fluids Safely—Avoid Fires

When you work around fuel, do not smoke or work near heaters or other fire hazards.

Store flammable fluids away from fire hazards. Do not incinerate or puncture pressurized containers.

Make sure machine is clean of trash, grease, and debris.

Do not store oily rags; they can ignite and burn spontaneously.



TS227 -UN-23AUG88

PY80265.05GO896 -19-10SEP05-1/1

Fuel Storage

Buy good quality, clean fuel from a reputable supplier.

Avoid storing fuel over long periods of time.

Proper fuel storage is critically important. Use clean storage and transfer tanks. Periodically drain water and sediment from bottom.

Store fuel in a convenient place away from buildings.

PY80265.05GO897 -19-10SEP05-1/1

Diesel Fuel

Fuel sulphur content should be less than 1.0 percent preferably less than 0.5 percent. Diesel fuel having sulphur content higher than 1.0 percent may cause increase wear on metal engine parts because of acids produced by sulphur during combustion.

Cetane number should be no less than 40 to assure satisfactory starting and overall performance.

Fitleration of fuel is critical for proper operation of engine. Use genuine MICO fuel filters. Always change fuel filter insert at given interval

IMPORTANT: If fuel sulphur content exceeds 0.7 percent, the engine oil drain interval must be reduced by 50 percent to 125 hours.

PY80265.05GO898 -19-10SEP05-1/1

Diesel Fuel Filters

Fitleration of fuel is critical for proper operation of engine. Use genuine MICO fuel filters. Always change fuel filter inserts (primary and seconary)at given interval

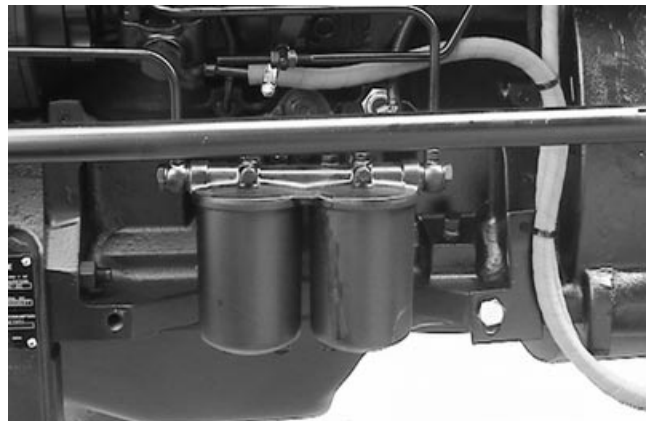

PY80265.05GO899 -19-10SEP05-1/1

Fill Fuel Tank

CAUTION: Handle fuel with care: It is highly flammable. **DO NOT** refuel the machine while smoking or when near open flame or sparks.

Always stop engine before refueling machine.
Fill fuel tank outdoors.

Prevent fires by keeping machine clean of accumulated trash, grease and debris. Always clean up spilled fuel.

Fuel tank can be filled through either fill cap (A). Fill fuel tank at end of each days operation. This prevents condensation in tank as moist air cools.

Specification

Fuel Tank (5103, 5103S, 5203, 5104 and 5204 Tractor)—	
Capacity.....	62 lit
Fuel Tank (5103E Tractor)—	
Capacity.....	50 lit

A—Fuel Tank Filler Cap



TSS202 -JUN-23AUG88



PY6027 -JUN-27MAY05

For 5103, 5103S, 5203, 5104 and 5204 Tractor



PY4101 -JUN-20AUG04

For 5103E Tractor

PY80265,05GO901 -19-29DEC06-1/1

Lubricant Storage

Your equipment can operate at top efficiency only when clean lubricants are used.

Use clean containers to handle all lubricants.

Whenever possible, store lubricants and containers in an area protected from dust, moisture, and other contamination. Store containers on their side to avoid water and dirt accumulation.

Make certain that all containers are properly marked to identify their contents.

Properly dispose of all old containers and any residual lubricant they may contain.

PY80265,05GO902 -19-10SEP05-1/1

Diesel Engine Oil

Use genuine engine oil. This oil is available in pack of 1litre and 8.5 litre at John Deere Dealership only



PY80265,05G1309 -19-20JUN06-1/1

Diesel Engine Coolant

The engine cooling system is filled to provide year-round protection against corrosion and cylinder liner pitting, and winter freeze protection to -37°C (-34°F). If protection at lower temperatures is required, consult your John Deere dealer for recommendations.

John Deere COOL-GARD™ Prediluted Coolant is preferred for service.

John Deere COOL-GARD Prediluted Coolant is available in a concentration of either 50% ethylene glycol or 55% propylene glycol.

Additional recommended coolants

The following engine coolant is also recommended:

- John Deere COOL-GARD Coolant Concentrate in a 40% to 60% mixture of concentrate with quality water.

John Deere COOL-GARD coolants do not require use of supplemental coolant additives, except for periodic replenishment of additives during the drain interval.

Other fully formulated coolants

Other fully formulated low silicate ethylene or propylene glycol base coolants for heavy-duty engines may be used if they meet one of the following specifications:

- ASTM D6210 prediluted (50%) coolant
- ASTM D6210 coolant concentrate in a 40% to 60% mixture of concentrate with quality water

Coolants meeting ASTM D6210 do not require use of supplemental coolant additives, except for periodic replenishment of additives during the drain interval.

Coolants requiring supplemental coolant additives

Other low silicate ethylene glycol base coolants for heavy-duty engines may also be used if they meet one of the following specifications:

- ASTM D4985 ethylene glycol base prediluted (50%) coolant
- ASTM D4985 ethylene glycol base coolant concentrate in a 40% to 60% mixture of concentrate with quality water

Coolants meeting ASTM D4985 require an initial charge of supplemental coolant additives, formulated for protection of heavy duty diesel engines against corrosion and cylinder liner erosion and pitting. They also require periodic replenishment of additives during the drain interval.

Other coolants

It is possible that neither John Deere COOL-GARD nor coolants meeting one of the coolant standards listed above is available in the geographical area where service is performed. If these coolants are unavailable, use a coolant concentrate or prediluted coolant with a quality additive package that provides cylinder liner cavitation protection and protects the cooling system metals (cast iron, aluminum alloys, and copper alloys such as brass) from corrosion.

The additive package must be part of one of the following coolant mixtures:

- ethylene glycol or propylene glycol base prediluted (40% to 60%) coolant
- ethylene glycol or propylene glycol base coolant concentrate in a 40% to 60% mixture of concentrate with quality water

Water quality

Water quality is important to the performance of the cooling system. Distilled, deionized, or demineralized water is recommended for mixing with ethylene glycol and propylene glycol base engine coolant concentrate.

IMPORTANT: Do not mix ethylene glycol and propylene glycol base coolants.

IMPORTANT: Do not use cooling system sealing additives or antifreeze that contains sealing additives.

DX,COOL3 -19-27OCT05-2/2

Use Correct Transmission-Hydraulic Filter Element

To protect systems, replace transmission-hydraulic oil filter with a John Deere service filter element. Minimum and maximum performance specifications are printed on John Deere filters. Other filters may be used if they meet these performance specifications.

See Lubrication and Maintenance section for recommended filter change intervals.

PY80265.05GO905 -19-10SEP05-1/1

Transmission and Hydraulic Oil

Same oil is used for transmission and hydraulic. Use HY-GARD® transmission-hydraulic oil. This oil is available in pack of 1 litre and 20 litre at John Deere Dealership only



PY5827 -UN-20JUN06

HY-GARD is a trademark of Deere & Company

PY80265.05GO906 -19-20JUN06-1/1

Grease

Depending upon the expected air temperature range during the service interval, use grease as shown on the adjoining table.

John Deere High-Temperature/Extreme-Pressure/Non-Clay Grease is recommended.

If other greases are used, they must be greases meeting SAE Multipurpose High Temperature Grease with Extreme Pressure (EP) Performance and capable of operating at compartment temperatures above 150°C (302°F)

At temperatures below —30°C (—22°F), use arctic greases such as those meeting Military Specification MIL-G-10942C.

Grease Type	Temperature Limits
Arctic Grease	Below —10°C (14°F)
SAE (NLGI) #0 or #1	0°C to —30°C (32°F to —22°F)
SAE (NLGI) #2	50°C to 0°C (122°F to 32°F)
JD High Temperature	50°C to —10°C (122°F to 14°F)

PY80265,05GO907 —19—10SEP05—1/1

Service and Maintenance

Observe Service Intervals

Using hour meter (A) as a guide, perform all services at the hourly intervals indicated on the following pages. Keep a service record on charts provided in the Lubrication and Maintenance Record Charts section.

IMPORTANT: Recommended service intervals are for average conditions. Service **MORE OFTEN** if tractor is operated under adverse conditions.

A—Hour Meter

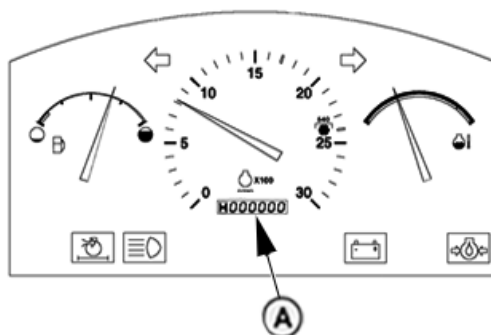

PY5737

For 5103, 5103S, 5203, 5104 and 5204 Tractor

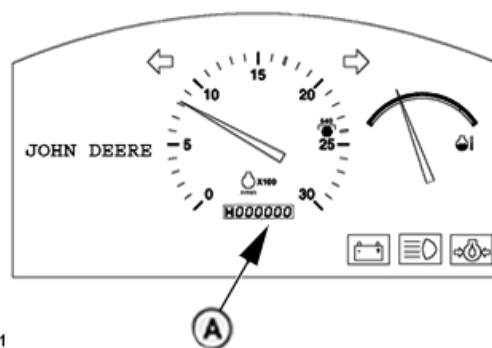

PY5761

For 5103E Tractor

PY80265.05GO908 -19-29DEC06-1/1

PY5737 -UN-31MAY06

PY5761 -UN-01JUN06

Break-In Service

IMPORTANT: Keep wheel hardware tight to avoid tractor damage. Check wheel hardware torque before operating, twice during first ten hours of operation, after fifty hours of operation, and periodically thereafter.

During the First 10 Hours of Operation:

Perform daily or 10 hours service. (See Service Intervals in Lubrication and Maintenance section.)

Tighten wheel hardware. (See Wheels, Tyres, and Treads section.)

After the First 50 Hours of Operation:

Tighten wheel hardware. (See Wheels, Tyres, and Treads section.)

Check alternator/fan belt tension and tighten air intake and cooling system hose clamps

Perform 50 Hours Service

After the First 100 Hours of Operation:

Replace transmission-hydraulic filter element

Change engine oil and filter¹

After the First 1100 Hours of Operation

Change transmission-hydraulic oil and filter

¹See Engine Break-In Oil in Service section for additional information.

NR25796.0000236 -19-21JUN06-1/1

Service Intervals

FILTER OVERVIEW WITH SERVICE INTERVALS

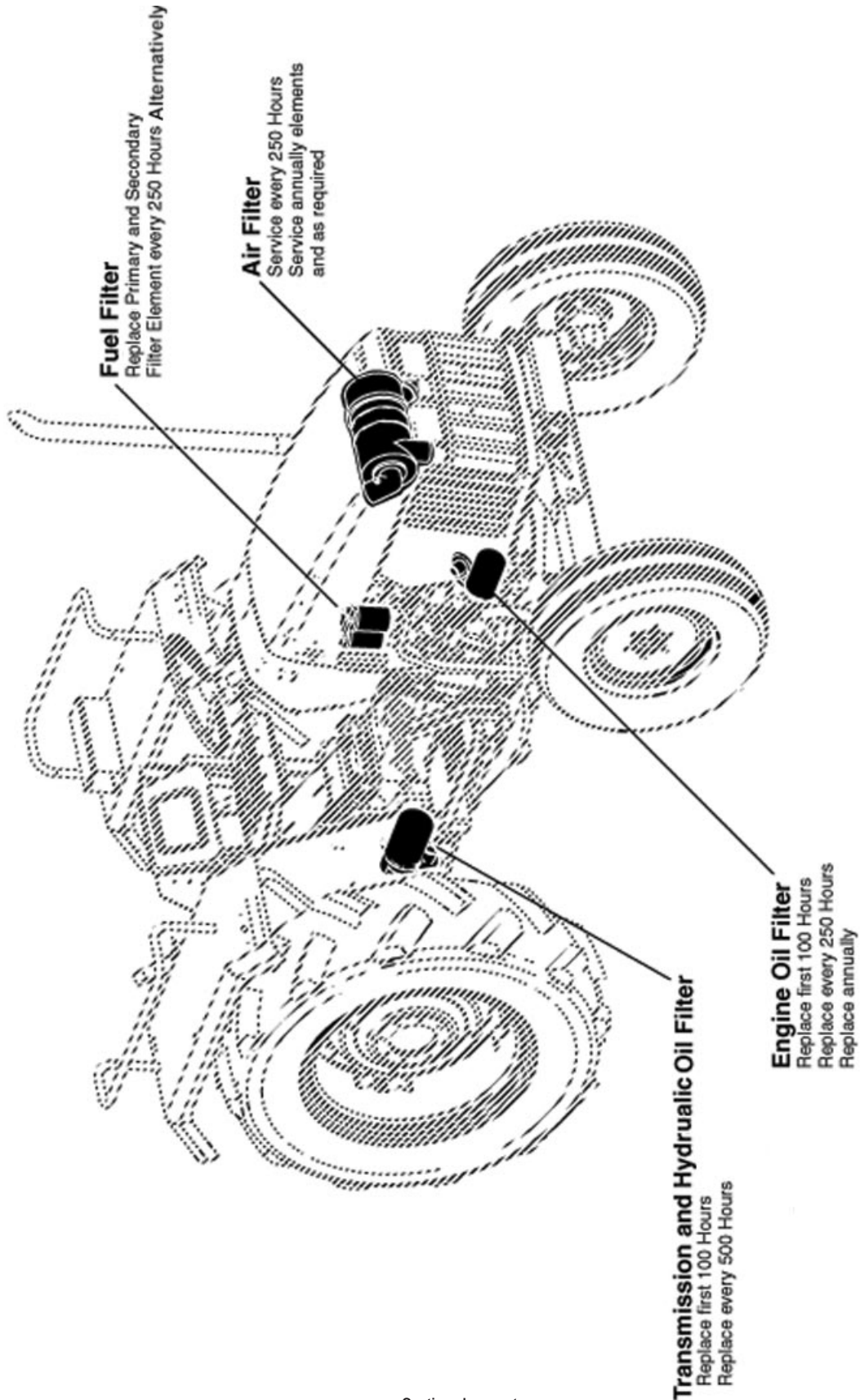

PY5833

Continued on next page

PY5833 -UN-26FEB07

26FEB07-1/3

Every 10 Hours

- Check engine oil level
- Check coolant level
- Drain water and sediment from fuel filter
- Lubricate tie rod ends¹
- Lubricate steering spindles¹
- Lubricate front axle pivot pin(s)¹
- Lubricate rear axle bearings¹
- Lubricate clutch pedal and right hand brake pedal.¹
- Lubricate clutch / brake shaft.¹

IMPORTANT: External lubrication is not required for oil type rear axle

Every 50 Hours

- Check transmission-hydraulic system oil level
- Clean and check battery
- Inspect all tires
- Lubricate front axle pivot pin(s)
- Lubricate steering spindles
- Inspect tractor for loose nuts and bolts
- Lubricate clutch pedal and right hand brake pedal.
- Lubricate clutch / brake shaft.

First 100 Hours

- Change engine oil and filter
- Replace transmission-hydraulic filter

Every 250 Hours

- Service air cleaner
- Change engine oil and filter
- Clean and check battery
- Inspect and adjust alternator/fan belt
- Lubricate 3-point hitch
- Check neutral start system
- Check clutch pedal free travel

- Check brake pedal adjustment
- Replace filter inserts (primary and secondary alternatively)

IMPORTANT: Never replace primary and secondary inserts simultaneously

Every 500 Hours

- Replace transmission-hydraulic filter

Every 600 Hours

- Clean engine crankcase vent tube
- Repack front wheel bearings
- Check and tighten all hoses and hose clamps
- Check cooling system for leaks
- Lubricate rear axle bearings
- Check engine idle speeds
- Have your John Deere dealer:
 - Check front axle pivot pin
 - Adjust engine valve clearance
- Inspect fuel injectors

IMPORTANT: External lubrication is not required for oil type rear axle

First 1100 Hours

- Change transmission-hydraulic oil and filter

Every 1250 Hours

- Change transmission-hydraulic oil and filter
- Clean transmission-hydraulic pickup screen

Annually

- Change engine oil and filter
- Replace air cleaner elements

¹Only necessary when operating in extremely wet and muddy conditions.

Every 2 Years or 2000 Hours (Whichever Comes First)

- Flush cooling system

- Service air cleaner
- Adjust throttle friction
- Drain water and sediment from fuel tank and fuel filter

Service As Required

NR25796,00002C5 -19-26FEB07-3/3

Service—Every 10 Hours

Check Engine Oil Level

1. Park tractor on level ground, put range shift lever in neutral (N), set brakes and turn engine "OFF".
2. Pull out dipstick (A). Oil level should be between two marks on dipstick. DO NOT operate engine when oil level is below "LOW" mark on dipstick.
3. If level is low, add oil through oil filler port (B) until even with upper mark. DO NOT overfill. (See fuels, Lubricants, Coolants and filters section.)

A—Engine Oil Dipstick
B—Engine Oil Filler Port

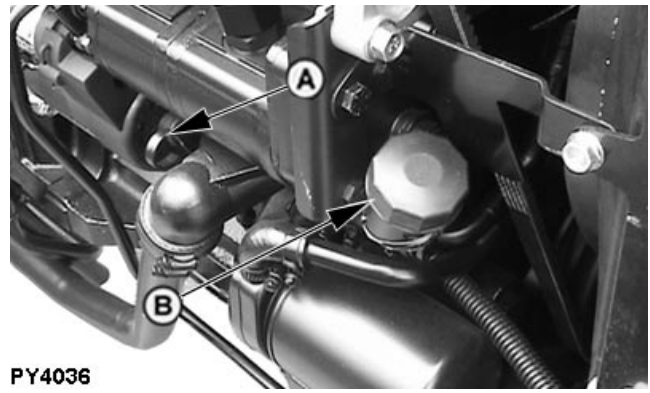

PY80265,05GO911 -19-07NOV06-1/1

Check Coolant Level

CAUTION: Only remove radiator cap (B) when engine is cold. Slowly loosen cap to first stop to relieve pressure before removing completely.

IMPORTANT: Check the coolant level when engine is cold.

1. Check coolant level in coolant recovery tank (A).
2. Coolant level shall be upto to "Cold Mark". If it is below "Cold Mark", add coolant to that mark only. (See Fuels, Lubricants and Coolant section.)

A—Coolant Recovery Tank
B—Radiator Cap

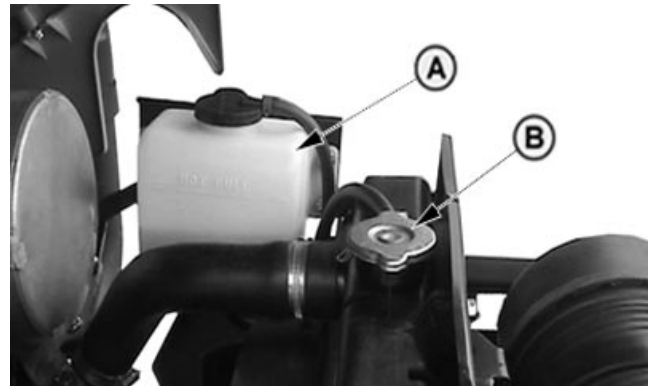
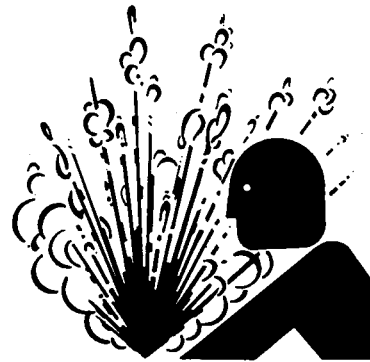

PY80265,05GO912 -19-04JUL06-1/1

Drain Water and Sediment From Fuel Filter

NOTE: Place a small container under drain fitting to catch draining fuel. Dispose of waste properly.

1. Put range shift lever in neutral (N), set brakes and turn engine OFF.
2. Open fuel filter drain Plug (A) to bleed accumulated moisture and sediment from filter into container. Tighten drain plug when clear fuel runs from drain.

A—Fuel Filter Drains

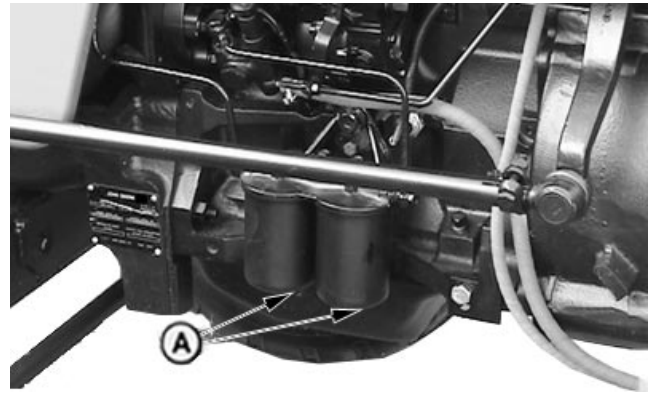

PY5162 -UN-23AUG05

PY80265,05GO913 -19-07NOV06-1/1

Lubricate as Necessary

Lubrication required only when operating in extremely wet and muddy conditions. Lubricate with several shots of multipurpose grease specified in Fuels, Lubricants and Coolant section.

- Tie rod ends
- Steering spindles (Front Axle) (See Service—50 Hours)
- Front axle pivot pin(s) (See Service—50 Hours)

- Rear axle bearings (See Service—600 Hours)

IMPORTANT: External lubrication is not required for oil type rear axle.

- Lubricate clutch pedal and right hand brake pedal (See Service—50 Hours)
- Lubricate clutch / brake shaft. (See Service—50 Hours)

NR25796,00002C6 -19-25JUL06-1/1

Service—Every 50 Hours

Check Transmission-Hydraulic System Oil Level

1. Park on level ground. Put range shift lever in neutral (N), set brakes and turn engine OFF.
2. Wait a minimum of five minutes for oil to settle.
3. Check level at sight glass. Level should be to full oil level mark (A).
4. Add oil to filler port (C) if level is low. (See Anti-Chatter Transmission/Hydraulic Oil in Fuels, Lubricants and Coolant section.)

A—Hydraulic Oil Full Level Mark
B—Hydraulic Oil Low Level Mark
C—Hydraulic Oil Filler Port

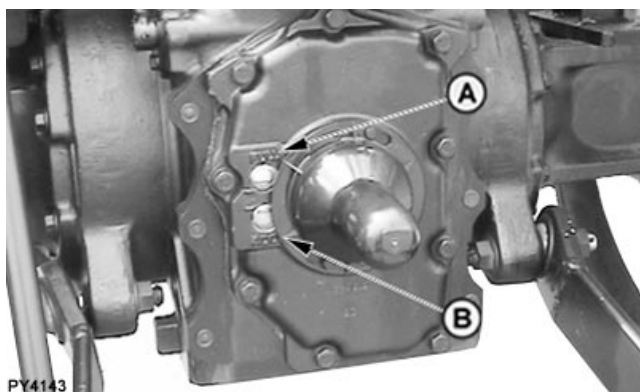

For 5103E Tractor

PY4143 -UN-12JUN06

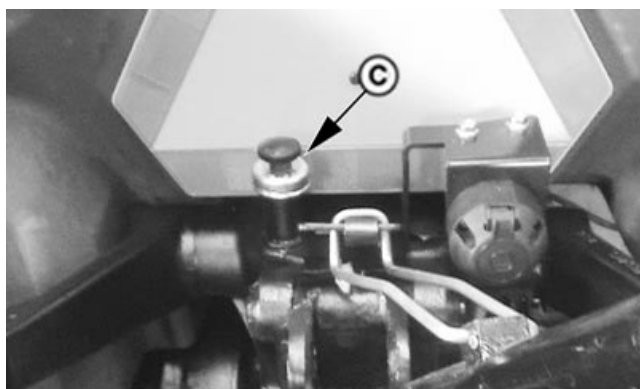

For 5103, 5103S, 5203, 5104 and 5204 Tractor

NR25796,000025E -19-29DEC06-1/1

PY4971 -UN-10DEC05

Clean and Check Battery

To access battery, see procedure in Service section.

Put range shift lever in neutral (N), set brakes and turn engine OFF. Wipe battery with a damp cloth. Clean and tighten connections if needed. Check fluid level in each cell, fill to bottom of filler neck with clean mineral-free water. (See Servicing Battery in Service section.)

A—Positive Terminal
B—Negative Terminal

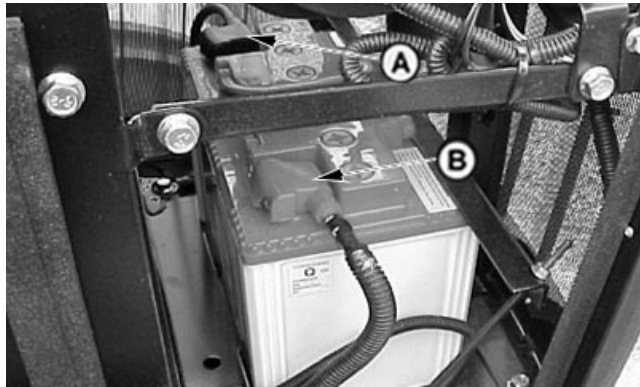

For 5103, 5103S, 5203, 5104 and 5204 Tractor

PY4018 -UN-10DEC05

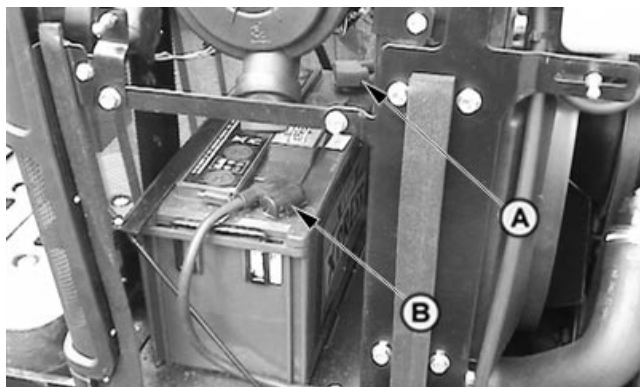

For 5103E Tractor

NR25796,000025F -19-12JAN07-1/1

PY4102 -UN-10DEC05

Lubricate Front Axle Pivot Pin

Front axle pivot pin (A) requires lubrication of the front and rear pivot bushing zerks with multipurpose grease. (See Fuels, Lubricants and Coolant section).

A—Front Axle Pivot Pin

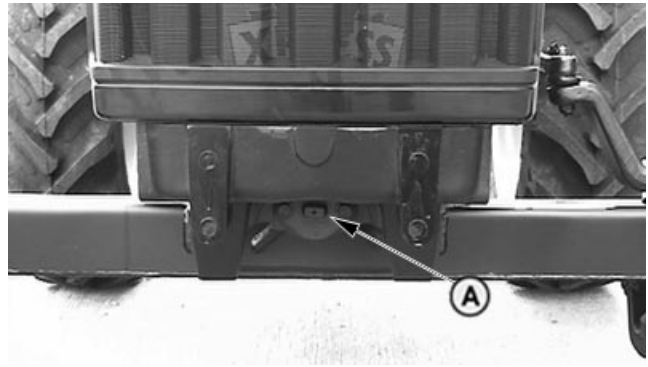

PY4146 -UN-26AUG04

NR25796,0000260 -19-12JUL06-1/1

Lubricate Steering Spindles

On front axle, apply several shots of general purpose grease to steering spindle fitting (A). (See Fuels, Lubricants and Coolant section) As Dana make front axle comes with self lubricating bearings, there is no need of spindle lubrication.

A—Greasing point



PY4144 -UN-26AUG04

NR25796,0000261 -19-12JUL06-1/1

Lubricate Clutch Pedal and Brake Pedal

Lubricate clutch pedal with multipurpose grease at greasing point (A).

Lubricate brake pedals with multipurpose grease at greasing point (B).

Also lubricate clutch and brake shaft at the same time.

- A—Clutch Pedal Greasing Points
- B—Brake Pedal Greasing Points

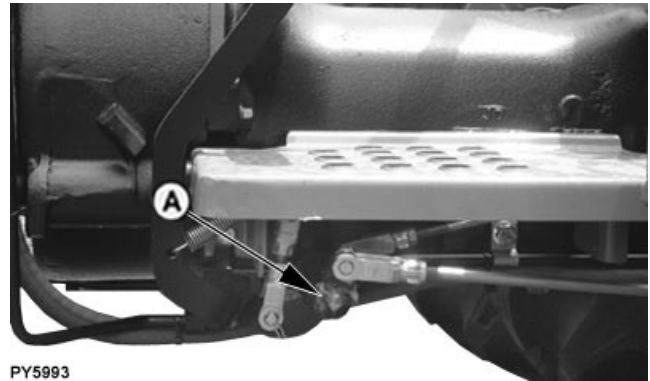

PY5993

Clutch Pedal Lubrication

PY5993 -UN-25JUL06

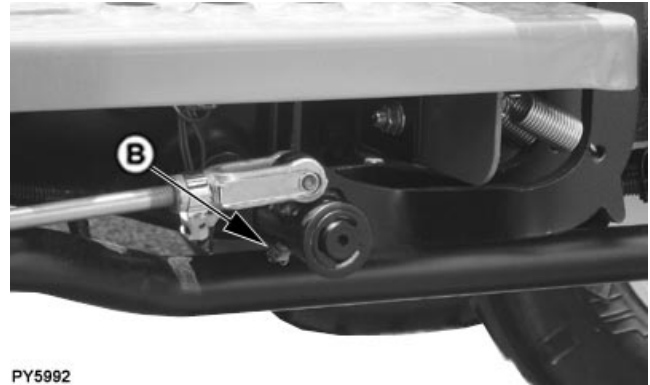

PY5992

Brake Pedal Lubrication

PY5992 -UN-25JUL06

NR25796.00002C9 -19-25JUL06-1/1

Inspect Tyres and Loose Hardwares



PY6099

PY6099 –UN–06AUG06

NOTE: Tractor shown may have optional equipment.

Inspect all tyres and check inflation pressure. Also check tractor for any loose hardware

Item	Measurement	Specification
Ballast Weights Retaining Bolts	Torque	230 N•m (170 lb-ft)
Front Axle Disk-to-Flange Bolts	Torque	210 N•m (155 lb-ft)
Rear Axle Rim-to-Disk Bolts	Torque	245 N•m (180 lb-ft)
Rear Axle Disk-to-Flange Bolts (5103, 5103S, 5203, 5104 and 5204)	Torque	550 N•m (406 lb-ft)
Rear Axle Disk-to-Flange Bolts (5103 E)	Torque	210 N•m (155 lb-ft)

NR25796,0000355 –19–12JAN07–1/1

Service—Every 250 Hours

Change Engine Oil and Filter

1. Run engine to heat oil. Turn engine off.
2. Remove oil drain plug (A) and drain oil.
3. Replace engine oil filter (B) while changing oil. Apply a film of oil on the new oil filter gasket and install new filter. Hand tighten plus 1/2 turn.
4. Install drain plug.
5. Add seasonal viscosity grade oil. (See Fuels, Lubricants and Coolant section.)

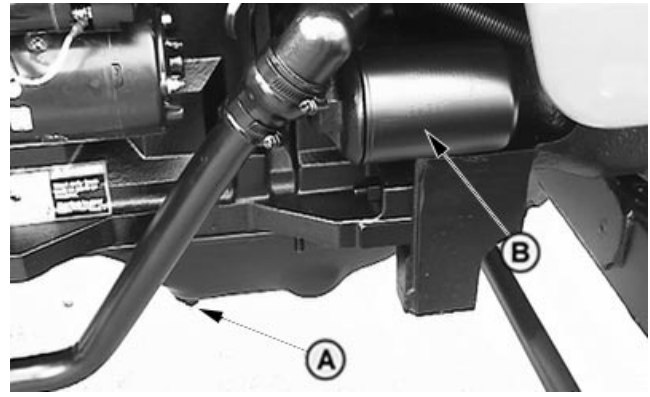

PY4147 -UN-26AUG04

A—Engine Oil Drain Plug
B—Engine Oil Filter

Specification

Engine Crankcase Oil—Capacity 8.5 L

NOTE: In Break-in-period, change the oil in first 100 hours.

PY80265.05GO920 -19-10SEP05-1/1

Service Air Cleaner

A dual element air cleaner is standard. A dirty primary element is indicated when the air restriction indicator on instrument panel illuminates. A dirty element can result in loss of power or excessive smoke.

IMPORTANT: Check unloader valve (B) frequently. Empty as often as needed to keep it from filling with dust. If valve is allowed to fill with dust, air cleaner element will plug rapidly.

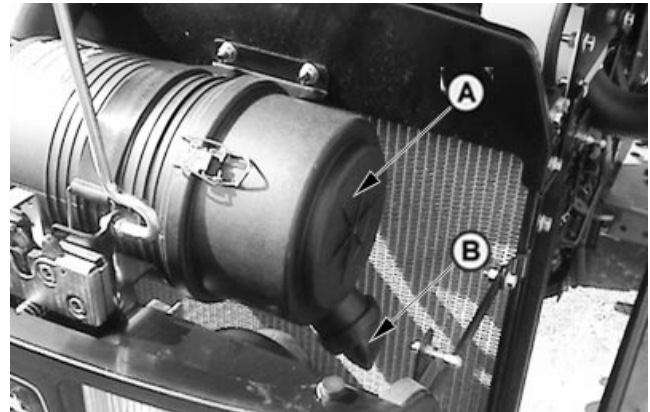

PY4179 -UN-03SEP04

A—Air Cleaner
B—Dust Unloader Valve

Service air cleaner (A) when indicator light illuminates, every 250 hours or at least once a year.

Replace primary element at least one a year.

The secondary element should be removed only when being replaced, normally once a year.

See procedure in Removing Air Cleaner Elements in Service section.

PY80265.05GO921 -19-10SEP05-1/1

Replace Fuel Filter Inserts

1. Remove cap screw (A) and filter element bowl (B).
2. Take out filter insert (C).
3. Drain the fuel and clean the bowl.
4. Install new filter insert.
5. Reinstall the bowl (B) and tighten screw (A) and washer (D).
6. Bleed the system from bleed screw (E).

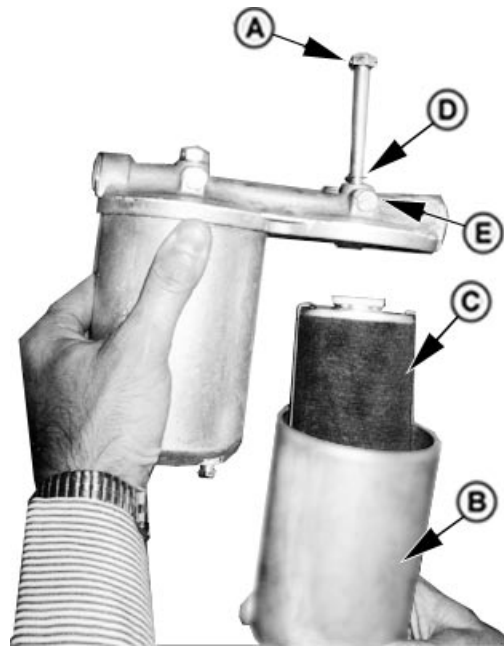

PY4917 -UN-18APR05

IMPORTANT: Change primary and secondary filter inserts alternatively. Never change both filter inserts simultaneously. Always use new O-ring which comes filter inserts.

- A—Cap Screw
- B—Filter Element Bowl
- C—Filter Insert
- D—Washer
- E—Bleed Screw

PY80265.05GO922 -19-04JUL06-1/1

Inspect and Adjust Alternator/Fan Belt

Replace if worn or damaged. (See procedure in Service section.)

NOTE: Run engine for five minutes to warm a cold belt. Let a hot belt cool for 15 minutes before adjustment.

Check tension by pressing belt midway between pulleys. Belt should deflect about 19 mm (3/4 in.) at 89 N (20 lb force).

Adjust tension by loosening cap screw (A) and mounting bolt (B). Apply force to alternator frame (C) until belt tension is correct. Tighten cap screw and bolt.

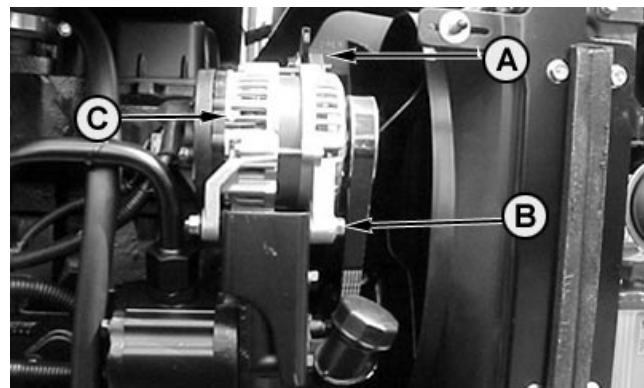

PY1652 -UN-27OCT03

- A—Tension Adjustment Cap Screw
- B—Alternator Mounting Bolt
- C—Alternator Frame

PY80265.05GO923 -19-10SEP05-1/1

Lubricate 3-Point Hitch

Lubricate right lift link (A) and left lift link (B) with several shots of multipurpose grease. (See Fuels, Lubricants and Coolant section.)

- A—Right Lift Link Grease Fittings (2 used)
- B—Left Lift Link Grease Fitting

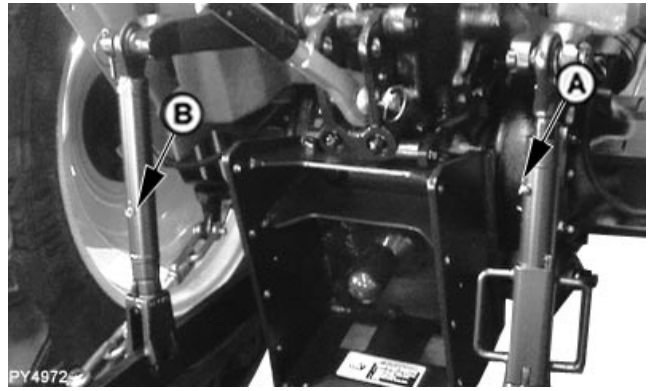

For 5103, 5103S, 5203, 5104 and 5204 Tractor

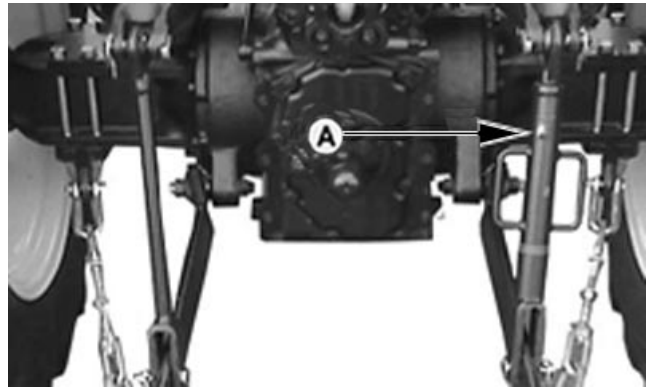

For 5103E Tractor

PY80265.05GO924 -19-29DEC06-1/1

Check Neutral Start System

Your John Deere tractor is equipped with interlocks to prevent inadvertent movement when the engine is started. Turning the key switch with the clutch pedal depressed should crank the engine if all of the following conditions exist:

- Range shift lever (A) in NEUTRAL
- PTO lever (B) in disengaged position

CAUTION: If starter turns engine in any of the following steps, have the neutral start system repaired by your John Deere dealer.

Turning the key switch to the start position should NOT start the engine, if either of the following exist:

- Range shift lever (A) in gear (not in NEUTRAL)
- PTO lever (B) in engaged position

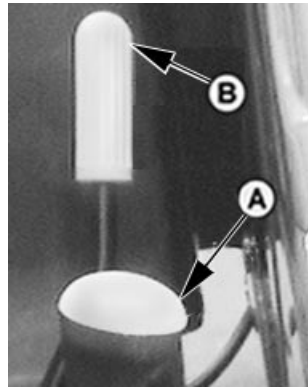

Dual Clutch Tractor

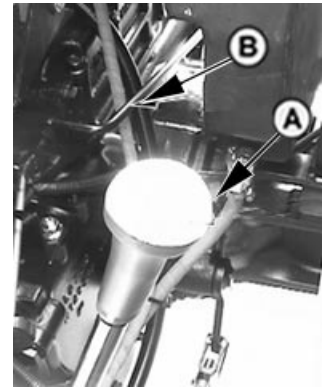

Single Clutch Tractor

- A—Range Shift Lever
- B—PTO Control Lever

PY80265.05GO925 -19-10SEP05-1/1

Check and Adjust Clutch Pedal Free Play

Measure free play (A) at top of pedal stroke. Adjust linkage to obtain 20 to 25 mm free play.

To adjust linkage, loosen lock nut (B), remove cotter pin (C), washer (D) and retaining pin (E). Rotate clevis. After making adjustment, replace clip, pin and washer and check free play. When free play is correct, tighten lock nut.

- A—Clutch Pedal Free Play
- B—Lock Nut
- C—Cotter Pin
- D—Washer
- E—Retaining Pin



Clutch Pedal Free Play

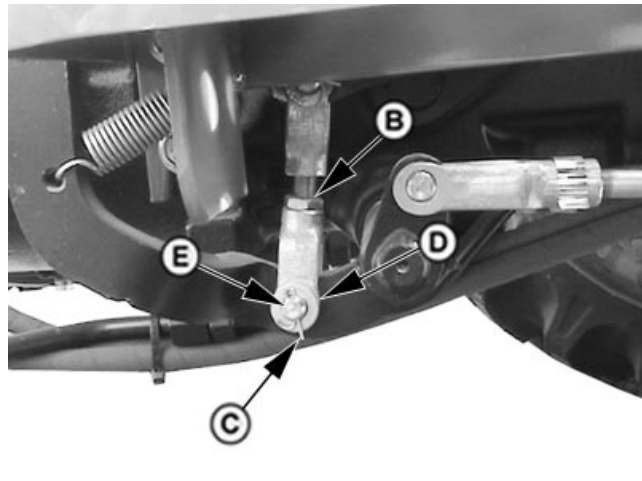

NR25796,0000356 -19-07AUG06-1/1

Check and Adjust Brake Pedal Free Play

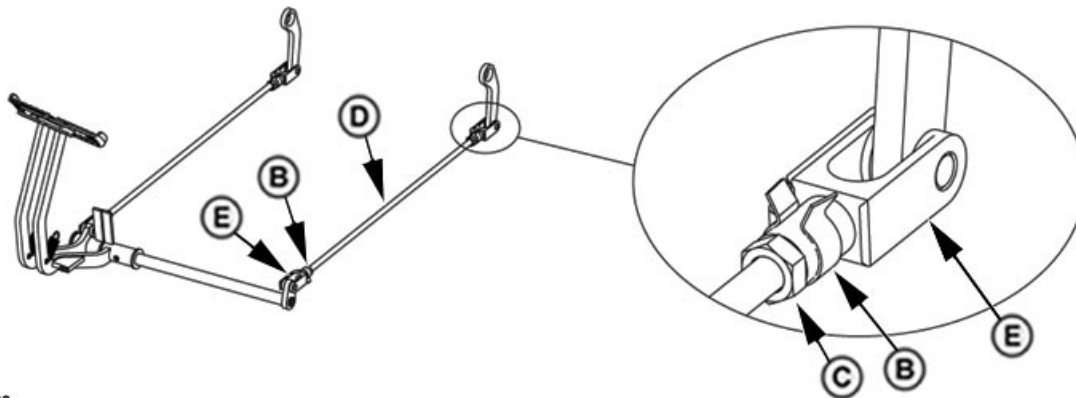

PY5828

PY5828 -UN-20JUN06

1. Park on level surface. Chock wheels to prevent machine movement.
2. Unlock brake pedals.
3. Check free play (A) of each brake pedal at top of stroke.
4. Linkage must be to specification.

Specification

Brake Pedal—Free Play..... 60 mm



PY6100

PY6100 -UN-06AUG06

Brake Pedal Adjustment

5. To adjust linkage, loosen jam nut (C).
6. Remove clip pin (B) from yoke (E) on either end of linkage.
7. Turn arm (D) until free play is to specification.
8. Tighten jam nut.
9. Install clip pin.

- A—Brake Pedal Free Play
- B—Clip Pin
- C—Jam Nut
- D—Arm
- E—Yoke

NR25796,0000357 -19-04AUG06-1/1

Service—Every 500 Hours

Replace Transmission-Hydraulic Filter

1. Remove filter (A). Apply a film of oil to new gasket and install new filter. Hand tighten plus 1/2 turn.
2. Run engine several seconds and recheck transmission-hydraulic oil level.
3. Add transmission-hydraulic oil if required (See Fuels, Lubricants and Coolant section).

A—Transmission-Hydraulic Oil Filter

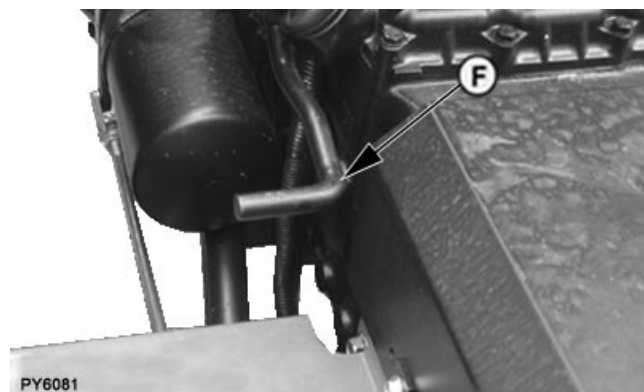

Right Side of Transmission

PY6081 -UN-06AUG06

NR25796,0000350 -19-04AUG06-1/1

Service—Every 600 Hours

Clean Engine Crankcase Vent Tube

CAUTION: Reduce compressed air to less than 210 kPa (2 bar) (30 psi) when using for cleaning purposes. Clear area of bystanders, guard against flying chips, and wear personal protection equipment including eye protection.

Remove crankcase vent tube (A) from engine. Wash in solvent or blow clean with compressed air. Reassemble vent tube breather cap to engine. Be sure vent tube is not kinked or pinched.

A—Crankcase Vent Tube

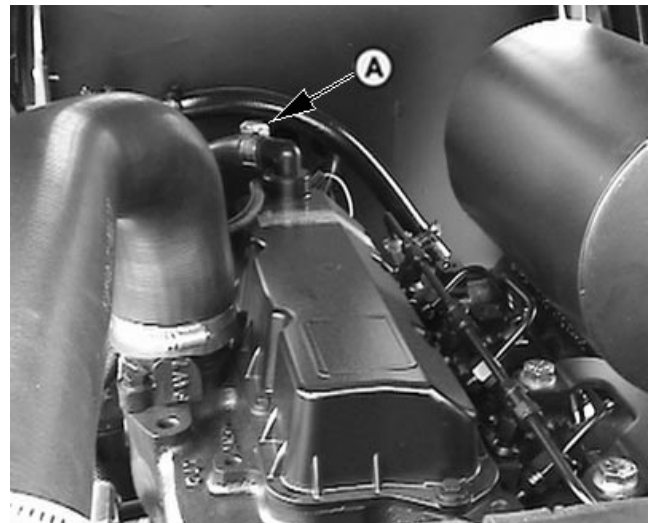

PY4527 -UN-21JAN05

PY80265.05GO929 -19-10SEP05-1/1

Pack Front Wheel Bearings (Only For Carraro Front Axle)

1. Jack up front end of tractor..
2. Remove hub cap, cotter pin, and wheel nut.
3. Remove washer and wheel bearings. Clean all parts in solvent and blow dry with compressed air. Replace any worn or damaged parts.
4. Pack bearing with multipurpose grease. (See Fuels, Lubricants and Coolant section.) Coat seal with same grease.
5. Reinstall bearings, washer, and wheel nut.
6. Tighten wheel nut until a slight drag is felt when hub is turned. Back nut off just enough to install cotter pin in hole in wheel spindle.
7. Reinstall hub cap and wheels. Tighten lug bolts to 175 N•m (130 lb-ft). Retighten bolts after driving tractor 100 m (109 yds) and again after 3 hours and 10 hours use.

IMPORTANT: DANA Front Axle: No need to grease Hub Assembly because it is provided with Self-Lubricated bearings.

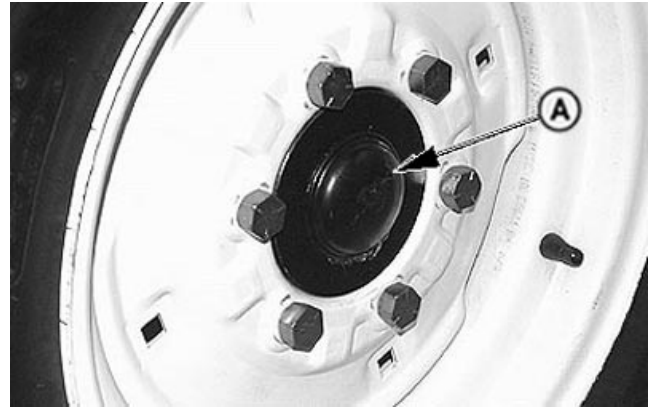

PY4529 -UN-22JAN05

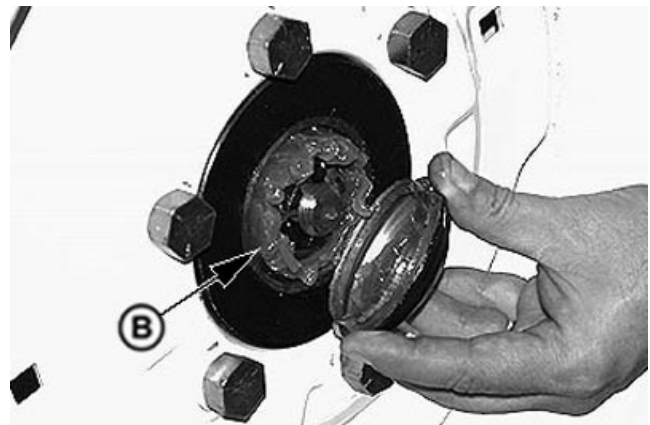

PY4528 -UN-22JAN05

A—Hub Cap
B—Pack Bearing with Grease

PY80265.05GO930 -19-10SEP05-1/1

Check Hoses and Hose Clamps for Tightness

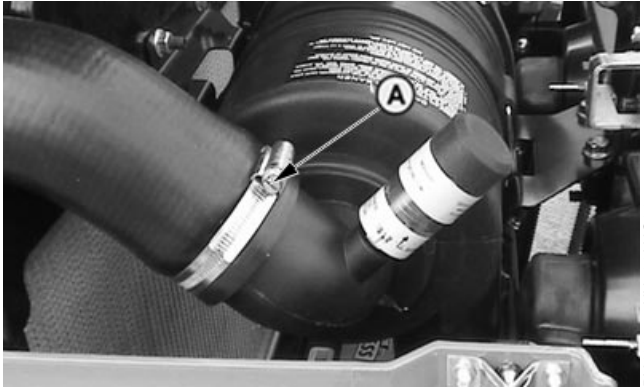

PY4115 -UN-21AUG04

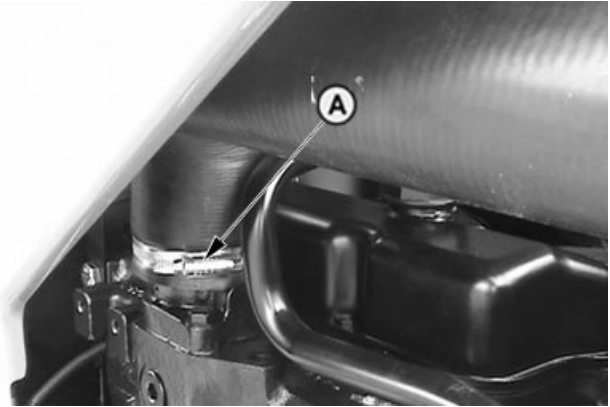

PY4116 -UN-21AUG04

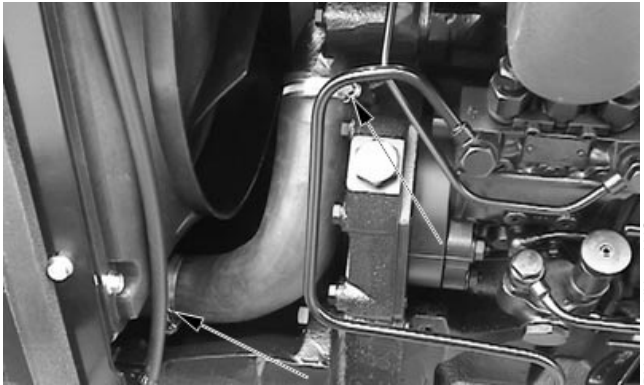

PY4156 -UN-28AUG04

Radiator Lower Hose

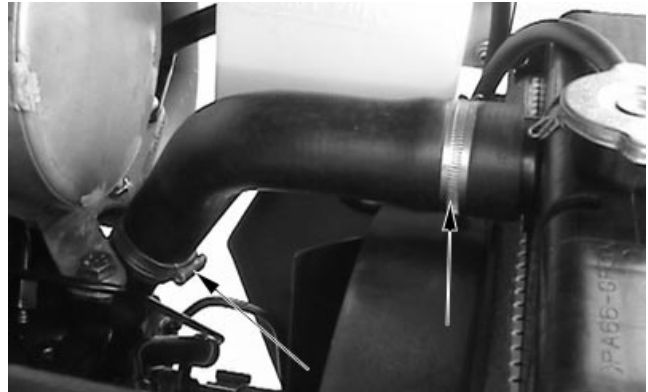

PY4155 -UN-28AUG04

Radiator Upper Hose

Check the following systems hose clamps for tightness:

- Air Cleaner to engine intake
- Engine Cooling
- Hydraulics
- Fuel

Check all hoses for cracks which could cause leaks or possible failure. Replace as necessary.

A—Hose Clip

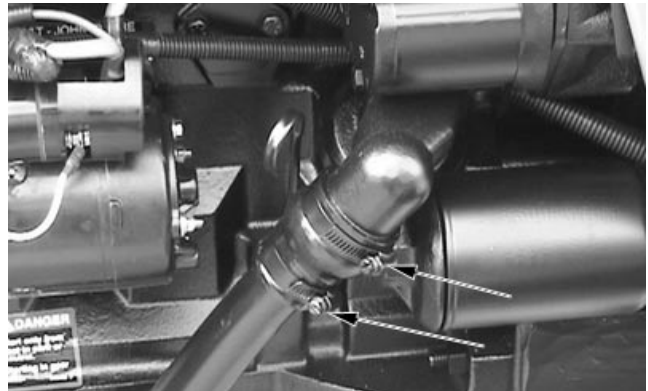

PY4154 -UN-27AUG04

PY80265,05GO931 -19-04JUL06-1/1

Lubricate Rear Axle Bearings

Lubricate rear axle fittings (A), both sides, with several shots of multi-purpose grease. (See Fuels, Lubricants and Coolant section.)

IMPORTANT: External lubrication is not required for oil type rear axle.

A—Rear Axle Fitting (2 used)



PY4025 -UN-16JUL04

Rear Axle Fitting (Dry Land)

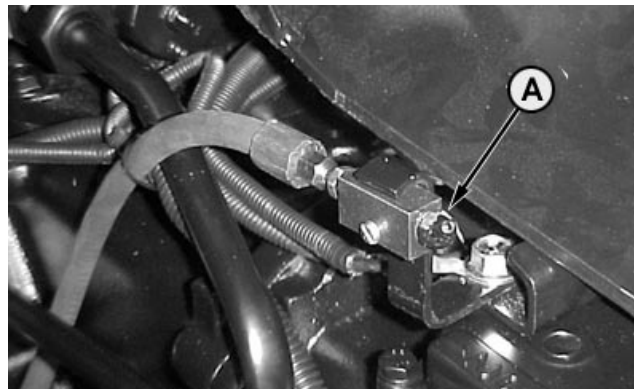

PY1707 -UN-03NOV03

Rear Axle Fitting (Wet Land)

NR25796.00002C7 -19-25JUL06-1/1

Check Engine Idle Speeds

For 5103E, 5103, 5103S and 5203 Tractors

Slow idle speed is 850 ± 25 rpm.

With no load, fast idle speed is 2485 ± 25 rpm.

If idle speeds are not correct, see your John Deere dealer.

Specification

Engine—Slow Idle—Speed 850 ± 25 rpm
 Engine—Fast Idle (with No
 Load)—Speed..... 2485 ± 25 rpm



PY5734

For 5103, 5103S, 5203, 5104 and 5204 Tractor

PY5734 -UN-31MAY06

For 5104 and 5204 Tractors

Slow idle speed is 800 - 875 rpm.

With no load, fast idle speed is 2475 - 2550 rpm.

If idle speeds are not correct, see your John Deere dealer.

Specification

Engine—Slow Idle—Speed 800 - 875 rpm
 Engine—Fast Idle (with No
 Load)—Speed..... 2475 - 2550 rpm

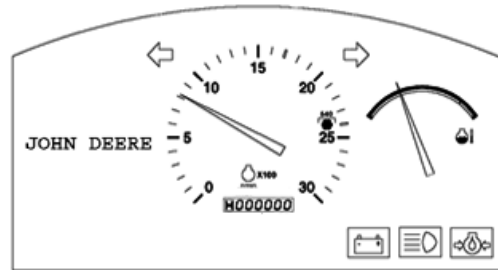

PY5758

For 5103E Tractor

PY5758 -UN-01JUN06

PY80265,05GO933 -19-29DEC06-1/1

Check Front Axle Pivot Pin

Ask your John Deere dealer to check the front axle pivot pin (A) for correct end play.

A—Front Axle Pivot Pin

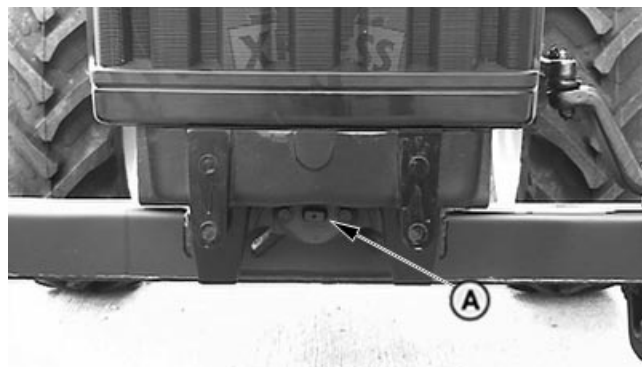

PY4146 -UN-26AUG04

PY80265,05GO934 -19-10SEP05-1/1

Adjust Engine Valve Clearance

Ask your John Deere dealer to make engine valve clearance adjustment and inspect fuel injectors

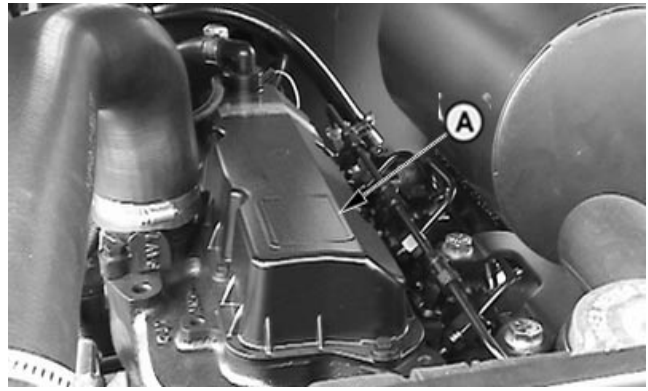

PY4038 -UN-23FEB06

NR25796,0000238 -19-21JUN06-1/1

Service—Every 1250 Hours

Change Transmission-Hydraulic Oil and Filter

1. Lower rockshaft to remove trapped oil.
2. Remove drain plug (C) from transmission case and drain oil. Dispose of waste oil properly.
3. Replace filter (B) while changing oil. Apply a film of oil to new filter gasket and install new filter. Hand tighten only.

A—Axle Housing
B—Transmission Oil Filter
C—Transmission Case Drain Plug

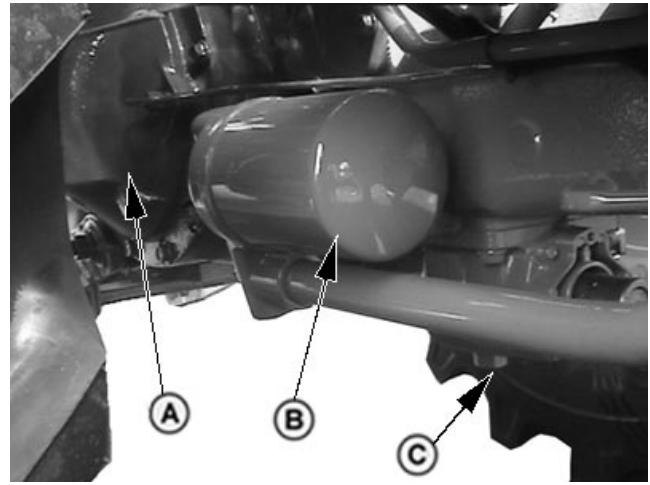

PY80265,05GO935 -19-12JUN06-1/2

4. Fill system with transmission-hydraulic oil. (See Fuels, Lubricants and Coolant section.)

Specification

Transmission Oil (Rear tyre size:
12.4 X 28 or 13.6 X 28)—
Capacity 33 L
Transmission Oil (Rear tyre Size
14.9 X 28—Capacity 34 L

5. Check oil level at sight glass after filling. Make sure oil level is to full level mark (A). Check again after operating for five minutes. Add oil if necessary.

A—Full Level Mark
B—Add Level Mark

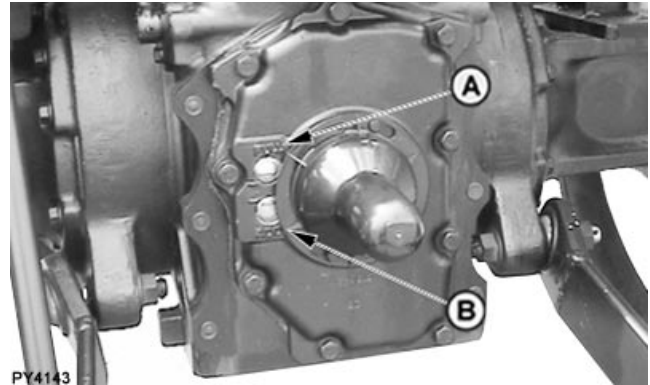

PY80265,05GO935 -19-12JUN06-2/2

Clean Transmission-Hydraulic Pickup Screen

Remove two cap screws (A) and remove screen cover (B).

1. Drain transmission-hydraulic oil. (See Change Transmission-Hydraulic Oil and Filter in this section.)
2. Remove screen and examine it for damage. Replace if necessary. Clean screen in solvent and blow dry with compressed air.
3. Carefully install screen so the front of screen is inserted in hole at front of differential case.
4. Fill system with transmission-hydraulic oil. (See Changing Transmission-Hydraulic Oil and Filter in this section.)
5. Check oil level at sight glass (C) after filling, and again after operating for five minutes.

A—Cap Screws (2 used)
B—Screen Cover
C—Sight Glass

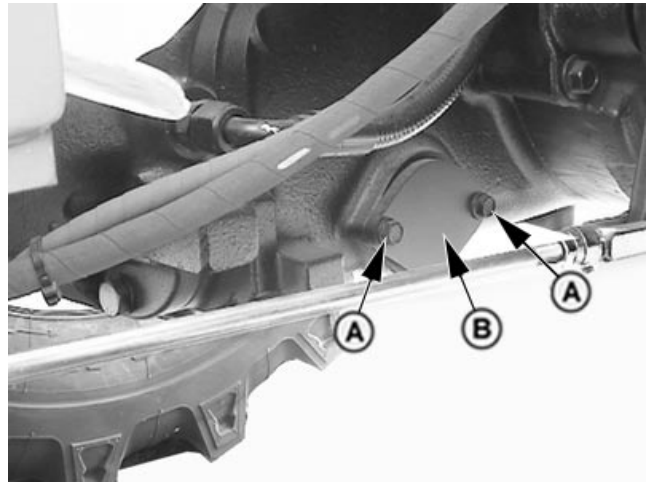

PY4974 -UN-22APR05

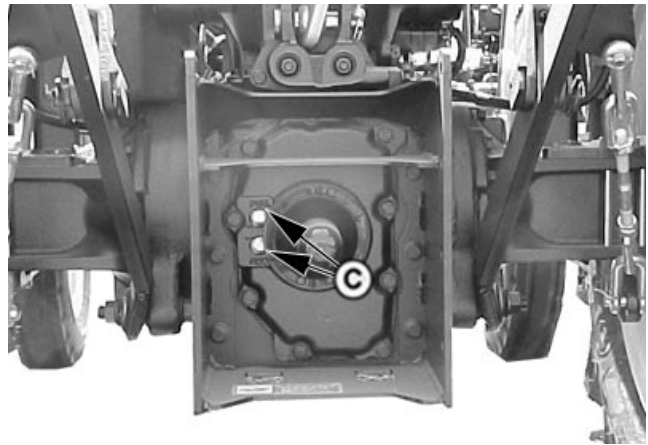

PY4973 -UN-22APR05

PY80265.05GO936 -19-10SEP05-1/1

Service—Annually

Replace Air Cleaner Elements

1. Open hood and remove side screen. (See Removing Side Screen in Service chapter.)
2. Release clips (A).
3. Remove cover (B).
4. Remove primary element (C).
5. Clean out any dirt in canister taking care not to damage the secondary filter element.

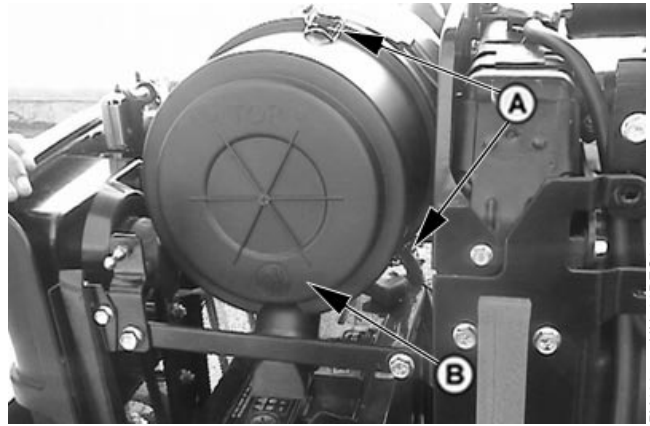

PY4295 -UN-06DEC04

IMPORTANT: Remove secondary element (inner element) **ONLY** if it is to be replaced. **DO NOT** attempt to clean secondary element.

If secondary element is replaced, install new element immediately to prevent dust from entering air intake system.

6. Removal of the secondary element (D) is similar to removal of the primary element.

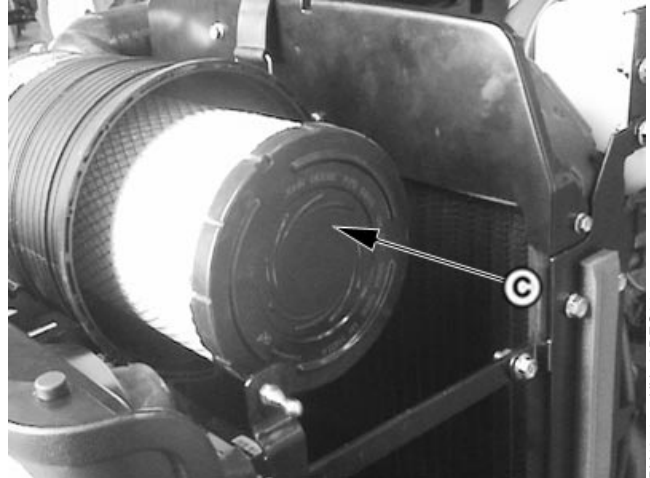

PY4271 -UN-06DEC04

NOTE: When installing the air cleaner canister, make sure that the dust unloader valve is facing down.

7. Install secondary element, primary element and cover.
8. Install side screens.

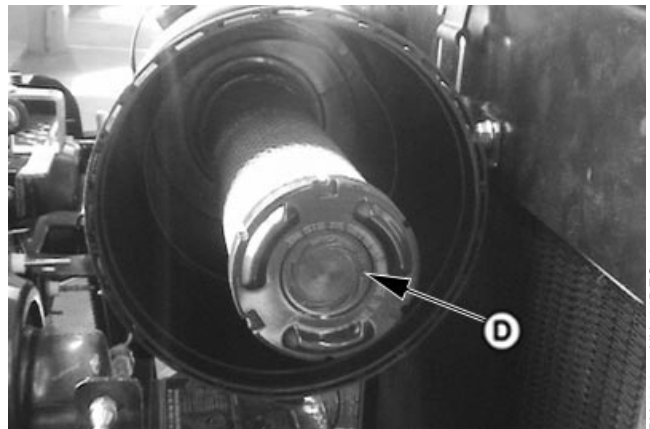

PY4294 -UN-06DEC04

- A—Clips
- B—Cover
- C—Primary Element
- D—Secondary Element

PY80265.05GO937 -19-10SEP05-1/1

Service—2 Years/2000 Hours

Flush Cooling System

For efficient operation, drain old coolant, flush the entire system, and fill with clean antifreeze solution at least once every two years.

CAUTION: DO NOT remove radiator cap or drain coolant until coolant is cold. Always loosen radiator cap slowly to relieve any excess pressure.

1. Drain coolant - Remove radiator cap (A). Open drain plug (B) on radiator and attach a drain hose. Route hose to container and drain coolant from radiator. Drain coolant from engine block by removing plug (C).

IMPORTANT: Thermostat must be removed to ensure a thorough flush.

2. Remove thermostat cover (D), remove thermostat and install cover (without thermostat). Tighten cap screws to specification.

Specification

Thermostat Cover Cap Screws—

Torque 47 N•m (35 lb-ft)

3. Flush system with water - Close all drain valves/plugs and fill system with clean water. Run engine about 10 minutes to stir up possible rust or sediment. Stop engine and drain water from system before rust and sediment settle.
4. Flush system with radiator cleaner - Close all drain valve/plugs and fill the cooling system with a good commercial radiator cleaner and water. Follow instructions provided with cleaner. Stop engine and immediately drain system.
5. Flush system with water - Close all drain valves/plugs and fill with clean water to flush the system. Run the engine about 10 minutes, then drain out flushing water.

- A—Radiator Cap
- B—Drain Plug
- C—Coolant Drain Plug
- D—Thermostat Cover

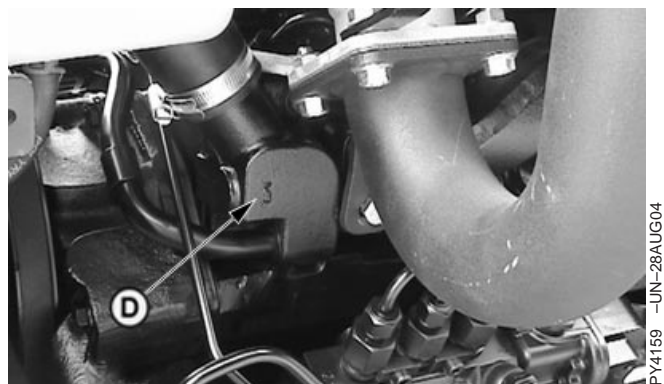
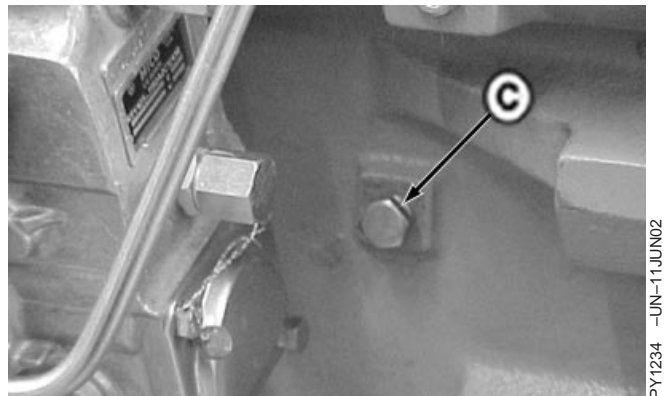
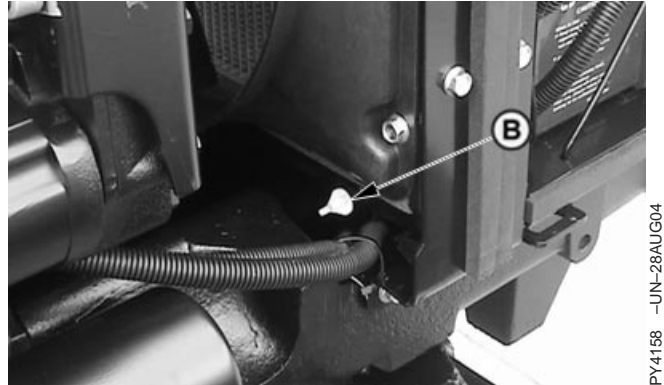

Continued on next page

PY80265.05GO938 -19-05JUL06-1/2

6. Remove thermostat cover and clean off the gasket material. Apply gasket sealant to new gasket and install thermostat and cover. Tighten cap screws to specification.

Specification

Thermostat Cover Cap Screws—

Torque 47 N•m (35 lb-ft)

7. Fill with fresh coolant - Close all drain valves/plugs and fill with a mixture of antifreeze, soft water, and coolant conditioner as specified in the Fuels, Lubricants, and Coolant section.
8. Check coolant level - Fill radiator to the top of the filler neck. Run the engine until operating temperature is reached. Let the engine cool (preferably overnight) and recheck the coolant level. Coolant level with a cold engine should be at the bottom of the filler neck. When filling the cooling system it may require several operating/cooling periods to stabilize the coolant level in the system. Add make-up coolant to the radiator as needed to bring the coolant level to the correct level.

PY80265,05GO938 -19-05JUL06-2/2

Service—As Required

Service Air Cleaner

Under dusty conditions, it may be necessary to service air cleaner more often than every 250 hours. Whenever dirty primary element is indicated by loss of power, excessive smoke or air restriction indicator light, replace primary element (A). (See Replace Air Cleaner in Service—250 Hours section.)

A—Primary Element

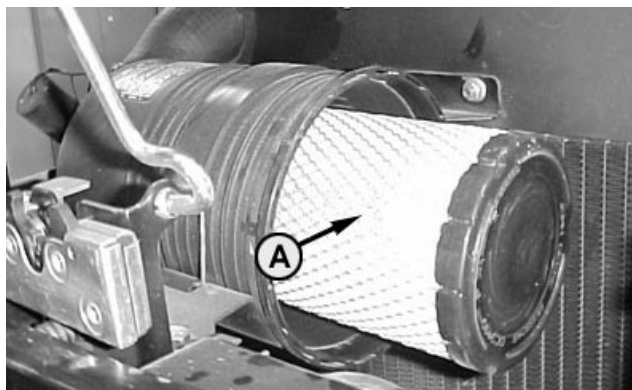

PY1688 -UN-31OCT03

PY80265,05GO939 -19-10SEP05-1/1

Adjust Throttle Friction

When throttle linkage becomes loose and does not stay in set position, adjust as follows:

NOTE: Instrument and side panels removed for illustration purposes. Throttle lever lock nut can be accessed by lowering key switch cover.

1. Adjust spring tension by loosening or tightening lock nut (A) until throttle lever movement is smooth throughout range of travel with only slight drag.

A—Throttle Lever Lock Nut

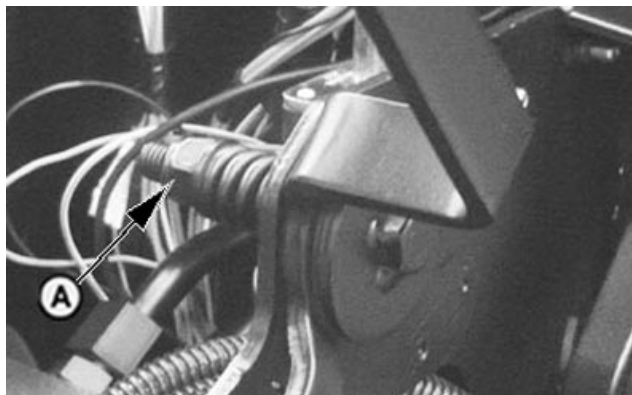

PY4072 -UN-24JAN05

PY80265,05GO940 -19-10SEP05-1/1

Service

Additional Service Information

This is not a detailed service manual. It contains only information needed for operation and routine maintenance. If you want more detailed service information, refer to Parts Catalog and/or a Technical Manual available at Dealership

PY80265.05GO941 -19-10SEP05-1/1

Service Tractor Safely



PY6099

PY6099 -UN-06AUG06

NOTE: Tractor shown may have optional equipment.

Disengage power to attachments and stop engine before making any repairs or adjustments.

Do not change engine governor setting or overspeed engine.

Keep the vehicle and attachments in good operating condition.

Keep safety devices in place and in working condition.

Keep all nuts, bolts, and screws tight to be sure the equipment is in safe working condition.

Before you work on any part of the engine, stop the engine, and let it cool. Hot engine parts can burn skin on contact.

Never run engine unless range shift lever is in neutral position.

Be careful to prevent clothing, jewelry, or long hair from getting caught in the fan blades, drive belts, or any other moving engine parts.

Unauthorized modifications to the machine may impair the function and/or safety and affect machine life.

NR25796,0000359 -19-07AUG06-1/1

Engine Break-In Oil

New engines are filled at the factory with John Deere ENGINE BREAK-IN OIL. During the break-in period, add John Deere ENGINE BREAK-IN OIL as needed to

maintain the specified oil level. Change the oil and filter after the first 100 hours of operation of a new or rebuilt engine.

PY80265.05GO943 -19-10SEP05-1/1

Work In Ventilated Area

Engine exhaust fumes can cause sickness or death. If it is necessary to run an engine in an enclosed area, remove the exhaust fumes from the area with an exhaust pipe extension.

If you do not have an exhaust pipe extension, open the doors and get outside air into the area



TS220 -UN-23AUG88

PY80265.05GO944 -19-10SEP05-1/1

Using High-Pressure Washers

IMPORTANT: Directing pressurized water at electronic/electrical components or connectors, bearings and hydraulic seals, fuel injection pumps or other sensitive parts and components may cause product malfunctions. Reduce pressure, and spray at a 45 to 90 degree angle.

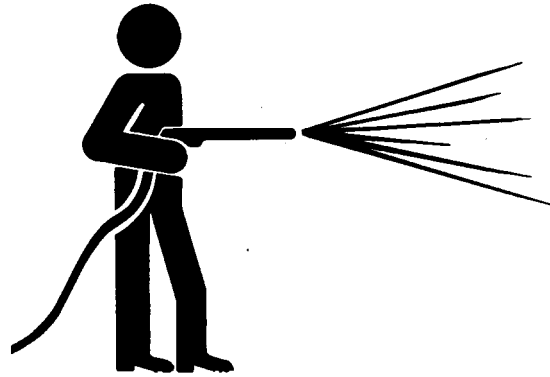

T6642EJ -UN-18OCT88

PY80265.05GO945 -19-10SEP05-1/1

Opening Hood

1. Push hood latch release (A) in to unlock hood.
2. Raise hood and lift the support rod (B).
3. Insert the hood support rod into the hood latch striker slot (C) to hold hood in raised position.

A—Hood Latch Release
B—Hood Support Rod
C—Hood Latch Striker



PY5152 -UN-21AUG05

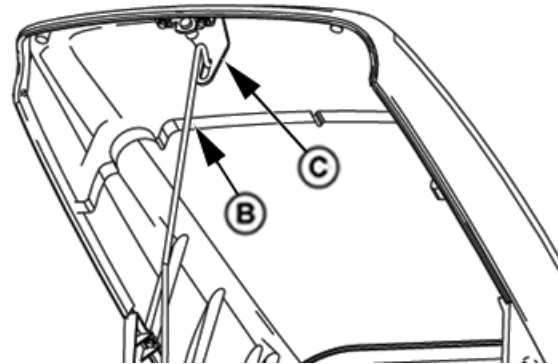

PY5829

PY5829 -UN-20JUN06

PY80265,05GO946 -19-20JUN06-1/1

Removing Side Screens

1. Raise the hood and secure with the support rod.
2. Pull side screen (A).
3. Tilt screen outward and lift from lower mounting slots.

A—Side Screens

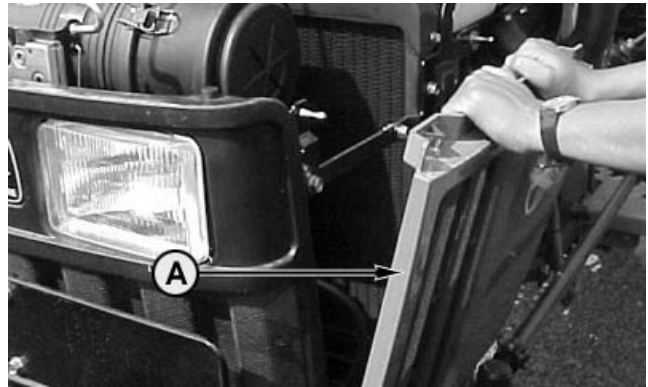

PY1736 -UN-14DEC05

PY80265,05GO947 -19-10SEP05-1/1

Removing Hood

1. Remove side screens. (See Removing Side Screens in this chapter.)
2. Remove two cap screws (A) securing hood.
3. Release the hood support rod from the hood latch and secure the rod in the stored position.
4. Remove hood from tractor.

PY5813

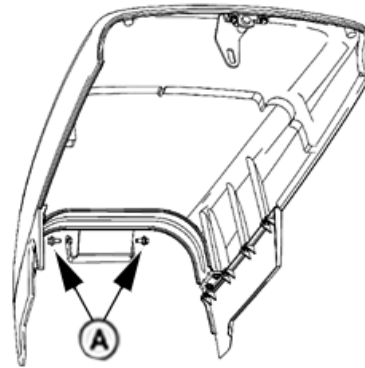

PY5813 -UN-19JUN06

A—Cap Screws (2 used)

PY80265,05GO948 -19-20JUN06-1/1

Air Intake System Components

Air enters the intake system through the open end of the air cleaner canister. A major portion of the dust is separated out by air turbulence action of the primary air cleaner element (A) and passed out into the radiator inlet air flow through the dust unloader valve (C). If the primary element becomes plugged, dust is filtered out by the secondary element (B).

- A—Primary Air Cleaner Element
- B—Secondary Air Cleaner Element
- C—Dust Unloader Valve

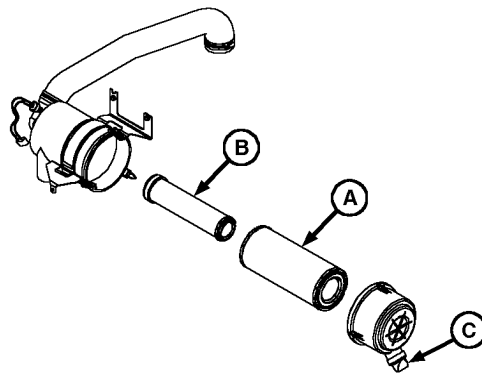

LV4089 -UN-20JUL99

PY80265,05GO949 -19-10SEP05-1/1

Service Air Cleaner at Regular Intervals

Service air cleaner if air restriction indicator (A) illuminates or at least every 250 hours. Replace air cleaner elements at least once a year.

The smaller “secondary” element should be removed only when being replaced, normally once a year. (See Replace Air Cleaner in Service—250 Hours section.)

A—Air Restriction Indicator

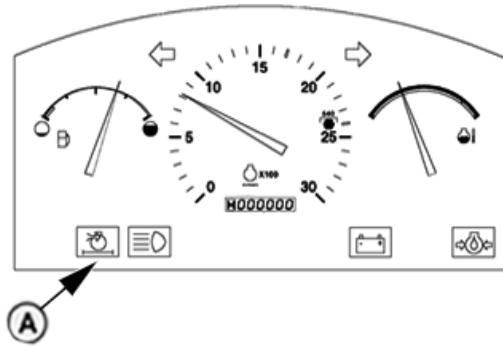

PY5731

For 5103, 5103S, 5203, 5104 and 5204 Tractor

PY5731 -UN-31MAY06

PY80265,05GO950 -19-29DEC06-1/1

Service Air Cleaner at Regular Intervals (5103E Tractor)

When Red indicator is seen in transparent area of Air restriction indicator (A) or at least every 250 hours. Replace air cleaner elements at least once a year.

The smaller “secondary” element should be removed only when being replaced, normally once a year. (See Replace Air Cleaner in Service—250 Hours section.)

A—Air Restriction Indicator

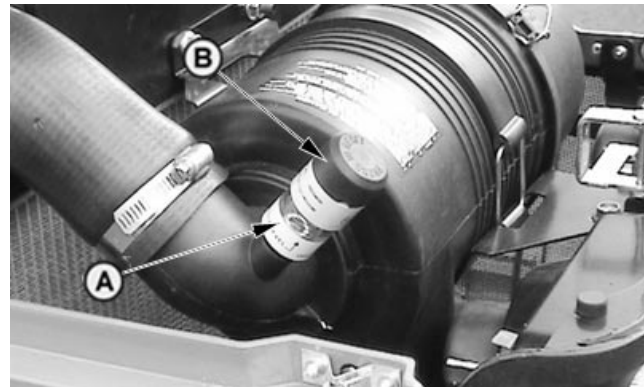

For 5103E Tractor

PY4093 -UN-25AUG04

PY80265,05GO951 -19-10SEP05-1/1

Checking Air Intake System

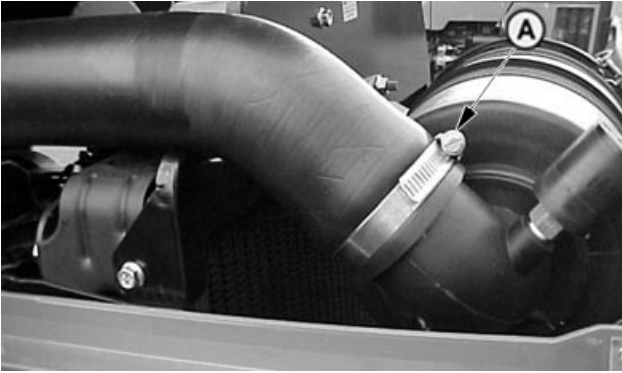

PY4016 -UN-14JUL04

For 5103, 5103S, 5203, 5104 and 5204 Tractor

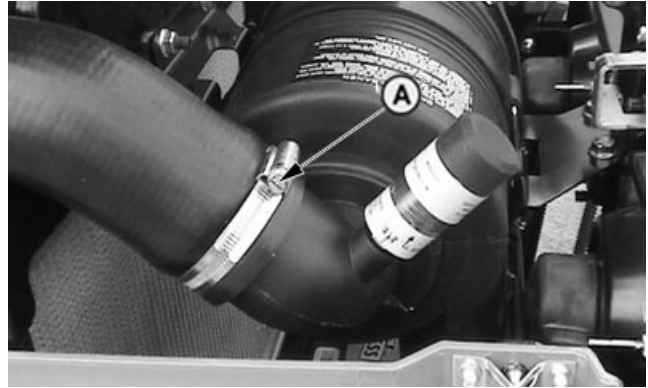

PY4115 -UN-21AUG04

For 5103E Tractor

Check all air intake system clamps (A) for tightness.

A—Air Intake System Clamps



PY4116 -UN-21AUG04

PY80265,05GO952 -19-29DEC06-1/1

Removing Primary Air Cleaner Element

1. Disconnect rubber strap (A) at the front of the canister.
2. Lift clip (B) and pull canister cover.
3. Clean out any dirt in canister taking care not to damage the secondary filter element.
4. Removal of the secondary element is similar to removal of the primary element.

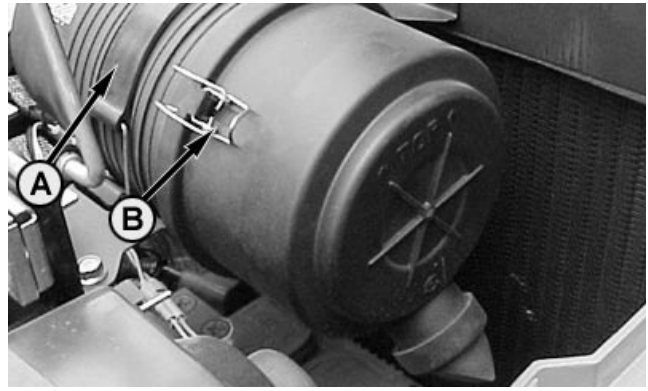

PY1100 -UN-29JUL01

IMPORTANT: Remove secondary element (inner element) **ONLY** if it is to be replaced. **DO NOT** attempt to clean secondary element. If secondary element is replaced, install new element immediately to prevent dust from entering air intake system. When replacing the air cleaner canister, make sure that the dust cup/ejector hose is facing downward.

A—Rubber Strap
B—Clip
C—Primary Element

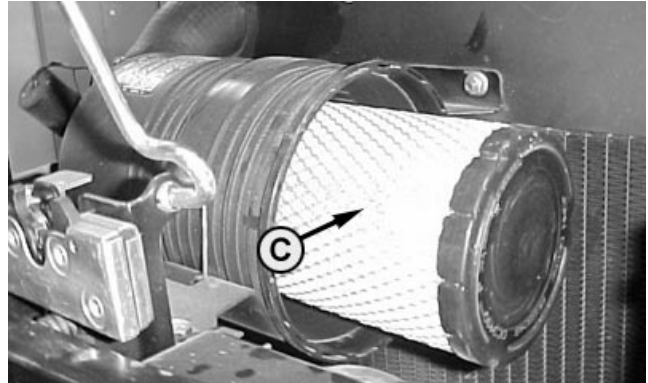

PY1113 -UN-29JUL01

PY80265.05GO953 -19-05JUL06-1/1

Cleaning Primary Element

1. Pat sides of element gently to loosen dirt. **DO NOT** tap element against a hard surface.
2. clean element with compressed air (below 690 kPa or 100 psi). Hold nozzle next to inner surface, and move up and down pleats.

IMPORTANT: **DO NOT** direct air against outside of element, as it might force dirt through to inside.

3. Inspect element before reinstalling.

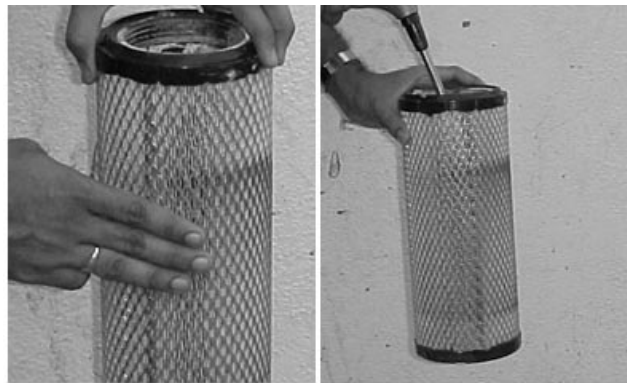

PY1114 -UN-29JUL01

PY80265.05GO954 -19-10SEP05-1/1

Washing Primary Element

IMPORTANT: Never wash element in gasoline or any solvent. Never use compressed air on a wet element. Do not oil element.

1. If element is coated with oil or soot, wash in a solution of warm water. Let element soak at least 15 minutes, then agitate gently to flush out dirt.
2. Rinse element thoroughly from inside with clean water. Use element cleaning gun or a free-running hose. Keep water pressure low (below 280 kPa or 40 psi) to avoid damaging element.
3. Allow element to dry completely before using. This usually takes from one to three days. DO NOT oven dry or use drying agents. Protect element from freezing until dry.
4. Inspect element before installing.

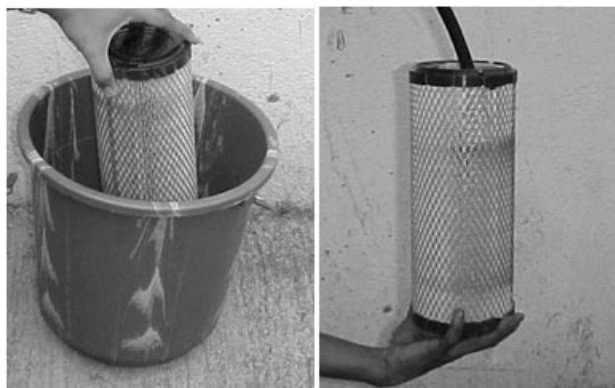

PY1122 -UN-31JUL01

PY80265.05GO955 -19-10SEP05-1/1

Inspecting Element

1. Hold a bright light (A) inside element (B) and check carefully for holes. Discard any element which shows the slightest hole.
2. Be sure outer screen is not dented. Vibration would quickly wear a hole in filter.
3. Be sure rubber sealing surfaces (C) are in good condition on both ends. If damaged, replace element.

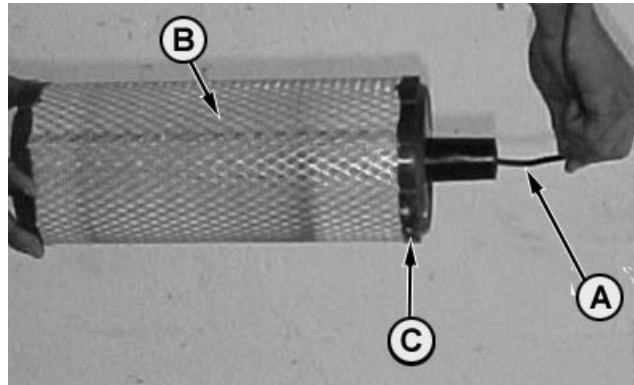

PY1636 -UN-30SEP03

A—Light Source
 B—Element
 C—Rubber Sealing Surface

PY80265.05GO956 -19-10SEP05-1/1

Storing Element

If element is not installed on tractor, seal element in a plastic bag and store in its original shipping container to protect against dust and damage.

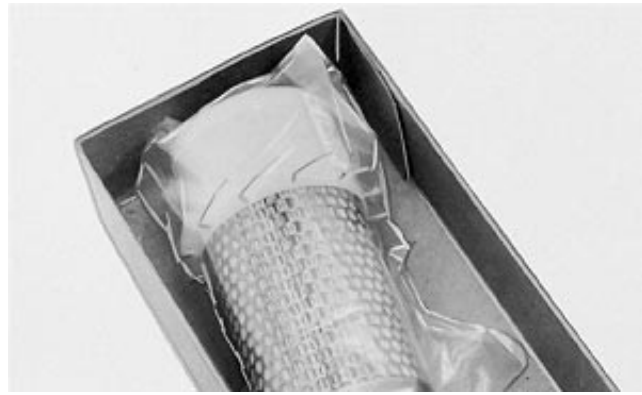

RW471 -JUN-26FEB90

PY80265.05GO957 -19-10SEP05-1/1

Replacing Alternator/Fan Belt

1. Loosen cap screw (A) and bolt (B) and rotate the alternator (C) to free the belt.
2. Remove belt from drive pulley.
3. Belt can be pulled around fan to remove.
4. Install new belt in reverse order of removal.
5. Adjust belt tension. (See Inspect and Adjust Alternator/Fan Belt in Service—250 Hours section.)

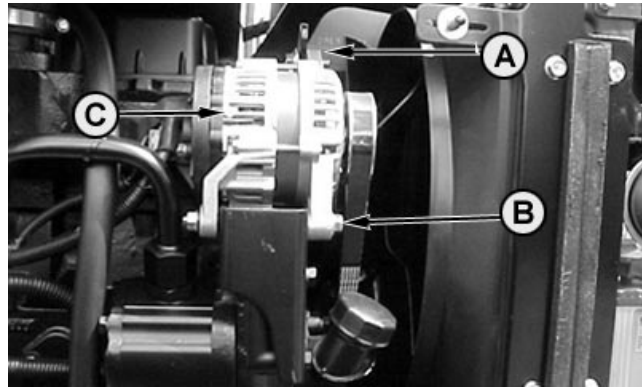

PY1652 -JUN-27OCT03

- A—Alternator Cap Screw
- B—Alternator Bolt
- C—Alternator

PY80265.05GO958 -19-10SEP05-1/1

Fuel System Components

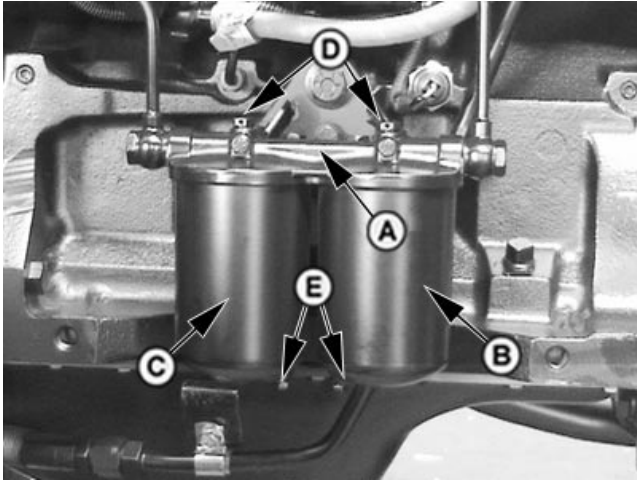

PY4895 -UN-11APR05

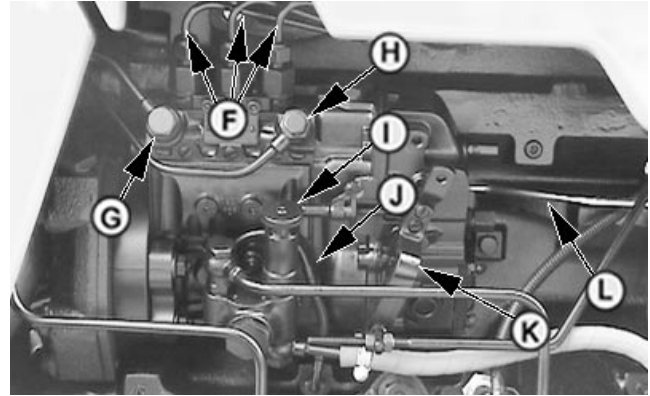

PY4887 -UN-19APR05

A—Mico Fuel filter Assembly
 B—Primary Filter
 C—Secondary filter
 D—Bleeding Screws-2 nos

E—Sediment Drain Screws-2 nos
 F—Fuel Injection Lines

G—Fuel Line to Pump
 H—Fuel return line
 I—Hand Priming Pump

J— Lubrication
 K—Acclerator
 L—Fuel Shut Off Lever

PY80265.05GO959 -19-10SEP05-1/1

Do Not Modify Fuel System

IMPORTANT: Modification or alteration of the injection pump, the injection pump timing, or the fuel injectors in ways not recommended by the manufacturer will terminate the warranty obligation to the purchaser. (See warranty information inside front cover.)

DO NOT attempt to service injection pump or fuel injectors yourself. Special training and special tools are required. (See your John Deere dealer.)

PY80265.05GO960 -19-10SEP05-1/1

Bleeding Fuel System

1. Loosen fuel return line (A).
2. Unscrew hand primer (B) on fuel supply pump until it can be pulled by hand.
3. Operate the hand primer until fuel flow is free from air bubbles.
4. Simultaneously stroke the hand primer down and close the fuel return port. This prevents air from entering the system. Tighten securely.
5. Lock hand primer in position.

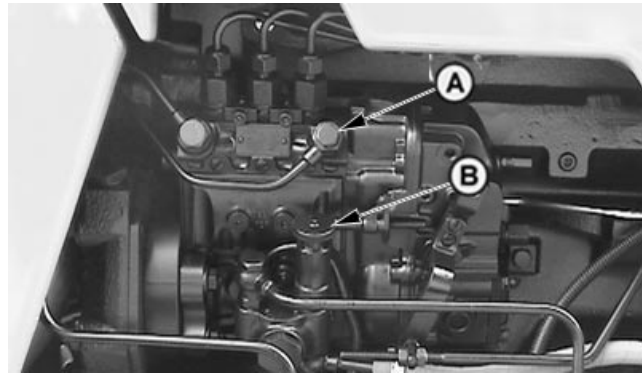

PY4117 -UN-21AUG04

A—Fuel Return Line
B—Hand Primer

PY80265,05GO961 -19-10SEP05-1/1

Bleed Fuel System At Fuel Injection Nozzles

If engine will not start after the bleeding procedures described above, continue as follows:

1. Place throttle lever in fast idle position.
2. Using two open-end wrenches, loosen fuel line on at least three nozzles.
3. Turn over engine with starter motor until fuel flows free from bubbles out of loosened fuel nozzle connections. Retighten connections.



PY1743 -UN-06NOV03

PY80265,05GO962 -19-10SEP05-1/1

Engine Cooling System

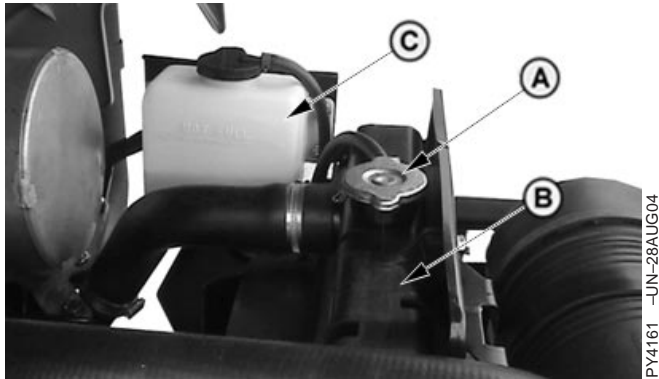

PY4161 -UN-28AUG04

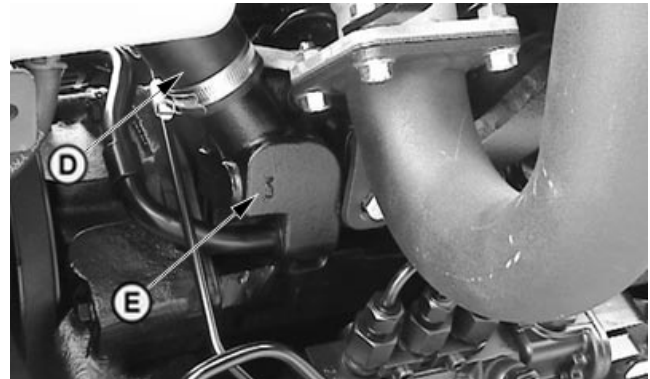

PY4163 -UN-28AUG04

Coolant is added in coolant recovery tank and not in radiator directly. For efficient operation, drain old coolant, flush entire cooling system atleast once in two years (See procedure in Service-2 years / 2000 hours section)

IMPORTANT: Never pour cold water into the cooling system of a hot engine, as it might crack cylinder block or head. DO NOT operate engine without coolant for even a few minutes.

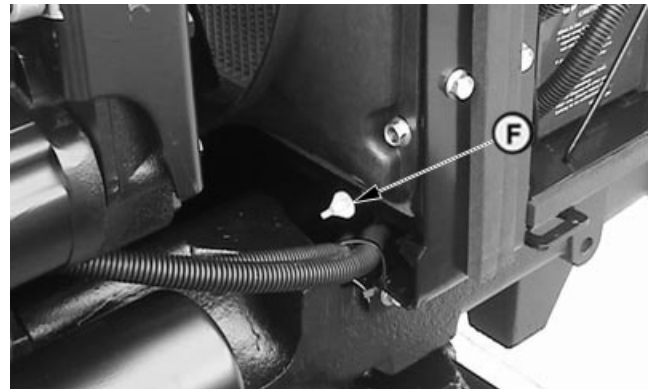

PY4162 -UN-28AUG04

- A—Radiator Cap
- B—Radiator
- C—Coolant Recovery Tank
- D—Upper Radiator Hose
- E—Thermostat Valve
- F—Radiator Drain Plug

PY80265,05GO963 -19-10SEP05-1/1

Cleaning Grille, Screens, Radiator and Oil Cooler

1. Whenever trash builds up on front grille (A) or side screens (B), stop engine and brush clean.

CAUTION: Reduce compressed air to less than 210 kPa (2 bar) (30 psi) when using for cleaning purposes. Clear area of bystanders, guard against flying chips, and wear personal protection equipment including eye protection.

2. Remove side screens (B), and see if trash has built up on radiator (C). If so, carefully remove it using a brush or compressed air.
3. If a more thorough cleaning is necessary, clean radiator from behind with compressed air or water. Straighten any bent fins.

A—Grille
B—Side Screens
C—Radiator

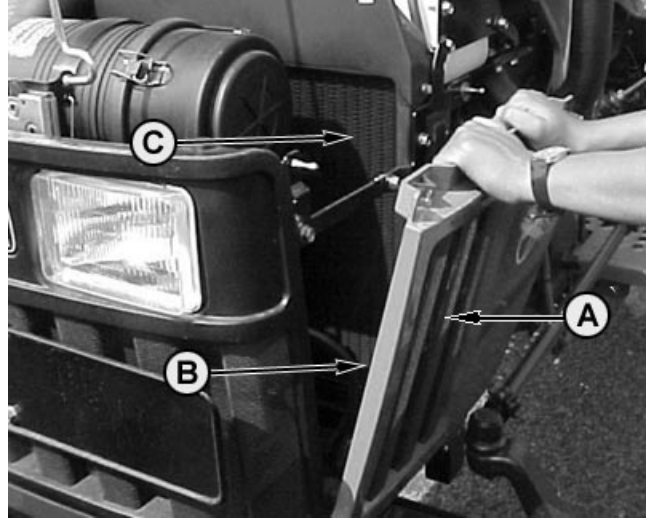
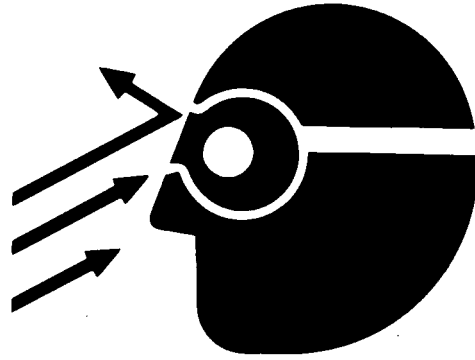

TSS266 -JUN-23AUG88

PY1804 -JUN-15NOV03

PY80265.05GO964 -19-10SEP05-1/1

Prevent Battery Explosions

Keep sparks, lighted matches, and open flame away from the top of battery. Battery gas can explode.

Never check battery charge by placing a metal object across the posts. Use a volt-meter or hydrometer.

Do not charge a frozen battery; it may explode. Warm battery to 16°C (60°F).



TS204 -JUN-23AUG88

PY80265.05GO965 -19-10SEP05-1/1

Observe Electrical Service Precautions

CAUTION: Keep all sparks and flames away from batteries, as gas given off by electrolyte is explosive. To avoid sparks, connect negative (ground) cable (B) last and disconnect it first. When using a booster battery, follow instructions in “Operating the Engine” section.



T5204 -UN-23AUG88

To avoid shocks and burns, disconnect battery negative (ground) cable (B) before servicing any part of the electrical system, then remove positive cable (A) if removing battery.

Keep all electrical shields in place.

A—Positive (+) Battery Cable
B—Negative (−) Battery Cable

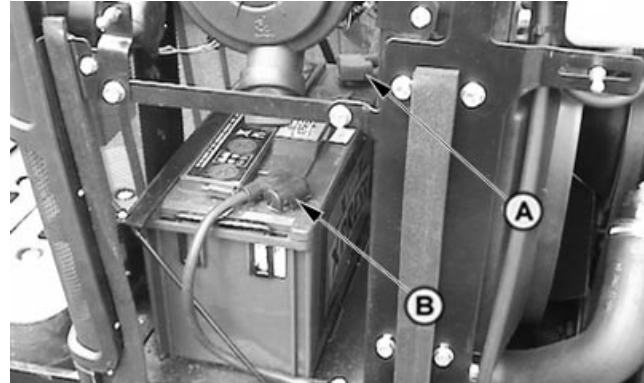

PY4102 -UN-10DEC05

PY80265.05GO966 -19-10SEP05-1/1

Battery Access

Battery is located in front of the radiator.

To gain access:

1. Raise the hood.
2. Pull side screens (A) and remove from slots. (See Removing Side Screens in this section.)

A—Side Screens

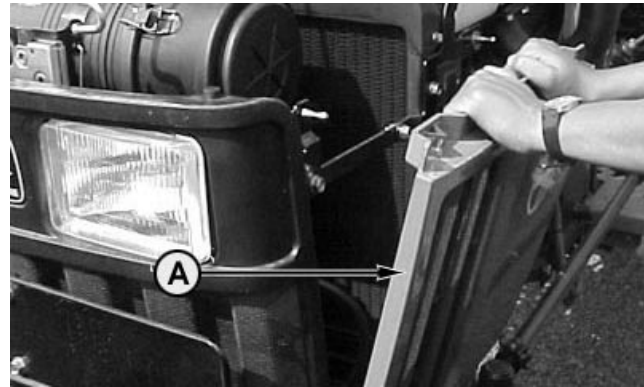

PY1736 -UN-14DEC05

PY80265.05GO967 -19-10SEP05-1/1

Removing Battery

⚠ CAUTION: To avoid sparks, disconnect negative (ground) cable first and connect it last.

1. Remove negative (ground) battery cable (B) and remove the cable connection. Then remove positive cable (A) and connection.

Loosen nuts securing battery hold-down and rotate the holder down, freeing the battery.

2. Lift and slide the battery from the battery tray.

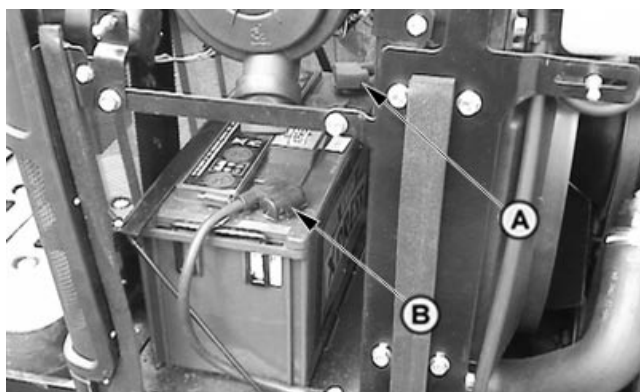

PY4102 -UN-10DEC05

A—Positive (+) Cable Nut
B—Negative (−) Cable Nut

PY80265,05GO968 -19-10SEP05-1/1

Checking Battery Condition



CAUTION: Battery gas can explode. Keep sparks and flames away from batteries. Use a flashlight to check battery electrolyte level.

Never check battery charge by placing a metal object across the posts. Use a voltmeter or hydrometer.

Always remove grounded (—) battery clamp first and replace it last.



TS204 -JUN-23AUG88

1. Use a battery hydrometer to check specific gravity of electrolyte in each cell. Charge battery if reading is below 1.215. Replace battery if difference between cells is more than 0.050 or if battery will not charge above 1.225.
2. Always correct specific gravity reading for electrolyte temperature variation. Add 0.004 to the reading obtained in step one for every 10°F above 80°F (add 0.007 to the reading for every 10° above 27°C). Subtract at same rate if electrolyte temperature is below 80°F (27°C). Corrected specific gravity of a fully charged battery is from 1.265 to 1.280.
3. A battery is considered fully charged when three consecutive hydrometer readings, taken at hourly intervals, show no rise in specific gravity.

PY80265,05GO969 -19-10SEP05-1/1

Servicing Battery

1. Keep battery clean by wiping with a damp cloth. Keep all connections (A and B) clean and tight. To remove any corrosion, wash terminals with a solution of four parts water to one part baking soda.

⚠ CAUTION: To avoid sparks, connect negative (ground) (—) cable last and disconnect it first.

2. Keep battery fully charged, especially during cold weather. If a battery charger is connected, attach a positive cable to the positive battery terminal (A). Connect the negative battery charger lead to a good ground on tractor frame.

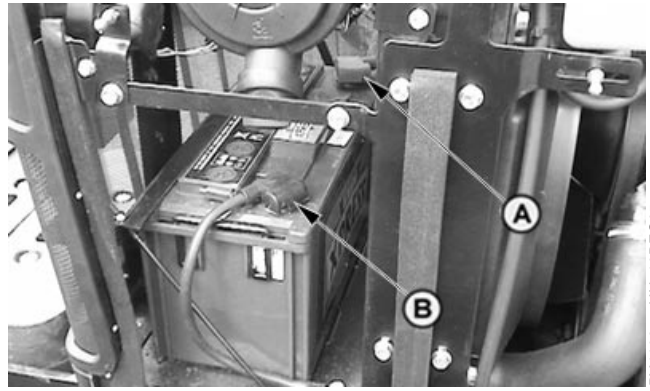

A—Positive (+) Battery Terminal
B—Negative (—) Battery Terminal

Continued on next page

PY80265,05GO970 -19-10SEP05-1/2

PY4102 -UN-10DEC05

CAUTION: Sulfuric acid in battery electrolyte is poisonous. It is strong enough to burn skin, eat holes in clothing, and cause blindness if splashed into eyes.

Avoid the hazard by:

1. Filling batteries in a well-ventilated area.
2. Wearing eye protection and rubber gloves.
3. Avoiding breathing fumes when electrolyte is added.
4. Avoiding spilling or dripping electrolyte.
5. Use proper jump start procedure.

If you spill acid on yourself:

1. Flush your skin with water.
2. Apply baking soda or lime to help neutralize the acid.
3. Flush your eyes with water for 15—30 minutes. Get medical attention immediately.

If acid is swallowed:

1. Do not induce vomiting.
2. Drink large amounts of water or milk, but do not exceed 2 L (2 quarts).
3. Get medical attention immediately.

IMPORTANT: DO NOT add water in freezing weather unless tractor will be run at least 30 minutes to assure thorough mixing.

3. Check level of electrolyte in each cell (A) at least every 250 hours. If low, fill to bottom of filler necks with CLEAN, SOFT water. DO NOT OVERFILL.
4. Coat terminals with a small amount of grease.

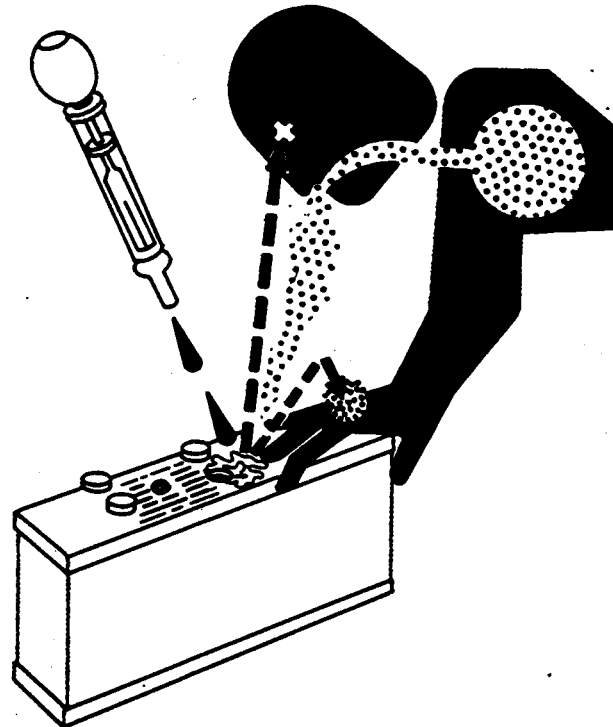

TS203 -UN-23AUG88



PY4164 -UN-28AUG04

A—Battery Cells

PY80265.05GO970 -19-10SEP05-2/2

Charging Battery

Keep battery fully charged, especially during cold weather.

CAUTION: Gas given off by battery is explosive. Keep sparks and flames away from battery. Before connecting or disconnecting a battery charger, turn charger off. Make last connection and disconnection at a point away from battery.

1. With charger off, attach positive battery charger lead to positive (+) battery terminal (A). Attach negative charger lead to tractor frame away from the battery.
2. Turn charger on and recharge the battery following battery manufacturer's instructions for using charger. Check battery condition as described below.
3. To disconnect battery charger, turn charger off. Remove negative charger lead first, follow by positive charger lead.

A—Positive (+) Battery Terminal
 B—Negative (−) Battery Terminal

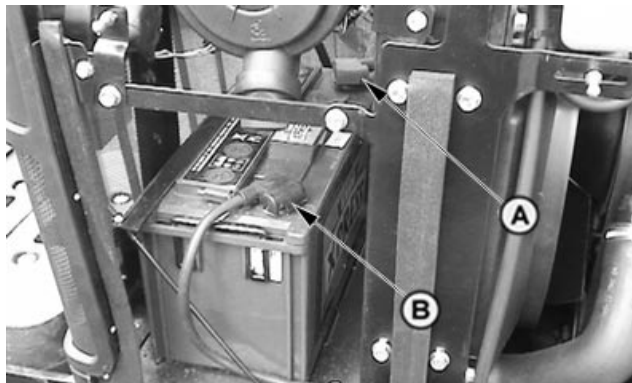

TSS204 -UN-23AUG88

PY4102 -UN-10DEC05

PY80265.05GO971 -19-10SEP05-1/1

Battery Replacement Specifications

When replacing battery, use recommended battery. See your John Deere dealer.

	Specification
Battery—Volts.....	12 Volts
Ampere Rating.....	88 AH
Make	Exide
Model	E88

PY80265.05GO972 -19-10SEP05-1/1

Connecting Starter Wiring

IMPORTANT: Disconnect battery negative (ground) cable before servicing any part of electrical system. Make all other connections before connecting ground cable.

Connect large battery cable (A) and alternator cable to large solenoid post (B). Connect the small white wire (C) to solenoid terminal (D).

- A—Large Battery Cable
- B—Large Solenoid Post
- C—Small White Wire
- D—Solenoid Terminal

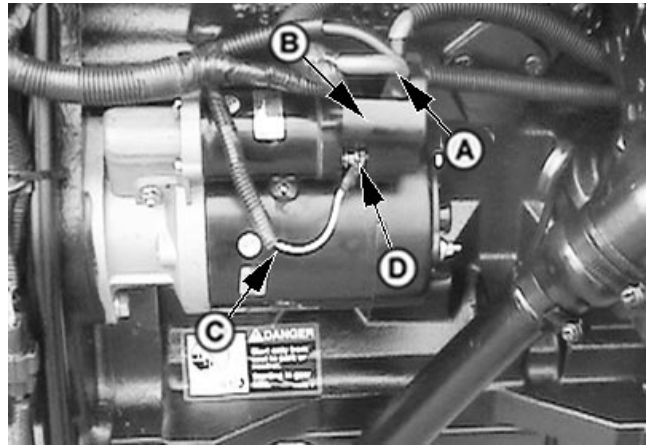

PY4876 -UN-12APR05

PY80265,05GO973 -19-07JUL06-1/1

Connecting Alternator Wiring For (5103E)

IMPORTANT: Disconnect battery negative (ground) cable before servicing any part of electrical system. Make all other connections before connecting ground cable.

To prevent damage to electrical system, disconnect alternator before making any electrical weld repairs. If an attached implement needs weld repair, disconnect it from tractor before welding, to prevent damage to tractor electrical system.

If alternator is disconnected for any reason, connect wires (A), (B) and (C) as shown at right.

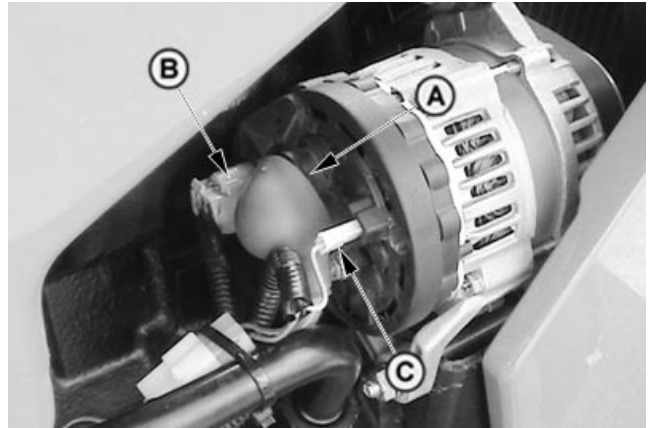

PY4165 -UN-28AUG04

- A—Alternator Wire
- B—Alternator-Battery Charging Indicator Wire
- C—Hourmeter Wire

PY80265,05GO974 -19-10SEP05-1/1

Connecting Alternator Wiring For (5103, 5103S, 5203)

IMPORTANT: Disconnect battery negative (ground) cable before servicing any part of electrical system. Make all other connections before connecting ground cable.

To prevent damage to electrical system, disconnect alternator before making any electrical weld repairs. If an attached implement needs weld repair, disconnect it from tractor before welding, to prevent damage to tractor electrical system.

If alternator is disconnected for any reason, connect wires (A) and (B) as shown at right.

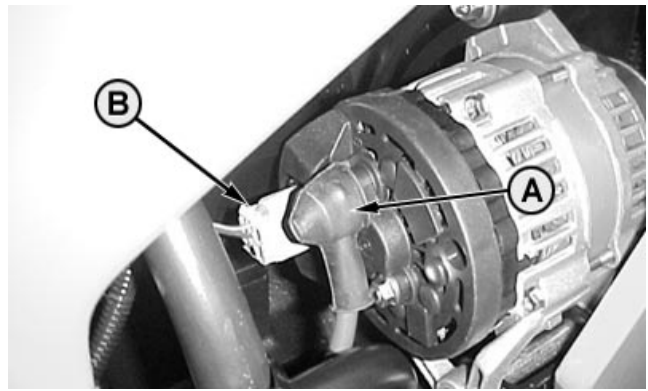

A—Alternator Wire
B—Alternator-Battery Charging Indicator Wire

PY1658 -UN-15DEC06

PY80265.05GO975 -19-10SEP05-1/1

Locating Fusible Link

Electrical circuits are protected by fusible link(s).

Fusible link (A) is located under hood on right-hand side of tractor, above fuel filter.

A—Fusible Link

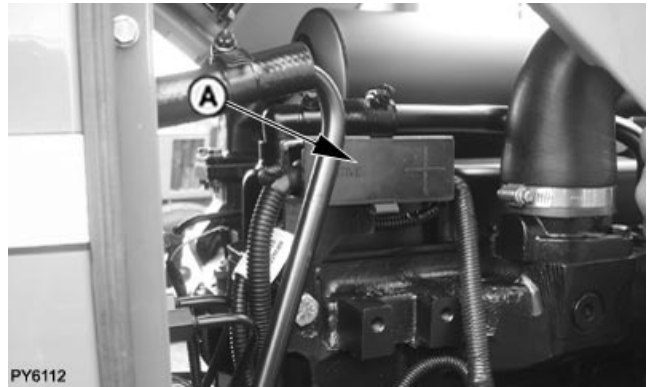

PY6112

PY6112 -UN-07AUG06

NR25796.000035A -19-07AUG06-1/1

Locating Fuses

All electrical circuits are protected by fuses. Amperage rating is marked on each fuse, plus fuses are color coded to ensure proper replacement.

To access fuse panel (A), remove four cap screws to lower fuse panel cover.

Fuse Rating	Color
10 Amp	Red
20 Amp	Yellow
30 Amp	Green

IMPORTANT: DO NOT replace original fuse with higher rated fuse or machine damage may occur. If original size fuse will not carry electrical load and continues to blow, have the electrical system checked by your John Deere dealer.

A—Fuse Panel

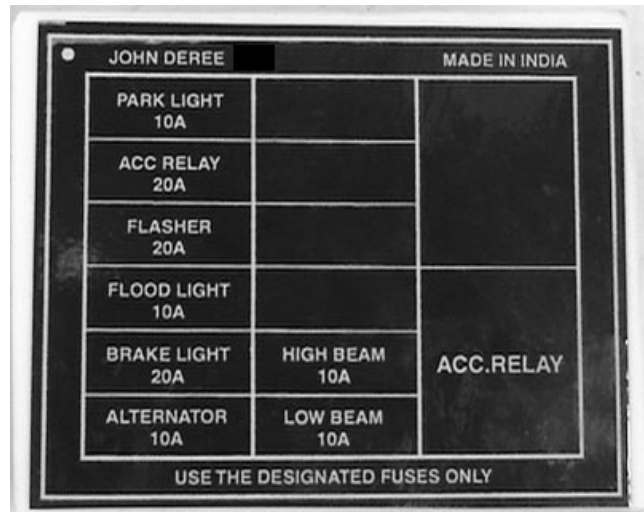

For 5103, 5103S, 5203, 5104 and 5204 Tractor

PY5163 -UN-23AUG05

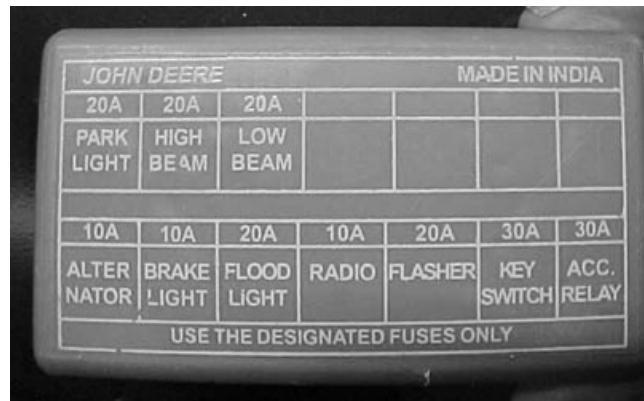

For 5103E Tractor

PY5164 -UN-23AUG05

PY80265,05GO977 -19-29DEC06-1/1

Fuse Size and Function

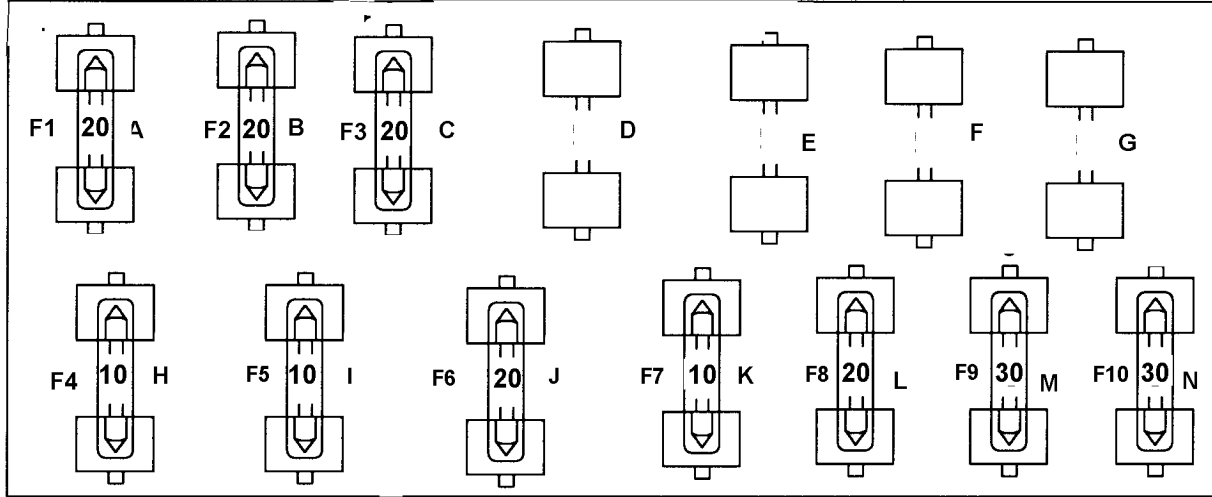

For 5103, 5103S, 5203, 5104 and 5204 Tractor

- | | | | |
|--------------------------|----------------------|------------------|--------------------------|
| A—20 amp—Park Light | H—10 amp—Alternator | K—10 amp—Radio | M—30 amp—Key switch |
| B—20 amp—High Beam Light | I—10 amp—Brake Light | L—20 amp—Flasher | N—30 amp—Accessory Relay |
| C—20 amp—Low Beam Light | J—20 amp—Flood Light | | |

PY80265,05GO978 -19-29DEC06-1/1

PY1674 -UN-30OCT03

Fuse Size and Function (5103E Tractor)

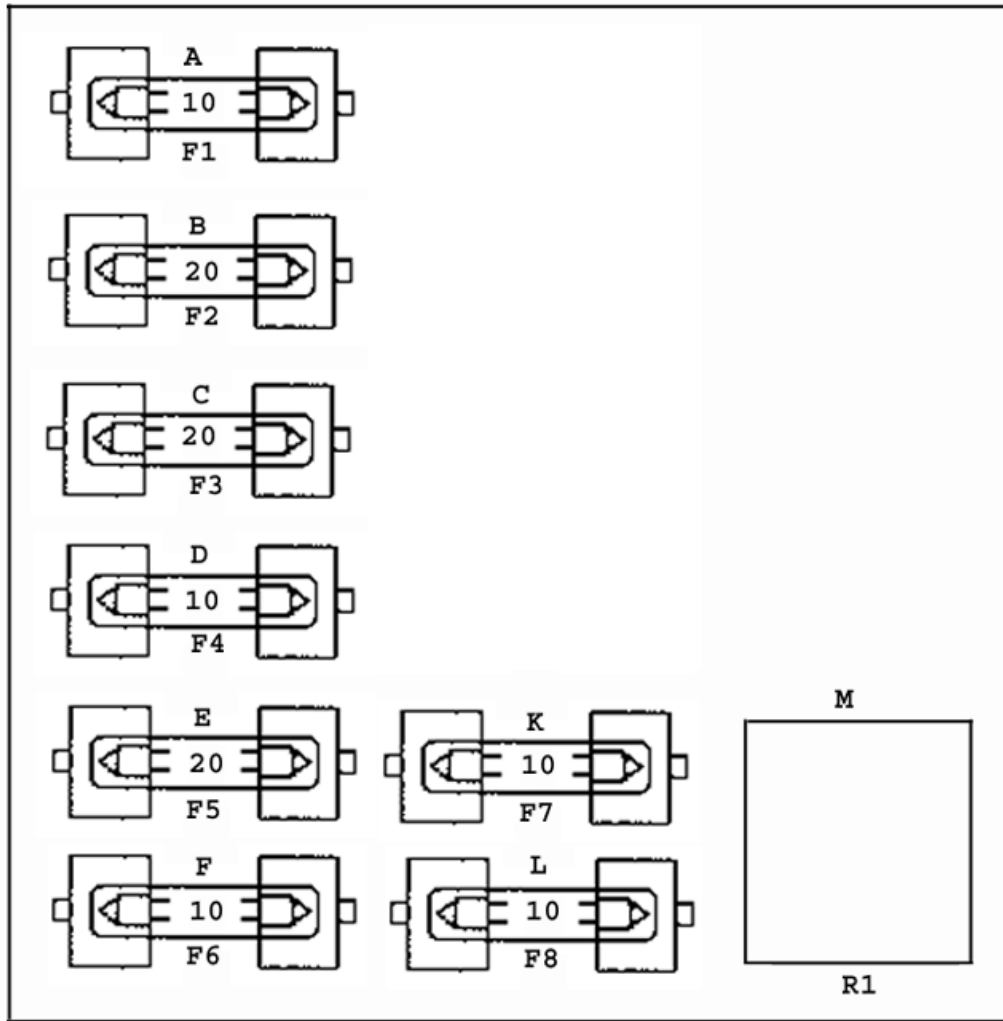

PY4118 -UN-27AUG04

For 5103E Tractor

- | | | | |
|--------------------------|----------------------|--------------------------|-------------------------|
| A—10 amp—Park Light | D—10 amp—Flood Light | F—10 amp—Alternator | L—10 amp—Low Beam Light |
| B—20 amp—Accessory Relay | E—20 amp—Brake Light | K—10 amp—High Beam Light | M—Relay R1 |
| C—20 amp—Flasher | | | |

PY80265,05GO979 -19-10SEP05-1/1

Aiming Headlights

1. Park tractor on level ground, with lights 8 m (25 ft) from a wall.
2. Measure from top of hood to the ground (A). Place a strip of masking tape (B) on the wall at the same height.
3. Place a piece of tape, folded in the middle to make a point, on the top front center of the hood.
4. Using the hood tape as a guide, sight across steering wheel and hood to locate tractor centerline. Mark tractor centerline (C) on wall.
5. From tractor centerline (C), mark a point 130 mm (5 in.) out in each direction (D). This mark locates a point directly in front of center of each headlight.
6. Turn light switch to dim position.
7. Locate small zone of bright light projected by each lamp. Cover other lamps if necessary. Top of zone (E) should be 130 mm (5 in.) below the tape. Left edge of zone (F) should be 130 mm (5 in.) left of lamp location marked (D).
8. To adjust headlights, see Adjusting Headlights in this section.

- A—Hood-to-Ground Distance
- B—Masking Tape
- C—Tractor Centerline
- D—Center of Headlight
- E—Top of Zone
- F—Left Edge of Zone

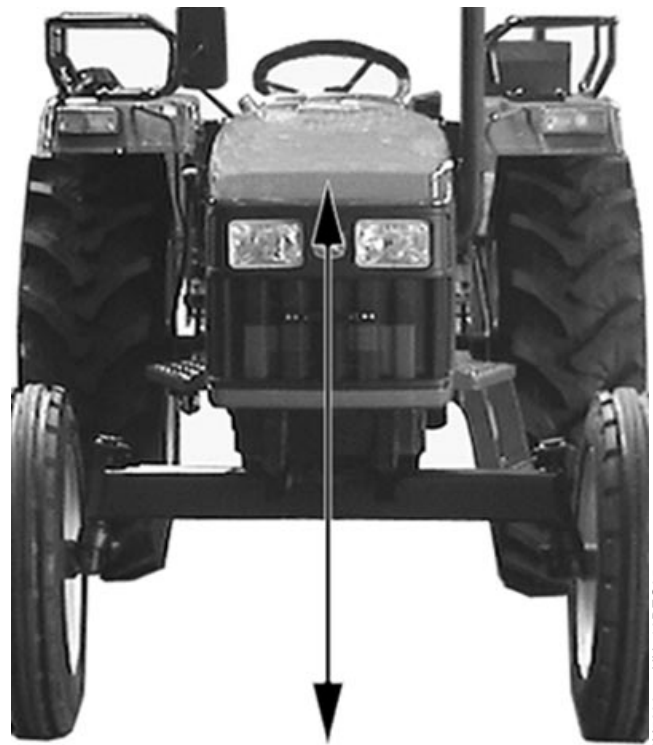

PY6290 -UN-12DEC05

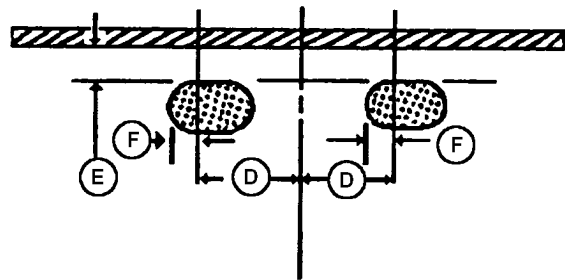
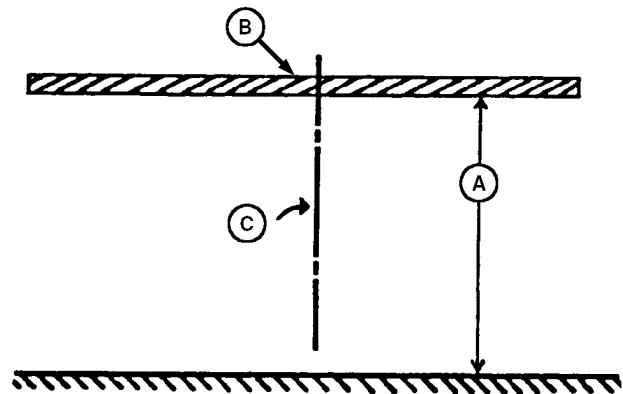

LV3020 -UN-10JUN99

Adjusting Headlights

1. Open the hood.
2. Turn screws (A—C) counterclockwise to lower beam or clockwise to raise beam.
3. To adjust beam in toward center of tractor, turn screw (A) counterclockwise and screws (B and C) clockwise an equal number of turns on each screw.
4. To adjust beam out from center of tractor, turn screws (B and C) counterclockwise and screw (A) clockwise an equal number of turns on each screw.

NOTE: Clips (D) need not be removed for adjustment.

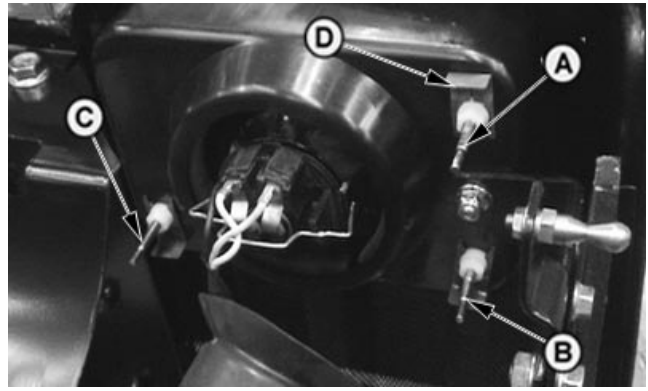

A—Headlight Mounting Screw
B—Headlight Mounting Screw
C—Headlight Mounting Screw
D—Clips

PY4104 -UN-12DEC05

PY80265,05GO981 -19-10SEP05-1/1

Replace Headlight Bulb

1. Remove headlight connector (A).
2. Remove dust boot (B).
3. Remove bulb (D).

CAUTION: A halogen bulb is pressurized and may shatter. Protect bulb against abrasions and scratches.

To guard against personal injury, wear protective eyeglasses and clothing when handling bulb. Turn power off when installing and before removing bulb. Dispose of bulb with care.

Allow bulb to cool before removing.

Read and follow all bulb manufacturers installation instructions.

4. Install bulb, collar, seal and connector in reverse order.

A—Headlight Connector
B—Dust Boot
C—Collar
D—Bulb

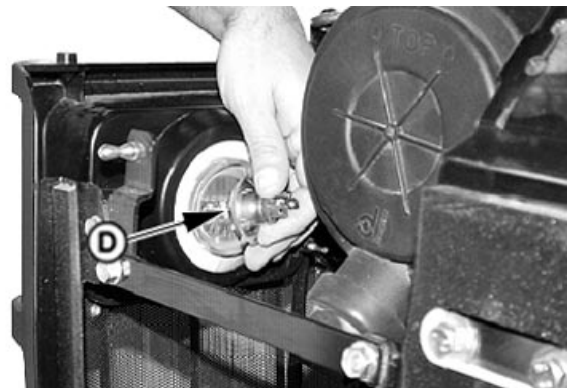
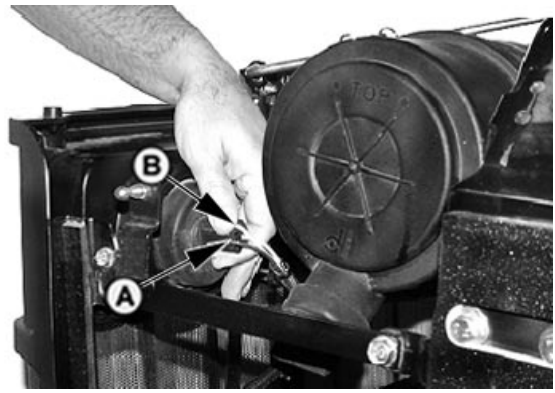

PY80265,05GO982 -19-10SEP05-1/1

Replace Tail Light and Warning Light Bulbs

1. Remove screws (A).
2. Remove lens.
3. Push and twist to release bulb from socket.
4. Reverse this procedure to reassemble light.

A— Cap Screws (4 used)

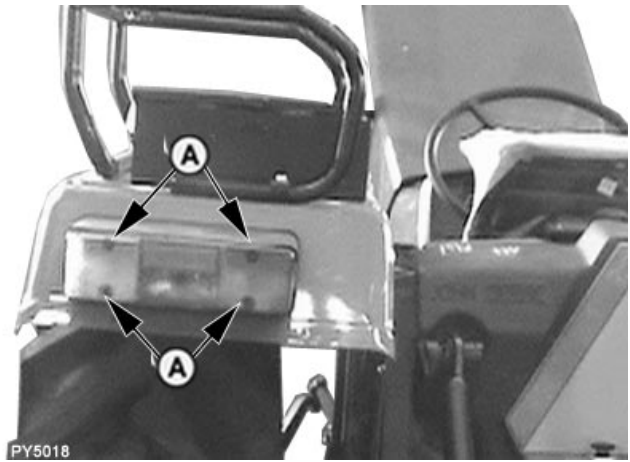

For 5103, 5103S, 5203, 5104 and 5204 Tractor

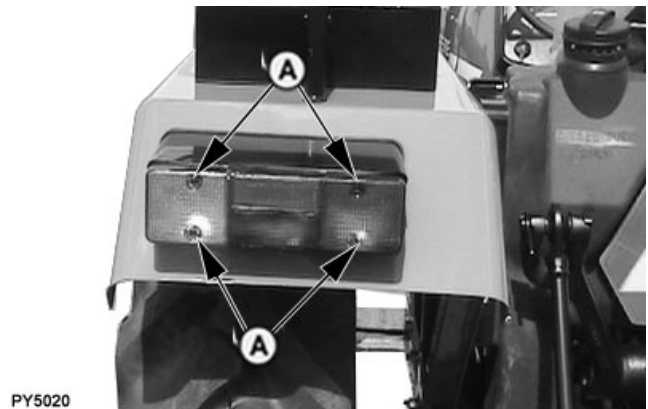

For 5103E Tractor

PY80265,05GO983 -19-29DEC06-1/1

Replace Flood Lamp Bulb

1. Loosen mounting hardware (A) and rotate flood lamp up to access cover fastening screw.
2. Remove screw, lamp cover and lamp from housing.
3. Disconnect wiring leads from bulb.
4. Rotate bulb counterclockwise and remove.
5. Reverse the procedure to reassemble the flood lamp.

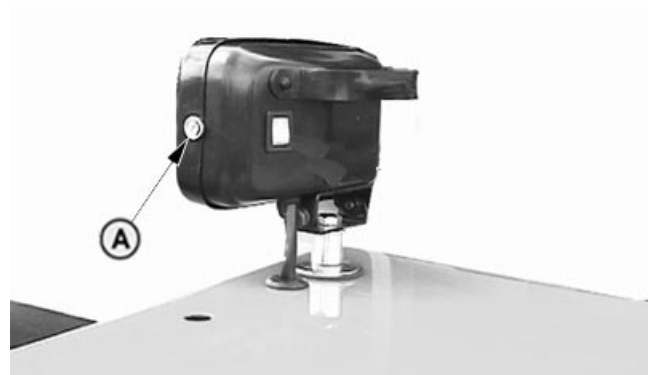

PY80265,05GO984 -19-29DEC06-1/1

Checking Tyres

1. Check tyres daily for damage or noticeably low pressure.
2. Have any cuts or breaks repaired as soon as possible.
3. Protect tyres from exposure to sunlight, petroleum products and chemicals.
4. Drive carefully. Try to avoid rocks and sharp objects.

IMPORTANT: Minimum pressures may be used only for light loads and only if

tractor has no added weight. If you install ballast or mounted implements, or if you pull heavy loads, increase pressure.

5. At least every 100 hours of operation, check tyres with an accurate gauge having 10 kPa (0.1 bar) (1 psi) graduations. If tyres contain liquid ballast, use a special air-water gauge and measure with valve stem at bottom.

Refer to Tyre Inflation Pressure Chart in Wheels, Tyres and Treads section.

PY80265,05GO985 -19-10SEP05-1/1

Troubleshooting

Engine Troubleshooting

Symptom	Problem	Solution
Engine hard to start or will not start	Improper starting procedure.	Reviewing starting procedure.
	No fuel.	Check fuel tank.
	Air in fuel tank.	Bleed fuel tank.
	Hand primer left raised.	Push primer down.
	Slow starter speed.	See "Starter Cranks Slowly".
	Crankcase oil too heavy.	Use oil of proper viscosity.
	Improper type of fuel.	Consult fuel supplier; use proper type fuel for operating conditions.
	Water, dirt, or air in fuel system.	Drain, flush, fill and bleed system.
	Clogged fuel filter.	Replace filter element.
	Dirty or faulty injectors.	Have John Deere dealer check injectors.
Engine knocks	Fuel shut-off valve closed.	Open fuel shut-off valve.
	Insufficient oil.	Add oil.
	Injection pump out of time.	See your John Deere dealer.
	Low coolant temperature.	See your John Deere dealer.
Engine runs irregularly or stalls frequently	Engine overheating.	See "Engine Overheats".
	Low coolant temperature.	See your John Deere dealer.
	Clogged fuel filter.	Replace filter element.
	Water, dirt, or air in fuel system.	Drain, flush, fill, and bleed system.
	Dirty or faulty injectors.	Have John Deere dealer check injectors.
Improper type of fuel.	Use proper fuel.	

Continued on next page

PY80265.05GO986 -19-10SEP05-1/4

Symptom	Problem	Solution
Below normal engine temperature	Defective temperature gauge or sender.	Check gauge, sender, and conditions.
	Lack of power	Engine overloaded.
	Low fast idle speed.	See your John Deere dealer.
	Intake air restriction.	Service air cleaner.
	Clogged fuel filter.	Replace filter element.
	Improper type of fuel.	Use proper fuel.
	Overheated engine.	See "Engine Overheats".
	Below normal engine temperature.	See your John Deere dealer.
	Improper valve clearance.	See your John Deere dealer.
	Dirty or faulty injectors.	Have John Deere dealer check injectors.
	Injection pump out of time.	See your John Deere dealer.
	Implement improperly adjusted.	See implement operator's manual.
	Restricted fuel line.	See your John Deere dealer.
	Restricted return line.	See your John Deere dealer.
	Improper ballast.	Adjust ballast to load.
Low oil pressure	Low oil level.	Add oil.
	Improper type of oil.	Drain, fill crankcase with oil of proper viscosity and quality.
High oil consumption	Crankcase oil too light.	Use proper viscosity oil.
	Oil leaks.	Check for leaks in lines, around gaskets and drain plugs.
	Restricted crankcase vent tube.	Clean vent tube.

Continued on next page

PY80265.05GO986 -19-10SEP05-2/4

Symptom	Problem	Solution
Engine emits white smoke	Improper type fuel.	Use proper fuel.
	Low engine temperature.	Warm up engine to normal operating temperature.
	Defective thermostat.	See your John Deere dealer.
	Defective injection nozzles.	See your John Deere dealer.
	Engine out of time.	See your John Deere dealer.
	Cold start advance or light load advance not functioning.	See your John Deere dealer.
Engine emits black or gray exhaust smoke	Improper type of fuel.	Use proper fuel.
	Clogged or dirty air cleaner.	Service air cleaner.
	Engine overloaded.	Reduce load or shift to a low gear.
	Injection nozzles dirty.	See your John Deere dealer.
	Engine out of time.	See your John Deere dealer.
Engine overheats	Dirty radiator core, or grille screens.	Remove all trash.
	Engine overloaded.	Shift to lower gear or reduce load.
	Low engine oil level.	Check oil level. Add oil as required.
	Low coolant level.	Fill radiator to proper level, check radiator, and hoses for loose connection or leaks.
	Faulty radiator cap.	Replace cap.
	Loose or defective fan belt(s).	Adjust belt tension(s).
	Cooling system needs flushing.	Flush cooling system.
	Defective thermostat.	See your John Deere dealer.
	Defective temperature gauge or sender.	See your John Deere dealer.
	Incorrect grade of fuel.	Use proper fuel.

Continued on next page

PY80265.05GO986 -19-10SEP05-3/4

Symptom	Problem	Solution
High fuel consumption.	Improper type of fuel.	Use proper fuel.
	Clogged or dirty air cleaner.	Service air cleaner.
	Engine overloaded.	Reduce load or shift to a lower gear.
	Improper valve clearance.	See your John Deere dealer.
	Injection nozzles dirty.	See your John Deere dealer.
	Engine out of time.	See your John Deere dealer.
	Implement improperly adjusted.	See implement operator's manual.
	Low engine temperature.	See your John Deere dealer.
	Excessive ballast.	Adjust ballast to load.
	Restricted air intake system.	Check system.
	Plugged crankcase vent tube.	Clean vent tube.

PY80265.05GO986 -19-10SEP05-4/4

Transmission Troubleshooting

Symptom	Problem	Solution
Transmission oil overheats	Low oil supply.	Fill system with correct oil.
	Clogged transmission-hydraulic oil filter.	Replace filter.
	Internal hydraulic leak.	See your John Deere dealer.
	Hitch feedback linkage improperly adjusted.	Reset linkage. See your John Deere dealer.
	Hydraulic motor not plumbed correctly.	See your John Deere dealer.
Low transmission pressure.	Low oil supply.	Fill system with correct oil.
	Clogged transmission-hydraulic oil filter.	Replace filter.

PY80265.05GO987 -19-10SEP05-1/1

Hydraulic System Troubleshooting

Symptom	Problem	Solution
Entire hydraulic system fails to function	Low oil supply.	Fill system with correct oil.
	Clogged transmission-hydraulic filter.	Replace filter.
	Clogged transmission-hydraulic pickup screen.	Clean pickup screen.
	High-pressure internal leak.	See your John Deere dealer.
Hydraulic oil overheats	Low oil supply.	Fill system with correct oil.
	Clogged transmission-hydraulic oil filter.	Replace filter.
	Internal hydraulic leak.	See your John Deere dealer.
	Hitch feedback linkage improperly adjusted.	Reset linkage. See your John Deere dealer.
	Hydraulic motor not plumbed correctly.	See your John Deere dealer.

PY80265.05GO988 -19-10SEP05-1/1

Brakes Troubleshooting

Symptom	Problem	Solution
No solid pedal feel	Pedals adjusted incorrectly.	See your John Deere dealer.
Excessive pedal travel	Pedals adjusted incorrectly.	See your John Deere dealer.
Brakes drag during transport	Brakes out of adjustment.	See your John Deere dealer.

PY80265.05GO989 -19-10SEP05-1/1

Rockshaft and 3-Point Hitch Troubleshooting

Symptom	Problem	Solution
Insufficient transport clearance	Center link too long.	Adjust center link.
	Lift links too long.	Adjust lift links.
	Implement not level.	Level implement.
	Implement not properly adjusted.	See implement operator's manual.
	Front of center link in upper holes.	Move center link to lower holes.
	Sway chains adjusted to short.	Lengthen sway chains.
Hitch drops slowly	Rockshaft rate-of-drop control not properly set.	Adjust rate-of-drop knob.
Hitch fails to lift or lifts slowly	Excessive load on hitch.	Reduce load.
	Low oil level.	Fill system with proper oil.
	Hydraulic oil too cold.	Allow oil to warm.
	Transmission-hydraulic oil filter clogged.	Replace filter.
	Transmission-hydraulic pickup screen clogged.	Clean or replace pickup screen.
Implement will not operate at desired depth	Lift links too short.	Adjust lift links.
	Lack of penetration.	See implement operator's manual.
	Improper setting of limit stop.	Reset position limit.
	Improper setting of draft lever.	See Rockshaft and 3-Point Hitch section.

Continued on next page

PY80265,05GO990 -19-10SEP05-1/2

Symptom	Problem	Solution
Insufficient or no hitch response to draft load	Front attachment of center link in upper holes.	Move center link attachment to lower bracket holes.
	Draft control lever in "Off" position.	Move lever rearward.
	Lift links too short.	Adjust lift links.
	Lack of penetration.	See implement operator's manual.
	Rate-of-drop too slow.	Adjust rate-of-drop valve.
Hitch too responsive	Front attachment on center link in lower bracket holes.	Move center link attachment to upper bracket holes.
	Improper draft sensing adjustment.	Move lever forward.
Hitch drops too fast	Rate-of-drop set too fast.	Adjust rate-of-drop.
Rockshaft control levers "drift". Levers too loose.	Friction disks are loose.	Adjust rockshaft control lever friction. See procedures in "Rockshaft and 3-Point Hitch" section or see your John Deere dealer.

PY80265.05GO990 -19-10SEP05-2/2

Electrical System Troubleshooting

Symptom	Problem	Solution
Battery will not charge	Loose or corroded connections.	Clean and tighten connections.
	Sulfated or worn-out battery.	Check electrolyte level and specific gravity.
	Loose or defective alternator/fan belt.	Adjust belt tension or replace belt.
Charging system indicator glows with engine running	Low engine speed.	Increase speed.
	Defective battery.	Check electrolyte level and specific gravity.
	Defective alternator.	See your John Deere dealer.
	Slipping alternator/fan belt.	Adjust belt tension.
Starter inoperative	Range shift lever in gear.	Move lever to neutral.
	PTO lever in engaged position.	Move PTO lever to disengaged position.
	Low battery output.	See your John Deere dealer.
	Blown fuse.	Replace fuse.
Starter cranks slowly	Low battery output.	Check electrolyte level and specific gravity.
	Crankcase oil too heavy.	Use proper viscosity oil.
	Loose or corroded connections.	Clean and tighten loose connections.
Light system does not function; rest of electrical system functions	Blown fuse.	Replace fuse.

Continued on next page

PY80265,05GO991 -19-10SEP05-1/2

Troubleshooting

Symptom	Problem	Solution
Entire electrical system does not function	Faulty battery connections.	Clean and tighten connections.
	Sulfated or worn-out battery.	Check electrolyte level and specific gravity.
	Blown fuse.	Replace fuse.
Relay(s) sticking or nonfunctional; repeated failures	Diode to protect circuit from arcing has failed.	See your John Deere dealer.

PY80265,05GO991 -19-10SEP05-2/2

Tractor Storage

Storing Tractor

IMPORTANT: Any time tractor will not be used for several months, use this procedure to minimize corrosion and deterioration.

1. Service air cleaner (A). (See Servicing Air Cleaner in Service section.)
2. If coolant has been in tractor for two years, flush cooling system (B). (See Flushing Cooling System in Service section.) Add 50 percent antifreeze water mixture. Test coolant for adequate cold weather protection.
3. Change engine oil and filter (D). (See Change Engine Oil and Filter in Service—250 Hours section.)
4. Drain fuel and add back 4 L of fuel. Then add 0.4 L of corrosion inhibitor.
5. Add 0.25 L of corrosion inhibitor to transmission-hydraulic system fill port (E).
6. Depress clutch and start engine. Run engine until it reaches operating temperature. Also raise and lower rockshaft several times. Shut off engine.

A—Air Cleaner
B—Cooling System
C—Engine Oil Drain Plug
D—Engine Oil Filter
E—Transmission-Hydraulic Oil Filler Cap

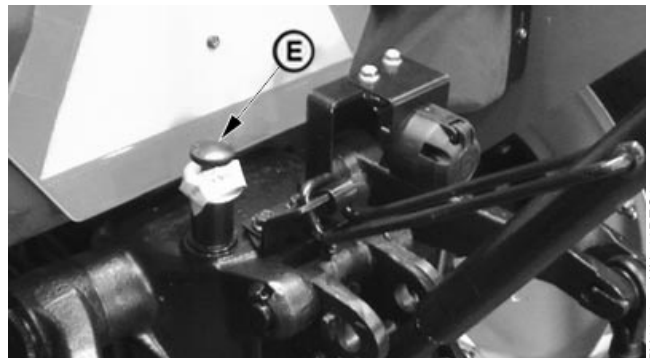
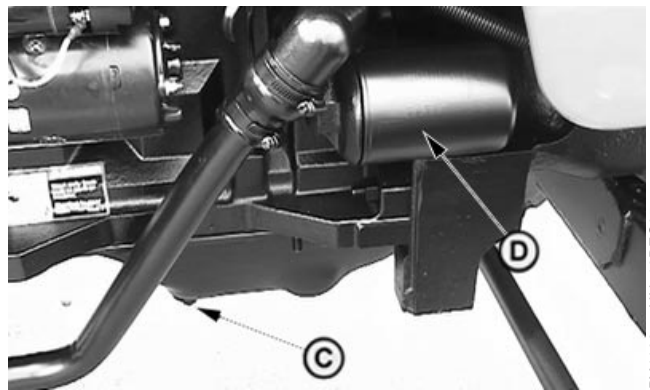
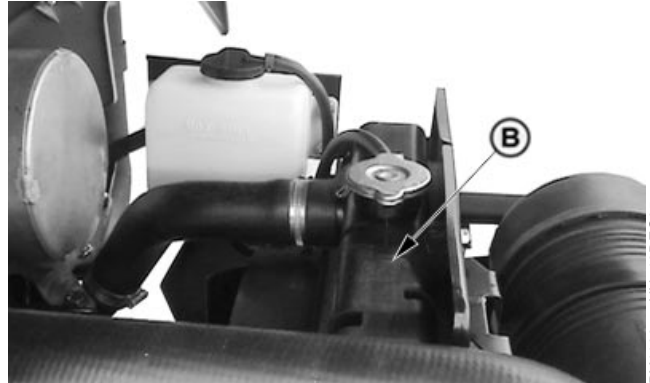
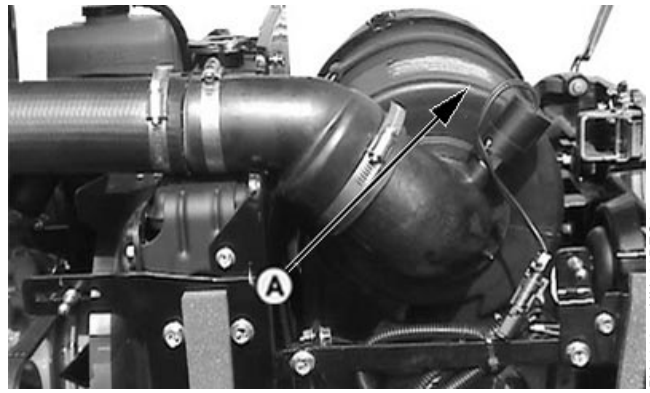

Continued on next page

PY80265,05GO992 -19-29DEC06-1/3

7. Add 0.5 L more inhibitor to fuel tank at either filler cap (A).
8. Add 0.5 L inhibitor to engine crankcase at filler (B).
9. Remove air intake hose at manifold. Pour 0.1 L inhibitor into manifold and replace hose. Pull hand throttle back to slow idle position. Crank engine only a few revolutions.
10. Loosen alternator/fan belt after they have cooled.
11. Remove and clean battery. Store in a cool, dry place. Keep it charged.¹
12. Tie or block clutch pedal in the disengaged position.
13. Coat exposed metal surfaces, such as adjustable front axles, if extended, with grease or a corrosion inhibitor.

A—Fuel Tank Filler Cap
B—Engine Oil Filler Cap

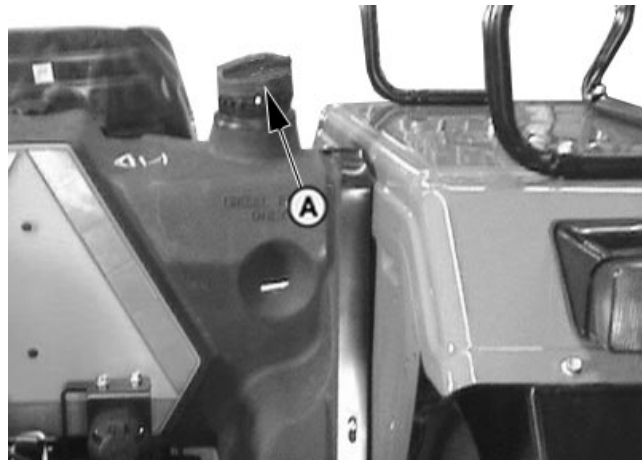

For 5103, 5103S, 5203, 5104 and 5204 Tractor

PY5027 -UN-27MAY05



For 5103E Tractor

PY4101 -UN-20AUG04

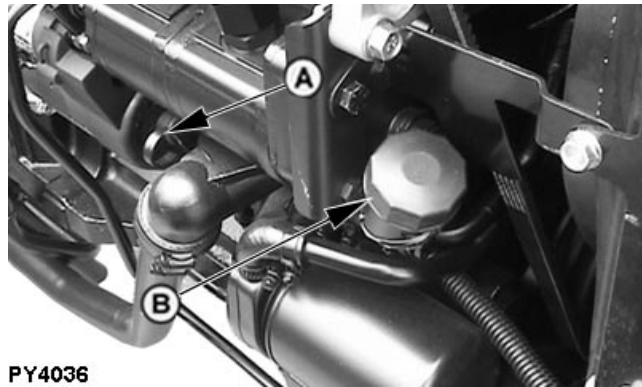

PY4036

PY4036 -UN-19JUN06

¹Disconnect battery ground cable for short-term storage periods (20 to 90 days).

Continued on next page

PY80265,05GO992 -19-29DEC06-2/3

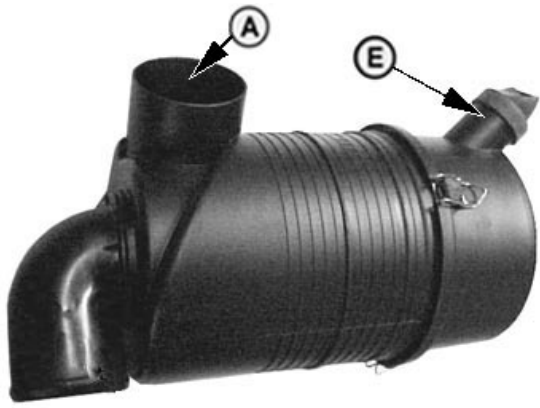

PY5004 -UN-21MAY05

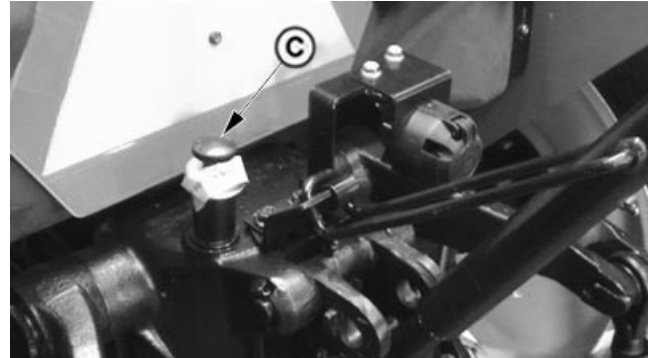
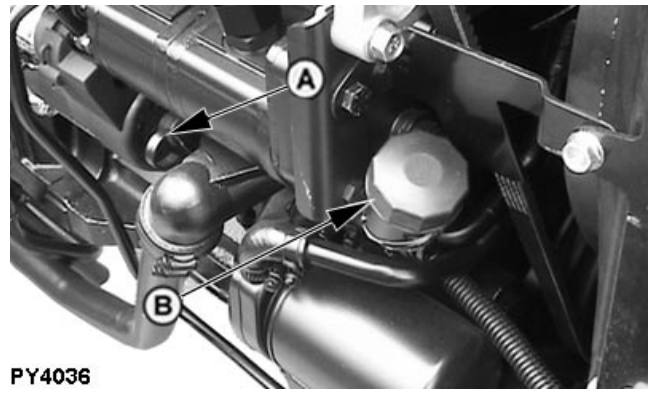

14. Use tape to seal air inlet hole (A), dust unloader valve (E), exhaust pipe, crankcase filler (B), fuel caps, and transmission-hydraulic system filler cap (C).
15. Cover dash with opaque material to prevent gauges from fading.
16. Raise tyres off ground. Protect them from heat and sunlight.
17. Thoroughly clean tractor. Touch up any painted surfaces that are scratched or chipped.
18. If tractor must be stored outside, cover it with a waterproof material.

- A—Air Cleaner Inlet Hole
- B—Engine Oil Filler Cap
- C—Transmission-Hydraulic Oil Filler Cap
- E—Dust Unloader Valve

PY80265.05GO992 -19-29DEC06-3/3

Removing Tractor From Storage

1. Check tyre inflation pressure. (See Wheels, Tyres and Treads section.) Lower tyres to ground.
2. Unseal all openings sealed in "Storing Tractor".
3. Install battery.
4. Remove ties or block which secured clutch pedal down.
5. Check levels of engine oil, transmission-hydraulic oil, and engine coolant, Add if necessary.
6. Drain a small amount of fuel from fuel tank to purge any moisture condensation that has collected.
7. Fill fuel tank.
8. Perform all appropriate 10-hour, 50-hour, 250-hour, and 600-hour services as instructed in Lubrication and Maintenance section.
9. Check all instruments and indicators by turning key switch to ON position.

PY80265,05GO993 -19-10SEP05-1/2

IMPORTANT: DO NOT operate starter more than 20 seconds at a time, and wait at least two minutes for starter to cool before trying again.

10. Pull hand throttle (A) all the way down, depress clutch pedal, and crank engine until oil pressure rises.
11. Connect wiring lead to fuel injection pump shut-off solenoid.
12. Depress clutch pedal and start engine. Operate engine at slow idle for several minutes. Warm up carefully and check all systems before placing tractor under load.



A—Hand Throttle

PY4485 -UN-16FEB06

PY80265,05GO993 -19-10SEP05-2/2

Specifications

John Deere 5103E Tractor

5103E—3029D Naturally Aspirated Engine

Observed PTO power	24.4 kW (33.2 PS)
Max. engine torque	128 N.m
Cylinders	3
Bore	106.5 mm
Stroke	110 mm
Displacement	2.9 L
Compression ratio	17.8:1
Firing order	1-2-3
Slow idle	850±25
Fast idle	2485±25
Operating range	1400-2300
Injection pump timing	15.5 ± 1° BTDC

Electrical

Battery	12 V, 88 Ah
Alternator	43Amp
Starter	12 V, 2.5 kW

Transmission

Clutch type	Single
Gearbox type	Collar Shift
No. of forward gears	8
No. of reverse gears	4
PTO speed	540 rpm

Brakes

Type	Wet disc brakes
Actuation	Mechanical

Hydraulics

Pump output	25.7 l/min
Lifting capacity	1100 kgf

Wheels and Tyres

Front tyre	6.0 x 16, 8 PR
Rear tyre	12.4 x 28, 12 PR

Dimensions and Weight

Total weight	1790 kg
Wheel base	1950 mm
Overall length	4080 mm
Overall width	1650 mm
Overall height (with exhaust pipe)	2205 mm
Ground clearance	365 mm
Turning radius w. brake	2840 mm
Turning radius w/o brake	3210 mm

Filling capacities

Fuel tank	50 lit
Engine sump	8.5 lit
Transmission	33 lit
Hydraulics	Common to transmission

PY80265,05GO994 -19-10SEP05-1/1

John Deere 5103 Tractor

5103—3029D Naturally Aspirated Engine

Observed PTO power	24.4 kW (33.2 PS)
Max. engine torque	139 N.m
Cylinders	3
Bore	106.5 mm
Stroke	110 mm
Displacement	2.9 L
Compression ratio	17.8:1
Firing order	1-2-3
Slow idle	850±25
Fast idle	2485±25
Operating range	1400-2300
Injection pump timing	15.5 ±1° BTDC

Electrical

Battery	12 V, 88 Ah
Alternator	43 Amp
Starter	12 V, 2.5 kW

Transmission

Clutch type	Single
Gearbox type	Collar Shift
No. of forward gears	8
No. of reverse gears	4
PTO speed	540 rpm

Brakes

Type	Wet disc brakes
Actuation	Mechanical

Hydraulics

Pump output	25.7 l/min
Lifting capacity	1220 kgf

Wheels and Tyres

Front tyre	6.0 x 16, 8 PR
Rear tyre	12.4 x 28, 12 PR

Dimensions and Weight

Total weight	1800 kg
Wheel base	1950 mm
Overall length	3335 mm
Overall width	1650 mm
Overall height (with exhaust pipe)	2205 mm
Ground clearance	365 mm
Turning radius w. brake	2840 mm
Turning radius w/o brake	3210 mm

Filling capacities

Fuel tank	62 lit
Engine sump	8.5 lit
Transmission	33 lit
Hydraulics	Common to transmission

PY80265,05GO995 -19-10SEP05-1/1

John Deere 5103S Tractor

5103S—3029D Naturally Aspirated Engine

Observed PTO power	26.5 kW (36.05 PS)
Max. engine torque	139 N.m
Cylinders	3
Bore	106.5 mm
Stroke	110 mm
Displacement	2.9 L
Compression ratio	17.8:1
Firing order	1-2-3
Slow idle	850±25
Fast idle	2485±25
Operating range	1400-2300
Injection pump timing	15.75 ± 1° BTDC

Electrical

Battery	12 V, 88 Ah
Alternator	43 Amp
Starter	12 V, 2.5 kW

Transmission

Clutch type	single clutch / Dual
Gearbox type	Collar Shift
No. of forward gears	8
No. of reverse gears	4
PTO speed	540 rpm

Brakes

Type	Wet disc brakes
Actuation	Mechanical

Hydraulics

Pump output	25.7 l/min
Lifting capacity	1220 Kgf

Wheels and Tyres

Front tyre	6.0 x 16, 8 PR
Rear tyre	12.4 x 28, 12PR 13.6 x 28, 12PR (Optional)

Dimensions and Weight

Total weight	1810 kg
Wheel base	1950 mm
Overall length	3335 mm
Overall width	1650 mm
Overall height (with exhaust pipe)	2205 mm
Ground clearance	365 mm
Turning radius w. brake	2840 mm
Turning radius w/o brake	3210 mm

Filling capacities

Fuel tank	62 lit
Engine sump	8.5 lit
Transmission	33 lit
Hydraulics	Common to transmission

PY80265,05GO996 -19-15JAN07-1/1

John Deere 5203 Tractor

5203—3029D Naturally Aspirated Engine

Observed PTO power	32.5 kW (44.21 PS)
Max. engine torque	165 N.m
Cylinders	3
Bore	106.5 mm
Stroke	110 mm
Displacement	2.9 L
Compression ratio	17.8:1
Firing order	1-2-3
Slow idle	850±25
Fast idle	2485±25
Operating range	1400-2300
Injection pump timing	15.5 ± 1° BTDC

Electrical

Battery	12 V, 88 Ah
Alternator	43 Amp
Starter	12 V, 2.5 kW

Transmission

Clutch type	Dual (Optional single clutch)
Gearbox type	Collar Shift
No. of forward gears	8
No. of reverse gears	4
PTO speed	540 rpm

Brakes

Type	Wet disc brakes
Actuation	Mechanical

Hydraulics

Pump output	25.7 l/min
Lifting capacity	1550 Kgf

Wheels and Tyres

Front tyre	6.0 x 16, 8 PR
Rear tyre	13.6 x 28, 12 PR 14.9 x 28, 12 PR (optional)

Dimensions and Weight

Total weight	1835 kg
Wheel base	1950 mm
Overall length	3360 mm
Overall width	1790 mm
Overall height (with exhaust pipe)	2215 mm
Ground clearance	420 mm
Turning radius w. brake	2900 mm
Turning radius w/o brake	3220 mm

Filling capacities

Fuel tank	62 lit
Engine sump	8.5 lit
Transmission	33 lit with Rear Tyre Size 13.6 X 28, 12 PR 34 lit with Rear Tyre Size 14.9 X 28, 12PR
Hydraulics	Common to transmission

PY80265,05GO997 -19-17JAN07-1/1

John Deere 5104 Tractor

5104—3029D Naturally Aspirated Engine

Observed PTO power	28.09 kW (38.2 hp)
Max. engine torque	157 N.m
Cylinders	3
Bore	106.5 mm
Stroke	110 mm
Displacement	2.9 L
Compression ratio	17.8:1
Firing order	1-2-3
Slow idle	800 - 875
Fast idle	2475 - 2550
Operating range	1200-2300
Injection pump timing	14.2 ± 1° BTDC

Electrical

Battery	12 V, 88 Ah
Alternator	40 Amp
Starter	12 V, 2.5 kW

Transmission

Clutch type	Single / Dual
Gearbox type	Collar Shift
No. of forward gears	8
No. of reverse gears	4
PTO speed	540 rpm

Brakes

Type	Wet disc brakes
Actuation	Mechanical

Hydraulics

Pump output	46 l/min
Lifting capacity	1400 Kgf

Wheels and Tyres

Front tyre	6.0 x 16, 8 PR
Rear tyre	13.6 x 28, 12 PR

Dimensions and Weight

Total weight	1800 kg
Wheel base	1950 mm
Overall length	3335 mm
Overall width	1650 mm
Overall height (with exhaust pipe)	2205 mm
Ground clearance	365 mm
Turning radius w. brake	2840 mm
Turning radius w/o brake	3210 mm

Filling capacities

Fuel tank	62 lit
Engine sump	8.5 lit
Transmission	33 lit
Hydraulics	Common to transmission

PY80265,00001DA -19-19JAN07-1/1

John Deere 5204 Tractor

5204—3029D Naturally Aspirated Engine

Observed PTO power	31.33 kW (42.6 hp)
Max. engine torque	180.4 N.m
Cylinders	3
Bore	106.5 mm
Stroke	110 mm
Displacement	2.9 L
Compression ratio	17.8:1
Firing order	1-2-3
Slow idle	800 - 875
Fast idle	2475 - 2550
Operating range	1200-2300
Injection pump timing	15.2 ± 1° BTDC

Electrical

Battery	12 V, 88 Ah
Alternator	40 Amp
Starter	12 V, 2.5 kW

Transmission

Clutch type	Single / Dual
Gearbox type	Collar Shift
No. of forward gears	8
No. of reverse gears	4
PTO speed	540 rpm

Brakes

Type	Wet disc brakes
Actuation	Mechanical

Hydraulics

Pump output	25.7 l/min for Manual Steering 46 l/min for Power Steering
Lifting capacity	1550 Kgf

Wheels and Tyres

Front tyre	6.0 x 16, 8 PR
Rear tyre	14.9 x 28, 12 PR

Dimensions and Weight

Total weight	1835 kg
Wheel base	1940 mm
Overall length	3360 mm
Overall width	1790 mm
Overall height (with exhaust pipe)	2215 mm
Ground clearance	420 mm
Turning radius w. brake	2900 mm
Turning radius w/o brake	3220 mm

Filling Capacities

Fuel tank	62 lit
Engine sump	8.5 lit
Transmission	34 lit
Hydraulics	Common to transmission

PY80265,00001D9 -19-17JAN07-1/1

Ground Speed at Rated Engine Speed (2300 rpm)

5103E Tractor (Rear tyre size : 12.4 x 28), (RR - 590 mm)	
Gear	Speed (km/h)
A1	2.80
A2	4.06
A3	6.09
A4	9.96
B1	8.41
B2	12.09
B3	18.18
B4	29.69
R1	3.77
R2	5.32
R3	8.12
R4	13.25

5103S, 5203 and 5104 Tractor (Rear tyre size : 13.6 x 28), (RR - 610 mm)	
Gear	Speed (km/h)
A1	2.9
A2	4.2
A3	6.3
A4	10.3
B1	8.7
B2	12.5
B3	18.8
B4	30.7
R1	3.9
R2	5.5
R3	8.4
R4	13.7

5103 Tractor (Rear tyre size : 12.4 x 28), (RR - 590 mm)	
Gear	Speed (km/h)
A1	2.80
A2	4.06
A3	6.09
A4	9.96
B1	8.41
B2	12.09
B3	18.18
B4	29.69
R1	3.77
R2	5.32
R3	8.12
R4	13.25

5203 and 5204 Tractor (Rear tyre size : 14.9 x 28), (RR - 640 mm)	
Gear	Speed (km/h)
A1	3.06
A2	4.38
A3	6.60
A4	10.80
B1	9.11
B2	13.06
B3	19.67
B4	32.15
R1	4.06
R2	5.82
R3	8.76
R4	14.31

PY80265.05GO998 -19-29DEC06-1/1

Metric Bolt and Cap Screw Torque Values

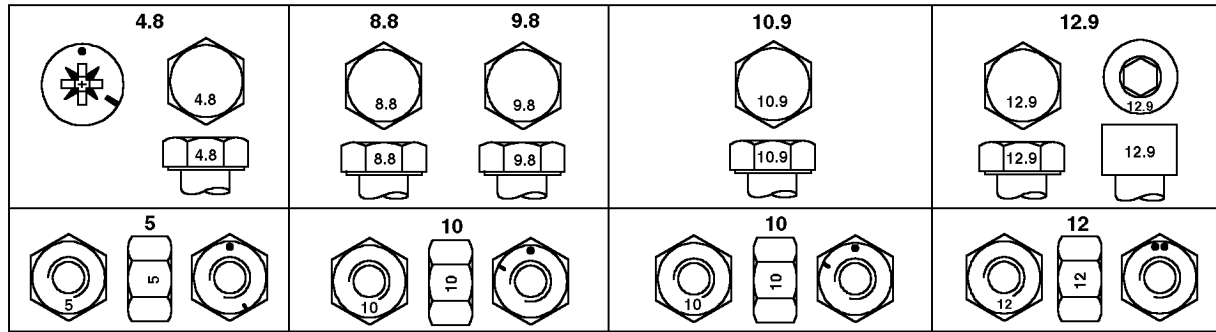

Top, Property Class and Head Markings; Bottom, Property Class and Nut Markings

TORQ2 -UN-07SEP99

Size	Class 4.8		Class 8.8 or 9.8		Class 10.9		Class 12.9	
	Lubricated ^a N•m(lb-ft)	Dry ^b N•m(lb-ft)	Lubricated ^a N•m(lb-ft)	Dry ^b N•m(lb-ft)	Lubricated ^a N•m(lb-ft)	Dry ^b N•m(lb-ft)	Lubricated ^a N•m(lb-ft)	Dry ^b N•m(lb-ft)
M6	4.7 (3.5)	6 (4.4)	9 (6.6)	11.5 (8.5)	13 (9.5)	16.5 (12.2)	15.5 (11.5)	19.5 (14.5)
M8	11.5 (8.5)	14.5 (10.7)	22 (16)	28 (20.5)	32 (23.5)	40 (29.5)	37 (27.5)	47 (35)
M10	23 (17)	29 (21)	43 (32)	55 (40)	63 (46)	80 (59)	75 (55)	95 (70)
M12	40 (29.5)	50 (37)	75 (55)	95 (70)	110 (80)	140 (105)	130 (95)	165 (120)
M14	63 (46)	80 (59)	120 (88)	150 (110)	175 (130)	220 (165)	205 (150)	260 (190)
M16	100 (74)	125 (92)	190 (140)	240 (175)	275 (200)	350 (255)	320 (235)	400 (300)
M18	135 (100)	170 (125)	265 (195)	330 (245)	375 (275)	475 (350)	440 (325)	560 (410)
M20	190 (140)	245 (180)	375 (275)	475 (350)	530 (390)	675 (500)	625 (460)	790 (580)
M22	265 (195)	330 (245)	510 (375)	650 (480)	725 (535)	920 (680)	850 (625)	1080 (800)
M24	330 (245)	425 (315)	650 (480)	820 (600)	920 (680)	1150 (850)	1080 (800)	1350 (1000)
M27	490 (360)	625 (460)	950 (700)	1200 (885)	1350 (1000)	1700 (1250)	1580 (1160)	2000 (1475)
M30	660 (490)	850 (625)	1290 (950)	1630 (1200)	1850 (1350)	2300 (1700)	2140 (1580)	2700 (2000)
M33	900 (665)	1150 (850)	1750 (1300)	2200 (1625)	2500 (1850)	3150 (2325)	2900 (2150)	3700 (2730)
M36	1150 (850)	1450 (1075)	2250 (1650)	2850 (2100)	3200 (2350)	4050 (3000)	3750 (2770)	4750 (3500)

^a "Lubricated" means coated with a lubricant such as engine oil, or fasteners with phosphate and oil coatings.

^b "Dry" means plain or zinc plated without any lubrication.

DO NOT use these values if a different torque value or tightening procedure is given for a specific application. Torque values listed are for general use only. Check tightness of fasteners periodically.

Shear bolts are designed to fail under predetermined loads. Always replace shear bolts with identical property class.

Fasteners should be replaced with the same or higher property class. If higher property class fasteners are used, these should only be tightened to the strength of the original.

Make sure fastener threads are clean and that you properly start thread engagement. This will prevent them from failing when tightening.

Tighten plastic insert or crimped steel-type lock nuts to approximately 50 percent of the dry torque shown in the chart, applied to the nut, not to the bolt head. Tighten toothed or serrated-type lock nuts to the full torque value.

Unified Inch Bolt and Cap Screw Torque Values

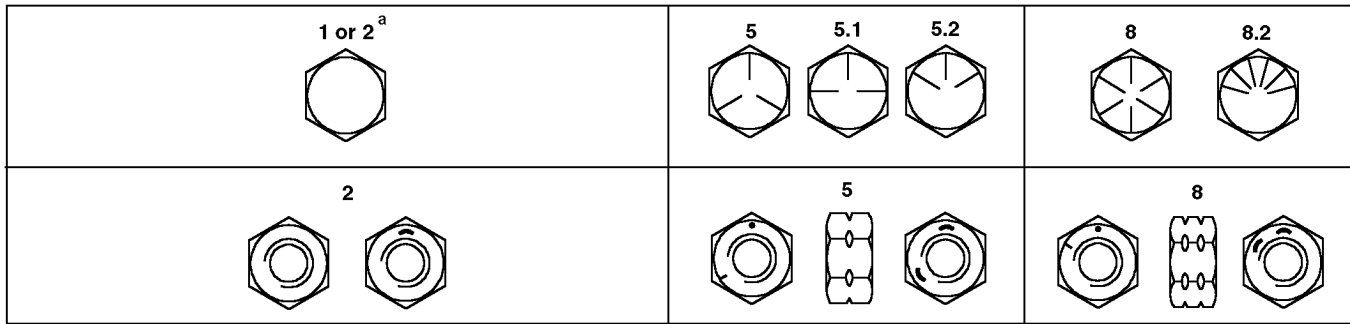

Top, SAE Grade and Head Markings; Bottom, SAE Grade and Nut Markings

TORQ1A -UN-27SEP99

Size	Grade 1 (No Mark)		Grade 2 ^a (No Mark)		Grade 5, 5.1 or 5.2		Grade 8 or 8.2	
	Lubricated ^b N•m(lb-ft)	Dry ^c N•m(lb-ft)	Lubricated ^b N•m(lb-ft)	Dry ^c N•m(lb-ft)	Lubricated ^b N•m(lb-ft)	Dry ^c N•m(lb-ft)	Lubricated ^b N•m(lb-ft)	Dry ^c N•m(lb-ft)
1/4	3.8 (2.8)	4.7 (3.5)	6 (4.4)	7.5 (5.5)	9.5 (7)	12 (9)	13.5 (10)	17 (12.5)
5/16	7.7 (5.7)	9.8 (7.2)	12 (9)	15.5 (11.5)	19.5 (14.5)	25 (18.5)	28 (20.5)	35 (26)
3/8	13.5 (10)	17.5 (13)	22 (16)	27.5 (20)	35 (26)	44 (32.5)	49 (36)	63 (46)
7/16	22 (16)	28 (20.5)	35 (26)	44 (32.5)	56 (41)	70 (52)	80 (59)	100 (74)
1/2	34 (25)	42 (31)	53 (39)	67 (49)	85 (63)	110 (80)	120 (88)	155 (115)
9/16	48 (35.5)	60 (45)	76 (56)	95 (70)	125 (92)	155 (115)	175 (130)	220 (165)
5/8	67 (49)	85 (63)	105 (77)	135 (100)	170 (125)	215 (160)	240 (175)	305 (225)
3/4	120 (88)	150 (110)	190 (140)	240 (175)	300 (220)	380 (280)	425 (315)	540 (400)
7/8	190 (140)	240 (175)	190 (140)	240 (175)	490 (360)	615 (455)	690 (510)	870 (640)
1	285 (210)	360 (265)	285 (210)	360 (265)	730 (540)	920 (680)	1030 (760)	1300 (960)
1-1/8	400 (300)	510 (375)	400 (300)	510 (375)	910 (670)	1150 (850)	1450 (1075)	1850 (1350)
1-1/4	570 (420)	725 (535)	570 (420)	725 (535)	1280 (945)	1630 (1200)	2050 (1500)	2600 (1920)
1-3/8	750 (550)	950 (700)	750 (550)	950 (700)	1700 (1250)	2140 (1580)	2700 (2000)	3400 (2500)
1-1/2	990 (730)	1250 (930)	990 (730)	1250 (930)	2250 (1650)	2850 (2100)	3600 (2650)	4550 (3350)

^a Grade 2 applies for hex cap screws (not hex bolts) up to 6 in. (152 mm) long. Grade 1 applies for hex cap screws over 6 in. (152 mm) long, and for all other types of bolts and screws of any length.

^b "Lubricated" means coated with a lubricant such as engine oil, or fasteners with phosphate and oil coatings.

^c "Dry" means plain or zinc plated without any lubrication.

DO NOT use these values if a different torque value or tightening procedure is given for a specific application. Torque values listed are for general use only. Check tightness of fasteners periodically.

Shear bolts are designed to fail under predetermined loads. Always replace shear bolts with identical grade.

Fasteners should be replaced with the same or higher grade. If higher grade fasteners are used, these should only be tightened to the strength of the original.

Make sure fastener threads are clean and that you properly start thread engagement. This will prevent them from failing when tightening.

Tighten plastic insert or crimped steel-type lock nuts to approximately 50 percent of the dry torque shown in the chart, applied to the nut, not to the bolt head. Tighten toothed or serrated-type lock nuts to the full torque value.

Identification Numbers

Identification Plates

Each tractor has the identification plates shown on these pages. The letters and numbers stamped on the plates identify a component or assembly. ALL these characters are needed when ordering parts or identifying a tractor or component for any John Deere product support program. Also, they are needed for law enforcement to trace your tractor if it is ever stolen. ACCURATELY record these characters in the spaces provided in each of the following photographs.

PY80265,05G1102 -19-10SEP05-1/1

Record Tractor Serial (Chassis) Number

Serial number plate (A) is located on the right front support member of the tractor.



PY5166 -UN-24AUG05

PY80265,05G1103 -19-10SEP05-1/1

Record Front Axle Serial Number

The front-axle serial number plate (A) is located on the right rear side of the axle housing.

Front Axle Serial Number _____

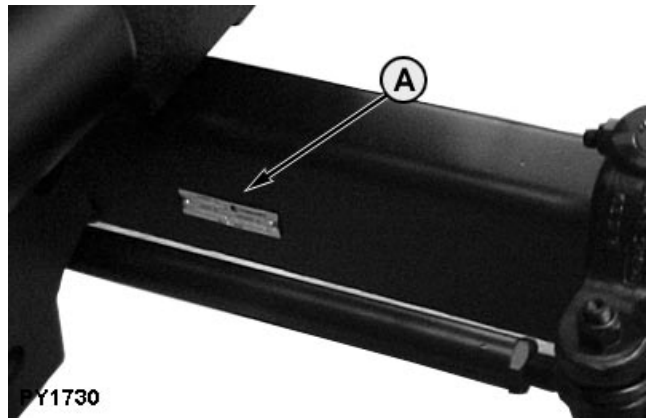

PY1730

CARRARO Front Axle

PY1730 -UN-01JUN06

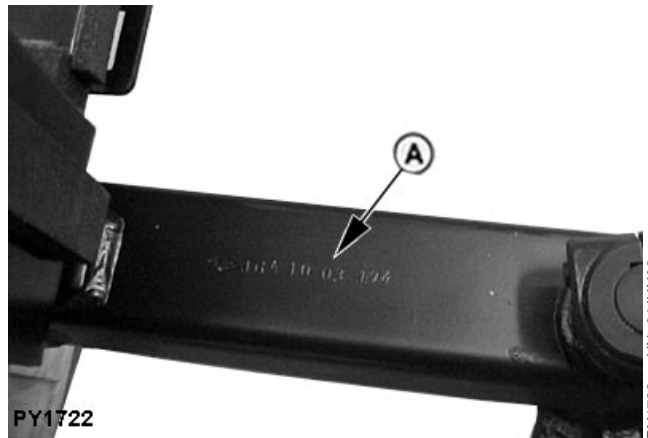

PY1722

DANA Front Axle

PY1722 -UN-01JUN06

PY80265,05G1104 -19-10SEP05-1/1

Record Engine Serial Number

Serial number plate (A) is located on the right-hand side of the engine block between the starter solenoid and the hydraulic pump.

Engine Serial Number _____



PY5154 -UN-21AUG05

PY80265,05G1105 -19-10SEP05-1/1

Record Transmission Serial Number

Transmission serial number is stamped into the lower left-hand corner of rear housing (A).

Transmission shield is removed for better quality of picture

Transmission Serial Number _____

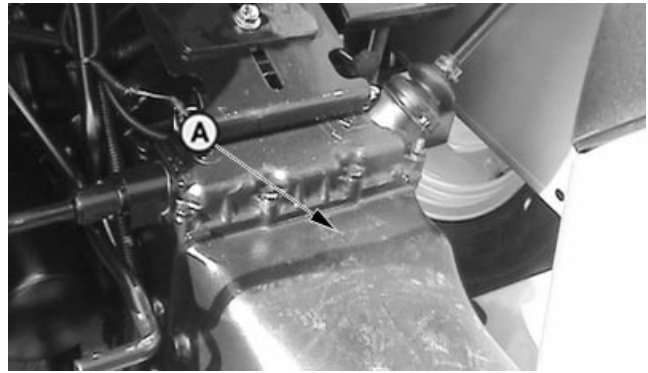

PY4178 -UN-03SEP04

Transmission Serial number

NR25796,0000358 -19-04AUG06-1/1

Lubrication Maintenance Record Charts

50, 250 Hour Service Chart

Every 50 Hours

- Check transmission-hydraulic system oil level
- Clean and check battery
- Inspect all tyres
- Lubricate front axle pivot pin
- Lubricate steering spindles
- Inspect tractor for loose nuts and bolts

- Service air cleaner
- Inspect and adjust alternator/fan belt
- Lubricate 3-point hitch
- Check neutral start system
- Check clutch pedal free play
- Check brake pedal adjustment
- Change primary and secondary filter inserts alternatively

Every 250 Hours

- Change engine oil and filter

Hours					Hours				
Date					Date				
Date					Date				
Hours					Hours				
Date					Date				
Hours					Hours				
Date					Date				
Hours					Hours				
Date					Date				
Hours					Hours				
Date					Date				
Hours					Hours				
Date					Date				
Hours					Hours				
Date					Date				
Hours					Hours				
Date					Date				
Hours					Hours				
Date					Date				

PY80265,05G1107 -19-10SEP05-1/1

500,600 Hour Service Chart

Every 500 Hours

- Replace transmission-hydraulic filter

- Tighten engine air intake hose clamps
- Check cooling system for leaks
- Lubricate rear axle bearings
- Check engine idle speeds
- Have your John Deere dealer:
 - Adjust engine valve clearance
 - Check front axle pivot pin
 - Inspect fuel injectors

Every 600 Hours

- Clean crankcase vent tube
- Repack front wheel bearings

Hours					Hours				
Date					Date				
Hours					Hours				
Date					Date				
Hours					Hours				
Date					Date				
Hours					Hours				
Date					Date				
Hours					Hours				
Date					Date				
Hours					Hours				
Date					Date				
Hours					Hours				
Date					Date				
Hours					Hours				
Date					Date				
Hours					Hours				
Date					Date				
Hours					Hours				
Date					Date				
Hours					Hours				
Date					Date				
Hours					Hours				
Date					Date				
Hours					Hours				
Date					Date				

1000, 1250 Hour Service Chart

Every 1000 Hours

- Check and adjust valve clearance
- Check engine speeds

Every 1250 Hours

- Change transmission-hydraulic oil and filter
- Clean transmission-hydraulic pickup screen

Hours					Hours				
Date					Date				
Hours					Hours				
Date					Date				
Hours					Hours				
Date					Date				
Hours					Hours				
Date					Date				
Hours					Hours				
Date					Date				
Hours					Hours				
Date					Date				
Hours					Hours				
Date					Date				
Hours					Hours				
Date					Date				
Hours					Hours				
Date					Date				
Hours					Hours				
Date					Date				
Hours					Hours				
Date					Date				
Hours					Hours				
Date					Date				

PY80265,05G1109 -19-10SEP05-1/1

Annual Service Chart

Annually

- Replace air cleaner elements

- Change engine oil and filter

Hours					Hours				
Date					Date				
Hours					Hours				
Date					Date				
Hours					Hours				
Date					Date				
Hours					Hours				
Date					Date				
Hours					Hours				
Date					Date				
Hours					Hours				
Date					Date				
Hours					Hours				
Date					Date				
Hours					Hours				
Date					Date				
Hours					Hours				
Date					Date				
Hours					Hours				
Date					Date				
Hours					Hours				
Date					Date				
Hours					Hours				
Date					Date				
Hours					Hours				
Date					Date				

2000 Hour Service Chart

Every 2 Years or 2000 Hours (Whichever Comes First)

- Flush cooling system

Hours					Hours				
Date					Date				
Hours					Hours				
Date					Date				
Hours					Hours				
Date					Date				
Hours					Hours				
Date					Date				
Hours					Hours				
Date					Date				
Hours					Hours				
Date					Date				
Hours					Hours				
Date					Date				
Hours					Hours				
Date					Date				
Hours					Hours				
Date					Date				
Hours					Hours				
Date					Date				
Hours					Hours				
Date					Date				
Hours					Hours				
Date					Date				

PY80265,05G1111 -19-10SEP05-1/1

As Required Service Chart

Service as Required

- Replace fuel filter

- Drain water and sediment from fuel tank
- Service air cleaner
- Adjust throttle friction

Hours					Hours				
Date					Date				
Hours					Hours				
Date					Date				
Hours					Hours				
Date					Date				
Hours					Hours				
Date					Date				
Hours					Hours				
Date					Date				
Hours					Hours				
Date					Date				
Hours					Hours				
Date					Date				
Hours					Hours				
Date					Date				
Hours					Hours				
Date					Date				
Hours					Hours				
Date					Date				
Hours					Hours				
Date					Date				
Hours					Hours				
Date					Date				
Hours					Hours				
Date					Date				

PY80265,05G1112 -19-10SEP05-1/1

John Deere Service

John Deere Parts

We help minimize downtime by putting genuine John Deere parts in your hands in a hurry. That's why we maintain a large and varied inventory to meet your spare parts needs.



PY00013.0000003 -19-14JUN01-1/1

TS100 -JUN-23AUG88

The Right Tools

Precision tools and testing equipment enable our Service Department to locate and correct troubles quickly. They save your time and money.



PY00013.0000004 -19-14JUN01-1/1

TS101 -JUN-23AUG88

Well Trained Technician

School is never out for John Deere service technicians. Training schools are held regularly to be sure our personnel know your equipment and how to maintain it.

Result?

Experience you can count on!

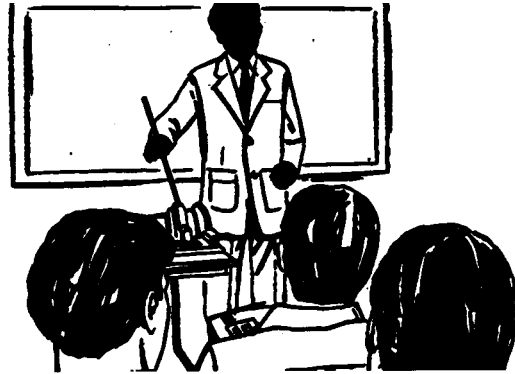

PY00013.0000005 -19-14JUN01-1/1

TS102 -JUN-23AUG88

Prompt Service

Our goal is to provide prompt, efficient care when you want it and where you want it. We can make repairs at your place or at ours, depending on the circumstances.

see us, depend on us. We'll be around when you need us.



PY00013.0000006 -19-14JUN01-1/1

TS103 -JUN-23AUG88

Index

Page

Page

A

Acid burns, battery	140-18
Adjusting rockshaft speed-of-drop Implement lock	55-5
Air cleaner	
Inspecting primary element	140-9
Replace elements	125-1
Service	110-1, 135-1
Service/regular intervals	140-6
Storing primary element	140-10
Air intake system	
Checking	140-7
Components	140-5
Air restriction indicator	45-4, 45-5
Alternator wiring	
Connecting	140-21, 140-22
Alternator/fan belt	
Inspect and adjust	110-2
Alternator/fan belt, replacing	140-10
Attaching implements to three point hitch	55-8
Attaching PTO-driven implement	65-2

B

Ballast	70-1
Limitations	70-3
Liquid weight	70-6
Matching to load work	70-1
Maximum front	70-5
Maximum rear	70-5
Selecting	70-1
Ballasting	70-4
Front end for transport	70-3, 70-4
Battery	
Access	140-15
Acid burn treatment	140-18
Booster	45-11
Charging	140-20
Checking condition	140-17
Clean and check	100-1
Removing	140-16
Replacement specifications	140-20
Servicing	140-18
Battery explosion	140-17
Before starting the engine	45-1
Bolts	
Front axle, tighten	75-3
Rear axle, tighten	75-5, 75-6
Booster battery	45-11

Brake pedal free play	
Check and adjust	110-5
Brakes	
Using	50-6
Brakes troubleshooting	145-5
Break-in	35-1
Break-in service	35-2, 90-1

C

Cast iron weights	70-5
Install rear	70-6
Center link	
Positioning	55-7
Charging system indicator	45-4
Checking Toe-In	75-9
Clutch pedal free play	
Check and adjust	110-4
Coolant	
Check level	95-1
Diesel engine	85-5
Coolant temperature gauge	45-5
Cooling system	
Components	140-13
Flush every two years	130-1

D

Dash panel	15-3
Diesel engine	
Oil	85-4
Differential lock	
Using	50-7
Draft control, using	55-4
Drawbar	
Load limitations	65-1
Driving on public roads	50-1, 80-1

E

Electrical service precautions	140-15
Electrical system troubleshooting	145-8
Engine	
Avoid idling	45-8
Break-in oil	140-3
Change oil and filter	110-1
Changing speeds	45-7

Page	Page		
Check idle speeds	115-4	Headlights	20-2
Check oil level	95-1	Adjusting	140-27
Observe work and idle speeds	45-9	Aiming	140-26
Stalled	45-8	Replace bulb	140-28
Stopping	45-10	High beam indicator	20-2
Troubleshooting	145-1	Hitch	
Warming up	45-7	Adjusting side sway	55-9
Engine crankcase vent tube		Components	55-1
Clean	115-1	Leveling	55-10
		Lubricate three-point	110-3
		Hood	
F		Opening	140-4
Fan/alternator belt, replacing	140-10	Removing	140-5
Front axle pivot pin		Hoses and hose clamps, check	115-2
Check	115-4	Hydraulic system troubleshooting	145-5
Lubricate	100-2	Hydraulic-transmission filter element	85-6
Front wheel bearings, pack	115-1		
Fuel		I	
Fill tank	85-3	Identification numbers	160-1
Storage	85-2	Idle speeds, check	115-4
Watch level	45-6	Implement to tire clearance	75-1
Fuel filter		Inch torque values	155-9
Drain	95-2	Indicator	
filter	110-2	Air restriction	45-4, 45-5
Fuel system		Charging system	45-4
Bleeding fuel injection nozzles	140-12	Oil pressure	45-3
Bleeding (MICO injection pump)	140-12	Instrument panel	15-3
Components	140-11		
Fuels and lubricants	85-1	L	
Fuses		Lateral float, adjusting	55-11
Locating	140-23	Light	
Size and function	140-24, 140-25	Hazard	20-5
Fusible link, locating	140-22	Light switch	
		Operation	20-1
G		Lighting and signals	20-1
Gauge		Lubricant	
Coolant temperature	45-5	Storage	85-4
Gear oil	85-6	Lubrication and maintenance record charts	165-1
Grease	85-7		
Grille screens, cleaning	140-14		
Ground speed estimates	155-7		
		M	
H		Metric torque values	155-8
Hardware			
Wheel/axle, tighten	75-3		

	Page		Page
N			
Neutral start system, check	110-3	10 hours	95-1
O			
Oil		100 hours	110-1
Engine break-in.	140-3	1200 hours	120-1
Warming hydraulic system	55-12	250 hours	110-1
Oil cooler, cleaning.	140-14	50 hours	100-1
Oil Gear	85-6	Service intervals	90-2
Oil pressure indicator	45-3	Service intervals, observe.	90-1
Operating transmission.	50-3, 50-4	Seven-terminal outlet	20-6
Operator training	50-1	Side screens, removing	140-4
P			
Position center link	55-7	Signals	20-1
Position control lever stop, setting	55-2	Speed/hour meter.	45-9
Prestart checks.	40-1	Starter wiring, connecting	140-21
PTO		Starting the engine	45-2
Adjusting clutch rod.	65-5	Steering spindles, lubricate.	100-2
Attach driven implement	65-2	Stopping tractor	50-8
Operating	65-3	Storing lubricants	85-4
R			
Radiator, cleaning.	140-14	Storing tractor.	150-1
Rear axle bearings, lubricate	115-3	T	
Removing tractor from storage	150-4	Tail light	20-3
Ride comfort, adjusting.	25-1	Replace bulb.	140-29
Rockshaft		Three-point hitch, lubricate	110-3
Position control	55-3	Throttle friction, adjust	135-1
Rate-of-drop adjustment	55-5	Tires	
Rockshaft and quick-coupler 3-point hitch		Checking.	140-30
troubleshooting	145-6	Inflation pressure	75-2
Rockshaft control lever friction, adjust	55-11	Inflation pressure chart	75-3
Rockshaft control levers	55-2	Toe-in	
S			
Seat		Adjusting.	75-10
Selecting position	25-1	Toe-in, 2-WD tractor	
Selecting a gear	50-5	Adjusting.	75-11
Service		Torque values	
As required	135-1	Adjustable front axle	75-3
		Inch.	155-9
		Metric	155-8
		Rear axle	75-5, 75-6
		Wheels/axles.	75-3
		Towing tractor	80-4
		Tractor controls	15-1
		Tractor PTO, operating.	65-3
		Transmission troubleshooting.	145-4
		Transmission, operating	50-3, 50-4
		Transmission, shifting.	50-3
		Transmission-hydraulic system	
		Change oil and filter	120-1
		Check oil level	100-1
		Clean pickup screen	120-2
		Replace filter.	112-1
		Transport	80-4

	Page
Tractor	05-7
Tread settings	
Adjustable front axle	75-8
Multi-position rear wheels	75-7
Tread width	
Rear wheel limitations	75-6
Troubleshooting	
Brakes	145-5
Electrical system	145-8
Engine	145-1
Hydraulic system	145-5
Quick-coupler 3-point hitch	145-6
Rockshaft	145-6
Transmission	145-4
Turn signals	20-4

U

Using	
Brakes	50-6
Cast iron weights	70-5
Differential lock	50-7
Draft control	55-4
Headlights	20-2
Tail lights	20-3
Turn signals	20-4

W

Warming hydraulic system oil	55-12
Warning light	
Replace bulb	140-29
Weights	
Cast iron	70-5
Install rear cast iron	70-6
Wheel slip	
Measuring manually	70-2