

LUX[®]
KONO

Smart
THERMOSTAT

Installation Manual

Thanks for inviting KONO™ into your home. The setup process is easy. All you need to do is follow these simple steps and you'll be on your way to saving energy and making your home even more comfortable.



LUX Products offers installation and product videos

Please visit LuxProducts.com/videos or visit our YouTube channel LUX Products Corporation. To contact LUX Technical Support please call 856.234.8803.

Para ver estas instrucciones en español, por favor visite LuxProducts.com/KONOmanualsSP

What's in the box?



KONO Smart

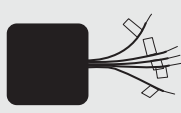

LUX Power Bridge™



Trim Plate



Screws



Wall Anchors

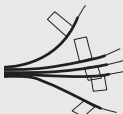

Wiring Labels

Tools Needed



Drill



Phillips Screwdriver



Optional: Wire Stripper



Smartphone

Table of Contents

| | |
|--------------------------------------|-------|
| 1. Start Here | 2-6 |
| 2. Installing with a C-Wire..... | 7-10 |
| 3. Installing without a C-Wire | 11-14 |
| 4. Connecting to the Network | 15-19 |
| 5. Appendix..... | 20-23 |

Press the knob when the thermostat is idle to view the menu. Rotate the knob to select an option and press again to confirm.



System Mode



Installation
Settings



Fan Mode



Network
Connection



Run Schedule



System
Preparing

For more information about
installation settings, please visit
LuxProducts.com/KONOManual

Behind KONO's Décor-snap™ cover you will see a small, removable "quick guide" to installation and an icon-key label. The icons represent the display icons of your KONO Smart. You will also find important information for HomeKit™ and WiFi setup.

This manual is a comprehensive guide to installation and wiring.

1. START HERE

Step 1.1: Download the LUX Products App to your mobile device and create an account.



Step 1.2: Now set your phone aside and turn off the power at the circuit breaker to both your heating and cooling systems before performing any wiring.

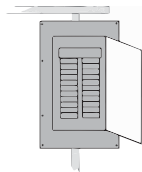

Step 1.3: Confirm that your heating and cooling system is powered down by changing the temperature on your thermostat.

Hint: Your system should not make any noise and you should not feel any air exiting your vents.

Step 1.4: Remove the front of your old thermostat from its base. If you see thick black wires, wire nuts, or any labels that say 120-240VAC or High Voltage, your system is not compatible with KONO Smart. Please call LUX Technical Support at 856.234.8803 before proceeding with your installation. If you do not see any high voltage labels or wires, you can continue with your installation.



Step 1.5: Use the included wire labels to mark which wire is connected to each terminal in your old thermostat. Take a picture of your current wiring layout – it may be helpful to reference this picture later.

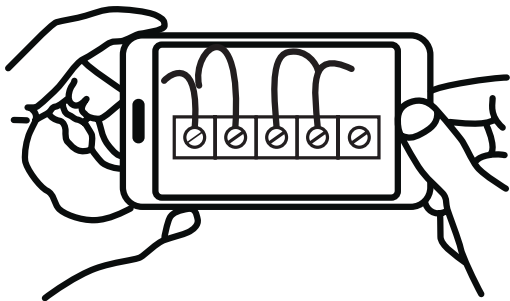

Step 1.6: Confirm if you have a C-Wire. If you do, please turn to the next page. If you do not, please skip ahead to page 11.

Installing with a C-wire

**Before starting**

Turn off the power at the circuit breaker to both your heating and cooling systems before performing any wiring. You will not need the included LUX Power Bridge.

Installation with C-wire

Step 2.1: Identify your system configuration (see wiring diagrams in appendix). Potential configurations include:

- Conventional 1H/1C (Y, G, W, R, C)
- Conventional 2H/1C (Y, G, W, W2, R, C)
- Heat Pump Single-Stage (Y, G, R, O/B, C)
- Heat Pump with auxiliary heat or dual fuel (Y, G, R, O/B, W, C)

If you have only one R wire, please use the RH terminal. If you have a different configuration other than what is listed above, please call LUX Technical Support for help with your installation.

Step 2.2: Remove each wire from its terminal – make sure that they don't fall down back into the wall.

Step 2.3: Remove the mounting screws from the base of the old thermostat. Remove the base from the wall.

Step 2.4: If you would like to use the trim plate or wall anchors, you can install them now.

Step 2.5: Separate KONO Smart from its base. Pull the wires from your wall through the center hole of the KONO Smart base. Secure the base to the wall using the included mounting hardware.

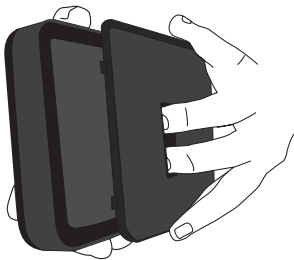

Option 1 - Conventional (furnace) Systems:

Step 2.6f: Following the terminal labels marked “Conventional” on the thermostat base, press the lever and insert each labeled wire into the top hole of the corresponding terminal.

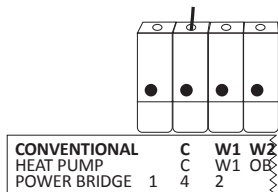

Step 2.7f: If you have both an RC and RH wire present, then remove the red cap next to the reset button. You can now skip ahead to step 2.8.

Option 2 - Heat Pump Systems:

Step 2.6hp: Following the terminal labels marked “Heat Pump” on the thermostat base and referencing your wiring photo, press the lever and insert each labeled wire into the top hole of the corresponding terminal.

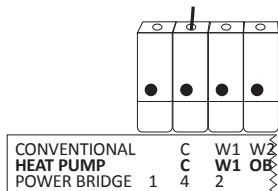

If your old thermostat did not have a W1 wire but did have a W2 wire, please insert the W2 wire into the W1 terminal.

Step 2.7hp: If you have both an O wire and a B wire (i.e. in a Trane system), please install the B wire to the “C” terminal.

For more detailed directions, please see the wiring diagrams in the appendix or call LUX Technical Support.

Installation with C-wire

Step 2.8: Securely fasten KONO Smart onto its base. Once it has clicked into place, return power to your heating and cooling system.

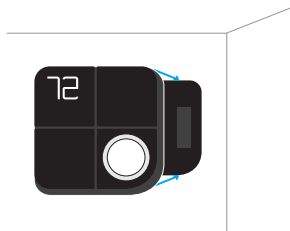

Step 2.9: After your thermostat powers up, you are ready to configure KONO Smart for your heating and cooling system and connect to a wireless network.

Please skip ahead to the “Connecting to the Network” section of this manual on page 15.

Installing without a C-Wire Using the Included LUX Power Bridge

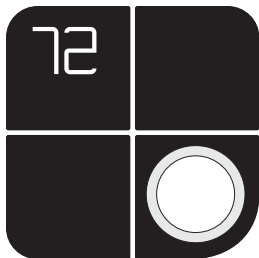

1. Install and wire your KONO

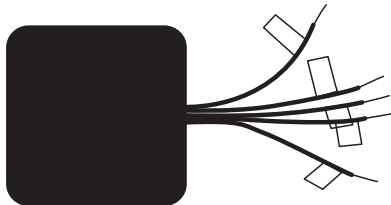

2. Install LUX Power Bridge at your furnace

For installation without C-wire,
you will need to access your furnace.



Before starting

Turn off the power at the circuit breaker to both your heating and cooling systems before performing any wiring.

Installation without C-wire

Hint: helpful videos showing how to wire a thermostat with the LUX Power Bridge are available at LuxProducts.com/videos

Step 3.1: Starting at your thermostat, confirm that you have one of the system configurations listed below:

- Conventional 1H/1C (Y, G, W, R)
- Conventional 2H/1C (Y, G, W1, W2, R)

If you have a different configuration other than what is listed above, please call LUX Technical Support for help with your installation.

Step 3.2: Remove each wire from its terminal – make sure that they do not fall down back into the wall.

Step 3.3: Remove the mounting screws from the base of the old thermostat. Remove the base from the wall.

Step 3.4: If you would like to use the trim plate or wall anchors, you can install them now.

3. C-WIRE

Step 3.5: Separate KONO Smart from its base. Pull the wires from your wall through the center hole of the KONO Smart base. Secure the base to the wall using the included mounting hardware.



Step 3.6: Following the terminal labels marked “Power Bridge” on the thermostat base, press the lever and insert each labeled wire into the top hole of the corresponding terminal. Connect as follows:

- Y Wire → Terminal 1
- W Wire → Terminal 2
- R Wire → Terminal 3
- G Wire → Terminal 4

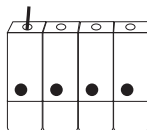

| | | | |
|---------------------|----------|----------|----------|
| CONVENTIONAL | C | W1 | W2 |
| HEAT PUMP | C | W1 | OB |
| POWER BRIDGE | 1 | 4 | 2 |

Step 3.7: Securely fasten KONO Smart onto its base.



Step 3.8: Go to your furnace – remove the door or panel and locate your control board or transformer. In most cases, there should be four wires running from the furnace to your thermostat – Y, G, W, and R. If you have additional wires, leave them as is.

- Step 3.9:**
- i) Matching the letters, label the wires connected to your furnace with the included white Power Bridge wire labels. Take a picture of the wiring at your control board.
 - ii) Disconnect these wires from the control board.
 - iii) Open the Power Bridge and insert each of your old wires into the corresponding numbered terminals in the Power Bridge.
 - iv) Finally, insert the Power Bridge wires (with the colored labels) into the corresponding terminals on your furnace control board.

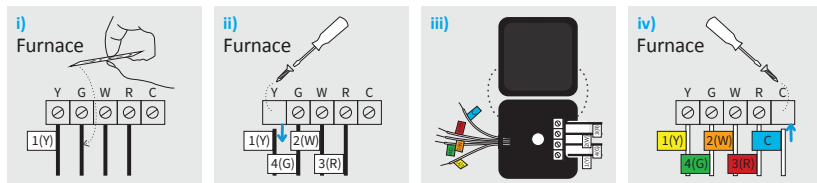

Step 3.10: Secure the LUX Power Bridge to your furnace. If you had to remove a panel or door to access your control panel, replace it now.

Step 3.11: Return power to your heating and cooling system. If your system, including your thermostat, does not power up please call LUX Technical Support.

After KONO Smart powers up, you are ready to configure it for your heating and cooling system and connect to a wireless network.

Connecting to the Network

Step 4.1: After your thermostat powers up, it will guide you through the initial system configuration. Use the knob to change options and press the knob to confirm your selection.

| First you will need to set your system type | |
|---|---|
| <p>(F) for Furnace or Boiler</p> <p>then</p> <p>Set the fan type to Gas (most common), Electric (for systems without gas or oil), or Boiler (no fan)</p> | <p>(HP) for Heat Pump</p> <p>then</p> <p>Set the valve type to O or B – look at the photo of your wiring to see which you have</p> |

Note: For advanced settings please visit LuxProducts.com/KONOmanual or call LUX Technical Support.

Step 4.2: After confirming your system settings, KONO Smart will ask if you would like to connect to the network. Select “ON” to begin connection or “OFF” to connect later. If you wish to connect, please make sure that you have downloaded the LUX Products App to your smartphone and created an account.



Hint: If you are having trouble, please see our instructional video at LuxProducts.com/videos

Step 4.3: After selecting “ON”, KONO Smart will display “01”. You will then need to select “iOS” if you are using an Apple® device or “And” if you are using an Android® device.



Step 4.4: After selecting “iOS” or “And”, your thermostat will display a large “02”, then “03”. Remove your Décor-snap™ cover.

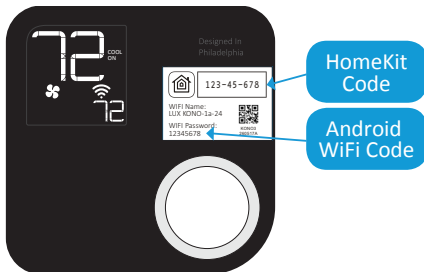

iOS® (iPhone® or iPad®)

Open your LUX App, tap the + icon to add a new accessory, then select the accessory ID that starts with LUX KONO to start the connection process.

Follow the instructions in the App.

If you need to cancel the joining process at any time, simply press and hold the knob for 5 seconds.

Locate your accessory's HomeKit Code under the Décor-snap cover. When prompted, use your iPhone or iPad's camera to scan the code.

After the App scans the code, your App and thermostat will handle the remaining steps in the connection process.



When you see the thermostat's idle screen, it means you are connected. You can now replace the Décor-snap cover.

To control this HomeKit-enabled accessory, iOS 10.3 or later is recommended.

ANDROID®

Open your LUX App, tap the + icon to add a new thermostat. When prompted by the LUX App, please use your phone's WiFi settings to join your LUX KONO's WiFi network. The network name and password can be found under the Décor-snap cover.

After connecting your thermostat to the network, please return to the App and select your home WiFi network from the list and enter your password.

Please make sure your phone reconnects to your home WiFi network and then return to the LUX App. From this point your thermostat and App will handle the remaining steps in the connection process.

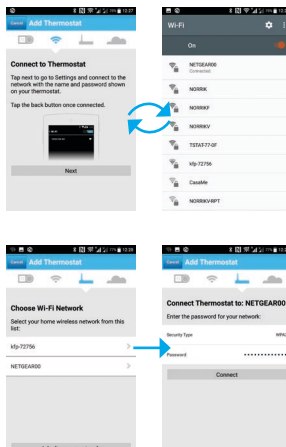

When you see the thermostat's home screen, it means you are connected. You can now replace the Décor-snap cover.

Congratulations!

Installation is complete and your KONO is ready to go. Now let's save some energy and make your home more comfortable.

Personalize your KONO Smart.

It's more than a thermostat, it's décor! Match KONO to your style by simply changing the Décor-snap cover. Check out our wide variety of designer colors and finishes at LUXProducts.com/shopcovers.



Hibiscus
Red



Sea
Green



Deep
Blue



Midnight
Black

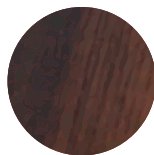

Wood
Grain

Conventional System With C-Wire Wiring Diagram

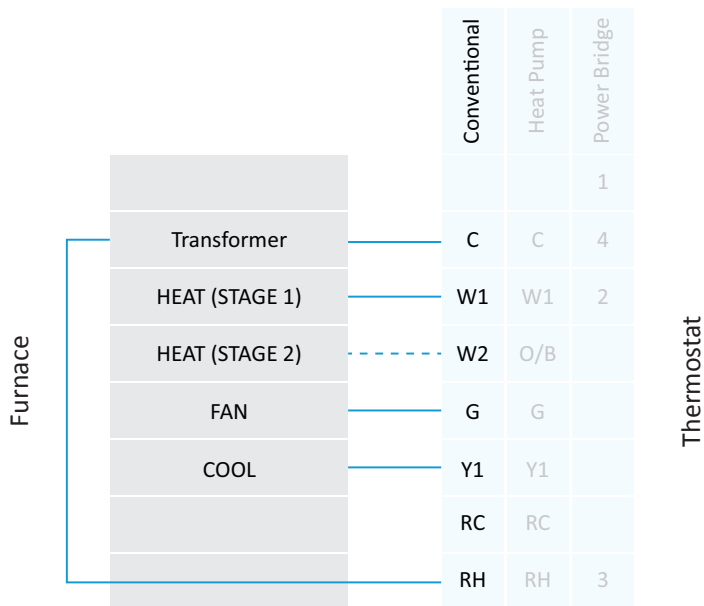

Notes:

- The W2 terminal is used for 2 stage heating systems only
- If you have both an RH and RC wire, please remove the red cap from the back of the thermostat

Heat Pump System With C-Wire Wiring Diagram

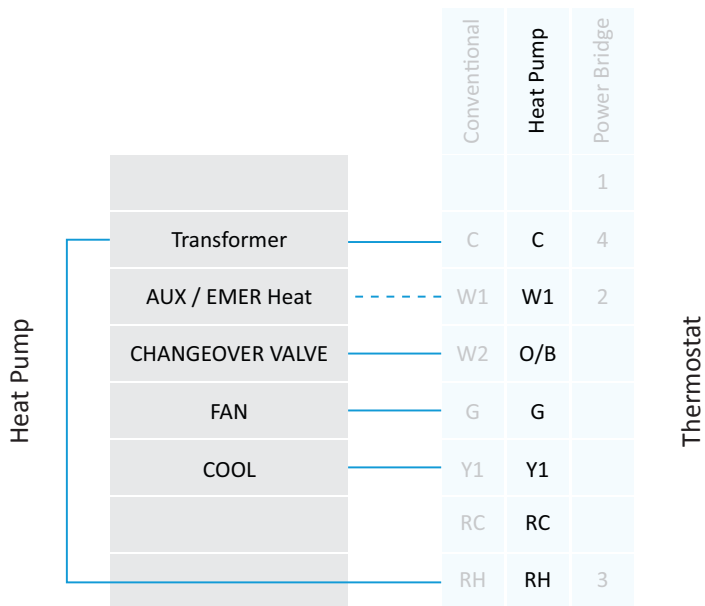

Notes:

- The W1 terminal is used for Auxiliary/Emergency heat or on Dual Fuel systems

LUX Power Bridge Wiring Diagram

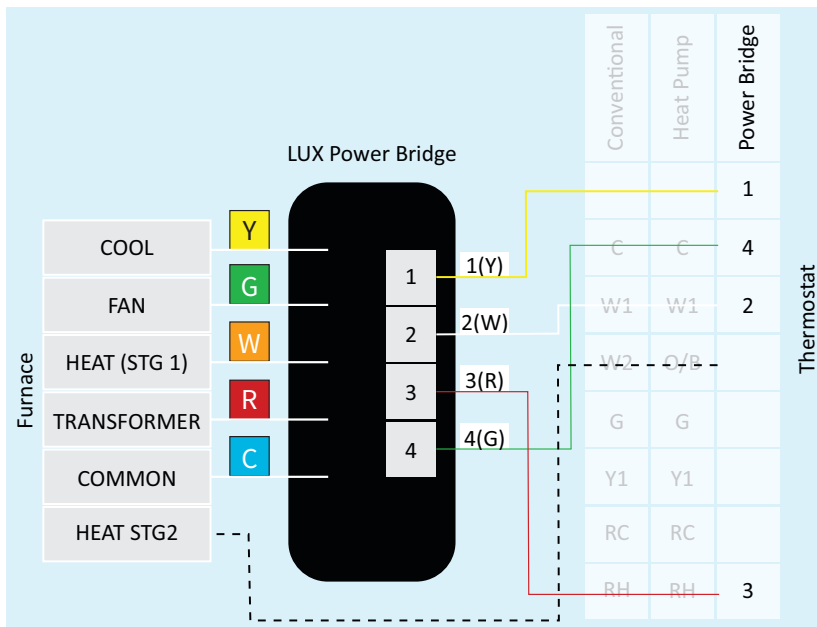

Notes:

- If you have a heat pump or dual transformer system, please call LUX Tech support.
- If you have any wires on your furnace not shown here, please leave them as is.

Apple HomeKit™

Use of the Works with Apple HomeKit logo means that an electronic accessory has been designed to connect specifically to iPod touch, iPhone, or iPad, respectively, and has been certified by the developer to meet Apple performance standards. Apple is not responsible for the operation of this device or its compliance with safety and regulatory standards.

Apple is a trademark of Apple Inc., registered in the U.S. and other countries. HomeKit is a trademark of Apple Inc.

FCC Part 15C

Warning: Changes or modifications to this unit not expressly approved by the party responsible for compliance could void the user's authority to operate the equipment.

NOTE: This equipment has been tested and found to comply with the limits for a Class B digital device, pursuant to Part 15 of the FCC Rules. These limits are designed to provide reasonable protection against harmful interference in a residential installation. This equipment generates, uses and can radiate radio frequency energy and, if not installed and used in accordance with the instructions, may cause harmful interference to radio communications. However, there is no guarantee that interference will not occur in a particular installation.

If this equipment does cause harmful interference to radio or television reception, which can be determined by turning the equipment off and on, the user is encouraged to try to correct the interference by one or more of the following measures:

- Reorient or relocate the receiving antenna.
- Increase the separation between the equipment and receiver.
- Connect the equipment into an outlet on a circuit different from that to which the receiver is connected.
- Consult the dealer or an experienced radio/TV technician for help.

This device complies with Part 15 of the FCC Rules. Operation is subject to the following two conditions:

(1) this device may not cause harmful interference, and (2) this device must accept any interference received, including interference that may cause undesired operation. FCC RF Radiation Exposure Statement

Caution: To maintain compliance with the FCC's RF exposure guidelines, place the unit at least 20cm from nearby persons.

Industry Canada Regulatory Information

This device complies with Industry Canada licence-exempt RSS standard(s). Operation is subject to the following two conditions: (1) this device may not cause interference, and (2) this device must accept any interference, including interference that may cause undesired operation of the device.

Le présent appareil est conforme aux CNR d'Industrie Canada applicables aux appareils radio exempts de licence. L'exploitation est autorisée aux deux conditions suivantes: (1) l'appareil ne doit pas produire de brouillage, et (2) l'utilisateur de l'appareil doit accepter tout brouillage radioélectrique subi, même si le brouillage est susceptible d'en compromettre le fonctionnement.



LUX PRODUCTS CORPORATION
Philadelphia, PA 19112 USA
LuxProducts.com

Designed in Philadelphia.