

LUX<sup>®</sup>  
KONO<sub>z</sub><sup>™</sup>

Smart Hub  
THERMOSTAT

Installation Manual

Thank you for inviting KONOz™ into your home. The setup process is easy. All you need to do is follow these simple steps and you'll be on your way to saving energy and making your home even more comfortable.

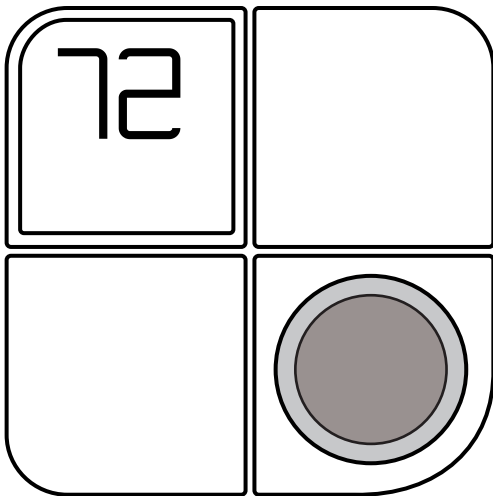

### LUX Products offers installation and product videos

Please visit [LuxProducts.com/videos](https://LuxProducts.com/videos) or visit our YouTube channel LUX Products Corporation.

Note: To contact LUX Technical Support, please call 856.234.8803.

*Para ver estas instrucciones en español, por favor visite.*

[LuxProducts.com/KONOzmanualSP](https://LuxProducts.com/KONOzmanualSP)

## What's in the box?

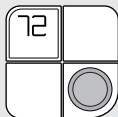

KONOz

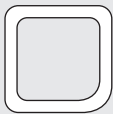

Trim Plate

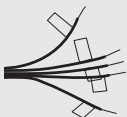

Wiring Labels



Screws



Wall Anchors



Batteries

## Tools Needed



Drill



Phillips Screwdriver



Optional: Wire Stripper



Smart Hub

## Table of Contents

1. Start Here .....	2-5
2. Installing KONOz .....	6-10
3. Operating KONOz .....	11-16
4. Appendix.....	17-19

**This manual is a comprehensive guide for the installation and wiring of your KONOz thermostat.**

**Step 1.1:** Turn off the power at the circuit breaker to both your heating and cooling systems before performing any wiring.

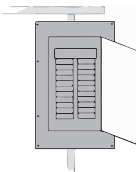

**Step 1.2:** Confirm that your heating and cooling system is powered down by changing the temperature on your existing thermostat. The heating and cooling should not come on but may show the temperature change on your existing thermostat.

Note: Your system should not make any noise and you should not feel any air exiting your vents.

**Step 1.3:** Remove the front of your old thermostat from its base.

If you see thick black wires, wire nuts, or any labels that say 120-240VAC or High Voltage, your system is not compatible with KONOz . Please call LUX Technical Support at 856.234.8803 before proceeding with your installation. If you do not see any high voltage labels or wires, you may continue with the installation process.



**Step 1.4:** Take a picture of your current wiring layout. The picture can be used as reference later.

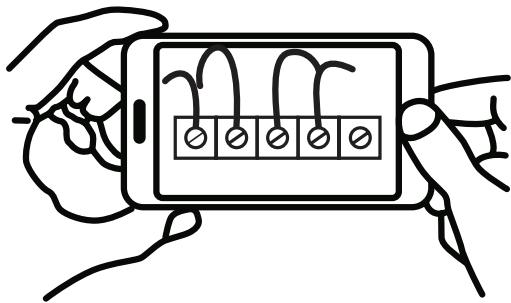

**Step 1.5:** Use the included wire labels to mark which wire is connected to each terminal in your old thermostat.

Note: Wiring letter designations correspond to either a “Heat Pump” or “Conventional” system.

Note: A wiring compatibility tool is available at [LuxProducts.com/wiring](https://LuxProducts.com/wiring)

## Wiring

**Step 2.1:** Identify your system configuration (see wiring diagrams in appendix). Potential configurations include:

System Configuration	Wiring Configuration
Conventional: 1H/1C without C-wire	Y, G, W1, R
Conventional: 1H/1C with C-wire	Y, G, W1, R, C
Conventional: 2H/1C without C-wire	Y, G, W1, W2, R
Conventional: 2H/1C with C-wire	Y, G, W1, W2, R, C

System Configuration	Wiring Configuration
Heat Pump: 1H/1C with C-wire	Y, G, R, O/B, C
Heat Pump with auxiliary or dual fuel:	Y, G, R, O/B, W1, C

If you have only one R wire, please use the RH terminal. If you have a different configuration other than what is listed above, please call LUX Technical Support for help with your installation. If you have a “C” wire then the included batteries are not needed.

Note: If you do not have a C-wire but would rather not use replaceable batteries, please visit [shop.LuxProducts.com/PowerBridge](https://shop.LuxProducts.com/PowerBridge) to learn more about our Lux Power Bridge solution.

**Step 2.2:** Verify that each wire has been properly labeled and remove each wire from its terminal — make sure that they don't fall into the wall.

**Step 2.3:** Remove the mounting screws from the base of the old thermostat and remove the base from the wall.

**Step 2.4:** Separate KONOz from its base.

**Step 2.5:** If you would like to use the trim plate or wall anchors, you may install them now.

**Step 2.6:** Pull the wires from your wall through the center hole of the KONOz base. Secure the base to the wall using the included mounting hardware. Follow the built in level to ensure that it is straight.

**Step 2.4**

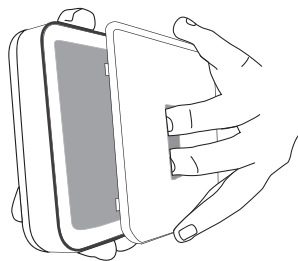

**Step 2.5**

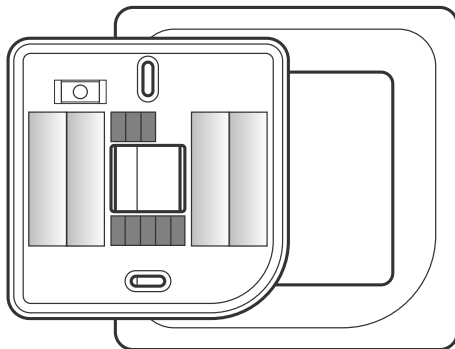

**Step 2.6**

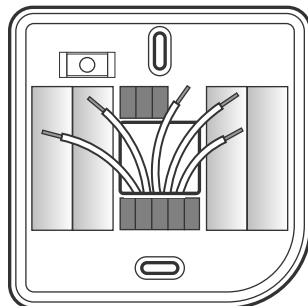

## Option 1 - Conventional (furnace) Systems:

**Step 2.7f:** Follow the terminal labels marked “Conventional” on the thermostat base. Press the lever and insert each labeled wire into the top hole of the corresponding terminal.

CONVENTIONAL HEAT PUMP POWER BRIDGE	C	Y1	W2
	C 4	Y1	O/B

**Step 2.8f:** If you have both an RC and RH wire present, then remove the red cap next to the reset button. You can now proceed to step 2.9.

## Option 2 - Heat Pump Systems:

**Step 2.7hp:** Follow the terminal labels marked “Heat Pump” on the thermostat base. Referencing your wiring photo, press the lever and insert each labeled wire into the top hole of the corresponding terminal.

CONVENTIONAL HEAT PUMP POWER BRIDGE	C	Y1	W2
	C 4	Y1	O/B

If your old thermostat did not have a W1 wire but did have a W2 wire, insert the W2 wire into the W1 terminal.

**Step 2.8hp:** If you have both an O wire and a B wire (i.e. in a Trane system), install the B wire in the “C” terminal.

For more detailed directions, please see the wiring diagrams in the appendix or call LUX Technical Support.



## Wiring

**Step 2.9:** If you do not have a C-wire, insert the (4) AA batteries included with your KONOz thermostat according to their correct polarization markings found on the KONOz.

Securely fasten KONOz onto its base. Once it has clicked into place, return power to your heating and cooling system.

**Note:** If batteries are installed, you must replace all batteries with only premium brand alkaline batteries at least once every two years.

To replace the batteries, remove the KONOz from its base (ie disconnecting it from its supply mains) and insert (4) AA premium brand alkaline batteries. If you discover leaky or damaged batteries, do not touch the batteries. Leaky or damaged batteries must be handled with proper safety equipment including safety glasses with side shields, and neoprene or natural rubber gloves in a well-ventilated room.

For disposal of batteries, abide by the local laws and regulations of your region. If you are not able to identify the applicable rules in your area, please check the instructions of the battery manufacturer.

For disposal of KONOz, you must remove batteries prior to disposal.

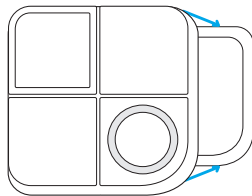

**Step 2.10:** Your KONOz is now ready to be configured for your heating and cooling system. The KONOz will guide you through the initial system configuration. Use the knob to change options and press the knob to confirm your selection.

**First you will need to set your system type:**

**(F) for Furnace or Boiler:**

Set the fan type to Gas (most common), Electric (for systems without gas or oil), or Boiler (no fan).

**(HP) for Heat Pump:**

Set the valve type to O or B - look at the photo of your wiring to see your valve type.

**Step 2.11:** After confirming your system settings, KONOz will ask if you would like to connect to a Smart Hub. Select “SET” to establish a connection with your Smart Hub or select “OFF” to connect later. For details on how to configure KONOz for your particular Smart Hub please visit: [LuxProducts.com/KONOzSmartHubSetup](https://LuxProducts.com/KONOzSmartHubSetup)

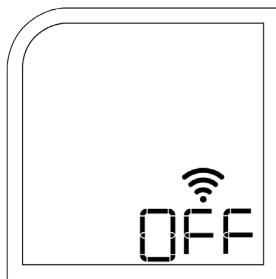

Press the knob when the thermostat is idle to view the menu. Rotate the knob to select an option and press again to confirm.



System Mode



Installation Settings



Fan Mode



Smart Hub Connection



Run Schedule \*



System Preparing

### Changing KONOz's Décor-snap™ Cover

Place right hang on outside edge of the Décor-snap cover and left hang on the edge of the KONOz screen. Hold KONOz in place while gently pulling the decor snap cover. You will find important information for Smart Hub setup including the Zigbee Install Code and model number.

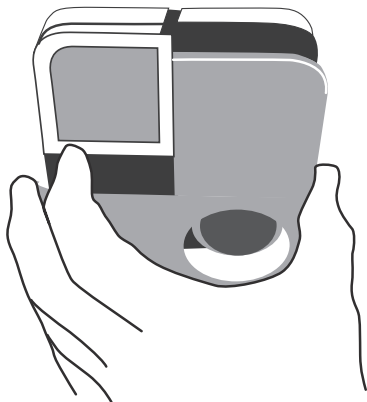

\*Note: Run Schedule will only work if enabled on Smart Hub.

## The operations guide section covers the following:

- 3.1 How to use KONOz
- 3.2 Reading KONOz's screen
- 3.3 Using KONOz throughout the year

### 3.1 How to use KONOz

KONOz's knob is the main way for you to control your heating and cooling systems. Simply press the knob to open a menu or select an option. Press and hold the knob at any time to exit a menu and return to the home screen. In a menu, rotate the knob to cycle through available options.

Note: If you are interested in advanced information, the Installation Setting Guide can be found at

[LuxProducts.com/KONOzManual](http://LuxProducts.com/KONOzManual)

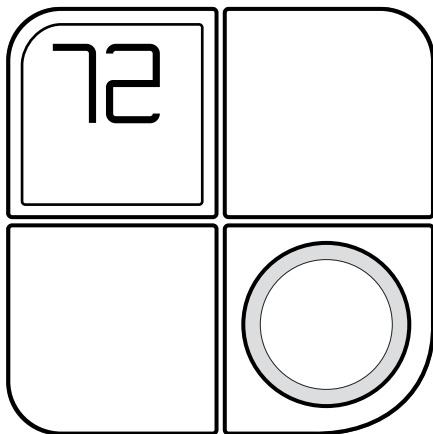

## 3.2 Reading KONOz's screen

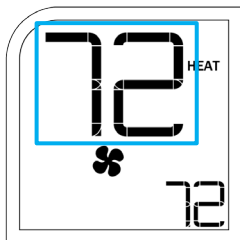

The large number in the top left shows your ambient room temperature.

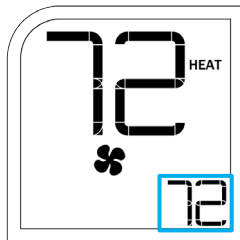

The small number in the bottom right shows your set temperature.

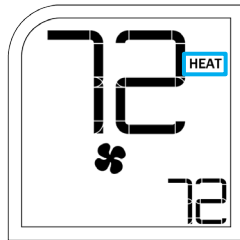

The selected system mode (HEAT, COOL or OFF) is shown to the right of the ambient room temperature.

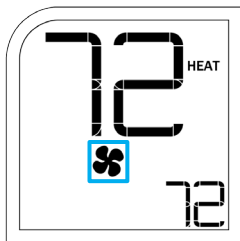

The active fan status is shown by the icon below the ambient room temperature. If it is off, your fan is not running. If it is on, your fan is running. Please note that your fan will run depending on your selected fan mode (either AUTO or ON).

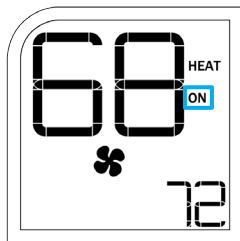

If you see ON under your system mode, it means that your system is actively heating or cooling your home.



This icon shows that your HVAC system is preparing to turn on or off. Please wait for heating and cooling to start.

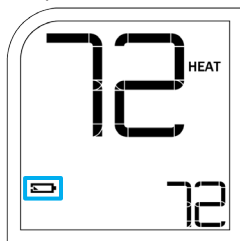

This icon indicates the battery levels of the KONOz.

Note: Replace all four AA batteries in the KONOz if the low battery icon or blinking empty battery icon appears on your KONOz.

## Reading KONOz's screen

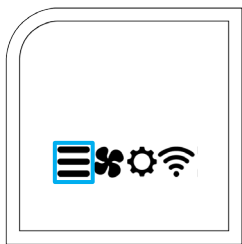

This icon opens the system mode menu. In this menu, you can set your HVAC system to OFF, HEAT, or COOL. Your thermostat will automatically detect which modes are available when you install your thermostat, so you may not see all three options depending on your system type.

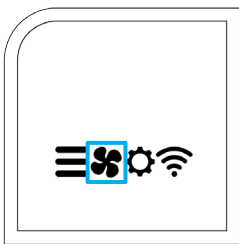

This icon opens the fan mode menu. In this menu, you can set your fan to AUTO, or ON. AUTO will run your fan when your system is actively heating or cooling. ON will run your fan continuously. If you set a filter life value in the installation settings, you'll be able to check the remaining life of your filter in the fan settings menu.



This icon opens the installation settings menu. In this menu, you can adjust advanced preferences for special applications. Select the gear icon, then after IS appears on the screen, select YES to begin the installation settings flow. For more information about the installation settings, please view the "Installation Settings Guide".

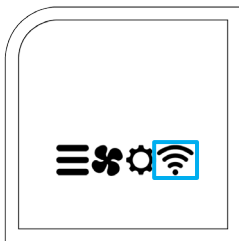

This icon opens the Smart Hub network connection menu. In this menu, you can choose to connect or disconnect from your Smart Hub. Select “SET” to establish a new Smart Hub connection. Select “OFF” to temporarily disable the connection. Lastly, select “ON” to reconnect to your Smart Hub. For more information about connecting to a Smart Hub, please view KONOz’s Smart Hub Setup Guide.

### 3.3 Using KONOz throughout the year

#### Cold Weather:

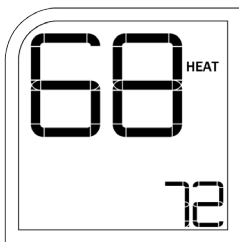

Heat mode is the best setting to use when it’s cold out and you won’t need to use your air conditioner. This will make sure that your air conditioner stays idle and that your heater keeps your home’s temperature above your chosen set-temperature.

#### Hot Weather:

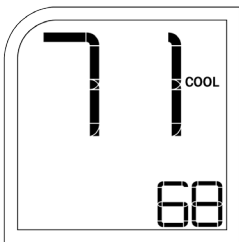

Cool mode is the best setting to use when it’s hot out and you won’t need to use your heating system. This will make sure that your heater stays idle and that your air conditioner keeps your home’s temperature below your chosen set-temperature.

## Congratulations!

Installation is complete and your KONOz is ready to go. Now let's save some energy and make your home more comfortable.

## Personalize your KONOz.

It's more than a thermostat, it's décor! Match KONOz to your style by simply changing the Décor-snap cover. Check out our wide variety of designer colors and finishes at [LuxProducts.com/ShopCovers](https://LuxProducts.com/ShopCovers)



Hibiscus  
Red



Sea  
Green



Deep  
Blue



Midnight  
Black

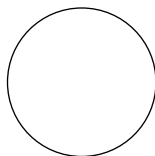

True  
White

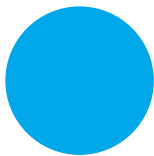

Sky  
Blue

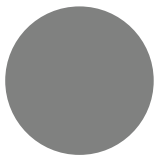

Sea Mist  
Grey

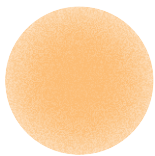

Champagne  
Gold



Driftwood

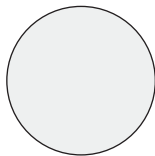

Paint  
It



## Conventional System

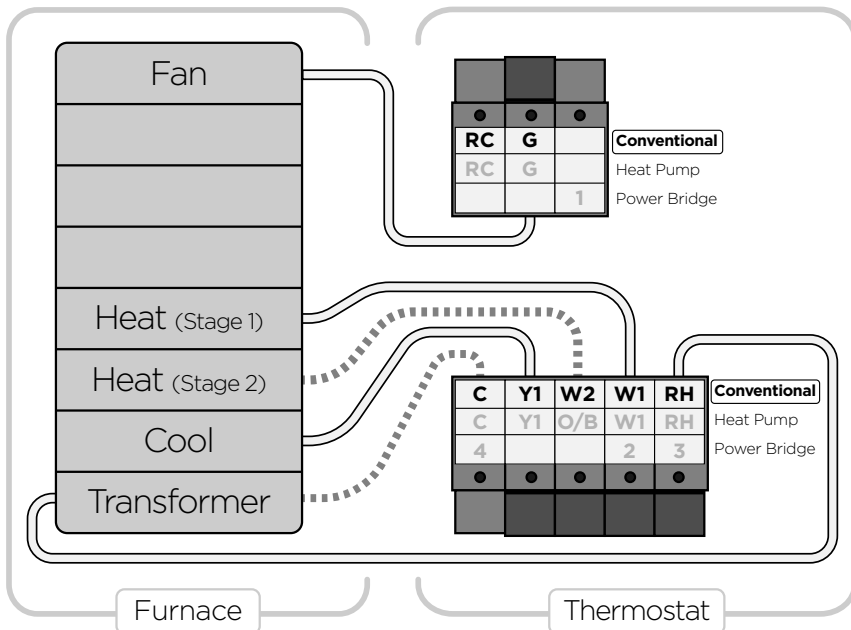

## Notes:

- C-wire optional
- The W2 terminal is used for 2 stage heating
- If you have both an RH and RC wire, please remove the red cap from the back of the thermostat

## Heat Pump System

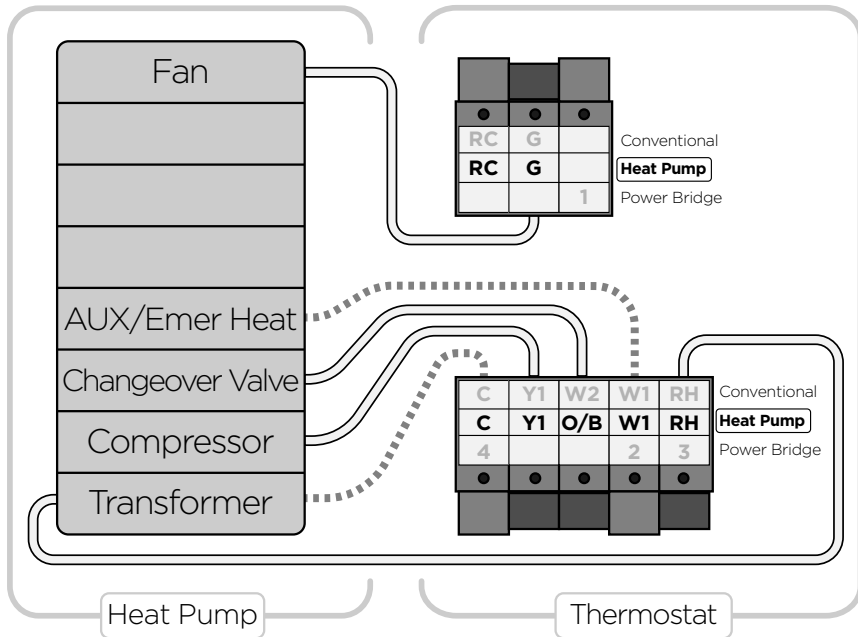

Notes:

- C-wire optional
- The W1 terminal is used for Auxiliary/Emergency heat or on Dual Fuel systems

**Technical Information:**

Disconnection Means: Type 1B

Pollution Degree: 2

Impulse Voltage: 330V

Automatic Action: 100,000 cycles

Electrical Rating:

-Input: 24V a.c. 60Hz or 4xAA Alkaline battery

-Output: @24V a.c. Max. 1.5A

**FCC Part 15C**

Warning: Changes or modifications to this unit not expressly approved by the party responsible for compliance could void the user's authority to operate the equipment. NOTE: This equipment has been tested and found to comply with the limits for a Class B digital device, pursuant to Part 15 of the FCC Rules. These limits are designed to provide reasonable protection against harmful interference in a residential installation. This equipment generates, uses and can radiate radio frequency energy and, if not installed and used in accordance with the instructions, may cause harmful interference to radio communications.

However, there is no guarantee that interference will not occur in a particular installation. If this equipment does cause harmful interference to radio or television reception, which can be determined by turning the equipment off and on, the user is encouraged to try to correct the interference by one or more of the following measures:

- Reorient or relocate the receiving antenna.
- Increase the separation between the equipment and receiver.
- Connect the equipment into an outlet on a circuit different from that to which the receiver is connected.
- Consult the dealer or an experienced radio/TV technician for help.

This device complies with Part 15 of the FCC Rules. Operation is subject to the following two conditions:

(1) This device may not cause harmful interference, and (2) this device must accept any interference received, including interference that may cause undesired operation. FCC RF Radiation Exposure Statement

Caution: To maintain compliance with the FCC's RF exposure guidelines, place the unit at least 20cm from nearby persons.

**RSS-247**

This device complies with Industry Canada licence-exempt RSS standard(s). Operation is subject to the following two conditions: (1) this device may not cause interference, and (2) this device must accept any interference, including interference that may cause undesired operation of the device.

*Le présent appareil est conforme aux CNR d'Industrie Canada applicables aux appareils radio exempts de licence. L'exploitation est autorisée aux deux conditions suivantes: (1) l'appareil ne doit pas produire de brouillage, et (2) l'utilisateur de l'appareil doit accepter tout brouillage radioélectrique subi, même si le brouillage est susceptible d'en compromettre le fonctionnement.*



LUX PRODUCTS CORPORATION  
Philadelphia, PA 19112 USA  
[LuxProducts.com](http://LuxProducts.com)

Designed in Philadelphia.