



MANUAL SPECIFICATION

DOCUMENT NO: Z370147
REVISION: C

TITLE: WHITESTAR SIGNATURE™ OWNER'S AND OPERATOR'S MANUAL (ENGLISH)
SOFTWARE VERSION 1.003, CE

SPECIFICATIONS:

- 1. BINDER:**
8 ½" x 11 x 1 ½" White vinyl with clear-view insert pockets or equivalent, 3 rings.
- 2. TEXT:**
 - 2.1 DIMENSIONS: 8 1/2" x 11" three rings, white laser paper
 - 2.2 TYPE OF PAPER: 20lb. Bond, White, 3 ring punched
 - 2.3 INK/COLOR: Black on white paper. Printing to be clear and legible with no ink smears.
 - 2.4 TYPE OF COPY: Single Copy, print 2 sides. Each chapter must start on a right-facing page.
- 3. COVER & SPINE:** Z330075 for Label Specifications.
- 4. TAB PAGES:** Z330077 for Label Specifications.
- 5. ASSEMBLY / PACKAGING:** Index tabs in the appropriate sections of the manual. Shrink-wrap assembled binder with copy of first page of document (cover page) between shrink and outside of binder. Manual identify from cover page (version, part number, etc.) must be facing out and visible for warehouse identification.
- 6. LANGUAGES:** English
- 7. POINTS OF USE:** AMO, Corporate, Santa Ana, Milpitas

CHANGE SUMMARY

REVISION	DESCRIPTION OF CHANGE
A	Create new manual for WHITESTAR SIGNATURE™ Owner's manual Software Version 1.03. For clinical use only.
B	Production manual for the 1.03 software version – updates for Venturi in all surgical modes and the Dual Linear Foot Pedal (Advanced Control Pedal)
C	Update to Reflux Description, Distributor address, New terms in glossary – New screens for Passive Reflux.

WHITESTAR SIGNATURE™



OWNER'S AND OPERATOR'S MANUAL



Manufactured By:
Advanced Medical Optics, Inc.
1700 E. St. Andrew Place
Santa Ana, CA 92705
USA

1-800-449-3060
www.amo-inc.com

CE
0050



AMO Ireland
Block B
Liffey Valley Office Campus
Quarryvale Co., Dublin Ireland

For Order Placement of Surgical Products

(IOLs and Phaco Supplies)
Call 1-877-AMO-4LIFE (USA)
1-877-266-4543

For Phaco Returns or Technical Service

Call 1-877-AMO-4LIFE (USA)
1-877-266-4543

All returns must be accompanied by a
RGA#
(Returned Goods Authorization)



Rx Only – Z370147 Rev C 1108
© 2008 Advanced Medical Optics, Inc.

Trademarks

AMO, the AMO ADVANCED MEDICAL OPTICS logo, and WHITESTAR are registered trademarks and ELLIPS, the ELLIPS logo, FUSION, the FUSION logo, LAMINAR, PHACOFIT, OCCLUSION MODE, and WHITESTAR SIGNATURE are trademarks of Advanced Medical Optics, Inc.

DUET and SOLO are trademarks of Micro-Surgical Technology, Inc.

Bluetooth is a registered trademark of Bluetooth SIG, Inc.

All brand names and products and company names mentioned in this document are the trade name, service mark, or registered trademarks of their respective owners.

Compliance

In accordance with:

- IEC/EN 60601-1

TABLE OF CONTENTS

Introduction	1-1
About this Manual	1-2
About Phacoemulsification	1-2
Intended Use	1-2
WHITESTAR SIGNATURE™ System Description & Features	1-2
WHITESTAR® Technology	1-3
FUSION™ Fluidics System	1-4
Accessories	1-4
WHITESTAR SIGNATURE™ System Console	1-5
WHITESTAR SIGNATURE™ System Operating Modes	1-6
System Components	2-1
Receipt and Inspection Instructions	2-2
WHITESTAR SIGNATURE™ System Components	2-2
WHITESTAR SIGNATURE™ System with FUSION™ Tubing Pack	2-4
System Setup	3-1
Safety Precautions	3-2
Warnings	3-5
Symbol Definitions	3-9
System Disposal	3-12
Setup Sequence – Anterior Segment Surgery	3-15
Footpedal	3-22
Programmable IV Pole	3-25
Wireless Remote Control (Optional)	3-26
Surgical Media Center (SMC) (Optional)	3-27
Shutdown Sequence – Anterior Segment Surgery	3-29
Equipment Operation	4-1
Display Screens and Controls	4-2
Language Selection	4-3
Startup	4-4
Select Program and Install the FUSION™ Tubing Cassette	4-6
Prime/Tune	4-7
Verify Irrigation/Aspiration Balance	4-10
Priming for Vitrectomy	4-11
Selecting and Changing Mode Parameters	4-12

Anterior Segment Surgery Operating Modes	5-1
Operating Mode Descriptions	5-2
Fusion™ Fluidics Phaco	5-15
Programming the Modes and Settings	5-21
Anterior Segment – Recommended Settings	5-37
OCCLUSION MODE™ Phaco Settings	5-41
Passive Reflux	5-48
Ellips™ Technology	5-48
Surgeon Programs	6-1
Select Surgeon/Program	6-2
Add a New Surgeon	6-3
Edit a Surgeon	6-5
Select a Preferred Program	6-6
Create a New Program	6-8
Edit a Surgeon Program	6-9
Copy a Surgeon Program	6-10
Delete a Surgeon	6-11
Delete a Program	6-12
Delete a Database	6-13
Lock a Program	6-13
Program – Assign Order	6-14
Diagnostics	7-1
Diagnostics	7-2
Wireless Footpedal Setup	7-3
Wireless Foot Pedal Calibration	7-5
Wireless Remote Control Setup	7-6
Calibrate Touch Screen	7-7
Check-out Precautions	8-1
System Check-out	8-2
Care and Cleaning	9-1
Cleaning Procedures	9-2
Sterilization Procedures	9-4
WHITESTAR SIGNATURE™ System Cleaning and Care	9-5

Error Messages Troubleshooting and Diagnostics	10-1
Error Message Display	10-2
Fuse Replacement Procedure	10-2
Wireless Foot Pedal Battery Replacement Procedure	10-3
Most Common User-Correctable Problems	10-5
Status, Warning and Error Messages	10-5
System Operation (Error) Messages	10-5
Troubleshooting	10-15
 Warranty and Maintenance	 11-1
Warranty Statement	11-2
 Specifications	 12-1
Physical Specifications	12-2
Environmental Specifications	12-3
Electrical Specifications	12-3
Diathermy Specifications	12-3
Irrigation and Aspiration Specifications	12-3
Phacoemulsification Specifications	12-4
Vitrectomy Specifications	12-4
Diathermy Power Graphs	12-5
Diathermy Power versus Load Impedance	12-10
Phaco Power Graphs	12-13
 Accessories and Parts Reordering	 13-1
List of Accessories with Part Numbers	13-2
 Glossary	 Glossary-1
 Index	 Index-1

1

INTRODUCTION

About this Manual

About Phacoemulsification

Intended Use

WHITESTAR SIGNATURE™ System Description & Features

WHITESTAR® Technology

FUSION™ Fluidics System

Accessories

WHITESTAR SIGNATURE™ System Console

WHITESTAR SIGNATURE™ System Operating Modes

About this Manual

This manual includes information about the WHITESTAR SIGNATURE™ System which is designed for anterior segment (phacoemulsification) surgical procedures.

This manual includes information regarding optional System enhancements. The availability of these features in your System configuration and availability in your area can be confirmed by your AMO representative.

About Phacoemulsification

Over thirty years ago, Dr. Charles Kelman conceived and developed phacoemulsification, a method of cataract removal using ultrasonic emulsification and aspiration of the cataractous lens through a small incision. Phacoemulsification is advantageous for both patient and surgeon:

- Greater intraoperative control.
- The smaller incision requires fewer or no sutures, poses less risk of infection and induced astigmatism, and gives better long-term and short-term predictability of vision.
- Patients are able to resume normal activity much sooner and with fewer restrictions than with traditional cataract extraction surgeries.

Advanced Medical Optics, Inc. (AMO) supports phacoemulsification with sophisticated instrumentation that optimizes the benefits of this surgical procedure.

Intended Use

The WHITESTAR SIGNATURE™ System is a modular ophthalmic microsurgical system that facilitates anterior segment (cataract) surgery. The modular design allows the users to configure the system to meet their surgical requirements.

This HIGH FREQUENCY (HF) SURGICAL EQUIPMENT is specified for use without a NEUTRAL ELECTRODE.

WHITESTAR SIGNATURE™ System Description & Features

The WHITESTAR SIGNATURE™ System is a multi-functional tool for use in anterior segment surgery and procedures. The WHITESTAR SIGNATURE™ System represents the latest generation of AMO® phacoemulsification technology. Safety, ease-of-use, and reliability are designed and manufactured into every WHITESTAR SIGNATURE™ System. The WHITESTAR SIGNATURE™ System meets applicable United States and International safety requirements for this type of device.

The WHITESTAR SIGNATURE™ System contains a number of features based on extensive research and clinical trials with highly-trained and noted ophthalmologists who are experienced phacoemulsification surgeons.

**WHITESTAR®
Technology**

The WHITESTAR® Technology represents the many enhancements to the power modulation for the WHITESTAR SIGNATURE™ System. The WHITESTAR® Technology enhancement was the first to deliver finely modulated pulses of energy, interrupted by extremely brief cooling periods. This allows the WHITESTAR SIGNATURE™ System to achieve full ultrasound cutting efficiency and magnetic followability, while introducing less energy into the eye. Ultrasound time is minimized or eliminated to reduce the risk of thermal damage.

WHITESTAR® ICE Technology

The WHITESTAR® ICE Technology was the next micro-pulse advance in phacoemulsification technology, which combined modulated ultrasonic power (pulse shaping) with vacuum control through the application of the Chamber Stabilization Environment (CASE).

This pulse shaping technology modified the standard “square” wave pulse, by increasing the amplitude of the first millisecond of the On Time “kick”, and then setting the remaining part of the On Time to the standard power setting. This is repeated for each On Time period, resulting in increased control and efficiency in phacoemulsification.

OCCLUSION MODE™ Phaco

The OCCLUSION MODE™ Phaco is used to regulate the vacuum rise time experiences following occlusion of the phaco tip, without limiting the choice of aspiration rate through an unoccluded needle. In order to independently control the aspiration rate and vacuum rise time, you can have a different aspiration rate when the needle is occluded than when the needle is not occluded.

The OCCLUSION MODE™ Phaco is also used to regulate ultrasound power modulation. The power modulation of the phaco handpiece (continuous, pulse, burst) can be programmed to automatically change when the phaco tip changes from an unoccluded condition to an occluded condition.

The FUSION™ Mode allows the user to access the settings and variables for both CASE and OCCLUSION MODE™ Phaco. The CASE and OCCLUSION MODE™ Phaco can be used together or independently.

FUSION™ Fluidics System

The WHITESTAR SIGNATURE™ System has both a flow-based peristaltic pump system and a vacuum based Venturi pump system. The patented microprocessor-based system continuously monitors and controls intraocular conditions of the flow and vacuum in the eye.

Chamber Stability Environmental (CASE)

CASE is an intelligent vacuum monitoring system used to regulate the maximum allowable vacuum that is experienced following the occlusion of the phaco tip. When the phaco tip becomes occluded, the vacuum rises. Clearing of the occlusion while the vacuum is at a high level can lead to a post-occlusion surge. With CASE enabled, the System monitors the actual vacuum levels and when the vacuum exceeds a specific threshold for a specified duration, the System automatically adjusts the maximum allowable vacuum setting to a lower predefined CASE maximum vacuum level. When the occlusion is cleared, the System is automatically restored to the original programmed maximum vacuum setting. This function makes it possible to have a different maximum vacuum setting when the needle is occluded than when the needle is not occluded.

Accessories**WHITESTAR® Handpiece**

The Phaco Handpiece has been designed with a straight-through aspiration channel for more efficient removal of nuclear fragments, to minimize clogging and to facilitate cleaning. The hand piece is lightweight, slim, and well-balanced, making it comfortable to use and easy to manipulate.

Ellips™ Handpiece

An Ellips™ phaco handpiece is available for use with the WHITESTAR SIGNATURE™ System. The Ellips™ handpiece provides both longitudinal and transversal movement. The Ellips™ handpiece provides great followability and can be used with either a straight or a curved tip.

Footpedal

The footpedal controls the various operating modes of the instrument, and all settings are programmed through the user interface. The WHITESTAR SIGNATURE™ Single Linear footpedal or the wireless Advanced Control Pedal (dual linear) can be used with the system.

The footpedal design offers control through the use of increased linearity and uniform pressure throughout the footpedal movement, easing foot and leg fatigue. The degrees of movement for each footpedal position can be selected and saved in memory for each surgeon/mode, pitch for the single linear footpedal only and pitch and yaw for the Advanced Control Pedal giving the pedal dual linear functionality. Reflux is activated by programmable switches, giving immediate response. The footpedal is connected to the rear of the console by a cable or can be wireless as with the Advanced Control Pedal.

Wireless Remote Control (Optional)

The WHITESTAR SIGNATURE™ System can be controlled from the wireless remote control keypad. All modes can be remotely accessed, and all settings can be adjusted with the use of the wireless remote control, including full programming and priming capabilities. Backlighting supports low light operating room conditions.

WHITESTAR SIGNATURE™ System Console

Operating Room teams contributed significantly to the successful design of the WHITESTAR SIGNATURE™ System Cart. The solid wheel base and locking wheels make the cart stable and smooth rolling. An adjustable height Mayo tray accommodates the handpieces and tubing. The remote control is wireless and recharges when the remote control is placed in the storage bay. An open bin and footpedal platform are available for storage.

WHITESTAR SIGNATURE™ System Display (Graphic User Interface-GUI)

The WHITESTAR SIGNATURE™ System graphic screen display is easy to read and easy to operate. You can see at a glance the status of the system. The screen gives you visual indication of operating modes, settings, and system status. Messages cue you through the procedure, and error messages indicate improper connections or selections. Help information is available from the touch screen controls.

Prime/Tune

Before the start of each surgical case, the system requires Prime, Tune or Prime/Tune to be executed. The Prime mode incorporates the function of tubing purge, and fills and completes the fluid aspiration and vacuum check. The Tune mode incorporates the ultrasonic power calibration and safety check for the connected phaco handpiece. The Prime/Tune mode allows the system to prime and tune the handpiece at the same time.

Dual Pump

The WHITESTAR SIGNATURE™ System provides a fluid aspiration system using either a peristaltic (flow-based) pump or a Venturi (vacuum-based) pump system. The surgeon can utilize the Venturi pump in the Phaco, IA, and Vitrectomy surgical modes.

Continuous Irrigation

Continuous Irrigation is immediately available via dedicated keys on the touch screen and the wireless remote control. Surgeon control of Continuous Irrigation with the footpedal is also available. Continuous Irrigation can be used to fill cups prior to Prime/Tune. The Cup Fill feature can be used in place of Continuous Irrigation when you fill a cup. The Cup Fill feature is only available from the Prime/Tune screen. (See Chapter 4 Equipment Operation, Prime/Tune for Detailed information.)

Programmable Operating Parameters

The WHITESTAR SIGNATURE™ System is programmable through the screens on the touch screen monitor. You can select your desired settings for each portion of the anterior surgical procedure. Up to 50 surgeon names with a maximum of 20 different setups, plus the AMO® default settings program can be stored in the instrument program memory. This allows different users to preset their preferences, or an individual user to select setups for different procedures, including a personalized initial operating mode.

MMP – Multiple Mode Programming

Multiple submodes are available within the WHITESTAR SIGNATURE™ System operating modes. This allows you to preset your settings for specific techniques such as phaco chop or viscoelastic removal.

Programmable IV Pole

The WHITESTAR SIGNATURE™ System is equipped with a programmable IV pole. The programmable IV pole height settings can be entered independently for each of the PHACO modes plus settings for Diathermy, IA and Vitrectomy. During surgery, the programmable IV pole height changes to the preprogrammed height when you switch modes.

The automated and programmable IV pole allows adjustment of the bottle height to provide gravity infusion through each procedural phase. Two adjustment keys on the touch screen or the wireless remote control are used to raise and lower the bottled balanced salt solution, while maintaining the sterility of the operating field. A separate up and down switch allows IV pole adjustment from the side of the system.

WHITESTAR SIGNATURE™ System Operating Modes

The WHITESTAR SIGNATURE™ System was designed to provide all the Operating Modes and surgical capabilities required by the anterior segment or cataract surgeon. These capabilities include:

Diathermy (DIA)

The Diathermy mode is used by most surgeons to coagulate blood vessels during the procedure and by some surgeons to “coag” the conjunctiva at the end of the procedure. An isolated output frequency allows non-contact tissue coagulation, eliminating adhesion and traction. Also, the depth of penetration of the energy field is less than that of lower frequency units, which minimizes tissue shrinkage or charring. The gentleness of the diathermy mode allows the surgeon to stop “bleeders” within the incision with only minimal scleral shrinkage.

Phacoemulsification (PHACO)

The Phacoemulsification mode is used to break up (emulsify) the nucleus of the lens and then allows the nucleus of the lens to be aspirated from the eye through a small incision. The continuous autotuning circuitry maximizes the emulsification efficiency for each lens density, even varying densities within the same lens. Phaco time is displayed in minutes and seconds. The convenient selection of linear or panel preset phaco power, in a variety of power delivery options (pulsed, burst, transversal), provides increased precision and control.

The WHITESTAR[®] Technology allows you to safely remove all lens types through small incisions with single-mode, single-instrument convenience.

The WHITESTAR[®] Technology is a patented software application proven to change the characteristics of phacoemulsification using little or no ultrasound. This is done by changing the thermal properties and improving control of the lens without reducing the cutting power or changing technique or efficiency.

CASE One Touch

The One Touch button simplifies the programming of the CASE function and allows you to easily define the basic CASE settings once. The CASE function can then be adjusted quickly with the CASE One Touch settings on the surgical screens. When these controls are used, the CASE functionality can be changed to provide enhanced control or improved efficiency to suit any particular combination of cataract density, surgical technique or personal preferences.

Irrigation/Aspiration (IA)

The Irrigation and Aspiration mode allows for controlled aspiration of cortical material from the eye, while maintaining intraocular stability, by replacing the aspirated material with a balanced salt solution. A peristaltic pump provides a predictable and stable aspiration rate. Complete control is achieved with “Aspiration Rate” and “Vacuum”. Irrigation is gravity-fed.

The gravity-fed mode is regulated by adjusting the height of the balanced salt solution bottle. This mode gives you flexible control of each case with independently adjustable vacuum level and flow rate settings.

Vitrectomy (VIT)

The Vitrectomy mode is used to remove vitreous from the eye during surgery. The WHITESTAR SIGNATURE[™] System uses air pressure to drive the vitreous cutter. The wide range of user-controlled, programmable cut rates supports both anterior segment and posterior segment surgeries.

2

SYSTEM COMPONENTS

Receipt and Inspection Instructions

WHITESTAR SIGNATURE™ System Components

WHITESTAR SIGNATURE™ System with FUSION™ Tubing Pack

Receipt and Inspection Instructions

When you receive your WHITESTAR SIGNATURE™ System inspect the exterior packaging for any signs of damage that might have occurred during shipping and record this damage on the shipping documents. If there are any signs of damage, carefully unpack the WHITESTAR SIGNATURE™ System and inspect the System for damage. If any damage to the package contents has occurred, you must immediately file a claim with the transporter. The transporters accept claims only from the recipient (you), not from the shipper (AMO).

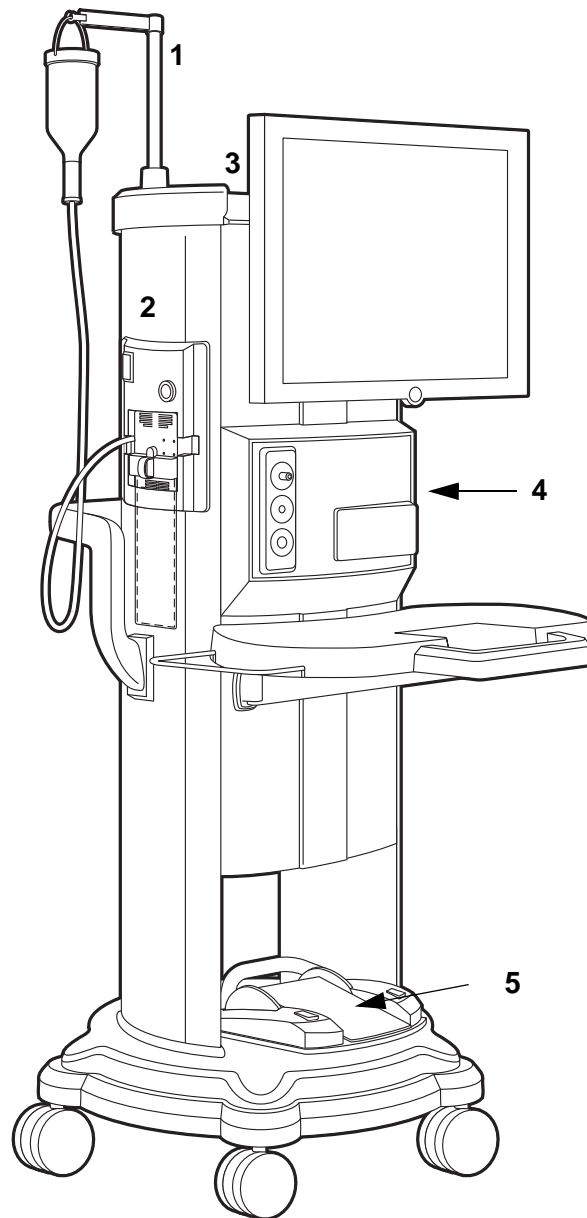
Your AMO Representative will have contacted you to schedule both the Installation and the In-Service Training when you receive your new WHITESTAR SIGNATURE™ System. **We suggest that you leave the WHITESTAR SIGNATURE™ System in the original packaging and store the package in a cool, dry environment** until the AMO installation personnel arrive to assemble, install and test your equipment. Extreme heat, cold or moisture can damage any electronic equipment.

WHITESTAR SIGNATURE™ System Components

Your WHITESTAR SIGNATURE™ System consists of some or all of the following components:

- WHITESTAR SIGNATURE™ System console with an integral cart, mayo tray on an adjustable arm and a Programmable IV Pole
- FUSION™ Tubing Pack (disposable)
- Footpedal and Power Cord (Single or Advanced Control Pedal (Dual Linear))
- Power Cord (detachable)
- Wireless Remote Control Module
- WHITESTAR SIGNATURE™ System Owner's Manual

Figure 2.1 – WHITESTAR SIGNATURE™ System



- | | |
|--|---|
| 1. Programmable IV Pole | 4. WHITESTAR SIGNATURE™ System console with Integral Cart and Mayo Tray |
| 2. FUSION™ Tubing Cassette | |
| 3. Wireless Remote Control Module (Storage bay on top of the system) | 5. Footpedal |

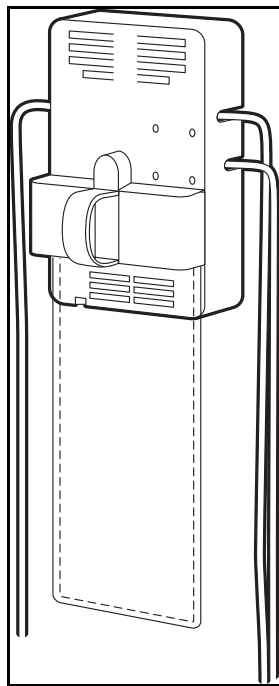
**WHITESTAR
SIGNATURE™
System with
FUSION™ Tubing
Pack**

Each surgical procedure requires a disposable FUSION™ Tubing Cassette for either the peristaltic pump or the Venturi pump. The FUSION™ Tubing Cassette only works with the peristaltic pump, which is used in anterior/cataract surgeries. The Dual Pump Tubing Cassette works with both the peristaltic pump and the Venturi pump. With the Fusion™ Dual Pump Pack you can select either pump while you are in a surgical case.

The tubing pack contains the following components:

- Tubing cassette with irrigation and aspiration tubing (administration set) with an attached, sealed drain bag
- Infusion Sleeve
- Test Chamber – to test and prime/tune the phaco handpiece
- Mayo Stand Drape – to cover the Mayo tray and arm
- Monitor Drape – to cover the front of the touch screen

Figure 2.2 – FUSION™ Tubing Cassette



Proper handling and disposal methods for biohazards must be used when you dispose of the tubing cassette, Mayo stand drape and monitor drape.

3

SYSTEM SETUP

Safety Precautions

Warnings

Symbol Definitions

System Disposal

Setup Sequence – Anterior Segment Surgery

Footpedal

Programmable IV Pole

Wireless Remote Control (Optional)

Surgical Media Center (SMC) (Optional)

Shutdown Sequence – Anterior Segment Surgery

Safety Precautions

Now that the system is set up and you have verified that all of the functions are operating properly, you are almost ready to use your WHITESTAR SIGNATURE™ System.

Read the following Safety Precautions and Warnings carefully before you use the WHITESTAR SIGNATURE™ System in surgery.

1. The WHITESTAR SIGNATURE™ System is equipped with 3-prong power plug which must be plugged into an outlet with a ground receptacle.

If the plug does not fit the outlet, contact an electrician. DO NOT modify or remove the ground pin.
2. Do not use extension cords with your system.
3. Do not overload your electrical receptacle (outlet).
4. If the cord or plug is damaged, do not use the instrument. An electric shock or fire hazard can result. Call AMO customer service to order a new cord.
5. The instrument has ventilation openings at the rear of the console to allow ambient air intake and the release of heat generated during operation. If the openings are blocked, heat build-up can cause system failures which can result in a fire hazard.
6. Do not try to move the WHITESTAR SIGNATURE™ System cart on deep pile carpets or over objects on the floor such as cables and power cords.
7. Take care not to trip over power and footpedal cords.
8. Do not try to lift the WHITESTAR SIGNATURE™ System cart.
9. Do not place the instrument on uneven or sloped surfaces.
10. Do not use disposables, accessories or other surgical instruments that are not designed for this system. Use only parts recommended by AMO to achieve optimum performance and safety.
11. Do not operate the WHITESTAR SIGNATURE™ System in a condensing environment. Take care to protect the instrument from fluid sprays or fluid buildup.
12. To protect the patient from contaminated fluids or handpieces, use only:
 - sterile tubing cassettes
 - sterile irrigation fluid
 - sterile handpieces
13. Use caution when you extend, retract or swivel the Mayo stand articulating arm. Stay clear of the hinged hardware.
14. Use caution when you use handpieces with sharp edges or pointed tips.

15. Always replace the tubing cassette between cases.
16. Wrap the excess power cord neatly around the cord wrap on the back of the console.

Changing Irrigation Flow

Use extreme caution when you lower or raise the balanced salt solution bottle to decrease or increase fluid flow and pressure. If you lower the bottle too much it can cause the anterior chamber to collapse. If you raise the bottle too high it can cause the anterior chamber to deepen. To make sure that the bottle height does not go too high, you can set the maximum bottle height on the Diagnostics screen.

Note: Use a new bottle of balanced salt solution at the start of each case.

Phacoemulsification without Adequate Irrigation

Operating phacoemulsification without an adequate irrigation flow can result in an elevated temperature of the tip and subsequent damage to the eye tissue or could cause the chamber to collapse. Confirm that there is irrigation flow before you initiate phacoemulsification. A tight wound or the angle of the needle next to the wound can also constrict the irrigation flow by pinching the coaxial irrigation sleeve assembly on the needle of the phaco handpiece.

Power Failure during Surgery

If there is a loss of power during a procedure, you need to:

- Withdraw the handpiece from the eye
- Release the footpedal to Position 0

When power is restored:

- Select Prime/Tune to reprime the fluids and tune the phaco handpiece. Use **Bypass** to reduce the length of prime time.
- Select the mode that was in use when power was lost (PHACO, IA, Vitrectomy or Diathermy)

Connecting Handpieces

It is very important that the electrical connectors on the handpieces are completely dry before they are connected to the WHITESTAR SIGNATURE™ System receptacles. You can receive a “Handpiece Ground Fault Error” message if the connector is wet.

Handling the Phaco Handpiece

The phaco handpiece is a very delicate instrument and must be handled with EXTREME care. If the handpiece is dropped or receives any other significant impact, the handpiece will not work properly. The ultrasonic titanium phaco tip must never touch any solid material while in use.

Always flush the handpiece immediately following surgery.

See cleaning instructions given in Chapter 9, “Care and Cleaning”.

Handpieces can be extremely hot immediately after sterilization. Use care and caution when handling.

Phaco and Vitrectomy Operation

The phaco handpiece and the vitrectomy cutter must never be activated with the tips exposed to air. If the tips are activated in the air, the useful life of the handpiece and the cutter is reduced. If power is to be introduced to the phaco handpiece or the vitrectomy cutter, the tips must be in a test chamber filled with a balanced salt solution, in a container of balanced salt solution, or in the patient's eye.

Vitrectomy

Failure to properly attach the tubing to the appropriate vacuum or pressure source can affect the vitrectomy cutter operation. Be sure to read the vitrectomy cutter package insert for correct assembly and connection procedures.

Diathermy

When you enter the Diathermy mode, an audible tone should be heard. Also, whenever diathermy power is applied, an audible tone should be heard.

The diathermy cable must be checked periodically for damage. If the cable shows signs of damage, replace the cable immediately with the same type of cable. Use of other types of cables can affect the diathermy performance.

During surgery, the diathermy output power must be as low as possible for the intended purpose. AMO recommends the 30% setting to start.

The diathermy cable must be positioned in such a way that contact with the patient or other leads is avoided. Grounded or ungrounded metal parts must not come in contact with the patient when diathermy is used.

For proper operation of the diathermy, replace the handpiece with the same type.

Programmable IV Pole

Do not exceed the maximum weight of two 500 ml balanced salt solution bottles on the IV pole bottle holder.

Wireless Remote Control and Wireless Foot Pedal

These devices comply with part 15 of the FCC (Federal Communications Commission) Rules. Operation is subject to the following two conditions:

1. This device may not cause harmful interference.
2. This device must accept any interference received, including interference that may cause undesired operation.

Any changes or modifications not expressly approved by Advanced Medical Optics, Inc. can void the user's authority to operate the equipment.

Note: This equipment has been tested and found to comply with the limits for a Class A digital device, pursuant to part 15 of the FCC Rules. These limits are designed to provide reasonable protection against harmful interference when the equipment is operated in a commercial environment. This equipment generates, uses, and can radiate radio frequency energy and, if not installed and used in accordance with the instruction manual, may cause harmful interference to radio communications. Operation of this equipment in a residential area is likely to cause harmful interference in which case the user will be required to correct the interference at his own expense.

Warnings



WARNING: All personnel who might operate this equipment must read and understand the instructions in this manual before the system is used. Failure to do so might result in the improper operation of the system. This device is only to be used by a trained licensed physician.



WARNING: The fluid level in the balanced salt solution bottle must be monitored by the surgical nursing staff. The result of a low bottle or an empty bottle affects the fluid balance and the intra-ocular pressure (IOP) while aspirating. The low or empty bottle can result in:

- The inadvertent chamber shallowing or collapse
- The Aspiration of tissue
- An ultrasonic wound heating commonly called wound burn (extreme case)

The surgical staff must monitor the fluid level at all times.



WARNING: DO NOT attempt to use the system if the system fails to perform properly as stated in this manual.



WARNING: DO NOT use the System in the presence of flammable anesthetics, or other flammable gases, near flammable fluids or objects, or in the presence of oxidizing agents, as a fire could result.



WARNING: This unit might interfere with any cardiac pacemaker fitted to the patient; therefore qualified advice must be obtained prior to such use.



WARNING: The patient must not come into contact with metal parts which are grounded or have appreciable capacitance to ground. The use of an antistatic mat for this purpose is recommended.



WARNING: Proper handling and disposal methods for biohazards must be used when you dispose of the tubing cassette, mayo stand drape and monitor drape.



WARNING: Monitoring electrodes or other types of equipment must be placed as far from those of the WHITESTAR SIGNATURE™ System as possible. High current limiting devices are recommended for the protection of such systems. Needle monitoring electrodes are not recommended.



WARNING: Keep the diathermy cord away from the patient and other handpieces or leads (for example, monitoring electrodes).



WARNING: The output power selected must be as low as possible for the intended purpose.



WARNING: Although this unit complies with all Electromagnetic Interference (EMI) standards and requirements, it is possible that interference provided by the operation of the HIGH FREQUENCY (HF) SURGICAL EQUIPMENT can adversely influence the operation of other electronic equipment.



WARNING: Skin to skin contact on the patient, for example, between the arms and the torso is not recommended. Insert dry gauze to avoid contact, as appropriate.

Note: The unit does not contain any neutral electrode.

Note: The diathermy output is bipolar.

Note: It is recommended that the condition of all inter-connecting and handpiece cables be checked on a regular basis.



WARNING: Risk of burns and fire. Do not use the system near conductive materials such as metal bed parts, inner spring mattresses, or similar items. Replace electrode cables on evidence of deterioration.



WARNING: Hazardous electrical output. This equipment is for use only by qualified personnel.



WARNING: Disconnect the power before you service the equipment.



WARNING: Remove the power cord from the power outlet when the equipment is not in use.



WARNING: Do not obstruct the power outlet so that the power cord can be readily removed, as needed.



WARNING: Not recommended for use in condensing environments. If exposed to a condensing environment, allow the system to equilibrate to typical operating room conditions prior to use.



WARNING: This HIGH FREQUENCY (HF) SURGICAL EQUIPMENT is specified for use without a NEUTRAL ELECTRODE.



WARNING: Failure of the HIGH FREQUENCY (HF) SURGICAL EQUIPMENT could result in an unintended increase of output power.



WARNING: DO NOT try to replace the Wireless Remote Control batteries. Call your AMO Technical Service representative to replace the batteries.



WARNING: Sterility assurance is the responsibility of the user. All non-sterile accessories must be sterilized prior to use.



WARNING: Prior to using any invasive portions of the handpiece assembly, examine under the microscope for any obvious damage, oxidation, or the presence of foreign material. If any questionable characteristics are noted, use a backup handpiece for surgery. Use of contaminated or damaged system accessories can cause patient injury.





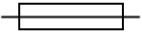




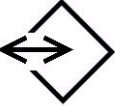












WARNING: Use of non-AMO approved products with the WHITESTAR SIGNATURE™ System, can affect overall system performance and is not recommended. AMO cannot be responsible for system surgical performance if these products are utilized in surgery.





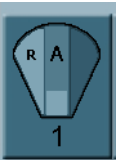




Symbol Definitions

The following symbols appear on the WHITESTAR SIGNATURE™ System front and back panels and in the software:

Table 3.1 – Symbol Definitions

Symbol	Definition
	Symbol on power switch indicates Power is On.
	Symbol on power switch indicates Power is Off.
	Indicates that there are important operating and maintenance instructions included in the Owner's and Operator's Manual.
	Indicates the presence of uninsulated high voltage inside the instrument. Risk of electric shock. Do not remove the instrument cover.
	Indicates fuse.
	Single phase alternating current.
	Patient applied part is isolated from earth ground.
	Patient applied part is grounded OR no direct electrical energy is involved.
	Footpedal connection.
	Communications Port

Symbol	Definition
	Programmable IV Pole
	Diathermy Receptacle
	Phaco Handpiece Receptacle
	Vitreotomy Cutter Connection
	Potential Equalizer
	Indicates compliance with the Medical Device Directive.
	Separate Disposal/Collection Required
	Environment Friendly Use Period in Years (RoHS)
	Indicates compliance with IEC 60601-1-2:2001, "Electromagnetic Compatibility Requirements and Tests for Medical Electrical Equipment."
	ETL Listed Mark issued to those products that have met the requirements of product safety standards for the United States and Canada. (ETL formerly Edison Testing Laboratory)

Symbol	Definition
	Universal Serial Bus (USB) Port Note: Use only AMO recommended USB stick drives.
	Federal Communications Commission (FCC) The FCC regulates interstate and international communications by radio, television, wire, satellite and cable under the FCC's jurisdiction.
	FUSION™ Mode button used to open the CASE settings screen.
	Single Linear Foot Pedal Icon. Shows the position of the footpedal when the footpedal is pressed. The number shown changes when the position is changed.
	Advanced Control Pedal (Dual Linear) Icon. Shows the position of the footpedal when the footpedal is pressed. The number shown changes when the position is changed. The letters indicate the location of Aspiration (A), Irrigation (I), Phaco (P), Reflux (R), Whitestar Increment/Decrement (WS) and Switch (S).
	WHITESTAR® Technology is On .
	WHITESTAR® Technology is On and ICE Pulse Shaping is On .
	Ellips™ Technology is On .
	Reload button is used to cycle through the surgeon's programs.

System Disposal**WEEE**

The electronic components of the WHITESTAR SIGNATURE™ System are subject to the European Union Directive 2002/96/EC on Waste Electrical and Electronic Equipment. This directive applies to all electronic equipment in the European Union only.

The disposal to municipal waste is prohibited for electronic equipment subject to this directive; this equipment must be treated or recycled. Each component that is subject to this regulation is marked on the component itself with the following symbol:



In some cases where the component's size prohibits marking (such as handpieces) the marking can be found on the directions for use and the warranty. Treatment and/or recycling of the electronic equipment are provided at no cost to you. Please see the contact information below for disposition of unwanted AMO electronic equipment.

For disposal of your unit, contact your local AMO subsidiary or the AMO service center nearest you.

<p>Belgium</p> <p><i>Contact</i> De Ceunynck Medical nv/sa Kontichsesteenweg 36 B-2630 AARTSELAAR Belgium</p>	<p>Denmark</p> <p><i>Distributor</i> AMO Denmark ApS c/o Advanced Medical Optics Norden AB Kanalvagen 3A SE 194 61 Upplands Vasby Sweden</p>
<p>Finland</p> <p>AMO Norden AB Vantaa/Finland Rajatorpantie 41 C, 3. krs FIN-01640 Vantaa Finland Phone: +358 9 8520 2192</p>	<p>France</p> <p>AMO France SAS Greenside 15, 750 Avenue de Roumanille 06410 Biot France Phone: +33 4 93 00 11 95</p>

<p>Germany</p> <p>AMO Germany GmbH Rudolf-Plank Strasse 31 D-76275 Ettlingen Germany Phone: +49 7243 729 444 (Hotline)</p>	<p>Greece</p> <p><i>Distributor</i> Nexus Medicals s.a. 12th km Nat. Road Ave Athens- Lamia & Zakynthou str. 14451 Metamorfosi Athens Greece</p>
<p>Ireland</p> <p>AMO Ireland Block B Liffy Valley Office Campus Quarryvale, Co. Dublin Ireland</p>	<p>Italy</p> <p>AMO Italy Srl Via Pio Emmanuelli, n.1 00143 Rome Italy Phone: +39 06 51 29 61</p>
<p>Netherlands</p> <p>AMO Netherlands B.V. Kantoorgebouw La Residence Weverstede 25 3431 JS Nieuwegein The Netherlands Phone: +31 (0)30 600 8787</p>	<p>Norway</p> <p><i>Distributor</i> Advanced Medical Optics Norway AS c/o Advanced Medical Optics Norden AB Kanalvagen 3A SE 194 61 Upplands Vasby Sweden</p>
<p>Poland</p> <p><i>Distributor</i> Oko-Vita Polska sp.z.o., ul Marywilska 34, 03-228 Warsaw, Poland</p>	<p>Portugal</p> <p>Advanced Medical Optics Spain S.L. sucursal em Portugal Praca Nuno Rodreguez dos Santos nº 7, 1600-171 Lisboa Portugal</p>
<p>Russia</p> <p><i>Distributor</i> Tradomed Ltd., Marksistskaya Str. 3, Bld 1, Moscow, 109147, Russia</p>	<p>Spain</p> <p>Advanced Medical Optics Spain, S.L. c/Dr. Zamenhof, n. 22, 4B 28027 Madrid Spain Phone: +34 9176 88 000</p>

Sweden Advanced Medical Optics Norden AB Kanalvagen 3A SE 194 61 Upplands Vasby Sweden	Switzerland <i>Distributor</i> AMO Switzerland GmbH, Churerstrasse 160 B, CH-8808 Pfäffikon, Switzerland
United Kingdom AMO United Kingdom Ltd Jupiter House Mercury Park Wooburn Green High Wycombe Buckinghamshire HP10 0HH United Kingdom Phone: +44 1628 551600	

RoHS (Restriction of Hazardous Substances)

For Chinese Regulation: Administrative Measure on the Control of Pollution Caused by Electronic Information Products

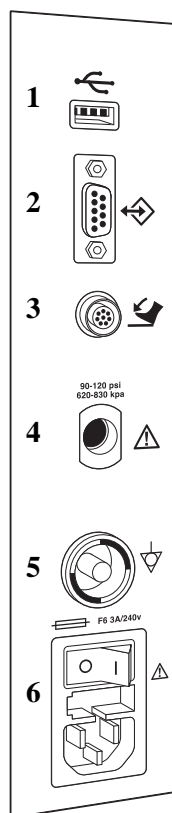
Table 3.2 – Names and Content of Toxic and Hazardous Substances or Elements

Parts Name	Toxic and Hazardous Substances or Elements					
	Pb	Hg	Cd	Cr6+	PBB	PBDE
Housing	x	o	o	x	o	o
Power Supply	x	o	o	x	x	x
Motherboard	x	o	o	o	x	x
Rear Panel Assembly Board	x	o	o	x	x	x
Pneumatics	x	o	o	x	o	o
LCD	x	x	o	o	x	x
Base Unit	x	o	o	o	x	x
Fluidics	x	o	o	x	o	o
o: Indicates that this toxic or hazardous substance contained in all of the homogeneous materials for this part is below the limit requirement in SJ/T11363-2006						
x: Indicates that this toxic or hazardous substance contained in at least one of the homogeneous materials used for this part is above the limit requirement in SJ/T11363-2006 (Enterprises may further provide in this box technical explanation for marking "X" based on their actual conditions.)						

**Setup Sequence –
Anterior Segment
Surgery**

The following is a general overview of the steps to be taken to prepare the WHITESTAR SIGNATURE™ System for surgery:

1. Connect the WHITESTAR SIGNATURE™ System power cord to the rear of system. Plug the power cord into a grounded power outlet.
2. Connect the footpedal to the rear panel receptacle.
3. Connect the compressed air line to the compressed air receptacle (optional).
4. Turn the system On at the back of the console.
5. Press the On/Off button on the Touch Screen monitor.
6. After completion of the Start Up Self Test, select the surgeon and program.
7. Install the tubing cassette, attach the required accessories (phaco, vitrectomy or diathermy handpieces) and set up the tubing.
8. Prime and tune the handpieces. (Refer to Chapter 4, Equipment Operation, *Prime/Tune.*)
9. Perform the final test of the fluidics and the handpiece integrity with the footpedal. (Refer to Chapter 4, Equipment Operation, *Verify Irrigation/Aspiration Balance.*)

Figure 3.1 – Rear Panel Connections

1. USB Port
2. Communications Port
3. Foot Pedal Connector

4. Compressed Air
5. Potential Equalizer
6. Power Switch and Power Cord Connection

Phacoemulsification Ultrasonic Handpiece



WARNING: Sterility assurance is the responsibility of the user. All non-sterile accessories must be sterilized prior to use.



WARNING: Prior to using any invasive portions of the handpiece assembly, examine under the microscope for any obvious damage, oxidation, or the presence of foreign material. If any questionable characteristics are noted, use a backup handpiece for surgery. Use of contaminated or damaged system accessories can cause patient injury.

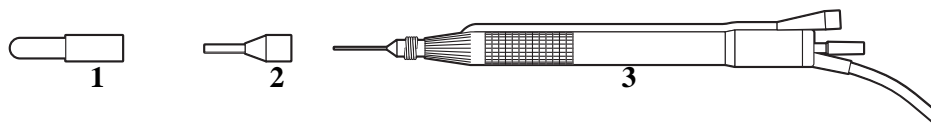
1. Use caution to prevent burns when handling the handpiece directly from sterilization.
2. Remove the tubing cassette and accessories from the tubing pack and place them in the sterile area.

3. Assemble the phaco handpiece as shown below. You need the handpiece, titanium phaco tip, the appropriate tip wrench, one of the infusion sleeves and the test chamber.



CAUTION: NEVER ATTEMPT TO STRAIGHTEN A BENT NEEDLE. THIS MIGHT PRODUCE A BROKEN TIP WHEN ULTRASOUND IS APPLIED.

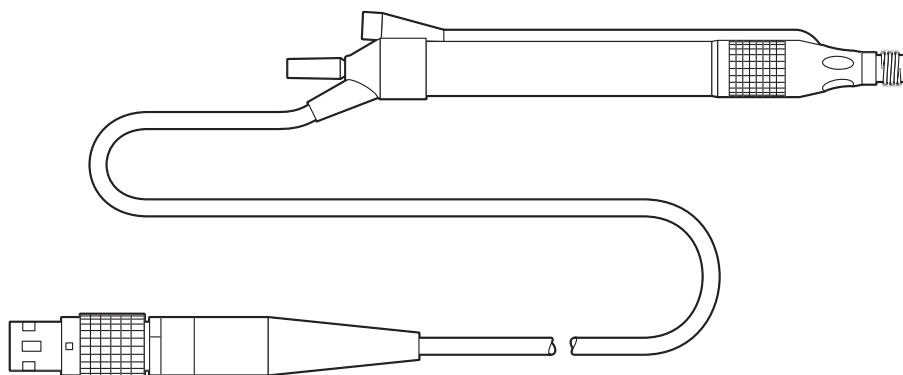
Figure 3.2 – Phaco Handpiece Assembly



1. Test Chamber
2. Infusion Sleeve
3. Handpiece with Tip

4. Attach the connector end of the handpiece to the phaco receptacle on the front of the WHITESTAR SIGNATURE™ System. **Make sure there is no moisture on the connectors prior to connecting. Moisture prevents the handpiece from operating properly.**

Figure 3.3 – Ellips™ Handpiece



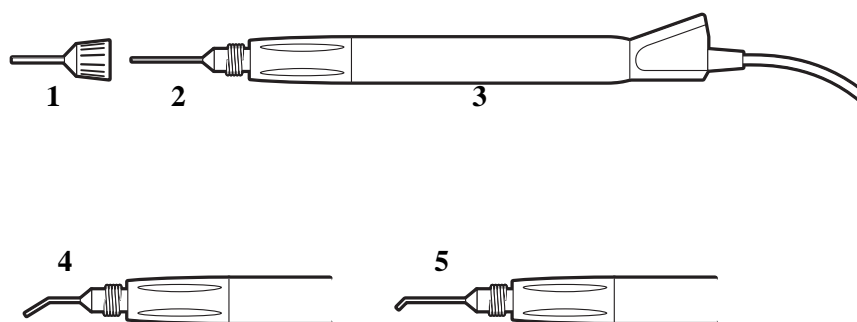
Note: The Ellips™ handpiece can be used with WHITESTAR® Technology and Ellips™ Technology phaco settings.

Irrigation/Aspiration Handpiece

1. Assemble the SOLO™ Irrigation/Aspiration (IA) Handpiece by attaching the infusion sleeve.

Note: The infusion sleeve and the test chamber are provided in the FUSION™ Tubing Pack. The LAMINAR™ Flow 20 ga. infusion sleeves can also be used and are available with the OPOS20L or any 20 ga. LAMINAR™ Phaco Tip.

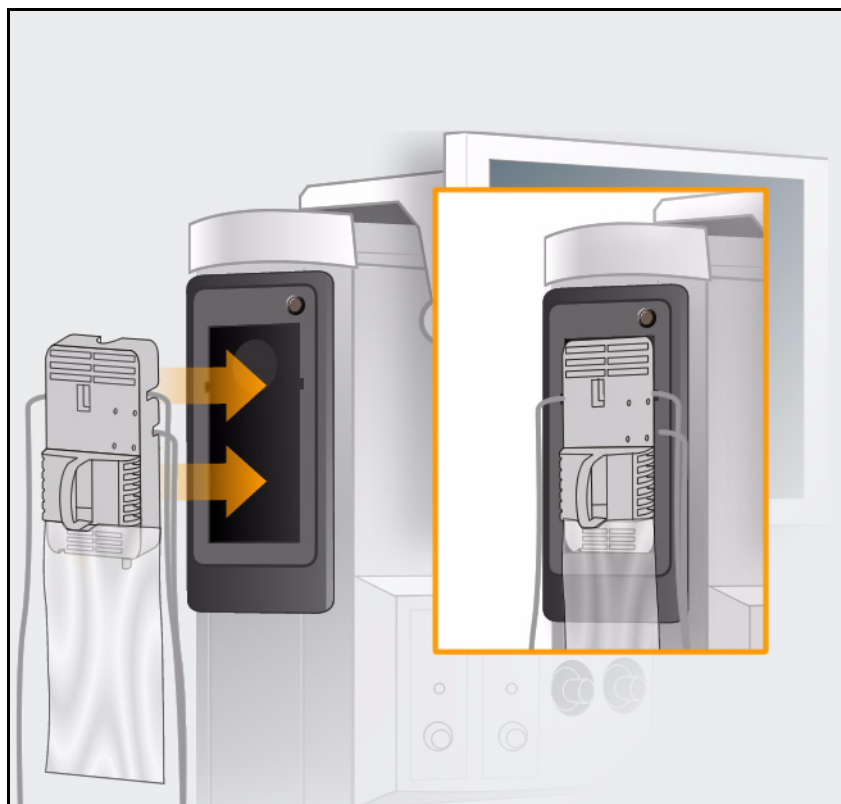
Figure 3.4 – IA Handpiece Assembly



- | | |
|-----------------------|----------------------------------|
| 1. Infusion Sleeve | 4. SOLO™ Curved Tip |
| 2. SOLO™ Straight Tip | 5. SOLO™ 45° Silicone Sleeve Tip |
| 3. Handpiece | |

Load the FUSION™ Tubing Cassette

1. Open the tubing pack packaging.
2. Install the FUSION™ cassette into the side receptacle, as shown below.
3. Make sure that the drainage bag is properly attached to the cassette.

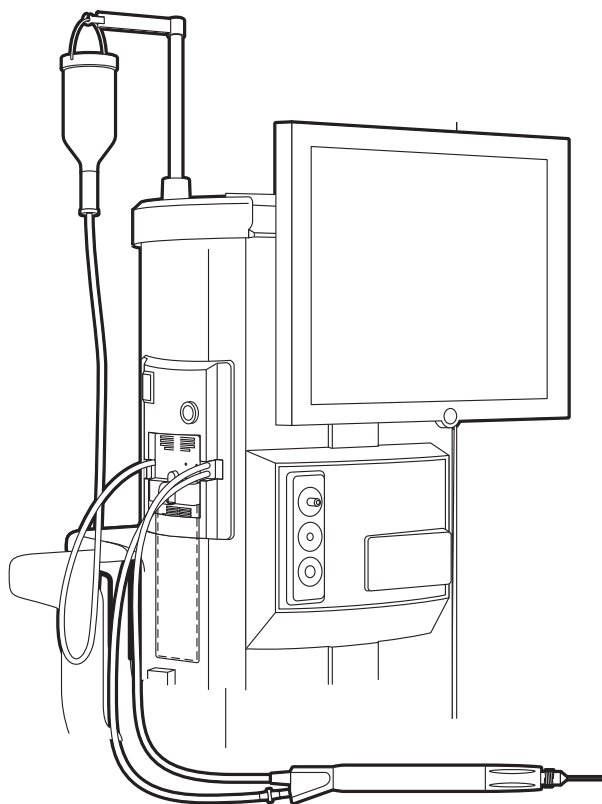
Figure 3.5 – Loading the FUSION™ Tubing Cassette

Note: Press the button above the cassette to remove the cassette.

Setup Completion

IMPORTANT! Before you insert the spike into the bottle, shake the irrigation drip chamber at the end of the irrigation tubing to confirm that the irrigation valve moves. If the valve does not rattle, the valve cannot operate properly and irrigation cannot flow.

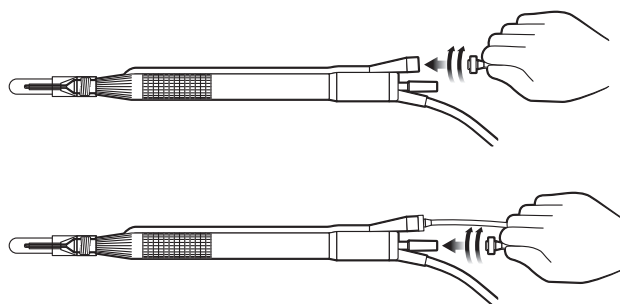
1. Place a new bottle of balanced salt solution on the top of the system console.
2. Insert the drip chamber spike into the balanced salt solution bottle.
3. Hang the balanced salt solution bottle from the Programmable IV Pole and squeeze the drip chamber.
4. Fill the drip chamber with fluid to the half-full level. The Programmable IV Pole moves to the appropriate height automatically.
5. Raise or lower the pole if needed. Use the IV pole **Up** and **Down** arrows on upper right of the touch screen. You can also use the Up/Down switch on the console.

Figure 3.6 – System Setup

6. Connect the IA tubing to the desired handpiece.
7. Insert the male luer end of the irrigation tubing into the phaco handpiece.
8. Attach the female luer fitting end of the aspiration tubing to the phaco handpiece.

Note: To protect the patient from contamination, use only:

- sterile tubing sets
- sterile irrigation fluid
- sterile handpieces

Figure 3.7 – Phaco Handpiece Connections

Diathermy

1. Connect the diathermy cord to the Diathermy Forceps or Pencil Probe.
2. Connect the diathermy cord to the diathermy receptacle on the front panel.

Figure 3.8 – Diathermy Forceps

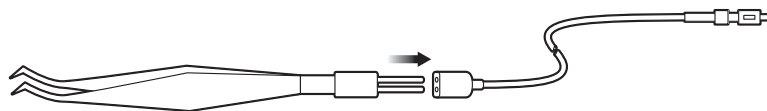


Figure 3.9 – Diathermy Pencil



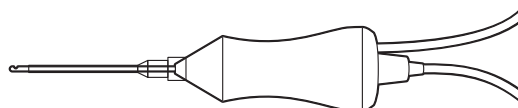
Note: Other diathermy accessories are regionally available. Contact your AMO representative.

Vitrectomy

If vitrectomy is indicated during surgery:

1. Connect the AMO[®] Vitrectomy Cutter as shown below. Vitrectomy requires the following components:
 - IA Tubing (from FUSION[™] Tubing Cassette)
 - Vitrectomy Cutter
 - Vitrectomy Infusion Sleeve, or a 23 Gauge Limbal Infusion Needle, if desired.
2. Assemble the handpiece using the instructions provided with the vitrectomy cutter.

Figure 3.10 – Vitrectomy Cutter



3. Attach the connector end of the vitrectomy cord to the vitrectomy receptacle on the front panel.

Pre-Operative Sterilization

The Instrument Sterilization Procedures in Chapter 9, “Care and Cleaning” identify the WHITESTAR SIGNATURE™ System instruments that must be sterilized prior to each surgical case. The recommended sterilization techniques, times and temperatures are given in Chapter 9, “Care and Cleaning”. AMO recommends that you follow the sterilization guidelines to maximize the life of your WHITESTAR SIGNATURE™ System instruments.

Footpedal

The footpedal controls all of the WHITESTAR SIGNATURE™ System functions, therefore, it is essential that you understand the footpedal operation.

The System software automatically detects if a footpedal and what type of footpedal is connected during power up.

The footpedal settings and adjustments can be selected and preset for the footpedal in the Configuration screen. Instructions for the footpedal settings are given in Chapter 5, “Anterior Segment Surgery Operating Modes”. The footpedal housing incorporates a handle, making the footpedal easy to grip for repositioning and storage.

The Footpedal cable attaches to the footpedal connector on the rear of the console. The Advanced Control Pedal (dual linear) can also be setup with a wireless connection.

Note: You must **NEVER** handle the footpedal by the cable.



WARNING: Use only NiMH type batteries in the wireless Advanced Control Pedal.

Figure 3.11 – Footpedal - Single Linear

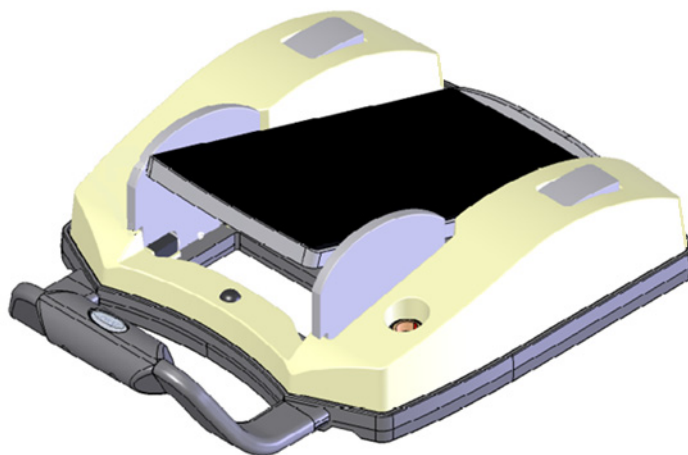
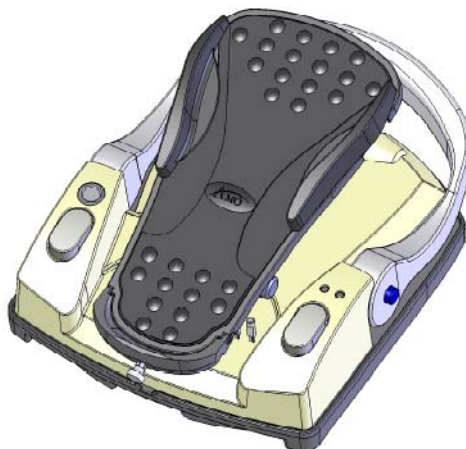
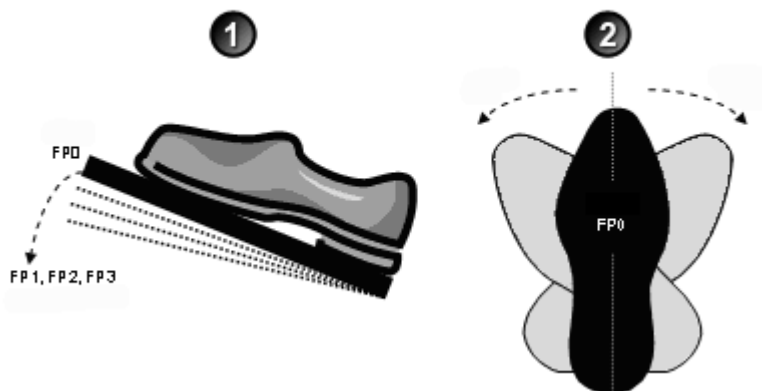


Figure 3.12 – Footpedal - Advanced Control Pedal (Dual Linear)**Footpedal Operation**

The footpedal has three active “PITCH” ranges, which are referred to as Positions 1, 2 and 3. Position 0 is the Off position, and Position 3 is the fully pressed position. The ranges are shown below. The Advanced Control Pedal has two Yaw switches.

Figure 3.13 – Footpedal “Pitch” and “Yaw” Positions

1. Pitch
Toe Down/Up
Configurable Ranges

2. Yaw
Toe Right/Left
Configurable Ranges

The footpedal position determines the function that is delivered by the handpiece, which depends on the mode selected on the touch screen. When the footpedal has been connected, place your foot on the pedal and press to the desired position. The footpedal settings and programming are addressed in Chapter 5, “Anterior Segment Surgery Operating Modes”.

Note: Four to six minutes after the system is shutdown and power is turned off, the wireless footpedal goes into a power-save mode. To turn on the Wireless Footpedal after you start up the system, touch the **Wake-up** button.

Reflux

Reflux is the controlled backflow of fluid through the aspiration port of the handpiece. Reflux is used to gently release or dislodge unwanted material from the handpiece tip. Reflux can also be used to “tent” the incision site to allow easier tip insertion. Reflux pressure depends on bottle head pressure (IV pole height and gravity) for the FUSION™ Fluidics pack (OPO70), and as such, is not intended to clear a clogged handpiece. However, reflux can be used to identify a blockage.

The reflux action can be programmed on any available footpedal switch. This causes fluid to be expelled from the aspiration line into or towards the eye.

The reflux is active until the footpedal switch is released.

The FUSION™ Fluidics pack (OPO70):

- allows an inter-connection of the irrigation line to the aspiration line, so that sterile balanced salt solution can enter the aspiration line.
- has no time restriction for Reflux as there is no pump reversal

The DP pack (OPO71):

- includes support for the vacuum tank used in the Venturi vacuum system
- does not support inter-connecting the irrigation line to the aspiration line. Therefore, only previously aspirated fluid is being refluxed.

Programmable IV Pole

The Programmable IV Pole is controlled by the **Up** and **Down** arrows on the upper right of the touch screen, next to the bottle height indicator. The buttons on the remote control and the switch on the side of the console can also be used to control the IV Pole. These controls are used to raise and lower the pole, and the height is indicated in the Programmable IV Pole screen. The Programmable IV Pole moves at a rate of approximately 6 cm (2 inches) per second.

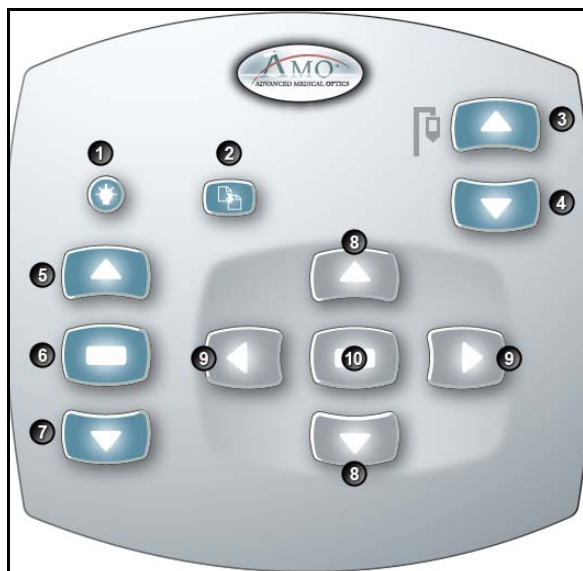
The Programmable IV Pole is adjustable from 0 to 104 centimeters, and can be set for either inches or centimeters. The height measurement is relative to the distance from the irrigation valve to the center of the drip chamber. The Programmable IV Pole height for each fluidic mode or submode (PHACO, IA, VIT) is saved in the WHITESTAR SIGNATURE™ System memory. A Maximum IV Pole height can be set on the Diagnostics screen.

When a surgery mode is selected, the Programmable Power IV Pole automatically moves to the preset height. To manually adjust the IV pole height, use the **Up** and **Down** arrows on the touch screen. Manual adjustments to the IV pole can also be made by pressing the rocker switch located on the side of the console. If a maximum height has been set, the IV pole will not move above that height.

Wireless Remote Control (Optional)

The wireless remote control keypad can be used to operate the WHITESTAR SIGNATURE™ System. All Modes, Programs, Diagnostics and End Case can be accessed and adjustments to the settings can be made with the remote control. The buttons on the remote keypad work the same as the controls on the WHITESTAR SIGNATURE™ System touch screen.

Figure 3.14 – Wireless Remote Control Module



- | | |
|------------------------|--------------------------|
| 1. Remote Backlight On | 6. Mode Select |
| 2. Reload | 7. Mode Down |
| 3. IV Pole Up | 8. Navigation Up/Down |
| 4. IV Pole Down | 9. Navigation Left/Right |
| 5. Mode Up | 10. Select |

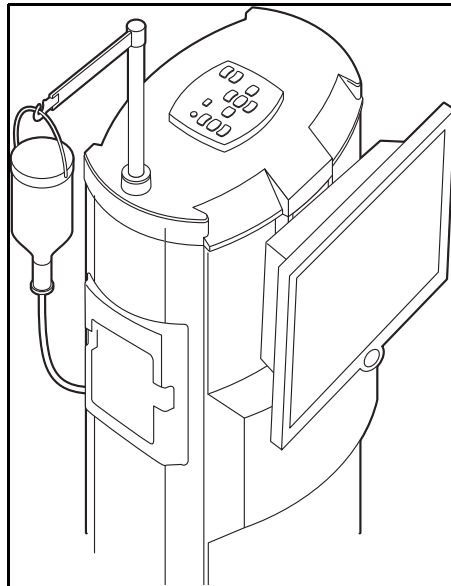
When not in use, store the Wireless Remote Control on the top of the system to charge the batteries.

After you turn the system On, press the Remote Control Backlight button to activate the Remote Control. When the system is Off the Remote Control is in a power save mode.

Note: After four to six minutes of idle time, the Remote Control goes into a power-save mode. To turn the Remote Control on, press the Backlight button.

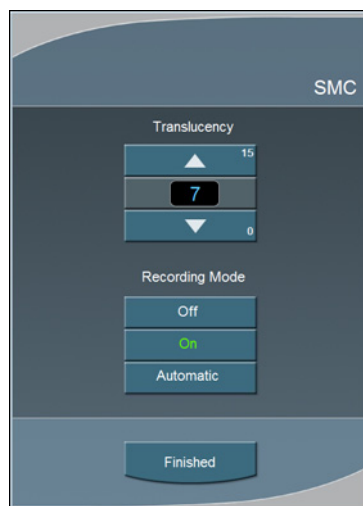


WARNING: DO NOT try to replace the Wireless Remote Control batteries. Call your AMO Technical Service representative to replace the batteries.

Figure 3.15 – Wireless Remote Control Module Storage**Surgical Media Center (SMC)
(Optional)**

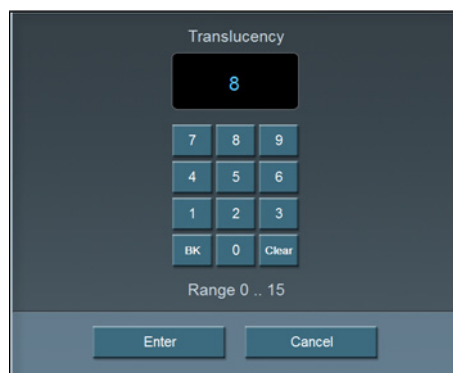
The Surgical Media Center (SMC) is used to record the surgery and the instrument settings to be viewed at a later date and time. The surgery is displayed on a monitor with the instrument settings. The SMC hardware is connected to your WHITESTAR SIGNATURE™ System Communications port on the rear panel. (See Figure 3.1 Rear Panel Connections.)

1. To configure the Surgical Media Center, select:
 - **Configuration**
 - **System Configuration**
 - **SMC**

Figure 3.16 – Surgical Media Center Pop-up Window

- Use the **Up** and **Down** arrows to adjust the settings. **Translucency** is used to make the overlay (instrument settings) more or less opaque.

Note: Press on the number in the control panel to open a numeric keypad and enter the required value. Press **Enter** on the Keypad pop-up window when you are finished.

Figure 3.17 – Numeric Keypad Pop-up Window

- Select the **Recording Mode**. **Off**, **On**, or **Automatic**. If the **Recording Mode** is **On**, the recording continues between cases. **Automatic** stops recording between cases.

Note: The Footpedal Switch can be set up to activate the SMC Record function.

- Press **Finished** to close the pop-up window.

**Shutdown Sequence
– Anterior Segment
Surgery**

The following is a general overview of the steps to be taken to shut the System down after surgery:

1. Select **End Case**.
2. Select **Shutdown**. At the prompt, select **Yes**.
3. Wait for shutdown sequence to complete.
4. Turn the system Off at the back of the console.
5. Remove the power cord from the power outlet.
6. Wrap the excess power cord neatly around the cord wrap on the back of the console.
7. Place the footpedal in the storage area on the console.
8. Place the Wireless Remote Control on top of the console to charge.
9. Refer to Chapter 9, “Care and Cleaning”, *Cleaning Procedures* for additional information.

4

EQUIPMENT OPERATION

Display Screens and Controls

Language Selection

Startup

Select Program and Install the FUSION™ Tubing Cassette

Prime/Tune

Verify Irrigation/Aspiration Balance

Priming for Vitrectomy

Selecting and Changing Mode Parameters

Display Screens and Controls

The touch screen is designed to give you visual indication of the status of the control systems at all times. When a mode (DIA, PHACO, IA, or VIT) is selected, the current settings are shown on the screen. As adjustments to settings are made, the screen shows the changes. The screens and controls are shown below.

Each Anterior segment surgery mode and submode has their own distinct screen setup:

- Irrigation/Aspiration
- Phaco without OCCLUSION MODE™
- Phaco with OCCLUSION MODE™ and/or CASE (FUSION™ MODE)
- Phaco with Ellips™ technology
- Vitrectomy
- Diathermy

Figure 4.1 – PHACO Screen



Additionally, there are screens or sub-screens for:

- Prime/Tune
- End Case
- Program
- Sounds
- Footpedal
- Database
- Diagnostics

Language Selection

The WHITESTAR SIGNATURE™ System features a 17-language user interface. Before you proceed, select one of the languages for your touch screen and controls. (English is the default language).

- To access the **Select Language** screen, from the main screen, select:
 - **Configuration**
 - **System Configuration**
 - **Language**
- Select the desired language from the listing.
- Press **Yes** at the confirmation pop-up. The screen automatically changes to the selected language.
- Press **Exit Settings** to proceed with the selected language.

Figure 4.2 – Language Screen

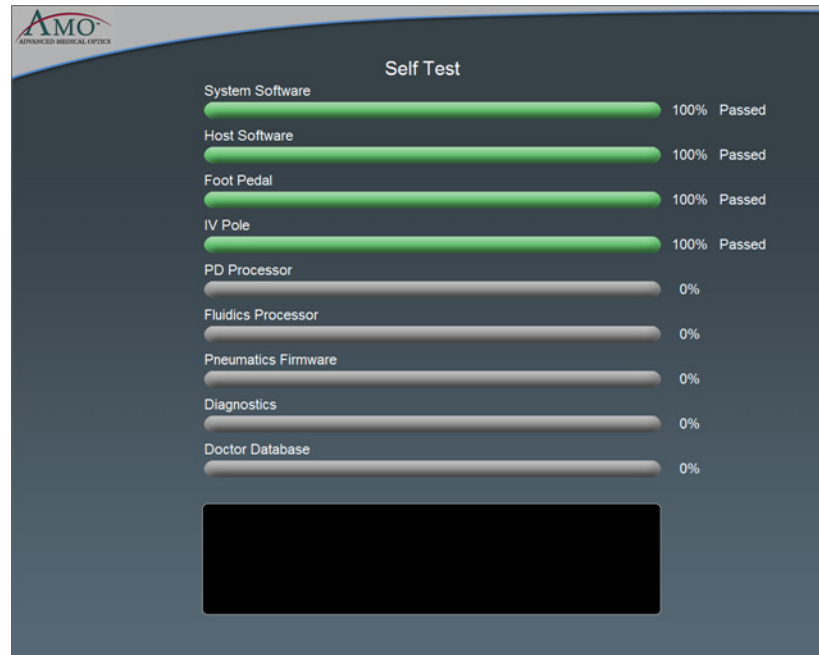


Note: On any screen, if you press the screen about 25 times, the System changes to the default language (English). You must press the same spot on the screen.

Startup

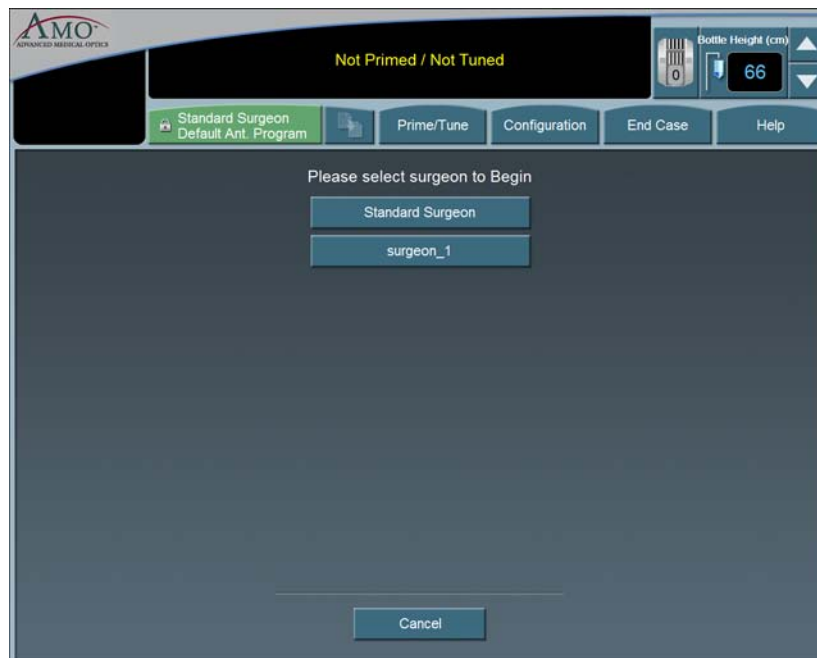
After you have turned on the WHITESTAR SIGNATURE™ System, the system performs a series of Self Tests.

Figure 4.3 – Self Test



After start up, the screen shows the available Surgeons and Programs that can be selected.

You can now select a Surgeon and a Program. A Program (or Surgeon Name) is a set of pre-established operating settings for each operating mode. The WHITESTAR SIGNATURE™ System allows you program up to a maximum of 50 Surgeon names, and 20 customized surgeon setups (programs) for each surgeon.

Figure 4.4 – Select Surgeon Screen

If Standard Surgeon is the only surgeon set up, this screen is not shown, and the System proceeds immediately to the tubing cassette installation screen.

From the Main Menu you can:

- Select a **Surgeon/Program** and begin surgery based on the values of that program
- Enter the **Settings** (Configuration) page, where you can edit, add, or delete programs and setup operating parameters
- Enter the **End Case** screen (Refer to Chapter 5, Anterior Segment surgery Operating Modes, *End Case*.)

Select Program and Install the FUSION™ Tubing Cassette

After you select a surgeon, you must select a program from the surgeon's available programs. If this is the first time the system has been used, **AMO Default Program** is the only program that appears on the screen. The first program you create uses the **AMO Default Program** settings as a starting point. You can modify the settings and **Save As** a specific program or surgeon name. The system does not let you overwrite the **AMO Default Program** when you press **SAVE**.

If a surgeon only has one program set up, this screen is not shown, and the System proceeds immediately to the tubing cassette installation screen for the type of program that is set up for that surgeon. The System automatically recognizes the type of tubing cassette that is installed.

Note: An asterisk next to a program name indicates that the surgeon as selected that program as their default program.

Figure 4.5 – Select Program Screen

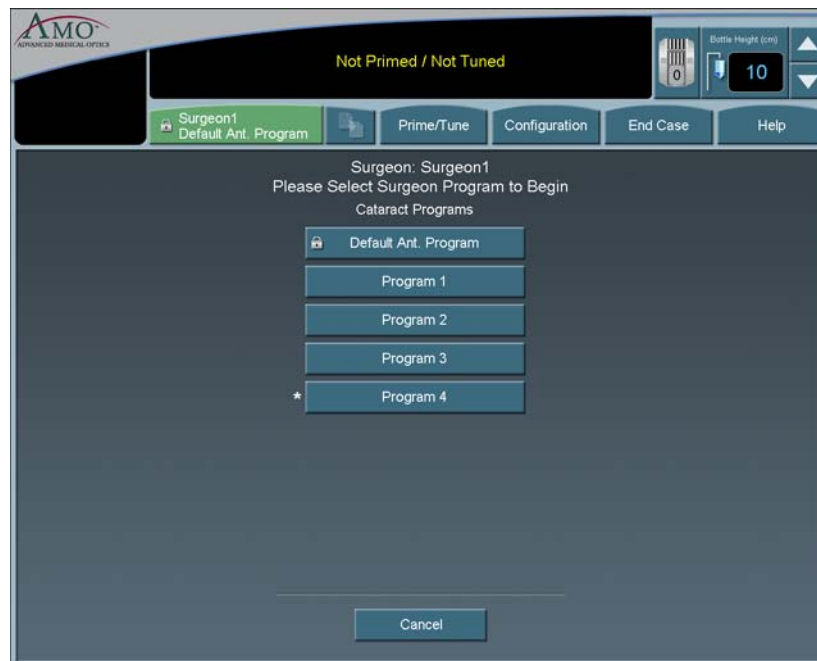
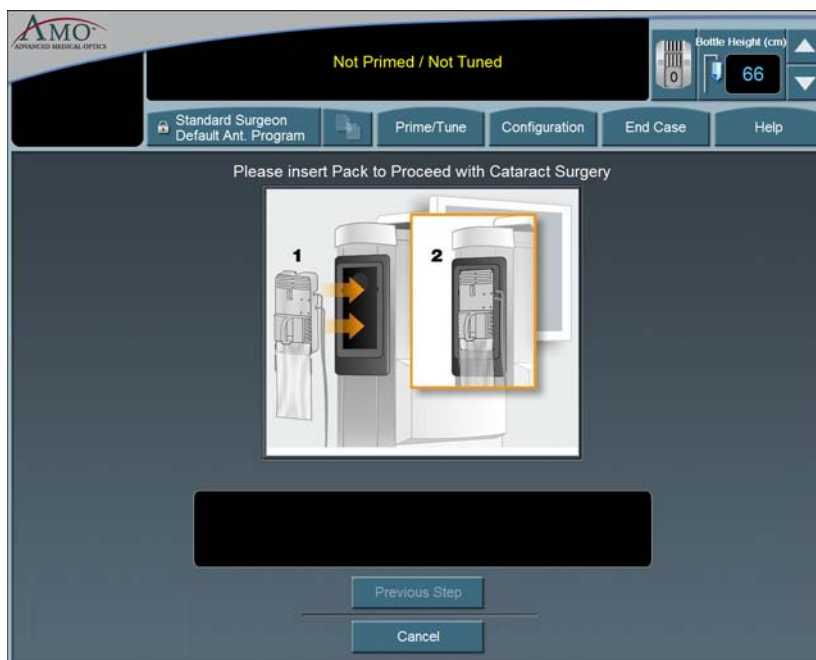


Figure 4.6 – Install Cassette Screen**Prime/Tune**

Prime/Tune is required before surgery is performed to fill the IA tubing with fluid, perform a vacuum check and to test and characterize the phaco handpiece. You must Prime and Tune:

- before each procedure
- anytime the handpiece is reconnected
- after you have inserted or replaced a tubing cassette

Continuous Irrigation can be selected to allow fluid to free flow from the bottle in order to collect fluid.

Note: Before you Prime and Tune, the Cup Fill feature can be used to fill cups. Use the **Up** and **Down** arrows to set the amount needed, either 30, 60 or 90 cc, to fill the cup and then press **Start**. The Cup Fill stops when the selected amount is dispensed or **Stop** is pressed. You can still use Continuous Irrigation to fill cups.

IA Prime is designed for a procedure that does not require a phaco handpiece. Tune is designed for a quick tune of the phaco handpiece with an IA tubing set. Tune can be used if a phaco tip is replaced during a procedure.

When you **Bypass** prime the overall fluidics prime sequence is shortened and the time to prime the WHITESTAR SIGNATURE™ System is reduced. **Bypass** can be used if **Continuous Irrigation** has been used or the I/A tubing was primed. If the I/A tubing was not properly primed, errors can occur.

To access the Prime/Tune routines, press the **Prime/Tune** button. The main console shows the Prime/Tune screen with all prime and tune options.

Note: Prime/Tune is a combination of Tune followed by IA Prime.

Figure 4.7 – Prime and Tune Screen



The WHITESTAR SIGNATURE™ System tracks the successful completion of the Prime and Tune cycle independently. In the event a retune is required (new tip, failed tune), only the **Tune** needs to be selected and run.



CAUTION: THE PHACO HANDPIECE AND VITRECTOMY CUTTER MUST NEVER BE ACTIVATED WITH THE TIP IN THE AIR. EXPOSURE OF THE TIP TO AIR DRASTICALLY REDUCES THE USEFUL LIFE OF THE HANDPIECE. IF POWER IS TO BE INTRODUCED TO THE PHACO HANDPIECE OR VITRECTOMY CUTTER, THE TIP MUST BE IN A TEST CHAMBER FILLED WITH BALANCED SALT SOLUTION, IN A CONTAINER OF BALANCED SALT SOLUTION OR IN THE PATIENT'S EYE.

Suggestions for Priming the Handpieces

Always fill the test chamber completely prior to running the Prime/Tune Cycle.

Do not lay the handpiece and the empty test chamber down and have the system fill the test chamber. This allows air to collect in the test chamber and can produce an error.

To collect the balanced salt solution:

1. Use the test chamber, a medicine cup, or similar container.

2. Use the **Up** and **Down** arrows to increase or decrease the amount of the fluid needed.
3. Press **Start** to turn on Cup Fill.
4. Use **Stop** to turn off Cup Fill before the requested amount of fluid is dispensed.
5. Perform a full Phaco Prime/Tune.

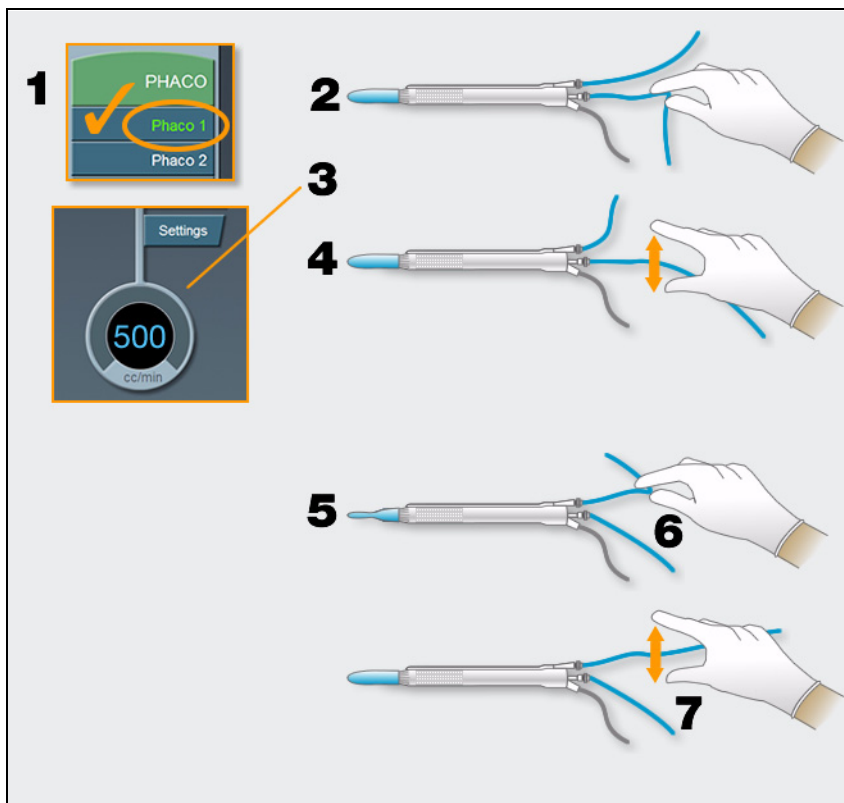
The **Prime/Tune** screen indicates the progress of the priming process.

1. Use the Cup Fill feature to fill the test chamber with fluid and to eliminate all air. If the test chamber is attached to the handpiece, remove the test chamber before you start the Cup Fill process.
2. Place the test chamber over the handpiece tip and the sleeve hub.
3. Press the **Prime/Tune** button, this starts the Prime and Tune sequences.
 - To perform a Prime only, press the **Prime** button.
 - To perform a Tune only, press the **Tune** button.
4. Make sure the movement of the IV pole is not blocked by low ceilings.
5. Watch the fluid fill the drip chamber. The fluid moves toward the handpiece and fills the test chamber.
6. The touch screen indicates the progress of the Prime and Tune process.
7. As the tubing lines are filled, the system software performs functional checks. The checks include:
 - Monitoring for the presence of irrigation flow (bottle height)
 - Leaks (via vacuum rise checks)
8. If the phaco handpiece is plugged in and **Prime/Tune** or **Tune** was selected, the system automatically includes a handpiece tuning test concurrently with the prime cycle.
 - At the end of the priming sequence, the WHITESTAR SIGNATURE™ System makes an audible sound to indicate that Prime process is complete.
 - At the end of the phaco tuning test, the WHITESTAR SIGNATURE™ System makes an audible alert sound to indicate that tune process is complete.
9. To discontinue Prime or Tune during the process, select **Cancel**.
10. When Prime and Tune are complete, the system automatically proceeds to the preprogrammed submode or Phaco 1 operating mode. It is important that you verify the IA balance prior to operating.

Verify Irrigation/ Aspiration Balance

We strongly recommend verifying that Irrigation/Aspiration is balanced properly for the settings to be used in surgery.

Figure 4.8 – Irrigation/Aspiration Balance Procedure



To verify Irrigation/Aspiration balance:

1. In PHACO 1 mode, hold the handpiece at approximate patient eye level.
2. Occlude the aspiration line just below the handpiece, while you press and hold the footpedal in position 2. Make sure the footpedal is connected. (Refer to Chapter 3, System Setup, *Footpedal*.)
3. The actual vacuum level should rise to the preset level.
4. Release the aspiration line and watch the test chamber to make sure that the test chamber does not collapse. A slight shallowing of the test chamber is normal.
5. If the test chamber collapses, raise the IV bottle height or lower the vacuum setting.
6. Pinch the irrigation tubing at the handpiece and watch for the test chamber to collapse.
7. Release the irrigation line and the test chamber should fill.
8. Press **Reset** in the upper left corner of the screen to open the Reset Timers pop-up window. Press **Yes** to reset the timers. You are now ready to begin surgery.

Priming for Vitrectomy

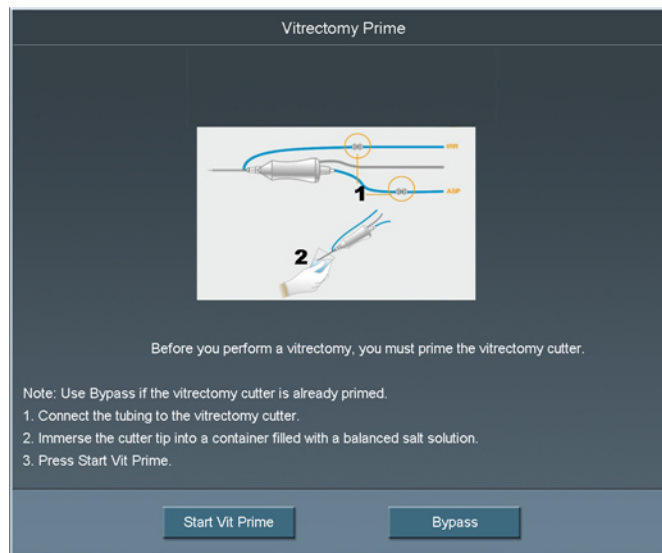
Before you perform vitrectomy, we recommend you prime the handpiece in order to reduce the chance of errors. Each time you select vitrectomy mode you are prompted to prime the vitrectomy handpiece. If you do not need to prime, press **Bypass**.

To prime the handpiece:

1. Attach the irrigation and aspiration cassette pack tubing together.
2. Press **Prime** on the Prime/Tune screen.
3. Press the **VIT** button to enter **VIT** mode.
4. Follow the instructions on the screen.
5. Press **Start Vit Prime**. The screen closes automatically when the handpiece is primed.

Note: If you must perform vitrectomy in the middle of phaco surgery, perform steps 3 through 5.

Figure 4.9 – Vitrectomy Prime Procedure



Selecting and Changing Mode Parameters

The system's graphical user interface (GUI) and touch screen is designed for ease-of-use, consistent application and maximum informational display during all operating modes.

Your interface with the system requires only three basic steps, which apply to all of the selections, settings and operations. Once this basic organization is understood, you can move quickly and easily through all of the system functions and operations.

The touch screen is organized into panels. The top panel shows current status, configuration options, the bottle height, and the footpedal icon. The left-side column lists the operating modes and submodes. The main panel that dominates the screen shows current operating levels for aspiration, vacuum and power.

- To switch operating modes or submodes, press a button in the left panel. The control panels in the main panel show the operating levels for that mode.
- To make basic changes to the settings, press the **Up** and **Down** arrows to increase or decrease a value.

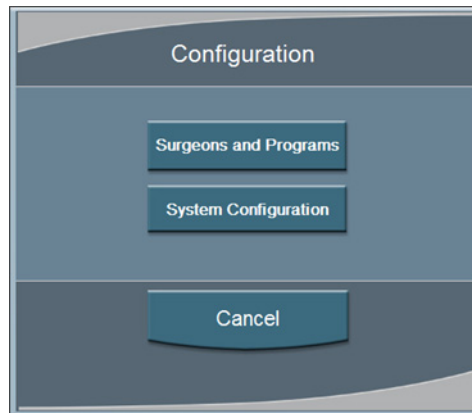
Note: Press on the number in the **Settings** control panel to open a numeric keypad and enter the required value. Refer to Figure 3.17 Numeric Keypad Pop-up Window. Press **Enter** to close the Keypad window.

- To change other control panel settings, such as **Panel** or **Linear** power, press the **Settings** button on that control panel. A **Settings** window opens, and you can make your selections.

Figure 4.10 – PHACO Mode Screen



- To make overall changes to a program, press **Configuration** on the top panel.

Figure 4.11 – Configuration Pop-up Window

- Press **Surgeons and Programs** to access surgeon names and their associated program setups.

Figure 4.12 – PHACO Submode Configuration Screen

5

ANTERIOR SEGMENT SURGERY OPERATING MODES

Operating Mode Descriptions

Fusion™ Fluidics Phaco

Programming the Modes and Settings

Anterior Segment – Recommended Settings

OCCLUSION MODE™ Phaco Settings

Passive Reflux

Ellips™ Technology

Operating Mode Descriptions

Diathermy

While the system is priming, you can select the Diathermy (**DIA**) mode (a function which does not require irrigation and aspiration flow) and perform Diathermy procedures. This process is referred to as a Diathermy during Prime.

Figure 5.1 – Diathermy Mode Screen



If Diathermy is selected during Prime, the screen indicates the Prime/Tune status and any messages associated with the prime and/or tune.

The WHITESTAR SIGNATURE™ System provides power for bipolar coagulation or diathermy. The amount of diathermy power is shown on the Diathermy screen. If **Panel** power is selected, you can increase or decrease power by pressing the **Up** or **Down** arrows on the Power control panel. If the **Linear** mode is selected, the power is controlled with the footpedal up to the maximum preset value.

Note: Press on the number in the **Settings** control panel to open a numeric keypad and enter the required value. Refer to Figure 3.17 Numeric Keypad Pop-up Window. Press **Enter** when you are finished.

Figure 5.2 – Prime/Tune in Diathermy Mode**Using Diathermy**

To begin Diathermy:

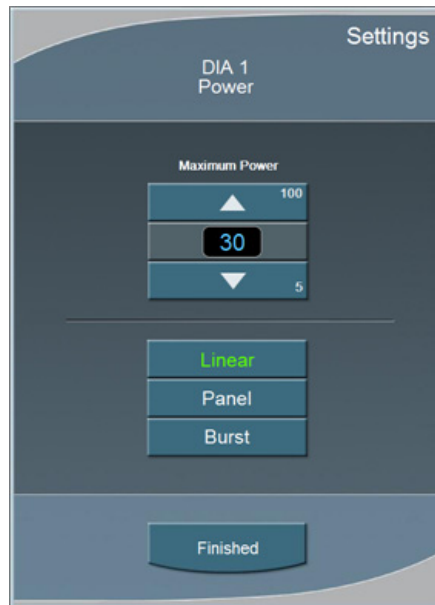
1. On the left panel press **DIA**.
2. Press the desired DIA submode button (**DIA 1** is selected by default).

The elapsed DIA time is displayed in the upper left corner as “DT”.

In the main panel, you can increase or decrease the power by pressing the diathermy **Power Up** or **Down** arrows. If **Linear** power is selected, you can use the footpedal to increase or decrease the power up to the maximum preset value.

To change the power delivery, press **Settings**. The **Settings** window opens. Set the power delivery to **Panel**, **Linear** or **Burst**. Linear delivery is the default.

- **Panel** – Diathermy power is delivered consistently at the power level (%) selected and indicated on the screen as Panel Maximum Power.
- **Linear** – Diathermy power is delivered from 5% to the maximum selected value (Maximum Power) as the footpedal is pressed.
- **Burst** – Diathermy is delivered as a single 150 ms pulse, at the selected power, as the footpedal is pressed.

Figure 5.3 – Diathermy Power Submode

To set the submode parameters:

1. Make the desired settings to the **DIA 1** values
2. Press the **DIA 2** button to set the parameter values.
3. Change the parameter values for **DIA 2**.
4. After the submode (Program submode DIA 1, DIA 2) parameters are set, you can press another mode button in the left panel to program **PHACO**, **IA**, or **VIT** modes.
5. To access the **SAVE** buttons and save the submode settings, press **End Case** in the top panel if no other changes are needed and save the settings.

Irrigation/Aspiration

Aspiration flow is necessary to remove the emulsified cataract material from the eye. An irrigation supply is necessary to replace fluid removed by aspiration of cortical material and fluid lost to leakage from the incision.

This fluid balance maintains the anterior chamber during surgery. Irrigation is controlled by gravity.

The flow rate of irrigation solution through the irrigation sleeve on the phaco tip is determined by the height of the drip chamber (head pressure). The drip chamber hangs from the bottle on the Programmable IV Pole. AMO recommends that at the start of a procedure, the irrigation solution level in the drip chamber be located approximately 65–70 cm above the patient's eye level. To increase irrigation pressure, the IV bottle is raised. To decrease pressure, the bottle is lowered.

The irrigation tubing runs through the tubing cassette and irrigation is controlled by the footpedal. When the footpedal is pressed, the pinch valve is opened and the irrigation fluid flows. Irrigation runs in footpedal Positions 1, 2 and 3.

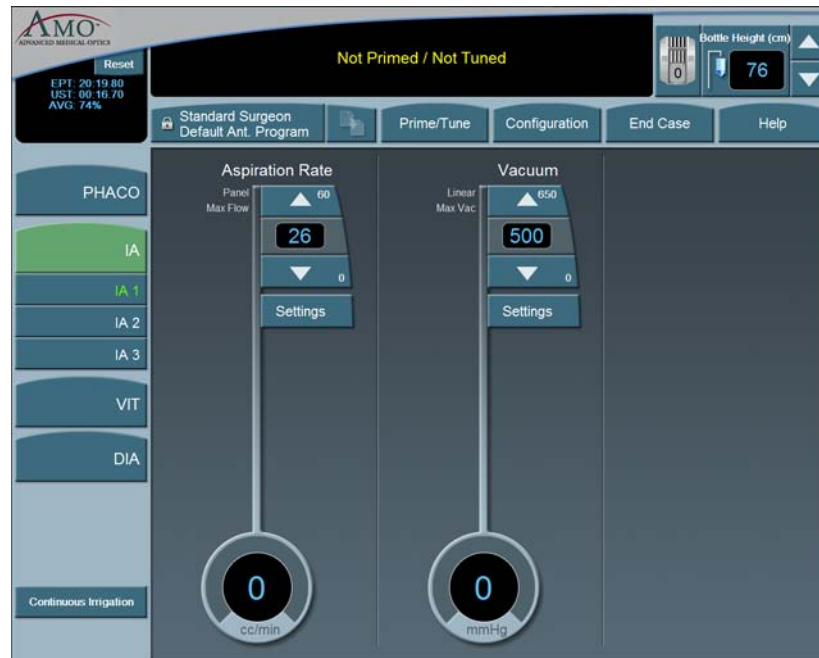
To program IA submodes:

1. On the left panel, press **IA**.
2. Select the desired IA submode. **IA 1** is selected by default.
3. Press the **Up** or **Down** arrows in the control panels on the main panel to increase or decrease Aspiration Rate or Vacuum.

Note: If the Venturi pump is **On**, only the Vacuum Settings are shown. To turn the Venturi pump setting on, use the **IA Submode Configuration** screen.

4. Press the **Settings** button in the control panels on the main panel to change Aspiration Mode or Vacuum Mode,
5. Press **Finished** to close the **Settings** window.
6. After all the submodes are programmed, select another mode.
7. If no other changes are needed press **End Case** to access the **SAVE** buttons and save the settings.

Figure 5.4 – Irrigation/Aspiration Mode



Continuous Irrigation

Continuous Irrigation is designed for collection of balanced salt solution for use during the case. This function opens the irrigation valve for fluid collection independent of the footpedal or prime cycle.

To activate Continuous Irrigation:

1. On the side panel, press the **Continuous Irrigation** button. This opens the valve and starts the flow of irrigation fluid.
2. Press **Continuous Irrigation** again to deactivate the continuous irrigation.

Figure 5.5 – Continuous Irrigation



Phacoemulsification

The purpose of phacoemulsification or PHACO is to emulsify the lens material. The phacoemulsification (phaco) handpiece provides ultrasonic energy, irrigation and aspiration simultaneously so that the lens material is extracted as it is emulsified. The phacoemulsification handpiece has a hollow needle that vibrates longitudinally at an ultrasonic frequency or a blend of longitudinal and transversal, if using the Ellips™. The rapid movement of the needle and the resulting cavitation energy disintegrates the cataract on contact. The debris is removed by suction through the hollow needle (aspiration). The resulting loss in volume of the anterior chamber is compensated by incoming balanced salt solution (irrigation).

PHACO Submodes

There are four PHACO submodes. Within each submode, there are programmable parameters for Unoccluded Phaco, and Occluded Phaco, and CASE settings.

Phaco Power is a combination of stroke length, frequency and handpiece efficiency. A preset power setting of 30% using linear control allows you the ultimate control during phaco. Adjustments to phaco power depend on factors that include nuclear density, your preferences and your experience.

Phacoemulsification mode lets you set four submodes with different settings. You can adjust the individual parameters of each submode.

Figure 5.6 – PHACO Submodes



For each PHACO submode, you can change the following settings:

- Aspiration Rate
- Vacuum
- Power

Before phacoemulsification, you must complete the steps to verify the Irrigation and Aspiration balance, as recommended in the Irrigation/Aspiration section in this chapter.

Using PHACO

1. Press **PHACO**.
2. Press **Phaco 1**, **Phaco 2**, **Phaco 3**, or **Phaco 4** to select the submode. The main panel shows all of the settings for Aspiration Rate, Vacuum and Power. Each submode has different default settings.
3. Press the footpedal to activate phacoemulsification. The Aspiration Rate, Vacuum and Power control panels indicate the associated levels throughout the procedure. The Footpedal icon in the upper right corner of the screen shows the position of the footpedal.

How to Program PHACO


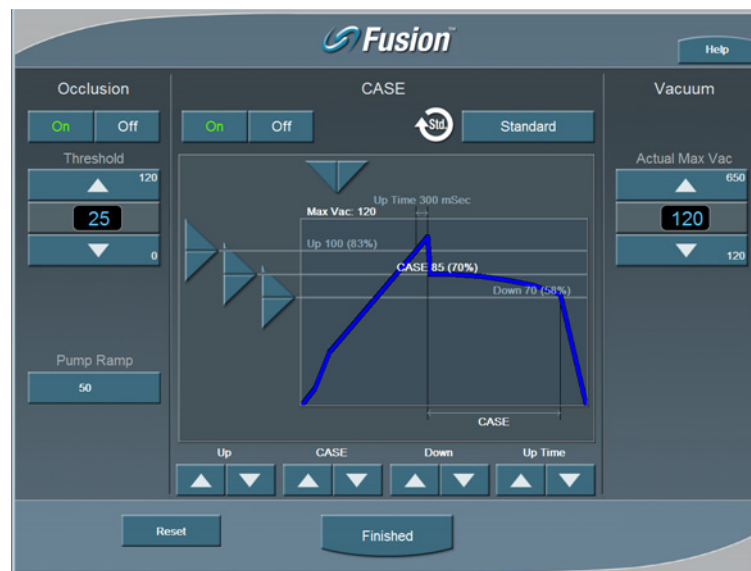
1. Press the **PHACO** button.
 2. Press the desired submode button. **Phaco 1** is selected by default.
- Note: You can set your Initial Mode/Submode on the Phaco Configuration screen. The Initial Mode/Submode is then your default setting. (Refer to Program Configuration, in this chapter.)
3. In the control panels in the main panel, click the **Up** or **Down** arrows to increase or decrease Aspiration Rate, Vacuum, or Power.
- Note: If the Venturi pump is On, only the Vacuum and Power Settings are shown. CASE is not accessible when the Venturi pump is On.
4. Repeat for each submode you want to program.
 5. If OCCLUSION MODE™ Phaco or CASE is desired, press  in the left column to activate the FUSION™ Mode screen. When OCCLUSION MODE™ Phaco is active, the **On** button is green.

Figure 5.7 – Fusion™ Fluidics Screen



If you use CASE or OCCLUSION MODE™ Phaco, you can set different values for both Occlusion Threshold and Max Vacuum. Refer to Fusion™ Fluidics Phaco for programming CASE and OCCLUSION MODE™ Phaco modes.

After all four PHACO submodes are programmed; press a mode button to select another mode.

If no other changes are needed press **End Case** to access the **SAVE** buttons and save the settings.

WHITESTAR® Technology

The WHITESTAR® Technology can be applied in any phaco power delivery mode. This technology is an advanced phacoemulsification power mode that delivers finely modulated pulses of energy interrupted by extremely brief cooling periods. This technology is available in Linear or Panel mode. When the



WHITESTAR® delivery mode is turned on, either  or  appears on the touch screen, along with the WHITESTAR® Duty Cycle.

Figure 5.8 – WHITESTAR® Technology



WHITESTAR® Duty Cycles are expressed as Pulse Time On/Pulse Time Off, to achieve a desired Duty Cycle. For example, the Duty Cycle setting 6/12 means that the pulse time **On** is 6 ms, and the pulse time **Off** is 12 ms, resulting in a 33% duty cycle.

Table 5.1 – WHITESTAR® Technology Parameter Settings

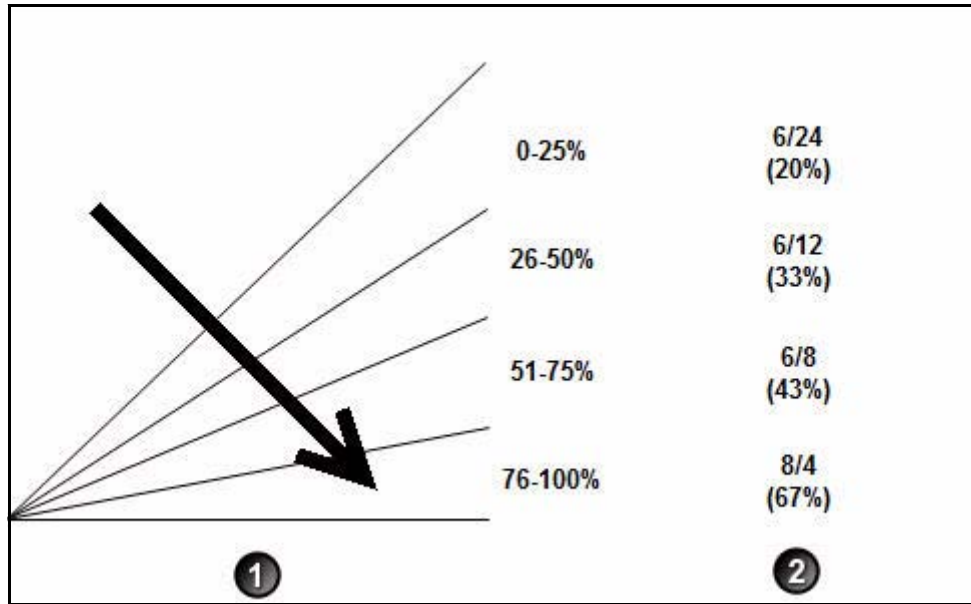
Setting	Pulse On Time (ms)	Pulse Off Time (ms)	Duty Cycle	Pulse Rate (pps)
6/12	6	12	33%	55
4/8	4	8	33%	83
6/4	6	4	60%	100
6/8	6	8	43%	71
8/4	8	4	67%	83
4/24	4	24	14%	35
6/28	6	28	18%	29
6/24	6	24	20%	33
8/24	8	24	25%	31
6/18	6	18	25%	41

Figure 5.9 – Duty Cycle



When the Variable WHITESTAR® Technology is used, different duty cycles are applied as the footpedal moves through the power delivery zone. The zone is divided into four equal size quadrants, and a different duty cycle can be applied in each quadrant.

Figure 5.10 – Variable WHITESTAR® Technology Footpedal Positions and Duty Cycles



- 1. Footpedal Position 3
- 2. WHITESTAR® Duty Cycle

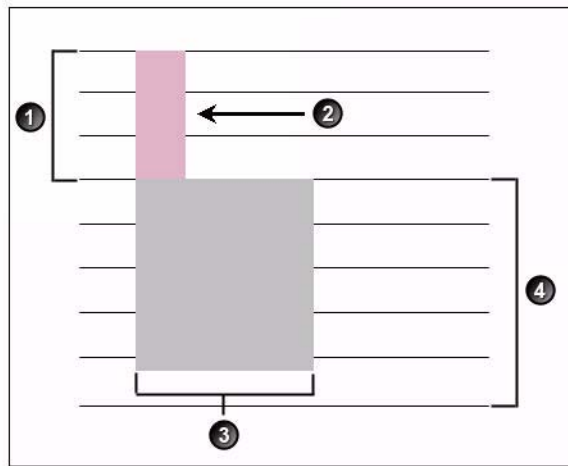
The WHITESTAR SIGNATURE™ System maintains duty cycles to be used with Variable WHITESTAR® – Variable WS. Variable WS contains the four duty cycles that are used in the different quadrants. You can also use the sliding adjustments to create Custom WHITESTAR® duty cycles for WS.

Figure 5.11 – Duty Cycles for Variable WS

WHITESTAR[®] ICE Technology Pulse Shaping

The WHITESTAR[®] ICE Technology was the next micro-pulse advance in phacoemulsification technology, which combined modulated ultrasonic power (pulse shaping) with vacuum control through the application of the Chamber Stabilization Environment (CASE).

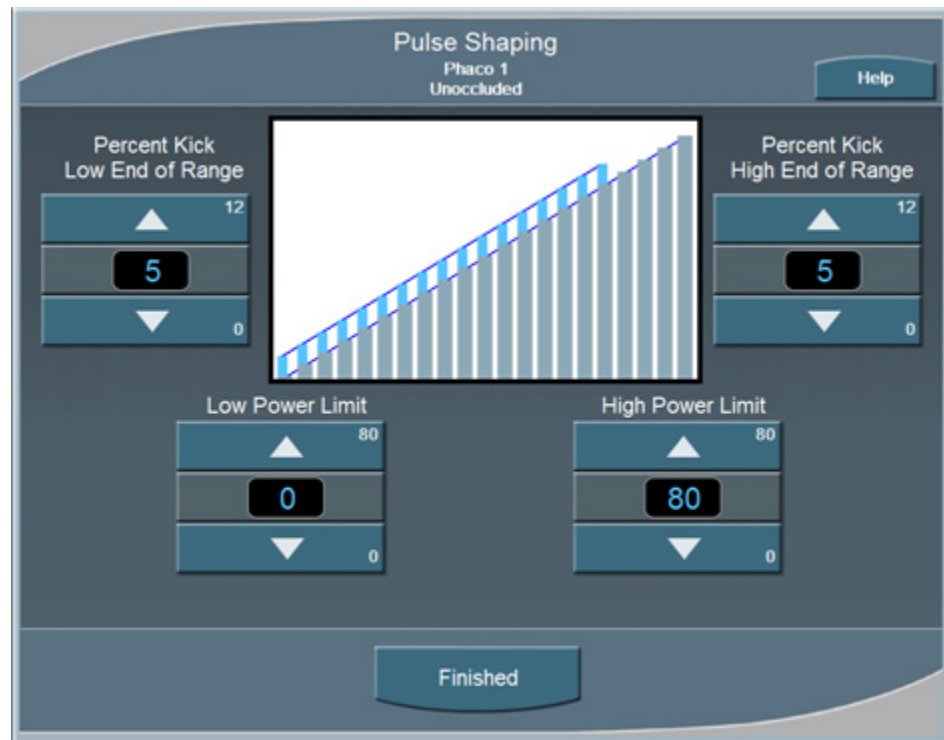
This pulse shaping technology modified the standard “square” wave pulse, by increasing the amplitude of the first millisecond of the On Time “kick”, and then setting the remaining part of the On Time to the standard power setting. This is repeated for each On Time period, resulting in increased control and efficiency in phacoemulsification.

Figure 5.12 – WHITESTAR[®] ICE Technology Pulse Shaping

- | | |
|-----------------------|----------------------|
| 1. Kick Amplitude | 3. Burst Width |
| 2. 1 Millisecond Kick | 4. Phaco Power Level |

To access the WHITESTAR[®] ICE Technology settings:

1. Press the **Power Settings** button.
2. Press the **WHITESTAR** mode button.
3. Press **On** for Pulse Shaping.
4. Press **Edit** to access the Pulse Shaping parameter settings.
5. Press **Finished** to close the screen. Continue to press **Finished** to return to the main screen.

Figure 5.13 – Pulse Shaping Screen

There are four settings for WHITESTAR[®] ICE Pulse Shaping:

- Low Power Limit
- High Power Limit
- Percent Kick Low End of Range
- Percent Kick High End of Range

The Low and High Power Limit settings define the range over which pulse shaping is applied. When the applied Phaco Power is outside of these limits, no pulse shaping is applied.

The Percent Kick settings determine the amplitude, or amount of Phaco Power “kick” that is applied in the first millisecond of Phaco Power application, either in the low end or the high end of the power range. As the Phaco power increases from the Low Power limit to the High Power Limit, the percentage of kick is interpolated for the power ranges in between the two limits.

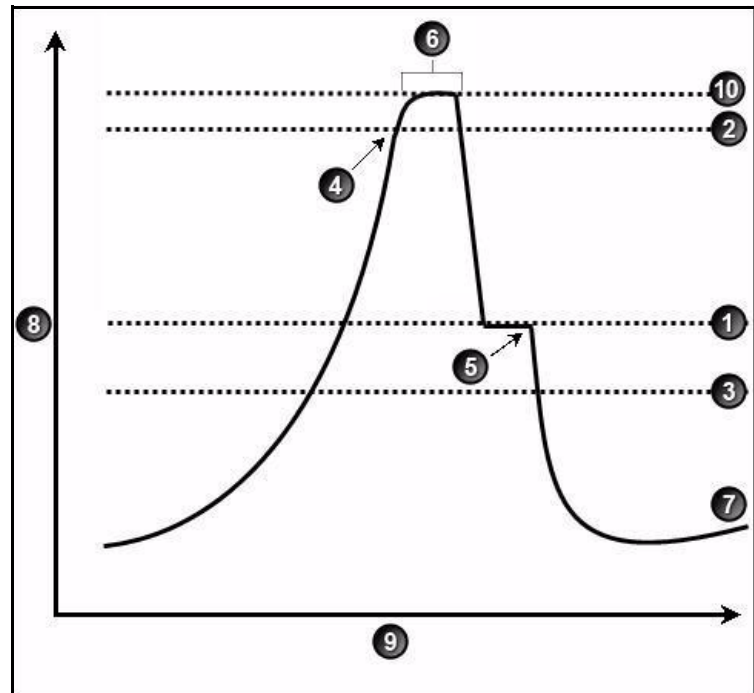
As an example, if a small kick setting is established for the Low End of the range and a large kick setting is established for the High End of the range, the kick percentage gradually increases as the Phaco Power increases. When the Percent Kick at the Low End is the same as the High End, then the kick remains constant throughout the Low to High range.

Fusion™ Fluidics Phaco

Fusion™ Fluidics Phaco is an intelligent vacuum monitoring system used to regulate the maximum allowable vacuum that is experienced following an occlusion of the phaco tip. When the phaco tip becomes occluded, the vacuum rises. Clearing of the occlusion while the vacuum is at a high level can cause a post-occlusion surge. With CASE enabled, the System monitors the actual vacuum levels and when the vacuum exceeds a specific threshold for a specified duration, the System automatically adjusts the maximum allowable vacuum setting to a lower predefined CASE maximum vacuum level. When the occlusion is cleared, the System is automatically restored to the original programmed maximum vacuum setting. It is possible to have a different maximum vacuum setting when the needle is occluded than when the needle is not occluded.

The power modulation of the phaco handpiece can be programmed to automatically change when the phaco tip changes from an unoccluded condition to an occluded condition.

Figure 5.14 – Fusion™ Fluidics Phaco



- | | |
|--|-----------------|
| 1. CASE Vacuum | 6. Up Time |
| 2. Upper Threshold | 7. Vacuum Level |
| 3. Lower Threshold | 8. Vacuum. |
| 4. Vacuum Level crosses Upper Threshold. | 9. Time. |
| 5. Phaco activated. | 10. Max Vac |

The CASE screen shows the settings as a graph. To access the OCCLUSION MODE™ Phaco and CASE settings:


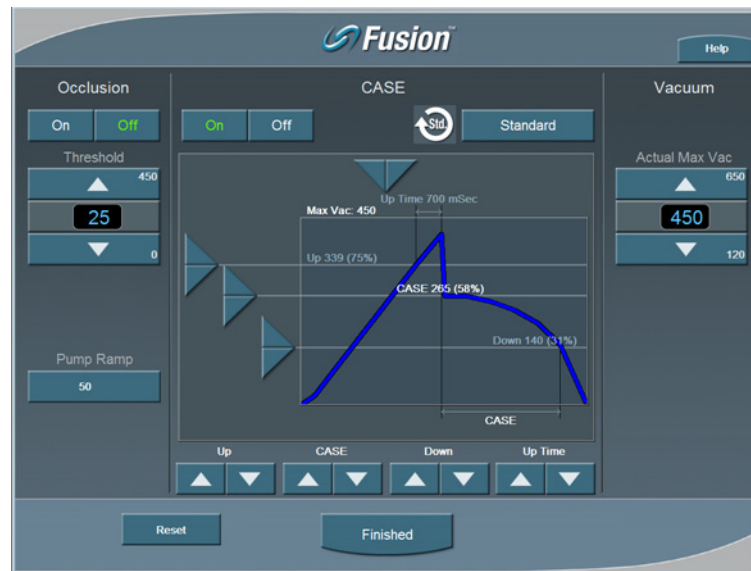
1. Press the  button from the **PHACO** mode screen.

Figure 5.15 – Fusion™ Fluidics Phaco Screen



2. Press the **On** button to turn CASE mode on.

Note: If the Venturi pump option is On, you cannot access the Fusion™ Fluidics screen. There is no Occlusion Mode or CASE Mode with Venturi.

3. Use the **Up** and **Down** arrows at the bottom of the screen to adjust the:

- **CASE Vacuum (CASE)** – This is the optimum occlusion vacuum setting
- **Upper Threshold (Up)** – This is the maximum threshold vacuum setting, which is maintained for the amount of time defined by the Up Time Threshold.
- **Lower Threshold (Down)** – After the occlusion is cleared, the vacuum is reduced to the lower vacuum threshold setting to allow the occlusion to be safely cleared, and then gradually returned to the previous levels.

4. Use the **Right** and **Left** arrows in the graphic to change the **Up Time Threshold**. The Up Time Threshold is the maximum time that the maximum threshold vacuum is maintained.

5. Press **Finished** to close the screen

Use the Fusion™ Fluidics screen to turn OCCLUSION MODE™ Phaco Off or On. When OCCLUSION MODE™ Phaco is **On**, the main PHACO operating screen provides for alternative Aspiration, Vacuum and Phaco Power settings that are used when an occlusion is detected.

Figure 5.16 – PHACO Screen



Vitrectomy

The WHITESTAR SIGNATURE™ System uses a pneumatic guillotine vitrectomy cutter. The handpieces are designed for cutting vitreous during anterior segment surgery and operate in conjunction with the Irrigation/Aspiration mode. The cutting speed can be changed on the touch screen. There are four adjustments related to the Vitrectomy mode:

- Aspiration Rate
- Vacuum
- Cut Rate
- Footpedal



CAUTION: THE PHACO HANDPIECE AND VITRECTOMY CUTTER MUST NEVER BE ACTIVATED WITH THE TIPS IN THE AIR. EXPOSING THE TIP TO AIR DRASTICALLY REDUCES THE USEFUL LIFE OF THE HANDPIECE. IF POWER IS TO BE INTRODUCED TO THE PHACO HANDPIECE OR VITRECTOMY CUTTER, THE TIPS MUST BE IN A TEST CHAMBER FILLED WITH A BALANCED SALT SOLUTION, IN A CONTAINER OF BALANCED SALT SOLUTION OR IN THE PATIENT'S EYE.

Using Vitrectomy

In the left panel, press **VIT 1** or **VIT 2** to select a submode. **VIT 1** is selected by default.

Note: Each time you select the vitrectomy mode you are prompted to prime the vitrectomy handpiece. Refer to Chapter 4, *Equipment Operation*, Priming for Vitrectomy for detailed information.

Figure 5.17 – Vitrectomy Mode Screen



1. In the main panel, press the **Up** or **Down** arrows to increase or decrease the Aspiration Rate, Vacuum, or Cut Rate.

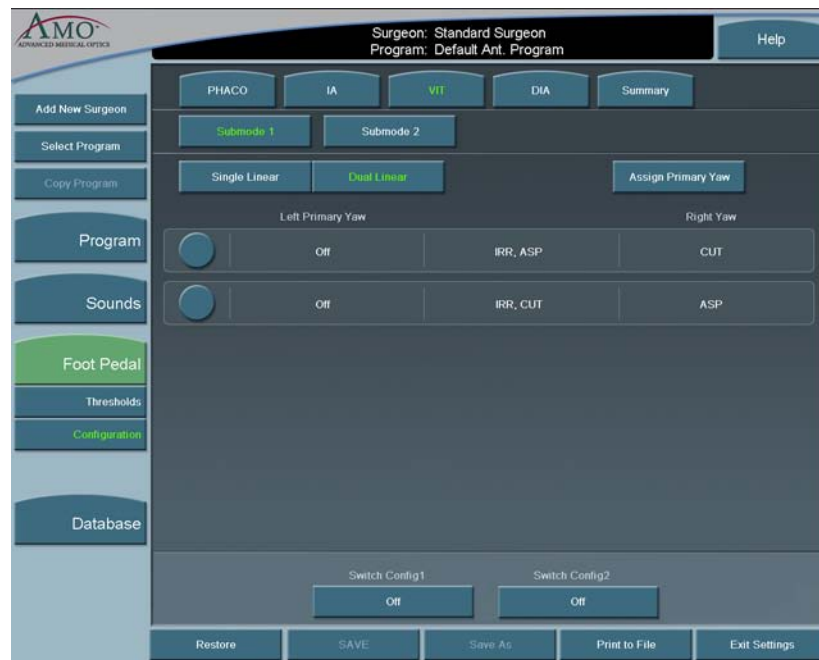
Note: If the Venturi pump is On, only the Vacuum and Cut Rate Settings are shown.

2. To program the footpedal, go to **Configuration, Surgeons and Programs, Foot Pedal, Configuration, VIT**.
3. Select a **Submode** to program.
4. Edit the footpedal settings as needed.

Figure 5.18 – Single Linear Foot Pedal Settings Screen



Figure 5.19 – Dual Linear Foot Pedal Settings Screen



5. When finished, press **Exit Settings**.
6. If no other changes are needed, press **End Case** to access the **SAVE** buttons and save the settings

Footpedal Vitrectomy Modes

The footpedal mode selection must be made for ICA, IAC, or Side vitrectomy (VIT), which determines how the vitrectomy cutter is activated as the footpedal is pressed from Positions 1 through 3. Use the left side switch to activate the cutter at the panel rate for Side VIT only.

Table 5.2 Vitrectomy Single Linear Footpedal Modes

Footpedal Positions	Vitrectomy Footpedal Modes		
	ICA	IAC	Side VIT
1	Irrigation	Irrigation	Irrigation
2	Irrigation/Cut	Irrigation/ Aspiration	Irrigation/ Aspiration
3	Irrigation/Cut/ Aspiration	Irrigation/ Aspiration/Cut	Irrigation/ Aspiration

Table 5.3 Vitrectomy Advanced Control Pedal (Dual Linear) Modes

Footpedal Positions	Vitrectomy Footpedal Modes		
	ICA	IAC	Side VIT
1	Irrigation	Irrigation	N/A
2	Irrigation/Cut	Irrigation/ Aspiration	N/A
Yaw	Aspiration	Cut	N/A

Programming the Modes and Settings

Program Configuration

These programmed settings allow for the selection of operational features and options pertinent to general operation for each mode and submode, the footpedal, system sounds and the system database.

When the **AMO Default Program** is selected, all of the modes and submodes are preset. Although these settings can be changed, they cannot be saved. Use the defaults as a source to your system settings. All default settings can be easily viewed on the Mode Configuration screens.

Figure 5.20 – PHACO Program Screen



AMO Default Setups**Sounds****Table 5.4 – WHITESTAR SIGNATURE™ System Default Settings**

Specific to each surgeon program/setup		
Sounds	Available Settings	AMO Default Settings
High Vacuum	On, Off	On
Mode Change	Off, Tone, Voice	Voice On
Submode Change	Off, Tone, Voice	Voice On
Value Change	On, Off	Voice On
Activity Confirmation	On, Off	Voice On
Vacuum	Off–10	6
Diathermy	5–10	6
Phaco Power	Off–10	Off
Error	5–10	6
Irrigation	Off-10	3
Key Press	Off–10	6
Speech	Off–10	6
CASE Activation	0–10	5
Master Volume	0–10	10

Footpedal – AMO Default Settings

The AMO Default footpedal settings for each operating mode are shown on the System's Summary Screen.

Figure 5.21 – Single Linear Footpedal Summary Settings



Table 5.5 – Footpedal Threshold AMO Default Settings

Footpedal Type	Parameter	Available Settings	AMO Default Settings
Single Linear	Pitch Regions	1–100%	P1=5% P2=30% P3=60%
	Switch Position	Switch 1= * Switch 2= *	Switch 1=Off Switch 2=Off
		Right= * Left= *	Right=Off Left=Off
	Feedback	On, Off	Off
Advanced Control Pedal (Dual Linear)	Primary Yaw	*	Reflux
	Pitch Region	1-100%	P1=5% P2=30% P3=60%
	Yaw Position	5-100%	Left=50%
			Right=50%
	Switch Position	Switch 1= * Switch 2= *	Switch 1=Off Switch 2=Off
	Yaw Threshold	5% - 100%	5%
	Feedback	On, Off	Off

*Switch Assignments

Surgeon Program Up	Surgeon Program Down	Previous Major Mode	Next Major Mode	Previous Active Mode
Next Active Mode	Previous Sub Mode	Next Sub Mode	Toggle SMC Record	Bottle Up
Bottle Down	Reflux	Continuous Irrigation	1-Touch Up (Phaco Only)	1-Touch Down (Phaco Only)
Toggle Case (Phaco Only)	Single Vit Cut (Vitrectomy Only)			

Table 5.6 – Diathermy – AMO Default Settings

Parameter	Available Settings	AMO Default Settings	
		DIA 1	DIA 2
Max Power	5–100%	30%	30%
Power Delivery Type	Linear, Burst, Panel	Linear	Burst
Initial Mode/ Submode	Any of the Submode Names	Phaco 1	Phaco 1

Table 5.7 – I/A – AMO Default Settings

Parameter	Available Settings	AMO Default Settings		
		IA1	IA2	IA3
Continuous Irrigation	On, Off	Off	Off	Off
Pump Selection	Venturi Peristaltic	Peristaltic	Peristaltic	Peristaltic
Bottle Height	0–104 cm 0–42 inches	76 cm 30 inches	50 cm 20 inches	50 cm 20 inches
Max Vacuum	0–650 mmHg	500 mmHg	500 mmHg	15 mmHg
Max Aspiration/ Mode (Peristaltic)	0–60 cc/min	26 cc/min Panel	26 cc/min Linear	6 cc/min Panel
Peristaltic Pump Ramp Threshold	10–100%	80%	80%	80%
Venturi Pump	On, Off	Off	Off	Off
Passive Reflux (Fusion™ Fluidics Pack)	Yes, No	Yes	Yes	Yes
Passive Reflux (Fusion™ Dual Pump Pack)	Yes, No	Yes	Yes	Yes
Initial Mode/ Submode	Any of the Submode Names	Phaco 1	Phaco 1	Phaco 1
Fluidic Mode	Panel, Linear	Panel Aspiration Linear Vacuum	Linear Aspiration Panel Vacuum	Panel Aspiration Linear Vacuum

Table 5.8 – PHACO – AMO Default Settings

Parameter	Available Settings	AMO Default Settings			
		Phaco 1	Phaco 2	Phaco 3	Phaco 4
Bottle Height	0–104cm 0–42 inches	66 cm 26 inches	76 cm 30 inches	76 cm 30 inches	76 cm 30 inches
Continuous Irrigation	On, Off	Off	Off	Off	Off
Pump Selection	Venturi Peristaltic	Peristaltic	Peristaltic	Peristaltic	Peristaltic
Max Vacuum Peristaltic	0–650 mmHg	75 mmHg	300 mmHg	400 mmHg	350 mmHg
Max Vacuum Venturi	0–600 mmHg	75 mmHg	300 mmHg	400 mmHg	350 mmHg
Venturi Pump	On, Off	Off	Off	Off	Off
Passive Reflux	Yes, No				
Fusion™ Fluidics Pack		Yes	Yes	Yes	Yes
Fusion™ Dual Pump Pack		Yes	Yes	Yes	Yes
Initial Mode/ Submode	Any of the Submode Names	Phaco 1	Phaco 1	Phaco 1	Phaco 1
Max Flow/ Aspiration Rate, Unoccluded (Peristaltic)	10–60 cc/min	18 cc/min	24 cc/min	18 cc/min	24 cc/min
Fluidics Mode	Panel, Linear	Panel Aspiration, Linear Vacuum	Panel Aspiration, Panel Vacuum	Panel Aspiration, Linear Vacuum	Panel Aspiration, Linear Vacuum
Occlusion Threshold	0–Max Vac.	25 mmHg	140 mmHg	60 mmHg	80 mmHg
OCCLUSION MODE™ Phaco	On, Off	Off	On	On	Off
CASE Mode	On, Off	Off	Off	On	On
CASE Upper Threshold.	0–Max Vac.	100 mmHg	250 mmHg	325 mmHg	300 mmHg
CASE Lower Threshold.	0–Max Vac.	70 mmHg	175 mmHg	200 mmHg	200 mmHg
Up Time	0–2000 ms	300 ms	300 ms	300 ms	300 ms
CASE Vac	120–650 mmHg	85 mmHg	225 mmHg	250 mmHg	250 mmHg
CASE One-Touch	-2, -1, STD, +1, +2	STD	STD	STD	STD
Peristaltic Pump Ramp	10–100%	50%	60%	50%	70%
Power Delivery Mode (Unoccluded and Occluded)	Continuous Short Pulse Long Pulse Low Power Pulse High Power Pulse Single Burst Multi-Burst Continuous Burst	Continuous	Continuous	Continuous	Continuous
Short Pulse Rate	1–14 pps	6 pps	6 pps	6 pps	6 pps
Long Pulse Rate	1–6 pps	4 pps	4 pps	4 pps	4 pps

Parameter	Available Settings	AMO Default Settings			
WHITESTAR® Technology Duty Cycles	2–30 On Time 2–30 Off Time Predefined: 6/12, 4/8, 6/4, 6/8, 8/4, 4/24, 6/28, 6/24, 8/24, 6/18	6/12 (33%)	6/12 (33%)	6/12 (33%)	6/12 (33%)
Max Aspiration Rate Occluded	10–60 cc/min	18 cc/min	28 cc/min	14 cc/min	24 cc/min
Max Phaco Power Occluded	0–100%	40%	30%	10%	40%
Max Ellips™ Phaco Power Occluded	On, Off	Off	Off	Off	Off
Max Phaco Power Unoccluded	0–100%	40%	20%	5%	30%
Max Ellips™ Phaco Power Unoccluded	On, Off	Off	Off	Off	Off
Power Delivery Type Occluded	Linear, Panel	Linear	Linear	Linear	Linear

Table 5.9 – Vitrectomy – AMO Default Settings

Customized to Each Surgeon Program/Setup AMO Default Settings			
Parameter	Available Settings	VIT 1	VIT 2
Bottle Height	0–104 cm 0–42 inches	30 cm 12 inches	30 cm 12 inches
Continuous Irrigation	On, Off	Off	Off
Pump Selection	Venturi Peristaltic	Peristaltic	Peristaltic
Max Vacuum/Mode (Peristaltic)	0–650 mmHg Panel, Linear	225 mmHg Panel	225 mmHg Panel
Max Aspiration Rate/ Mode	0–60 cc/min Panel, Linear	18 cc/min Panel	12 cc/min Panel
Fluidic Mode	Panel, Linear	Panel Aspiration Panel Vacuum	Panel Aspiration Panel Vacuum
Cut Rate	50–2500 cpm	250 cpm	450 cpm
Footpedal Mode	ICA, IAC	ICA	IAC
Pump Ramp Threshold	10 - 100%	100%	100%
Venturi Pump	On, Off	Off	Off

Customized to Each Surgeon Program/Setup AMO Default Settings			
Parameter	Available Settings	VIT 1	VIT 2
Passive Reflux (Fusion™ Fluidics Pack)	Yes, No	Yes	Yes
Passive Reflux (Fusion™ Dual Pump Pack)	Yes, No	Yes	Yes
Initial Mode/ Submode	Any of the Submode Names	Phaco 1	Phaco 1

Aspiration Rate

The Aspiration Flow Rate is the speed at which material is removed from the eye through the aspiration tubing. A pump provides the necessary aspiration flow to withdraw fluid and lens material from the eye chamber through the handpiece. With this aspiration flow system, the vacuum builds when the aspiration port is blocked or occluded. The vacuum reduces as the occlusion clears.

You can adjust the rate in 1 cc increments from 0 to 60 cc per minute. You can also choose Panel or Linear flow.

The flow rate decreases as the vacuum approaches maximum.

To adjust the flow rate:

1. On the Aspiration Rate control panel, press the **Up** or **Down** arrows to increase or decrease the aspiration rate from 0 to 60 cc per minute.
2. Press the **Settings** button to select **Linear** or **Panel** aspiration flow.

The Settings panel appears.

3. Press the **Linear** or **Panel** button.

The Linear vacuum rate is linear with respect to the footpedal position. As the footpedal is pressed through Position 2, the vacuum level travels between 0 mmHg and the maximum preset level as occlusions at the aspiration port occur. The actual vacuum level is indicated by the vacuum progress shown on the screen.

The Panel vacuum rate provides a continuous evacuation at the established vacuum rate. The vacuum builds only when the footpedal is in Position 2 and an occlusion in the aspiration port is created.

4. Press **Finished** to close the window.

Vitreotomy Cutting Rates

Note: Each time you select the vitrectomy mode you are prompted to prime the vitrectomy handpiece. Refer to Chapter 4, *Equipment Operation*, Priming for Vitrectomy for detailed information.

You can vary the Vitrectomy Cut Rate of the vitrectomy cutter from 50-2500 CPM (cuts per minute) in increments of 50 CPM between 100–1000, and 100 CPM between 1000–2500 CPM.

Some surgeons prefer a higher rate, which allows the surgeon to perform the same amount of cutting with smaller “bites” of vitreous. This minimizes motion and is gentle on the tissue.

To adjust the cut rate

1. On the **Cut Rate** panel, press the **Up** or **Down** arrows to increase or decrease the cut rate.
2. Press **Settings** to select either Linear or Panel cutting methods. The **Settings** window opens.

Note: Side Vit is only available for use with a single linear foot pedal.

3. Press **Linear** or **Panel** button.
4. Press **Finished** to close the window.

Figure 5.22 – VIT Cut Rate



Footpedal Settings

The System accommodates multiple configurations for setting footpedal operation. Each surgeon has one set of footpedal settings for all programs.

The **Switch Assignment** screen opens when you select **On** for any of the switches on the **Foot Pedal** selection screens. The **Switch Assignment** screen allows you to make a selection for that switch.

Footpedal Settings

From the top panel of any operating screen, press **Configuration**. The program highlighted on the Main Menu is used.

1. Press **Surgeons and Programs** in the pop-up window.
2. In the side panel press **Foot Pedal**.

Figure 5.23 – Foot Pedal Pitch Thresholds - Single Linear

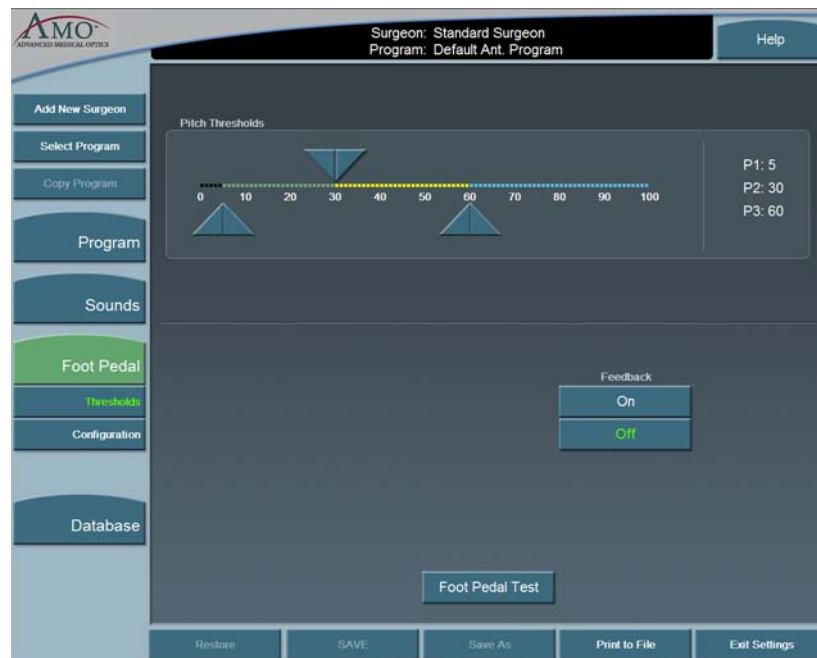
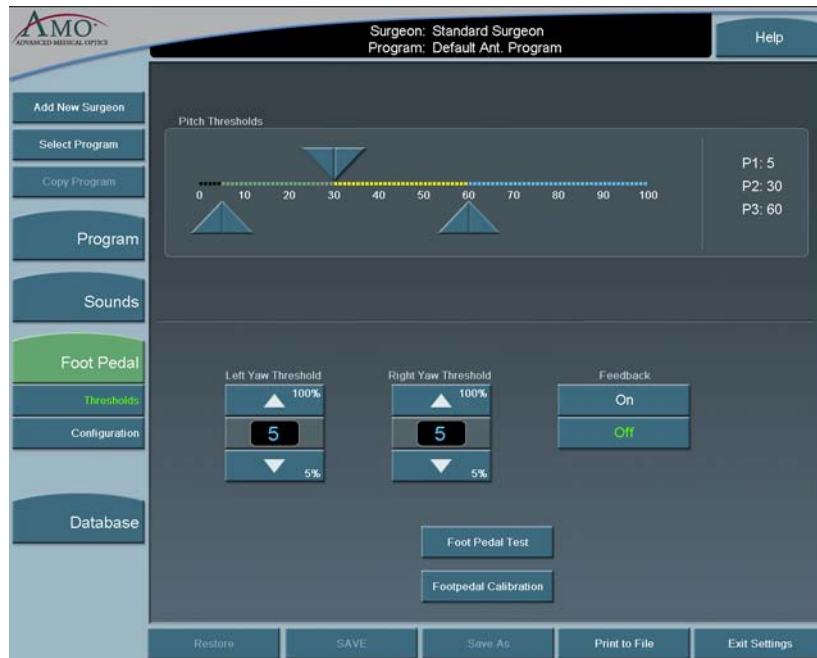


Figure 5.24 – Foot Pedal Pitch Thresholds - Advanced Control Pedal (Dual Linear)



3. Adjust the Yaw Threshold percentage if the Advanced Control Pedal is used.
4. Adjust the Foot Pedal **Pitch Threshold** settings.
5. Turn the Foot Pedal **Feedback On** or **Off**. You can use the **Foot Pedal Test** button to test your settings.
6. Press **Configuration**. The **Foot Pedal Settings** options are shown.

Figure 5.25 – VIT Foot Pedal Settings Advanced Control Pedal (Dual Linear)

7. Select the type of foot pedal.
8. Select the Primary Yaw. Each time you select the **Assign Primary Yaw** button, the selection is changed from left-to-right or right-to-left.
9. Select the operating modes for that surgery using the top Mode tabs and complete the footpedal setup for each mode (PHACO, IA, VIT, or DIA). The footpedal settings are shown in the center of the screen. Select **Summary** to view the footpedal settings for all of the modes.
10. Press each of the switches in any of the four modes. A pop-up window is shown for each switch.
11. Select the **Switch Assignment** from the list.

Note: WHITESTAR Increment and WHITESTAR Decrement are used to increase or decrease the Duty Cycles during surgery.

Figure 5.26 – Vitrectomy Switch Assignment Pop-up Window

12. Press **Finished** to close the window.
13. Press **SAVE** to retain the settings.

Note: If you entered **Configuration** while in an Operating mode, press **Exit Settings** to return to the previous mode.

Vacuum

The vacuum is the force exerted on the aspirated fluid in the aspiration tubing. To make sure you have fluidic balance while in phacoemulsification, you can adjust the Max Vac from 0 to 650 mmHg (Peristaltic pump), as indicated on the Vacuum panel.

1. To adjust the vacuum settings:
 - To increase or decrease vacuum force, press the **Up** and **Down** arrows on the Vacuum panel.
2. To select **Linear** or **Panel** flow, press **Settings**. The Vacuum **Settings** pop-up window appears.
3. Press the **Linear** or **Panel** button.
4. Press **Finished**.

The Linear flow increases from the minimum (0 cc per min) to the maximum preset flow rate as the surgeon presses the footpedal through Position 2. A higher flow rate (as delivered from the footpedal) results in a quicker vacuum rise time. A slower flow rate results in a slower vacuum rise time.

The Panel flow provides a constant evacuation at the preset flow rate when the footpedal enters Position 2.

End Case

End Case is available in the top panel from any programming or surgical mode. **End Case** allows you terminate the programming session or surgical case. If changes were made to the program settings, you are prompted to **SAVE** the settings.

Note: For ease of viewing, the EPT, Ellips EPT, UST and AVG times are shown in a large font size on the **End Case** window. The Ellips EPT is shown only when Ellips™ Technology is On.

Program

Note: **SAVE**, **Save As**, and **Restore** have the same functions on the Program Configuration screens.

SAVE – Saves the changes to the existing Surgeon Name/Program.

Save As – Saves the program changes (made to an existing program) to a new program name when you enter a program name.

Restore – Erases any program changes and resets the values back to the last saved values.

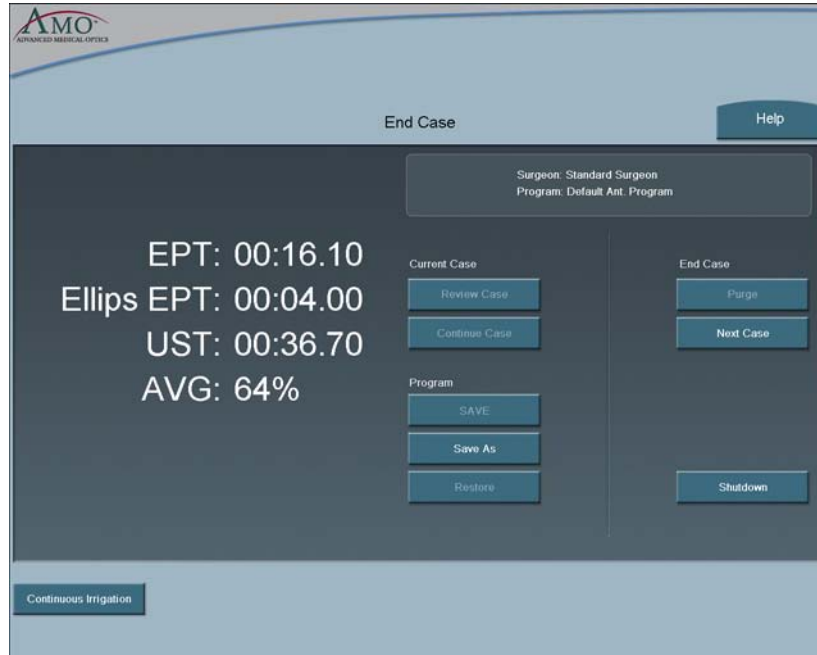
End Case

Purge – Select **Purge** to remove all of the fluid from the irrigation and aspiration tubing before you remove the tubing cassette.

Next Case – Select **Next Case** to install a new tubing cassette.

Note: Use a new bottle of balanced salt solution at the start of each case.

Figure 5.27 – End Case Screen



The timers in the upper left corner indicate Effective Phaco Time (EPT), Ultrasonic (U/S) Time in Footpedal Position 3, and Ellips EPT if Ellips™ Technology is On. Effective Phaco Time is ultrasound time as a weighted total that takes into account the amount of power being used:

- at 100% power: 1 sec. U/S Time = 1 sec. EPT
- at 50% power: 1 sec. U/S Time = .5 sec. EPT

Current Case

Review Case – shows the graphical history of the surgery. (Refer to Figure 5.28 Review Case Screen.)

1. Select a shorter time interval to adjust the Time Line Duration and to see greater case details. For example, 10 Sec shows more detail than 15 Min.
2. Select a longer time interval for an overview of the surgery or sessions, such as 1 hour or 2 hours. This view provides less detail, but gives you a better indication of the trends over a period of time. Use the << or >> buttons to change the time intervals. You cannot use the arrow buttons when you view an active case.

3. Press the **Select Review Case** to select and view a specific surgical case.
4. Press **Export** to name and save the record to a USB device. Enter a name for the **Case History**.

Note: Use only AMO recommended USB stick drives.

5. Use the **Print to File** to save the data to a file format. The **Delete Record** button removes the case from the **Record** database.
6. Select **Finished** to close the window.

Figure 5.28 – Review Case Screen



Continue Case – Select **Continue Case** to return to the current case, after you selected **Review Case** or **Restore**.

Shutdown – Select the **Shutdown** button to turn the System **Off**. At the prompt, press **Yes** to complete the process.

Anterior Segment – Recommended Settings

Phaco Power

You can adjust power from 0% to 100% in 5% increments for both Occluded and Unoccluded phaco tips. The large number in the power panel indicates the selected maximum Phaco Power. The phaco power can be either Linear or Panel.

1. **Linear** – Power is controlled with the footpedal, the power increases from 0%–100% to the maximum preset level. When the footpedal is fully pressed, the power level is at the maximum preset level. The power increase is indicated by the power display bar.
2. **Panel** – Power is delivered consistently at the power level (%) indicated on the screen. The power level does not change when you press the footpedal.

There are eight choices for delivery of phaco power:

- **Continuous**
- **Short Pulse**
- **Long Pulse**
- **Low Power Pulse**
- **High Power Pulse**
- **Single Burst** (Panel only)
- **Multiple Burst** (Panel only)
- **Continuous Burst** (Panel only)

From the PHACO operating screen, press **Settings** and the Phaco Power selection screen appears.

Figure 5.29 – Phaco Power Settings

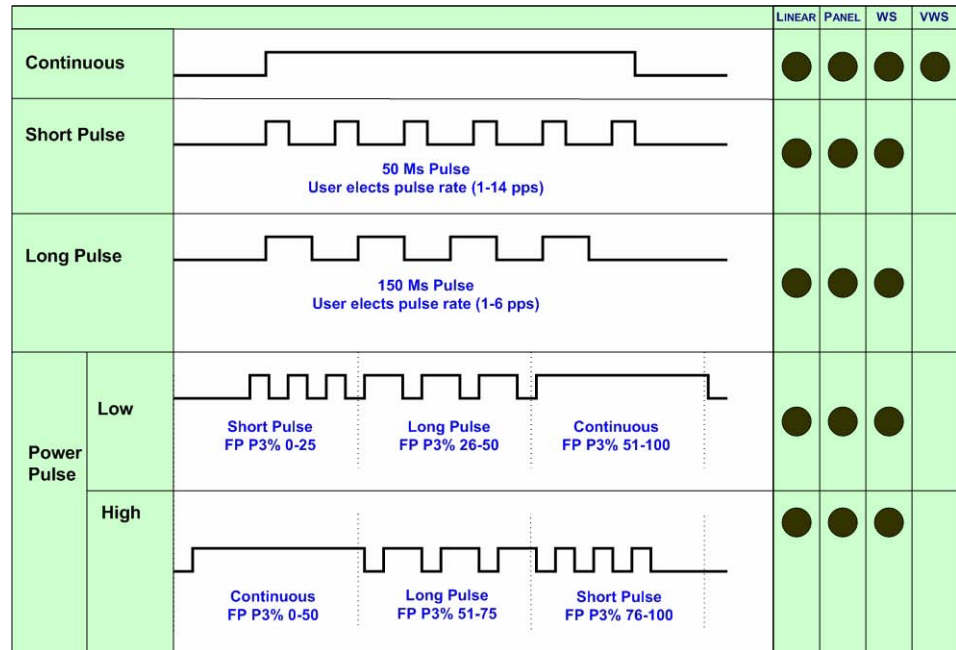


In addition to the eight Phaco Power modes, you can also select the **WHITESTAR** Mode. The WHITESTAR® Technology and Ellips™ Technology are discussed later in this section.

Continuous Phaco Power

Continuous Phaco Power delivers continuous, uninterrupted phaco power to the handpiece and requires no pulse rate setting.

Figure 5.30 – AMO® Phaco Power Modes



Short Pulse Phaco Power

Short Pulse delivers Phaco in pulses of 50 ms when the footpedal is in Position 3. You can set this in a range of 1 to 14 pulses per second (pps). The actual number of pps is shown on the button to the right of the **Short Pulse** button.

To set the Short Pulse range:

1. Press the button to the right of the **Short Pulse** button. A **Settings** pop-up window appears.
2. Press the **Up** or **Down** arrow to increase or decrease the pps from 1 to 14.
3. Press **Finished** to close the window.

Long Pulse Phaco Power

Long Pulse delivers Phaco in pulses of 150 ms when the footpedal is in Position 3. You can set this in a range of 1 to 6 pulses per second (pps). The actual number of pps is displayed on the button to the right of the Long Pulse button.

To set the Long Pulse range:

1. Press the button to the right of the **Long Pulse** button. A **Settings** pop-up window appears.
2. Press the **Up** or **Down** arrow to increase or decrease the pps from 1 to 6.

3. Press **Finished** to close the window.

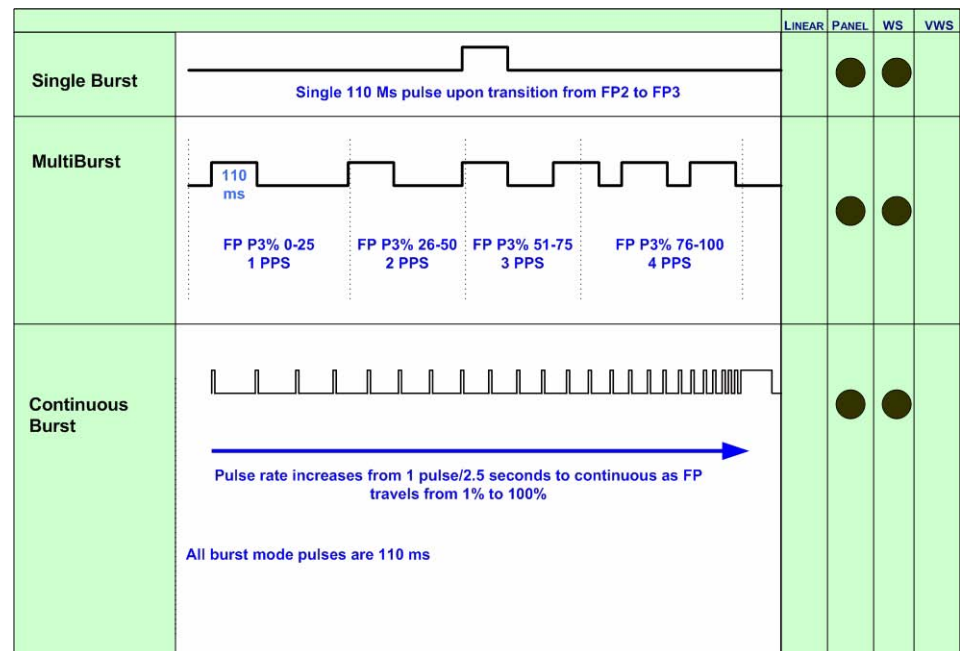
Low Power Pulse Phaco Power

Low Power Pulse generates short pulses of ultrasonic power in footpedal Position 3. When you press the footpedal, the pulses become longer and eventually blend together to become continuous phaco power.

High Power Pulse Phaco Power

High Power Pulse generates continuous Phaco Power in footpedal Position 3. When you press the footpedal, the continuous pulse changes into long pulses and then gradually changes to short pulses.

Figure 5.31 – AMO® Phaco Burst Power Modes



Single Burst Phaco Power (Panel Only)

Single Burst delivers a single burst of ultrasonic power of 110 ms duration when you press the footpedal to Position 3. You must return to footpedal Position 2, pause for approximately one-half (.5) second, and then press the footpedal to Position 3 to obtain an additional burst of energy.

Multiple Burst Phaco Power (Panel Only)

Multiple Burst generates a burst of ultrasonic power of 110 ms duration, with additional bursts deployed beginning at approximately 1 burst per second when you press the footpedal to Position 3.

The frequency of burst increases as you press the footpedal. At the maximum level of footpedal Position 3, the bursts are delivered at the rate of 4 bursts per second.

Continuous Burst Phaco Power (Panel Only)

Continuous Burst delivers a 110 ms ultrasonic burst duration. As you press the footpedal through Position 3, the bursts get closer together. At the maximum level of footpedal Position 3, the bursts blend together, and the power becomes continuous (at the preset power level).

Override PHACO Submode Settings

You can override the settings for a PHACO submode by selecting the submode, and either press the **Up** and **Down** arrows to increase or decrease Aspiration Rate, Vacuum, or Power settings, or press **Settings** on the control panels for Aspiration Rate, Vacuum, or Power. If you pressed the **Settings** button, the **Settings** pop-up window appears.

Figure 5.32 – Override PHACO Submode Settings



OCCLUSION MODE™ Phaco Settings

CASE Mode

To access the OCCLUSION MODE™ Phaco and CASE settings:


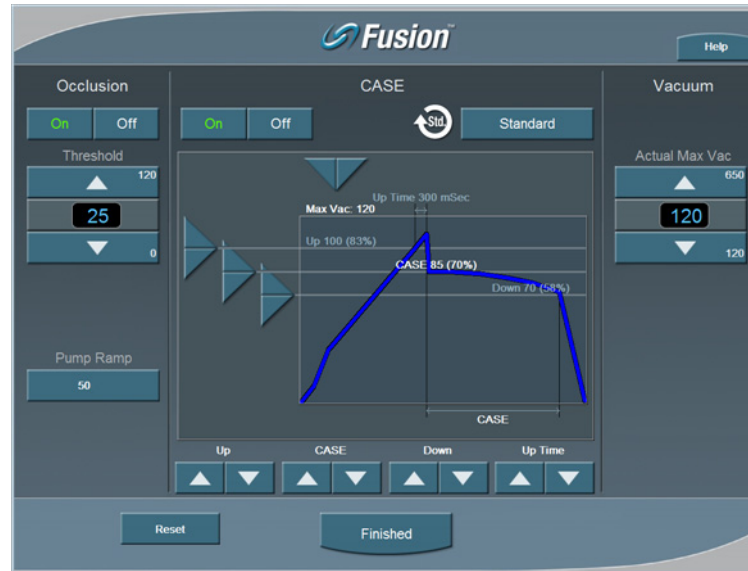
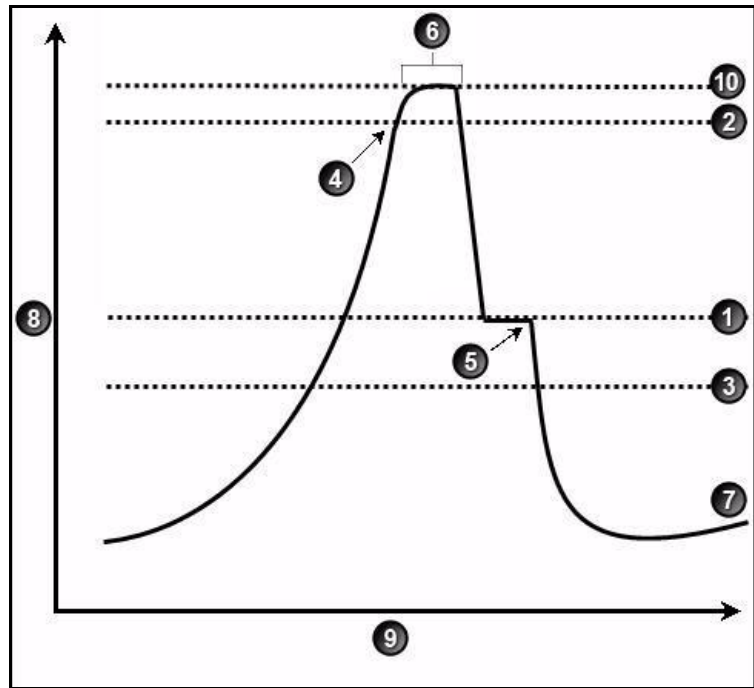
1. Press the  button from the PHACO operating screen.

Figure 5.33 – CASE OCCLUSION MODE™ Phaco



CASE maintains a stable chamber by detecting an impending occlusion break, and reducing the vacuum before occlusion surge can occur. When the occlusion is detected, the System waits long enough to allow the particle to be firmly grasped, and then reduces the vacuum to a lower level in order to allow the occlusion to be safely cleared. When the occlusion is fully cleared, the vacuum returns to the previous vacuum level.

Figure 5.34 – CASE OCCLUSION MODE™ Phaco



- | | |
|---|-----------------|
| 1. CASE Vacuum | 6. Up Time |
| 2. Upper Threshold | 7. Vacuum Level |
| 3. Lower Threshold | 8. Vacuum |
| 4. Vacuum Level crosses Upper Threshold | 9. Time |
| 5. Phaco activated | 10. Max Vac |

You can control and customize the CASE behavior by setting the:

1. Upper and Lower Vacuum Threshold levels
2. CASE Vacuum Level
3. “Up Time” delay, which determines the maximum time that the Upper Threshold Vacuum level is maintained.

CASE One Touch

To simplify the programming of the CASE function, you only need to define the basic CASE parameters once. The CASE function can then be adjusted quickly and simply from the CASE One Touch settings on the surgical screen. Using these controls, the CASE functionality can be changed to provide greater efficiency (**Up** arrow) or provide more control (**Down** arrow) to suit any particular combination of cataract density, surgical technique or personal preference.

When CASE is **On**, use the **One Touch** buttons to adjust the CASE parameters.

Figure 5.35 – CASE One Touch

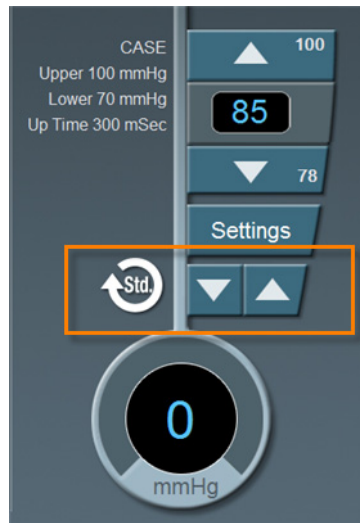


Table 5.10 – CASE One Touch Parameter Settings

Parameter	CASE -2	CASE -1	CASE STD	CASE +1	CASE +2
Pump Ramp Setting	Program default	Program default	Program default	CASE STD +10%	CASE STD +20%
CASE Occlusion Delay	CASE STD -200 ms	CASE STD -100 ms	Program default	CASE STD +100 ms	CASE STD +200 ms
CASE Upper Threshold	CASE STD -5%	Program default	Program default	Program default	CASE STD +5%

OCCLUSION MODE™ Phaco Settings

You can set different Aspiration Rates for occluded aspiration as opposed to unoccluded aspiration.

With the OCCLUSION MODE™ Phaco you can set a different vacuum rise time when the phaco tip is occluded without changing the aspiration rate through an unoccluded needle.

To set the Occluded Aspiration Rate thresholds:


1. Press **PHACO**.
2. Press  on the left of the screen. Three new control panels appear for Aspiration and Power. The center panel is for a graphical display of the CASE settings.
3. Press **On** to set the thresholds.
4. Change the settings in the new control panels as needed.
5. Press **Finished** to close the window.

Figure 5.36 – OCCLUSION MODE™ Phaco



6. Press **Finished** to close the screen.

Occlusion Vacuum Threshold

In OCCLUSION MODE™ Phaco, you can set an occluded threshold value for vacuum.

When in OCCLUSION MODE™ Phaco, there is an additional control panel for Vacuum. The Vacuum Threshold setting lets you choose the vacuum level at which occluded settings take effect.

To adjust the Occluded Vacuum Threshold:

1. Press the **Up** or **Down** arrows, in Occlusion mode, to increase or decrease the Occluded Vacuum Threshold.
2. When the threshold is decreased, the occlusion settings take effect sooner.

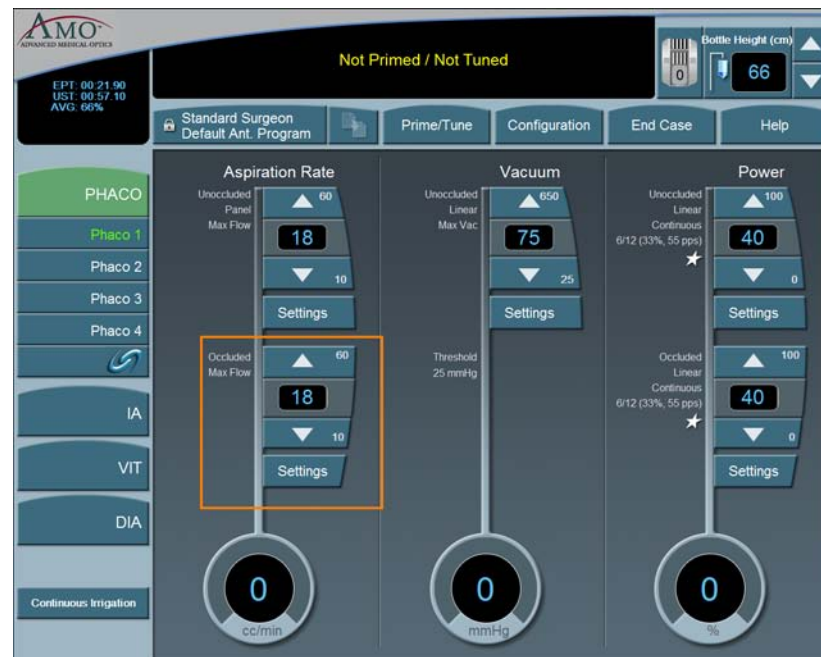
Occlusion Aspiration Rate

In OCCLUSION MODE™ Phaco, you can set a different Max Flow value for aspiration. There is an additional control panel for aspiration below the standard aspiration control panel.

To adjust the occluded aspiration rate:

1. In OCCLUSION MODE™ Phaco, press the **Up** or **Down** arrows to increase or decrease the occluded aspiration rate.

Figure 5.37 – Occlusion Aspiration Rate



Or

2. Press **Settings**. The **Occluded Aspiration Rate** pop-up window appears.

Figure 5.38 – Occluded Aspiration Rate Pop-up Window

3. Press the **Up** or **Down** arrows to increase or decrease the occluded aspiration rate.
4. Press **Finished** to close the window.

OCCLUSION MODE™ Phaco Power Settings

You can set different power levels when the phaco tip is occluded.

When you are in OCCLUSION MODE™ Phaco, there is an additional control panel for Power.

Figure 5.39 – OCCLUSION MODE™ Phaco Power Settings



1. WHITESTAR® Technology with Pulse Shaping with Ellips™ Technology
2. WHITESTAR® Technology without Pulse Shaping

To adjust the occluded power delivery:

1. In OCCLUSION MODE™ Phaco, press the **Up** or **Down** arrows to increase or decrease the occluded power level.
2. Press **Settings** to change other power settings. A **Power Settings** screen opens.
3. Press **Linear** or **Panel**. Depending on whether you select **Linear** or **Panel**, there are a total of nine different power settings you can choose.
4. Press the buttons on the right of the **Settings** screen to select a power delivery value.
5. Press the **On** button to engage WHITESTAR® Technology.
6. Press **Finished** to close the screen.

Venting an Occlusion

When the aspiration port is blocked or occluded by tissue or other material, the vacuum pressure builds up. The aspiration flow system vents to the bottle when the footpedal is released. Another choice is that you can release the footpedal to Position 1 and that causes the aspiration system fluid to vent using pump rotation.


These methods release the material at the aspiration port and gives you full control if the tip accidentally grabs the capsule or iris. The internal fluidic system allows the desired vacuum level to be maintained when you hold the footpedal at a constant position. The two adjustments associated with aspiration flow are Max Vac and Max Flow.

Passive Reflux

You can select from either **Yes** or **No**. The **Yes** reverses the pump to vent. The **No** option opens a path to the bottle pressure and allows reflux into the eye.

1. Select **Configuration**.
2. Select **Surgeons and Programs**.
3. Select the applicable operating mode and submode.
4. Press the **Passive Reflux** button to select either **Yes** or **No**. The system default is **Yes**.

Ellips™ Technology

Press the Ellips™ Technology button on the Phaco Power Settings screen to activate. The  is shown on the Phaco operating mode screen when Ellips™ Technology is on. Ellips™ Technology can be set for each Phaco submode.

Note: You must have an Ellips™ Phaco handpiece attached to the system before you can activate the Ellips™ Technology.

Figure 5.40 – Phaco with Ellips™ Technology



6

SURGEON PROGRAMS

Select Surgeon/Program

Add a New Surgeon

Edit a Surgeon

Select a Preferred Program

Create a New Program

Edit a Surgeon Program

Copy a Surgeon Program

Delete a Surgeon

Delete a Program

Delete a Database

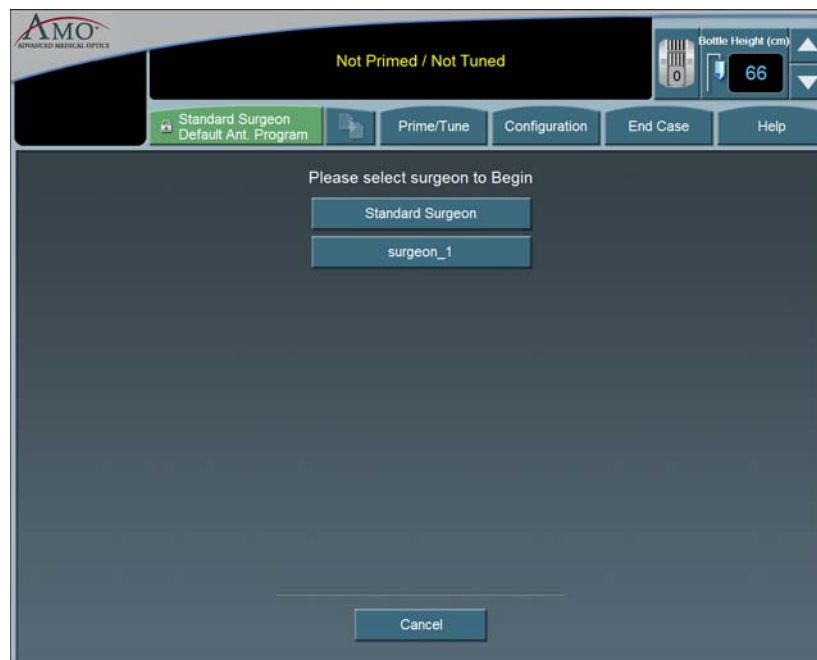
Lock a Program

Program – Assign Order

Select Surgeon/ Program

1. When the System completes the Self Test routine, you are prompted by the System to select a Surgeon (by name). If there are no surgeons defined on the system this screen is not shown.
Note: If your name is not listed, you can use **Standard Surgeon**, the AMO default surgeon setup, and then save those settings to your name.
2. After you select a surgeon, the System prompts you to select a **Surgeon Program**. If there are no programs defined on the system, the **Select A Surgeon Program** screen is not shown.

Figure 6.1 – Select Surgeon Window

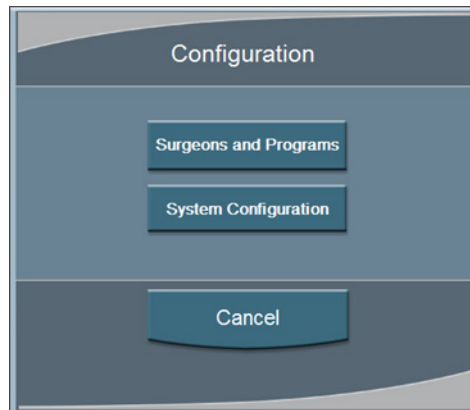


Add a New Surgeon

To create a new Surgeon program:

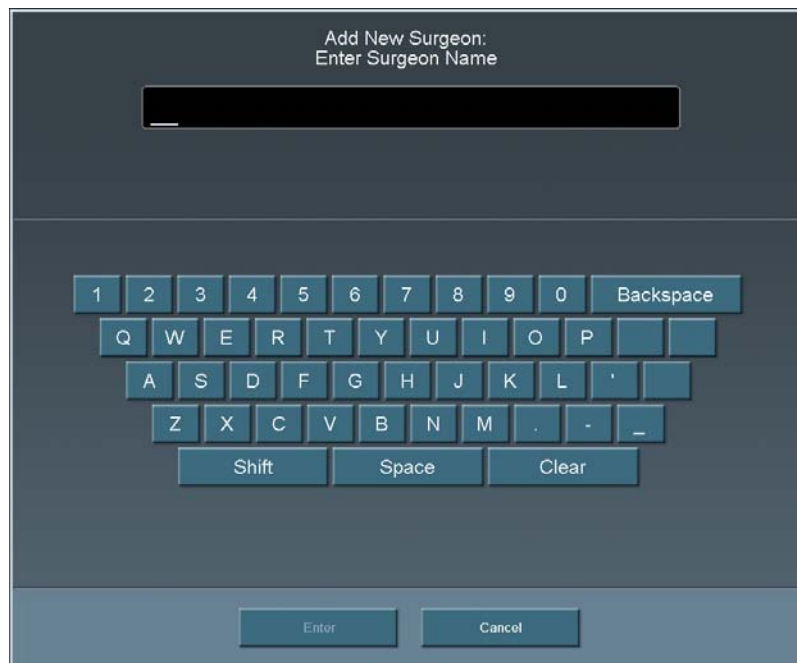
1. Press **Configuration**.
2. Press **Surgeons and Programs**.

Figure 6.2 – Configuration Pop-up Window



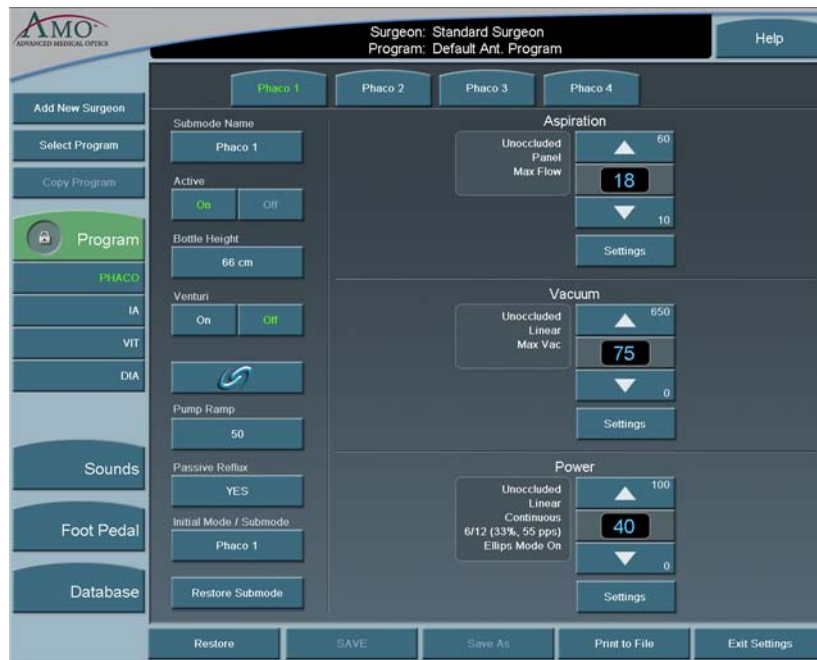
3. The **Program Settings** screen opens.
4. Press **Add New Surgeon**. The Keyboard window opens.
5. Enter the name of the surgeon.
6. Press **Enter** to save the new surgeon and exit the Keyboard window. The new Surgeon now appears in the list of available surgeons.

Figure 6.3 – Keyboard Screen



- Edit the settings for this surgeon on the **Program Settings** screen. Use the **Copy Program** to copy another surgeon's program. Refer to Copy a Surgeon Program in this chapter.

Figure 6.4 – PHACO Submode Settings

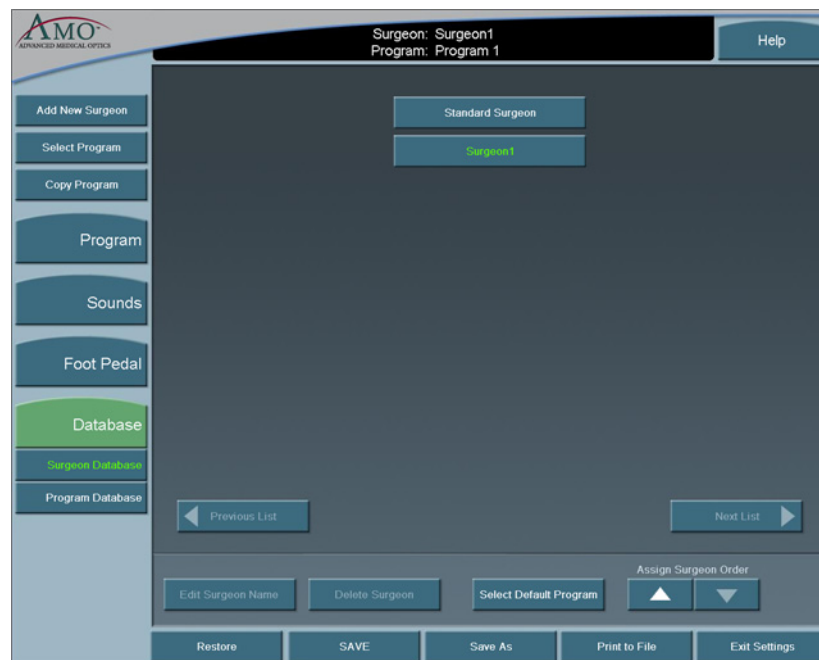


8. Press **SAVE**. If you do not edit any of the settings you can only use **Save As**.
9. Press **Exit Settings**.

Edit a Surgeon

1. Press **Configuration**.
2. Press **Surgeons and Programs**.
3. Press **Database**.
4. Press **Surgeon Database** button.
5. Select a surgeon from the list.

Figure 6.5 – Select Surgeon



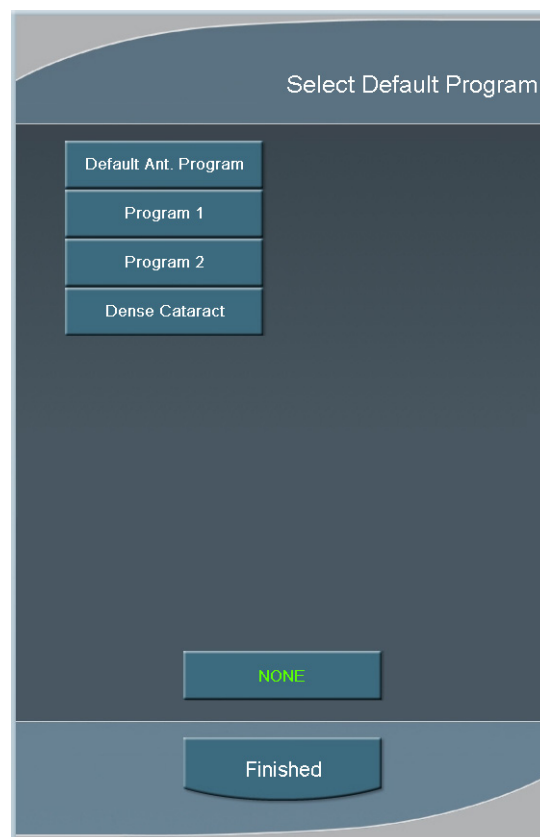
6. Press **Edit Surgeon Name**. The Keyboard window appears.
7. Edit the name.
8. Press **Enter**.
9. Press **Exit Settings**.

Select a Preferred Program

Use the **Select Surgeon** screen to assign your preferred or default program. the program selected here is indicated with an asterisk (*) on the **Select Program to Begin** screen when the system is started. When you select **Next Case** the system asks if you want to return to your preferred program. You are prompted only if you are not in your preferred program.

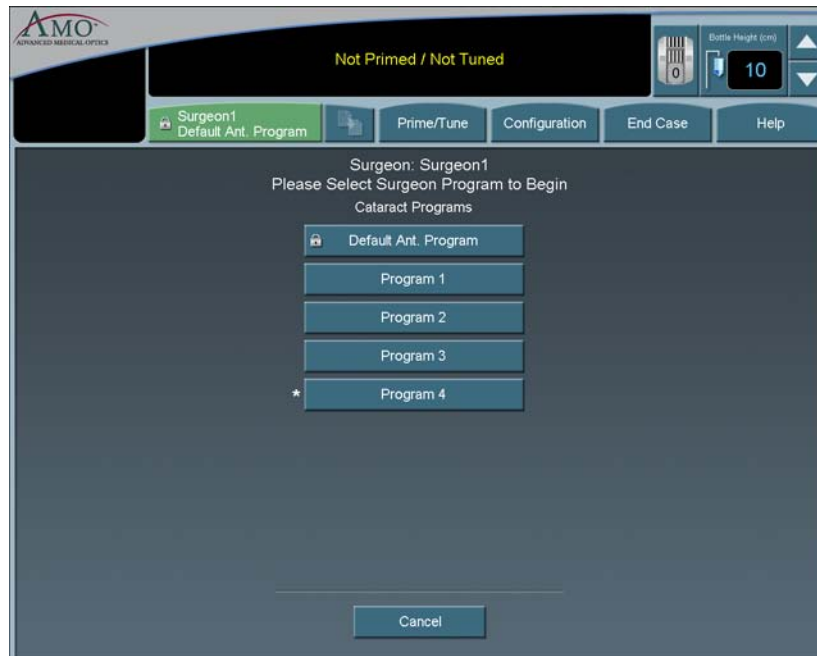
1. Press **Configuration**.
2. Press **Surgeons and Programs**.
3. Press **Database**.
4. Press **Surgeon Database**.
5. Select a surgeon from the list.
6. Select **Assign Default Program**.

Figure 6.6 – Select Default Program Pop-up



7. Select a program or select **None** to clear a selection.
8. Select **Finished** to close the window. Your preferred program is indicated with an asterisk on the **Select Program to Begin** screen when the system is started.

Figure 6.7 – Select a Program to Begin Screen



Create a New Program

When you create a new surgeon, that surgeon is assigned the **AMO Default Program** setup. You can customize a program for that surgeon name with your preferred settings. You can also create new programs for existing surgeons.

1. Press **Configuration**.
2. Press **Surgeons and Programs**.
3. Press **Select Program**.
4. Select the surgeon or program from the list.
5. Press **Enter**.
6. Edit the settings for this program on the **Settings** window. Use the **Copy Program** to copy another surgeon's program. Refer to Copy a Surgeon Program in this chapter.
7. Press **Save As**. The Keyboard window opens.
8. Enter the name of the program.
9. Press **Enter**.
10. Press **Exit Settings**.

Edit a Surgeon Program

1. Press **Configuration**.
2. Press **Surgeons and Programs**.
3. Press **Select Program**.
4. Select the surgeon or program from the list.

Figure 6.8 – Select Program



5. Press **Enter**.
6. Select the mode and submode to edit.
7. Edit the settings for this program on the **Settings** window.
8. Press **SAVE**.
9. Press **Exit Settings**.

Copy a Surgeon Program

You can copy the settings of one surgeon program for use by another surgeon.

To copy a surgeon program:

1. Press **Configuration**.
2. Select **Surgeons and Programs**.
3. Press **Copy Program** and select the **Surgeon** or **Program** you want to copy from the list. This copies all of the settings of the selected program and the submodes.

Note: If Standard Surgeon is the active surgeon, **Copy Program** is not available to the user. Press **Select Program** to change the surgeon and program.

4. Press **Enter**.
5. Press **Save As** at the bottom of the screen. The Keyboard window opens.
6. Enter the new name for the program.
7. Press **Enter** to save the new program and exit the Keyboard window. The new program now appears in the list of available programs.
8. Press **Exit Settings**.

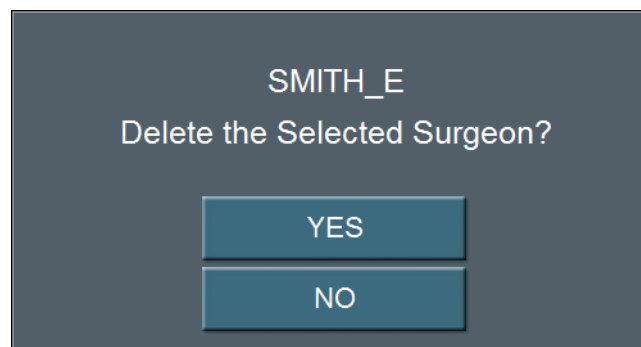
Delete a Surgeon

Use **Delete Surgeon** to remove a surgeon from the Select Surgeon screen. You cannot delete the current surgeon.

Note: You cannot delete a current surgeon or a surgeon that is selected on the **Settings** screen.

1. Press **Configuration**.
2. Press **Surgeons and Programs**.
3. Press **Database**.
4. Press **Surgeon Database**.
5. Select a surgeon to delete.
6. Select **Delete Surgeon**. A delete confirmation pop-up appears.

Figure 6.9 – Delete Confirmation Pop-up Window



7. Press **Yes**.
8. Select **Exit Settings**.

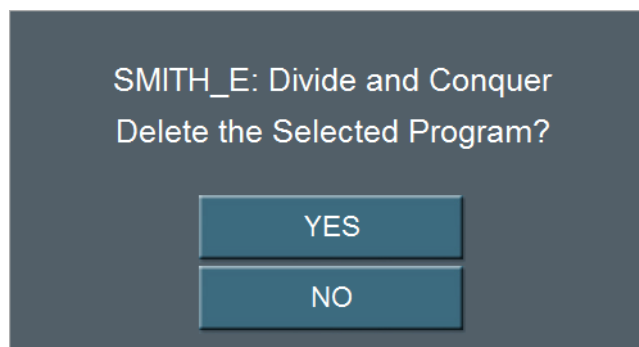
Delete a Program

Use **Delete Program** to remove a surgeon program from the Select Program screen. You cannot delete the current program.

Note: You cannot delete a current program or a program that is selected on the **Settings** screen.

1. Press **Configuration**.
2. Press **Surgeons and Programs**.
3. Press **Database**.
4. Press **Program Database**.
5. Select a program to delete.
6. Select **Delete Program**. A delete confirmation pop-up appears.

Figure 6.10 – Deletion Confirmation



7. Press **Yes**.
8. Select **Exit Settings**.

Delete a Database

You can delete a database from your memory device. Contact your AMO Service Representative to delete a database from your system's hard drive.

Note: Use only AMO recommended USB stick drives.

1. Insert the USB flash drive into the port on the back of the system.
2. From **Configuration**, press **System Configuration** to access the Diagnostic screen.
3. Press **Restore All**.
4. Press the database to delete from the list.
5. Press **Delete Selection**.
6. Press **OK** at the confirmation window.
7. Press **Finished** to close the window.

Figure 6.11 – Database Restore Screen

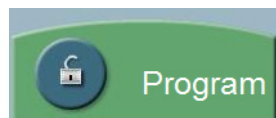


Lock a Program

Press the open padlock at any time to lock the program. To edit a locked program, use **Save As** and rename the program.

Note: When a program is locked the program cannot be unlocked. You cannot edit a locked program.

Figure 6.12 – Program Lock Button

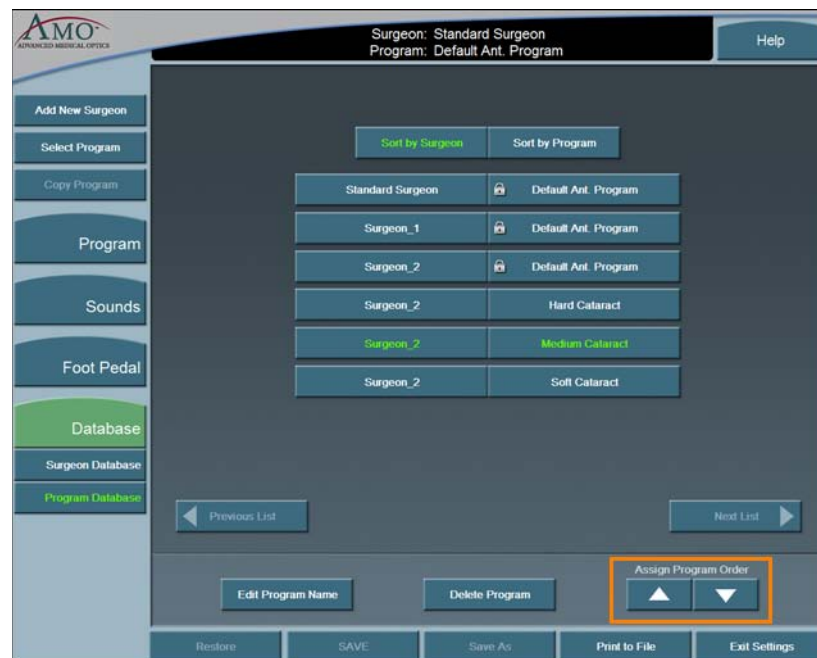


Program – Assign Order

Use **Program Assign Order** to change the order in which the surgeon names are shown on the **Select Surgeon** window.

1. Press **Configuration**.
2. Press **Surgeons and Programs**.
3. Press **Database**.
4. Select **Program Database**. A list of programs appears.
5. Select a program.
6. Use the **Assign Program Order Up** and **Down** arrows to move the Program. The arrows are found at the bottom of the window.

Figure 6.13 – Surgeon and Program Databases



7. Repeat steps 5 and 6 until you are satisfied with the order.
8. Select **Exit Settings**.

7

DIAGNOSTICS

Diagnostics

Wireless Footpedal Setup

Wireless Foot Pedal Calibration

Wireless Remote Control Setup

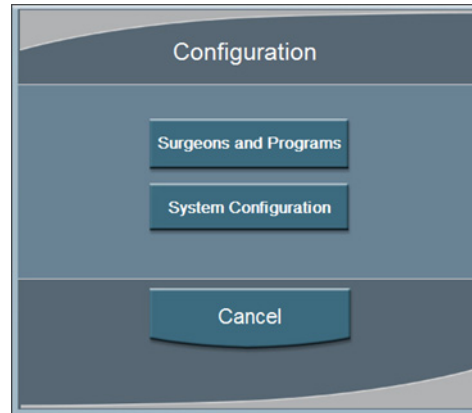
Calibrate Touch Screen

Diagnostics

To access diagnostics:

1. Press **Configuration**.

Figure 7.1 – Configuration Pop-up Window



2. Press **System Configuration**. On the System Configuration screen, **Diagnostic** is selected by default.

The Diagnostic screen shows the various Diagnostic Routines, Logs, System Utilities and Database Management functions that can be accessed by the Operator. Press the button for the diagnostic routine you want to run or view. Follow the instructions on the screen to complete the test process. The Service and Factory Diagnostic routines can only be accessed by authorized AMO service personnel.

Figure 7.2 – Diagnostics Screen

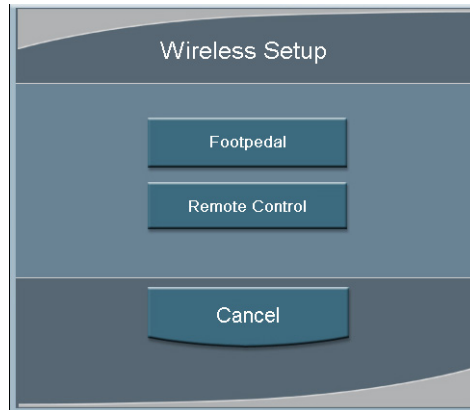


Wireless Footpedal Setup

You can pair the Wireless Foot Pedal (Advanced Control Pedal) to the system with either the Footpedal Cable or wireless. The Wireless Foot Pedal uses Bluetooth® technology to communicate with the system. The Wireless Foot Pedal has a range of ten (10) feet from the system.

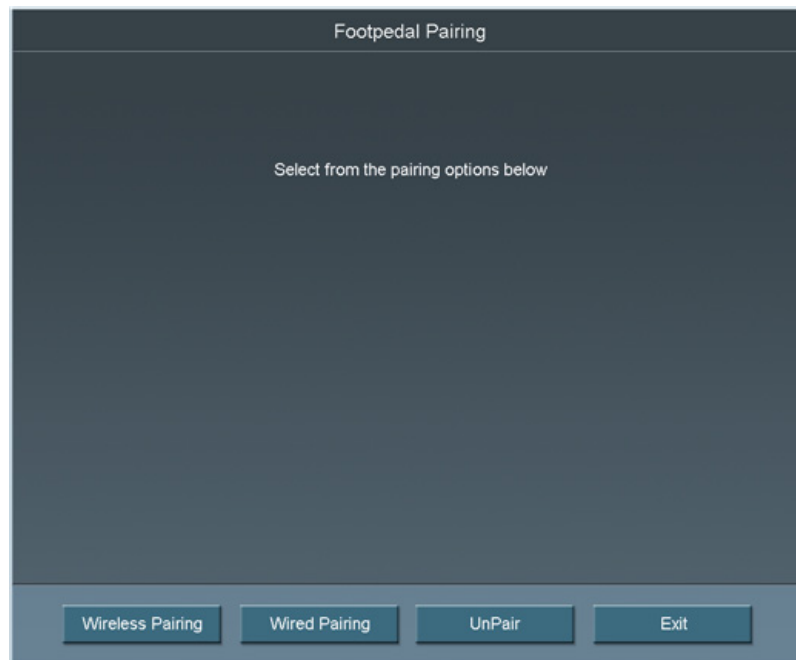
1. Press **Wireless Setup**.
2. Select **Footpedal**.

Figure 7.3 – Wireless Setup Pop-up Screen

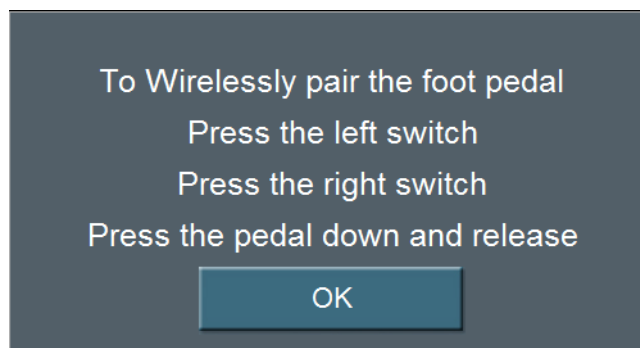


3. Select either **Wireless Pairing** or **Wired Pairing**. To use **Wired Pairing** you must have the Footpedal Cable attached to the system.

Figure 7.4 – Footpedal Pairing Screen



4. Follow the instructions shown on the screen.

Figure 7.5 – Wireless Footpedal Pairing Instructions

5. Press **Exit** to close the screen and access the Foot Pedal Test screen.
 - If the blue light is on, the wireless foot pedal is paired.
 - If the blue light is flashing the wireless foot pedal is not paired.
 - If the green light is on, the batteries in the foot pedal are charged.
 - If the green light is blinking, the batteries in the wireless foot pedal need to be charged. Attach the cable to charge the batteries.
6. Use UnPair to unpair either of the Advanced Control Pedals (dual linear) from the system.

Wireless Foot Pedal Calibration

To maintain optimal use of the foot pedal, the wireless foot pedal must be calibrated from time to time.

Figure 7.6 – Footpedal Calibration Screen



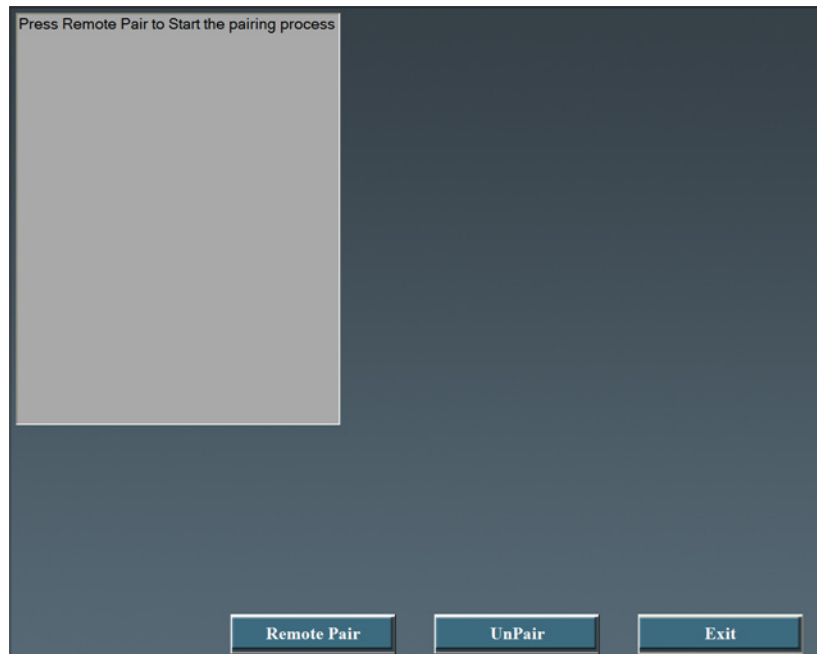
1. Press **Footpedal Calibration** from the **Diagnostic** screen. The Footpedal Calibration screen can also be accessed from the Foot Pedal Threshold screen.
Note: Only press the foot pedal when you are instructed. If you press the foot pedal at any other time the calibration of the foot pedal can fail.
2. Follow the instructions shown on the screen. The Calibration screen closes automatically when completed and the Foot Pedal Test screen opens.
3. Test the foot pedal.

Wireless Remote Control Setup

Use the **Wireless Setup** button to connect the System with a Wireless Remote Control.

Note: Make sure that the **Backlight** feature for the Wireless Remote Control is off (before you start the **Wireless Setup** process).

Figure 7.7 – Wireless Setup Screen



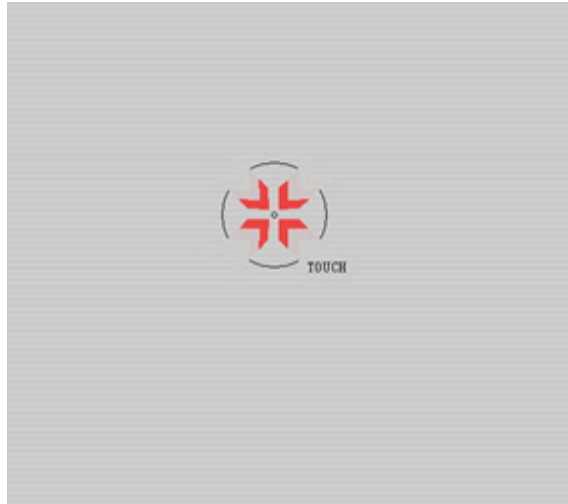
1. Press **Wireless Setup**.
2. Select **Remote Control**.
3. Press **Remote Pair**.
4. Follow the messages shown on the screen.
5. For the Remote Control:
 - Press the corresponding buttons on the wireless remote control as prompted. If **Remote Pair** fails, follow the instructions on the screen.
 - Press the buttons on the wireless remote control.
 - Verify for each button that the corresponding button on the screen lights. If the button does not light on the screen, the test fails. If the test fails contact AMO for technical service.
6. Press **Exit** to close the window.
7. Press the Unpair button to unpair the Remote.

Calibrate Touch Screen

The System touch screen needs to be calibrated as part of the system maintenance. Press **Calibrate Touch Screen** to start the calibration procedure.

1. Press the center of the target circle until the **Touch** message changes to **Release**.

Figure 7.8 – Touch Screen Target Circle



2. When released, the circle moves to the next point to be calibrated.
3. Repeat Step 1 for all of the calibration points.
4. Press **Accept** when all of the calibration points are completed.

8

CHECK-OUT PRECAUTIONS

System Check-out

System Check-out

The purpose of the check-out procedure is to verify that the System is installed and operating properly. The check-out procedure must be performed at least prior to the first case of the day and any time program changes are made as outlined in the following steps. The IA mode and handpiece are tested first, then the PHACO mode and handpiece, so that the phaco handpiece (which is used first) is set up and ready for surgery.

If any of the check-out steps are not successfully performed, they must be repeated. If the instrument still does not work correctly, refer to Chapter 10, “Error Messages Troubleshooting and Diagnostics”.

Note: Refer to **WARNINGS** in Chapter 3, “System Setup” before you set up the System.

Set-Up and Prime/Tune

Refer to the System Setup and Equipment Operation chapters of this manual for instructions on installing the tubing and priming/tuning the system.

Irrigation and Aspiration

1. Connect the tubing to the IA handpiece.
2. Select **IA** mode.
3. Hold the test chamber near the handpiece tip, press and hold the footpedal in Position 1.
4. Observe the irrigation flow.

Phacoemulsification

1. Connect the tubing to the phaco handpiece.
2. Screw the phaco needle onto the handpiece, use your fingers to engage the screw thread, and then use the tip wrench to tighten the needle. Screw the irrigation sleeve assembly over the needle.
3. Select the **PHACO** mode.
4. Press and hold the footpedal in Position 1.
5. Observe the irrigation flow.
6. Hold the handpiece approximately at the patient’s eye level, and fill the test chamber with irrigation fluid.
7. Place the test chamber over the irrigation sleeve.
8. Occlude the aspiration tubing just below the phaco handpiece. Press and hold the footpedal in Position 2. The actual vacuum level should rise to the preset level.

9. Release the occlusion and watch the test chamber to make sure that the test chamber does not collapse. A dent or dimple in the test chamber is normal.
10. To test irrigation, pinch the irrigation tubing at the IA handpiece and watch for the test chamber to collapse. Release the irrigation tubing and the test chamber should fill.
11. Press **Next Case** to reset the Phaco timer.

Phacoemulsification check-out is complete.

Diathermy



CAUTION: IF A TONE IS NOT HEARD WHEN THE FOOTPEDAL IS PRESSED AND VOLUME ADJUSTMENT IS UNSUCCESSFUL, THE MODE IS NOT FUNCTIONING PROPERLY. REFER TO Chapter 10, “Error Messages Troubleshooting and Diagnostics”.

1. Connect the Diathermy forceps to the cable and the cable to the front panel of the console.
2. Select the **Diathermy** mode.
3. Press the footpedal. A tone should be heard when the footpedal is pressed.

Vitrectomy

1. Attach the irrigation and aspiration cassette pack tubing together.
2. Press **Prime** on the Prime/Tune screen.
3. Press the **VIT** button to enter **VIT** mode.
4. Follow the instructions on the screen.
5. Observe that the:
 - irrigation fluid flows
 - aspiration tubing is full and clear of air
 - the vitrectomy cutter motor is activated (slight sense of motion of the handpiece)
 - cutter blade operates
6. Press **Start Vit Prime**. The screen closes automatically when the handpiece is primed.

Vitrectomy check-out is complete.

9

CARE AND CLEANING

Cleaning Procedures

Sterilization Procedures

WHITESTAR SIGNATURE™ System Cleaning and Care

Cleaning Procedures

All previously used reusable items must be handled according to ANSI/AAMI ST79:2006 *Comprehensive guide to steam sterilization and sterility assurance in health care facilities*. Information about the reuse of any products can be found in the Directions for Use for the particular product. All single use items or items which have completed their recommended useful life must be disposed of in accordance with accepted hospital practices and procedures and local governing ordinances and recycling plans. These items can include, but are not limited to, waste materials, waste collection bags, tubing, infusion-sleeves and test chambers.

Note: Inspect the Diathermy, Vitrectomy and Phaco handpiece cables for possible damage on a daily basis.

Phaco Handpiece

The following cleaning procedures for the phaco handpieces must be implemented immediately after use. The straight-through design of the phaco handpiece makes cleaning easy and greatly reduces the likelihood of the handpiece clogging.

However, to maximize the life of your instruments, you must clean the instruments immediately after use. Failure to properly clean the instrument can result in tissue buildup and dangerous cross-contamination.



WARNING: Balanced salt solutions tarnish and pit metals, which causes the handpiece to deteriorate. Proper cleaning of the instruments prolongs their useful life. AMO recommends using sterile nonpyrogenic water to clean the handpieces and accessories.



CAUTION: DO NOT STERILIZE THE HANDPIECES PRIOR TO PERFORMING THE CLEANING PROCEDURES DESCRIBED BELOW.

The following cleaning procedure is to be performed at the end of each surgical case:

1. With the tip cap sleeve and phaco tip still in place on the handpiece, inject 60 cc of sterile nonpyrogenic water through the irrigation tubing of the handpiece with a syringe. Remove the syringe and fill the syringe with air. Attach the syringe and flush the tube and handpiece with air.
2. Inject 60 cc of sterile nonpyrogenic water through the aspiration tubing of the phaco handpiece. It is helpful to use a female to female connector to attach the syringe to the aspiration tubing. Remove the syringe and fill the syringe with air. Attach the syringe and flush the tube and handpiece with air.
3. Carefully remove the phaco tip cap sleeve and phaco tip from the handpiece for disposal or to be sanitized and stored
4. Inject sterile nonpyrogenic water into the test chamber with a syringe and then empty. Repeat this step three to four times.

5. Aspirate sterile nonpyrogenic water through the phaco tip into a syringe; this clears any debris from within the tip and prevents clogging of the suction port.
6. Gently wipe the power cable of the handpiece with gauze soaked in distilled water.



WARNING: Improper/inadequate cleaning may result in particulate matter adhering to the instrument and exfoliation of particles into the surgical field. In addition, the function and life expectancy of the phaco handpiece can become compromised.



CAUTION: DO NOT CLEAN THE PHACO HANDPIECE WITH ANY TYPE OF ULTRASONIC CLEANING DEVICE; THE CLEANING DEVICE CAN DAMAGE THE PIEZOELECTRIC CRYSTALS.

Irrigation/Aspiration Handpiece

1. Back-flush the IA handpieces immediately at the end of the procedure.

Use a 10cc syringe with sterile nonpyrogenic water and flush the water from the back of the handpiece through the tip. This process must be performed at least two times through both the irrigation and aspiration channels.

Note: You can use other available AMO[®] products designed for this process (IA Cleaning Kit, AMO Part No. OM05510114).

Figure 9.1 – I/A Handpiece Cleaning



2. Make sure IA handpieces are dry when they are stored.

Diathermy Handpiece

Clean the diathermy handpieces with the same procedures you use to clean other ophthalmic instruments.

Note: Inspect the Diathermy, Vitrectomy and Phaco handpiece cables for possible damage on a daily basis.

Vitrectomy Cutter

The vitrectomy cutter is a disposable, single-use instrument.

Sterilization Procedures

AMO recommends that you follow the sterilization procedures outlined in this section to maximize the life of your System instruments.

All parts must be cleaned thoroughly prior to sterilization, and all sterilization equipment must be validated prior to use.



CAUTION: DO NOT STERILIZE THE HANDPIECES PRIOR TO PERFORMING THE CLEANING PROCEDURES DESCRIBED EARLIER IN THIS SECTION.

THE STORAGE CASES PROVIDED CANNOT BE PLACED IN AN AUTOCLAVE.

The following sterilization techniques, times, and temperatures must be used in order to ensure consistent product performance:

Gravity Displacement Sterilization – A type of sterilizer in which incoming steam displaces the residual air through a port or drain usually in or near the bottom of the sterilizer chamber. Typical operating temperatures are 121 to 123°C (250 to 254°F) and 132 to 135°C (270 to 275°F).

Prevacuum Sterilization – A type of sterilizer which relies on one or more pressure and vacuum excursions at the beginning or end of the cycle.

This method of operation usually results in shorter cycle times because of the rapid removal of air from the chamber and the load by the vacuum system, the usually higher operating temperature (132 to 135°C / 270 to 275°F; 141 to 144°C / 285 to 290°F), and the shorter exposure time for porous loads.

Note: The cycle times require the product to be wrapped. In an emergency situation only Flash Sterilization in accordance with ANSI/AAMI ST79:2006 *Comprehensive guide to steam sterilization and sterility assurance in health care facilities* can be used. The parameters for mixed porous and nonporous items must be used.



CAUTION: GAS STERILIZATION IS NOT RECOMMENDED.

Cooling is not necessary prior to reassembly; however, caution must be used to prevent burns. Follow the handpiece assembly instructions.



WARNING: Sterility assurance is the responsibility of the user. All non-sterile accessories must be sterilized prior to use. In addition, AMO recommends a terminal sterilization cycle in the autoclave after the final case of the day. This cycle must include a drying cycle to remove moisture from the tubing and handpieces for storage.

Devices undergoing sterilization must be thoroughly cleaned to minimize bio-burden. Validation of the sterilization vessel and the sterilization cycle is the responsibility of the user.

1. After sterilization, store the instruments in a safe, clean environment. Keep the instruments dry and free of dust. Make sure that the handpiece nose cone tips are adequately protected during storage.
2. Do not wind the phaco handpiece cord too tight. Handle the cord as you would a fiber optic cable. Follow the natural curve of the cord and wind only as tight as the natural curve of the cord (approximately 6 inch coiled cord diameter).



WARNING: Handle the phaco handpiece with extreme care. The piezoelectric crystal in the handpiece is very sensitive to shock. If the handpiece is dropped, it is possible that the handpiece might not function correctly. If this happens, contact AMO for repair information or replacement.

WHITESTAR SIGNATURE™ System Cleaning and Care

1. Turn the power switch on the back of the System **Off** before you unplug the system from the wall outlet.
2. At the end of the day, thoroughly wipe down the system, cart, power pole and footpedal using a cloth dampened with a germicidal detergent and sterile nonpyrogenic water. Be careful not to saturate any part of the system or the footpedal with liquid. Excessive liquid can damage the System electronics.
3. Do not push or pull on the system components.
4. AMO recommends that you leave the footpedal and power cords connected to the system to prevent loss and unnecessary wear on the electrical connectors.
5. Although the footpedal is water-resistant, make sure that the footpedal is kept as dry as possible.
6. Place the Advanced Control Pedal (dual linear) in the storage recess at the bottom of the console so that the footpedal batteries can charge. You can attach the footpedal cable to the console to charge the batteries.
7. Place the wireless remote control in the storage recess on the top of the console so that the Wireless Remote Control batteries can charge.

10 ERROR MESSAGES TROUBLESHOOTING AND DIAGNOSTICS

Error Message Display

Fuse Replacement Procedure

Wireless Foot Pedal Battery Replacement Procedure

Most Common User-Correctable Problems

Status, Warning and Error Messages

System Operation (Error) Messages

Troubleshooting

Error Message Display

The red Error Messages are shown at the top of the screen. Press the Help button to open the corrective action for that error. When the error is corrected, press OK to clear the error message from the screen. If the error message is cleared but not corrected, the error message is generated again.

The yellow Alerts are shown at the top of the screen. The alert does not need to be cleared as an error message. An alert, for example, can be: Remote Control Battery power level is 10 – 25% of maximum. The battery needs to be charged.



WARNING: DO NOT try to replace the Wireless Remote Control batteries. Call your AMO Technical Service representative to replace the batteries.

Fuse Replacement Procedure

If the System does not turn on when the power switch is turned **On**, and you have confirmed that the power cord is properly connected and plugged in, check to see if the fuse is bad.

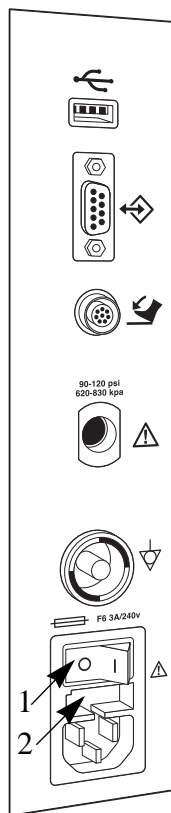
Note: To prevent the risk of fire or damage to the instrument, replace the fuses with the exact type and rating as indicated below (check the voltage sticker on the back panel of System to confirm your system voltage):

Table 10.1 – Fuse Specifications

	Voltage	Quantity	Fuse Specifications
Console	100/120/240	2	6.3A, 250V, Bussman GDA

To replace the console fuses:

1. Unplug the System electrical power.
2. Unplug the power cord from the back panel.
3. Locate the fuse holder on the back panel of the System, as shown below.
4. Use a small screwdriver to gently pry open the cover and expose the fuse holder.
5. Gently pry out the fuse holder.
6. Remove the bad fuse and replace the fuse with a new fuse (value and size specified above).
7. Replace the fuse holder. Make sure that the arrows point to the right side of the back panel. Tilt the fuse holder slightly to the right and push in.
8. Push the fuse holder cover up and in until the cover snaps closed.
9. Reconnect the power cord to the back panel.
10. Plug the System into an electrical receptacle (outlet).

Figure 10.1 – Fuse Location

1. Power Switch 2. Fuse Holder

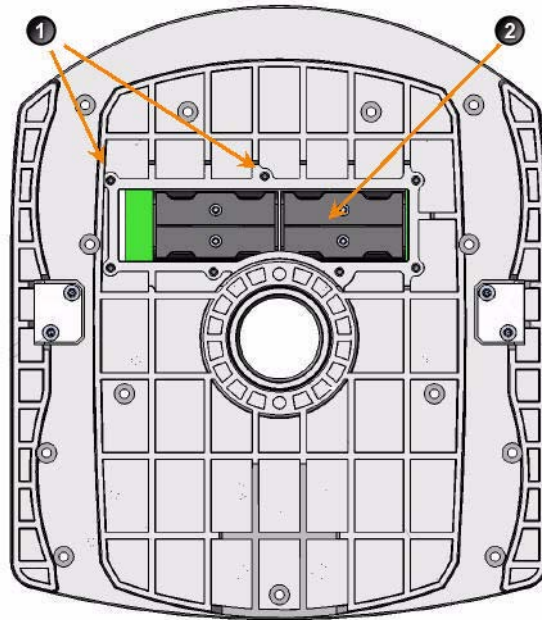
Wireless Foot Pedal Battery Replacement Procedure

Four AA size NiMH batteries provide power to the wireless foot pedal. You must replace the batteries with the same size and type (NiMH) of batteries. If incorrect batteries are used, the wrong batteries might cause damage to the foot pedal.

To replace the batteries in the foot pedal:

1. Remove the screws on the battery cover. The battery cover is located on the bottom of the foot pedal.
2. Remove the old batteries. Do not throw the batteries in to the garbage. Use the proper disposal method for the batteries.
3. Insert the new batteries. Make sure that the batteries are inserted correctly.
4. Replace the battery cover and tighten all of the screws.

Figure 10.2 – Battery Location for the Wireless Foot Pedal



1. Battery Cover Screws (7) 2. NiMH Batteries

Most Common User-Correctable Problems

Use the information in this section if you are not successful with the System Check-out. Consult this section to resolve the problem before you call AMO for technical service.

Before you call AMO for service:

- Make sure that the System is plugged in to a power receptacle.
- Make sure that there is electrical power to the receptacle.
- If there is no phacoemulsification, make sure that the phaco needle is tight on the handpiece.
- If there is no phacoemulsification, make sure that the phaco needle is compatible with the handpiece (for example, non-AMO[®] phaco needle on an AMO[®] handpiece).
- If there is no phacoemulsification, confirm that phaco needle/handpiece was not damaged by dropping or misuse.
- If no irrigation occurs, shake the drip chamber to confirm that the ball or valve moves freely. If there is no rattle sound, replace the drip chamber with another disposable tubing pack.

Status, Warning and Error Messages

The System shows Status, Warning and Error Messages on the monitor.

The message can show possible solutions or recommendations to clear the error. The messages can indicate the available options if a component or subsystem fails.

The messages are listed in the following pages with the corrective actions to be taken to clear the error.

Recycle Power as a Corrective Action means that you turn the System **Off** (through the normal shut down procedure), wait a few seconds, and then turn the System **On**. If an error cannot be corrected, document the error message before you call AMO for technical service. Technical Service needs to know the error message to diagnose and correct the error.

System Operation (Error) Messages

Table 10.2 – Fluidic Controller Error Messages

Error Number	Message	Probable Cause	Corrective Action
14	Vacuum Parameter Check Failure.	Hardware failure or program error.	Select Next Case .
15	Flow Parameter Error	Hardware failure or program error.	Select Next Case .
16	FP Yaw Parameter Error	Hardware failure or program error.	Select Next Case .

Error Number	Message	Probable Cause	Corrective Action
17	FP Pitch Parameter Error	Hardware failure or program error.	Select Next Case .
18	IV Check Error	Hardware failure or program error.	Select Next Case .
19	Vit Cutter Check Error	Hardware failure or program error.	Select Next Case .
101	Fluidics communication error.	Invalid data from the IH or communication errors.	Select Next Case .
102	Fluidics write error.	Microcontroller SPI, SPI Bus, EEPROM, or ADC is faulty.	Cycle power.
103	Fluidics read error.	Microcontroller SPI, SPI Bus, EEPROM, or ADC is faulty.	Cycle power.
104	Fluidics Reservoir Vacuum Level Error.	External air pressure low. Venturi muffler clogged. External air valve clogged. External air leak. Venturi vacuum path leak. Vacuum sensor not calibrated or faulty.	Reprime the System.
105	Fluidics Reservoir Leak.	Venturi vacuum path leak	Reprime the System.
106	Fluidics Tank Vacuum Level Error.	Reservoir vacuum is low. Tank vacuum path leak. Vacuum sensor not calibrated or faulty. Vacuum regulator not calibrated or faulty. Vacuum regulator drive circuit failure.	Reprime the System.
107	Fluidics Tank Leak.	Tank vacuum path leak.	Reprime the System.

Error Number	Message	Probable Cause	Corrective Action
108	Fluidics Pack Vacuum Level Error.	Reservoir vacuum is low. Pack vacuum path leak. Vacuum sensor not calibrated or faulty. Vacuum regulator not calibrated or faulty. Vacuum regulator drive circuit failure.	Reprime the System.
109	Fluidics Pack Leak.	Pack leak.	Reprime the System.
110	Fluidics RAM error.	Bad Microcontroller.	Cycle power.
111	Fluidics ROM error.	Bad Microcontroller.	Cycle power.
112	Fluidics Master Communication error.	Instrument Host malfunction. Bad microcontroller.	Cycle power.
113	Drain Pump Fault.	Droplets, bubbles, or fog on chamber walls. Bad fluid level sensor(s). Bad cable. Fluid level sensor drive circuits faulty. Drain pump drive circuit fault.	Check the chamber and the bag for over-inflation. Select Next Case .
114	Fluidics DAC Fault.	Circuit failure (I2C bus, DAC, or micro).	Reprime the System.
115	Fluidics Evacuation Vacuum Level Error.	Reservoir vacuum is low Evacuation vacuum path leak Vacuum sensor not calibrated or faulty Vacuum regulator not calibrated or faulty Vacuum regulator drive circuit failure	Reprime the System.
116	Fluidics Evacuation Leak.	Evacuation path leak.	Reprime the System.

Error Number	Message	Probable Cause	Corrective Action
117	Fluidics Fluid Level Sense Error.	Droplets, bubbles, or fog on chamber walls. Bad fluid level sensor(s). Bad cable. Fluid level sensor drive circuits faulty.	Check the chamber and the bag for over-inflation. Select Next Case.
118	Fluidics Irrigation Valve error.	Valve failure. Drive circuit failure.	Cycle power.
119	Fluidics Pinch Valve error.	Valve failure. Drive circuit failure.	Cycle power.
120	Fluidics Silicone Extraction Valve Fault	Valve failure. Drive Circuit failure.	Disable Venturi or select Next Case.
121	Fluidics Pack Alignment Valve Fault.	Pump failure. Drive circuit failure.	Reinsert the pack and reprime.
122	Fluidics Dump Valve Fault.	Valve failure. Drive circuit failure.	Disable Venturi or select Next Case.
123	Fluidics Venturi Valve Fault.	Valve failure. Drive circuit failure.	Disconnect compressed air. Reprime the system.
124	Fluidics Rotary Vane Fault.	Pump failure. Drive circuit failure.	Connect compressed air. Reprime the system.
125	Fluidics Pack Valve error.	Valve failure. Drive circuit failure.	Cycle power.
127	Fluidics Valve Vent error.	Irrigation blocked.	<ol style="list-style-type: none"> 1. End the current Case. 2. Start a New Case. 3. Reprime the System. 4. Turn the system off, wait a few seconds, then turn the system on. 5. Install a new tubing cassette 6. If the error does not clear or if the error continues to occur, document the Error Message and contact AMO for technical service.
128	Fluidics Pack Loading error.	Pack not properly seated.	Reload the tubing cassette. Reprime.
129	Fluidics Proportional Valve Fault.	Valve failure. Drive circuit failure.	Disconnect compressed air. Reprime the system.

Error Number	Message	Probable Cause	Corrective Action
130	Fluidics Encoder error.	Pack loading problem. Encoder is faulty. Decoder circuit is faulty. Stepper driver circuit is faulty.	Reload the tubing cassette. Select Next Case .
131	Fluidics Mode error.	Instrument Host malfunction. Bad SSC Board. Bad footpedal.	Cycle power.
132	Fluidics VAC regulator current is too high or too low.	Vacuum regulator faulty. Drive circuit faulty.	Disable Venturi or select Next Case .
133	Fluidics strain gauge ADC error.	ADC is faulty.	Cycle power.
134	Fluidics Drain Pump Rotational Error.	Pack loading problem. Encoder is faulty. Decoder circuit is faulty. Stepper driver circuit is faulty.	Insert Fusion™ Pack or select Next Case . Reprime the system.
135	Low external air pressure.	Leak in external air supply path. Pressure regulator set too low. Pressure sensor faulty.	Reinsert the pack and reprime. Check the external air supply.
136	Fluidics VAC Regulator Vent Fault.	Pinch valve is blocked.	Disable Venturi or select Next Case .
137	Footpedal error.	Bad footpedal or user depressing footpedal.	Release the footpedal. Disconnect and reconnect footpedal. Cycle power and retry.
138	Tank fluid level has reached the top sensor.	Drain pump cannot keep up with the input of fluid.	Please wait for the tank to drain
144	Fluidics Vacuum Sensors Disagree Error.	Leak in vacuum path Vacuum sensor faulty.	Reinsert the pack and reprime.
147	Reservoir vacuum is too low. Target vacuum cannot be reached.	Leak Vacuum regulator faulty Drive circuit faulty	Select Next Case . Reprime the system.

Error Number	Message	Probable Cause	Corrective Action
148	Pressure to pack capture mechanism is less than 60 psi.	Leak	Reinsert the pack and reprime.
149	Unloaded strain gauge reading is too high or too low.	Pack not loaded correctly.	Reinsert the pack and reprime.
201	Phaco Communication error.	Bad data sent from host.	Retune or cycle power.
202	Phaco power error.	Hardware failure (phaco driver).	Retune or cycle power.
203	Phaco handpiece error.	Bad handpiece.	Retune or cycle power. Replace the phaco handpiece.
204	Phaco handpiece error.	Wire in handpiece broken.	Retune or cycle power. Replace the phaco handpiece.
207	Incompatible Handpiece Error.	Incompatible handpiece.	1. Turn off Ellips™ Technology. 2. Attach the Ellips™ handpiece. 3. Tune the handpiece.
210	Phaco RAM error.	Chip is bad.	Cycle power.
211	Phaco ROM error.	Bad 196 processor.	Cycle power.
212	Phaco controller timeout.	Host stopped writing to the Phaco controller.	Cycle power.
281	Phaco communication error.	Software bug or Hardware failure.	Cycle power.
282	Phaco error.	Bad handpiece.	Check handpiece and retune.
283	Phaco error.	Driver failure.	Check handpiece and retune. Replace the handpiece and tune.
284	Phaco power supply error.	Bad Power Supply.	Cycle power or call service.
285	Check for loose handpiece and retune.	Tip is loose.	Check for loose handpiece tip and retune. Replace the handpiece and tune.
286	Phaco handpiece impedance error.	Bad handpiece.	Check handpiece and retune. Replace the handpiece and tune.

Error Number	Message	Probable Cause	Corrective Action
288	Diathermy error.	DIA subsystem issue.	Check handpiece. Select Next Case or cycle power.
290	Footpedal error.	Bad footpedal or user pressing the footswitch.	Check footpedal. Cycle power.
291	Phaco Diathermy power supply error.	Software or hardware failure.	Cycle power.
301	Pneumatics RAM error.	Microcontroller failure.	Cycle power.
302	Pneumatics ROM error.	Microcontroller failure.	Cycle power.
303	Pneumatics Master communication error.	Watchdog event. PC104 Bus failure. Micro failure. CPLD failure.	Cycle power.
307	Pneumatics communication error.	Invalid data received by the IH or communication error.	Cycle power.
308	External air pressure high/low.	Valve failure. Drive circuit failure.	Check compressed air supply. Select Next Case .
309	Piston pump pressure high/low.	Pump failure. Drive circuit failure.	Select Next Case .
310	Vit selector valve pressure high/low.	VIT Selector Valve failure. Drive circuit failure.	Select Next Case .
311	Dump valve pressure high/low.	VIT Dump Valve failure. Drive circuit failure.	Select Next Case .
312	Cut valve pressure high/low.	VIT Cut Valve failure. Drive circuit failure.	Select Next Case .
322	Pneumatics system pressure too low.	V1 External Air valve not open. Piston Pump not working. System leak. Dump valve not closing. Vitrectomy Cut valve always on.	Select Next Case .

Error Number	Message	Probable Cause	Corrective Action
323	Pneumatics system pressure too low.	PP1 Piston Pump not working. Piston Pump not working. System leak. Dump valve not closing. Vitrectomy Cut valve always on.	Select Next Case .
327	Pneumatics system pressure too low at the high cut rates.	PP1 Piston Pump not working. Piston Pump not working. System leak. Dump valve not closing. Vitrectomy Cut valve always on. Selector valve is not changing.	Select Next Case .
336	Pneumatics system pressure too low at the low cut rates.	PP1 Piston Pump not working. Piston Pump not working. System leak. Dump valve not closing. Vitrectomy Cut valve always on. Selector valve is not changing.	Select Next Case .
353	IH to GUI Communication Timed Out.	Software error or hardware error.	Select Next Case .
360	IH Fluidics – read error.	Communication error.	Cycle power.
361	IH Fluidics – write error.	Communication error.	Cycle power.
362	IH Fluidics – Comm. error.	Communication error.	Cycle power.
370	IH Phaco read error.	Communication error.	Cycle power.
371	IH Phaco write error.	Communication error.	Cycle power.
372	Bad Phaco long pulse.	Communication error.	Check program setting. Cycle power.
373	IH Invalid Phaco burst setting.	Communication error.	Check program. Cycle power.
374	Handpiece removed during Phaco.	No handpiece is connected.	1. Attach a handpiece. 2. Tune the handpiece.

Error Number	Message	Probable Cause	Corrective Action
375	Incompatible HP.	Attempted to use Ellips™ Phaco settings with a WHITESTAR® handpiece.	<ol style="list-style-type: none"> 1. Turn off Ellips™ Technology. 2. Attach the Ellips™ handpiece. 3. Tune the handpiece.
380	IH Pneumatics – read error.	Communication error.	Cycle power.
381	IH Pneumatics – write error.	Communication error.	Cycle power.
390	IH Diag read error.	Communication error.	Cycle power.
391	IH Diag write error.	Communication error.	Cycle power.
416	Footpedal communication error.	Could not open port. Footpedal not responding.	Reconnect footpedal.
418	Footpedal compatibility error.	New footpedal firmware.	Replace footpedal.
501	Prime excessive vacuum error.	Communication error.	Check the tubing cassette. Reload or replace the tubing cassette. Reprime.
502	Prime low bottle height error.	Bottle not at the proper height.	Increase bottle height and reprime.
503	Prime low vacuum error.	Hardware failure.	Check the tubing cassette. Reload or replace the tubing cassette. Reprime.
507	Prime EQ pressure error.	Hardware failure.	Reprime.
508	Prime low venturi vacuum error.	Hardware failure.	Reprime.
511	IV Pole communications error.	Communication error.	Reprime the system.
512	IV Pole communications error.	Communication error.	Reprime the system.
513	IV Pole communications error.	Communication error.	Reprime the system.
514	IV Pole error.	Communication error.	Reprime the system.

Error Number	Message	Probable Cause	Corrective Action
515	IV Pole calibration error.	Communication error.	Reprime the system.
516	IV Pole communication error.	Communication error.	Reprime the system.
517	IV Pole jammed.	Jammed. Motor failure. A “Short” in the motor wires. Obstruction is not allowing the pole to move	Check for obstructions. Reprime the system.
601	Tune excessive vacuum error.	Hardware failure.	Check the tubing and the connections to the handpiece. Retune.
605	Tune no handpiece error.	Hardware failure.	Insert handpiece and retune.
2000	DLL CRC Error	DLL checksum does not match config.dat.	Cycle power.
2001	CRC Error	STR checksum does not match config.dat.	Cycle power.
2002	Database Self Test Error	Database file checksum does not match config.dat.	Cycle power.
2003	Error updating database file.	Error when database was saved.	Cycle power.
2004	Error adding language.	Error during the Install Language session.	Cycle power.
2005	Error reading USB memory stick.	Error during an Import or Export session.	Cycle power.
2006	Error loading DLL.	Cannot find or load a DLL file.	Cycle power.
2007	Record file save error.	Error when Record database file was saved.	Cycle power.
2008	Error reading Record file.	Cannot read Record database file.	Cycle power.
2010	IH Communication timed out.	No communication with the IH.	Cycle power.

Error Number	Message	Probable Cause	Corrective Action
2011	Error retrieving version strings from IH.	Cannot not retrieve the IH version numbers.	Cycle power.
2012	IH timeout error.	No communication with IH.	Cycle power.
2014	IH Selftest error.	Cannot get Selftest status from the IH.	Cycle power.

Troubleshooting **Table 10.3 – Troubleshooting – General**

General	
Problem	Corrective Action
The System does not come on when the power switch is turned on.	<ol style="list-style-type: none"> 1. Turn the power switch Off. 2. Confirm that the power cord is connected to the console back panel. 3. Confirm that the power cord is plugged into the electrical receptacle or another power source. 4. Confirm that there is electrical power to the wall receptacle or power source. 5. Turn the system On. 6. If the system still does not come on, turn the power Off. Check for bad fuses and replace the fuse if necessary. 7. Contact AMO for Technical Service.

General	
Problem	Corrective Action
<p>The wireless remote control does not pair.</p>	<ol style="list-style-type: none"> 1. Make sure that you are pairing only one remote. If you try to pair more than one remote at the same time, the pairing fails. 2. Only pair the remote with one console at a time. Do not press the pairing key sequence on multiple remote controls as this causes the pairing to fail. 3. Do not have any other Bluetooth® devices in the same area as the remote and the console (other remote controls, dual linear foot pedals, cell phones, or headsets, for example) as the pairing operation will fail. The software only detects a maximum of nine (9) devices any more than nine and the pairing fails. 4. Check to see if the remote control is in “Sleep” mode. If the remote is in “Sleep” mode, press the Backlight button on the remote. Complete the UP, DOWN, RIGHT, LEFT, RELOAD key sequence to pair the remote. Note: Always press the Backlight button before you pair the remote. 5. The remote control can only be paired with one console at a time. Make sure that the remote has not been paired with another console. You must: <ul style="list-style-type: none"> • Unpair the remote from the console. • Shut down the console. • Pair the remote with the new console. Make sure this console is at least 40 meters away from the first console. 6. The remote cannot be paired with another console after that remote has been paired. (You cannot pair one remote with two (2) consoles.) <ul style="list-style-type: none"> • Unpair the remote from the console. • Move the first remote out of range from the console. • Wait for the first remote to go into “Sleep” mode. • Pair the new remote. 7. Make sure that the batteries are fully charged before you pair the remote with the console. Low batteries can cause pairing failures. 8. Charge the batteries if pairing has failed after several attempts. 9. When the batteries are charging (the remote is in the charge cradle): <ul style="list-style-type: none"> • The Bluetooth® is turned off • The remote cannot be used • Pairing cannot be performed

General	
Problem	Corrective Action
Dual Linear Foot Pedal does not pair.(Advanced Control Pedal)	<ol style="list-style-type: none"> 1. Make sure that the foot pedal is not paired with another console. 2. Do not have any other Bluetooth® devices in the same area as the foot pedal and the console (other remote controls, dual linear foot pedals, cell phones, or headsets, for example) as the pairing operation will fail. The software only detects a maximum of nine (9) devices any more than nine and the pairing fails. 3. Make sure that the batteries are fully charged before you pair the foot pedal with the console. Low batteries can cause pairing failures. 4. Charge the batteries if pairing has failed after several attempts. 5. When the batteries are charging (the foot pedal is in the charge cradle): <ul style="list-style-type: none"> • The Bluetooth® is turned off • The foot pedal cannot be used • Pairing cannot be performed
The footpedal is not operating properly.	<ol style="list-style-type: none"> 1. Go to the Diagnostics section and perform a Footpedal Test. 2. Confirm the footpedal cord is connected at the back of the console. 3. Confirm the footpedal is paired to the System, for the Advanced Control Pedal (dual linear) only. 4. Perform a Foot Pedal Calibration, for the Advanced Control Pedal (dual linear) only. 5. Replace the wireless footpedal batteries, Advanced Control Pedal (dual linear) only.
The Programmable IV Pole does not respond.	<ol style="list-style-type: none"> 1. The pole might have reached maximum or minimum height. 2. Attempt a Programmable IV Pole height adjustment with the touch screen, remote, or the up and down switch on the side of the system.
The Touch Screen does not respond.	Perform the Touch Screen Calibration procedure as described in Diagnostics.
Priming Errors.	<ol style="list-style-type: none"> 1. Check the tubing pack loading, including reloading the tubing cassette. 2. Verify that there are no kinks, clogs, or loose fittings. 3. Replace the handpiece and the tip and prime. 4. Replace the tubing cassette. 5. Check the test chamber for proper installation and leaks. 6. Contact AMO Technical Service to check the vacuum.

Table 10.4 – Troubleshooting – Irrigation

Irrigation	
Problem	Corrective Action
No irrigation flow.	<ol style="list-style-type: none"> 1. Make sure the appropriate mode is selected on the screen. 2. Check for kinks in the irrigation tubing. 3. Check the tubing connection to the handpiece. 4. Tap the drip chamber to make sure the valve operates properly. 5. Check the bottle height. 6. Press the footpedal to Position 1 and check for flow. 7. Listen for the irrigation pinch valve in the tubing manifold area to confirm that the valve operates when the footpedal is pressed. 8. If there is still no flow, replace the tubing cassette.
Reduced/insufficient irrigation flow.	<ol style="list-style-type: none"> 1. Check for kinks in the tubing or leaks in the tubing or the handpiece. 2. Check the bottle height. 3. Check the tubing connections. 4. Check for a pinched irrigation sleeve at the incision.
Irrigation flow continues even when footpedal is Off (Position 0).	<ol style="list-style-type: none"> 1. Check that the footpedal is not obstructed and not stuck in P 1. 2. Check the footpedal operation. 3. Verify that Continuous Irrigation is not active.
Anterior chamber is too shallow or too deep.	<ol style="list-style-type: none"> 1. Check the bottle height. 2. Too shallow, check for a pinched irrigation sleeve at the incision. 3. Check the pump speed (flow rate). 4. Check that the irrigation tubing is not obstructed. 5. Make sure Irrigation and Aspiration are balanced.
Using large amounts of fluid.	<ol style="list-style-type: none"> 1. Check the bottle height. 2. Check the incision size. 3. Check the flow rate (pump speed too high). 4. Check that no fluid enters the collection bag when you do not use irrigation. 5. Reseat or replace the tubing.

Table 10.5 – Troubleshooting – Aspiration

Aspiration	
Problem	Corrective Action
No aspiration.	<ol style="list-style-type: none"> 1. Make sure the appropriate mode is selected on the screen. 2. Check for kinks or clogs in the tubing. 3. Check the tubing connection to the handpiece. 4. Make sure that the handpiece is not clogged. 5. Press the footpedal to Position 2 and check the pump function.
Poor aspiration.	<ol style="list-style-type: none"> 1. Check the flow rate. 2. Check the footpedal operation. 3. Check for kinks or clogs in the tubing. 4. Make sure that the handpiece is not clogged. 5. Check the tubing connection to the handpiece. 6. Check the IA handpiece o-rings for excessive wear. Replace the o-rings, if needed.
Not building vacuum. Pump does not turn.	<ol style="list-style-type: none"> 1. Check the programming. If the surgeon is in “linear vacuum” as opposed to “linear aspiration”, the footpedal must be pressed through Position 2 for the vacuum to reach the preset maximum. 2. Make sure the footpedal is pressed. 3. Check the tubing connection to the handpiece. 4. Check for air in the irrigation and aspiration tubing. 5. Check the system vacuum settings. 6. Replace the tubing cassette 7. Run IA Prime. 8. Check the flow rate.
Chamber shallowing or partially collapses.	<ol style="list-style-type: none"> 1. Check the bottle height and the handpieces for correct position. 2. Check the flow rate setting. 3. Check the tubing fittings to the handpiece. 4. Check for kinks in the tubing. 5. Remove the handpiece and perform the test chamber test to make sure the handpiece is balanced. 6. Make sure Irrigation and Aspiration are balanced.

Table 10.6 – Troubleshooting – Phacoemulsification

Phacoemulsification	
Problem	Corrective Action
No phacoemulsification.	<ol style="list-style-type: none"> 1. Make sure that the PHACO mode is selected on the touch screen. 2. Make sure that the System is Primed and Tuned. 3. Check the footpedal operation. 4. Make sure that the phaco handpiece cord is properly connected to the phaco receptacle on the front of the system. 5. Check the Phaco Power setting. 6. Make sure that the phaco tip is tight on the handpiece. 7. Check to make sure that the phaco tip is not damaged. 8. If the tip is damaged, replace the tip with a new tip and retune.
Poor or intermittent phacoemulsification.	<ol style="list-style-type: none"> 1. Check all of the corrective steps above for “No Phacoemulsification”. 2. Remove the phaco tip and then replace the tip. Make sure the tip is tight on the handpiece. 3. Check the Phaco Power delivery setting for both unoccluded and occluded (if applicable) settings. 4. Tune the phaco handpiece.

Table 10.7 – Troubleshooting – Diathermy

Diathermy	
Problem	Corrective Action
No diathermy or poor diathermy.	<ol style="list-style-type: none"> 1. Make sure that the Diathermy mode is selected on the touch screen. 2. Check the footpedal operation. 3. Check the Diathermy Power setting. 4. Check the diathermy cord for a secure connection to the forceps and to the diathermy receptacles on the system. 5. Make sure that the diathermy cord connections are dry. 6. Try to use diathermy starting at a low power setting and gradually increase the power. 7. Replace the diathermy cord. 8. Replace the diathermy handpiece.
No sound when using diathermy.	<ol style="list-style-type: none"> 1. Make sure the Volume Setting is set at 6 or greater in Settings. 2. Check for sounds when you push any touch screen or remote buttons. 3. Check for an audible confirmation upon completion of system start-up test (at power up). 4. Perform the Sound Test on the Diagnostics screen.

Table 10.8 – Troubleshooting – Vitrectomy

Vitrectomy	
Problem	Corrective Action
No vitrectomy cutting or poor cutting.	<ol style="list-style-type: none"> 1. Make sure that the Vitrectomy mode is selected on the touch screen. 2. Verify that the surgeon is in footpedal Position 3, if IAC step vitrectomy is programmed. If ICA is programmed, verify the footpedal is in Position 2. 3. Check the footpedal operation. 4. Check the tubing connections to the vitrectomy cutter. 5. Check the vitrectomy tubing connection to the front panel receptacle on the system. 6. Check the Vitrectomy Rate (CPM) setting on the touch screen. Lower the CPM, if necessary. 7. Check that irrigation and aspiration are working correctly. 8. Verify that the cutter blade moves. 9. Replace the vitrectomy cutter and try again.

11

WARRANTY AND MAINTENANCE

Warranty Statement

Warranty Statement

AMO warrants for a period of two years (24 months) from the date of installation of the WHITESTAR SIGNATURE™ System console, footpedal, wireless remote control, programmable power pole and the phaco handpiece to be free from defects in materials and workmanship when properly installed, maintained, and used for the intended purpose.

MISUSE AND MISHANDLING ARE NOT COVERED UNDER WARRANTY. AMO's sole obligation is to repair or replace, at AMO's option, the defective part(s).

The Irrigation/Aspiration Handpiece Set, Diathermy Forceps and Diathermy Cord are warranted for ninety (90) days.

This warranty applies only to the original purchaser/user of the device and only so long as the equipment is used in the country to which it was originally shipped by AMO.

THIS WARRANTY IS IN LIEU OF ALL OTHER WARRANTIES, EXPRESSED OR IMPLIED, INCLUDING WITHOUT LIMITATION THE WARRANTIES OF MERCHANTABILITY OR FITNESS FOR A PARTICULAR PURPOSE. IN NO EVENT SHALL AMO BE LIABLE TO THE PURCHASER FOR CONSEQUENTIAL DAMAGES.

Extended Warranty

Extended Warranty Contracts (excluding the phaco handpiece) are available. Contact AMO for information on the availability of an Extended Warranty Contract.

Note: If outside the United States, contact your local AMO office or representative for warranty information.

Maintenance

User maintenance of the WHITESTAR SIGNATURE™ System is limited to those adjustments and corrective actions given in the Error Messages and Troubleshooting, and Diagnostics sections of this manual. There are no user serviceable components within the machine and you must not attempt to access the internal components. Any attempt to do so will void the warranty.

Routine or periodic maintenance of the WHITESTAR SIGNATURE™ System by an AMO representative is recommended at least annually. AMO recommends the measurement of PE resistance and leakage current according to IEC 601-1 every two years.

If a problem continues following setup, check-out and troubleshooting as per the procedures given in this manual, contact AMO for corrective action (1-877-AMO-4LIFE in USA 1-877-266-4543). Please contact your local AMO office or representative for region-specific phone numbers.

12

SPECIFICATIONS

Physical Specifications

Environmental Specifications

Electrical Specifications

Diathermy Specifications

Irrigation and Aspiration Specifications

Phacoemulsification Specifications

Vitrectomy Specifications

Diathermy Power Graphs

Diathermy Power versus Load Impedance

Phaco Power Graphs

**Physical
Specifications**
Table 12.1 – System Physical Specifications

		English / U.S.	Metric:
WHITESTAR SIGNATURE™ System Console:			
Console Dimensions (with display)	Width	24 inches	61 cm
	Depth	24 inches	61 cm
	Height	54 inches	137 cm
Power Cord Length		20 feet	6 meters
Electrical Enclosure Current Leakage		IEC 60601-1 compliance UL 60601-1	
Weight (including IV pole)		195 pounds	88.5 kg
Footpedal:			
Single Linear			
Dimensions	Width	12 inches	31 cm
	Length	10.5 inches	27 cm
	Height	5.5 inches	14 cm
Weight		10.0 pounds	4.5 kg
Advanced Control Pedal (Dual Linear)			
Dimensions	Width	10.5 inches	27 cm
	Length	14 inches	36 cm
	Height	5.5 inches	14 cm
Weight		15 pounds	7 Kg
Cord Length		11.8 feet	36 cm
Power IV Pole:			
Maximum Travel		41 inches	107 cm
Velocity		2.4 inches/sec	6 cm/sec.
Maximum Lift Weight		2.43 pounds	1.1 kg
Wireless Remote Control			
	Width	5 inches	13 cm
	Length	5 inches	13 cm
	Height	1.5 inches	4 cm
	Weight	2.0 pounds	.9 kg

Environmental Specifications**Table 12.2 – Environmental Specifications**

Environmental Specifications	Operating Temperature	10 to 40°C
	Humidity	Up to 95% RH, non-condensing
Storage/Transportation Conditions	Storage Temperature	-20 to 60°C
	Humidity	Up to 95% RH, non-condensing

Electrical Specifications**Table 12.3 – Electrical Specifications**

	Voltage	Frequency	Rated Power	Fuse Rating	Enclosure Current Leakage
System	100/120/240 Vac	50/60 Hz	750 VA	6.3A, 250V, Bussman GDA	<500 uA

Diathermy Specifications**Table 12.4 – Diathermy Specifications**

Diathermy Specifications		
	Power Adjustment	5 to 100%, in 5% increments
	Diathermy Power (maximum power into rated load)	8.5 Watts into 350 ohms 386 KHz
	Diathermy Type	Bipolar

Irrigation and Aspiration Specifications**Table 12.5 – Irrigation and Aspiration Specifications**

IA Specifications		
Peristaltic Pump	Vacuum Level	0–650 mmHg in 5 mmHg increments
	Pump Flow	0 to 60 cc/minute
Venturi Pump	Vacuum Level	0-600 mmHg in 5 mmHg increments

Phacoemulsification Specifications **Table 12.6 – Phacoemulsification Specifications**

Phacoemulsification Specifications	Phaco Power	0 to 100%, in 5% increments
Peristaltic Pump	Vacuum Level	0–650 mmHg in 5 mmHg increments
	Pump Flow Rate	0 to 60 cc/minute
Venturi Pump	Vacuum Level	0-600 mmHg in 5 mmHg increments

Vitrectomy Specifications **Table 12.7 – Vitrectomy Specifications**

Vitrectomy Specifications		
Peristaltic Pump	Vacuum Level	0–650 mmHg in 5 mmHg increments
	Pump Flow Rate	10 to 60 cc/minute, in 2 cc increments
Venturi Pump	Vacuum Level	0-600 mmHg in 5 mmHg increments

Diathermy Power Graphs

Table 12.8 – Diathermy Output Power (Typical) 50 Ohm

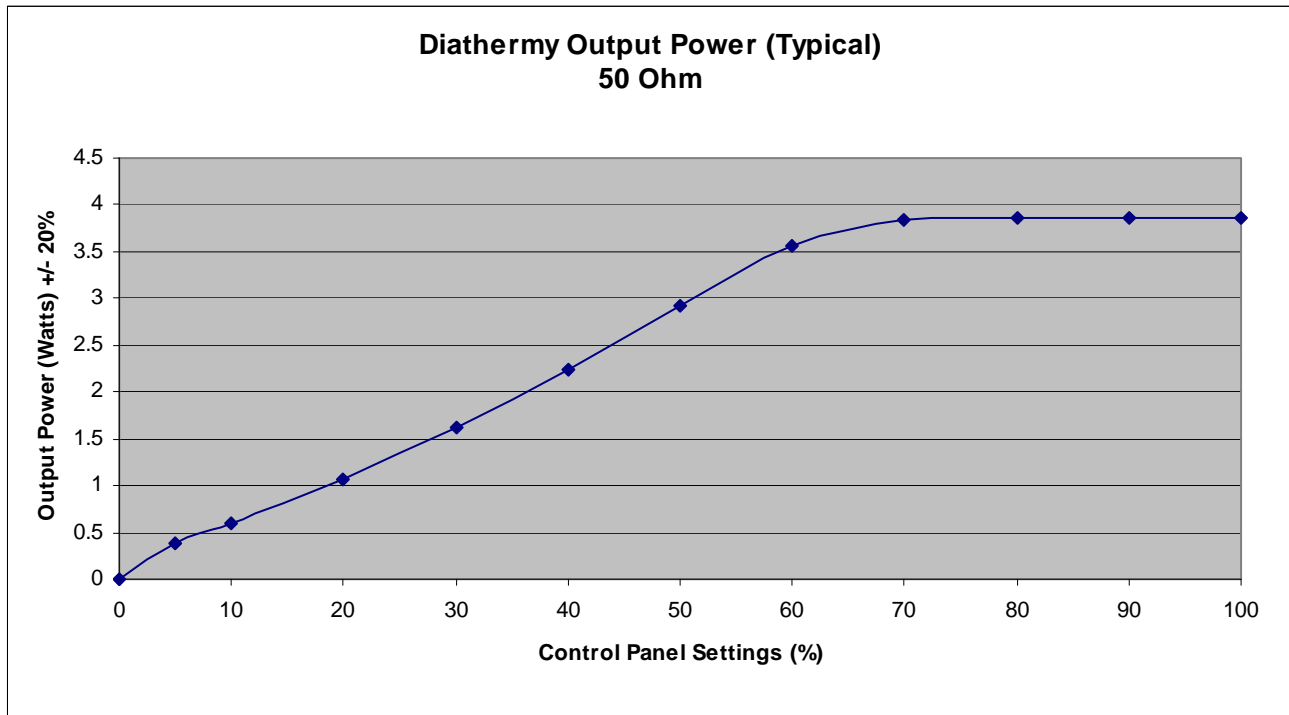


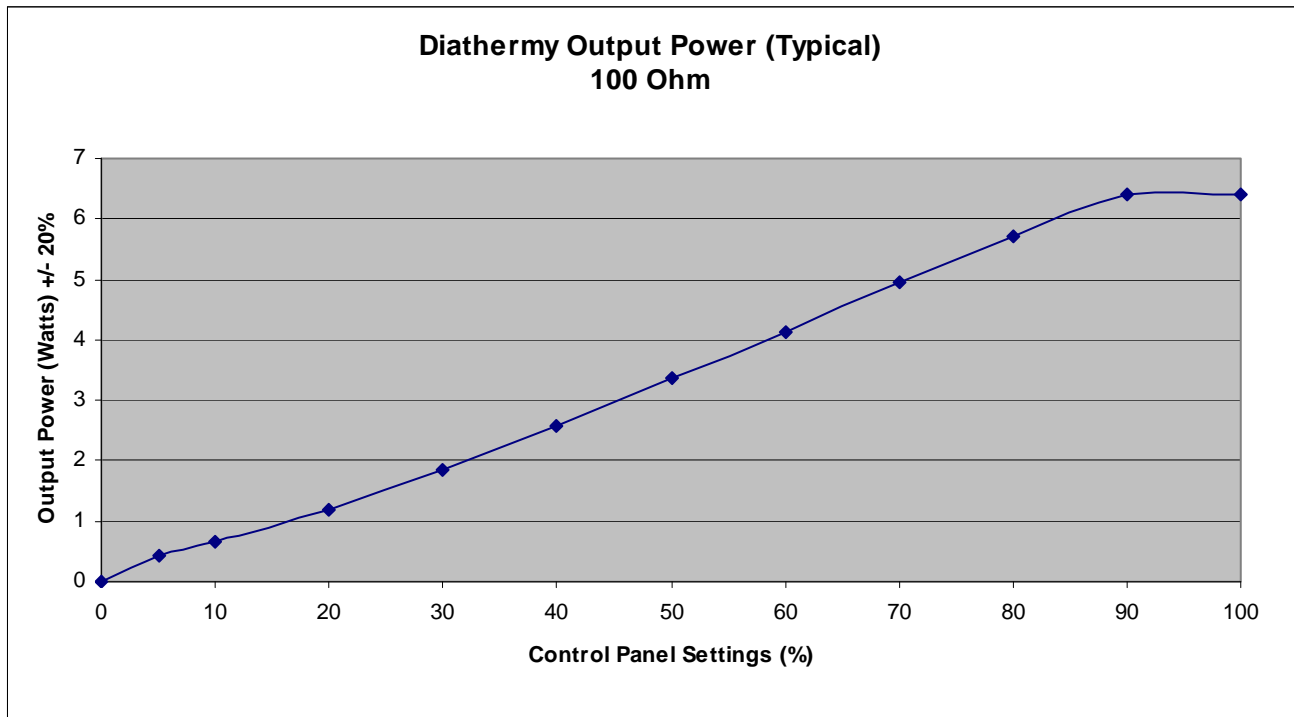
Table 12.9 – Diathermy Output Power (Typical) 100 Ohm

Table 12.10 – Diathermy Output Power (Typical) 200 Ohm

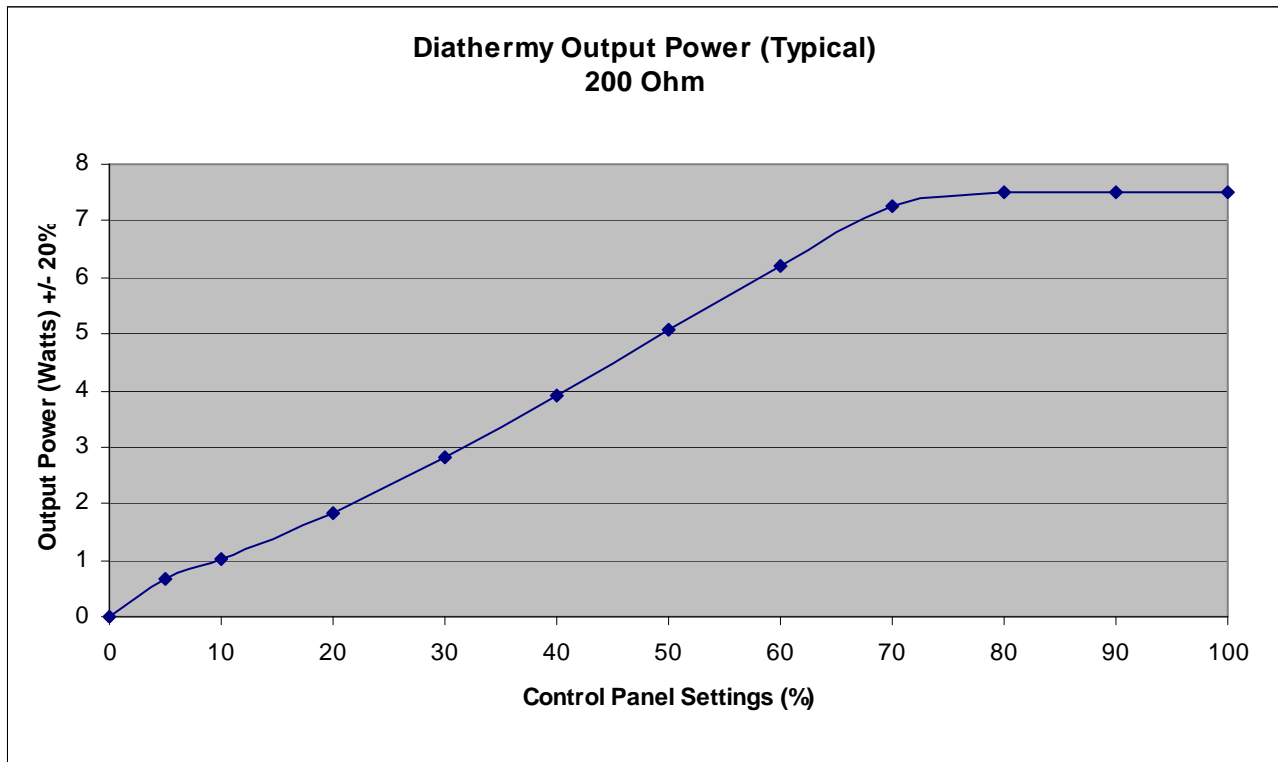


Table 12.11 – Diathermy Output Power (Typical) 500 Ohm

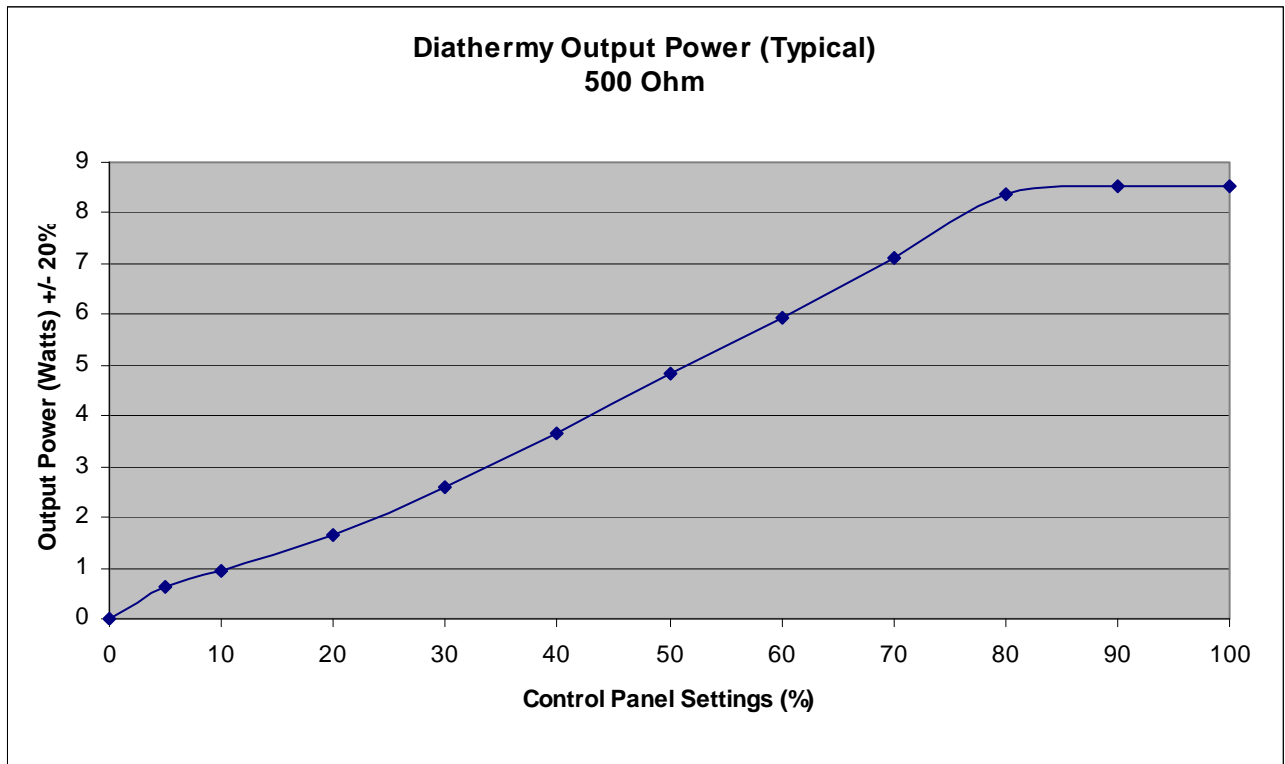
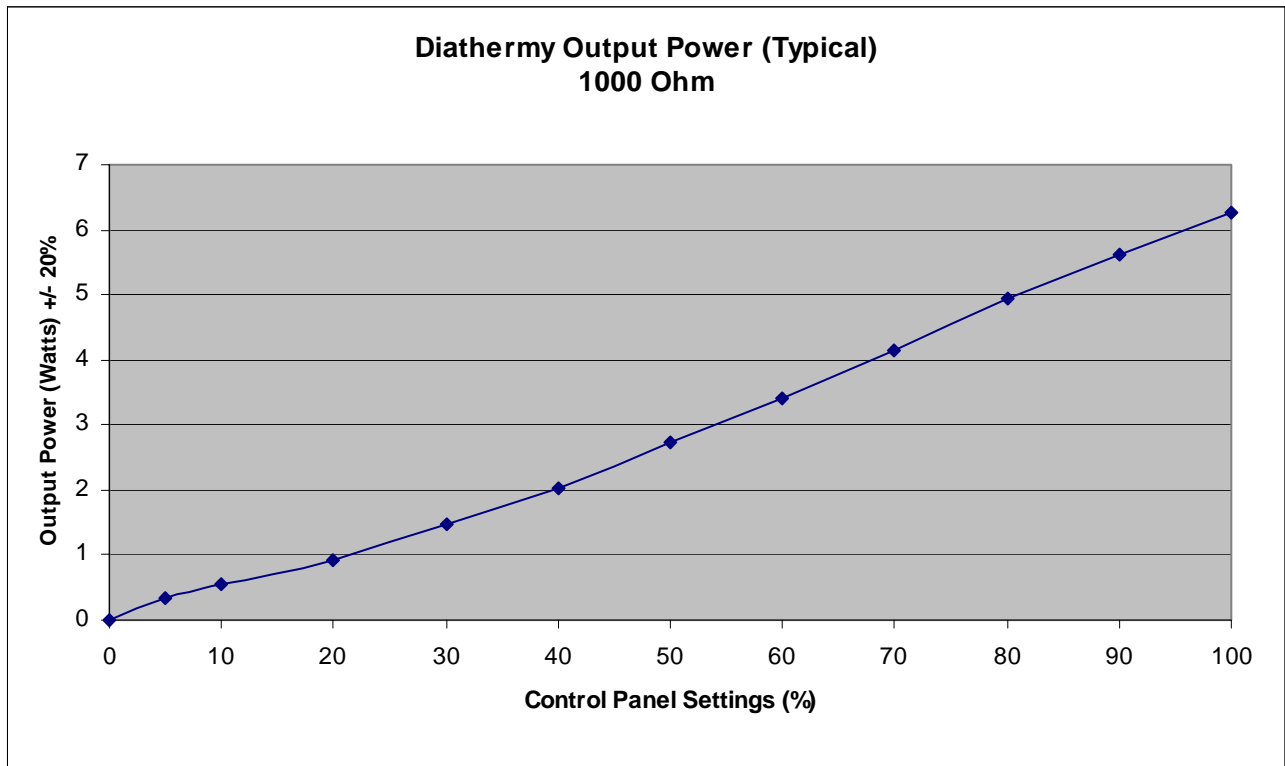


Table 12.12 – Diathermy Output Power (Typical) 1000 Ohm



Diathermy Power versus Load Impedance

Table 12.13 – Diathermy Output Power (50% Setting)

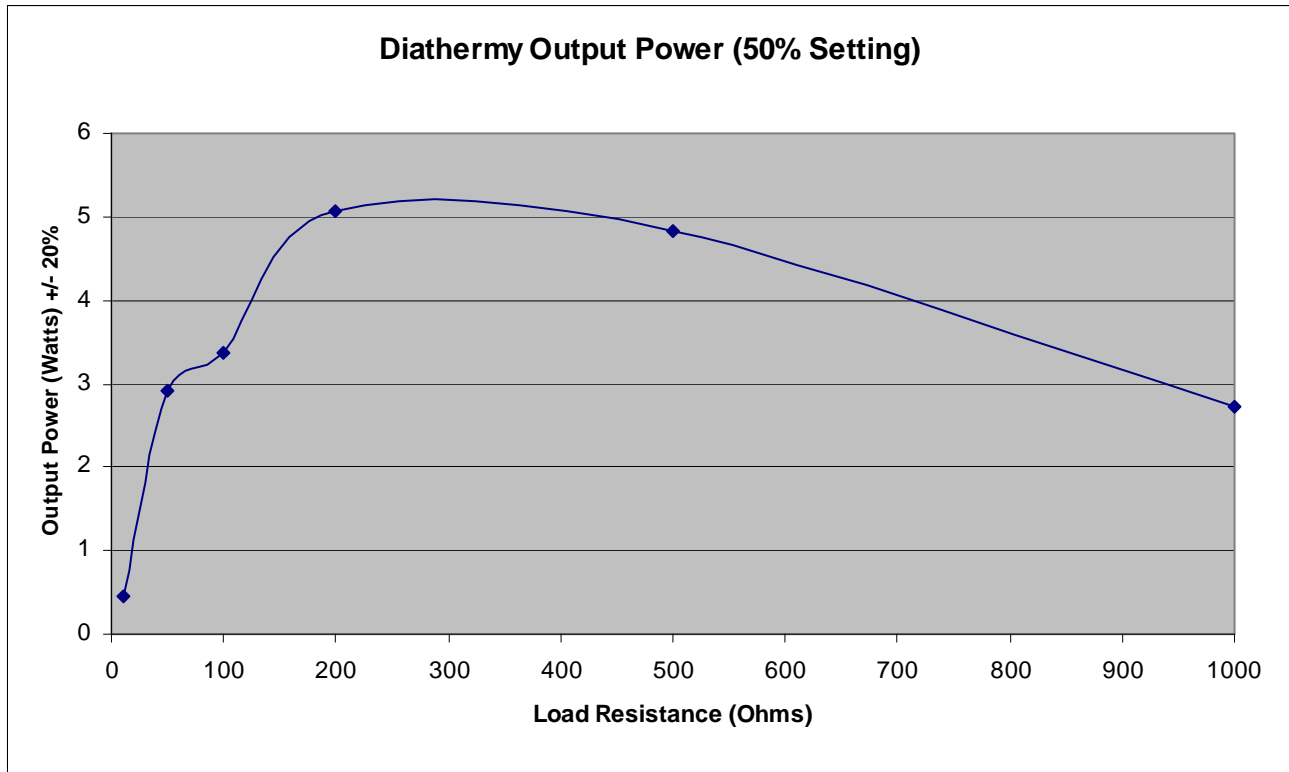


Table 12.14 – Diathermy Output Power (100% Setting)

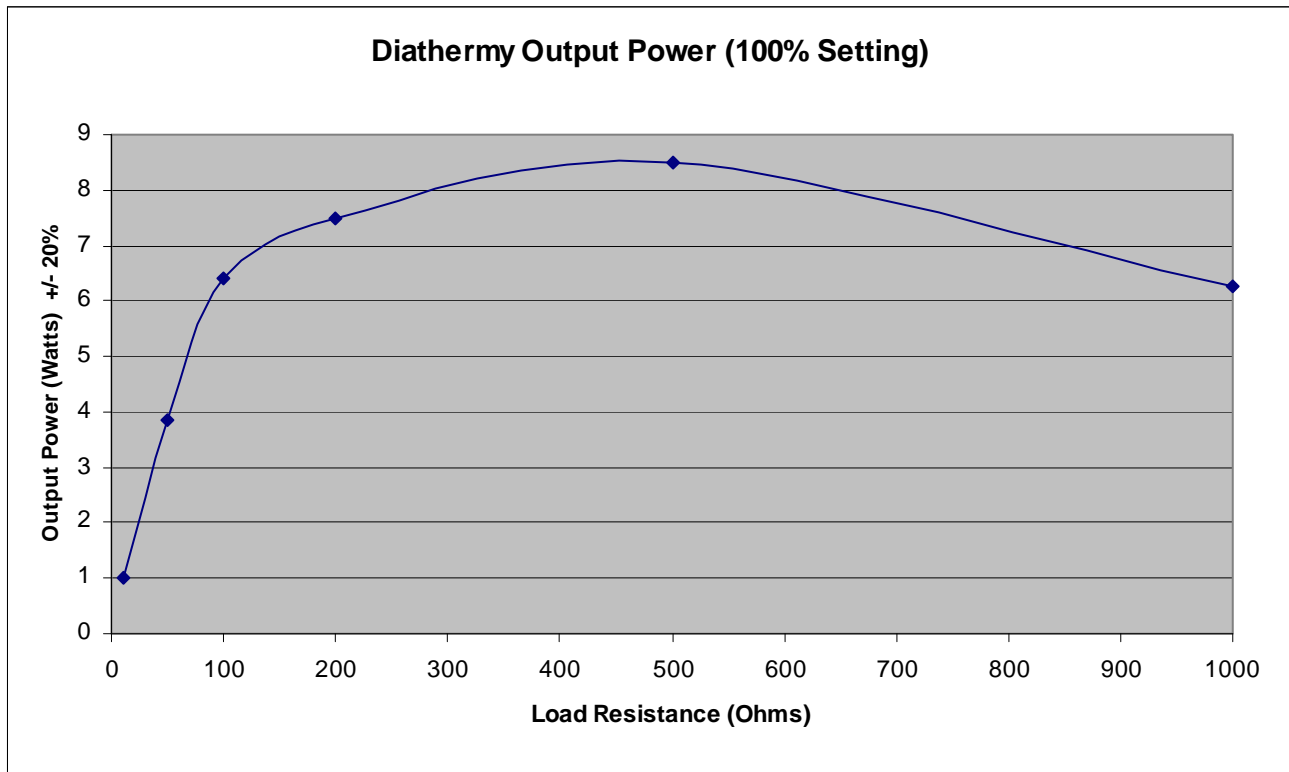
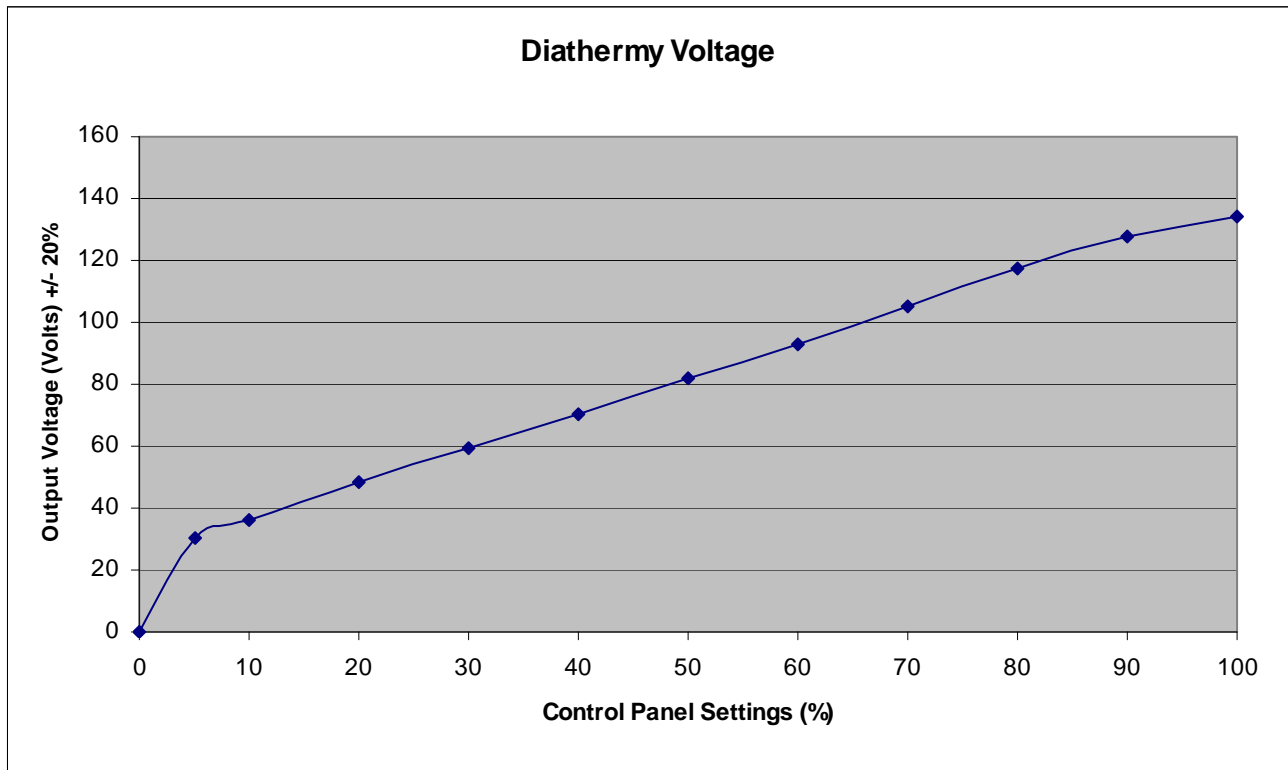


Table 12.15 – Diathermy Voltage



Phaco Power Graphs

Table 12.16 – Longitudinal Phaco Power

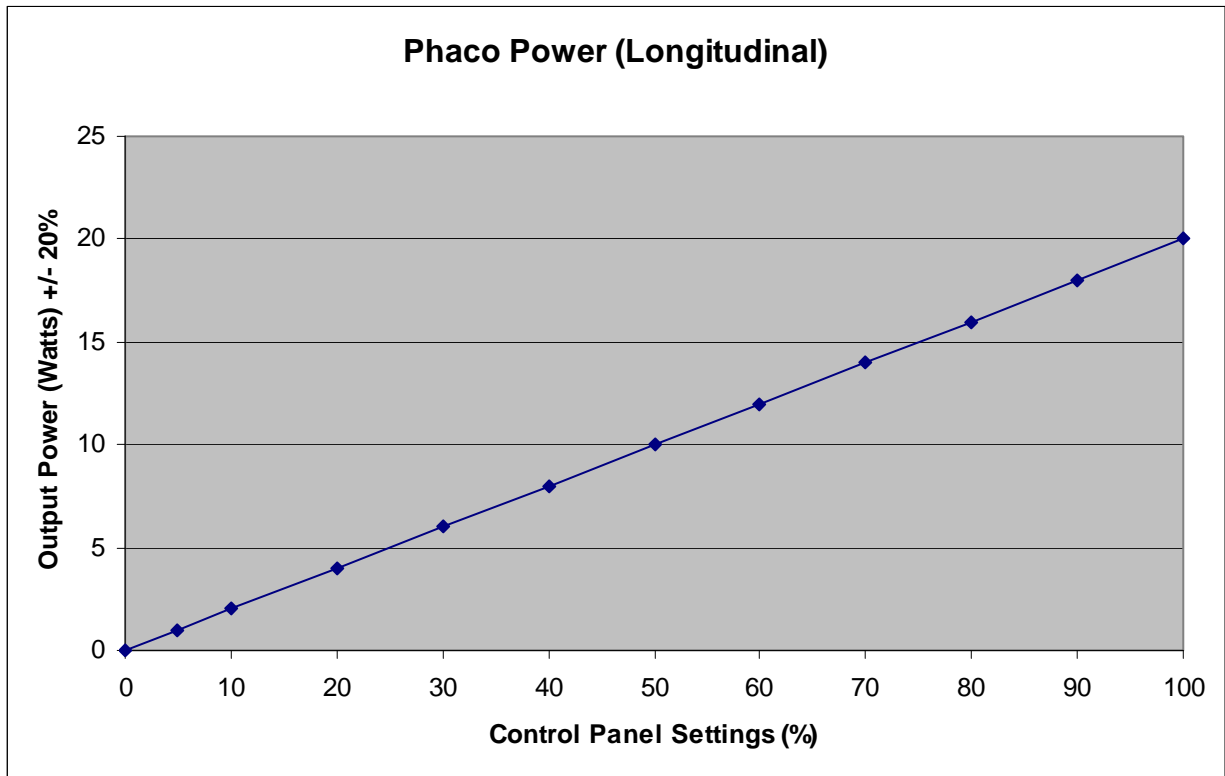


Table 12.17 – Ellips™ Phaco Power

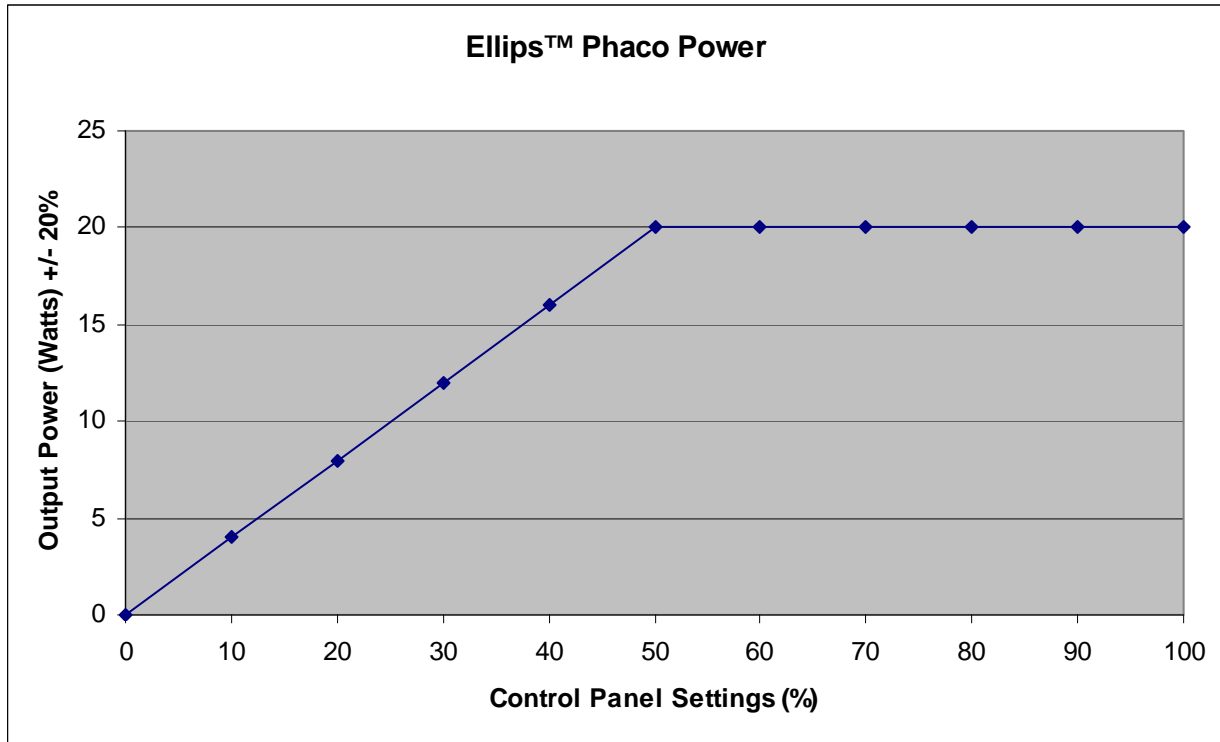


Table 12.18 – Ellips™ Phaco Power and Longitudinal Phaco Power

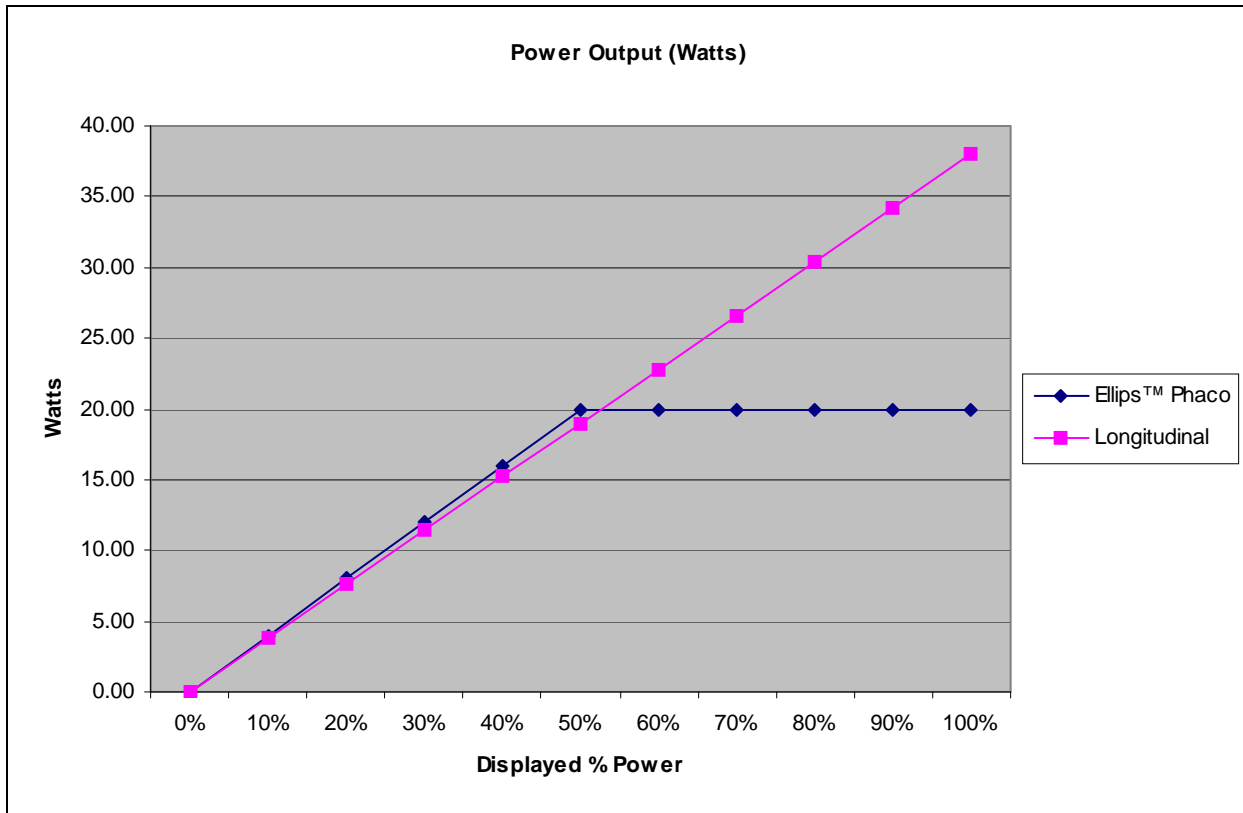
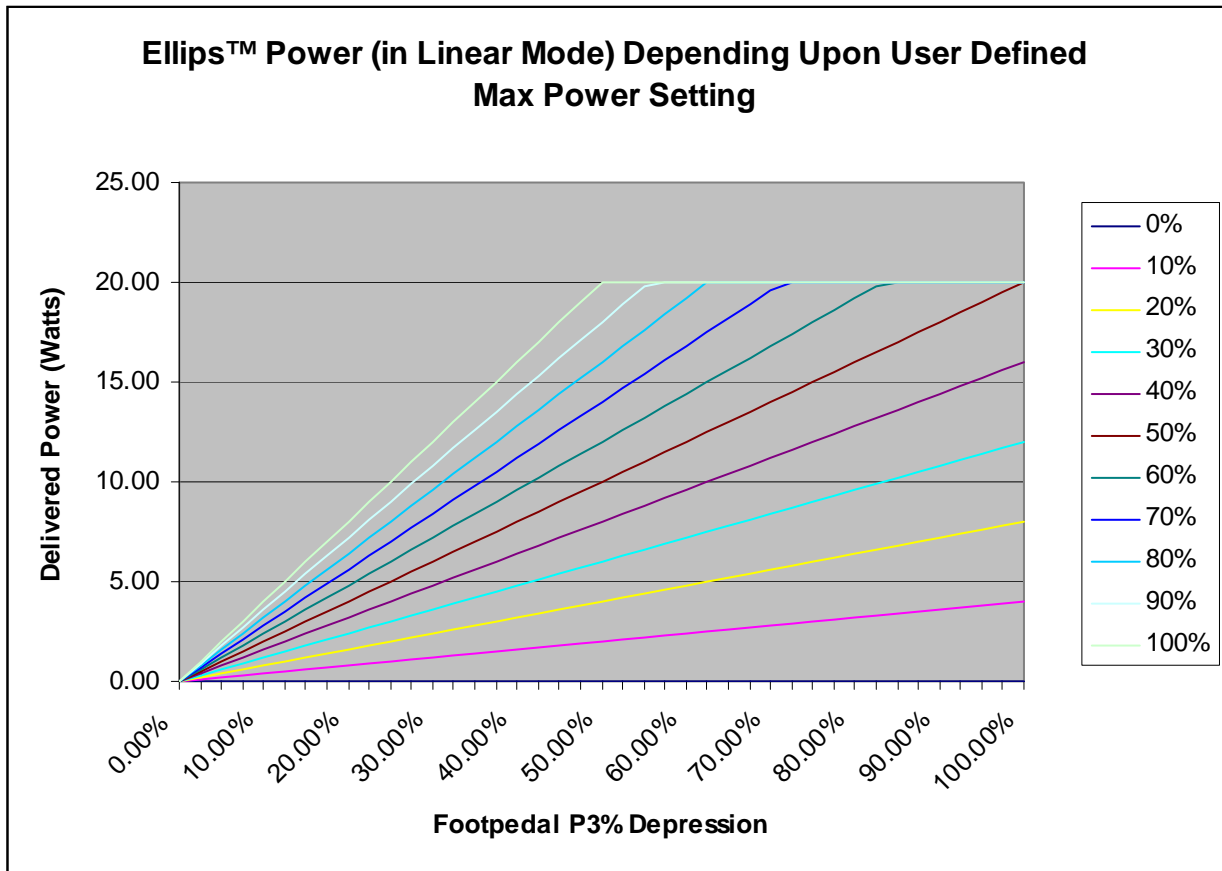


Table 12.19 – Ellips™ Phaco Power Linear Mode



13

ACCESSORIES AND PARTS REORDERING

List of Accessories with Part Numbers

Table 13.1 – WHITESTAR SIGNATURE™ System Part Number

Name	Description	Part No.
WHITESTAR SIGNATURE™ Console	An ophthalmic microsurgical system.	NGP680300

**List of Accessories
with Part Numbers**

The following table is a list of accessories that you can use to reorder parts for your WHITESTAR SIGNATURE™ System. Your AMO representative can advise you of recommended inventory levels based on the volume of phacoemulsification procedures done in your facility. All of the items listed below are ordered through your AMO representative or directly through AMO Customer Service.

Table 13.2 – Accessories and Parts List

System Accessories	Description	Part No.
Phaco Handpiece	AMO® Phaco Handpiece	SOV680290
	WHITESTAR® Phaco Handpiece, Coaxial	690697
	Ellips™ Phaco Handpiece	690858
	19 Gauge LAMINAR™ Flow Phaco Tip, 0° Round Tip	OPOR0019L
	19 Gauge LAMINAR™ Flow Phaco Tip, 15° Round Tip	OPOD1519L
	19 Gauge LAMINAR™ Flow Phaco Tip, 30° Round Tip	OPOD3019L
	19 Gauge LAMINAR™ Flow Phaco Tip, 45° Round Tip	OPOD4519L
	Disposable 20 Gauge LAMINAR™ Flow Phaco Tip, 0° Round Tip	OPOD0020L
	Disposable 20 Gauge LAMINAR™ Flow Phaco Tip, 15° Round Tip	OPOD1520L
	Disposable 20 Gauge LAMINAR™ Flow Phaco Tip, 30° Round Tip	OPOD3020L
	Disposable 20 Gauge LAMINAR™ Flow Phaco Tip, 45° Round Tip	OPOD4520L
	Disposable LAMINAR™ Flow Phaco Tip, 19 Gauge, 30° Curved	OPOCR3019L
	Disposable LAMINAR™ Flow Phaco Tip, 20 Gauge, 30° Curved	OPOCR3020L
	19 Gauge LAMINAR™ Flow Irrigation Sleeve and Test Chamber	OPOS19L
	Disposable 20 Gauge LAMINAR™ Flow Infusion Sleeve and Test Chamber	OPOD20L

System Accessories	Description	Part No.
	LAMINAR™ Flow Tip Wrench	OPOMTWL
	SOLO™ I/A Handpiece, 20 Ga., Curved Silicone Sleeve Tip	OPOIA20CRV
	SOLO™ I/A Handpiece, 20 Ga., 45° Silicone Sleeve Tip	OPOIA2045D
	SOLO™ I/A Handpiece, 20 Ga., Straight Silicone Sleeve Tip	OPOIA20STR
	SOLO™ I/A Handpiece Kit	OPOIA20KIT
I/A Handpiece	PHACOFIT™ Titanium Handle	OM055002
	PHACOFIT™ I/A Tip Curved .5 mm Port	OM05510110
	PHACOFIT™ O-Ring's I/A Tip (5PK)	OM05510112
	PHACOFIT™ Titanium, Multi-Tip Set	OM05510113
	PHACOFIT™ Cleaning/Flushing Kit	OM05510114
	PHACOFIT™ Tip, Luer Adapter (Aspiration)	OM05510115
	PHACOFIT™ Tip, 45 Degree Silicone (No Sleeve)	OM05510116
	PHACOFIT™ I/A Tip Straight .3MM Port	OM0551011
	PHACOFIT™ I/A Tip Curved .3 mm Port	OM0551012
	PHACOFIT™ I/A Tip 45 Degree 0.3 mm Port	OM0551013
	PHACOFIT™ I/A Tip 90 Degree 0.3 mm Port	OM0551014
	PHACOFIT™ I/A Tip Binkhorst 0.3 mm Port	OM0551015
	PHACOFIT™ I/A Tip Straight SI 0.3 mm Port	OM0551016
	PHACOFIT™ I/A Luer Adapter, F/F	OM0551017
	PHACOFIT™ I/A Tip Curved, SI, .3 mm Port	OM0551018
	PHACOFIT™ I/A Tip Straight .5MM Port	OM0551019
	PHACOFIT™ Athlete I/A Tip Straight Type	OM0551020J
	PHACOFIT™ Athlete I/A Tip 45 Degree Type	OM0551021J
	DUET™ STARTER KIT, 20GA	DUA02020

System Accessories	Description	Part No.
	DUET™ ASPIRATION HANDLE	DU02100
	DUET™ IRRIGATION HANDLE	DU02200
	DUET™ 20G CURVED IRRIGATOR CLOSED END	DU02301
	DUET™ 20G CURVED ASPIRATION .3MM PORT CAP POL	DU02302
	DUET™ 19G FINE IRRIGATING CHOPPER	DU02303
	DUET™ 20G OLSON II IRRIGATING CHOPPER	DU02305
	DUET™ MST Aguirre Duet Tip	DU02325
	DUET™ MST Fine/Nagahara Tip	DU02335
Diathermy Handpiece	Bipolar Cord with Fischer Connection	K106075
	Bipolar Forceps, Curved Iris 0.5 mm Tip	K121085
	18 Gauge Straight Diathermy Pencil, reusable	K147000
Vitreotomy Cutter	20 gauge Vitreous Cutter	NGP0020
	23 gauge Vitreous Cutter	NGP0023
	25 gauge Vitreous Cutter	NGP0025
FUSION™ Tubing Pack	Fusion™ Tubing Pack (disposable, sterile)	OPO70
	Fusion™ Dual Pump Tubing Pack (disposable, sterile)	OPO71
Wireless Remote Control	WHITESTAR SIGNATURE™ System Remote Control	NGP680135
Footpedal	WHITESTAR SIGNATURE™ Foot Pedal (Single Linear)	NGP680701
	Advanced Control Pedal for the WHITESTAR SIGNATURE™ (Dual Linear)	NGP680702
Miscellaneous	Power Cord, Hospital Grade, 20 ft., 6.1 meters	2410-0049-L
	Footpedal Cable to WHITESTAR SIGNATURE™ System	0100-0055
	WHITESTAR SIGNATURE™ Dust Cover	0100-0750
	Sterilization Tray	MSR309
	WHITESTAR SIGNATURE™ System Owner's Manual (English)	NGP Z370147

System Accessories	Description	Part No.
	WHITESTAR SIGNATURE™ System Owner's Manual (Chinese)	NGP Z370161
	WHITESTAR SIGNATURE™ System Owner's Manual (Korean)	NGP Z370163
	WHITESTAR SIGNATURE™ System Owner's Manual (Japanese)	NGP Z370162
	WHITESTAR SIGNATURE™ System Owner's Manual (French)	NGP Z370148
	WHITESTAR SIGNATURE™ System Owner's Manual (German)	NGP Z370150
	WHITESTAR SIGNATURE™ System Owner's Manual (Swedish)	NGP Z370157
	WHITESTAR SIGNATURE™ System Owner's Manual (Finnish)	NGP Z370160
	WHITESTAR SIGNATURE™ System Owner's Manual (Portuguese)	NGP Z370152
	WHITESTAR SIGNATURE™ System Owner's Manual (Italian)	NGP Z370149
	WHITESTAR SIGNATURE™ System Owner's Manual (Spanish)	NGP Z370151
	WHITESTAR SIGNATURE™ System Owner's Manual (Danish)	NGP Z370158
	WHITESTAR SIGNATURE™ System Owner's Manual (Dutch)	NGP Z370153
	WHITESTAR SIGNATURE™ System Owner's Manual (Greek)	NGP Z370156
	WHITESTAR SIGNATURE™ System Owner's Manual (Norwegian)	NGP Z370159
	WHITESTAR SIGNATURE™ System Owner's Manual (Polish)	NGP Z370154
	WHITESTAR SIGNATURE™ System Owner's Manual (Russian)	NGP Z370155
	WHITESTAR SIGNATURE™ System Owner's Manual CD, Multilingual	NGP Z370164

GLOSSARY

Term	Definition
Active Reflux	Reflux that occurs in response to a user request (typically by way of the footpedal).
Active State	The state where the instrument responds to the footpedal in all zones. All the surgical modes are operative.
Active Vacuum Vent	The vacuum is relieved by a controlled reversal of the peristaltic pump or by the vacuum regulator.
Advanced Control Pedal (Dual Linear)	A footpedal for the WHITESTAR SIGNATURE™ Phacoemulsification System that operates in two independent linear movement planes (Pitch and Yaw). The two linear movement planes provide proportional control of user-defined functions.
Anterior Chamber	A fluid filled space inside the eye between the iris and the innermost corneal surface.
Anterior Mode	The Anterior function operating mode of the instrument.
Anterior Segment	The front third of the globe; includes structures located between the front surface of the cornea and the vitreous.
Aspiration	Removal of fluid from the eye using the pumps.
Aspiration Line	Fluids pathway within the handpiece that is utilized to extract fluid and tissue from the eye.
Burst Mode	One of the available options on the WHITESTAR SIGNATURE™ System for phaco power delivery. Characterized by short periods of time where the power is turned on, interspersed with off times.
CASE	Chamber Stabilization Environment is an intelligent vacuum system that monitors occlusions and adjusts the vacuum to prevent or reduce post occlusion surge or chamber collapse.
Cassette	The tubing packs that are installed on the system to connect the tubing on the hand pieces to the vacuum and irrigation sources in the instrument.
Compatible Surgeon Programs	Programs that have the same Pack Type, Pump Type, and Infusion method.
Continuous Phaco Power	One of the available Phaco power delivery modes.

Term	Definition
Controller	A processor or microcontroller that is programmed to fulfill a specific task. It can be anything from a small 8-bit microprocessor to a PC-compatible system. On the WHITESTAR SIGNATURE™ system, the following controllers have been identified: GUI Host Processor, Instrument Host Processor, Fluidics Controller, Phaco-Diathermy (PD) Controller, Pneumatic Controller, Diagnostic Controller, IV Pole Controller, Remote Controller, Touch Screen Controller, Footpedal Controller, Footpedal Wireless Controller, Remote Wireless Controller, and Sound Controller.
Continuous Burst Phaco Power	One of the available Phaco power delivery modes.
Diathermy	Method used to coagulate blood vessels during a cataract procedure and to join together the conjunctiva at the end of a cataract procedure using electrical current.
DLL	Dynamic Link Library. A collection of software routines that can be loaded and accessed at run time.
Ellips™ Technology	A technology that provides both longitudinal and transverse movement within the Ellips™ handpiece.
EMI	Electromagnetic Interference. Emitted by electrical circuits carrying rapidly changing signals, as a by-product of their normal operation, and which causes unwanted signals (interference or noise) to be induced in other circuits.
Evacuation	The removal, by suction, of fluids from the eye cavity through a phacoemulsification ultrasonic handpiece.
Extraction	The process or act of pulling or drawing out fluids from the eye cavity during Phacoemulsification surgery.
Fluidics	The components and aspects of the system involving fluid; specifically, irrigation, aspiration, vacuum, pressure and their performance as interdependent systems.
FPn	Foot Pedal zone position (0, 1, 2, or 3). The zone changes when the footpedal is pressed.
FUSION™	The screen in which the Occlusion mode, CASE mode, and Actual Maximum Vacuum settings can be modified.
FUSION™ Fluidics Pack (OPO70)	The fluidic tubing pack which interfaces only with the peristaltic pump related components.
FUSION™ Dual Pump Pack (OPO71)	The FUSION™ dual pump fluidic tubing pack which interfaces with both the peristaltic and the vacuum-based pump related components.
Gravity Infusion	The bottle height-induced irrigation when the IV pole is positioned at a specific height.
GUI	Graphical User Interface. Used to reference the interface presented to the user on a graphical screen.
High Power Pulse Phaco Power	One of the available Phaco power delivery modes.

Term	Definition
IV Pole	The programmable pole used to position the irrigation solution during the phacoemulsification process.
I/A	A general term for Irrigation/Aspiration, and a specific footpedal configuration.
IAC	A Vitrectomy mode that uses the Irrigation, Aspiration, and Cutting sequences as the footpedal is pressed.
ICA	A Vitrectomy mode that uses the Irrigation, Cutting, and Aspiration sequences as the footpedal is pressed.
Irrigation	Causing fluid to be moved into/toward the eye via the irrigation line.
Irrigation Line	The fluid path within the handpiece that is used to allow the clean balanced salt solution to travel from the bottle into the eye.
LCD	The Liquid Crystal Display on the WHITESTAR SIGNATURE™ System.
Linear Variable	Any switch on the footpedal that is used for Linear control. (Pitch or Yaw.)
Long Pulse Phaco Power	One of the available Phaco power delivery modes.
Low Power Pulse Phaco Power	One of the available Phaco power delivery modes.
Max Vac (Maximum Vacuum)	The value for a vacuum based fluidic is the lesser of 600 mmHg or 85% of the CASE Upper Threshold. The maximum value for a peristaltic pump is 650 mmHg.
Motor Venting	Used with both the FUSION™ Fluidics pack (OPO70) and the Dual Linear (OPO71) pack. Driving the peristaltic pump in the reverse direction to vent.
Multiple Burst Phaco Power	One of the available Phaco power delivery modes.
NiMh	Nickel-Metal Hydride. A type of rechargeable battery.
One-Touch CASE	The ability to alter the CASE settings with a single press of a button. The modes are +2, +1, Standard, -1, -2.
Operating Mode	The current operating mode of the instrument. The modes are Phaco, I/A, Vitrectomy, and Diathermy.
Pairing	The process of matching two BlueTooth® Devices, the console and the remote control or the console and the wireless foot pedal, so that they can communicate with one another.
Pars Plana Incision	A surgical cut into the eyeball that passes through the sclera and the pars plana area of the ciliary body, between the pars plans and the ora serrata. Common site for instruments used for Vitrectomy procedures.
Passive Reflux	A small reflux from the aspiration line that occurs automatically when the system vents. Historically, this has occurred on AMO® systems that utilize valve venting.
Peristaltic	A flow based pump.

Term	Definition
Phacoemulsification / Phaco	The term is abbreviated as Phaco. Phaco is a cataract extraction technique originally developed by Dr. Charles Kelman. To use this technique, a surgeon makes a small incision in the eye and emulsifies the cataract with the help of a vibrating needle inserted through the incision. The emulsified particles of the cataract are gently aspirated through the needle while the surgeon continues to irrigate the eye's chamber to maintain intraocular pressure (IOP).
Pitch	The vertical travel of the footpedal.
Pneumatics	Components and aspects of the system involving high and low pressure and vacuum.
Post Occlusion Surge	A result of rapidly changing pressures within the anterior chamber of the eye. The fluid surge is caused when the Phaco Tip is blocked during a procedure and is suddenly cleared. The surge can cause an imbalance of fluids leaving the eye and potential damage to the eye tissue.
Power Boost Mode	An operating mode in which the yaw movement of the Advanced Control Pedal (Dual Linear Footpedal) is utilized to provide a temporary increase (Boost) in phaco power.
Primary Venting Mechanism	A venting mechanism (valve, motor) selected by the host software as the preferred means of performing venting.
Programming Mode (System Configuration)	When the system is not Primed/and not Tuned Phaco, I/A, and Vitrectomy surgical modes are not available. However, the user can program and update surgical and system settings.
Pump Ramp	A characteristic of the peristaltic pump that determines the point at which the pump speed is decreased in order to maintain a manageable rate of vacuum rise.
Pulse Shape	A feature of WHITESTAR [®] Technology which allows the user to define a "kick" of increased power at the beginning of a WHITESTAR [®] pulse over a range of Phaco power settings.
Reflux	Fluid that is moved into/toward the eye via the aspiration port/line. The reverse flow within the aspiration line that can be used to release or dislodge unwanted material from the handpiece tip or to "tent" the incision site to allow easier tip insertion. Reflux is not intended to clear a clogged handpiece. However, reflux can be used to identify a blockage.
Remote Control	A user interface control for the GUI system through a wireless connection. The Remote Control commands are interpreted to control the GUI software.
Safe State	A state where the Phaco, Vitrectomy, Diathermy, and fluidics functions are disabled, with irrigation on and the fluid vented. The instrument the footpedal is disabled. As a result, all of the surgical modes become inoperable.

Term	Definition
Secondary Venting Mechanism	A venting mechanism (valve, motor or vacuum regulator) automatically used by the system to attempt venting if the primary venting mechanism should fail.
Short Pulse Phaco Power	One of the available Phaco power delivery modes.
Single Burst Phaco Power	One of the available Phaco power delivery modes.
Single Linear Footpedal	A footpedal with only one plane of travel allowing proportional control of system parameters.
SubMode	A submode is a defined set of parameters for the current mode. Most operating modes have multiple submodes. For example, there are three I/A submodes for Anterior surgery, each of which contains a set of potentially different parameters for the I/A mode.
Surgical Media Center (SMC)	An optional accessory product that can be connected to the WHITESTAR SIGNATURE™ system to generate and record video images of the surgery. The video images contain embedded information about the instrument status and settings throughout the surgical procedure.
System	A hardware unit and associated peripherals including software required to perform a specific function.
Tenting the Incision (Wound)	Using reflux while inserting the handpiece into the eye. This technique causes the incision (wound) to open slightly (tent), thus making handpiece insertion easier.
Touch Screen	The display surface of the Liquid Crystal Display (LCD) that responds to touch.
Vacuum Boost Mode	An operating mode in which the yaw movement of the Dual Linear Footpedal is utilized to provide a temporary increase (Boost) in the maximum vacuum.
Vacuum Regulator Venting	Using the vacuum regulator in the WHITESTAR SIGNATURE™ system to vent the vacuum in the OPO71 vacuum tank. Used only with the Venturi pump.
Valve Reflux	The fluid flows back through the pinch valve.
Valve Vent	The vacuum is vented through the aspiration line.
Valve Venting	Used with OPO70 pack only. Manipulation of the fluidic connections to cause fluid from the irrigation bottle to be directed toward the aspiration port in order to vent. Typically this results in passive reflux.
Variable WS	A mode where the user can define the WHITESTAR® Technology delivery based on the footpedal position.
Venting	Relieving vacuum in the aspiration tube. Typically venting is performed when the Footpedal is moved from position 2 into position 1 or 0.
Venturi	A vacuum based pump.

Term	Definition
Vitrectomy	The removal of vitreous with a needle-like cutter that has fluid injection and suction capabilities.
WHITESTAR [®] Technology	A proprietary software technology that is used to deliver finely modulated pulses of energy, interrupted by extremely brief cooling periods.
Yaw	The horizontal movement of the footpedal that works from either the left or the right of the footpedal.
Yaw Threshold	The programmed yaw movement that is allowed before the yaw switch is activated on the footpedal.

INDEX

A

- Accessories 13-1
- Add a Surgeon 6-3
- Adjusting
 - Cut Rates 5-29
 - Flow Rate 5-28
- Advanced Control Pedal
 - Does Not Pair 10-17
 - Dual Linear 1-4, 3-11, 3-22, 7-4, 9-5, 12-2
 - Modes
 - Vitrectomy 5-20
 - Pitch
 - Thresholds 5-31
 - VIT 5-32
 - Settings
 - Dual Linear 5-19
 - Wireless 3-22
- Anterior chamber too deep 10-18
- Anterior Segment
 - Settings 5-37
 - Surgery 3-15
- Anterior Segment Surgery 5-1
- Aspiration
 - Specifications 12-3
 - Troubleshooting 10-19
- Aspiration Flow Rate 5-28
- Aspiration Rate
 - Occlusion 5-45
 - PHACO 5-7
 - Vitrectomy 5-17
- Assign Order 6-14
- Autoclave 9-4

B

- Backlight button 10-16
- Balance
 - Irrigation/Aspiration 4-10
- balanced salt solution 3-19
- batteries
 - footpedal 3-22, 9-5
 - remote control 3-26
- Battery
 - Location
 - Wireless Foot Pedal 10-4
 - Replacement
 - Wireless Foot Pedal 10-3
- Begin Tune 4-9
- blocked
 - aspiration port 5-47
- Bluetooth® 10-16
- Bluetooth® devices 10-17
- Bottle Height
 - IA 5-25
 - PHACO 5-26
 - Vitrectomy 5-27
- Burst 5-3
- Bypass 4-7, 4-11

C

Calibration

- Touch Screen 7-7

- Wireless Foot Pedal 7-5

Care of the System 9-5

CASE 5-7

CASE Lower Threshold

- PHACO 5-26

CASE Mode 5-41

- PHACO 5-26

CASE ONE Touch 1-7, 5-43

CASE Upper Threshold

- PHACO 5-26

CASE Vac

- PHACO 5-26

CASE Vacuum 5-16

Cassette

- Loading 3-18

Chamber partially collapses 10-19

Changing

- Irrigation 3-3

- Mode Parameters 4-12

charging the footpedal 9-5

Check-out 8-2

- Irrigation/Aspiration 8-2

- Phacoemulsification 8-2

- Vitrectomy 8-3

Cleaning

- Handpiece 9-2

- System 9-5

Common Problems 10-5

Complete

- Setup 3-19

Components 2-2

Configuration 4-12

Connecting Handpieces 3-3

Connections

- Rear Panel 3-16

Console Dimensions 12-2

Continuous Burst 5-37

- PHACO Power 5-40

Continuous Irrigation 1-5, 4-7, 5-6

- Cup Fill 4-9

- IA 5-25

- PHACO 5-26

Continuous Phaco Power 5-38

Continuous Power 5-37

Controls

- Screens 4-2

Copy a Program 6-10

Cup Fill 4-7, 4-9

Custom Duty Cycles 5-11

Cut Rate

- Adjusting 5-29

- Vitrectomy 5-17, 5-27

cuts per minute 5-29

Cutter

- Vitrectomy 3-21

Cutting Rates

- Vitrectomy 5-29

D

Database 4-2

- Delete 6-13

- Management 7-2

- Program 6-14

- Restore 6-13

Default Program 4-6, 5-21

Default Settings

- Diathermy 5-24

- Footpedal 5-23

- Irrigation/Aspiration 5-25

- PHACO 5-26

- Sound 5-22

- Vitrectomy 5-27

Delete

- Database 6-13

- Program 6-12, 6-13

- Surgeon 6-11

DIA time 5-3

Diagnostics 4-2, 7-2, 10-1

Diathermy 1-6, 3-4, 5-2
 Default Settings 5-24
 Forceps 3-21
 Handpiece 9-3
 Part Numbers 13-4
 Output Power 12-10
 Pencil Probe 3-21
 Power 12-10
 Power Graphs 12-5
 Specifications 12-3
 Troubleshooting 10-20
 Using 5-3
 Voltage 12-12
 Dimensions 12-2
 drainage bag 3-18
 DT 5-3
 Dual Linear
 Advanced Control Pedal 1-4, 3-11, 3-22,
 5-31, 7-4, 9-5, 12-2
 Settings 5-19
 Settings
 Advanced Control Pedal 5-19
 VIT Footpedal Settings 5-32
 Dual Linear Foot Pedal does not pair 10-17
 Dual Pump 1-5
 Duty Cycles 5-9
 PHACO 5-27

E

Edit
 Program 6-9
 Surgeon 6-5
 Effective Phaco Time 5-35
 Electrical
 Specifications 12-3
 Ellips™ 1-4
 Handpiece 1-4, 3-17
 Technology 5-48
 End Case 4-2, 5-34
 Environmental
 Specifications 12-3
 EPT 5-35
 Equipment Operation 4-1
 Error Message 10-2

Error Messages 10-5

F

failed to pair 10-16
 Feedback
 Footpedal 5-24
 Flash Sterilization 9-4
 Flow Rate
 Adjusting 5-28
 Fluidics 1-4
 Error Messages 10-5
 Mode
 PHACO 5-26
 Foot Pedal
 Battery Replacement 10-3
 Calibration 7-5
 Pitch
 Advanced Control Pedal 5-31
 Pitch Thresholds
 single linear 5-30
 Settings
 single linear 5-19
 Single Linear 1-4
 wireless 3-4
 Footpedal 1-4, 3-22, 4-2
 Advanced Control Pedal 3-11
 charging 9-5
 Dual Linear
 Advanced Control 3-11
 Feedback 5-24
 Modes
 Vitreotomy 5-20
 Part Number 13-4
 Pitch 3-23
 Pitch Regions 5-24
 Positions 3-23, 5-11
 Settings 5-23, 5-30
 Setup
 Wireless 7-3
 Single Linear 3-22
 Specifications 12-2

- Summary
 - single linear 5-23
- Switch Assignment 5-32
- Threshold 5-24
- Vitrectomy 5-17, 5-27
- Wireless 1-4, 3-22
- Forceps 11-2
 - Diathermy 3-21
- Fuse
 - Location 10-3
 - Replacement 10-2
- Fusion 5-15, 5-44
- FUSION™ 2-4
- FUSION™ Tubing Pack
 - Part Number 13-4

G

- Gas Sterilization 5-28, 9-4
- General
 - Troubleshooting 10-15
- Graph
 - Phaco Power 12-13
- Graphic User Interface 1-5
- Graphs
 - Diathermy Power 12-5
- Gravity Displacement Sterilization 9-4
- GUI 1-5

H

- Handpiece
 - Cleaning 9-2, 9-3
 - Connecting 3-3
 - IA 3-18
 - Phaco 3-20
 - Priming 4-8
 - Ultrasonic 3-3
 - Warranty 11-2
- Help 10-2
- High Power
 - Limit 5-14
 - Pulse 5-37
 - PHACO Power 5-39

I

- IA
 - Handpiece 3-18
 - Submodes 5-5
- IAC 5-20
- ICA 5-20
- ICE Pulse Shaping
 - WHITESTAR® 5-14
- Infusion Sleeve 2-4
- Initial Mode 5-8, 5-24, 5-25, 5-28
- Inspection Instructions 2-2
- Install Tubing Cassette 4-6
- Irrigation
 - Changing 3-3
 - Continuous 4-7, 5-6
 - flow does not stop 10-18
 - Inadequate 3-3
 - Specifications 12-3
 - Troubleshooting 10-18
- Irrigation/Aspiration 1-7, 5-4
 - Balance 4-10
 - Check-out 8-2
 - Default Settings 5-25
- IV Pole
 - does not work 10-17
 - Programmable 3-4, 3-25, 5-4

K

- kick 5-14

L

- LAMINAR™ Flow 3-18
- Linear 5-2, 5-3, 5-28
 - Occluded Power 5-47
- List of Accessories 13-1
- Load
 - Impedance 12-10
 - Resistance 12-10
- Locked Program 6-13
- Logs 7-2

Long Pulse
 PHACO Power 5-38
 Power 5-37
 Rate
 PHACO 5-26
 Low batteries 10-16, 10-17
 Low Power
 Limit 5-14
 Pulse 5-37
 PHACO Power 5-39
 Lower Threshold 5-16

M

Maintenance 4-2, 11-2
 Touch Screen 7-7
 Max Aspiration
 IA 5-25
 Rate
 Occluded
 PHACO 5-27
 PHACO 5-26
 Vitrectomy 5-27
 Max Phaco Power
 Occluded
 PHACO 5-27
 Unoccluded
 PHACO 5-27
 Max Power
 Diathermy 5-24
 Max Vacuum 5-9
 IA 5-25
 PHACO 5-26
 Vitrectomy 5-27
 maximum vacuum 5-15
 Mayo Stand Drape 2-4
 Messages
 Error 10-2
 Miscellaneous Part Numbers 13-4
 Mode Programming 1-6
 Modes
 Changing Parameters 4-12
 How to program 5-21
 Monitor Drape 2-4

Multiple Burst
 PHACO Power 5-39
 Power 5-37
 Multiple Mode Programming 1-6

N

NiMH 3-22, 10-3
 No aspiration 10-19
 No diathermy or poor diathermy 10-20
 No irrigation flow 10-18
 No phacoemulsification 10-20
 No sound when using diathermy 10-20
 No vacuum 10-19
 No vitrectomy cutting 10-21

O

Occluded Aspiration Rate 5-44
 Occluded Phaco 5-7
 Occlusion
 Aspiration Rate 5-45
 Threshold 5-9
 PHACO 5-26
 Vacuum Threshold 5-45
 Venting 5-47
 OCCLUSION MODE™ Phaco
 Settings 5-26, 5-41, 5-44
 Off Time 5-27
 On Time 5-27
 ONE Touch
 CASE 5-43
 Operating Modes 1-6
 Anterior Segment 5-1
 Operating the Equipment 4-1
 Output Power
 Diathermy 12-10
 Override Settings 5-40

P

pair

- Advanced Control Pedal 10-17
- Dual Linear Foot Pedal 10-17
- Wireless Remote Control 10-16

Pairing Instruction

- Wireless Remote Control 7-6

Pairing Instructions

- Wireless Foot Pedal 7-4

Panel 5-2, 5-3, 5-28

- Occluded Power 5-47

Parameter Settings

- WHITESTAR® Technology 5-10

Parameters

- Programming 1-6

Part Numbers 13-2

Parts

- Reordering 13-1

Passive Reflux 5-48

Pencil Probe

- Diathermy 3-21

Percent Kick

- High End of Range 5-14
- Low End of Range 5-14

Peristaltic Pump 12-3

PHACO

- Default Settings 5-26
- Program 5-8
- Submodes 5-7
- Using 5-8

Phaco Handpiece 1-4, 3-4, 3-17, 3-20, 9-2

- Part Numbers 13-2

PHACO Power 5-37

Phaco Power 5-7

- Continuous 5-38
- Graph 12-13

Phacoemulsification 1-2, 1-7, 3-3, 3-16, 5-6, 5-7, 8-3, 10-20, 12-4

- Check-out 8-2
- Specifications 12-4
- Troubleshooting 10-20

Physical Specifications 12-2

PITCH 3-23

Pitch Regions

- Footpedal 5-24

Poor aspiration 10-19

Poor phacoemulsification 10-20

Positions

- Footpedal 3-23

Power

- Continuous 5-37
- Continuous Burst 5-37
- Delivery
 - Diathermy 5-24
 - PHACO 5-26, 5-27

Failure 3-3

High Pulse 5-37

Long Pulse 5-37

Low Pulse 5-37

Multiple Burst 5-37

PHACO 5-7

Phaco 5-37

Short Pulse 5-37

Single Burst 5-37

Switch 10-5

Power Cord Length 12-2

pps 5-38

Precautions 8-2

- Safety 3-2

Preferred Program 6-6

Prevacuum Sterilization 9-4

Prime

- Bypass 4-7

Prime/Tune 1-5, 4-2, 4-7, 4-8, 4-9, 5-3, 8-2

Priming

- Handpiece 4-8
- Vitreotomy 4-11

Problems

- Common 10-5

Program 4-2
 Assign Order 6-14
 Configuration 5-21
 Database 6-14
 Defaults 5-21
 Delete 6-12
 Edit 6-9
 Lock 6-13
 Locked 6-13
 Preferred 6-6
 Programmable IV Pole 1-6, 3-4, 3-19, 3-25, 5-4
 Specifications 12-2
 Programming
 Multiple Mode 1-6
 PHACO 5-8
 Programs
 Select 4-4
 Surgeon 6-1
 Pulse Off Time 5-10
 Pulse On time 5-10
 Pulse Rate 5-10
 Pulse Shaping 5-12
 pulses per second 5-38
 Pump not working 10-19
 Pump Ramp
 PHACO 5-26
 Threshold
 IA 5-25

R

Rear Panel 3-16
 Recording Mode 3-28
 Reduced/insufficient irrigation flow 10-18
 Reflux 3-24
 Passive 5-48
 Remote Control 3-4
 Wireless 3-26, 7-6
 Remote Pair 7-6
 Reordering
 Parts 13-1
 Replacing
 Batteries 10-2, 10-3
 Replacing the Fuse 10-2

Reset
 Timers 4-10
 Restore
 Database 6-13
 Restriction of Hazardous Substances 3-14
 RoHS 3-14

S

Safety Precautions 3-2
 Screens
 Controls 4-2
 Select Program 4-6
 Selecting a Language 4-3
 Self Test 4-4
 Settings
 Anterior Segment 5-37
 Footpedal 5-30
 How to program 5-21
 Occlusion Mode 5-44, 5-47
 OCCLUSION MODE™ Phaco 5-41
 Override 5-40
 Submode Parameters 5-4
 Setup
 Completion 3-19
 Sequence 3-15
 System 8-2
 Wireless 7-6
 Short Pulse
 PHACO Power 5-38
 Power 5-37
 Rate
 PHACO 5-26
 Shutdown
 Sequence 3-29
 Side VIT 5-20
 Side vitrectomy 5-20
 Single Burst
 PHACO Power 5-39
 Power 5-37
 Single Linear
 Foot Pedal 1-4, 12-2
 Settings 5-19
 Pitch Thresholds 5-30

- Sleep Mode 10-16
 - SMC
 - Surgical Media Center 3-27
 - SOLO™ 3-18
 - Sounds 4-2
 - Default Settings 5-22
 - Specifications
 - Diathermy 12-3
 - Electrical 12-3
 - Environmental 12-3
 - Footpedal 12-2
 - Fuse 10-2
 - IA 12-3
 - IV Pole 12-2
 - Phacoemulsification 12-4
 - Physical 12-2
 - Vitrectomy 12-4
 - Start Vit Prime 8-3
 - Startup 4-4
 - Status 10-5
 - STD Surgeon 6-2
 - Sterilization 3-22, 9-4
 - Gas 9-4
 - Gravity Displacement 9-4
 - Prevacuum 9-4
 - Storage Conditions 12-3
 - Submode
 - Parameters 5-4
 - PHACO 5-7, 5-40
 - Submodes
 - IA 5-5
 - PHACO 5-7
 - Surgeon
 - Add 6-3
 - Copy 6-10
 - Delete 6-11
 - Edit 6-5
 - Select 6-1
 - STD 6-2
 - Surgeon/Program
 - Select 4-4
 - Surgeons and Programs 4-13
 - Surgical Media Center
 - SMC 3-27
 - Switch Assignment 5-30
 - Footpedal 5-32
 - Symbol Definitions 3-9
 - System
 - Check-out 8-2
 - Cleaning 9-5
 - Console 1-5
 - Default Settings 5-22
 - Description 1-2
 - Disposal 3-12
 - does not turn on 10-15
 - Self Test 4-4
 - Shutdown 3-29
 - Tests 7-2
 - Utilities 7-2
- ## T
- Technical Service 10-5
 - Technology
 - WHITESTAR® 5-9
 - Test Chamber 2-4, 13-2
 - Threshold
 - Vacuum 5-45
 - Timers
 - Reset 4-10
 - Touch Screen
 - Calibration 7-7
 - Does not respond 10-17
 - Using 4-12
 - Translucency 3-28
 - Troubleshooting 8-2, 10-1
 - Aspiration 10-19
 - Diathermy 10-20
 - General 10-15
 - Irrigation 10-18
 - Phacoemulsification 10-20
 - Vitrectomy 10-21
 - Tubing Cassette 2-4
 - Install 3-18, 4-6
 - Tune 4-7
 - Begin 4-9

U

- Ultrasonic (U/S) Time 5-35
- Ultrasonic Handpiece 3-3
- Unoccluded Phaco 5-7
- Unpair 10-16
- Up Time
 - PHACO 5-26
 - Threshold 5-16
- Upper Threshold 5-16
- Using
 - Diathermy 5-3
 - PHACO 5-8
 - too much fluid 10-18
 - Touch Screen 4-12
 - Vitrectomy 5-18

V

- Vacuum 5-34
 - monitoring 5-15
 - PHACO 5-7
 - pressure 5-47
 - Rate
 - Linear 5-28
 - Panel 5-28
 - Vitrectomy 5-17
- Variable WHITESTAR® Technology 5-11
- Variable WS 5-11
- Venting
 - Occlusion 5-47
- Venturi pump 5-16
- VIT Foot Pedal Settings
 - dual linear 5-32

- Vitrectomy 3-4, 3-21, 5-17
 - Advanced Control Pedal (Dual Linear) Modes 5-20
 - Check-out 8-3
 - Cut Rate 5-29
 - Cutter 3-4
 - Default Settings 5-27
 - Footpedal Modes 5-20
 - Prime 4-11
 - Specifications 12-4
 - Troubleshooting 10-21
 - Using 5-18
 - VIT 1-7
- Voltage
 - Diathermy 12-12

W

- Wake-up 3-24
- Warnings 3-2, 3-5
- Warranty 11-1
- Watts 12-5, 12-14
- WHITESTAR
 - Decrement 5-32
 - Increment 5-32
- WHITESTAR® ICE Technology 1-3
- WHITESTAR® Technology 1-3, 5-9
- Wireless Advanced Control Pedal 3-22
- Wireless Foot Pedal 3-4
 - Battery Location 10-4
 - Calibration 7-5
- Wireless Footpedal
 - Pairing 7-4
 - Setup 7-3
- Wireless Remote Control 1-5, 3-4, 3-26
 - Part Number 13-4
 - Setup 7-6
- wireless remote control does not pair 10-16

Y

- Yaw 3-23