



ULTRA-RUGGED
FIELD PC
OWNER'S MANUAL

ActiveSync, Excel, Hotmail, Internet Explorer, Microsoft, MSN, Outlook, PowerPoint, Visual Studio, Windows, Windows Media, Windows Mobile, Windows Mobile Device Center, Windows Vista, and the Windows logo are trademarks or registered trademarks of Microsoft Corporation in the United States and/or other countries.

The *Bluetooth*[®] word mark is owned by the Bluetooth SIG, Inc. and any use of such marks by Juniper Systems, Inc. is under license.

Acrobat and Reader are registered trademarks of Adobe Systems Incorporated in the United States and/or other countries.

The names of actual companies and products mentioned herein may be the trademarks of their respective owners.

© Copyright 10-2010 Juniper Systems, Inc. All rights reserved.

P/N 20020-03-M0



WARNING! Text set off in this manner indicates that failure to follow directions could result in serious injury.



CAUTION: Text set off in this manner indicates that failure to follow directions could result in damage to equipment or loss of information.

Contents

1 Getting Started

| | |
|----------------------------------|---|
| The Anatomy of the Field PC..... | 6 |
| Getting Started..... | 7 |

2 Battery and Power

| | |
|--------------------------------|----|
| Battery Settings Screen..... | 12 |
| Charging the Battery Pack..... | 14 |
| USB/Power Dock..... | 16 |
| Using Vehicle Power..... | 18 |

3 Communicating with a Desktop Computer

| | |
|--|----|
| Communicating with a Desktop Computer..... | 20 |
|--|----|

4 Using the Hardware

| | |
|--|----|
| Using the Hardware..... | 24 |
| Powering Off, Suspending, Resetting, and Restoring Factory Defaults..... | 26 |
| Using the Stylus..... | 28 |
| Using the Touchscreen..... | 29 |
| PC Card Installation..... | 30 |
| Micro SD Card Installation..... | 30 |

5 Programs and Settings

| | |
|--------------------------------------|----|
| Understanding the Today Screen..... | 34 |
| Entering Information..... | 35 |
| Recognizing Status Icons..... | 37 |
| Recognizing Soft Keys..... | 38 |
| Adjusting the Display Backlight..... | 38 |

| | |
|--|----|
| Performing Common tasks on the Field PC..... | 40 |
| Using On-Device Help..... | 43 |
| Backing Up Data | 44 |
| Connecting to a Desktop Computer..... | 48 |
| Information for Software Developers..... | 48 |
| 6 Bluetooth® Wireless Communications | |
| Bluetooth® Drivers and Profiles..... | 50 |
| Supported Bluetooth® Profiles..... | 56 |
| 7 Wi-Fi Connections | |
| Wi-Fi Connections..... | 64 |
| 8 Care and Maintenance | |
| Caring for Your Field PC..... | 68 |
| Disposing of the Field PC and Battery Pack..... | 73 |
| 9 Service Information | |
| Repairing the Field PC..... | 76 |
| Preparing for a Service Center Call..... | 76 |
| A Product Specifications and Warnings | |
| Product Specifications..... | 78 |
| 9-pin Serial Port Pinouts..... | 80 |
| Battery Warnings..... | 81 |
| Equipment Warnings..... | 82 |
| B Certifications and Regulatory Information | |
| Regulatory Information..... | 84 |
| Limited Product Warranty | 87 |
| Index | |

1

Getting Started

6 *The Anatomy of the Field PC*

7 *Getting Started*



The Field PC is a rugged handheld computer designed for data collection from multiple environments. Equipped with Windows Mobile 6 it features a wide variety of applications software and accessories.

The Anatomy of the Field PC

The picture below shows some of the important features of the Field PC.

! **CAUTION:** Tampering with the jack screws will break the waterproof seal of the unit.

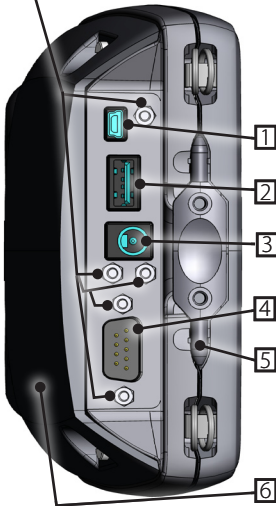

- 1 USB client (mini B)
- 2 USB host (full size A)
- 3 12V DC jack
- 4 9-pin serial port
- 5 Stylus
- 6 Back compartment door

- 7 Top lanyard cleats
- 8 Touchscreen/display
- 9 Battery door latches
- 10 Power button
- 11 Bottom lanyard cleats

Getting Started

Install the Battery Pack

When you receive the Field PC, you must install and charge the NiMH battery pack before using. To do this, complete the following steps:

1. Push up on the sliding latches on the sides of the Field PC to open the battery compartment door.

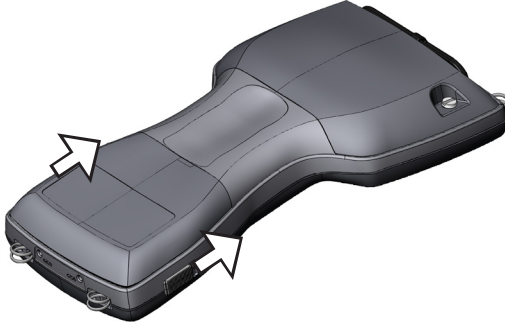

2. Place the NiMH battery pack in the left side of the battery compartment, push down, and slide it all the way to the right. There is a small arrow on the bottom right corner of the battery pack, make sure the arrow is pointing to the right when it is placed in the Field PC.



3. Push the battery door closed until the slide latches click into place. If the latches are not securely in place the unit is no longer water tight.

Note: Do not turn on the Field PC yet.

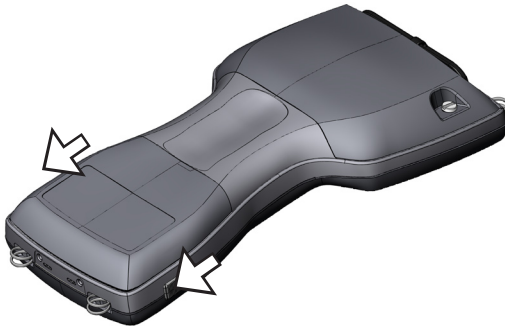

4. Plug the AC wall charger that came with the Field PC into the wall socket.
5. Remove the rubber protector from the Field PC's external power input jack.



6. Plug the wall charger into the Field PC power jack located at the top of the case. The Charge Settings screen opens requesting you set the charge percentage. Select *Enter percentage and capacity*, set the battery charge to 10%, and leave the battery capacity at 4000.

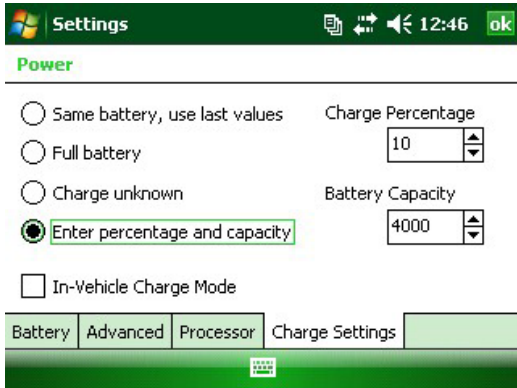

7. Charge the battery pack at room temperature for at least 6 hours.

2

Battery and Power

- 12 *Battery Settings Screen*
- 14 *Charging the Battery Pack*
- 16 *USB/Power Dock*
- 18 *Using Vehicle Power*



This chapter teaches you about the rechargeable NiMH battery pack. It typically lasts 12 to 20 hours, and charges in 4–6 hours using a wall charger, vehicle charger (optional), or USB/PowerDock (optional).

Battery Settings Screen

Understanding the Battery Settings Screen

The battery charge percentage of the Field PC must be confirmed or manually set using the Battery Settings Screen. This screen appears whenever:

- The battery pack is removed and (re)installed.
- The “Power Off” option is selected from the “Power Button” menu (which appears after holding the Power Button for 8 seconds) and then the Field PC is powered back on.
- A Hard Reset is performed (by holding down the Power Button for 10 seconds).
- A Clean Boot (Set to Factory Defaults) is performed.
- The charge of the battery pack is fully drained while in the Field PC, and the unit is then plugged into an AC wall charger or USB/Power Dock and turns on.

Note: To access the Charge Settings screen, you can either tap the battery icon or go to Start > Settings > System tab > Power > Charge Settings tab.

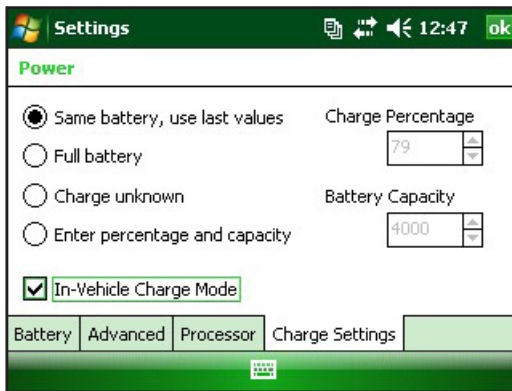

Battery Settings Options

The New Battery Detected screen has four choices:

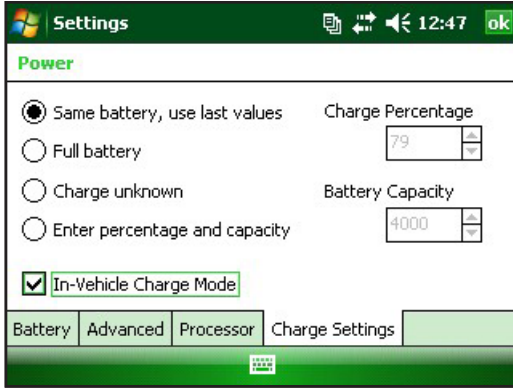

- Same battery, use last values
- Full battery
- Charge unknown
- Enter percentage and capacity

Use **Same Battery** if the Field PC was turned off and back on or if the battery was taken out and re-inserted without being recharged, this option uses the information the unit already has for the battery setting.

Use **Full Battery** if the battery is fully charged.

Use **Charge Unknown** if you do not know the charge of the battery.

Note: The battery gauging will not be accurate with Charge Unknown until the battery is fully charged. The battery icon may not display the percentage of charge correctly.

Use **Enter percentage and capacity** if you know the charge or if it is a new battery pack.

Enter the correct percentage if it is known and click Ok. If it is a new battery pack complete the following steps:

1. Set the Percentage to 10 and leave the Battery Capacity at 4000.

Note: The factory battery is 4000 mAh and so the default for the Capacity box is 4000. To learn more about this setting read the Battery Capacity section.

2. Tap on Ok to save the settings and to close the screen.
3. Plug unit into AC charger to charge the new battery. Once the battery pack is fully charged, the gauging is automatically set to 100%.

Battery Capacity

The capacity is the amount of energy a fully charged battery can supply in milliamp-hours (mAh). The battery capacity of the factory Field PC battery pack is 4000 so the default setting for the battery capacity is 4000.

If you are using a different battery pack, check its mAh rating commonly listed on the battery label. For optimum performance, use battery packs with a 3000 to 4000 mAh capacity. The higher the capacity the longer the charge is held.

Note: As a battery pack ages, operation time is reduced. The capacity setting for an older battery pack can be adjusted downward to reduce charging time and to more accurately represent the battery capacity.

Charging the Battery Pack **Recharging the NiMH Battery Pack**

We recommend charging the Field PC battery pack when it is not in use. The Field PC prevents the battery pack from being overcharged if left plugged into the wall charger.

Temperature Ranges for Charging the NiMH Battery Pack

The Field PC NiMH battery pack is charged most efficiently at temperatures ranging between 10° to 20° C (50° to 68° F) when the AC power adapter is used. The Field PC battery pack does not charge outside of the range 0° to 40° C (32° to 104° F).

Using the Alkaline Battery Holder (optional accessory)

To properly use the alkaline battery holder, complete the following steps:

1. Open the alkaline battery holder by pressing the tabs simultaneously on either side and pulling.



2. Insert three unused AA alkaline batteries by following the + and – signs respectively.



Note: It is important that only alkaline batteries are used. We recommend using non-rechargeable high quality alkaline batteries such as Duracell® Ultra or Energizer® Lithium.

3. Close the alkaline battery holder by sliding the door in place and press down to snap it securely shut.

4. Follow the directions for changing a battery pack to install the alkaline battery holder. However, the charge settings screen will not pop up.



The alkaline battery holder is to be used as an emergency, secondary source of power, not as the primary source. The batteries do not last as long as the standard battery pack and have a lower performance rate. The display heater cannot be enabled and the backlight is disabled when the battery power level is low.

Please recycle used alkaline batteries in a responsible way.

USB/Power Dock

The USB/Power Dock charges the Field PC, and allows you to transfer and synchronize files between the Field PC and a desktop computer. The Power Dock is ordered separately. Listed below are the functions of the three LED indicators on the Power Dock:

| Function | LED Color |
|-------------------|-----------|
| Power Supply | Green |
| Charging | Amber |
| USB Communication | Red |

Power Supply

The Power Dock uses the AC wall adapter that comes with the Field PC. Plug the Field PC power adapter into the dock, in the back on the right, and then into the wall.



When the green LED indicator turns on, the Power Dock has power.

Charging

The Power Dock charges the Field PC. Place the Field PC into the Power Dock and the Field PC automatically turns on and begins charging, the amber LED is on. When the amber LED turns off, the Field PC is finished charging. The charging time is the same whether the Field PC is turned on or off.

Note: Never operate the Field PC in the USB/Power Dock without a battery installed. The dock does not supply adequate power to the Field PC for normal operation. Do not use the Power Dock with alkaline batteries installed.

USB Communication

The Power Dock also provides a USB connection from the Field PC to the desktop computer. The red LED indicator turns on when the USB connection between the Field PC and desktop computer is active.

Using Vehicle Power

Vehicle Mode should be used when the Field PC is connected to a vehicle power supply. By using Vehicle Mode the battery does not charge if the charge level is above 90%. This restriction makes sure the battery is not overcharged.

To turn Vehicle Mode on (default is off), complete the following steps:

1. Tap *Start* > *Settings* > *System* tab > *Power* > *Charge Settings* tab.
2. Select In-Vehicle Charge Mode check box.

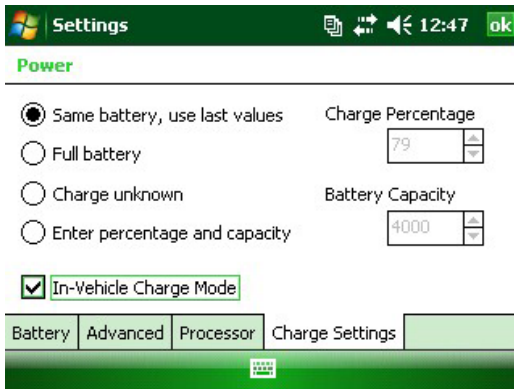

3. Tap *ok*.



WARNING: If Vehicle Mode is not used when charging in a vehicle, the battery may be overcharged resulting in permanent damage to the battery.

3

Communicating with a Desktop Computer

20 *Communicating with a
Desktop Computer*



The Field PC can connect to a desktop computer using either ActiveSync® (for computers with Windows® 2000 and Windows® XP), or Windows Mobile® Device Center (for computers with Windows Vista™).

Communicating with a Desktop Computer

Install ActiveSync® on a Desktop Computer (Windows® 2000 and Windows® XP)

Note: If you have Windows Vista™, see Install Windows Mobile Device® Center.

1. Insert the Getting Started Disc into your desktop computer. A window appears on the display.
2. Select your language.
3. Follow the directions on the screen to install Windows® ActiveSync® 4.5. *Note: Install ActiveSync® before attaching the USB cable to the desktop or Field PC.*

Creating an ActiveSync® Connection

1. Plug USB Client end (mini B) of the USB communications cable into your Field PC.
2. Plug the USB Host end (full size A) of the USB communications cable into your desktop computer.
3. Establish an ActiveSync® partnership by following the instructions on the desktop computer screen.

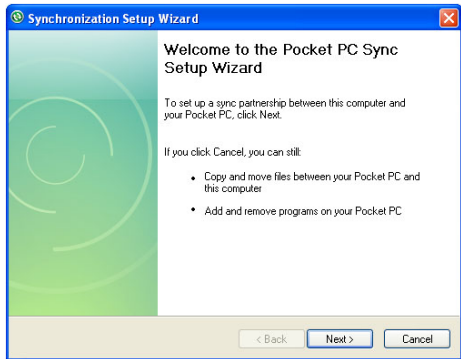

Install Windows Mobile® Device Center on a Desktop Computer (Windows Vista™)

To install the Windows Mobile® Device Center on a desktop computer with Windows Vista™ complete the following steps:

1. Connect your device to your desktop computer.
2. Download the Windows Mobile® Device Center Installer to your computer by clicking on the download link that appears in the pop-up window.
3. Select “Run this program from its current location” and click OK.
4. Follow the instructions on the screen.



Creating Windows Mobile® Device Center Connection

Once Windows Mobile® Device Center has been installed, create a connection at any time by plugging one end of a USB cable into the computer and the other end into the Field PC. Windows Mobile® Device Center automatically opens. Follow the steps on the screen.

Note: For more information about connecting to a computer using either ActiveSync® or Windows Mobile® Device center visit the Microsoft Windows Mobile® website.

4

Using the Hardware

- 24 *Using the Hardware*
- 26 *Powering Off, Suspending, Resetting, and Restoring Factory Defaults*
- 28 *Using the Stylus*
- 29 *Using the Touchscreen*
- 30 *PC Card Installation*
- 30 *Micro SD Card Installation*



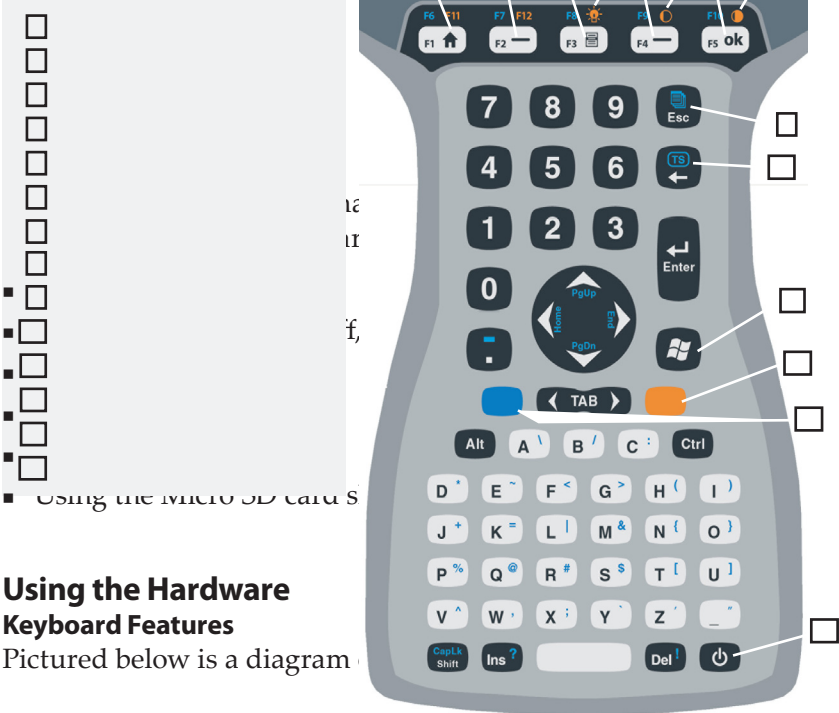

Using the Hardware Keyboard Features

Pictured below is a diagram

Some keys have standard functions as well as special functions accessed with the ORANGE and BLUE shift keys.

Five keys are located below the display. These keys act as standard Windows Mobile keys unless the application program uses them as function keys. With the use of the ORANGE and BLUE shift keys, twelve function keys and three special function keys are available.

Function Keys and Key Sequences

The Windows Mobile functions are the standard key outputs. These include the Home key, the Menu key, and the Tasks Manager key. The standard key outputs are functional unless an ORANGE or BLUE shift key is pressed.

Shift Key Usage

Note: Follow the same steps with the ORANGE shift key to access the orange printed keyboard characters.

To access a single blue printed keyboard characters:

- Press and release the BLUE shift key followed by the key with the desired blue-lettered character.

To activate several blue-lettered keys before returning to

standard mode:

- Press and hold the BLUE shift key down while you press all the desired BLUE keys. Once the BLUE shift key is released, the keyboard reverts back to the standard mode.

Communication Ports

The Field PC has the following communication ports located at the top of the case:

- 9 pin serial port
- USB A (host) port
- USB B mini (client) port

Connector Protectors

The Field PC is sealed without the protectors, however the rubber connector protectors keep dirt and moisture out of the ports.

Powering Off, Suspending, Resetting, and Restoring Factory Defaults

The Power button allows you to suspend, power off, or reset the device. A series of keyboard actions also lets you restore settings, and icons to their original factory defaults. Below are instructions for each action.

Powering Off the Device

When the device is powered off, it closes all programs and powers down all system components except for the real-time clock. Unlike suspend mode, the device resets when it is powered on again. Any unsaved data will be lost.

To preserve battery power, we recommend you power off the device if it will be left unused for two weeks or longer.

To power off the Field PC,

1. Save all open files and close any running programs.

2. Press and hold the Power button until the Power Button menu appears.

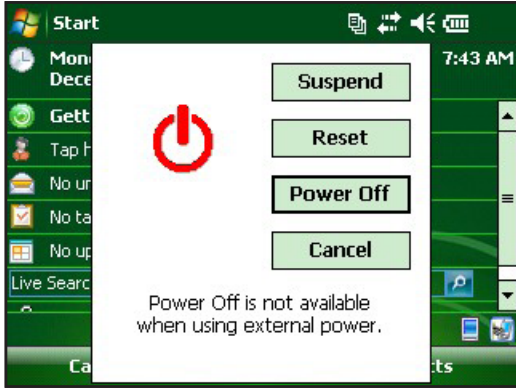

Note: The Field PC cannot be powered off while it is plugged into the wall charger.

3. Tap *Power Off*. A warning dialog appears. Tap *OK*.

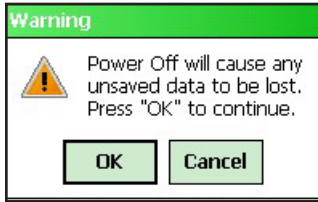

To power on your Field PC, hold down the Power button until you see the screen light up.

Note: The Battery Settings screen will appear when you power on your Field PC.

Suspending the Device

Suspending the Field PC is different from powering it off. When the device is suspended it goes to sleep, and when it is turned back on, the device resumes where it was before it was suspended. Some battery power is used during suspend.

We recommend suspending your device if you plan to turn it off for less than two weeks as long as the Field PC is attached to wall charger every night and weekend.

To suspend your device, press the Power button briefly and release. To resume the device from suspend mode, press the Power button again.

Resetting the Device

Follow the steps below to reset the Field PC:

1. Save your open files and close any running programs.
2. Press and hold the Power button until the Power Button menu appears.
3. Choose *Reset*.

If your device locks up, you can reset the device by pressing the Power button for 10 seconds or until the screen goes dark. After a few seconds, the device turns on again.

Restoring the Device to its Factory State

Follow the steps below to restore user storage, settings, and icons on your Field PC to their original factory defaults.



CAUTION: Restoring the Field PC to its original factory state permanently erases data saved on the Field PC, any software you installed, and any changes you made to the Field PC (including setting changes).

1. Backup data and software you want to reinstall on the Field PC on removable media or a desktop computer.
2. Press and hold the Power button until the Power Button menu appears.
3. Choose *Reset* and quickly press and hold the Ctrl + Alt + Del buttons. A progress bar appears. Hold the buttons down until the second tick on the progress bar is shown.

Data and software stored on removable media (Micro SD or PC card) is not erased during a clean boot. Software may need to be reinstalled on the Field PC after a clean boot.

Using the Stylus

Below are instructions for tasks using the stylus.

| To do this . . . | Follow these steps |
|---------------------------------|--|
| Select an item | Tap once. |
| Open an item or file | Tap the item or file twice. |
| Open a context menu for an item | Tap and hold the item. The context menu appears. |
| Cut or copy | Tap and hold until the context menu appears. Select <i>Cut</i> or <i>Copy</i> . |
| Paste | Tap and hold the area where you want to paste. Select <i>Paste</i> from the context menu that appears. |
| Drag and drop | Tap and drag the item to the destination. Lift up the stylus. |
| Select multiple items | Drag the stylus over the items. |

Using the Touchscreen

This section explains how to protect, calibrate, and disable the touchscreen.

Protecting the Touchscreen

The touchscreen is sealed to protect your device against water and dust. To protect your touchscreen, we recommend that you apply a touchscreen protector.

Calibrating the Touchscreen

If the touchscreen is not responding accurately to stylus taps, try calibrating the touchscreen manually using the following steps:

1. Tap *Start > Settings > System* tab.



2. Scroll down and tap on the Screen icon.
3. When the Screen window appears, tap *Align Screen*.
4. Follow the directions to calibrate the touchscreen.
5. After you calibrate the touchscreen, the Screen window appears again. Tap *OK* to exit the screen.

Disabling the Touchscreen

To disable or enable the touchscreen, press the BLUE shift key then the *TS* key.

PC Card Installation

A PC card can be used to expand the memory and peripheral capabilities of the Field PC. The PC card slot is also capable of taking an SD or CF card with an adapter. To install a card complete the following steps:

1. Use a screwdriver to open the back compartment door.
2. Insert the card socket-first with the front of the card facing up. Gently push it in until it stops.

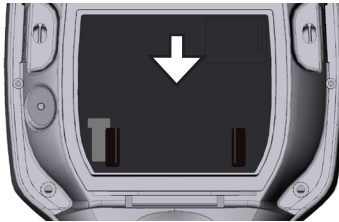

3. Close the door to the card slot and reattach the back compartment door.

Note: Be careful when inserting and removing cards. Excess force could damage the card and the card drive.

To remove a card from the slot push the eject button, grasp the card firmly and pull it out.

Micro Micro SD Card Installation

A Micro SD card holder is located at the back of the unit. Some models may ship with a Micro SD card already installed.

! **CAUTION:** Installing a card improperly can result in damage to the unit not covered by the warranty.

To properly install a Micro SD card complete the following steps:

1. Use a screwdriver to open the back compartment door.
2. Gently lift the flap located in the top right corner of the board protector.
3. Slide the Micro SD card door to the right to open.

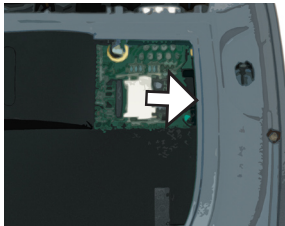

4. Slide the Micro SD card into the door with the connectors facing down and outward.

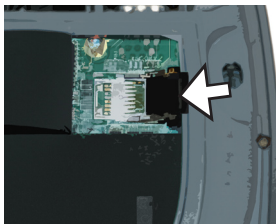

! **CAUTION:** Do not place the Micro SD card directly into the board connector. The card reader and the card may be damaged.

5. Gently shut door and slide it to the left to lock it in place.

6. Close the flap in the board protector and securely reattach the back compartment door.

To remove a Micro SD card, follow these steps in reverse order.

5

Programs and Settings

- 34 *Understanding the Today screen*
- 35 *Entering Information*
- 37 *Recognizing Status Icons*
- 38 *Recognizing Soft Keys*
- 40 *Performing Common Tasks on the Field PC*
- 43 *Using On-Device Help*
- 44 *Backing up Data*
- 48 *Connecting to a Desktop Computer*
- 48 *Information for Software Developers*



The Field PC uses the Windows Mobile® 6 operating system. This chapter explains how to use Windows Mobile® 6.

Understanding the Today Screen

The Today screen is the default screen you see when your device powers on. From the Today screen you can view or select

- Today's date
- Owner information
- Messages
- Tasks
- Upcoming appointments

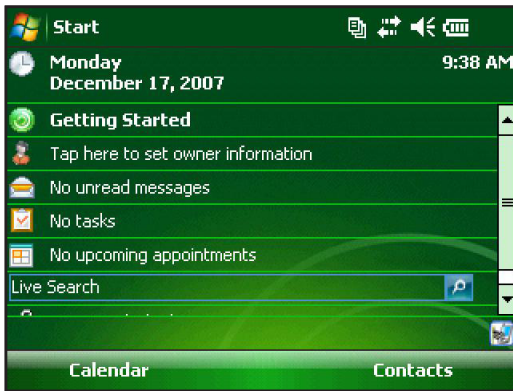

The Today screen also allows you to lock or unlock your device. Locking the device disables your screen for easy cleaning.

To lock the device, simply tap on the words “Device unlocked.” To unlock the device, tap on the word “Unlock” on the two screens that appear.

Using the Start Menu

The Start menu is the main access point to all programs in Windows Mobile®. It allows you to access files, programs, or system settings.

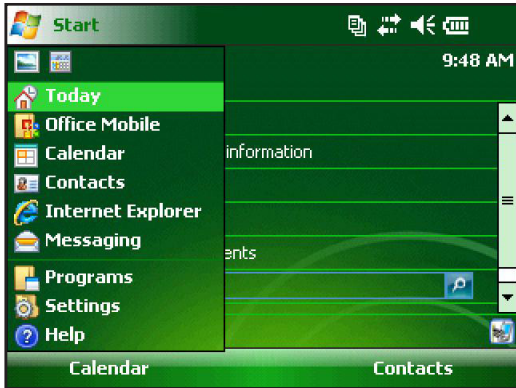

To access the Start menu, tap the Start menu icon in the top left corner of your screen or press the Start menu button on the keypad. The Start menu appears giving you links to programs, settings, and menus.

Entering Information

At the bottom of the display, is a data entry icon. Tapping on the icon allows you to enter information using the stylus. Specifically, you can choose to:



Select alphanumeric characters from the on-screen Keyboard utility (the default input method).



Use *Letter Recognizer*. This input method recognizes character strokes and gestures.



Enter text using *Block Recognizer*. This utility recognizes letters from single strokes.



Use *Transcriber*, a program that allows you to enter data using cursive, print, or mixed handwriting.

Note: For more details about using each input method, go to Start > Settings > Input and choose the input method from the Input window.

When you are ready to enter text, you can switch from the default input method (keyboard) by following these steps:



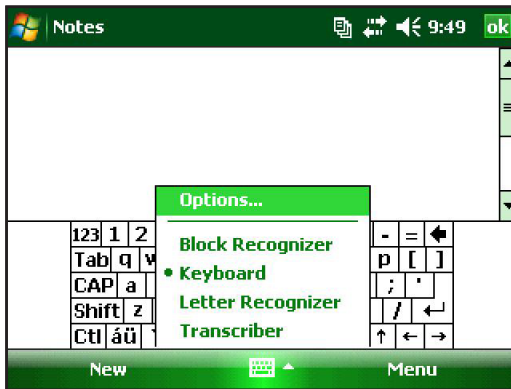

1. On the bottom center of the screen, tap the arrow next to the input method icon (shown). If the input selector arrow is not displayed, tap the input method icon. 
2. The input method menu appears. Tap the input method you want from the list of options.



3. Using the selected input method, enter your text.

Recognizing Status Icons

Status icons show the status of operations on the Field PC. Status icons and their functions are listed in the following chart.

| Icon | Name | Function |
|---|----------------------|--|
|  | Charge indicator | Tells you when the device is charging. |
|  | Speaker | Tap to control volume. |
|  | Battery capacity | Tap to see charge settings screen. |
|  | Touchscreen disabled | Touchscreen is disabled |

For an additional list of icons and their functions, follow these steps:

1. Tap *Start > Help*.
2. Select *Contents* located in the lower left corner.
3. Tap on *Overview of the Today screen > What do those status icons indicate?*

Recognizing Soft Keys

These context-sensitive keys appear as words, buttons, or tabs on the menu bar. Tap on these keys to perform actions or open menus. Here you see soft keys on the Today screen.



Adjusting the Display Backlight

The backlight is set to bright by default when the device is running on external power. When battery power is used the backlight default setting is off, saving battery power. These settings can be adjusted by following these steps:

1. Tap *Start > Settings > System tab > Brightness*.
2. Select the Battery Power tab if it is not already selected. The Brightness window for battery power appears.

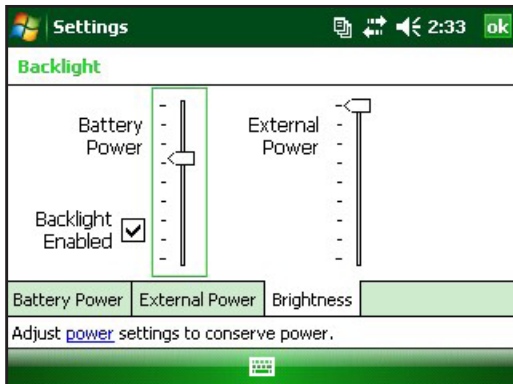

3. You can enable the backlight and adjust the backlight brightness by moving the Battery Power or External Power slider up or down.

Adjusting the Backlight Timer

By default, the display backlight is set to turn off after one minute of inactivity. To adjust the time when your backlight turns off, follow these steps:

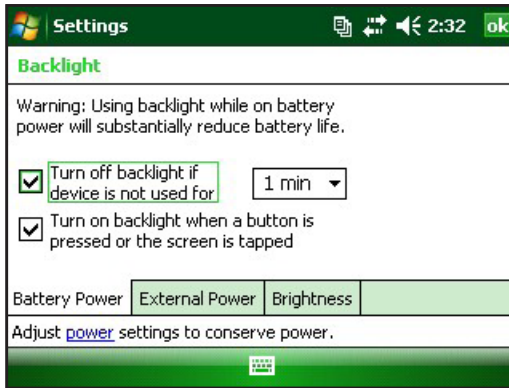

1. Tap *Start > Settings > System tab > Backlight*. The Backlight window appears. To change the timer for external power, tap the External Power tab.
2. Select or deselect the two options.
3. If you selected the first checkbox, choose the length of time before the backlight turns off.

Adjusting the Contrast and Brightness

The mono screen on the Field PC unit has the option to control the contrast. The color screen on the Field PC has the option to control the brightness.

Press the ORANGE shift key and then the F4 to dim, or F5 to brighten, the contrast or brightness.

Performing Common tasks on the Field PC

Creating a Name for the Field PC

We recommend creating a name for the Field PC so external devices like desktop computers or devices that use Bluetooth® wireless technology can differentiate between devices. The Field PC is shipped with a name “FieldPCxxxxxxx” with xxxxxxxx being the serial number.

To create a different name, follow these steps:

1. Tap *Start* > *Settings* > *Systems* tab.
2. Tap *About*.
3. Select the *Device ID* tab at the bottom of the screen.

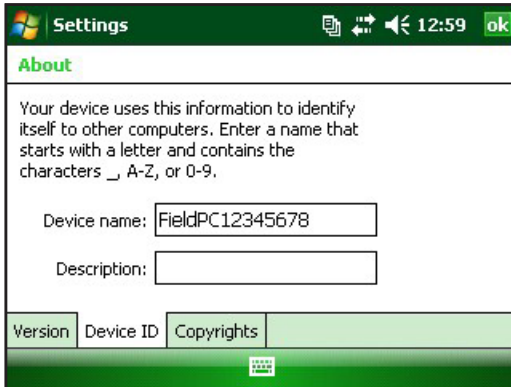

4. Type in a new device name.

Exploring Files

To explore files stored on the Field PC, follow these steps:

1. Tap *Start > Programs > File Explorer*. The File Explorer window appears.
2. If the drive you want does not already appear, tap on the drop-down menu in the top left to select it.



3. Navigate the file directory by tapping on the folders and files you want. If you want to go up a level, tap on the *Up* soft key at the bottom of the screen.
4. Use the *Menu* soft key at the bottom of the screen to manipulate files.

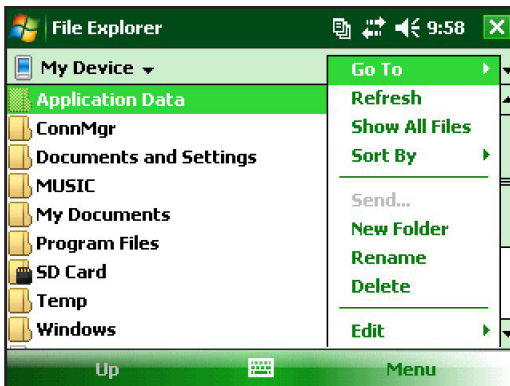

Applications and Task Manager

Close Running Programs

The Task Manager can be used to close unused programs to free memory on the device. We recommend closing any programs you are not using.

Note: Tapping on the  in the top right corner of a program only minimizes the program; the program continues to run in the background.

To close one or more running programs, follow these steps:

1. Go to *Start > Programs > Task Manager*.

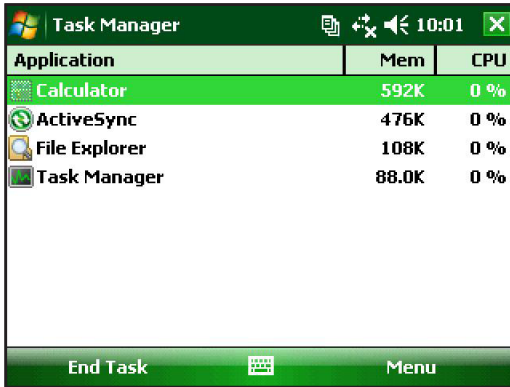

2. Select the program(s) you want to close.
3. Tap *End Task*.

Switching Between Running Programs

To switch between programs running on your Field PC, follow these steps while within the applications manager:

1. Select the program you want to switch to.
2. Tap the *Menu* soft key and then *Switch To*. The program comes to the forefront.

Viewing Memory Allocation for Programs

To see how much memory is available for programs and storage on the Field PC, go to the applications manager by either clicking the icon at the top or pressing the shortcut key. Tap the *Main* tab.

Available memory for storage and programs screen appears.

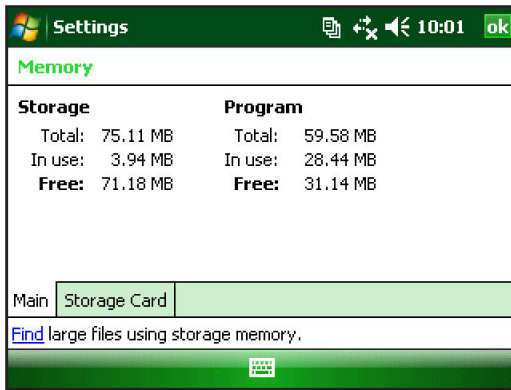

Using On-Device Help

You can access electronic help files on your Field PC from each screen. Windows Mobile® provides help information that is context-sensitive; the help information that appears on the help screen is directly related to what you are doing on the device.

To access help files, follow these steps:

1. Tap *Start > Help*.
2. Select an option from the help menu that appears.

Note: If the topic you want is not listed, try one of these options:

Option 1: Choose *Contents* at the bottom of the screen. A table of contents appears. Tap on the item you want.

Option 2: Choose *Search* at the bottom of the screen. Search allows you to search for specific topics within boundaries you set.

Option 3: If you want help about a certain program on your mobile device, open the program first, then tap *Start > Help*. The help menu items that appear are directly related to the application program.

Note: If you need more assistance than a help file provides, visit the Microsoft website at www.microsoft.com/mobile.

Backing Up Data

Your Field PC is designed to protect your data. However, it is still a good idea to back up your data regularly by saving information to a desktop computer or to a micro SD or PC card.

Backing Up to a Desktop Computer

To copy files from your Field PC to a desktop computer, follow these steps:

Using ActiveSync® (Windows® 2000 and Windows® XP)

1. Re-establish an ActiveSync® connection.
2. In the ActiveSync window on your desktop computer, click *Tools > Explore Pocket PC*.

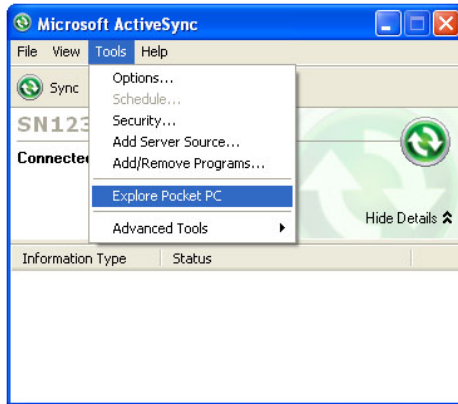

3. A new window opens, showing the file directory for the Field PC.

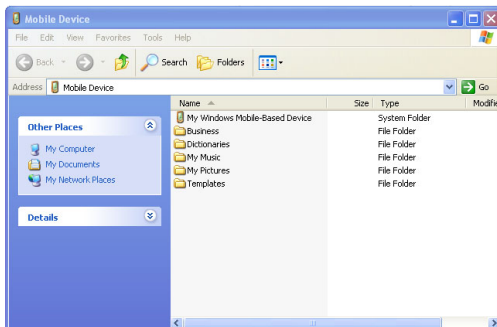

4. Select the files on the Field PC you want to copy.
5. Copy the files by choosing *Edit > Copy* or by right-clicking and choosing *Copy*.
6. Paste the files onto the desktop computer.

Using Windows Mobile® Device Center (Windows Vista™)

1. If you have Windows Vista™, re-establish a Windows Mobile® Device Center connection.
2. In the window on your desktop computer, click *File Management*.



3. A new window opens, showing the file directory for the Field PC.

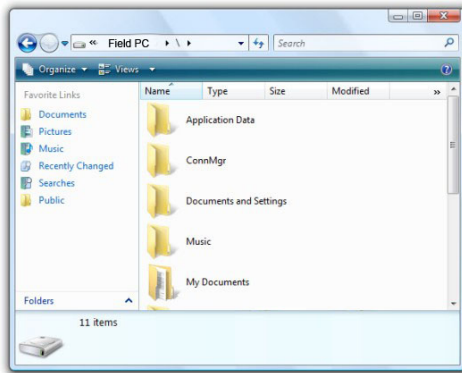

4. Select the files on the Field PC you want to copy.
5. Copy the files by choosing *Edit > Copy* or by right-clicking and choosing *Copy*.
6. Paste the files onto the desktop computer.

Copying Data

To copy data from one directory to another (this includes to and from cards), follow these steps:

1. Select *Start > Programs > File Explorer*.
2. The drop-down menu in the top left is a list of file directories. Choose the directory where the files you want to copy are located.

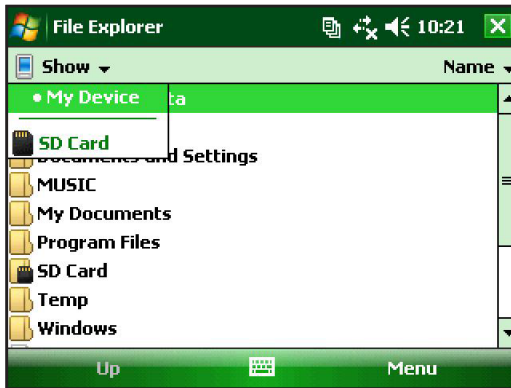

3. Highlight the files you want to copy and tap on *Menu* in the lower right.

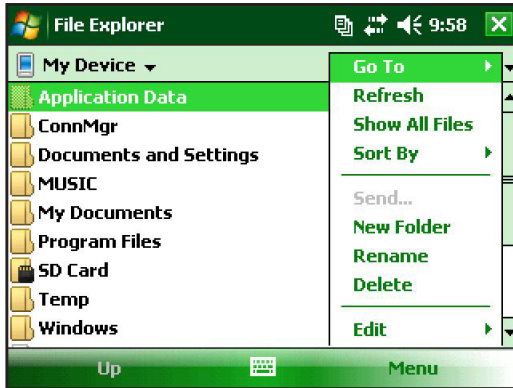

4. Tap the stylus on the *Edit* option.

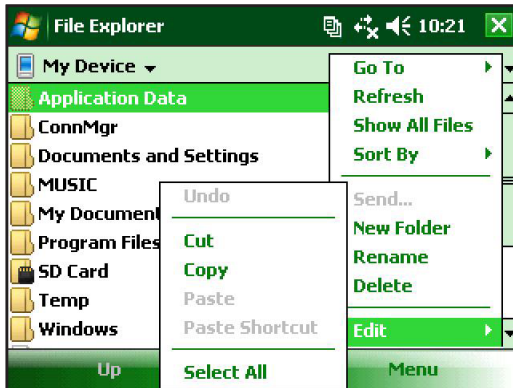

5. Choose *Copy* from the sub menu.
6. Select the file directory you wish to copy to.
7. To paste, tap the *Menu* soft key and choose *Edit > Paste*.
8. The files are now in both directories.

Connecting to a Desktop Computer

Re-establishing an ActiveSync® Connection

To re-establish an ActiveSync® connection, follow these steps:

Note: You can charge the unit while connected.

1. Plug USB client end (mini B) of the USB communications cable into your Field PC.
2. Plug the USB host end (full size A) into your desktop computer. ActiveSync® automatically establishes a connection between the Field PC and the desktop computer.
3. Follow the instructions on the desktop computer screen.

Note: Microsoft ActiveSync® version 4.5 or later is required to connect to the Field PC.

Re-establishing Windows Mobile® Device Center Connection

Complete the following steps to reestablish a Windows Mobile® Device Center connection.

1. Plug the USB host (full sized A) into available port on the desktop computer.
2. Plug the other end, USB client (mini B) into the Field PC. Windows Mobile Device® Center will automatically open.
3. Follow the steps on the screen.

Information for Software Developers

Information for software developers and programmers can be found at the Microsoft website. Information specific to the Field PC can be located at the website www.junipersys.com.

6

Bluetooth® Wireless Communications

50 *Bluetooth® Drivers and Profiles*

56 *Supported Bluetooth® Profiles*



This chapter explains different Bluetooth drivers and profiles and how to create partnerships. Not every Field PC has an integrated Bluetooth radio.

Bluetooth® Drivers and Profiles

Microsoft® Bluetooth drivers are loaded onto your Field PC at the factory. These drivers support the following profiles: serial port, file transfer, audio/visual control, dial up networking, object push, human interface device, and advanced audio distribution.

Identify the Power Status of Bluetooth using Wireless Manager

By default, Bluetooth is turned off. If you turn Bluetooth on and then suspend the device, Bluetooth turns off while the Field PC is suspended to save battery power. When you resume (turn on) the Field PC, Bluetooth turns on automatically. To determine the power status of the Bluetooth tap *Start > Settings > Connections tab > Bluetooth > Mode tab*.



Make the Field PC Discoverable to another Device

To allow other devices that use Bluetooth wireless technology to detect the Field PC and communicate with it, you must make your device discoverable or establish a partnership with the other device.

Follow these steps to make your device discoverable:

1. Tap *Start > Settings > Connections* tab.
2. Tap *Bluetooth*.
3. Select the *Turn on Bluetooth* checkbox, and then select the checkbox to *Make this device discoverable to other devices*.

Create a Bluetooth Partnership

A partnership is created between the Field PC and another device that uses *Bluetooth* wireless technology to help exchange information securely. Follow the steps below to create a partnership:

1. Make sure the two devices are turned on, discoverable, and within at least 30 feet of one another.
2. Tap *Start > Settings* and then tap the *Connections* tab.
3. Tap *Bluetooth > Devices* tab > *Add New Device*. Your device searches for other devices with Bluetooth capabilities and displays them in the list.



4. The name of the Bluetooth device appears. Tap the name, then tap *Next*.

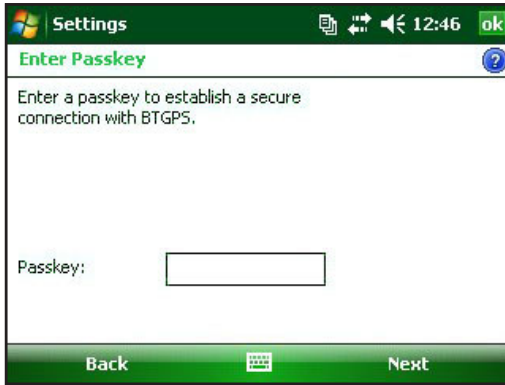

5. If the Bluetooth device has an assigned passkey, enter the number. If the device has not already been assigned a passkey but requires one, enter an alphanumeric passkey on the Field PC between 1 and 16 characters. Tap *Next*.

Note: If you are unsure whether your device requires a passkey and whether one has already been assigned to your Bluetooth device, see the user documentation that came with the Bluetooth device.

Important: If the Bluetooth device does not use a passkey, leave the passkey blank and tap *Next*. A message appears, asking if you want to add the device to the device list. Choose *No* and skip to step 7.

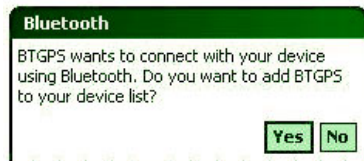

Note: It is important to choose No when you are asked whether you want to add to the device to the device list; choosing Yes sends you back to the passkey screen.

6. Enter the same passkey on the Bluetooth device if required.
7. In the Partnership Settings screen on the Field PC, you can assign a new name to the Bluetooth device in the *Display Name* option.
8. Select the service you want to use from the Services box, then tap *Finish*.

Bluetooth Virtual COM Ports

Some application programs connect using a virtual COM port (serial port) when making a Bluetooth connection. To make a connection possible for such programs, you must first set up a virtual COM port on the Field PC. Once created, this virtual port can be used like any other COM port. For example, you can use a virtual COM port for programs that connect to a GPS receiver.

When setting up a virtual COM port, you must specify if the COM port is an outgoing COM port or an incoming COM port.

An outgoing COM port means that the Field PC initiates communication with the other device. For example, when you are using a Bluetooth GPS receiver, the Field PC initiates the request for data; thus, the virtual COM port connecting with the receiver would be an outgoing COM port.

An incoming COM port means that the other device is initiating the communication with the Field PC. For example, a desktop computer might initiate a Bluetooth ActiveSync connection with the device via the virtual COM port.

For more details about setting up outgoing and incoming COM Ports, read the following sections.

Set up an Outgoing Bluetooth COM Port

Use this option if you want to assign the virtual COM port as an Outgoing COM port (*i.e.*, you want to use the Field PC to initiate communications with another device).

Follow the steps below to set up an outgoing Bluetooth COM port.

1. Make sure you have paired with the serial port device you want to communicate with. To do this, follow the steps in the section called *Create a Bluetooth partnership* in this chapter.
2. Select the COM Ports tab.
3. Tap *New Outgoing Port*, the second option shown.

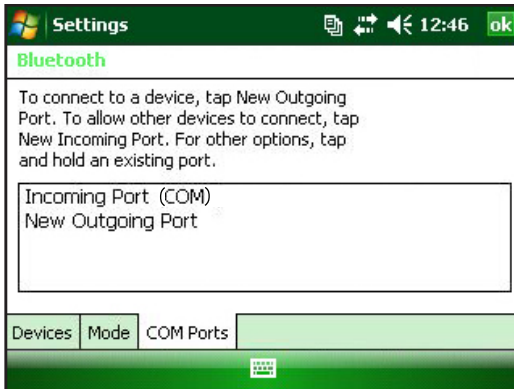

4. The *Add a Device* screen appears. Tap on the name of the device you want to set up as an outgoing port.

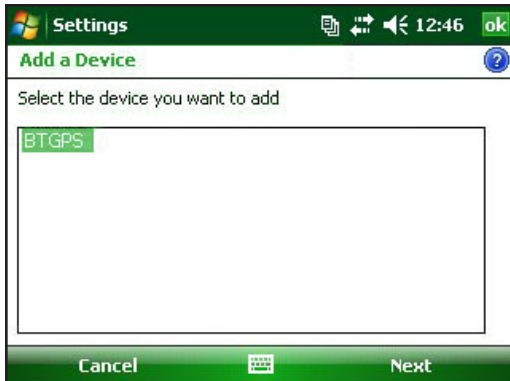

5. Select a numbered COM port from the list of ports that appear. If the port cannot be created, it is in use. Select a different numbered port.

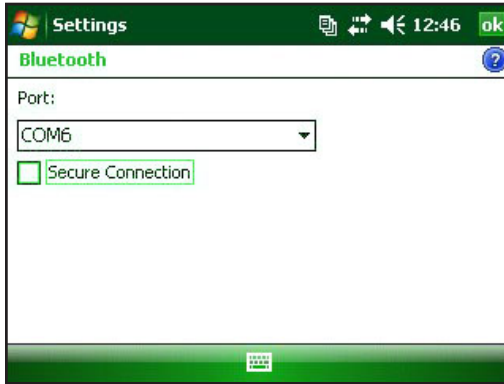

6. **Important:** Deselect the *Secure Connection* option below the list of COM ports, as shown above. Deselecting this option ensures that the device disconnects its Bluetooth connection only when you tell it to, and prevents the device setup from being deleted after one connection.
7. Tap *Finish*.

Once the virtual COM port is assigned using the outgoing Bluetooth COM port, specify the COM port assignment within your application as explained in the user documentation for the application. An example follows.

Suppose you are using a Bluetooth-enabled GPS receiver with the device and a navigation program on the Field PC. In this example, assume you have set up a virtual COM port between the Field PC and the GPS receiver and that you assigned the outgoing COM port as COM 6. To assign the COM port in your navigation program, you would then follow these steps:

1. Locate the place in the navigation program where the COM port is chosen.
2. Select COM Port 6 as the COM port for the Bluetooth GPS receiver.

Set up an Incoming Bluetooth COM Port

Use this option if you want to assign the virtual COM port as an Incoming COM port (i.e., you want another device to initiate communications with the Field PC). If you are connected with a Bluetooth device that supports serial communications, follow these steps to set up the incoming Bluetooth COM port:

1. Press the *COM Ports* tab.
2. Tap on *New Incoming Port*.
3. Select a numbered COM port from the list.
Note: If the port cannot be created, it is in use. Select a different numbered port.
4. **Important:** Deselect (clear) the *Secure Connection* checkbox. Deselecting this option ensures that the device disconnects its Bluetooth connection only when you tell it to, and prevents the device setup from being deleted after one connection.

Supported Bluetooth® Profiles

This section describes the *Bluetooth*® profiles recognized by the Microsoft drivers installed on your Field PC. Drivers determine which devices your Field PC can communicate with.

Note: Bluetooth cards are not recognized by Field PCs with integrated Bluetooth.

This section is organized by Bluetooth profile, each of which is briefly described below. Instructions for using each profile to create Bluetooth partnerships follow.

- *Serial Port Profile (SPP)*. Similar to a serial cable, this profile acts as a liaison between two devices, such as the Field PC and a GPS receiver, using virtual ports. (These ports are described in the previous section.)

- *Dial-Up Networking (DUN)*. This profile lets you connect to a computer through a cell phone or a Bluetooth-enabled modem.
- *Human Interface Device (HID)*. This profile allows you to communicate between the Field PC and a Bluetooth keyboard or mouse.
- *Object Push Profile (OPP)*. This profile lets you exchange files like data, audio, business cards, appointments, and contacts. Similar to the well-known object exchange profile (OBEX).
- *Advanced Audio Distribution (A2DP)*. This profile allows output for high fidelity stereo audio to Bluetooth enabled headphones, as well as microphone audio back to handheld.
- *File Transfer Profile (FTP)*. This profile lets you transfer files between handheld computers and/or desktop computers.
- *Audio/Video Control*. This profile is the control for the audio player, such as start, stop, play previous, play next, and volume.

Serial Port Profile (SPP)

This section explains how to:

- Communicate with another device using the Serial Port Profile
- Configure ActiveSync® to synchronize through the Serial Port Profile
- Connect to a desktop computer that has a Bluetooth dongle
- Print from the Field PC to a Bluetooth printer using the Serial Port Profile

Communicating with Another Device using the Serial Port Profile

Follow the instructions below to communicate with a device using the Serial Port Profile.

1. On the Field PC, tap on the Wireless Manager icon to make sure Bluetooth is on and that the Field PC is discoverable.
2. In the Wireless Manager, tap *Menu > Bluetooth Settings > Device* tab > *New partnership*.

3. Select your target device and tap *Next* to create a Bluetooth partnership with the target device. *Note: After you have created a partnership with a device, the device automatically appears in the list of Bluetooth devices. You do not have to re-create a device partnership.*
4. Enter the passkey on the Field PC and on the device. (See the documentation for the device for details. If there is no passkey listed for the device, tap *Next*, then *No*.)
5. On the Field PC, select *Serial Port* and tap *Finish*.
6. The device appears on the list of partnerships.
7. Choose the *COM Ports* tab. Choose *New Outgoing Port* and tap *Next*. Select a COM port that is available.
8. **Important:** Deselect (clear) the *Secure Connection* checkbox. Deselecting this option ensures that the device disconnects the Bluetooth connection only when you tell it to.
9. Tap *Finish* to save the settings. Tap *OK* and *Done* to close the Wireless Manager application.

Connecting to a Desktop Computer using a Bluetooth Dongle

1. Make the Field PC discoverable.
2. Select the *COM Ports* tab.
3. Choose *New Outgoing Port*.
4. Select the device and tap *Next*.
5. Select an available COM Port.
6. **Important:** Deselect (clear) the *Secure connection* option. Deselecting this option ensures that the device disconnects its Bluetooth connection only when you tell it to.
7. Tap *Finish* to save your settings.
8. On your desktop computer, right-click the Bluetooth icon on your menu bar.
9. Select *Add Bluetooth device*.

10. Select *Let me choose passkey*.
11. Type in a passkey.
12. On the Field PC, type in the same passkey.
13. Tap *Next*, *OK*, and *Done*.

Print from the Field PC to a Bluetooth Printer using the Serial Port Profile

Currently, not many Windows Mobile applications support direct printing. However, you can use third-party printing programs such as PrintBoy® to print data from the Field PC with a Bluetooth printer.

Before you set up a third-party print application, you need to first discover the Bluetooth printer. To do so, follow these steps:

1. On the Field PC, make sure Bluetooth is on and that the Field PC is discoverable.
2. In the Wireless Manager, tap *Menu* then *Bluetooth Settings*.
3. From the *Devices* tab, select *New partnership*.
4. When the printer appears on the list of devices, select it.
5. Tap *Next*.
6. Enter the passkey and tap *Next*.
7. Select *Serial Port*.
8. From the COM Ports tab, tap *New Outgoing port*.
9. Select the printer.
10. Tap *New COM port*.
11. Deselect the *Secure Connection* option.

You can now print using a third-party print application you install on the Field PC. For details about using the application to print, see the documentation that came with the application.

Dial-Up Networking (DUN) Profile

This profile allows you to connect to the Internet using a cell phone dial-up connection or cordless modem. Instructions for partnering with both device types are described below.

Connecting to the Internet using a Cell Phone Dial-Up Connection

1. Make your cell phone discoverable. (See the user documentation that came with your cell phone for instructions.)
2. On the Field PC, tap on the Wireless Manager icon on the Today screen.
3. Tap *Menu > Bluetooth Settings*.
4. Select the *Turn on Bluetooth* checkbox.
5. In the Devices tab, choose *New Partnership*.
6. Select your cell phone from the list of devices and tap *Next*.
7. Enter any passkey on the Field PC.
8. Enter the same passkey and any other requested information on your cell phone.
9. On the Field PC, select *Dialup Networking*, then tap *Next*.
10. Tap *Start > Settings > Connections tab > Connections*.
11. Choose *Add a new modem connection*.
12. Enter a name for the connection and select *Bluetooth* as the modem.
13. Tap *Next*.
14. Select the name of your cell phone, then tap *Next*.
15. Enter the phone access number according to your phone carrier's specifications. Tap *Next*.
16. Enter a user name, password, and domain as specified by your network administrator.
17. Tap *Advanced*.
18. Fill in the remaining boxes as appropriate. Tap *OK* when you are done.
19. Tap *Finish*. Now you should be able to connect to the Internet on the Field PC through your phone's dialup connection.

Human Interface Device (HID) Profile

1. Make sure Bluetooth is on or discoverable. Create a Bluetooth partnership with the device.
2. Make sure the HID is ready for pairing and select *New Partnership* to search for a Bluetooth device.
3. Select the name of the HID and tap *Next*.
4. If the device has an assigned passkey or accepts a passkey you give it, enter the passkey on the Field PC and tap *Next*. If the device needs no passkey, leave the Passkey field blank, tap *Next*, and choose *No* when you are asked whether you want the device to be added to the device list.

Note: Saying No when you are asked whether you want to add the device to the device list allows you to proceed to the next screen; saying Yes returns you to the passkey screen.

5. If appropriate, enter the same passkey on the HID to establish a partnership.
6. Select *Input Device*.
7. Tap *Finish*. You now have a partnership with the HID.

Note: If no partnership appears for the HID on the Devices tab screen, try resetting your Field PC.

Object Push Profile (OPP) or Beaming

Your Field PC uses Object Exchange File (OBEX) protocol to transfer or “push” electronic objects such as business cards from one Bluetooth-enabled device to another.

Transferring Data from a Bluetooth-Enabled Device

To send data (beam) from a Bluetooth-enabled device to the Field PC, follow these steps:

1. Make sure the Field PC is discoverable.
2. On the Bluetooth-enabled device, tap and hold the stylus on the filename you want to beam. A menu appears.
3. Choose *Beam File*. The device finds the Field PC.
4. Send data from the device to the Field PC. The Field PC receives the data.

To send data from your Field PC to a Bluetooth device, follow these steps:

1. Make sure the device is discoverable. (For instructions, see the user documentation that came with your device.)
2. On the Field PC, make sure Bluetooth is on.
3. In File Explorer, tap and hold on the name of the file you want to transfer, then choose *Beam File* from the menu that appears.
4. When the name of the device becomes visible, tap on the name.
5. On the Bluetooth device, accept the file. The file is transferred.

More Information about Bluetooth

For more information on Bluetooth profiles visit <http://bluetooth.com>.

7

Wi-Fi Connections

64 *Wi-Fi Connections*

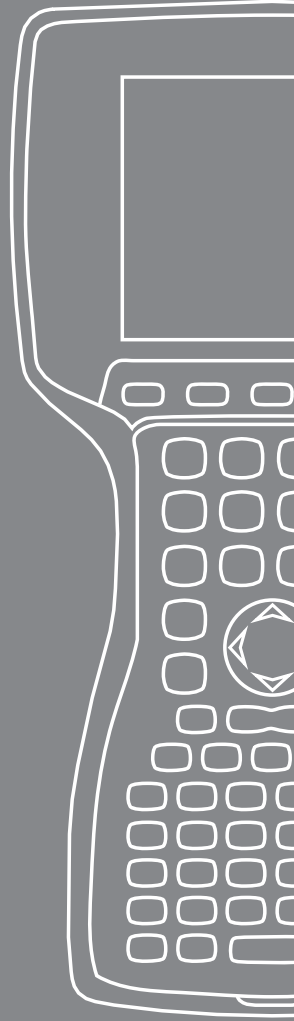

This chapter teaches how to connect to networks and the internet through the built in Wi-Fi module. Not all Field PCs come with an integrated Wi-Fi module.

Wi-Fi Connections

When the Field PC is connected through Wi-Fi, the icon  appears in the tool bar.

Connecting to Wi-Fi Network

When entering an access point, a window pops up on your screen asking if the network connects to the internet or a private or corporate network. Choose the correct network and tap *Connect*. The choice is stored in the Connection Manager for future use.

If the window does not pop up, you can actively look for a network connection by completing the following steps:

1. Activate Wi-Fi by going to *Start > Settings > Connections tab > Wireless Manager*.



- Turning the Wi-Fi on automatically scans the area for available networks.

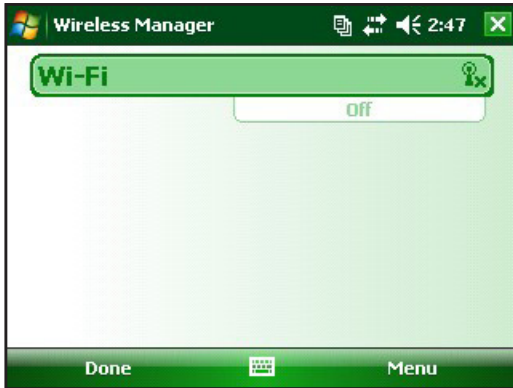

- When the Field PC has completed the scan, a list of available networks and their strengths appears in *Start > Settings > Connections tab > Wi-Fi*

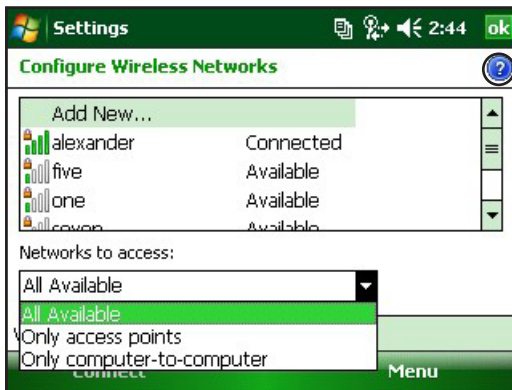

Note: Click on this icon when you need help.

4. Tap on the desired network to connect.

Note: If the network is password protected, a window appears for the password to be inserted.

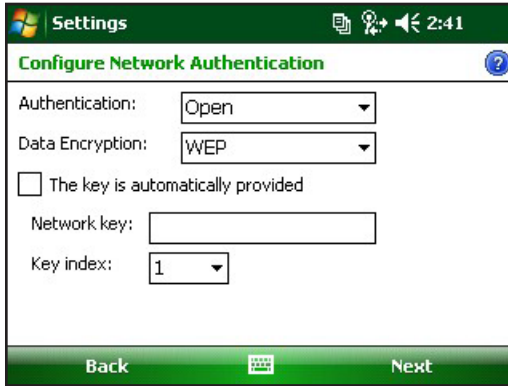

Managing Connections

To adjust the Wi-Fi settings, access the Managing Connections window go to *Start > Settings > Connections* tab > *Connections*.

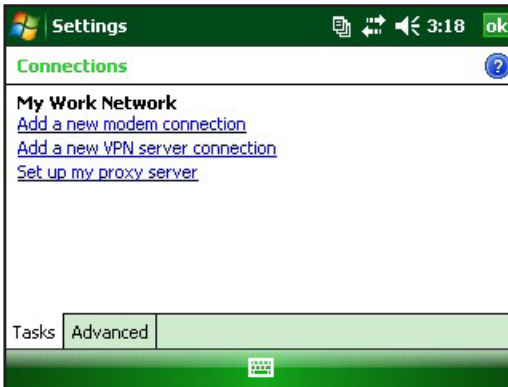

8

Care and Maintenance

- 68 *Caring for your Field PC*
- 73 *Disposing of the Field PC
Battery Pack*



This chapter explains how to store, clean, and protect your Field PC and battery pack.

Caring for Your Field PC

Storing your Field PC and Battery Pack

When the Field PC is not being charged and is suspended, it draws a small amount of power. This power draw is used to maintain the memory (RAM) of the Field PC in the same state it was when it was suspended.

When the battery reaches a low charge, the Field PC automatically comes out of suspend mode and powers off so there is no further drain on the battery. This feature protects your battery from damage if this charge level occurs. The Field PC resets when the battery is recharged and turned on.

Data and programs are secure, as long as they have been saved, even if the battery pack becomes discharged. The Field PC does not depend on the battery to store the data for extended periods.

Storing the Field PC for Less Than Two Weeks

To protect the files on your Field PC during storage periods of less than two months, complete the following steps:

1. Close all application programs.
2. Plug your Field PC into the AC wall adapter that was shipped with your Field PC, or place the unit into the USB/Power Dock that is plugged into the AC wall charger.

Note: Charging the Field PC when it is not in use helps the Field PC to avoid inaccurate battery gauging and having the battery discharge to low levels.

Storing the Field PC for More than Two Weeks

To protect the Field PC during storage periods of two months or more, complete the following steps:

1. Charge the battery to full capacity (100%).
2. Close all running programs and turn off the Field PC.
3. Remove the battery pack.



4. Place the battery pack in a dry location.

Taking your Field PC out of Extended Storage

While storing the battery pack, it naturally discharges slightly while inactive. When you are ready to use your Field PC after storing it for an extended period of time, complete the following steps:

1. Insert the battery pack.
2. Turn on your Field PC.
3. Enter 10% on the Battery Settings pop up screen.
4. Tap on the Accept button to save the new setting.
5. Plug your Field PC into the external AC wall charger and charge the battery pack in your Field PC for at least 6 hours.

Protecting the Touchscreen

Protect the touchscreen from impact, pressure, or abrasive substances that could damage it. To further protect the touchscreen, apply one of the screen protectors that came with your Field PC.

When using any screen protector, be sure to replace the screen protector as often as the screen protector packaging directs. To apply a screen protector, follow the directions on the package.

Protecting the Field PC against Mechanical Shock

The Field PC is designed for protection from mechanical shock. It can be dropped from up to four feet (1.219 m) onto plywood. Shock protection is guaranteed only when the optional expansion pods and latches are securely fastened.

Cleaning the Field PC

In some environments, the Field PC is exposed to substances, such as pitch or tar which require stronger cleaning supplies for removal.



CAUTION: Some of the available cleaning supplies/chemicals on the market will damage the case.

Safe Cleaners to Use

The Field PC can be cleaned safely with the following cleaners:

- Greased Lightning® Multi-Purpose Cleaner
- Orange Clean (Orange Glo® International)
- Fantastik® OxyPower® (SC Johnson)
- Orange Cleaner Oil Eater (Kafko International, Ltd.)

Cleaning the Case

To clean the case, it is recommended that you use warm water, mild detergent, and a toothbrush.

Note: This method can be used when cleaning the keyboard. Do not use the brush on the display, it could be scratched.

Cleaning the Keyboard

Dirt and debris can get underneath the keyboard bezel. To clean, use a coin (do not use a screwdriver) to pry the bezel up at the recess located at the bottom of the keyboard.



We recommend that you use warm water, mild detergent, and a toothbrush to clean the keyboard. The Field PC remains sealed during this process.

Note: Do not direct a high pressure stream of water at the keyboard to clean it. This action could break the seal, causing water to get inside the Field PC.

Reattach the bezel by inserting the top ridge and lowering the bezel down flat onto the case. Press down along the sides while aligning the keys through the holes.



Note: After you reattach the bezel, check each key to make sure it is completely free from the bezel. If any part of a key is caught underneath the bezel, you may not be able to turn the Field PC on or you may hear a continuous string of beeps.

Cleaning the Touchscreen

To clean the touchscreen of the Field PC, complete the following steps:

1. Press the *BLUE* shift key + *TS (BkSp)* key to disable the touchscreen.
2. Use a clean cotton cloth to wipe off the screen.

Note: Do not use anything abrasive that could scratch the screen (including tissues and paper towels).

3. Press the *BLUE* shift key + *TS (BkSp)* key to enable the touchscreen.

Disposing of the Field PC and Battery Pack

This product must not be disposed of with municipal waste. It is your responsibility to dispose of your waste equipment by handing it over to a designated collection point for the recycling of waste electrical and electronic equipment. If you cannot find a location, contact the manufacturer for information about disposal.

The Nickel Metal Hydride battery pack for your Field PC is recyclable. Avoid placing it in the trash or municipal waste system.

To find the nearest battery recycling center in the USA, visit the Rechargeable Battery Recycling Corporation's website at *www.rbrc.org/call2recycle/index.html* or call 1-800-8-battery.

The Field PC contains no mercury or cadmium.

9

Service Information

- 76 *Repairing the Field PC*
- 76 *Preparing for a Service Center Call*



This chapter teaches you how to return and prepare your Field PC for repair. It also shows you where to find information you need when making a call to a service center.

Repairing the Field PC

If the Field PC is in need of repair, call your service center for a Return Materials Authorization number (RMA).

Important: Do not attempt to service the device yourself. This action voids the warranty.

Preparing for a Service Center Call

When you contact a service center, you are asked to identify your device. Your device serial number and other identification information can be found by following these steps:

1. Tap *Start* > *Settings*. The Settings window appears.
2. Tap the System tab.
3. Choose *System Config*. The System Configuration window appears, listing the information you need for the service center.

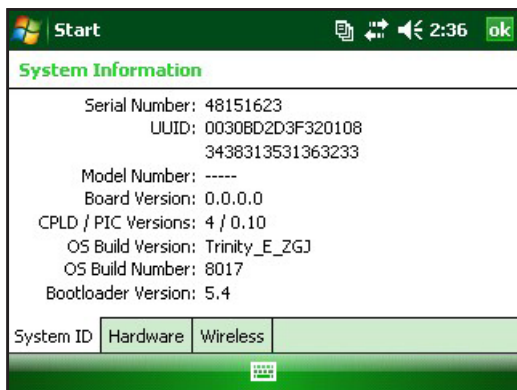

Note: The numbers in the above screen may not be the numbers on your Field PC.

A

Product Specifications and Warnings

- 78 *Product Specifications*
- 79 *9-pin Serial Port Pinouts*
- 80 *Battery Warnings*
- 81 *Equipment Warnings*



Product Specifications

| | |
|-----------------------------------|--|
| Operating System | Microsoft® Windows Mobile® 6 |
| Processor | Intel® XScale® PXA270, 624 MHz |
| Memory | 128 MB RAM |
| Primary Storage | 512 MB, 1G, 2G |
| Display Color | 3.8" QVGA active matrix color TFT transfective LCD with LED backlight; 320 x 240 pixels |
| Display Mono | 4.1" QVGA with LED backlight; 320 x 240 pixels |
| Touchscreen | Sealed, resistive, pressure sensitive, enable/disable |
| Expansion and I/O slots | Micro SD; PCMCIA 3.3/5 volts of Type I or Type II |
| Keyboard | All printable ASCII characters, 12 function keys |
| Operating Temperature | -4° to 131° F (-20° to 55° C) |
| Storage Temperature | -31° to 140° F (-35° to 60° C) |
| Battery Charging Temperature | 32° to 104° F (0° to 40° C) |
| Water, Sand and Dust proof rating | IP67 sealed against accidental immersion (1 m for 30 minutes) |
| Battery Pack | Rechargeable nickel metal hydride (NiMH) |
| Communications Module | Serial port 9-pin D-sub connector, USB Host (Full A), USB Client (Mini B), power input 12 volts DC |
| COM 1 Port | 9-pin D-sub connector; full modem control signals, 5 V @ 200 mA available on DTR pin 4; controlled by DTR signal; conformal coated |

| | |
|-------------------------|---|
| Power | Input 12 volts DC; Range 10-20 VDC; reverse polarity protection; over voltage protection; auto shut off |
| Wireless Communications | Optional integrated Bluetooth and 802.11 b/g WLAN (Wi-Fi) |
| Internal Clock | Integrated real time clock with battery backup |
| Enunciators | On system tray |

9-pin Serial Port Pinouts

| Pin # | Description |
|-------|----------------------------------|
| 1 | Data Carrier Detect (DCD) Input |
| 2 | Receive Data (RCD) Input |
| 3 | Transmit Data (TXD) Output |
| 4 | Data Terminal Ready (DTR) Output |
| 5 | Ground (GND) |
| 6 | Data Set Ready (DSR) Input |
| 7 | Request To Send (RTS) Output |
| 8 | Clear To Send (CTS) Input |
| 9 | Ring Indicator (RI) Input |

Wiring Diagram

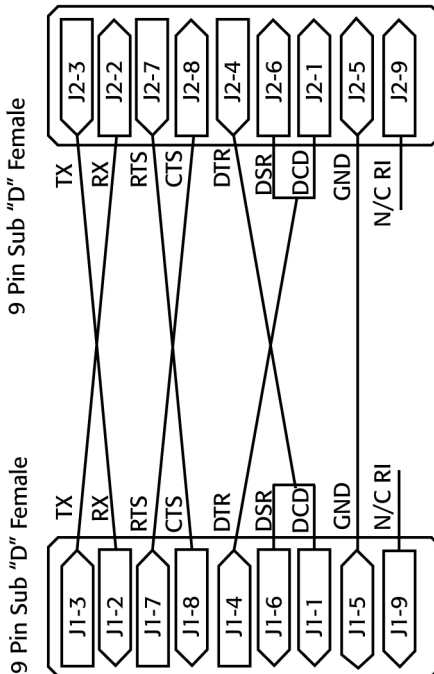

Battery Warnings

Follow these additional safety guidelines:

Use only battery packs approved for use with this device.

Do not store or leave your device or battery pack near a heat source such as a radiator, fireplace, stove, electric heater, or other heat-generating appliance, or otherwise expose it to temperatures in excess of 140° F (60° C).

Do not try to open the battery pack.

Do not carry a battery pack in your pocket, purse, or other container where metal objects (such as car keys or paper clips) could short-circuit the battery pack terminals.

Keep the battery pack contacts clean. If they get dirty, wipe them off with a soft cloth.

Dispose of the battery pack properly. See the section called *Disposing of your Field PC and battery packs* in this manual for instructions.

Do not install the battery pack backwards so that the polarity is reversed.

Do not connect the positive terminal and the negative terminal of the battery pack to each other with any metal object (such as wire).

Do not solder directly onto the battery pack.

Do not place the battery pack in direct sunshine.

In the rare event that the battery pack leaks and fluid gets into the eye, do not rub the eye. Rinse well with water and immediately seek medical care.

Risk of explosion if incorrect battery type is used.



Equipment Warnings

WARNING: To reduce the risk of personal injury, electrical shock, fire or damage to the equipment:

Plug the wall charger into an electrical outlet that is easily accessible at all times.

Disconnect power from the equipment by unplugging the wall charger from the electrical outlet or unplugging the synchronization cable from the host computer.

Do not place anything on the wall charger cord or any of the other cables. Arrange them so that no one may accidentally step on or trip over them.

Do not pull on a cord or cable. When unplugging the wall charger from the electrical outlet, pull on the plug, not the cord.

Use only wall chargers intended for the Field PC. Using any other external power source can damage your product and void your warranty.

Using the Field PC in Extreme Temperatures

The Field PC operates in ranges from -4°F to 131°F (-20°C to 55°C). To help your device function properly, store the device indoors when possible.

Other Tips:

If the Field PC is exposed to temperatures below 14°F (-10°C), the device may slow down or the display backlight may become dim to reduce the load on the battery power.

Extremely low or high temperatures may prevent the battery pack from charging. Charge the battery pack in temperatures between 32°F and 104°F (0°C and 40°C). For best results, charge the battery pack at room temperature (68°F or 20°C).

B

Certifications and Regulatory Information

84 *Regulatory Information*

87 *Limited Product Warranty*



Regulatory Information

FCC

This device complies with Part 15 of the FCC Rules. Operation of this equipment is subject to the following two conditions:

1. The device may not cause harmful interference.
2. This device must accept any interference received, including interference that may cause undesired operation.

Note: This equipment has been tested and found to comply with the limits for a Class B digital device, pursuant to part 15 of the FCC Rules. These limits are designed to provide reasonable protection against harmful interference in a residential installation. This equipment generates, uses and can radiate radio frequency energy and, if not installed and used in accordance with the instructions, may cause harmful interference to radio communications. However, there is no guarantee that interference will not occur in a particular installation. If this equipment does cause harmful interference to radio or television reception, which can be determined by turning the equipment off and on, the user is encouraged to try to correct the interference by one or more of the following measures:

- Reorient or relocate the receiving antenna.
- Increase the separation between the equipment and receiver.
- Connect the equipment into an outlet on a circuit different from that to which the receiver is connected.
- Consult the dealer or an experienced radio/TV technician for help.

ⓘ CAUTION: Changes or modifications to the Field PC that are not expressly approved by the manufacturer could void the user's authority to operate the equipment.

ⓘ CAUTION: Only approved accessories may be used with this equipment. In general, all cables must be high quality, shielded, correctly terminated, and normally restricted to two meters in

length. Wall chargers approved for this product employ special provisions to avoid radio interference and should not be altered or substituted.

This device must not be co-located or operating in conjunction with any other antenna or transmitter.

This device operates in compliance with the FCC radiation exposure limits for an uncontrolled environment. Users must follow instructions provided in the user documentation to satisfy compliance with FCC RF exposure requirements.

This device has been tested and meets the FCC RF exposure guidelines when used with the body worn accessories supplied with this product. Use of other accessories for body worn use may expose the user to RF radiation that exceeds the FCC guidelines.

Industry Canada

This Class B digital apparatus complies with Canadian ICES-003. Cet appareil numérique de la classe B est conforme à la norme NMB-003 du Canada.

This device complies with RSS-210 of Industry Canada. Operation is subject to the following two conditions: (1) this device may not cause interference, and (2) this device must accept any interference, including interference that may cause undesired operation of the device.

CE Marking

 Products bearing the CE marking comply with the 2004/108/EC (EMC Directive), 1999/5/EC (R&TTE Directive), 2006/95/EC (Low Voltage Directive) issued by the Commission of the European Community.

CE compliance of this device is valid only if powered with/by a CE-marked wall charger provided by the manufacturer. Compliance with these directives implies conformity to the

following European Norms (in parentheses are the equivalent international standards and regulations):

- EN 55022 (CISPR 22)—Electromagnetic Interference
- EN 55024 (IEC 61000-4-2, 3, 4, 5, 6, 8, 11)—Electromagnetic Immunity
- EN 61000-3-2 (IEC 61000-3-2)—Power Line Harmonics
- EN 61000-3-3 (IEC 61000-3-3)—Power Line Flicker
- EN 60950 (IEC 60950)—Product Safety
- ETS 300 328-2—Technical Requirements for 2.4 GHz Radio Equipment
- EN 301 489-1, -17—General EMC Requirements for Radio Equipment

European Union

The telecommunication functions of this device may be used in the following EU and EFTA countries: Austria, Belgium, Bulgaria, Cyprus, Czech Republic, Denmark, Estonia, Finland, France, Germany, Greece, Hungary, Iceland, Ireland, Italy, Latvia, Liechtenstein, Lithuania, Luxembourg, Malta, Netherlands, Norway, Poland, Portugal, Slovak Republic, Romania, Slovenia, Spain, Sweden, Switzerland, and United Kingdom.

Restrictions apply to the operation of the 802.11b/g radio in this device. Use of channel 14 is outside of the band of frequencies permitted in the European Union and should not be used.

France

Restrictions apply to the operation of the Bluetooth radio in this device. This equipment may be used indoors. Due to the potential that this radio may transmit in excess of 10mW in the band 2454 to 2483.5 MHz, outdoor operation is restricted. The latest requirements may be found at: <http://www.art-telecom.fr>

Limited Product Warranty

Juniper Systems, Inc. (“JS”) warrants that the Field PC/Field PCs shall be free from defects in materials and workmanship, under normal intended use, for a period of 12 months from the date of shipment. The Field PC can be warranted up to 5 years (including the standard warranty period) through the purchase of an extended warranty. JS warrants that the following items shall be free from defects in materials and workmanship, under normal intended use, for a period of ninety (90) days from the date of shipment:

- battery packs,
- media containing the Field PC programs,
- desktop computer programs,
- user documentation, and
- accessories.

Extended warranties apply only to the Field PC, not battery packs, media containing the Field PC programs, desktop computer programs, user documentation, and accessories. Parts that are excessively worn are not covered under the extended warranty plan. These parts may include, but are not limited to, the keyboard elastomer and switch matrix, hand straps, touchscreens, and connector modules.

Warranty Exclusions

This warranty shall not apply if:

- (i) the product has been set up improperly or has been improperly installed or calibrated,
- (ii) the product is operated in a manner that is not in accordance with the user documentation,
- (iii) the product is used for a purpose other than for which it was designed,

- (iv) the product has been used in environmental conditions outside of those specified for the product,
- (v) the product has been subject to any modification, alteration, or change by or on behalf of customer (except and unless modified, changed or altered by JS or under direct supervision of JS),
- (vi) the defect or malfunction results from misuse or accident,
- (vii) the serial number on the product has been tampered with or removed, or
- (viii) the product has been opened or tampered with in any way.

This warranty is exclusive and JS will not assume and hereby expressly disclaims any further warranties, whether express or implied, including, without limitation, any warranty as to merchantability, fitness for a particular purpose, non-infringement or any warranties arising from the course of performance, dealing, or usage of trade. JS specifically makes no warranties as to the suitability of its products for any particular application. JS makes no warranties that

- its products will meet your requirements or will work in combination with any hardware or applications software products provided by third parties,
- the operation of its products will be uninterrupted or error free, or
- all defects in the product will be corrected.

JS shall not be responsible for software, firmware, information, or memory data contained in, stored on, or integrated with any products returned to JS for repair, whether under warranty or not.

Remedy

In the event a defect in materials or workmanship is discovered and reported to JS within the specified warranty period, JS will, at its option, repair the defect or replace the defective part or product. Replacement products may be new or reconditioned. JS

warrants any replaced or repaired product for a period of ninety (90) days from the date of return shipment, or through the end of the original warranty period, whichever is longer.

Limitation of Liability

To the fullest extent allowed by law, the obligation of JS shall be limited to the repair or replacement of the product. JS shall in no event be liable for special, incidental, or consequential, indirect, special or punitive damages of any kind, or for loss of revenue or profits, loss of business, loss of information or data, or other financial loss arising out of or in connection with the sale, installation, maintenance, use, performance, failure, or interruption of any product. Any responsibility and/or liability of JS shall, in connection with a warranted product, be limited in the maximum amount to the original purchase price.

Warranty Repairs

To obtain repair or service on the Field PC, contact your authorized repair center within the applicable warranty period to receive a Return Material Authorization (RMA) number. Repairs returned without proper authorization may acquire an additional handling fee and/or delay in the repair. The customer is responsible to prepay all shipping costs when sending equipment to a repair center. JS will return the repaired equipment by the same method it was received with costs of shipping prepaid.

Governing Law

This warranty is governed by the laws of Utah, and excludes the United Nations Convention on Contracts for the International Sale of Goods. The courts of Utah shall have exclusive personal jurisdiction in case of any disputes arising out of or in connection with this warranty.

Services and Materials Provided Under Warranty

- Analysis of problem by service technician
- Labor and materials required to fix defective parts
- Functional analysis performed after repair
- Repair turnaround within 10 working days of receipt unless special circumstances exist
- Shipping costs to return device to customer

Index



Index

A

- ActiveSync 20
 - Backing up Data 44
 - Creating a connection 20
 - Re-establishing Connection 48
- Alkaline Battery Holder
 - Install 15
- Applications Manager 24, 42
 - Viewing Memory Allocation 42

B

- Backing Up Data 44
 - To Desktop Computer 44
- Backlight 24
 - Timer 39
- Battery Pack. *See also* Alkaline Battery Holder
 - Battery Settings Screen 12
 - Capacity 14
 - Charging Temperature 78
 - Disposing of 73
 - Install 7
 - Percentage and Capacity 13
 - Recharging 14
 - Warnings 80
- Battery Settings Screen. *See* Battery Pack
- Bluetooth
 - Advanced Audio Distribution (A2DP) 57
 - Audio/Video Control 57
 - Beaming. *See* Object Push Profile (OPP)
 - Create a Partnership 51
 - Dial-Up Networking (DUN) 60
 - Dial-Up Networking profile
 - using a cell phone to connect to the Internet 60
 - Dongle 58

- Drivers and Profiles 50
- File Transfer Profile (FTP) 57
- Human Interface Device (HID) 61
- Incoming COM Port 56
- Internet using Dial-up Connection 60
- Make Discoverable 50
- Object Push Profile (OPP) 61
- Outgoing COM Port 54
- Passkey 52
- Print 59
- Serial Port Profile (SPP) 57
- Virtual COM Port 53
- Wireless Manager 50
- Bluetooth Profiles
 - Profiles 56

C

- Care and Maintenance 68
 - Cleaning 70
 - Protecting Against Mechanical Shock 70
 - Protecting the touchscreen 70
 - Storage 68
 - Less Than Two Months 68
 - More Than Two Months 69
 - Taking Out 69
- CE Marking 85
- CF Card. *See* PC Card
- Communicating with a Desktop Computer 20, 48.
 - See also* ActiveSync and Windows Mobile Device Center
- Communications Module 78
- Connector Protectors 26
- Contrast/Brightness 24, 39
- Copying Data 46
- Creating a Name 40

D

- Data Entry 35
 - Block Recognizer 36
 - Keyboard Utility 35
 - Letter Recognizer 35
 - Transcriber 36
- Display
 - Product Specifications 78

E

- Equipment Warnings 82
- Exploring Files 41

G

- Getting Started Disc 20

K

- Keyboard 24
 - Cleaning 71
 - Diagram 24
 - Shift Keys 25
 - Blue 24
 - Orange 24

M

- Memory 78
- Micro SD Card 30
- Microsoft Website 43

N

- New Battery Detected. *See* Battery Pack

O

- On-device Help 43
- Operating System 78

P

- PC Card 30
- Power Button 24, 26
 - Powering Off 26
 - Resetting the Device 27
 - Restoring Factory State 28
 - Suspending 27
- Product Specifications 78

R

- Regulatory Information 84
- Repairing 76
 - Return Materials Authorization (RMA) 76
- Return Materials Authorization. *See* Repairing

S

- SD Card. *See* PC Card
- Serial Port Pinouts 80
- Soft Keys 38
 - Left 24
 - Right 24
- Software Developers Kit 48
- Start Menu 35
 - Windows Button 24
- Status Icons 37
 - Battery Capacity 37
 - Charge Indicator 37
 - Speaker 37
 - Touch Screen 37
- Stylus 28

T

- Task Manager 42
 - Close Unused Programs 42
 - Switching Between Running Programs 42
- Temperatures
 - Battery Charging 78
 - Charging Battery Pack. *See also* Battery Pack
 - Extreme 82
 - Operating 78
 - Storage 78
- Today Screen 34
- Touch Screen 24, 29
 - Calibrating 29
 - Cleaning 72
 - Disabling 29
 - Protecting 29, 70

U

- USB/Power Dock 16
 - Charging 17
 - LED Indicators 16
 - Power Supply 17
 - USB Communication 18

V

- Vehicle Power 18
 - Vehicle Mode 18

W

- Wi-Fi 64
 - Connecting to Network 64
 - Managing Connections 66
 - Status Icons 64
- Windows Mobile Device Center 21
 - Backing Up Data 45
 - Creating a Connection 21
 - Re-establish Connection 48