

VARO

SAMSUNG POWERED WIFI SPEAKER DOCK





MODEL:CAW-03012

PLEASE READ THIS INSTRUCTION MANUAL CAREFULLY BEFORE
OPERATION AND KEEP IT FOR FUTURE REFERENCE

IMPORTANT SAFETY INSTRUCTIONS

	CAUTION RISK OF ELECTRIC SHOCK DO NOT OPEN	
CAUTION: TO REDUCE THE RISK OF ELECTRIC SHOCK, DO NOT REMOVE COVER (OR BACK). NO USER-SERVICEABLE PARTS INSIDE. REFER SERVICING TO QUALIFIED SERVICE PERSONNEL.		

	The lightning flash with arrowhead symbol, within an equilateral triangle, is intended to alert user to the presence of uninsulated "dangerous voltage" within the product's enclosure, that may be of sufficient magnitude to constitute a risk of electric.
	The exclamation point within an equilateral triangle is intended to alert the user to the presence of important operating and maintenance (servicing) instructions in the literature accompanying the appliance.

FCC Warnings

WARNING: Changes or modifications to this unit not expressly approved by the party responsible for compliance could void the user's authority to operate the equipment.

NOTE: This equipment has been tested and found to comply with the limits for a Class B digital device, pursuant to Part 15 of the FCC Rules. These limits are designed to provide reasonable protection against harmful interference in a residential installation. This equipment generates, uses, and can radiate radio frequency energy and, if not installed and used in accordance with the instructions, may cause harmful interference to radio communications. However, there is no guarantee that interference will not occur in a particular installation. If this equipment does cause harmful interference to radio or television reception, which can be determined by turning the equipment off and on, the user is encouraged to try to correct the interference by one or more of the following measures:

- Reorient or relocate the receiving antenna.
- Increase the separation between the equipment and receiver.
- Connect the equipment into an outlet on a circuit different from that to which the receiver is connected.
- Consult the dealer or an experienced radio/TV technician for help.

FCC NOTICE:

To assure continued compliance, follow the attached installation instructions and use only shielded cables when connecting to other devices. Modifications not authorized by the manufacturer may void user's authority to operate this device.

Before using the unit, be sure to read all operating instructions carefully. Please note that these are general precautions and may not pertain to your unit. For example, this unit may not have the capability to be connected to an outdoor antenna.

- 1. Read these instructions**
All the safety and operating instructions should be read before the product is operated.
- 2. Keep these instructions**
The safety and operating instructions should be retained for future reference.
- 3. Heed all warning**
All warnings on the product and in the operating instructions should be adhered to.
- 4. Follow all instructions**
All operating and use instructions should be followed.
- 5. Do not use this apparatus near water**
Do not use the product near water and moisture, for example: near a bathtub, washbowl, kitchen sink or laundry tub; in a wet basement; or near a swimming pool.
- 6. Clean only with dry cloth**
Unplug this product from the wall outlet before cleaning. Do not use liquid cleaners or aerosol cleaners. Use a dry cloth for cleaning.
- 7. Do not block any ventilation openings. Install in accordance with the manufacturer's instructions.**
Slots and openings in the cabinet and in the back or bottom are provided for ventilation, to ensure reliable operation of the product and to protect it from overheating. These openings must not be blocked or covered. The openings should never be blocked by placing the product on a bed, sofa, rug or other similar surface. This product should never be placed near or over a radiator or heat source. This product should not be placed in a built-in installation such as a bookcase or rack unless proper ventilation is provided or the manufacturer's instructions have been adhered to.
- 8. Do not install near any heat sources such as radiators, heat registers, stoves, or other apparatus (including amplifiers) that produce heat.**
- 9. Do not defeat the safety purpose of the polarized or grounding-type plug. A polarized plug has two blades with one wider than the other. A grounding type plug has two blades and a third grounding prong. The wide blade or the third prong are provided for your safety. If the provided plug does not fit into your outlet, consult an electrician for replacement of the obsolete outlet.**
- 10. Protect the power cord from being walked on or pinched particularly at plugs, convenience receptacles, and the point where they exit from the apparatus.**
- 11. Only use attachments/accessories specified by the manufacturer.**

This equipment complies with FCC radiation exposure limits set forth for an uncontrolled environment.

This equipment should be installed and operated with minimum distance 20cm between the radiator & your body.

FCC ID:OKU-CAW03012.

IMPORTANT SAFETY INSTRUCTIONS

12. Use only with the cart, stand, tripod, bracket, or table specified by the manufacturer, or sold with the apparatus. When a cart is used, use caution when moving the cart/apparatus combination to avoid injury from tip-over.



Portable Cart Warning

13. Unplug this apparatus during lightning storms or when unused for long periods of time.
14. Refer all servicing to qualified service personnel. Servicing is required when the apparatus has been damaged in any way, such as power-supply cord or plug is damaged, liquid has been spilled or objects have fallen into the apparatus, the apparatus has been exposed to rain or moisture does not operate normally, or has been dropped.
15. Power Source
The product should be operated only from the type of power source indicated on the marking label. If you are not sure of the type of power supply to your home, consult your appliance dealer or local power company. For products intended to operate from battery power, or other sources, refer to the operating instructions.
16. Power lines
An outside antenna system should not be located in the vicinity of overhead power lines or other electric light or power circuits, or where it can fall into such power lines or circuits. When installing an outside antenna system, extreme care should be taken to keep from touching such power lines or circuits as contact with them might be fatal.
17. Overloading
Do not overload wall outlets and extension cords as this can result in a risk of fire or electric shock.
18. Object and liquid entry
Never push objects of any kind into the product through as they may touch dangerous voltage points or short out parts that could result in fire or electric shock. Never spill or spray any type of liquid on the product.

19. Outdoor antenna grounding

If an outside antenna is connected to the product, be sure the antenna system is grounded so as to provide some protection against voltage surges and built up static charges.

Section 810 of the National Electrical Code, ANSI/NFPA 70, provides information with respect to proper grounding of the mast and supporting structure, grounding of the lead-in wire to an antenna discharge product, size of grounding conductors, location of antenna discharge product, connection to grounding electrodes and requirements for the grounding electrodes.

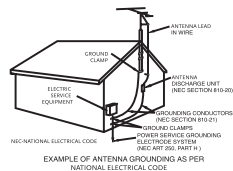

20. Service

Do not attempt to service this product yourself as opening or removing covers may expose you to dangerous voltage or other hazards. Refer all servicing to qualified service personnel.

21. Replacement parts

When replacement parts are required, be sure the service technician uses replacement parts specified by the manufacturer or those that have the same characteristics as the original part. Unauthorized substitutions may result in fire or electric shock or other hazards.

22. Safety check

Upon completion of any service or repairs to this product ask the service technician to perform safety checks to determine that the product is in proper operating condition.

23. Wall or ceiling mounting

The product should be mounted to a wall or ceiling only as recommended by the manufacturer.

24. Damage requiring service

Unplug the product from the wall outlet and refer servicing to qualified service personnel under the following conditions:

- When the power-supply cord or plug is damaged.
 - If liquid has been spilled or objects have fallen into the product.
 - If the product has been exposed to rain or water.
 - If the product does not operate normally by following the operating instructions.
- Adjust only those controls that are covered by the operating instructions, as an adjustment of other controls may result in damage and will require extensive work by a qualified technician to restore the product to its normal operation.
- If the product has been dropped or the cabinet has been damaged.
 - When the product exhibits a distinct change in performance – this indicates a need for service.

25. Note to CATV system installer

This reminder is provided to call the CATV system installer's attention to Article 820-40 of the NEC that provides guidelines for proper grounding and, in particular, specifies that the cable ground shall be connected to the grounding system of the building, as close to the point of cable entry as practical.

Note:

Refer all servicing to qualified service personnel. Servicing is required when the unit has been damaged in any way such as the following: the power-supply cord or plug has been damaged, liquid has been spilled into the unit, the unit has been exposed to rain or moisture, the unit has been dropped or the unit does not operate normally.

LOCATION OF CONTROLS

MAIN UNIT:

TOP VIEW

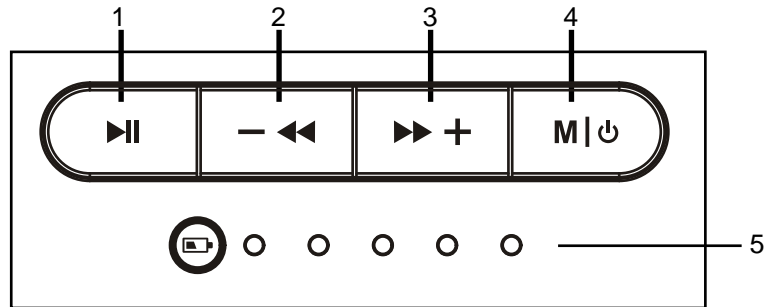

FRONT VIEW

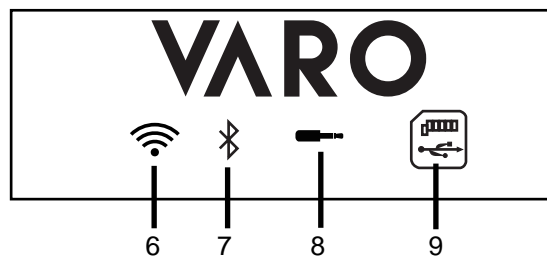

REAR VIEW

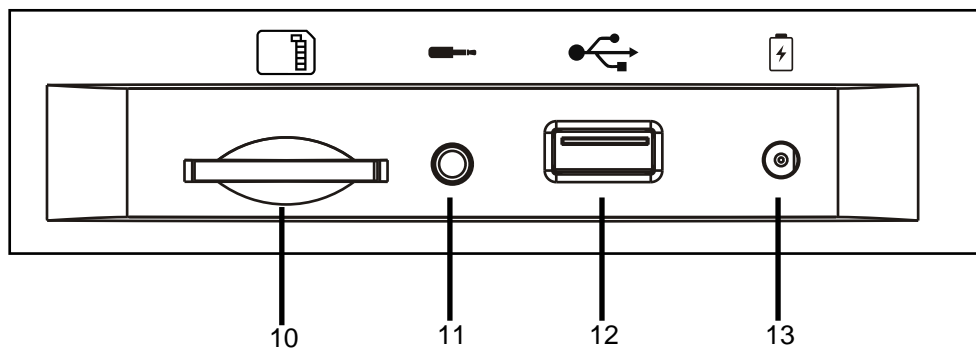

- | | |
|-------------------------------------|---------------------|
| 1. Play/Pause (WiFi Pairing) Button | 8. AUX IN Indicator |
| 2. Previous (Volume Down) Button | 9. SD/USB Indicator |
| 3. Next (Volume Up) Button | 10. SD Card Slot |
| 4. Mode (Power On/Off) Button | 11. AUX IN Jack |
| 5. Battery Indicator | 12. USB Port |
| 6. WiFi Indicator | 13. DC IN Jack |
| 7. Bluetooth Indicator | |

Specification

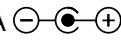
Power supply.....	9.5V  2.2A 
Audio output.....	6WX2+10W (RMS)
Running Time.....	around 3.2 hours(with 50% volume)
Recharging Time.....	around 3 hours
Bluetooth working range.....	32 feet (tested in open area)
Bluetooth version.....	V4.1
WiFi working range.....	approx. 96 feet

Accessories:

- 1 X AC/DC Adapter for the main unit (9.5V, 2.2A)
- 1 X 3.5mm Stereo AUX IN Cable
- 1 X Instruction Manual

RECHARGING

- During playing, press the battery indicator button to display the battery level.



Battery Indicator Button

- The battery indicator will flash blue during low battery level.



Battery Indicator

- Using the supplied Adapter to recharge through the DC IN jack at the rear of the main unit.
- The red indicator will light up when charging, it will turn blue after fully charged.



Battery Indicator

BLUETOOTH OPERATION

Pairing the speaker with Bluetooth devices (phone or music device)

1. Press and hold the **M|🔊** button to turn on the unit.
2. Press the **M|🔊** button repeatedly to turn to Bluetooth mode, the Bluetooth indicator on front of the unit will light up and blink, and a tone sounds, now it is entering pairing mode.
3. Activate the Bluetooth function on your Bluetooth device (phone or music device). Please refer to the manufacturer's instructions of your device.
4. Once you have activated Bluetooth on your device, select the speaker "CAW-03012" from the list of available Bluetooth devices.
5. Once paired successfully, Bluetooth indicator will stop blinking and a tone will be heard.
6. If pairing is unsuccessful, turn off the speaker first and then re-pair following above steps.
7. Once you have paired the speaker with a device, the speaker will remember this device and will pair automatically when the device's Bluetooth is activated and in range.
8. If you want to pair it with a new device, press and hold the **▶||** button to disconnect the current pairing.

During playing:

A: Press the **–◀** or **▶+** button to skip to previous or next track.

B: Press the **▶||** button to pause, press again to resume playing.

C: Press and hold the **–◀** or **▶+** button to decrease or increase the volume.

NOTE:

During playing, please do not insert the AUX IN cable into the AUX IN Jack, or it will switch to AUX IN mode, the AUX IN indicator will light up, it will switch to WiFi mode when unplug the AUX IN cable.

AUX IN OPERATION

1. Connected the external audio device to the unit by an audio connection cable with 3.5mm stereo mini jacks as:
 - ~ Insert one end to the Phone; Line Out or AUX Out Jack on the external audio device.
 - ~ Insert the other end to the AUX IN jack on the rear of the main unit.

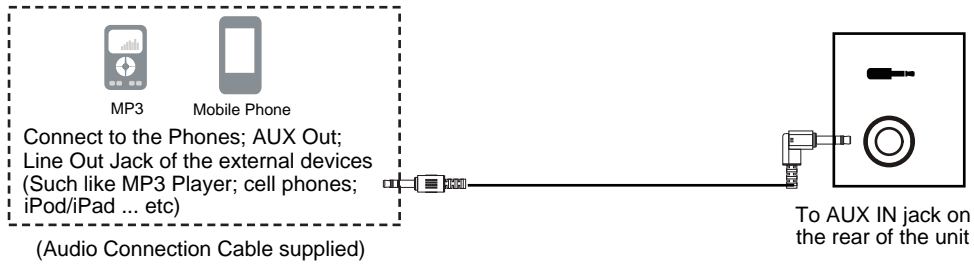

2. Press and hold the **M|⏻** button to turn on the unit.
3. Press the **M|⏻** button repeatedly to turn to AUX IN mode, the AUX IN indicator on front of the unit will light up.
4. Play music as usual on your external device.

NOTE: It will switch to AUX IN mode when AUX IN cable plugged into the AUX IN jack in any other modes(such as WiFi, Bluetooth, USB, SD, OPTICAL).

USB/SD OPERATION

NOTE: Only the USB or SD Card inserted to the unit can the USB/SD mode be selected.
The latter one inserted to the unit will be played first.

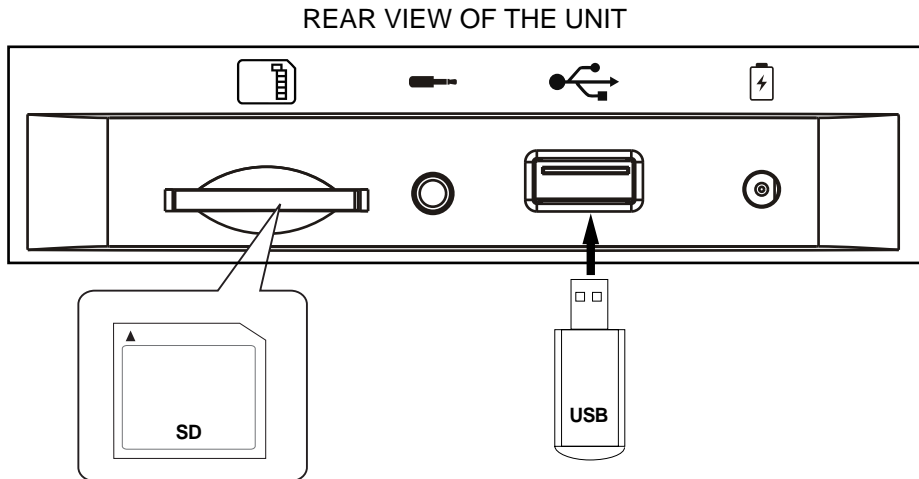

1. Insert the USB device or SD memory card into the USB port/card slot as shown above figure.
2. Press and hold the **M|⏻** button to turn on the unit.
3. Press the **M|⏻** button repeatedly to turn to USB/SD mode, the USB/SD mode indicator on front of the unit will light up.
4. The unit will automatically play the track after a few seconds.

During playing:

- A: Press the **◀◀** or **▶▶** button to skip to previous or next track.
- B: Press the **⏸** button to pause, press again to resume playing.
- C: Press and hold the **◀◀** or **▶▶** button to decrease or increase the volume.

Setup

PREPARATION

- Before connecting the mobile phone with the unit, search the VARO WIFI CONTROLLER from network by the following website:

Android:
<http://fir.im/bvaro>

iOS:
<http://fir.im/varo>



- Download and install the App and set the language of mobile phone to English.
- The App icon will appear like the Fig.1 after successful installation.

NOTE: Please make sure that there is no AUX IN cable plugged in AUX IN jack.

CONNECT THE PHONE WITH THE UNIT

- Press and hold the **M|⏻** button to turn on the unit, the WiFi indicator will light up and blink.
- Activate the WiFi on the phone, search and connect the router (WiFi Source),
- Tap VARO WIFI CONTROLLER icon to activate and it will try to search the devices (Fig.A).
Select the VIBE on Fig.B and tap CONNECT SPEAKER, tap Continue on Fig.C.
- Read the tips on Fig.D and tap NEXT.

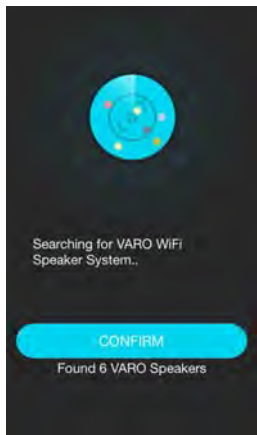

Fig.A



Fig.B



Fig.C

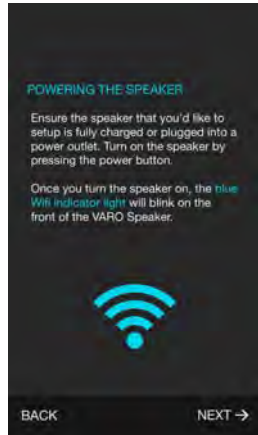

Fig.D

Setup

- Select the same WiFi (router source) as the phone connected and tap LOGIN on Fig.E.
- Press and hold the ► button on the unit as instructed on Fig.F and tap Next to continue.
- Wait until the progress bar reaches 100% as instructed on Fig.G.
- Select to add another speaker or play music after successful connection as Fig.H.



Fig.E



Fig.F

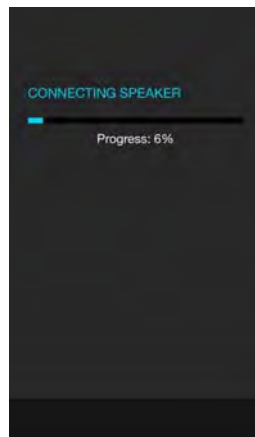

Fig.G

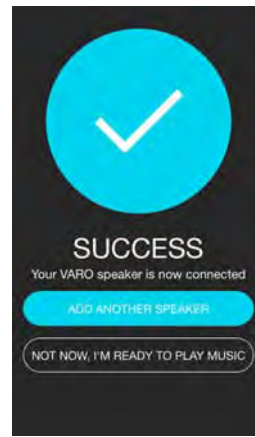

Fig.H

NOTE: There will be voice tone sounding during connection procedure like the following:

- " Searching for Wifi connection "
- " Waiting for Wifi connection "
- " Wifi connected "

Using the screen instructions and the voice tone to make connection and operations.

- After connection completed, it will give instructions like Fig.I and tap Next to continue.
- Read the onscreen instructions on Fig.J, Fig.K, Fig.L and continue.

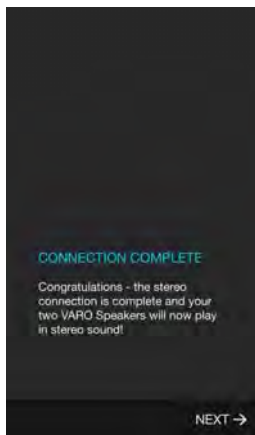

Fig.I

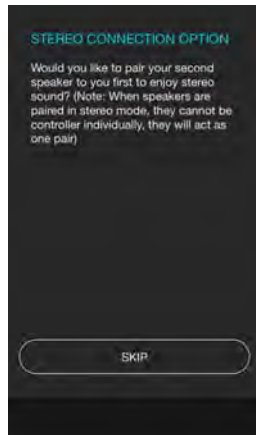

Fig.J



Fig.K

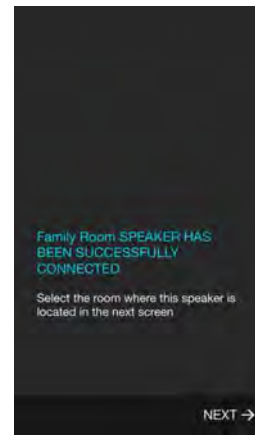

Fig.L

Setup

- Wait until the progress bar reaches 100% as instructed on Fig.G.
If it displays like Fig.M, tap Try Again to repeat the above stated steps to reconnect.
- If it does not fail to connect, continue to set the SPEAKER LOCATION, tap Custom...column on Fig.N to rename the speaker location. Input the name and confirm on Fig.O.

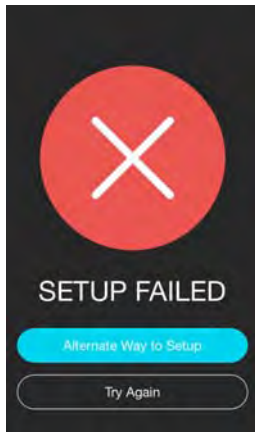

Fig.M

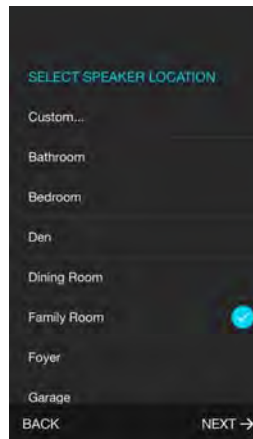

Fig.N

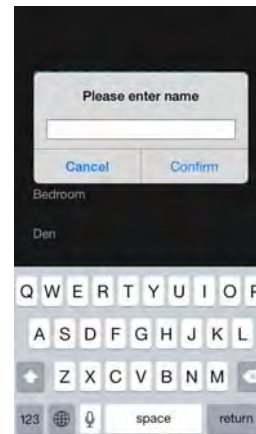

Fig.O

Glance at The Function of Each Icon



- On SPEAKER CONTROLS page (Fig.P), tap  to return to home page. Tap  to Rename, browse the Speaker Info and Preset Content. Tap  Add a New Speaker to add more speaker as onscreen instructions. Tap Pause All to pause playing on all speakers, tap again to resume play all speakers. Tap volume level bar to adjust the volume, tap STEREO icon to set to LEFT channel or RIGHT channel.



Fig.P



Home Page

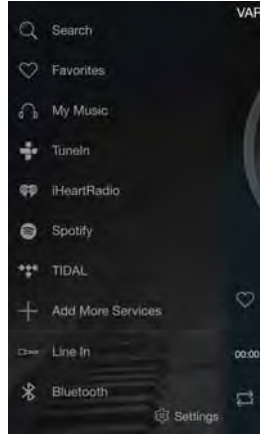
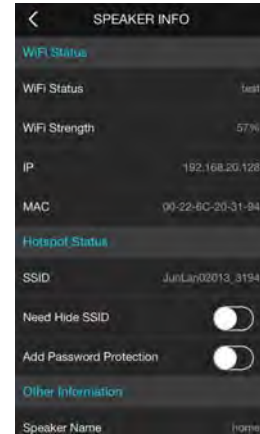
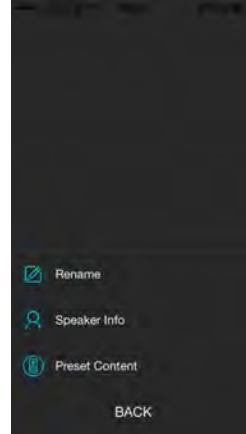

Speaker Info Page

Tap [Pairing Your Speakers?](#) on SPEAKER CONTROLS page to set solo or multi mode. as onscreen instructions like Fig.Q.

Drag down slowly from the top of the SPEAKER CONTROLS page window until the upward arrow head appears then release to update the SPEAKER CONTROLS page, if there is existing connected speaker, it will appear on the SPEAKER CONTROLS page. See Fig.R.



Fig.Q.



Fig.R.

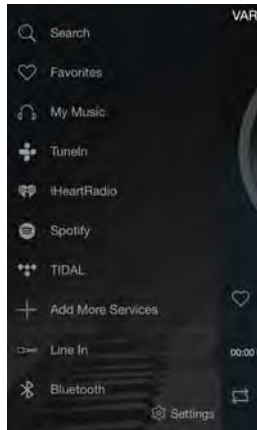

Guide of Using App Functions

- On Home Page, tap Search to search the desired music shown on the below pictures.

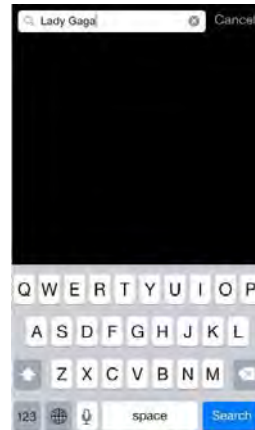
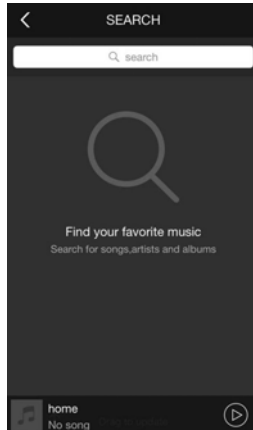

Home Page



- On Home Page, tap Favorites to listen your favorite music, on music playing page, tap the  icon to add songs to My Playlist, tap the  icon to add songs to Favorites.
- On Home Page, tap My Music to listen from native music, My Playlist or Recently Played music.
- On Home Page, tap TuneIn to listen online radio, or other programmes.
- On Home Page, tap iHeartRadio and sign up to listen iHeart radio.

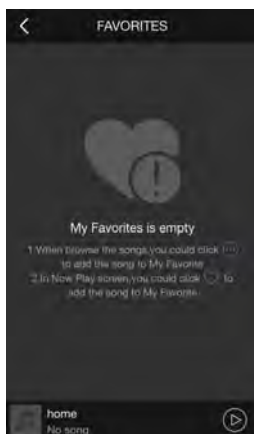

Favorites

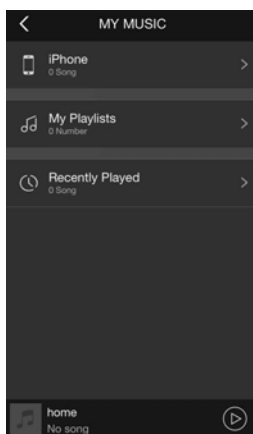

My Music

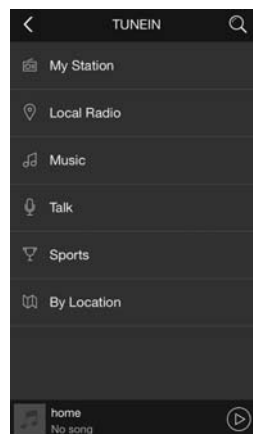

TuneIn

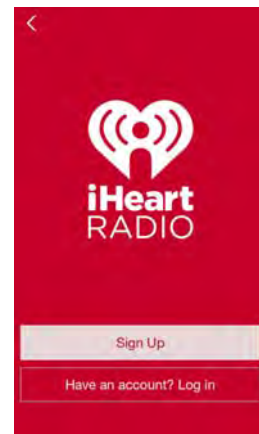

iHeart

Guide of Using App Functions

- On Home Page, tap Sportify to listen music.
- On Home Page, tap Add More Services to add the desired online programs platform.
- Tap Line in, Bluetooth, USB Devices or Optical to switch function mode on Fig.S.
- Tap Settings to check the Version and Feedback information on Fig.T.

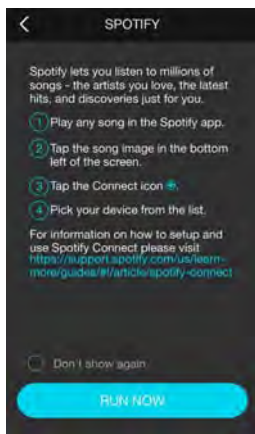

Sportify

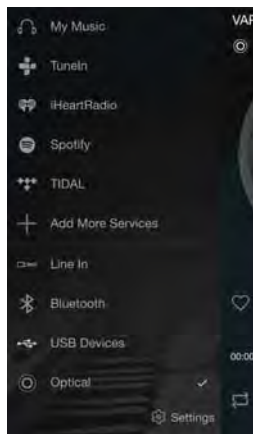

Fig.S

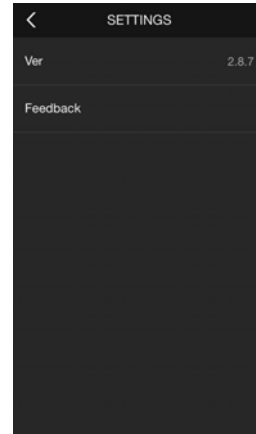

Fig.T

NOTE: Other detail functions like adding, cancel, delete, manage...customize, etc. can be operated according to the onscreen instructions.

FAQ

Q: Can't stream music to the device?

A: Make sure your phone or PAD are in the same Wi-Fi network as your device. If you use 3rd. music APP, please check if the APP supports Airplay, DLNA or Qplay protocol.

Q: Can the APP system be controlled independently by two different phones/tablets at the same time or can it only be controlled with one?

A: It can be controlled by different phones / tablets.

Q: Can I play my MP3 music collection on the iPhone?

A: Yes. You just have to install the controller app on the iPhone. In the app, you will see an option to play music on "This iPhone".

Q: What kinds of music format does it support?

A: Most of the format is available. Such as MP3, WMA, AAC (AAC+), Apple lossless, FLAC, APE, etc.

Q: Does it support multi-room playback?

A: Yes. Playback the same song in multiple speakers with minimal latency (less than 5 ms) or different songs in multiple speakers with one App.

Q: Does the wireless transmission have loss of sound quality?

A: No. Your mobile devices or other devices just send control instructions, and the adapter will download songs metadata, decoding it and then playback in local speaker, so there is no loss of the music quality through wireless transmission.

Q: Does it support R&L channel?

A: Yes, this is supported. You can find the sign in APP.