

IB Size: 105.5 x 210mm (A5)

CRAIG®



**32 INCH
STEREO SOUND BAR**
with Bluetooth® Wireless Technology



Owner's Manual

PLEASE READ BEFORE OPERATING THIS EQUIPMENT.

Model:CHT939

IMPORTANT SAFETY INSTRUCTIONS

	CAUTION RISK OF ELECTRIC SHOCK DO NOT OPEN	
CAUTION: TO REDUCE THE RISK OF ELECTRIC SHOCK, DO NOT REMOVE COVER (OR BACK). NO USER-SERVICEABLE PARTS INSIDE. REFER SERVICING TO QUALIFIED SERVICE PERSONNEL.		

	The lightning flash with arrowhead symbol, within an equilateral triangle, is intended to alert user to the presence of uninsulated "dangerous voltage" within the product's enclosure, that may be of sufficient magnitude to constitute a risk of electric.
	The exclamation point within an equilateral triangle is intended to alert the user to the presence of important operating and maintenance (servicing) instruction in the literature accompanying the appliance.

FCC Warnings

WARNING: Changes or modifications to this unit not expressly approved by the party responsible for compliance could void the user's authority to operate the equipment.

This device complies with Part 15 of the FCC rules. Operation is subject to the following two conditions: 1) this device may not cause harmful interference, and 2) this device must accept any interference received, including interference that may cause undesired operation.

NOTE: This equipment has been tested and found to comply with the limits for a Class B digital device, pursuant to Part 15 of the FCC Rules. These limits are designed to provide reasonable protection against harmful interference in a residential installation. This equipment generates, uses, and can radiate radio frequency energy and, if not installed and used in accordance with the instructions, may cause harmful interference to radio communications. However, there is no guarantee that interference will not occur in a particular installation. If this equipment does cause harmful interference to radio or television reception, which can be determined by turning the equipment off and on, the user is encouraged to try to correct the interference by one or more of the following measures:

- Reorient or relocate the receiving antenna.
- Increase the separation between the equipment and receiver.
- Connect the equipment into an outlet on a circuit different from that to which the receiver is connected.
- Consult the dealer or an experienced radio/TV technician for help.

FCC NOTICE:

To assure continued compliance, follow the attached installation instructions and use only shielded cables when connecting to other devices. Modifications not authorized by the manufacturer may void user's authority to operate this device.

Before using the unit, be sure to read all operating instructions carefully. Please note that these are general precautions and may not pertain to your unit. For example, this unit may not have the capability to be connected to an outdoor antenna.

1. Read these instructions

All the safety and operating instructions should be read before the product is operated.

2. Keep these instructions

The safety and operating instructions should be retained for future reference.

3. Heed all warning

All warnings on the product and in the operating instructions should be adhered to.

4. Follow all instructions

All operating and use instructions should be followed.

5. Do not use this apparatus near water

Do not use the product near water and moisture, for example: near a bathtub, washbowl, kitchen sink or laundry tub; in a wet basement; or near a swimming pool.

6. Clean only with dry cloth

Unplug this product from the wall outlet before cleaning. Do not use liquid cleaners or aerosol cleaners. Use a dry cloth for cleaning.

7. Do not block any ventilation openings. Install in accordance with the manufacturer's instructions.

Slots and openings in the cabinet and in the back or bottom are provided for ventilation, to ensure reliable operation of the product and to protect it from overheating. These openings must not be blocked or covered. The openings should never be blocked by placing the product on a bed, sofa, rug or other similar surface. This product should never be placed near or over a radiator or heat source. This product should not be placed in a built-in installation such as a bookcase or rack unless proper ventilation is provided or the manufacturer's instructions have been adhered to.

8. Do not install near any heat sources such as radiators, heat registers, stoves, or other apparatus (including amplifiers) that produce heat.

9. Do not defeat the safety purpose of the polarized or grounding-type plug. A polarized plug has two blades with one wider than the other. a grounding type plug has two blades and a third grounding prong, the wide blade or the third prong are provided for your safety. if the provided plug does not fit into your outlet, consult an electrician for replacement of the obsolete outlet.

10. Protect the power cord from being walked on or pinched particularly at plugs, convenience receptacles, and the point where they exit from the apparatus.

11. Only use attachments/accessories specified by the manufacturer.

- 12. Use only with the cart, stand, tripod, bracket, or table specified by the manufacturer, or sold with the apparatus. When a cart is used, use caution when moving the cart/apparatus combination to avoid injury from tip-over.**



Portable Cart Warning

- 13. Unplug this apparatus during lightning storms or when unused for long periods of time.**
- 14. Refer all servicing to qualified service personnel. Servicing is required when the apparatus has been damaged in any way, such as power-supply cord or plug is damaged, liquid has been spilled or objects have fallen into the apparatus, the apparatus has been exposed to rain or moisture does not operate normally, or has been dropped.**

- 15. Power Source**
The product should be operated only from the type of power source indicated on the marking label. If you are not sure of the type of power supply to your home, consult your appliance dealer or local power company. For products intended to operate from battery power, or other sources, refer to the operating instructions.

- 16. Power lines**
An outside antenna system should not be located in the vicinity of overhead power lines or other electric light or power circuits, or where it can fall into such power lines or circuits. When installing an outside antenna system, extreme care should be taken to keep from touching such power lines or circuits as contact with them might be fatal.

- 17. Overloading**
Do not overload wall outlets and extension cords as this can result in a risk or fire or electric shock.

- 18. Object and liquid entry**
Never push objects of any kind into the product through as they may touch dangerous voltage points or short out parts that could result in fire or electric shock. Never spill or spray any type of liquid on the product.

- 19. Outdoor antenna grounding**
If an outside antenna is connected to the product, be sure the antenna system is grounded so as to provide some protection against voltage surges and built up static charges.

Section 810 of the National Electrical Code, ANSI/NFPA 70, provides information with respect to proper grounding of the mast and supporting structure, grounding of the lead-in wire to an antenna discharge product, size of grounding conductors, location of antennadischarge product, connection to grounding electrodes and requirements for the grounding electrodes.

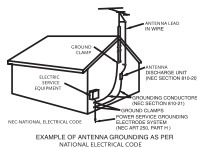

- 20. Service**
Do not attempt to service this product yourself as opening or removing covers may expose you to dangerous voltage or other hazards. Refer all servicing to qualified service personnel.

- 21. Replacement parts**
When replacement parts are required, be sure the service technician uses replacement parts specified by the manufacturer or those that have the same characteristics as the original part. Unauthorized substitutions may result in fire or electric shock or other hazards.

- 22. Safety check**
Upon completion of any service or repairs to this product ask the service technician to perform safety checks to determine that the product is in proper operating condition.

- 23. Wall or ceiling mounting**
The product should be mounted to a wall or ceiling only as recommended by the manufacturer.

- 24. Damage requiring service**
Unplug the product from the wall outlet and refer servicing to qualified service personnel under the following conditions:
- When the power-supply cord or plug is damaged.
 - If liquid has been spilled or objects have fallen into the product.
 - If the product has been exposed to rain or water.
 - If the product does not operate normally by following the operating instructions.

Adjust only those controls that are covered by the operating instructions, as an adjustment of other controls may result in damage and will require extensive work by a qualified technician to restore the product to its normal operation.

- If the product has been dropped or the cabinet has been damaged.
- When the product exhibits a distinct change in performance – this indicates a need for service.

- 25. Note to CATV system installer**
This reminder is provided to call the CATV system installer's attention to Article 820-40 of the NEC that provides guidelines for proper grounding and, in particular, specifies that the cable ground shall be connected to the grounding system of the building, as close to the point of cable entry as practical.

Note:
Refer all servicing to qualified service personnel. Servicing is required when the unit has been damaged any way such as the following: the power-supply cord or plug has been damaged, liquid has been spilled into the unit, the unit has been exposed to rain or moisture, the unit has been dropped or the unit does not operate normally.

POWER SOURCE

1. Insert the plug from the supplied AC/DC adaptor to the DC In Jack on the top of unit.
2. Insert the small plug from the supplied AC Power Cord to the AC In Jack on the AC/DC Adaptor.
3. Insert the AC Plug from the supplied to the wall outlet Having AC 100-240V~; 50/60Hz.

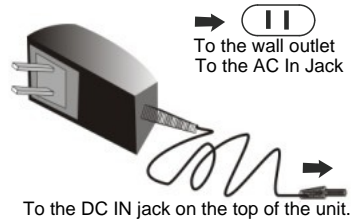

NOTE:

If Long period of time will not use the unit, unplug the AC Cord from the wall outlet.

INSTALLATION

1. Placing on the table

When placing the Sound Bar on an entertainment center, bookshelf, or any type of enclosed space, be sure to allow at least 2-3 inches of space around the Sound Bar for ventilation. If the Sound Bar is enclosed in a tight space, without ventilation, heat generated from the Sound Bar could produce a potential heat hazard.

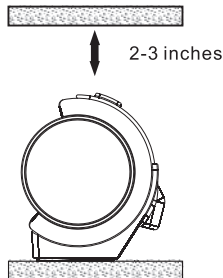

2. Mounting the Speaker Bar onto a wall

We recommend having this speaker professionally mounted. By using the included wall mounting accessories, the sound bar can be mounted onto a wall.

Distance Between Two Brackets

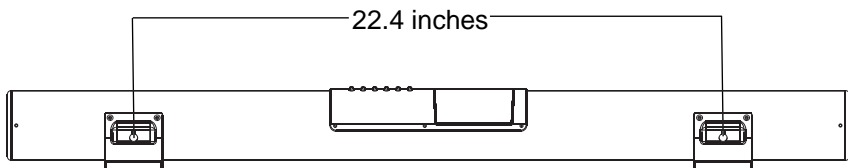

2.1 Mounting on the wooden wall

You may use

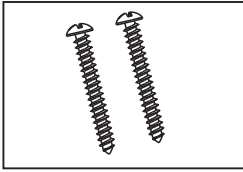

2 pieces screws
(Included)

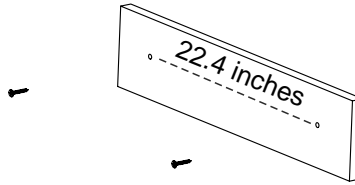

1. Mark the position of the mounting screws on the wall using a pencil.
2. Drill the supplied screws directly into the marks that you have made on the wall and leave approx. 0.3 inch length to hook the sound bar.
3. Put the sound bar onto the mounting screws. Make sure they are firm and stable.

2.2 Mounting on the wall

You may use

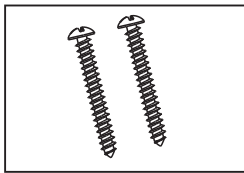

2 pieces screws
(Included)

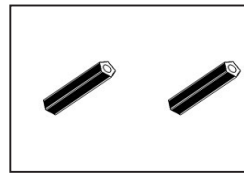

2 pieces plastic inserts
(Included)

1. Mark the position of the mounting screws on the wall using a pencil.
2. Drill 2 x 7/32 inch diameter holes by a powerful electric drill (Not Supplied).
3. Insert the supplied plastic inserts into the holes by hammer (Not Supplied).
4. Secure the supplied screws into the plastic insert and leave approx. 0.3 inch length to hook the sound bar.
5. Put the sound bar onto the mounting screws. Make sure they are firm and stable.

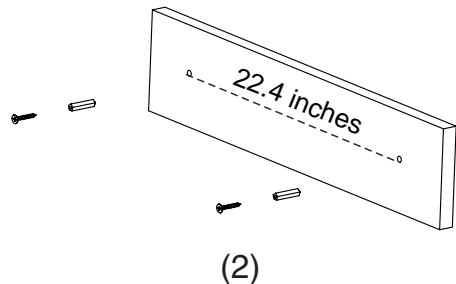
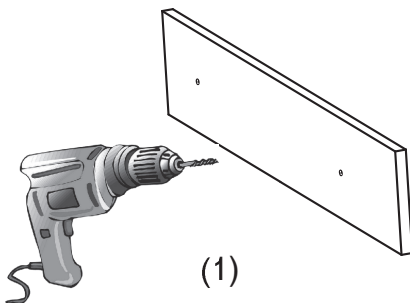

LOCATION OF CONTROLS

Front View

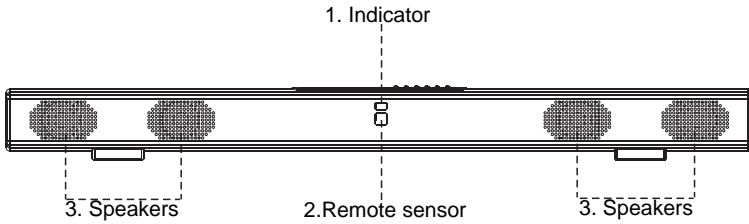

Top View

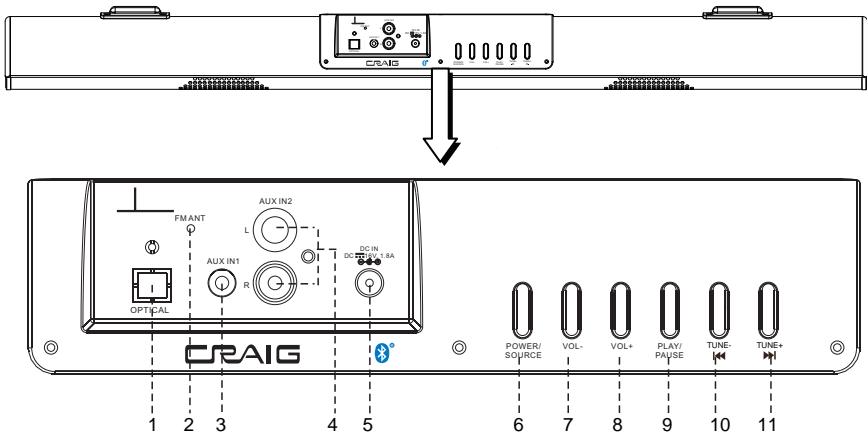

1. OPTICAL (Optical In Jack)
2. FM ANT (FM Antenna)
3. AUX IN 1 jack
4. AUX IN 2 jacks
5. DC IN jack
6. POWER/SOURCE button

7. VOL- (Volume Down) button
8. VOL+ (Volume Up) button
9. PLAY/PAUSE button
10. TUNE- / ⏮ (Skip Backward) button
11. TUNE+ / ⏭ (Skip Forward) button

LOCATION OF CONTROLS - REMOTE CONTROL

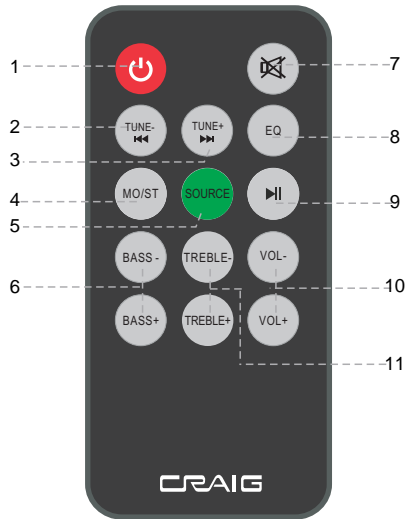

1. Power ON/OFF button
2. TUNE-/ (Skip Backward) button
3. TUNE+/ (Skip Forward) button
4. MO/ST (Mono/Stereo) button
5. SOURCE button

6. BASS +/- buttons
7. (Mute) button
8. EQ (Equalizer) button
9. (Play/Pause) button
10. VOL (Volume) +/- buttons
11. TREBLE +/- buttons

BATTERIES INSTALLATION (REMOTE CONTROL)

- First Time Use

Remove and discard the insulation tab as figure on the right.

- If the battery is consume, replace it as below:

1. Push and slide out the battery holder as figure 1 below.
2. Replace the battery with a new CR2025 button cell as the polarity markings on the rear of the Remote Control.
3. Close the battery holder.

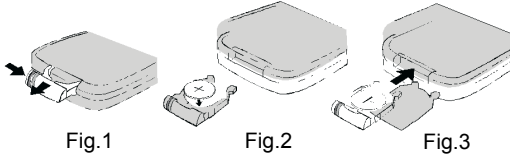

BATTERY PRECAUTIONS

Folloe these precautions when using a battery in this device:

1. Use only the size and type of battery specified.
2. Be sure to follow the correct polarity when installing the battery as indicated in the battery compartment. A reversed battery may cause damage to the device.
3. Do not mix different types of batteries together (e.g. Alkaline and Carbon-zinc) or old batteries with fresh ones.
4. If the batteries in the device are consumed or device is not to be used for a long period of time, remove the batteries to prevent damage or injury from possible battery leakage.
5. Do not try to recharge the battery not intended to be recharged; it can overheat and rupture. (Follow battery manufacturer's instructions.)
6. The batteries shall not be exposed to excessive heat such as sunshine, fire or the like.
7. Clean the battery contacts and also those of the device prior to battery installation.
8. This product contains a coin/button cell battery. If the coin/button cell battery is swallowed, it can cause severe internal burn in just 2 hours and can lead to death. Keep new and used batteries away from children. If the battery compartment does not close securely, stop using the product and keep it away from children. If you think batteries might have been swallowed or placed inside any part of the body, seek immediate medical attention.

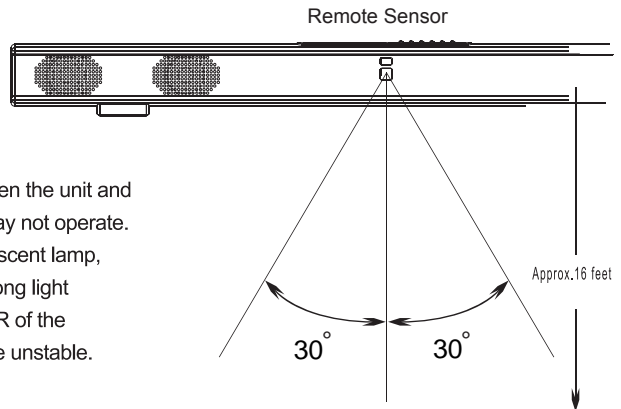

EFFECTIVE DISTANCE OF REMOTE TRANSMITTER







NOTES:

- When there is an obstacle between the unit and the transmitter, the transmitter may not operate.
- When direct sunlight, an incandescent lamp, fluorescent lamp or any other strong light shines on the REMOTE SENSOR of the unit, the remote operation may be unstable.

GENERAL OPERATIONS

1. Connect the AC/DC adapter to the unit and wall outlet as the previous procedure. The Red Indicator will light.
2. Press the POWER/SOURCE button on the unit or press the  Power button on the remote control to power on the unit from standby mode. The color of the Indicator will turn to correspondence color.
3. Press the POWER/SOURCE button on the unit or press SOURCE button on the remote control repeatedly to switch to desired mode, the color of the Indicator will turn to:
Blue----- Bluetooth
Purple----- FM Radio
Green----- AUX IN 1
Yellow----- AUX IN 2
Cyan----- Optical
4. During Playback:
 - ~ Press the VOL (Volume) + or - buttons to adjust volume level as desired.
 - ~ Press the EQ button repeatedly to select and set equalizer mode as desired.
(To reset the EQ to normal mode; power off the unit then power on again)
 - ~ Press the  (Mute) button to turn off the sound. Press again to resume.
 - ~ Press the BASS +/- buttons to adjust the sound level of bass.
 - ~ Press the TREBLE +/- buttons to adjust the sound level of treble.
5. When finished listening, press and hold the POWER/SOURCE button on the unit or press the  button on the remote control to power off (Standby mode) the unit.
6. If long period of time will not use the unit, unplug the AC/DC Adaptor from the wall outlet.

LISTEN TO FM RADIO

1. Connect the Sound Bar to the power as previous procedures.
2. Press the POWER/SOURCE button on the unit or the  button on the remote control to power on the unit.
3. Press the POWER/SOURCE button on unit or press the SOURCE button on the remote control repeatedly until the color of the Indicator turns to Purple.
4. Press and hold the TUNE - /  or TUNE + /  buttons until the Indicator start blinking to search and plays the searched available FM station.
5. Press and release the TUNE - /  or TUNE + /  buttons repeatedly to fine tune.
6. If the available FM station is stereo, the unit will play it in stereo mode automatically. If the reception is no good, press the MO/ST button on the remote control to switch it to Mono mode. Press again to turn back to Stereo mode.

FM Antenna

The Antenna wire on the top of the unit is for radio reception. If reception is weak, unwind and extend the wire or relocate the wire to improve the radio reception.

BLUETOOTH PAIRING AND PLAYBACK

Blue tooth

In first time use or re-pairing to new BT Device, pairing the unit to the external BT Device as follows:

1. Power on the unit as previous procedures.
2. Press the POWER/SOURCE button on the unit or press the SOURCE button on the remote control repeatedly until the color of the Indicator turns to Blue.
3. Power on the external BT Device and enter to searching mode. Start pairing as the on screen instructions on the external BT Device. After paired, The Indicator will stop blinking.
(For details pairing procedures, please refer to the user's manual of your BT Device.)

Notes:

1. When the external BT Device searched the unit, our model number " CHT939 " will appear on the display of external BT Device.
2. Pairing code "0000" or "1234" may need to enter.

Normal operation after paired:

1. Power on the unit and selected the playback source to BT as previous procedures.
2. Turn on the BT function of the external BT Device.
3. Wait a few seconds until the unit paired to the external BT Device automatically. The Blue indicator stop blinking.
4. Play the music in the connected BT Device as usual.
5. During playback:
 - ~ Press the TUNE -/⏮ or TUNE +/⏭ buttons to skip the tracks.
 - ~ Press the PLAY/PAUSE button on the unit or ⏸ button on the remote control to pause. Press again to resume normal playback.

AUX IN 1 : LISTEN TO EXTERNAL AUDIO DEVICES

1. Connect the Headphone/Earphone; Aux out jack or Line out jack from the external audio player (such like MP3 player; Discman ... etc) to the AUX IN 1 jack on the top of unit by the supplied Audio Connection Cable as the figure below:

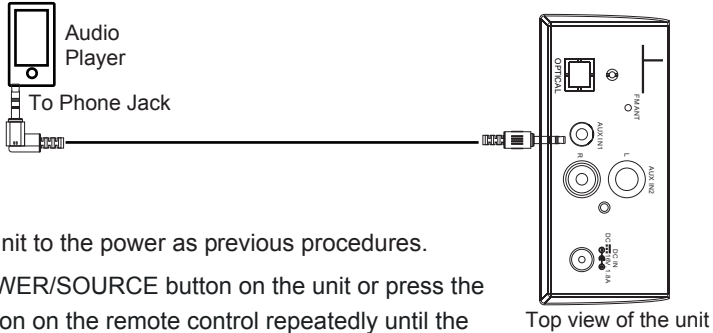

2. Connect the unit to the power as previous procedures.
3. Press the POWER/SOURCE button on the unit or press the SOURCE button on the remote control repeatedly until the color of the Indicator turns to Green.
4. Power on the connected external player and start playback music as usual.

AUX IN 2 : LISTEN TO TV/DVD/VCR/DVR

1. Connect the Aux out jacks from the external audio player (such like TV, DVD player, VCR ...etc.) to the AUX IN 2 jacks on the top of unit by the RCA Connection Cable as the figure below:

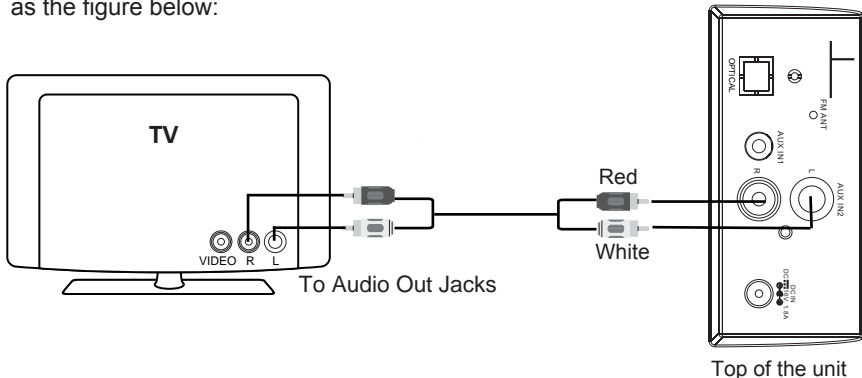

2. Connect the Sound Bar to the power as previous procedures.
3. Press the POWER/SOURCE button on the unit or press the SOURCE button on the remote control repeated until the Indicator turns to Yellow.
4. Power on the connected external player and start playback the Video/Music as usual.

OPTICAL IN

1. Connect the Optical out jack from the external audio player (such like TV, DVD VCR ...etc.) to the OPTICAL jack on the top of unit by the Optical Connection Cable as the figure below: (For PCM format only)

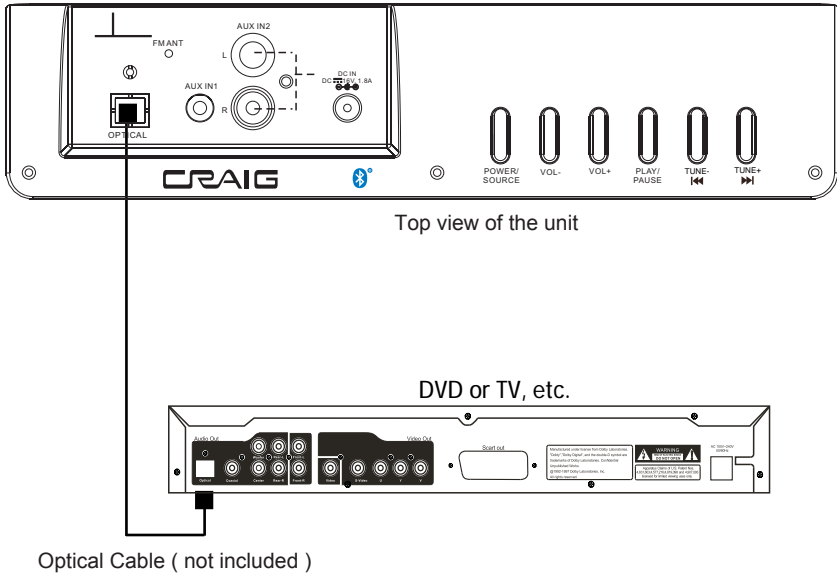

2. Connect the Sound Bar to the power as previous procedures.
3. Press the POWER/SOURCE button on the unit or press the SOURCE button on the remote control repeated until the Indicator turns to Cyan.
4. Power on the connected external player and start playback the Music as usual.

TROUBLESHOOTING GUIDE

Check the followings before requesting service		
SYMPTOM	POSSIBLE CAUSE	POSSIBLE SOLUTION
No power	Power AC/DC adapter not connected	Connect the power AC/DC adapter.
	The unit is in Standby mode	Press the  button to turn on the unit.
No sound	Volume in minimum position	Raise volume level by pressing the VOL (Volume) + button.
	The paired/connected device is not in playback mode	Play music/movie in the paired/connected device as usual and make sure the volume level of it is in high level.
	Input source incorrect	Press the POWER/SOURCE button on the unit or press SOURCE on the remote control repeatedly to set the input source to the desired mode.
Sound distortion	Bass level of the connected device too high	Reduce the bass level of the connected device.
		Press the BASS - button on the Sound Bar to reduce bass level.
	Volume level too high	Reduce the volume level by pressing the VOL (Volume) - button.
		Reduce the volume level of the paired/connected device.
Remote not working	The battery is consumed	Replace with new battery.
Poor FM reception		Relocate and unwind the FM antenna wire.
Bluetooth reception failure	The external device is far from the unit	Put the external BT device close to the unit.
	Have not paired	Pair the unit with the BT Device as the procedures on page 9.

GENERAL SPECIFICATIONS

Power Source..... DC \equiv 16V; 1.8A, \ominus \oplus

Radio Coverage.....FM 87.5-108 MHz

Impedance of Speakers:

Loud Speakers 8 Ohm, 10 W x 2

Audio Power:

Loud Speakers:10 W (RMS) x 2

Total:.....20W

Bluetooth Effective Range in Open Area.....Up to 32 feet

Remote Effective Range.....Up to 16 feet

Accessories:

1 x AC/DC Adaptor (Input: AC 100-240V~; 50/60Hz; 1A. Output: DC \equiv 16V; 1.8 A, \ominus \oplus)

1 x Remote Control, using CR 2025 button cell (Included, already installed in remote control)

1 x Stereo Audio Connection Cable with 3.5mm stereo plugs

1 x User's Manual

2 x Plastic Inserts (For Wall Mount)

2 x Metallic Screws (For Wall Mount)

LIMITED WARRANTY

Craig warrants this product to be free from manufacturing defects in material and workmanship under normal use for a period of 90 days from date of purchase. If service is required, please return the product to the store where it was purchased for exchange; or, pack the unit in the original packing material with all accessories if applicable, a copy of your sales receipt and a Cashier's check or Money Order for \$15.00 (to cover shipping and handling costs) payable to Craig Electronics Inc. For consumers in Canada, please make sure that the cashier check or money order is redeemable through a U.S. bank. Ship your product freight pre-paid. Your unit will be repaired, replaced or if the unit can not be repaired or replaced, a refund will be forwarded to you within four weeks of receipt of your unit. Please ship your unit to:

Craig Electronics Inc.
1160 NW 163 Drive
Miami, FL 33169

This warranty is void if the product has been: a) Used in a commercial application or rental. b) Damaged through misuse, negligence, or abuse. c) Modified or repaired by anyone other than an authorized Craig service center. d) Damaged because it is improperly connected to any other equipment.

Note: This warranty does not cover: a) Ordinary adjustments as outlined in the Owner's Manual which can be performed by the customer. b) Damage to equipment not properly connected to the product. c) Any cost incurred in shipping the product for repair. d) Damage to the product not used in the USA.

This warranty is not transferable and only applies to the original purchase. Any implied warranties, including the warranty of merchantability, are limited in duration to the period of this expressed warranty and no warranty whether expressed or implied shall apply to the product thereafter.

Under no circumstance shall Craig be liable for any loss or consequential damage arising out of the use of this product. This warranty gives specific legal rights. However, you may have other rights which may vary from state to state. Some states do not allow limitations on implied warranties or exclusion of consequential damage. Therefore, these restrictions may not apply to you.

To Obtain Service on your Product
email: service@craigelectronics.com