



USER'S GUIDE
V: 811-01



ITB123B Bluetooth Tower Speaker

For the most up-to-date version of this User's Guide, go to www.iLiveElectronics.com

Warnings and Precautions

CAUTION: TO PREVENT ELECTRIC SHOCK, MATCH WIDE BLADE OF PLUG TO WIDE SLOT, FULLY INSERT.

WARNING: To reduce the risk of fire or electric shock, do not expose this apparatus to rain or moisture.

AVERTISSEMENT: Pour réduire le risque d'incendie ou de choc électrique, ne pas exposer cet appareil sous la pluie et l'humidité.

CAUTION: Use of any controls or adjustments or performance of procedures other than those herein specified may result in hazardous radiation exposure.

WARNING: Changes or modifications to this unit not expressly approved by the party responsible for compliance could void the user's authority to operate the equipment.

WARNING: Do not place this unit directly onto furniture surfaces with any type of soft, porous, or sensitive finish. As with any rubber compound made with oils, the feet could cause marks or staining where the feet reside. We recommend using a protective barrier such as a cloth or a piece of glass between the unit and the surface to reduce the risk of damage and/or staining.

WARNING: Use of this unit near fluorescent lighting may cause interference regarding use of the remote. If the unit is displaying erratic behavior move away from any fluorescent lighting, as it may be the cause.

CAUTION: Danger of explosion if battery is incorrectly replaced. Replace only with the same or equivalent type.

PRÉCAUTION: *Danger d'explosion si les piles sont remplacées de façon incorrect. Remplacer les piles seulement par le même type de pile ou l'équivalent.*

WARNING: The battery, batteries, and battery pack shall not be exposed to excessive heat such as sunshine, fire, or the like.

WARNING: Lithium batteries, like all rechargeable batteries are recyclable and should be recycled or disposed of in normal household waste. Contact your local government for disposal or recycling practices in your area. They should never be incinerated since they might explode.

WARNING: Shock hazard - Do Not Open.

AVIS: *RISQUE DE CHOC ÉLECTRIQUE - NE PAS OUVRIR*

Mains Plug or Direct plug-in adapter is used as disconnect device and it should remain readily operable during intended use. In order to disconnect the apparatus from the mains completely, the Mains Plug or Direct plug-in adapter should be disconnected from the mains socket outlet completely.

La fiche d'alimentation ou adaptateur de courant est utilisé comme dispositif de déconnexion et doit rester accessible pendant l'utilisation. Pour mettre l'appareil hors tension, la fiche ou adaptateur de courant doit être débranché de la prise de courant.



WARNING: TO REDUCE THE RISK OF ELECTRIC SHOCK, DO NOT REMOVE COVER (OR BACK). NO USER-SERVICEABLE PARTS INSIDE. REFER SERVICING TO QUALIFIED SERVICE PERSONNEL.



The lightning flash with arrowhead symbol, within an equilateral triangle, is intended to alert the user to the presence of uninsulated "dangerous voltage" within the product's enclosure that may be of sufficient magnitude to constitute a risk of electric shock to persons.



The exclamation point within an equilateral triangle is intended to alert the user to the presence of important operating and maintenance (servicing) instructions in the literature accompanying the appliance.

Important Safety Instructions

1. Read these Instructions.
2. Keep these Instructions.
3. Heed all Warnings.
4. Follow all instructions.
5. Do not use this apparatus near water.
6. Clean only with a dry cloth.
7. Do not block any ventilation openings. Install in accordance with the manufacturer's instructions.
8. Do not install near any heat sources such as radiators, heat registers, stoves, or other apparatus (including amplifiers) that produce heat.
9. Do not defeat the safety purpose of the polarized or grounding - type plug. A polarized plug has two blades with one wider than the other. A grounding type plug has two blades and a third grounding prong. The wide blade or the third prong are provided for your safety. When the provided plug does not fit into your outlet, consult an electrician for replacement of the obsolete outlet.
10. Protect the power cord from being walked on or pinched particularly at plugs, convenience receptacles, and the point where they exit from the apparatus.
11. Only use attachments/accessories specified by the manufacturer.



12. Use only with a cart, stand, tripod, bracket, or table specified by the manufacturer, or sold with the apparatus. When a cart is used, use caution when moving the cart/apparatus combination to avoid injury from tip-over.

13. Unplug this apparatus during lightning storms or when unused for long periods of time.
14. Refer all servicing to qualified service personnel. Servicing is required when the apparatus has been damaged in any way, such as power-supply cord or plug is damaged, liquid has been spilled or objects have fallen into the apparatus, the apparatus has been exposed to rain or moisture, does not operate normally, or has been dropped.

Special note: When placing your unit on a lacquered or natural finish, protect your furniture with a cloth or other protective material.

FCC Warnings

WARNING: Changes or modifications to this unit not expressly approved by the party responsible for compliance could void the user's authority to operate the equipment.

NOTE: This equipment has been tested and found to comply with the limits for a Class B digital device, pursuant to Part 15 of the FCC Rules. These limits are designed to provide reasonable protection against harmful interference in a residential installation. This equipment generates, uses, and can radiate radio frequency energy and, if not installed and used in accordance with the instructions, may cause harmful interference to radio communications. However, there is no guarantee that interference will not occur in a particular installation. If this equipment does cause harmful interference to radio or television reception, which can be determined by turning the equipment off and on, the user is encouraged to try to correct the interference by one or more of the following measures:

- Reorient or relocate the receiving antenna.
- Increase the separation between the equipment and receiver.
- Connect the equipment into an outlet on a circuit different from that to which the receiver is connected.
- Consult the dealer or an experienced radio/TV technician for help.

Additional Warnings

The apparatus shall not be exposed to dripping or splashing and that no objects filled with liquids, such as vases, shall be placed on apparatus.

L'appareil ne doit pas être exposé aux écoulements ou aux éclaboussures et aucun objet ne contenant de liquide, tel qu'un vase, ne doit être placé sur l'objet.

Battery shall not be exposed to excessive heat such as sunshine, fire or the like.

Les piles ne doivent pas être exposées à de forte chaleur, tel qu'à la lumière du soleil, au feu ou autres choses de semblable.

Caution marking is located at the rear or bottom of the apparatus.

Attention marquage est situé sur le panneau arrière ou inférieur de l'unité.

The marking information is located at the rear or bottom of apparatus.

Le marquage est situé sur le panneau arrière ou inférieur de l'unité.



This symbol indicates that this product incorporates double insulation between hazardous mains voltage and user accessible parts.

ITB123B

Features

- Supports Enhanced Data Rate (EDR)
- Supports profile A2DP (Advanced Audio Distribution Profile)
- Negative LCD display
- Built-in FM wire antenna
- Station memory presets (20 FM)
- Bass controls
- Treble controls
- Supports Bluetooth v3.0
- Digital volume control
- Digital FM radio (PLL)
- Remote
- 3.5mm audio input
- LED pairing indicator
- Wireless range: 33 feet
- Built-in stereo speakers
- AC power: built in AC power cord.

Includes

- Remote control: requires a CR2025 battery (pre-installed)
- RCA stereo audio cable
- Wooden stand and mounting screws

Setup

Power

AC power: built in AC power cord.

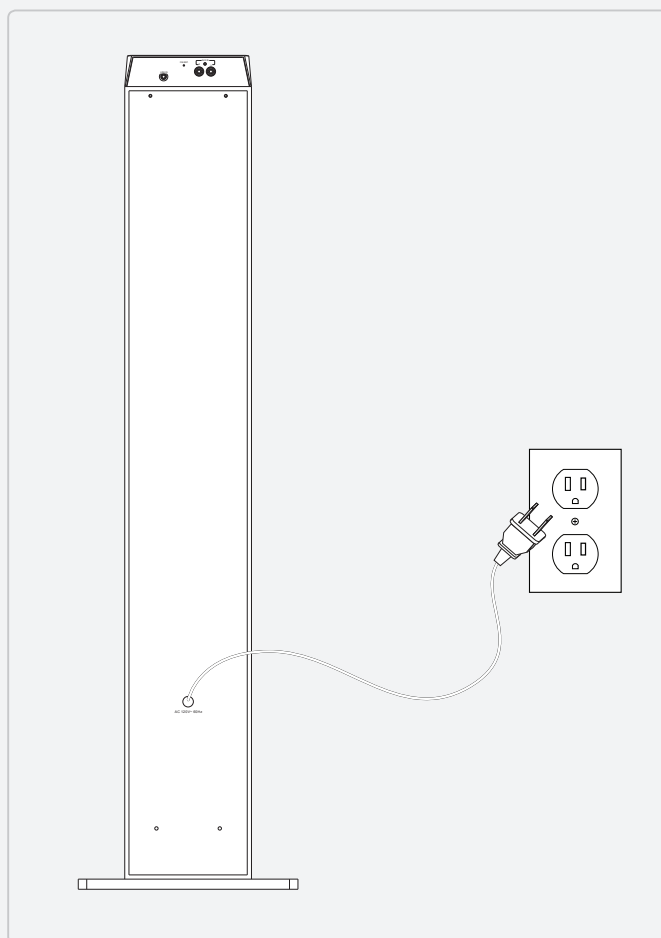

Remote

Requires a CR2025 battery (pre-installed)

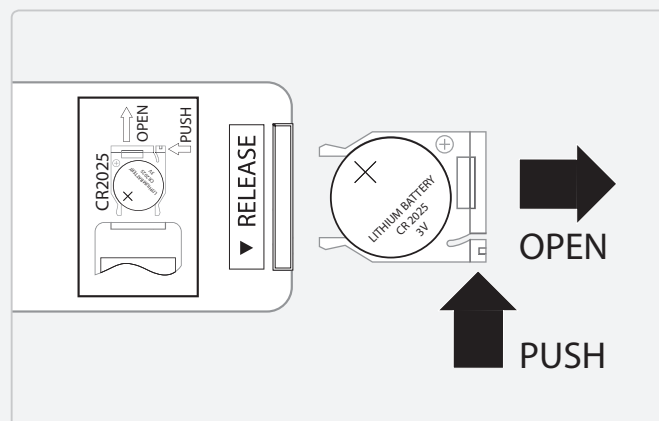
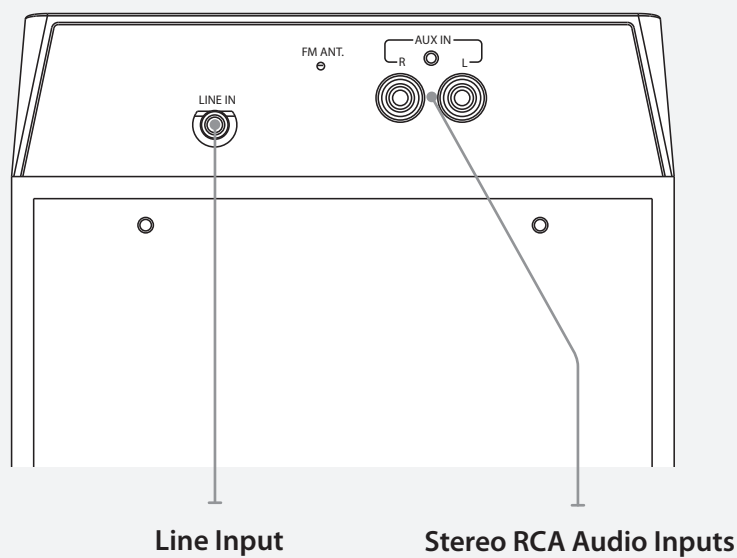
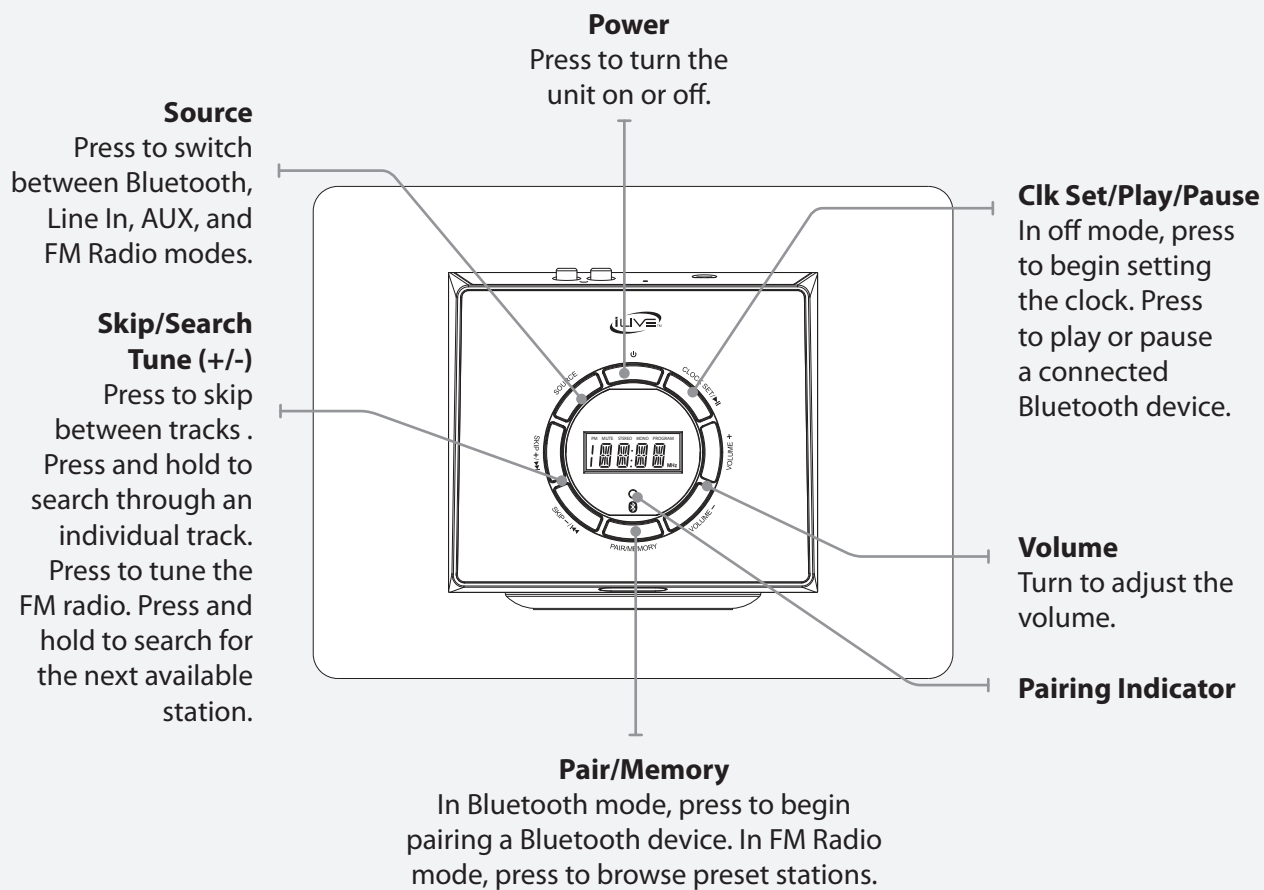
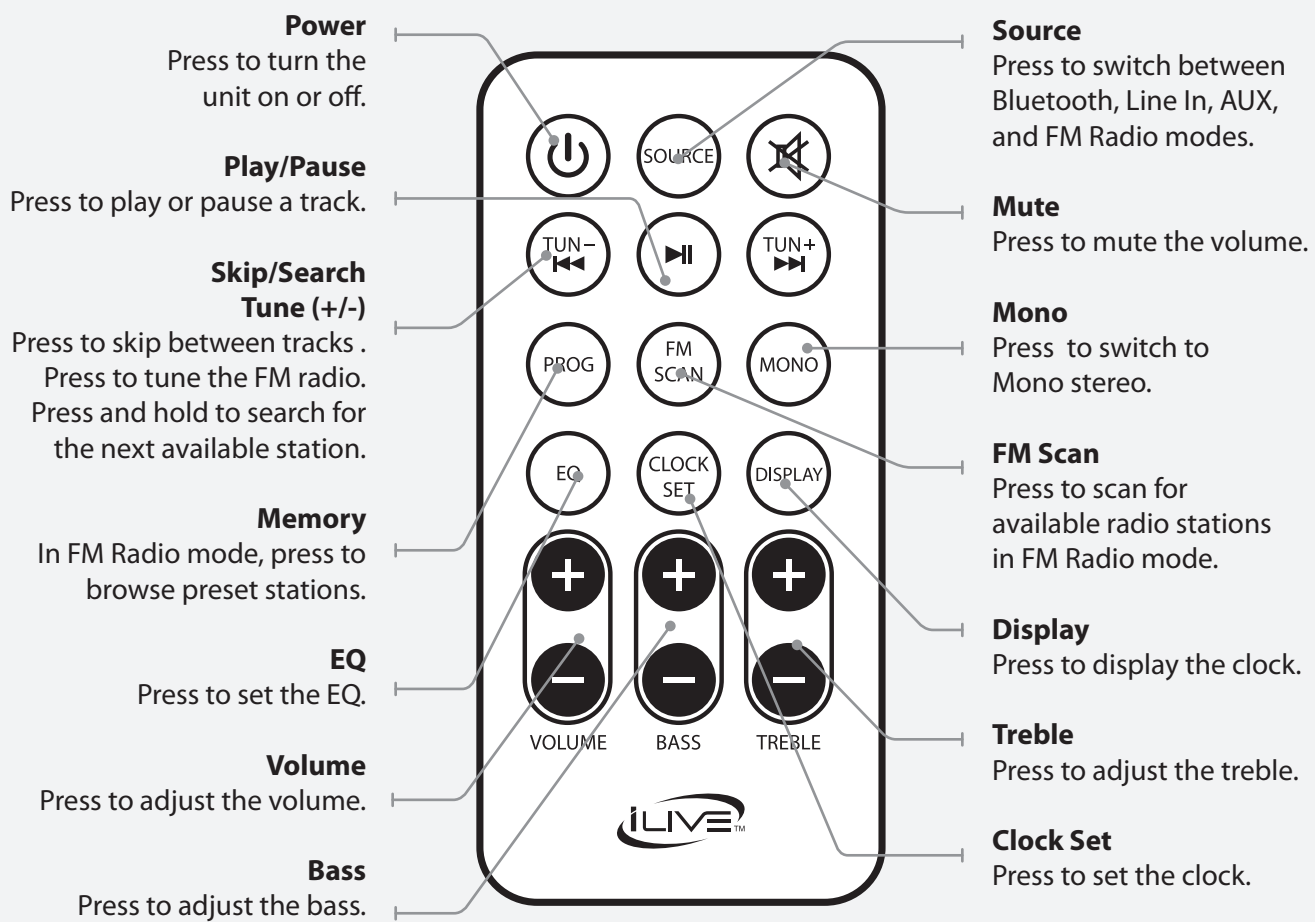

Table of Contents

Warnings and Precautions	2
Important Safety Instructions	3
ITB123B	4
Features	
Setup	4
Power	
Remote	
Includes	
Table of Contents	5
Introduction	6
Audio Inputs & Subwoofer Output	8
Using the Stereo RCA Inputs	
Using the Line In	
Radio and Line In	9
Tuning the FM Radio	
Saving Stations as Presets	
Bluetooth	10
Pairing a Bluetooth Device for the First Time	
Playing Audio Wirelessly	
Stand	11
Company Information	12
International Support	
Contact Information	
Warranty	
Green Initiative	

Introduction





Setting the Clock & Stereo RCA Inputs

Setting the Clock

1. If powered on, press the **Power** button to turn the unit off.
2. Press the **Clock Set** button.
The hour will begin to flash.
3. Press the **Tuning+/-** buttons to adjust the hour.
4. Press the **Clock Set** button.
The minute will begin to flash.
5. Press the **Tuning+/-** buttons to adjust the minute.
6. Press the **Clock Set** button again to finish setting the time.

Using the Stereo RCA Inputs

When connecting two products using an RCA Cable, match the colored ports with the same colored connection.

1. Connect the RCA Cable to the RCA Stereo Inputs located on the back of the unit, and to the audio outputs on the television.
2. Press the **Power** button to power on the unit.
3. Press the **Source** button repeatedly to enter Aux Mode.
4. Audio played through the television will now be heard through the speakers.

Radio and Line In

Tuning the FM Radio

1. Press the **Power** button to turn the unit on.
2. Press the **Source** button repeatedly to switch the unit to FM Mode.
3. Press the **Tuning+/-** buttons on the unit or the remote to scan for the next available station.
4. Press and hold the **Tuning+/-** buttons to search for the next available station.

Saving Stations as Presets

1. Press the **Source** button repeatedly to enter FM Radio Mode.
2. Press the **FM Scan** button on the remote.
3. The bar speaker will scan for all available stations, and store them.
4. Press the **Memory** button on the remote or the unit to browse through stored stations.

Using the Line In

3.5 mm line input cable not included.

1. Plug one end of a 3.5 mm audio input cable into the **Line In** on the unit.
2. Plug the other end of the cable into the audio output/headphone output on an MP3 Player or other audio source.
3. Press the **Power** button to power the unit on.
4. Press the **Source** button repeatedly to enter Line In Mode.
5. Audio played through the connected device will now be heard through the speakers.

Bluetooth

Pairing a Bluetooth Device for the First Time

1. Power on the unit by pressing the **Power** button.
2. Press the **Source** button repeatedly to enter Bluetooth mode.

The display will show "BT".

3. Press the **Pairing** button on the top of the unit.

*The **Pairing Indicator** will flash blue quickly.*

When pairing, remain within 3 feet of the unit.

4. Using the native controls on your Bluetooth device, select the "ITB123" in your Bluetooth settings to pair.

If your device requests a password, enter the default password "0000".

Refer to the user's manual for your specific device for instructions on pairing and connecting Bluetooth devices.

5. When successfully paired and connected, a beep will issue from the unit and the **Pairing Indicator** will display a solid blue light.

After initial pairing, the unit will stay paired unless unpaired manually by the user or erased due to a reset of the device.

If your device should become unpaired or you find it is unable to connect, repeat the above steps.

Playing Audio Wirelessly

1. Follow the instructions for [Pairing a Bluetooth Device](#).
2. Press the **Source** button repeatedly to enter Bluetooth mode.
3. Use the native controls on the connected Bluetooth Device to select a track.
4. To play, pause or skip the selected track, use the native controls on the connected Bluetooth Device.
5. Audio played through the connected Bluetooth device will now be heard through the speakers.

Stand

Attaching the Stand

1. Align the holes in the bottom of the unit to the holes in the base.
2. Use a philips-head screwdriver to tighten or remove the screws. Using an power drill could damage the TV stand.

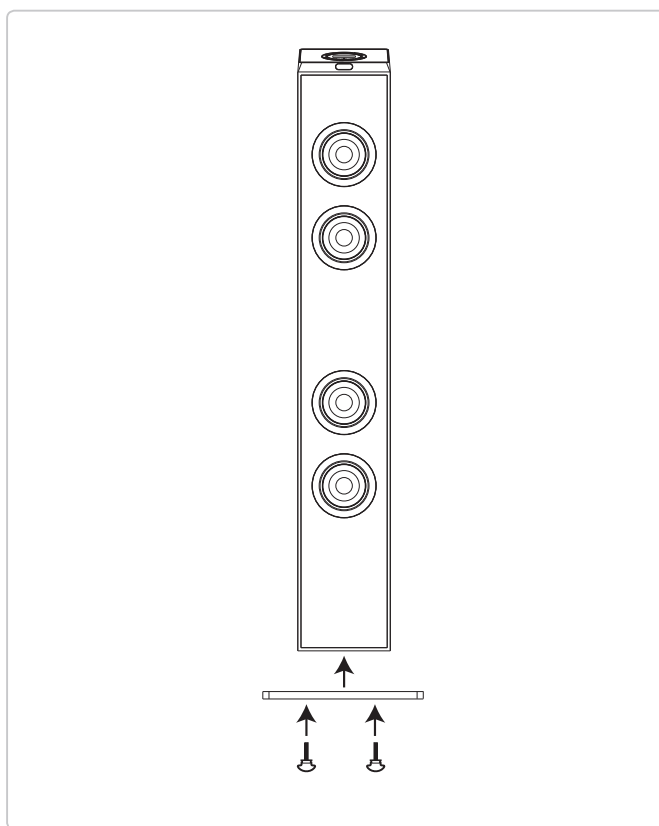
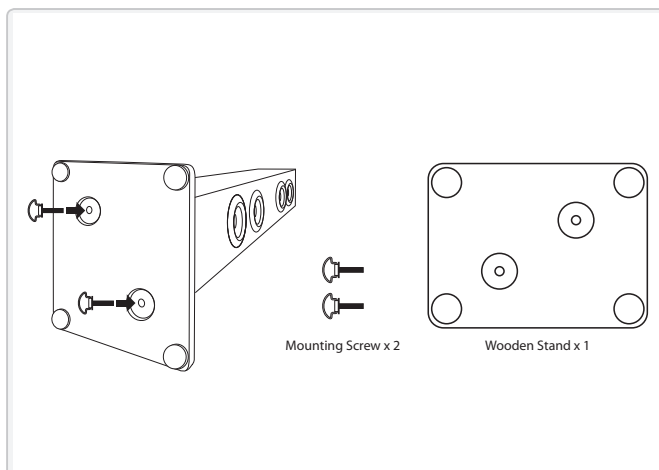

Company Information

International Support

To download this User's Guide in English, Spanish, and French, or to get answers to frequently asked questions, visit the support section at:

www.iLiveElectronics.com

Para descargar este Manual del Usuario en inglés, español y francés, o para obtener respuestas a preguntas frecuentes, visite la sección de apoyo en:

www.iLiveElectronics.com

Pour télécharger ce guide de l'utilisateur en anglais, espagnol ou français, ou pour obtenir des réponses à des questions fréquemment posées, consultez la rubrique d'assistance sur:

www.iLiveElectronics.com

Contact Information

Email Support: proinfo@dpiinc.com

Email Parts: partsinfo@dpiinc.com

Phone Support: 1-888-999-4215

Website: www.iLiveElectronics.com

Warranty

For Warranty Information and the most up-to-date version of this User's Guide, go to:
www.iLiveElectronics.com

Green Initiative



Environmental Commitment to 'Protect for Today and Sustain for Tomorrow'

On a continual basis DPI, Inc. is making efforts to sustain the environment and improve the recyclability of its products and packaging.

Focusing on "protecting for today and sustaining for tomorrow" DPI, Inc. has committed to reducing packaging size, increasing the usage of recyclable plastics, and ensuring that packaging and manuals are made with up to 85% recycled material. In addition to material consideration, DPI, Inc. has also focused on the finer details that positively impact the environment such as employing the usage of soy-based inks.

DPI, Inc. also ensures that the factories that produce the company's wide variety of consumer electronics adhere to environmentally friendly air and water restrictions. This is yet another example that every step of the way DPI, Inc. is making efforts to lessen any impact on the environment.

In 2011 DPI, Inc. also began conversations with Energy Star in order to ensure that the consumer electronics being produced meet high standards of energy efficiency. The ultimate goal is keeping energy costs for consumers low while providing quality, feature-rich products.