



CRAIG®

37 INCH STEREO SOUND BAR SYSTEM

**with Digital Optical Input and
Bluetooth® Wireless Technology**

Owner's Manual



PLEASE READ BEFORE OPERATING THIS EQUIPMENT.



Model: CHT988

Size: 148.5(W) x 210(H)mm (A5)



IMPORTANT SAFETY INSTRUCTIONS

	CAUTION RISK OF ELECTRIC SHOCK DO NOT OPEN	
CAUTION: TO REDUCE THE RISK OF ELECTRIC SHOCK, DO NOT REMOVE COVER (OR BACK). NO USER-SERVICEABLE PARTS INSIDE. REFER SERVICING TO QUALIFIED SERVICE PERSONNEL.		

	The lightning flash with arrowhead symbol, within an equilateral triangle, is intended to alert user to the presence of uninsulated "dangerous voltage" within the product's enclosure, that may be of sufficient magnitude to constitute a risk of electric.
	The exclamation point within an equilateral triangle is intended to alert the user to the presence of important operating and maintenance (servicing) instruction in the literature accompanying the appliance.

FCC Warnings

WARNING: Changes or modifications to this unit not expressly approved by the party responsible for compliance could void the user's authority to operate the equipment.

NOTE: This equipment has been tested and found to comply with the limits for a Class B digital device, pursuant to Part 15 of the FCC Rules. These limits are designed to provide reasonable protection against harmful interference in a residential installation. This equipment generates, uses, and can radiate radio frequency energy and, if not installed and used in accordance with the instructions, may cause harmful interference to radio communications. However, there is no guarantee that interference will not occur in a particular installation. If this equipment does cause harmful interference to radio or television reception, which can be determined by turning the equipment off and on, the user is encouraged to try to correct the interference by one or more of the following measures:

- Reorient or relocate the receiving antenna.
- Increase the separation between the equipment and receiver.
- Connect the equipment into an outlet on a circuit different from that to which the receiver is connected.
- Consult the dealer or an experienced radio/TV technician for help.

FCC NOTICE:

To assure continued compliance, follow the attached installation instructions and use only shielded cables when connecting to other devices. Modifications not authorized by the manufacturer may void user's authority to operate this device.

Before using the unit, be sure to read all operating instructions carefully. Please note that these are general precautions and may not pertain to your unit. For example, this unit may not have the capability to be connected to an outdoor antenna.

FCC ID:OKUSBB55166

1. Read these instructions

All the safety and operating instructions should be read before the product is operated.

2. Keep these instructions

The safety and operating instructions should be retained for future reference.

3. Heed all warning

All warnings on the product and in the operating instructions should be adhered to.

4. Follow all instructions

All operating and use instructions should be followed.

5. Do not use this apparatus near water

Do not use the product near water and moisture, for example: near a bathtub, washbowl, kitchen sink or laundry tub; in a wet basement; or near a swimming pool.

6. Clean only with dry cloth

Unplug this product from the wall outlet before cleaning. Do not use liquid cleaners or aerosol cleaners. Use a dry cloth for cleaning.

7. Do not block any ventilation openings. Install in accordance with the manufacturer's instructions.

Slots and openings in the cabinet and in the back or bottom are provided for ventilation, to ensure reliable operation of the product and to protect it from overheating. These openings must not be blocked or covered. The openings should never be blocked by placing the product on a bed, sofa, rug or other similar surface. This product should never be placed near or over a radiator or heat source. This product should not be placed in a built-in installation such as a bookcase or rack unless proper ventilation is provided or the manufacturer's instructions have been adhered to.

8. Do not install near any heat sources such as radiators, heat registers, stoves, or other apparatus (including amplifiers) that produce heat.

9. Do not defeat the safety purpose of the polarized or grounding-type plug. A polarized plug has two blades with one wider than the other. A grounding type plug has two blades and a third grounding prong. The wide blade or the third prong are provided for your safety. If the provided plug does not fit into your outlet, consult an electrician for replacement of the obsolete outlet.

10. Protect the power cord from being walked on or pinched particularly at plugs, convenience receptacles, and the point where they exit from the apparatus.

11. Only use attachments/accessories specified by the manufacturer.

IMPORTANT SAFETY INSTRUCTIONS

12. Use only with the cart, stand, tripod, bracket, or table specified by the manufacturer, or sold with the apparatus. When a cart is used, use caution when moving the cart/apparatus combination to avoid injury from tip-over.



Portable Cart Warning

13. Unplug this apparatus during lightning storms or when unused for long periods of time.
14. Refer all servicing to qualified service personnel. Servicing is required when the apparatus has been damaged in any way, such as power-supply cord or plug is damaged, liquid has been spilled or objects have fallen into the apparatus, the apparatus has been exposed to rain or moisture does not operate normally, or has been dropped.

15. Power Source

The product should be operated only from the type of power source indicated on the marking label. If you are not sure of the type of power supply to your home, consult your appliance dealer or local power company. For products intended to operate from battery power, or other sources, refer to the operating instructions.

16. Power lines

An outside antenna system should not be located in the vicinity of overhead power lines or other electric light or power circuits, or where it can fall into such power lines or circuits. When installing an outside antenna system, extreme care should be taken to keep from touching such power lines or circuits as contact with them might be fatal.

17. Overloading

Do not overload wall outlets and extension cords as this can result in a risk of fire or electric shock.

18. Object and liquid entry

Never push objects of any kind into the product through as they may touch dangerous voltage points or short out parts that could result in fire or electric shock. Never spill or spray any type of liquid on the product.

19. Outdoor antenna grounding

If an outside antenna is connected to the product, be sure the antenna system is grounded so as to provide some protection against voltage surges and built up static charges.

Section 810 of the National Electrical Code, ANSI/NFPA 70, provides information with respect to proper grounding of the mast and supporting structure, grounding of the lead-in wire to an antenna discharge product, size of grounding conductors, location of antenna discharge product, connection to grounding electrodes and requirements for the grounding electrodes.

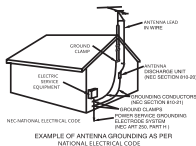

20. Service

Do not attempt to service this product yourself as opening or removing covers may expose you to dangerous voltage or other hazards. Refer all servicing to qualified service personnel.

21. Replacement parts

When replacement parts are required, be sure the service technician uses replacement parts specified by the manufacturer or those that have the same characteristics as the original part. Unauthorized substitutions may result in fire or electric shock or other hazards.

22. Safety check

Upon completion of any service or repairs to this product ask the service technician to perform safety checks to determine that the product is in proper operating condition.

23. Wall or ceiling mounting

The product should be mounted to a wall or ceiling only as recommended by the manufacturer.

24. Damage requiring service

Unplug the product from the wall outlet and refer servicing to qualified service personnel under the following conditions:

- When the power-supply cord or plug is damaged.
- If liquid has been spilled or objects have fallen into the product.
- If the product has been exposed to rain or water.
- If the product does not operate normally by following the operating instructions.
Adjust only those controls that are covered by the operating instructions, as an adjustment of other controls may result in damage and will require extensive work by a qualified technician to restore the product to its normal operation.
- If the product has been dropped or the cabinet has been damaged.
- When the product exhibits a distinct change in performance – this indicates a need for service.

25. Note to CATV system installer

This reminder is provided to call the CATV system installer's attention to Article 820-40 of the NEC that provides guidelines for proper grounding and, in particular, specifies that the cable ground shall be connected to the grounding system of the building, as close to the point of cable entry as practical.

Note:

Refer all servicing to qualified service personnel. Servicing is required when the unit has been damaged any way such as the following: the power-supply cord or plug has been damaged, liquid has been spilled into the unit, the unit has been exposed to rain or moisture, the unit has been dropped or the unit does not operate normally.

POWER SOURCE

Main Unit:

1. Insert the small plug from the supplied AC/DC Adapter to the DC IN Jack on the rear of unit.
2. Connect the AC/DC Adapter to the wall outlet having AC 100-240V~; 50/60Hz. The Red Standby Indicator on the front of unit will illuminate.



NOTES:

- To save energy, unplug the AC/DC Adaptor from the wall outlet if you may not use the unit for an extended period of time.
- This AC/DC Adaptor intended to be correctly orientated in a vertical or floor mount position.

Remote Control:

Remove and discard the insulation film as illustrated on the right.

If the button cell is drained, replace it by a new one as below:

1. Push and slide out the battery holder as Fig.1 below.
2. Replace the button cell with a new CR2025 button cell as the polarity markings on the rear of the Remote Control as Fig.2 below.
3. Close the battery holder as Fig.3 below.

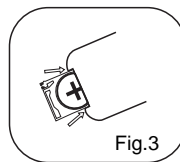
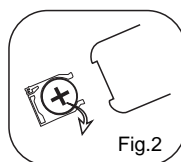
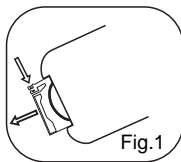
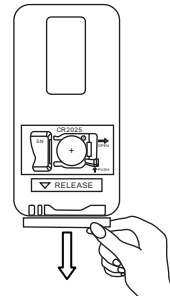

BATTERY PRECAUTIONS:

Follow these Battery Precaution when using a battery in this device:

1. Use only the size and type of battery specified.
2. Be sure to follow the correct polarity when installing the battery as indicated in the battery compartment. A reversed battery may cause damage to the device.
3. Do not mix different types of batteries together (e.g. Alkaline and Carbon-zinc) or old batteries with fresh ones.

4. If the batteries in the device are consumed or the device is not to be used for a long period of time, remove the batteries to prevent damage or injury from possible battery leakage.
5. Do not try to recharge the battery not intended to be recharged; it can overheat and rupture. (Follow battery manufacturer's instructions.)
6. Do not dispose of battery in fire. Battery may explode or leak.
7. Clean the battery contacts and also those of the device prior to battery installation.
8.  This product contains a coin/button cell battery. If the coin/button cell battery is swallowed, it can cause severe internal burn in just 2 hours and can lead to death. Keep new and used batteries away from children. If the battery compartment does not close securely, stop using the product and keep it away from children. If you think batteries might have been swallowed or placed inside any part of the body, seek immediate medical attention.

INSTALLATION

1. Placing on the table

When placing the Sound Bar on an entertainment center, bookshelf, or any type of enclosed space, be sure to allow at least 2-3 inches of space around the Sound Bar for ventilation. If the Sound Bar is enclosed in a tight space, without ventilation, heat generated from the Sound Bar could produce a potential heat hazard.

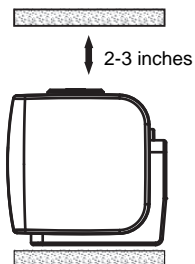

2. Mounting the Speaker Bar onto a wall

We recommend having this unit professionally mounted. By using wall mounting accessories, the unit can be mounted onto a wall.

Distance Between Two Brackets

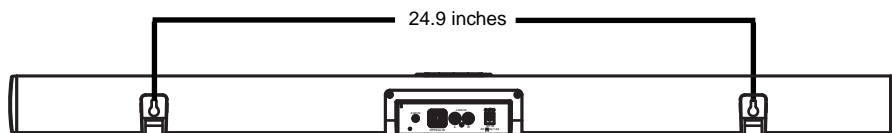

Mounting to a wall

2.1 Mounting to a wooden wall

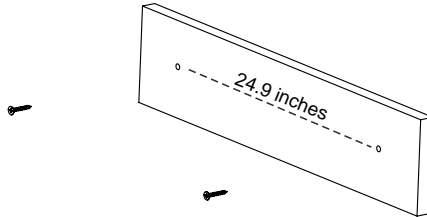

- Mark the position of the mounting screws on the wall using a pencil (not included).
- Drill the supplied mounting screws directly into the marks that you have made on the wall and leave approx. 0.3 inches length to hook the sound bar.
- Put the sound bar onto the mounting screws. Make sure they are firm and stable.

2.2 Mounting to a brick wall

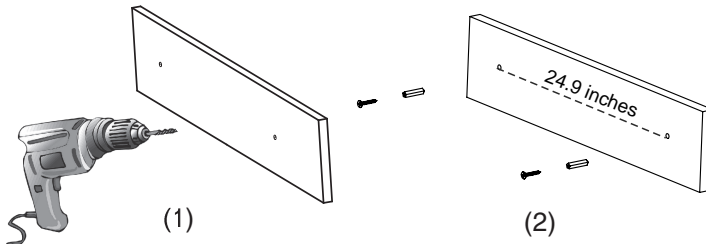

- Mark the position of the supplied mounting screws on the wall using a pencil (not included).
- Drill 2 holes on wall with a powerful electric drill (not included).
- Insert the supplied plastic inserts into the holes by hammer (not included).
- Secure the supplied mounting screws into the plastic insert and leave approx. 0.3 inch length to hook the sound bar.
- Put the sound bar onto the mounting screws. Make sure they are firm and stable.

LOCATION OF CONTROLS

Front View:

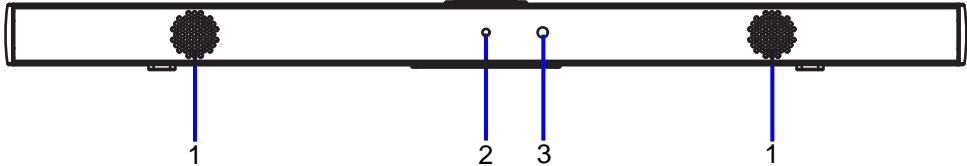

Rear View:

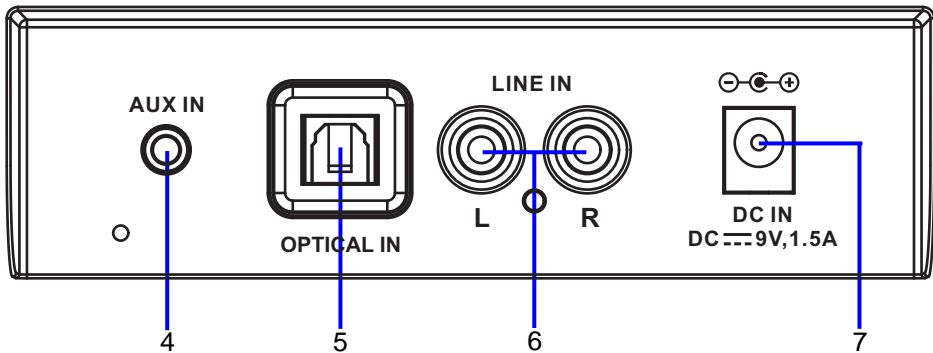

Top View:

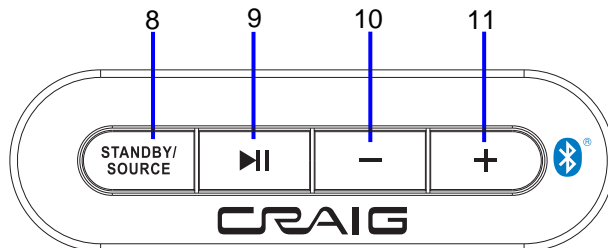

- | | |
|--------------------|--|
| 1. Speakers | 7. DC IN Jack |
| 2. Indicators | 8. STANDBY/SOURCE Button |
| 3. Remote Sensor | 9. ▶ (Play/Pause) Button |
| 4. AUX IN Jack | 10. - (Volume Down/Skip Backward) Button |
| 5. OPTICAL IN Jack | 11. + (Volume Up/Skip Forward) Button |
| 6. LINE IN Jacks | |

LOCATION OF CONTROLS - REMOTE CONTROL

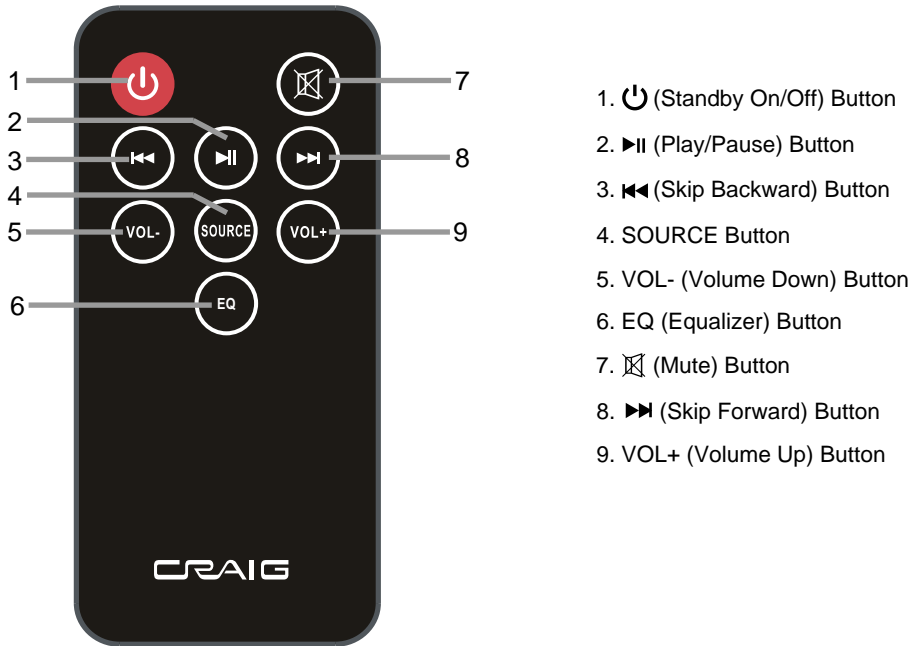

EFFECTIVE DISTANCE OF REMOTE TRANSMITTER

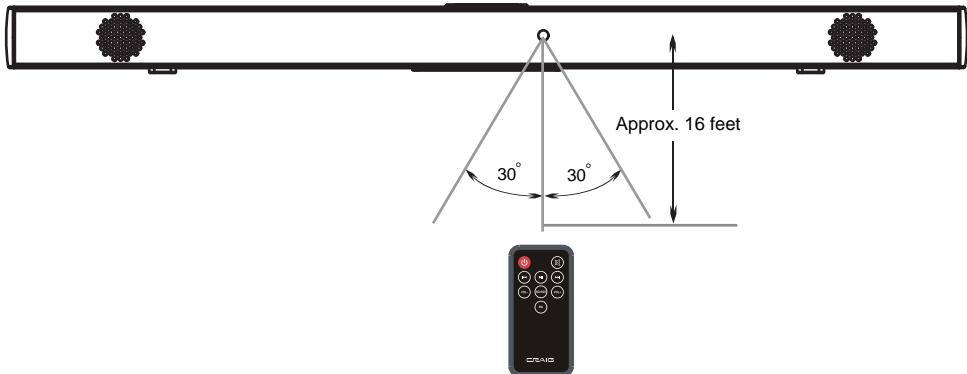

NOTES:



- When there is an obstacle between the unit and the transmitter, the unit may not operate.
- When direct sunlight, an incandescent lamp, fluorescent lamp or any other strong light shines on the REMOTE SENSOR of the unit, the operation of the remote may be unstable.

OPERATIONS

GENERAL OPERATION:

1. Connected the unit to AC power as previously instructed. The Red Standby Indicator on the front of unit will illuminate.
2. Press the STANDBY/SOURCE Button on the top of unit or press the  Button on the Remote Control to power on the unit from Standby mode.
3. Press the STANDBY/SOURCE Button on the top of unit or press the SOURCE Button on the Remote Control repeatedly to switch to desired playback mode. The color of the indicator on the front of unit will changes as your selection (see list below):

Playback Mode:	Color of the INDICATOR on front panel
BT (Bluetooth)	Blue
LINE IN	Green
AUX IN	Purple (Red + Blue Mixed)
OPTICAL IN	Indigo (Blue + Green Mixed)

4. During playback:
 - A. Press and release the **+** or **-** buttons on the unit or press the VOL + or VOL- buttons on the Remote Control repeatedly to adjust volume level as desired.
 - B. Press the  (Mute) Button on the Remote Control to mute the sound temporary, press again to turn it back.
 - C. Press the EQ (Equalizer) Button on the Remote Control repeatedly to select and set equalizer effects as desired.
5. When finished listening, press and hold the STANDBY/SOURCE Button on the top of unit approximately 2 seconds or press the  Button on the Remote Control to turn the unit to Standby mode.
6. To save energy, unplug the AC/DC Adaptor from the wall outlet if you may not use the unit for an extended period of time.

BT MODE:

BT (Bluetooth) pairing:

First time use or re-pairing the unit to a new BT Device, pair as follows:

1. Power on the unit and enter to BT mode as previously instructed. The color of the indicator on the front of unit will turn to blue and blink.
2. Power on the external BT Device and enter to BT searching mode. Start pairing following the on screen instructions from the external BT Device. After paired, the blue indicator will stop blinking.
3. If pairing is complete you may now play music with your external BT Device.
4. During playback:
 - Press the ►|| Button on the unit or Remote Control to pause, press again to resume normal playback.
 - Press and hold the — or + buttons on the unit or press the ◀◀ or ▶▶ buttons on Remote Control repeatedly to skip tracks.

Notes:

- When the external BT Device searched the unit, our model number "CHT988" will appear on the display of external BT Device.
- If while pairing you are asked for a code please try "0000" or "1234".

Normal operation after pairing:

1. Power on the external BT Device and enter to BT mode.
2. Power on the unit and enter to BT mode as previously instructed. The color of the indicator on the front of unit will turn to blue and blink.
3. Wait a few seconds until the unit is automatically paired to the external BT Device. The blue indicator will stop blinking.
4. After pairing is complete, you may now play music with your external BT Device.

LINE IN:

Listen music from RCA output jacks from an external Video/Audio Player such as a Television; DVD Player, VCR ...etc.

1. Connect one end of the RCA Connection Cable (included) to the Line Out Jacks on the external Video/Audio Player.
2. Connect the other end of the cable to the LINE IN Jacks on the rear of unit as illustrated below:

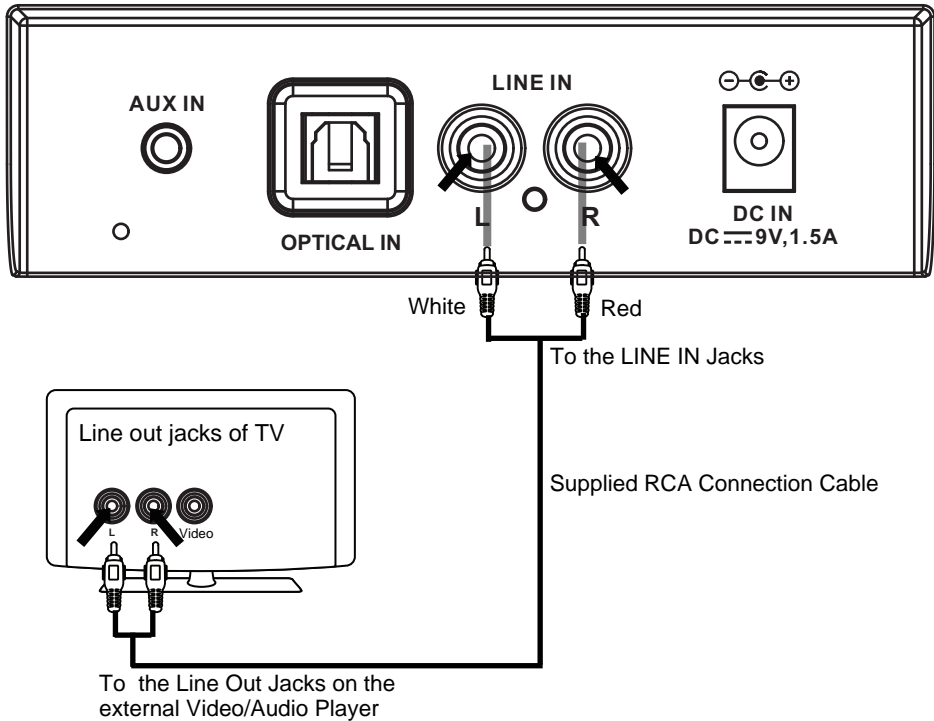

3. Power on the unit and enter to LINE IN mode as previously instructed. The color of the indicator on the front of unit will turn to Green.
4. Play the video/music on the connected Video/Audio Player as usual. (Make sure the volume level of the connected Video/Audio Player is turned to high level.)

AUX IN:

Listen music from an external Audio Player such as a MP3 Player, Discman ...etc.

1. Connect one end of the Supplied Audio Connection Cable to the Line Out/AUX Out Jack on the external Audio Player.
2. Connect the other end of the cable to the AUX IN Jack on the rear of unit as illustrated below:

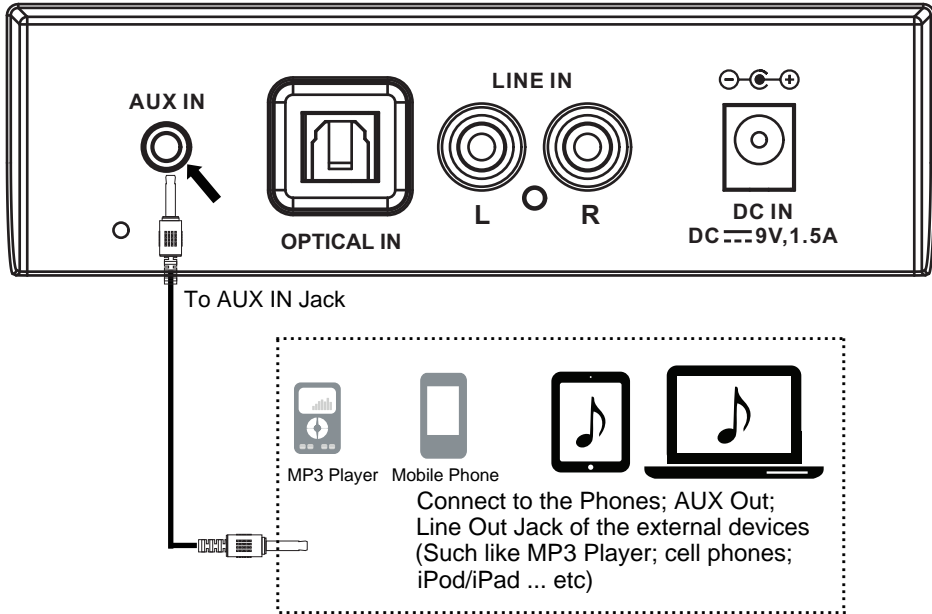

3. Power on the unit and enter to AUX IN mode as previously instructed. The color of the indicator on the front of unit will turn to Purple (Red + Blue Mixed).
4. Play the music on the connected Audio Player as usual. (Make sure the volume level of the connected Audio Player is turned to high level.)

OPTICAL IN:

Listen music from the Optical Out Jack on an external Video Player or Television:

1. Connect one end of the Optical Connection Cable (not included) to the Optical Out Jack on the external Video Player or Television.
2. Connect the other end of the cable to the OPTICAL IN Jack on the rear of unit as illustrated below:

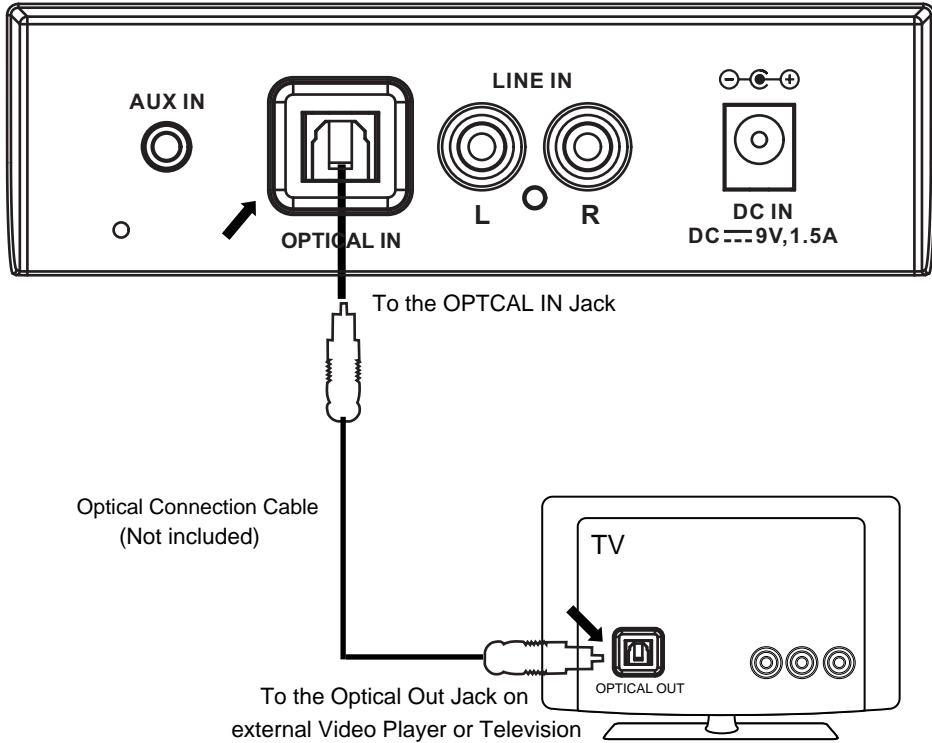

3. Power on the unit and enter to Optical IN mode as previously instructed. The color of the indicator on the front of unit will turn to Indigo (Blue + Green Mixed).
4. Plays the video on the connected Video Player or watching the TV program on the connected TV as usual.



CLEANING:**CLEANING**

1. To prevent fire or shock hazard, disconnect your unit from the AC wall outlet when cleaning.
2. The finish on your unit may be cleaned with a dust cloth and cared for as other furniture. Use caution when cleaning and wiping the plastic parts.
3. Mild soap and a damp cloth may be used.



TROUBLESHOOTING GUIDE

SYMPTOM	POSSIBLE CAUSE	POSSIBLE SOLUTION
No power	The adapter is not connected	Connect the adapter to the unit and wall outlet as page 4
	The unit is in standby mode	Press the STANDBY/SOURCE Button on the unit or press the  Button on the Remote Control to power on the unit from standby mode
No sound or sound weak	Volume level in minimum position	Raise the volume level by press and release the + Button on the top of unit or press the VOL+ Button on Remote Control repeatedly
	The paired/connected device is not in playback mode	Play music/movie in the paired/connected device as usual and make sure the volume level of it is in high level
	Input source incorrect	Press the STANDBY/SOURCE Button on the unit or the SOURCE Button on the Remote Control repeatedly to switch to desired mode
Sound distortion/rattle	Volume level too high	Reduce the volume level by press and release the - Button on the top of unit or press the VOL- Button on the Remote Control repeatedly
		Reduce the volume level of the paired/connected device
Remote Control not functioning	Out of remote control range	Point the remote control to the Remote Sensor on the unit within 16 feet, +/- 30 degree
	The button cell in the Remote Control are drained	Replace it by a new CR2025 button cell
Bluetooth not functioning	The external BT device is too far from the unit	Place the external BT device close to the unit
	BT have not paired	Pair the unit with the BT device as page 10

GENERAL SPECIFICATION

Power Source.....	DC  9V, 1.5A, 
Audio Power.....	5W per Channel (Total 10W, RMS)
BT Version.....	4.1
Bluetooth effective working range in open area.....	up to 32 feet
Remote effective working range.....	up to 16 feet

ACCESSORIES

- 1 x AC/DC Adapter (Input: AC 100-240V~, 50/60Hz, 0.5A)
(Output: DC  9V, 1500mA, )
- 1 x Remote Control, using CR2025 button cell (Included, already installed)
- 1 x Owner's Manual
- 1 x Audio Connection Cable with 3.5mm Stereo Plugs
- 1 x RCA Connection Cable
- 2 x Plastic Inserts (For Wall Mounting)
- 2 x Metallic Screws (For Wall Mounting)

**SPECIFICATIONS AND ACCESSORIES ARE SUBJECT TO CHANGE
WITHOUT NOTICE**

LIMITED WARRANTY

Craig warrants this product to be free from manufacturing defects in material and workmanship under normal use for a period of 90 days from date of purchase. If service is required, please return the product to the store where it was purchased for exchange; or, pack the unit in the original packing material with all accessories if applicable, a copy of your sales receipt and a Cashier's check or Money Order for \$12.00 (to cover shipping and handling costs) payable to Craig Electronics Inc. For consumers in Canada, please make sure that the cashier check or money order is redeemable through a U.S. bank. Ship your product freight pre-paid. Your unit will be repaired, replaced or if the unit can not be repaired or replaced, a refund will be forwarded to you within four weeks of receipt of your unit. Please ship your unit to:

Craig Electronics Inc.
1160 NW 163 Drive
Miami, FL 33169

This warranty is void if the product has been: a) Used in a commercial application or rental. b) Damaged through misuse, negligence, or abuse. c) Modified or repaired by anyone other than an authorized Craig service center. d) Damaged because it is improperly connected to any other equipment.

Note: This warranty does not cover: a) Ordinary adjustments as outlined in the Owner's Manual which can be performed by the customer. b) Damage to equipment not properly connected to the product. c) Any cost incurred in shipping the product for repair. d) Damage to the product not used in the USA.

This warranty is not transferable and only applies to the original purchase. Any implied warranties, including the warranty of merchantability, are limited in duration to the period of this expressed warranty and no warranty whether expressed or implied shall apply to the product thereafter.

Under no circumstance shall Craig be liable for any loss or consequential damage arising out of the use of this product. This warranty gives specific legal rights. However, you may have other rights which may vary from state to state. Some states do not allow limitations on implied warranties or exclusion of consequential damage. Therefore, these restrictions may not apply to you.

To Obtain Service on your Product
email: service@craigelectronics.com