

DBPOWER

Bluetooth Soundbar User Manual



2018.03.
01
16:52:53
+08'00'







MODEL: SBB-55210

www.dbpower.co.uk / service@dbpower.co.uk

TABLE OF CONTENTS

What's in the box	2
Product diagram	3
Remote control key defination	4
Battery installation for remote control.....	5
Placement and mounting	6
General operation	7
Bluetooth pairing and connection.....	8
Optical digital audio in operation.....	8
Line in and Aux in opertation	10
Troubleshooting.....	11
Gernal specifications.....	12
FCC statement and Safety instructions.....	13

WHAT'S IN THE BOX

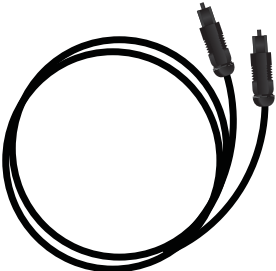
 <p>Soundbar</p>	 <p>Remote Control with CR2025 Battery</p>
 <p>User Manual</p>	 <p>Power Adapter</p>
 <p>Aux In cable</p>	 <p>Line In Cable</p>
 <p>Digital Optical Cable</p>	

PRODUCT DIAGRAM:

Front View

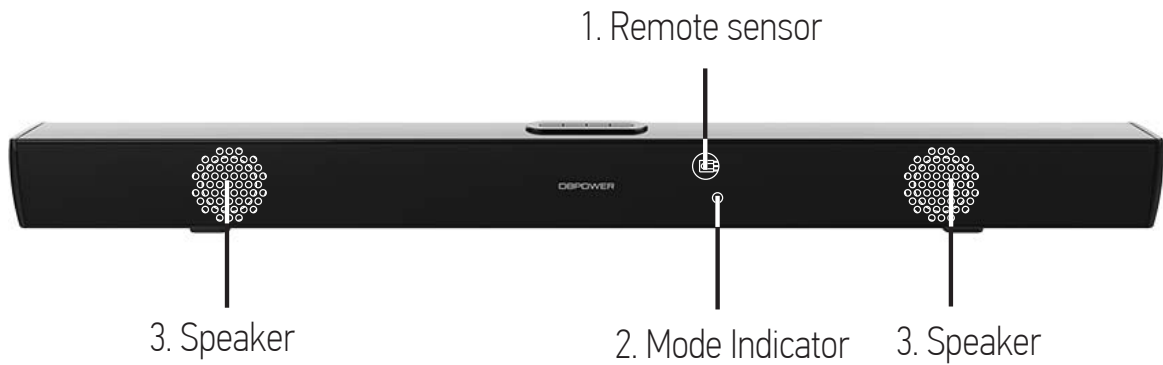

Rear View

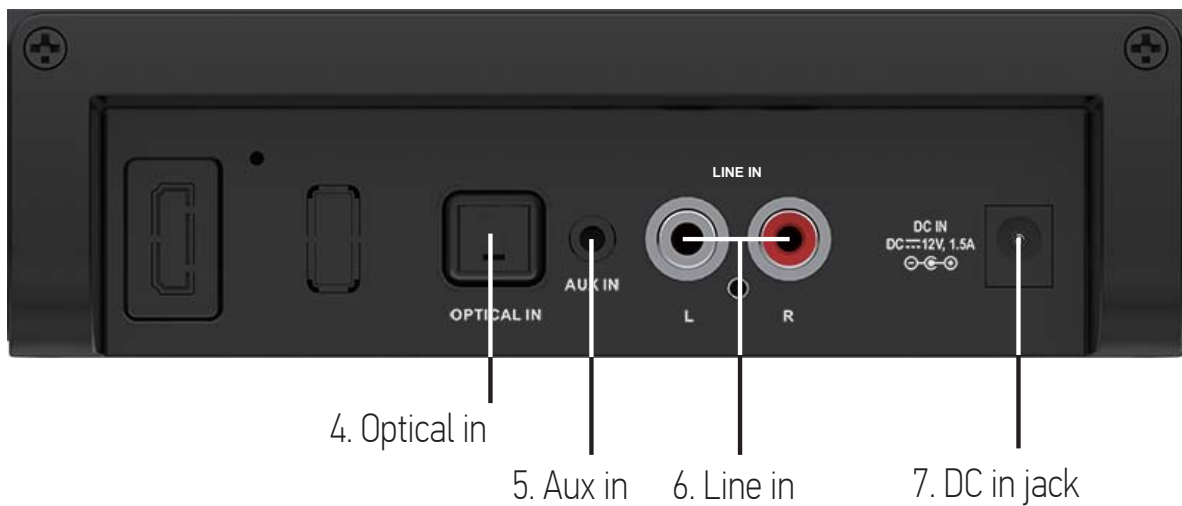

Top View

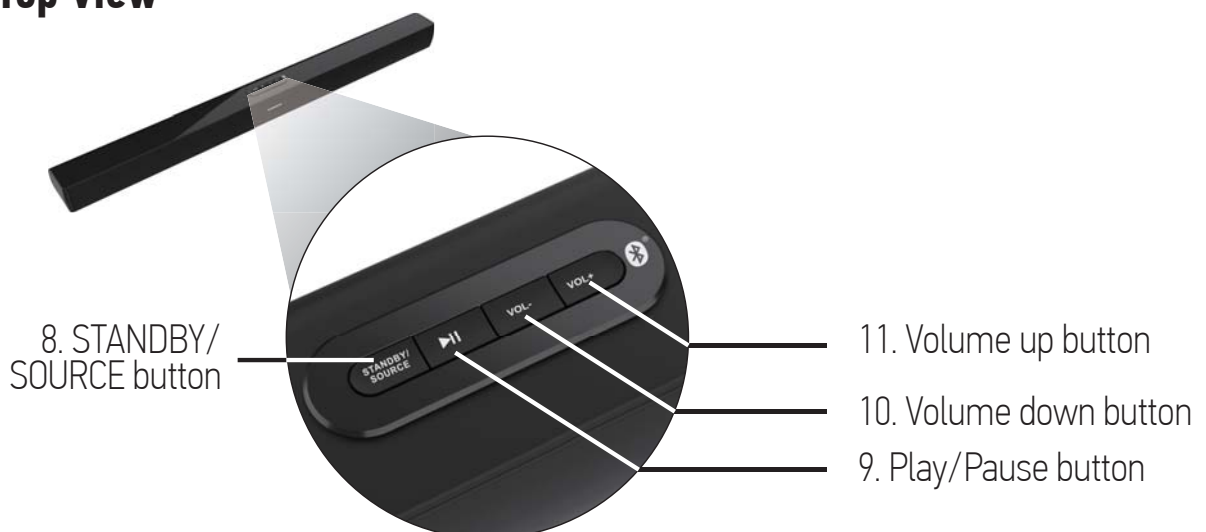

REMOTE CONTROL KEY DEFINATION

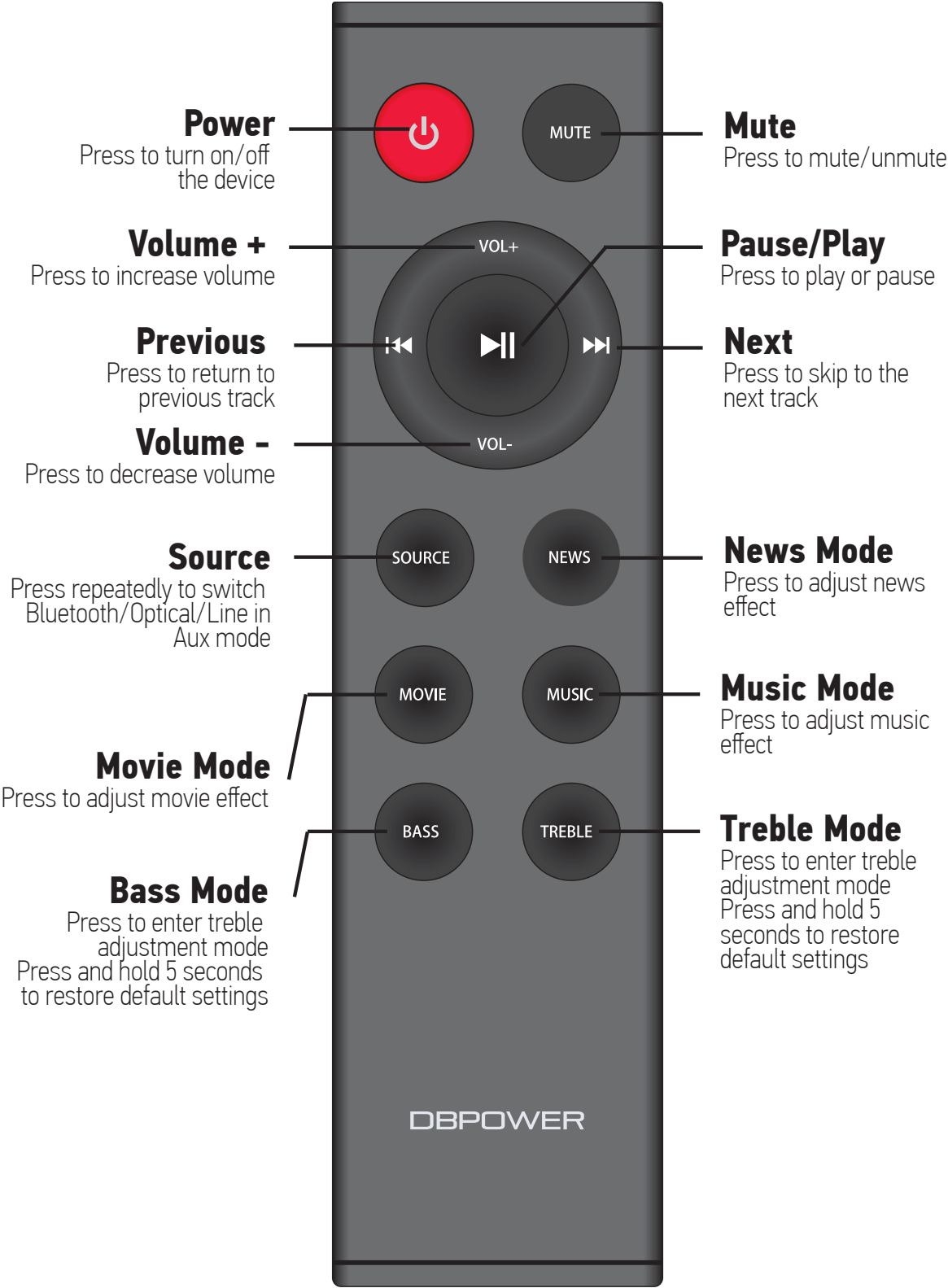

BATTERY INSTALLATION FOR REMOTE CONTROL

Battery installation:

1. Press and slide out the battery door as shown in Fig.1.
2. Replace the battery with a new CR2025(3V) button cell with the polarity marking upward as shown in Fig.2.
3. Insert the battery door back again and make it firm as shown in Fig.3.

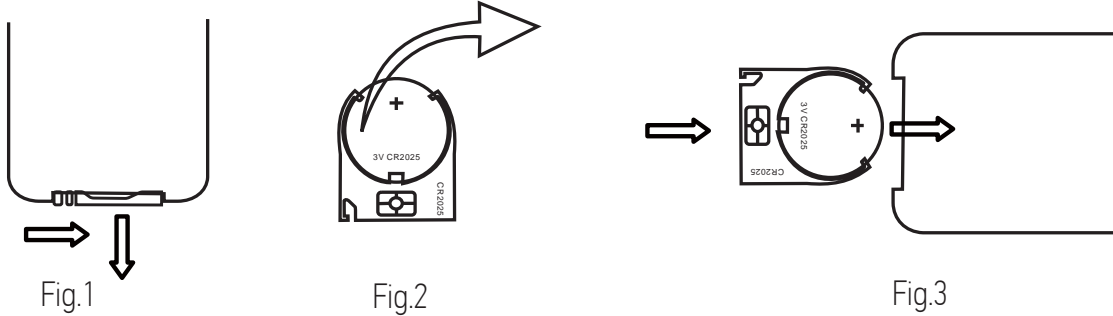

BATTERY PRECAUTIONS

Follow these precautions when using a battery in this device:

1. Use only the size and type of battery specified.
2. Be sure to follow the correct polarity when installing the battery as indicated in the battery compartment, a reserved battery may cause damage to the device.
3. Do not mix different types of battery together (e.g: Alkaline and Carbon-zinc) or old battery with fresh ones.
4. If the battery in the device are consumed or the device is not to be used for a long period of time, remove the battery to prevent damage or injury from possible leakage.
5. Do not try to recharge the battery as it is not intended to be recharged; it can overheat and rupture. (Follow the battery manufacturer's instructions.)
6. The battery shall not be exposed to excessive heat such as sunshine or fire.
7. Clean the battery contacts and also those of the device prior to battery installation.
8. The remote control is supplied with a coin/button cell battery. If the coin button cell battery is swallowed, it can cause severe internal burns in just 2 hours and can lead to death. Keep new and used battery away from children. If the stop using the product and keep it



away from children. If you think battery might have been swallowed or placed any part of the body, seek immediate medical attention.

CAUTION

- Danger of explosion if the battery is incorrectly replaced.
- Replace only with the same or equivalent type.

Remote control operation range

- When there is an obstacle between the remote and the transmitter, the unit may not operate.
- When direct sunlight, an incandescent lamp, fluorescent lamp or any other strong light shines on the REMOTE SENSOR of the unit, the operation of the remote may be unstable.

PLACEMENT AND MOUNTING

1. Placing the device on table - Ventilation

When placing the Sound Bar on an entertainment center, bookshelf, or any type of enclosed space, be sure to allow at least 2-3 inches of space around the Sound Bar for ventilation. If the Sound Bar is enclosed in a tight space, without ventilation, heat generated from the Sound Bar could produce a potential heat hazard.

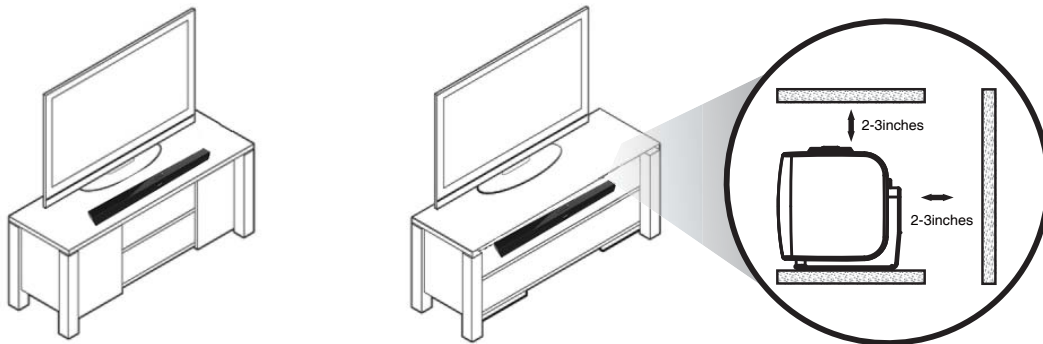

MOUNTING TO THE WALL

2.1 Mounting to wooden wall

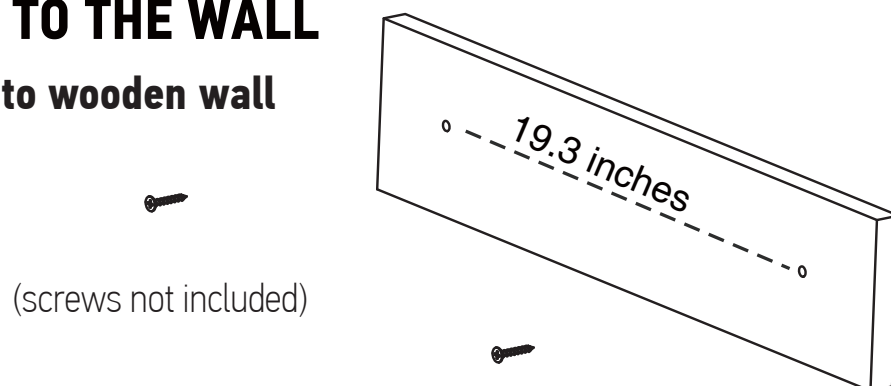

- A. Mark the position of the mounting screws on the wall using a pencil.
- B. Drill the screws directly into the marks that you have made on the wall and leave approx. 0.3 inches length to hook the sound bar.
- C. Put the sound bar onto the mounting screws. Make sure they are firm and stable.

2.2 Mounting to brick wall

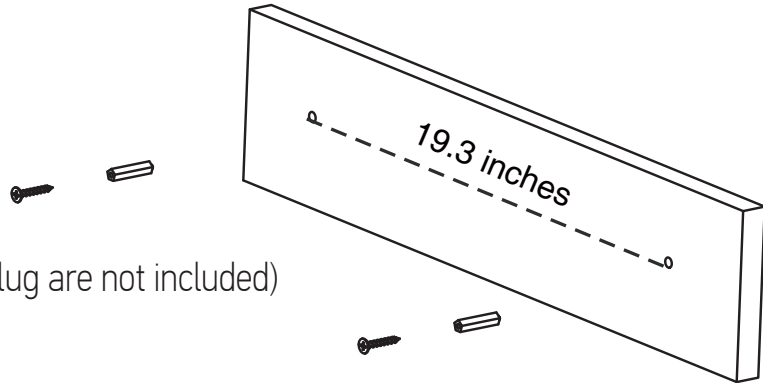

(screws and plastic fixing plug are not included)

- A. Mark the position of the mounting screws on the wall using a pencil.
- B. Drill 2 holes on wall with a powerful electric drill.
- C. Insert the fixing plug and hammer into the holes.
- D. Secure the screws into the fixing plug and leave approx. 0.3 inches length to hook the sound bar.
- E. Put the sound bar onto the mounting screws. Make sure they are firm and stable.

GENERAL OPERATION

1. Connect the Adapter to the unit and wall outlet. The red indicator will light.
2. Press and hold the STANDBY/SOURCE button on the unit or press the  button on remote control to power on the unit.
3. Press the STANDBY/SOURCE button on the unit or press the SOURCE on remote control repeatedly to switch to desired mode. The color of the mode indicator will turn to:

Bluetooth Indicator	Flashing Blue	Not paired to any Bluetooth device
	Solid Blue	Paired
Optical Indicator	Solid Indigo	Optical Mode
Line in Indicator	Solid Green	Line in Mode
Aux in Indicator	Solid Violet	Aux in Mode

NOTE: The indicators also function as a volume indicator. When the volume + / -

button is pressed, the LED indicators will flash up or go off one by one to show the increased or decreased volume, it will turn to solid light when the maximum or minimum volume is pressed.

4. Remote control setup:



- ~ Press the Vol+ or Vol- buttons to adjust volume.
- ~ Press the MUTE button on remote control to turn on or turn off the sound.
- ~ Press the NEWS on remote control to set the news sound effect.
- ~ Press the MOVIE on remote control to set the movie sound effect.
- ~ Press the MUSIC on remote control to set the music sound effect.
- ~ Press the BASS button on remote control repeatedly to set bass level.
- ~ Press the TREBLE button on remote control repeatedly to set treble level.

NOTE: Both BASS and TREBLE button have seven levels of adjustment with 0 as the default. A single press sequentially gives +1, +2, +3, -3, -2, -1 and back to 0.

5. When finish listening, press and hold the STANDBY/SOURCE button on unit or press the  button on remote control to power off the unit and put it into standby mode.

BLUETOOTH PAIRING AND CONNECTION

1. Power on the unit as previously explained.
2. Press the STANDBY/SOURCE button on the unit or press the SOURCE button on remote control repeatedly until the indicator turns to Blue and blinks.
3. Power on the external Bluetooth enable device and enter Bluetooth mode and try searching the unit.
4. When "SBB-55210" appears, select it and make connection.
5. After successful paired, the Blue indicator will stay lit.
6. During playback:

- ~ Press the  or  button on remote control to skip tracks.
- ~ Press the  button on remote control to pause, press it again to resume.

NOTE: The unit will be automatically connected with the last paired Bluetooth device if their Bluetooth function are activated and they are in working range.

OPTICAL DIGITAL AUDIO IN

1. Connect the Optical out jack from the external audio player (such as TV, DVD player etc.) to the OPTICAL IN jack on the rear of the unit with the optical connection cable as illustrated below: (For PCM format only)

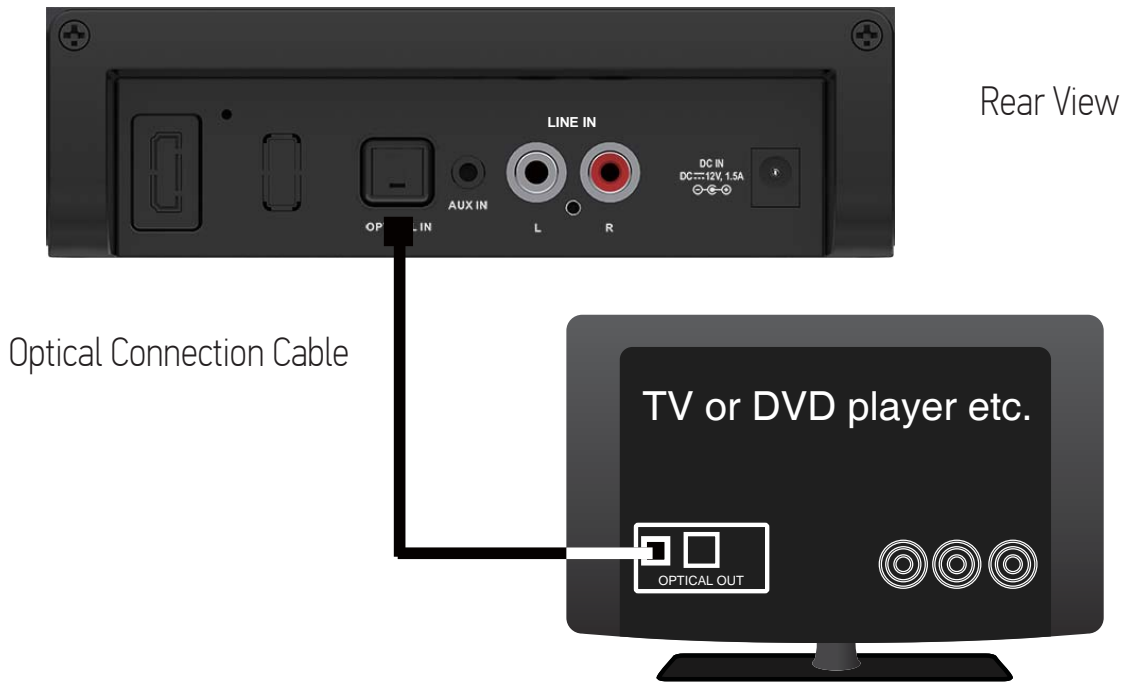

2. Power on the unit as previously explained.
3. Press the STANDBY/SOURCE button on the unit or press the SOURCE button on remote control repeatedly until the indicator turns to Indigo.
4. Power on the connected external player and start playback the music as usual. Turn on the digital audio output and set it to PCM (Plus Code Modulation) type similar to the follows figure:

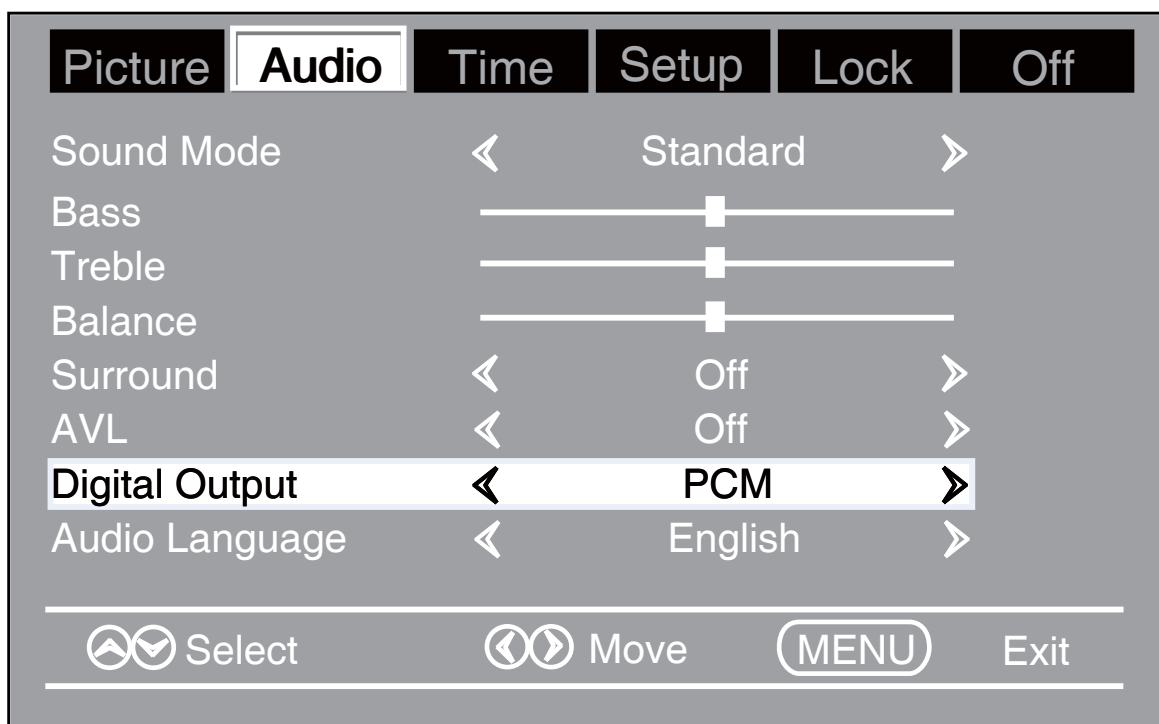

LINE IN

An external Audio/Video player(such as TV, DVD palyer etc.) can be connected to this unit and listen through the unit's speakers.

1. Plug one end of the Line In cable into the LINE IN jacks(L&R) on the unit.
2. Plug the other end of the line in cable into the Line Out jacks(L&R) on TV or DVD player etc.

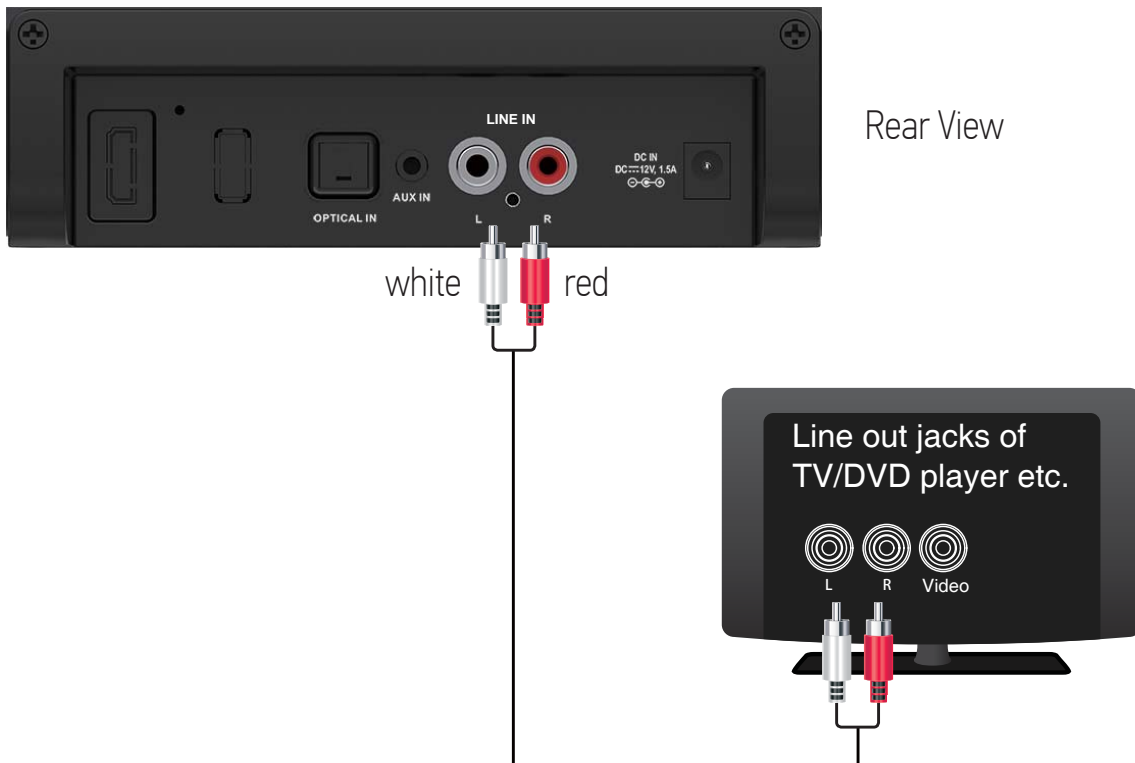

3. Power on the unit as previously explained.
4. Press the STANDBY/SOURCE button on the unit or press the SOURCE button on remote control repeatedly until the indicator turns to Green.
5. Power on the connected external player and start playback the music as usual.

AUX IN

An external Audio player(such as mobile phone, MP3 palyer etc.) can be connected to this unit and listen through the unit's speakers.

1. Plug one end of the AUX IN Cable into the AUX IN jack on the unit.
2. Plug another end of the AUX IN Cable into the headphone hack or Aux Out jack on the external audio player.



Rear View

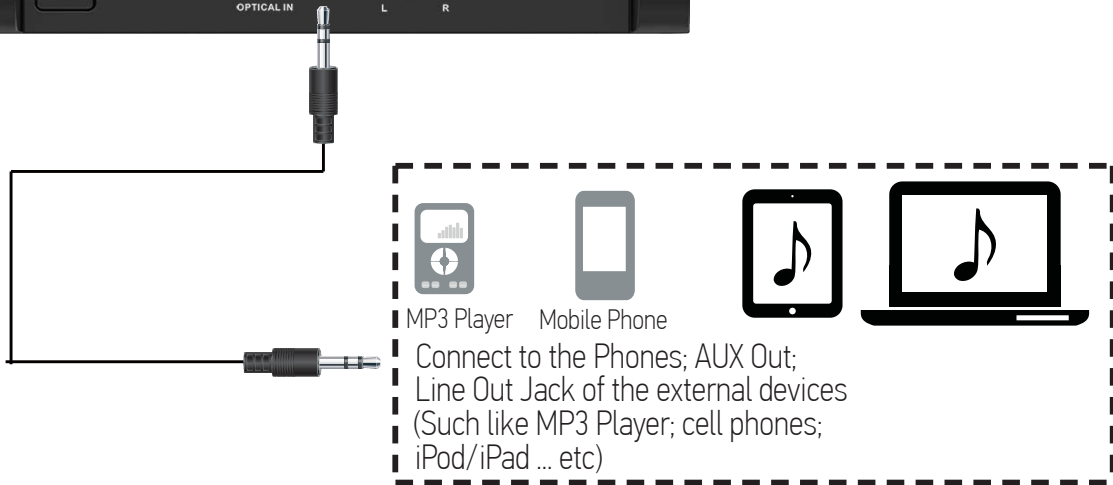



3. Power on the unit as previously explained.
4. Press the STANDBY/SOURCE button on the unit or press the SOURCE button on remote control repeatedly until the indicator turns to Violet.
5. Power on the connected external player and start playback the music as usual.

TROUBLESHOOTING GUIDE

SYMPTOM	POSSIBLE CAUSE	POSSIBLE SOLUTION
No power	The adapter is not connected	Conenct the adapter to the unit and wall outlet
	The unit is in standby mode	Press and hold STANDBY/SOURCE button on the unit or press the  button on remote control to power on the unit
No sound or sound weak	Volume level in minimum position	Raise the volume level by pressing the Vol + Button on the top of unit Or press VOL+ button on remote control
	The paired/connected device is not in playback mode	Play music/movie in the paired/ connected device as usual and make sure the volume level of it is in high level.
	Input source incorrect	Press the STANDBY/SOURCE button on the unit or press the SOURCE button on remote control to switch to desired mode

Sound distortion /rattle	Volume level too high	Reduce the volume level by pressing the Vol - Button on the top of the unit ,Or press VOL- button on remote control ,Reduce the volume level of the paired/ connected device.
Remote Control not functioning	Out of range	Point the remote contro closer to the infrared receiver on the unit within 16 feet, +/-30 degrees,make sure there are no obstacles in between
	The batteries in the remote control are drained	Replace with new battery
Bluetooth reception failure	The external device is too far from the unit	Put the external BT device close to the unit.
	Have not paired	Pair the unit with the BT Device as the procedures stated in this manual.

GENERAL SPECIFICATIONS

Power input	AC100~240V, 50/60Hz
Power output	DC12V  1.5A  
Audio output	2x10W
Bluetooth effextive working range in open area.....	up to 32 feet
Remote effective working range.....	up to 16 feet

FCC STATEMENT:

This device complies with part 15 of the FCC Rules. Operation is subject to the following two conditions:

- (1) This device may not cause harmful interference, and
- (2) This device must accept any interference received, including interference that may cause undesired operation.

Any Changes or modifications not expressly approved by the party responsible for compliance could void the user's authority to operate the equipment

This equipment complies with FCC radiation exposure limits set forth for an uncontrolled environment. This equipment should be installed and operated with minimum distance 20cm between the radiator & your body.

FCC NOTICE:

This equipment has been tested and found to comply with the limits for a Class B digital device, pursuant to Part 15 of the FCC Rules. These limits are designed to provide reasonable protection against harmful interference in a residential installation. This equipment generates, uses and can radiate radio frequency energy and, if not installed and used in accordance with the instructions, may cause harmful interference to radio communications. However, there is no guarantee that interference will not occur in a particular installation. If this equipment does cause harmful interference to radio or television reception, which can be determined by turning the equipment off and on, the user is encouraged to try to correct the interference by one or more of the following measures:

- Reorient or relocate the receiving antenna.
- Increase the separation between the equipment and receiver.
- Connect the equipment into an outlet on a circuit different from that to which the receiver is connected.
- Consult the dealer or an experienced radio/TV technician for help.

FCC STATEMENT:

To assure continued operation, follow the attached installation instructions and

use only shield cables when connecting to other devices. Changes or modifications not expressly approved by the party responsible for compliance could void the user's authority to operate the equipment.

IMPORTANT SAFETY INSTRUCTIONS



CAUTION: TO REDUCE THE ELECTRIC SHOCK, DO NOT REMOVE THE COVER (OR BACK). NO USER SERVICEABLE PART INSIDE, REFER SERVICING TO QUALIFIED SERVICE PERSONNEL.

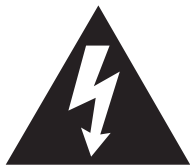

DANGEROUS VOLTAGE: The lightning flash with arrowhead symbol within an equilateral triangle is intended to alert the user to the presence of uninsulated “dangerous voltage” within the product’s enclosure that may be of sufficient magnitude to constitute a risk of electric shock to persons.



ATTENTION: The exclamation point within an equilateral triangle is intended to alert the user to the presence of important operating and maintenance (servicing) instructions in the literature accompanying the appliance.

Before using the unit, be sure to read all operating instruction carefully, please note that these are general precautions and may not pertain to your unit. For example, this unit may not have the capability to be connected to an outdoor antenna.

1. Read these instructions

All the safety and operating instructions should be read before the appliance is operated.

2. Keep these instructions

The safety and operating instructions should be kept for future reference.

3. Heed all warnings

All warnings on the appliance and in the operating instructions should be adhered to.

4. Follow all instructions

All operation and use instructions should be followed.

5. Do not use this apparatus near water

The appliance should not be used near water; for example, near a bath tub, washbowl, kitchen sink, laundry tub, in a wet basement, or near a swimming pool.

6. Clean only with dry cloth

The appliance should be cleaned only as recommended by the manufacturer.

7. Do not block any ventilation openings. Install in accordance with the manufacturer's instructions.

8. Outdoor antenna grounding

If an outside antenna is connected to the product, be sure the antenna system is grounded so as to provide some protection against voltage surges and built up static charges. Section 810 of the National Electric Code ANSI/ NFPA 70 provides information with respect to proper grounding of the mast and supporting structure, grounding of the lead-in wire to an antenna discharge product, size of grounding conductors, location of antenna-discharge product, connection to grounding electrodes and requirements for the grounding electrodes.

9. Service

Do not attempt to service this product yourself as opening or removing covers may expose you to dangerous voltage or other hazards. Refer all servicing to qualified service personnel.



is a trademark on a registered trademark of Bluetooth SIG Inc. All other trademarks and trade names are those of their respective owners.