



10.1" BLUETOOTH DVD PLAYER WITH WIRELESS HEADPHONES

User's Guide for Model PDB1077B

For the most up-to-date version of this User's Guide, go to www.gpx.com

Safety Instructions & Warnings

Important Safety Instructions

- Read these Instructions.
- Keep these Instructions.
- Heed all Warnings.
- Follow all instructions.
- Do not use this apparatus near water.
- Clean only with a dry cloth.
- Do not block any ventilation openings. Install in accordance with the manufacturer's instructions.
- Do not install near any heat sources such as radiators, heat registers, stoves, or other apparatus (including amplifiers) that produce heat.
- Do not defeat the safety purpose of the polarized or grounding - type plug. A polarized plug has two blades with one wider than the other. A grounding type plug has two blades and a third grounding prong. The wide blade or the third prong are provided for your safety. When the provided plug does not fit into your outlet, consult an electrician for replacement of the obsolete outlet.
- Protect the power cord from being walked on or pinched particularly at plugs, convenience receptacles, and the point where they exit from the apparatus.
- Only use attachments/accessories specified by the manufacturer.
- Unplug this apparatus during lightning storms or when unused for long periods of time.
- Refer all servicing to qualified service personnel. Servicing is required when the apparatus has been damaged in any way, such as power-supply cord or plug is damaged, liquid has been spilled or objects have fallen into the apparatus, the apparatus has been exposed to rain or moisture, does not operate normally, or has been dropped.
- Use only with a cart, stand, tripod, bracket, or table specified by the manufacturer, or sold with the apparatus. When a cart is used, use caution when moving the cart/apparatus combination to avoid injury from tip-over.



FCC Warnings

Warning: Changes or modifications to this unit not expressly approved by the party responsible for compliance could void the user's authority to operate the equipment.

NOTE: This equipment has been tested and found to comply with the limits for a Class B digital device, pursuant to Part 15 of the FCC Rules. These limits are designed to provide reasonable protection against harmful interference in a residential installation. This equipment generates, uses, and can radiate radio frequency energy and, if not installed and used in accordance with the instructions, may cause harmful interference to radio communications. However, there is no guarantee that interference will not occur in a particular installation. If this equipment does cause harmful interference to radio or television reception, which can be determined by turning the equipment off and on, the user is encouraged to try to correct the interference by one or more of the following measures:

- Reorient or relocate the receiving antenna.
- Increase the separation between the equipment and receiver.
- Connect the equipment into an outlet on a circuit different from that to which the receiver is connected.
- Consult the dealer or an experienced radio/TV technician for help.

FCC ID: OKUTDV31041

Battery Warnings

- **WARNING:** Do not ingest battery, Chemical Burn Hazard.
- If the remote control supplied with this product contains a coin/button cell battery and the coin/button cell battery is swallowed, it can cause severe internal burns in just 2 hours and can lead to death.
- Keep new and used batteries away from children. If the battery compartment does not close securely, stop using the product and keep it away from children.
- If you think batteries might have been swallowed or placed inside any part of the body, seek immediate medical attention.
- **CAUTION:** Danger of explosion if battery is incorrectly replaced. Replace only with the same or equivalent type.
- **WARNING:** There is a danger of explosion if you attempt to charge standard Alkaline batteries in the unit. Only use rechargeable NiMH batteries.
- Battery shall not be exposed to excessive heat such as sunshine, fire, or the like.
- Do not mix old and new batteries.
- Completely replace all old batteries with new ones.
- Do not mix alkaline, standard (carbon-zinc), or rechargeable (ni-cad, ni-mh, etc) batteries.
- Batteries should be recycled or disposed of as per state and local guidelines.

Additional Warnings and Precautions

- **CAUTION:** TO PREVENT ELECTRIC SHOCK, MATCH WIDE BLADE OF PLUG TO WIDE SLOT, FULLY INSERT.
- Mains plug is used as disconnect device and it should remain readily operable during intended use. In order to disconnect the apparatus from the mains completely, the mains plug should be disconnected from the mains socket outlet completely.
- **CAUTION:** Use of controls or adjustments or performance of procedures other than those specified may result in hazardous radiation exposure.
- **WARNING:** Changes or modifications to this unit not expressly approved by the party responsible for compliance could void the user's authority to operate the equipment.
- **WARNING:** Use of this unit near fluorescent lighting may cause interference regarding use of the remote. If the unit is displaying erratic behavior move away from any fluorescent lighting, as it may be the cause.
- **WARNING:** Shock hazard - Do Not Open.
- Caution and marking information is located at the rear or bottom of the apparatus.
- **WARNING:** To reduce the risk of fire or electric shock, do not expose this apparatus to rain, moisture, dripping, or splashing.
- Objects filled with liquids, such as vases, shall not be placed on the apparatus.
- **To avoid hearing damage**, make sure that the volume on your music player is turned down before connecting your headphones. After placing headphones in/on your ears, gradually turn up the volume until you reach a comfortable listening level.
- This product meets and complies with all Federal regulations.



WARNING: To reduce the risk of electric shock, do not remove cover (or back). No user-serviceable parts inside. Refer servicing to qualified service personnel.



The exclamation point within an equilateral triangle is intended to alert the user to the presence of important operating and maintenance (servicing) instructions in the literature accompanying the appliance.



The lightning flash with arrowhead symbol, within an equilateral triangle, is intended to alert the user to the presence of un-insulated "dangerous voltage" within the product's enclosure that may be of sufficient magnitude to constitute a risk of electric shock to persons.



This symbol indicates that this product incorporates double insulation between hazardous mains voltage and user accessible parts.



WARNING: This product can expose you to chemicals including lead, which is known to the State of California to cause cancer. For more information go to: www.P65Warnings.ca.gov



This product utilizes a Class 1 laser to read Compact Discs. This laser Compact Disc Player is equipped with safety switches to avoid exposure when the CD door is open and the safety interlocks are defeated. Invisible laser radiation is present when the CD Player's lid is open and the system's interlock has failed or been defeated. It is very important that you avoid direct exposure to the laser beam at all times. Please do not attempt to defeat or bypass the safety switches.

Table of Contents

Overview	5
DVD Player Features	
Wireless Headphone Features	
Includes	
Power & Charging	6
Portable DVD Player	
Headphones	
DVD Player	8
Controls & Features	
Loading and Playing a Disc	
Programming a Loaded Disc	
Remote	10
Functions	
Distance & Angle	
Batteries	
Wireless Headphones	12
Features & Controls	
Connecting to Other Devices	13
Pairing the Headphones and DVD Player	
Headphone 3.5mm Audio Line Input	
SD Memory Card	
USB Storage Device	
External Television or Screen	
Customer Support	16
Contact Information	
Warranty	
International Support	

Overview

DVD Player Features

- Bluetooth Wireless - 33 ft. range
- DVD/CD player
- 10.1" display
- 1024x600 native resolution
- 16:9 aspect ratio
- NTSC/PAL video system
- TTS (Voice Guide)
- SD/MMC card slot and USB port
- 3.5mm audio/video output
- Stereo headphone jack
- Built-in stereo speakers
- Built-in rechargeable battery - requires AC/DC power adapter (included)

Wireless Headphone Features

- Bluetooth Wireless - 33 ft. range
- Built-in microphone
- Aux In (3.5mm audio line input)
- Adjustable headband
- On-ear controls
- Built-in rechargeable battery

Includes

- Remote control
- AC/DC power adapter
- 12V DC car adapter
- Micro-USB to USB charging cable (for headphones)

Power & Charging

Portable DVD Player

The DVD player requires an AC/DC power adapter or 12V DC car adapter (both included) to charge the battery.

DVD Player Power Status	Indicator Light
Power ON + Charging complete	Green Light
Power OFF + Charging	Red Light
Power OFF + Charging Complete	Light OFF

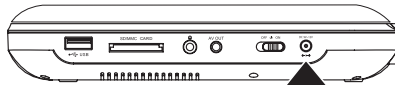

For normal use, plug the AC/DC adapter into the DC Power Port on the DVD player and a standard wall outlet.

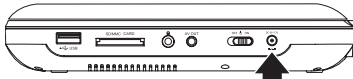
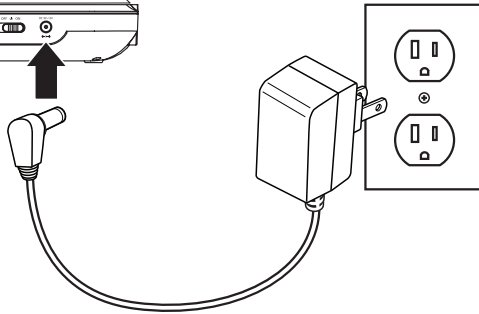

For use in a car, plug the 12V DC car adapter into the DC Power Port and a 12V power socket.

The car adapter is not compatible with a 24V power socket.

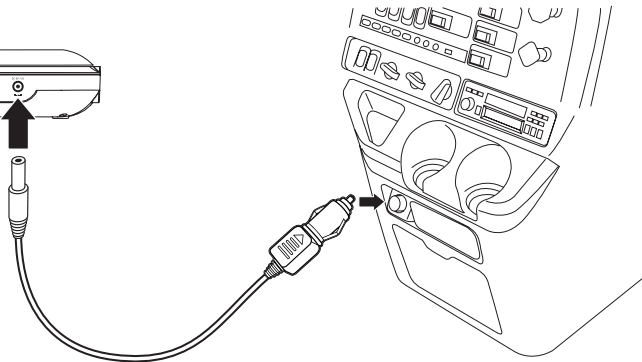

Headphones

The internal battery in the headphones requires a Micro-USB to USB cable (included) to charge. Charge fully before use. Initial charge time is approximately 2 hours. When battery is low, the LED indicator will flash red for one minute, then the headphones will automatically power off.

Headphones Power Status	Indicator Light
Battery Charging	Red Light
Charging Complete	Light OFF

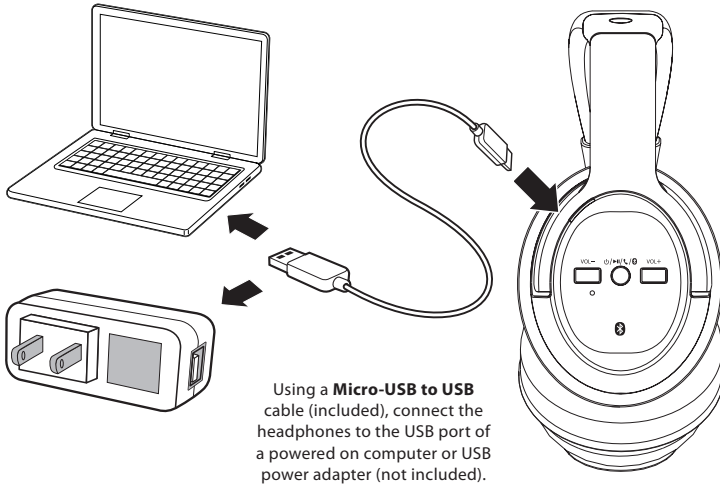

Notes About Batteries & Charging

- Do not charge for longer than 24 hours.
- Do not leave devices unattended while charging.
- Do not plug the car adapter into the 12V power socket until after the car ignition is on.
- Disconnect the car adapter from the power socket after use.
- The batteries in these devices are not replaceable. Attempting to remove the batteries may cause damage or personal injury, and will void your warranty.
- When not in use, recharge and store devices within a temperature range of 40°F - 95°F (5°C - 35°C).
- The battery life of all batteries naturally shortens over time.

DVD Player

Controls & Features

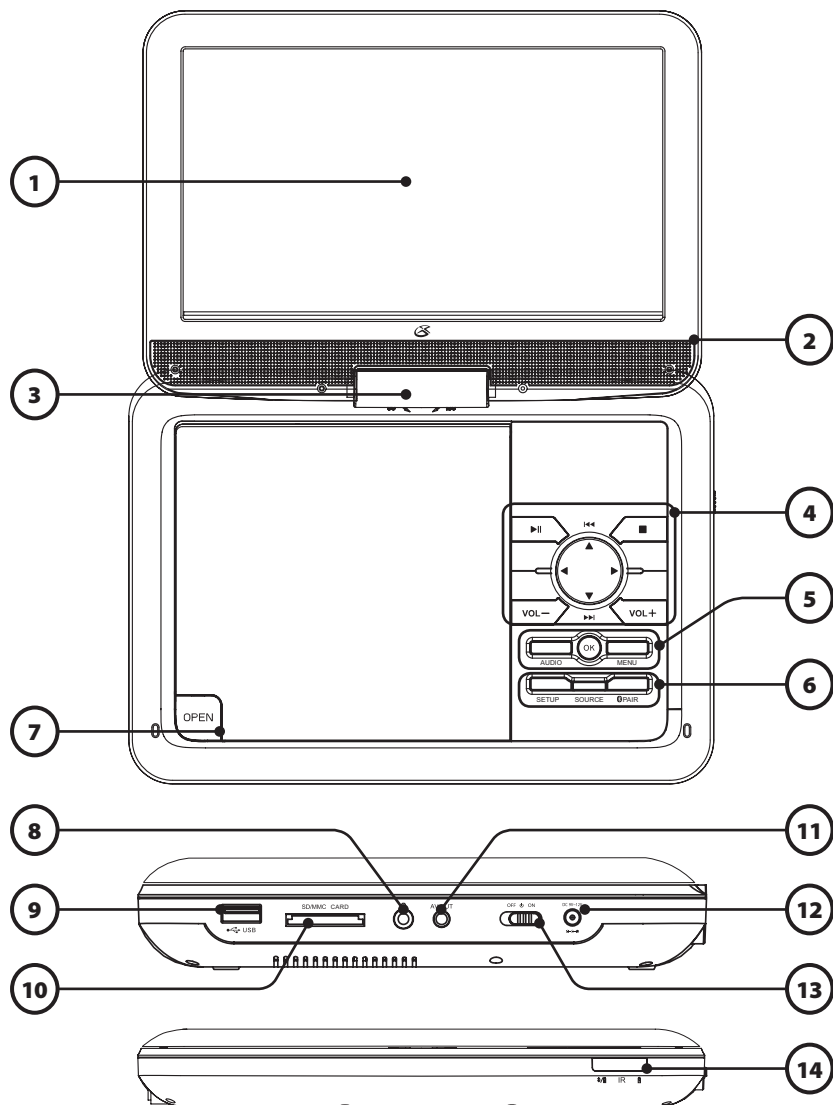

1. 10.1" Display

2. Built-in Stereo Speakers

3. Display Swivel Joint

Adjusts viewing and rotation angle up to 180°.

4. Play Controls

Press **▶||** to play or pause a loaded disc.

Press **■** to stop playing a loaded disc.

Press **◀◀ ▶▶** to skip tracks or chapters.

Press **VOL- VOL+** to adjust the volume level.

Press **◀▶▲▼** for menu navigation.

5. Audio / OK / Menu

Press **Audio** to adjust audio settings for a loaded DVD, including Voice Description and DVD commentary (if available).

Press **OK** to confirm selections.

Press **Menu** to access DVD menus.

6. Setup / Source / Pair

Press **Setup** to access DVD player menus, settings, and options.

Press **Source** to switch between DVD, CARD, and USB modes. Press **OK** to confirm selection.

Press and hold ** Pair** to pair to the included headphones (see pg. 13).

7. Disc Player

Press **Open** to open the disc door. Load CDs or DVDs label side facing up.

8. Stereo Headphone Jack

9. USB Port

10. SD Card Slot

11. 3.5mm AV Out

Use a 3.5mm to RCA audio/video cable (not included) to connect to another device or screen and play media through the AV Output.

12. DC Power Port

Connect power adapter (2x included) to charge battery and power the unit.

13. Power Switch

Slide to power ON or OFF.

14. Remote Sensor / LED Indicators

Aim remote at this sensor (see pg. 11).

Power ON + Battery Charging - Solid green light.

Charging Battery - Solid red light (player OFF).

Charging Complete - No lights.

Bluetooth Unpaired - Flashing blue light.

Bluetooth Paired - Solid blue light.

Loading and Playing a Disc

1. Press **Open** to open the **Disc Door**.
2. Load a disc into the player, label side facing up, then close the disc door.
3. After a disc is loaded, it will begin playing automatically. If the disc does not begin playing automatically, press the **Play/Pause** button. Use the controls on the player or the remote to play media, navigate settings menus, etc.

Programming a Loaded Disc

1. While the loaded disc is playing, press the **Prog** button on the remote.
2. Use the **Arrow** buttons to select a program slot.
3. Use the **Number Keypad** to enter in the chapter and title, or track.
4. Use the **Arrow** buttons to highlight the on-screen **START** button and press the **OK** button to begin playing.

Remote

Functions

Display ON/OFF
Power the screen ON or OFF.

Number Keypad
Enter chapter / track numbers.

Setup
Press to access the setup menu.

Arrows/OK
Press to make selections in the on screen or disc menus.

◀◀ Previous / Next ▶▶
Press to skip between chapters or tracks.

◀◀ Back / Fwd ▶▶

Press to search through an individual chapter or track.

▶|| Play / Pause

Press to play or pause.

OSD (On Screen Display)

Displays chapter, title, or track information.

Subtitle

Press to cycle through subtitles-English, French, Spanish, or OFF.

Step

Press to advance playback one frame at a time.

Angle

Press to view alternate angles on supported DVDs.

Zoom

Press to zoom in or out on a loaded DVD.

Prog

Press to program a loaded disc to play titles, chapters, or tracks in a specified order.

TTS (Voice Guide)

Press to turn Talk-to-Text ON or OFF (intended for visually impaired users).

TTS announces menus and remote functions.

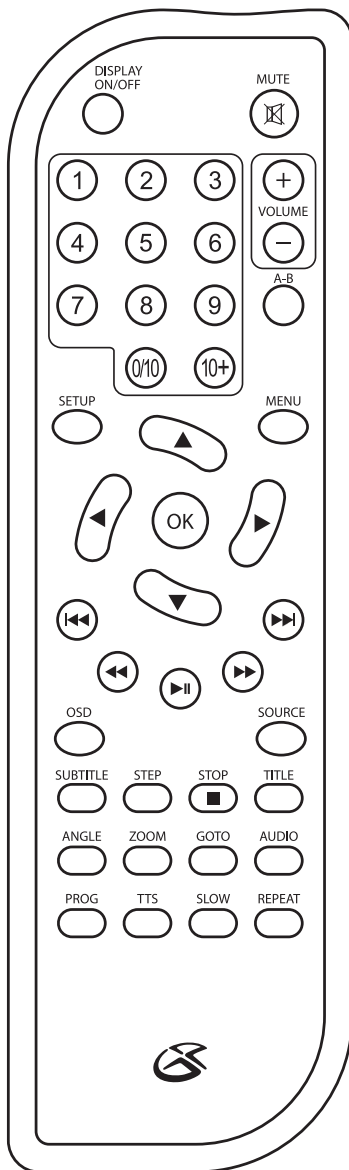

Mute
Press to mute volume.

Volume
Press to adjust audio level.

Note: Volume cannot be adjusted from the wireless headphones.

A-B
Create a repeating loop on a CD, DVD, or media file.

Press to set A point (start), press again to set B point (end).

Press a third time to cancel.

Menu (DVD)

Press to access DVD menus.

Source

Press and use the Arrow/OK buttons to select the source.

■ Stop

Press to stop playback.

Title

Press to access the title menu on a loaded DVD.

Press again to play DVD from the beginning.

Go To

On a loaded disc, press to quickly go to a specific track or chapter.

Use the Arrow/OK buttons to enter and confirm your selection.

Audio

For DVD play, press to adjust audio settings for the DVD, including Voice Description and DVD commentary (if available).

Angle

Press to view alternate angles on supported DVDs.

Slow

Press to select slow motion play speed.

Repeat

Press to repeat the current selection or track.

Distance & Angle

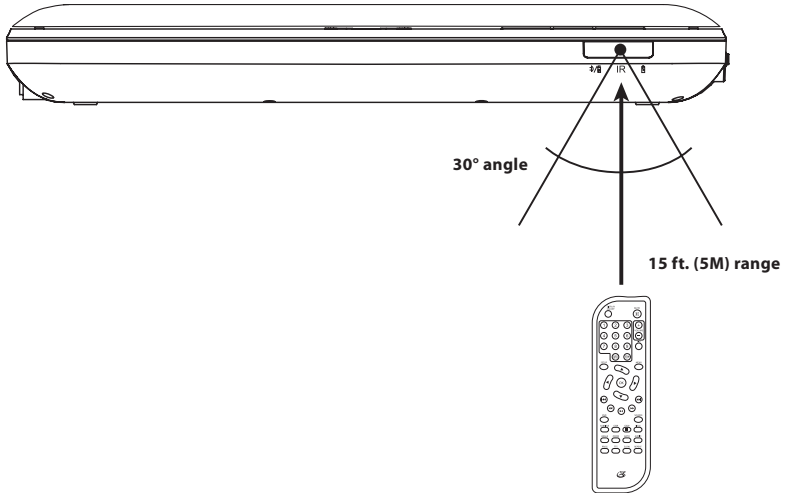

Batteries

Requires 2 AAA batteries (not included).

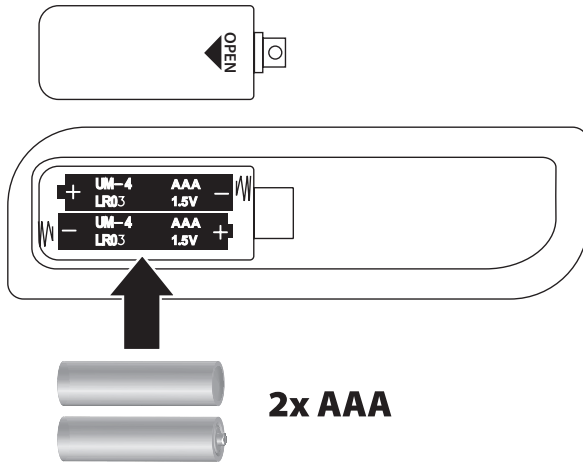

Wireless Headphones

Features & Controls

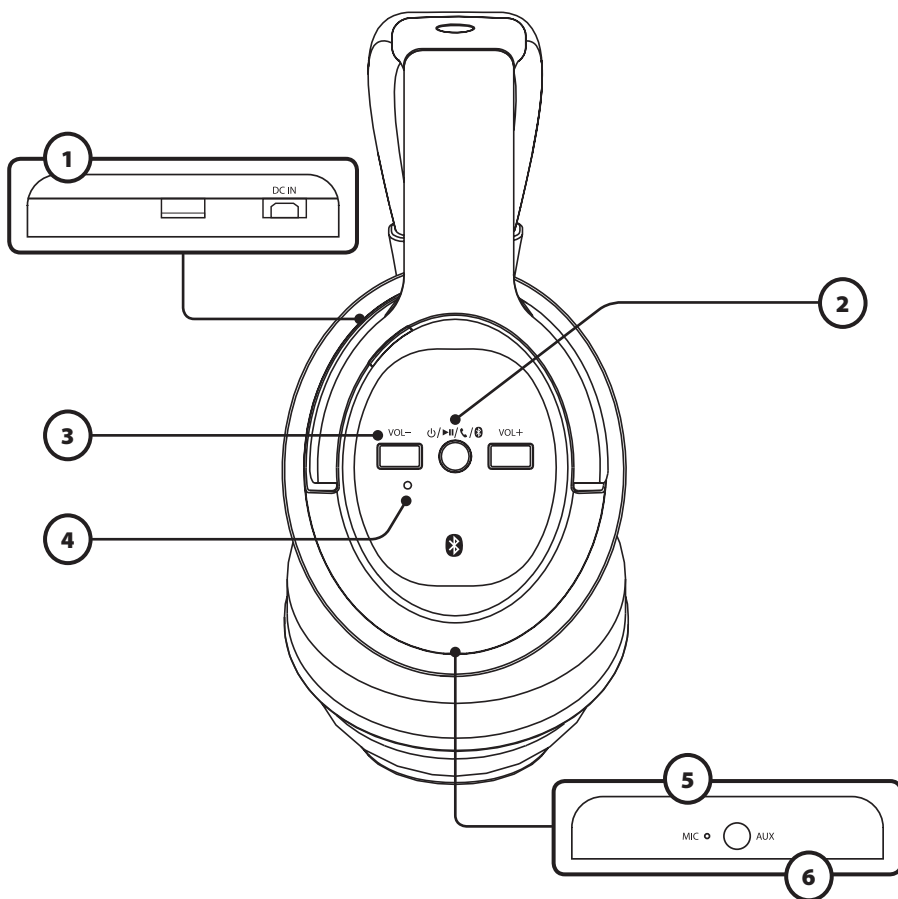

1. DC Power Port

Connect Micro-USB to USB power cable (included) to charge battery.

2. Power / Play / Speakerphone / Pair

Power ON + Pair Bluetooth - Press and hold until blue/red flashing indicator and voice prompt.

Power ON - Press and hold for 5 seconds to power ON or OFF.

Play/Pause - Press to play or pause audio.

Speakerphone - Press to answer incoming call.

3. Volume

Press VOL- VOL+ to adjust the volume level.

4. LED Indicator Light

Power ON + Bluetooth Paired - Solid blue light.

Pairing Bluetooth - Flashing blue/red light.

Charging Battery - Solid red light.

Charging Complete - No lights.

5. Microphone

6. Aux In (3.5mm audio line input)

Connecting to Other Devices

Pairing the Headphones and DVD Player

After initial pairing, the DVD player and the headphones will stay paired unless unpaired manually by the user, or erased due to a reset of either device. If this occurs or you find either unit is unable to connect, repeat these steps.

1. **On the headphones**, press and hold the **⏪/▶II/⏩/⏻** button until the pairing indicator begins flashing red and blue and a voice announces "Bluetooth is connecting." *When pairing, remain within 3 feet of the unit.*
2. **On the DVD player**, press and hold the **Pair** button **until** the LED indicator begins quickly flashing blue.
3. When successfully paired, the LED indicators on both the headphones and the DVD player will turn solid blue and a voice will announce "Bluetooth connected" through the headphones. Media played from the DVD player will now be heard through the headphones.
4. Use the controls on the DVD player to select and play media. Note: The volume controls on the DVD player and remote will not adjust volume of the headphones.
5. After initial pairing to the DVD player, press and hold the **⏪/▶II/⏩/⏻** button for approximately 5 seconds. The headphones will power ON and automatically reconnect with the DVD player. *Make sure the DVD player is also powered ON.*

Headphone 3.5mm Audio Line Input

Requires a 3.5 mm audio input cable (not included).

1. Using a 3.5 mm audio input cable, connect the **Headphone Jack** on the portable DVD player to the **Aux In** (3.5mm audio input) on the headphones.
2. The portable DVD player will automatically detect the connection and media from the player will be heard through the headphones.

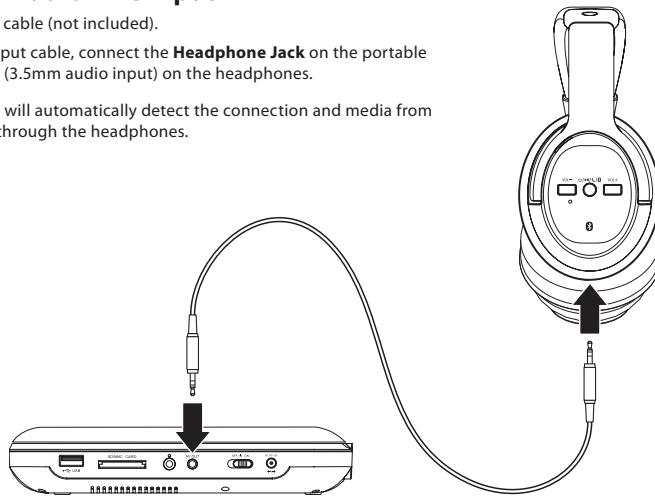

Connecting to Other Devices

SD Memory Card

Supports SD cards up to 32GB.

Supports JPEG, AVI, VOB, MPEG 1, MPEG 2 and MPEG 4 file formats.

1. Load an SD card into the **SD card slot**.
2. Set the **Source** to **CARD**.
3. Use the **Arrow/OK** buttons to select and play content from the connected SD card.

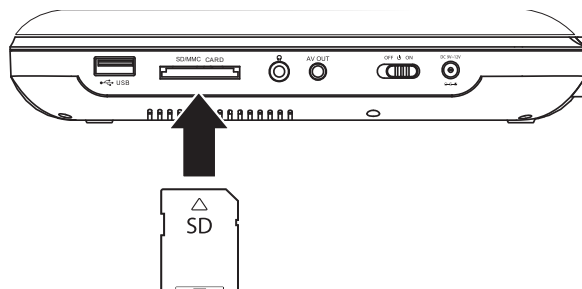

USB Storage Device

Supports USB drives up to 32GB.

Supports JPEG, AVI, VOB, MPEG 1, MPEG 2 and MPEG 4 file formats.

1. Load a USB drive into the **USB Port**.
2. Set the **Source** to **USB**.
3. Use the **Arrow/OK** buttons to select and play content from the connected USB thumb drive.

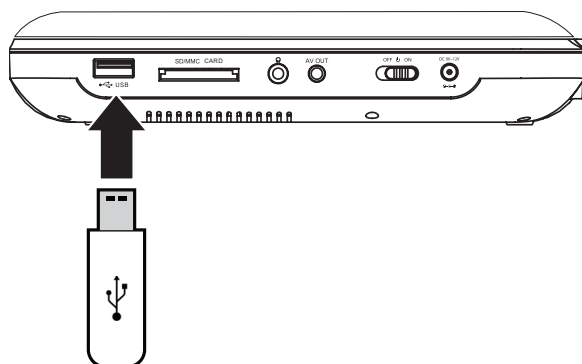

External Television or Screen

Requires 3.5mm to RCA Composite AV cable (red/white/yellow, not included).

1. Using an 3.5mm to RCA Composite cable, connect the **Audio/Video Output** on the portable DVD player to the corresponding **Audio/Video Inputs** on a television or other external system.
2. Set the television's input source to the connected output from the DVD player.
3. The portable DVD player will automatically detect the connection and media from the player will be played through the television. Use the controls on the portable DVD player and remote to select and play media. Use the controls on the television to adjust volume.

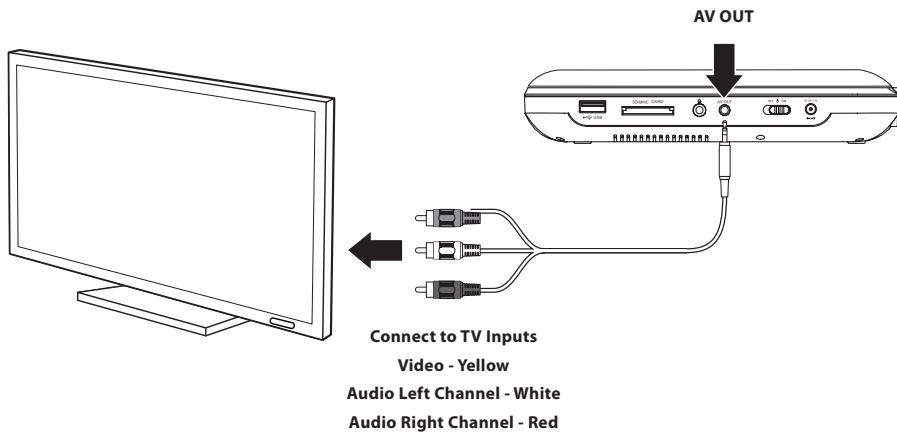

NOTE: The portable DVD player's audio output sends a fixed volume level to any connected device. To adjust the volume you must change it from the connected device. Adjusting the volume of the DVD player will have no effect.

Customer Support

Contact Information

Website: www.gpx.com

Email Support: prodinfo@dpiinc.com

Email Parts: partsinfo@dpiinc.com

Phone Support: 1-888-999-4215

Warranty

For Warranty Information and the most up-to-date version of this User's Guide, go to: www.gpx.com

International Support

To download this User's Guide in English, Spanish, and French, or to get answers to frequently asked questions, visit the support section at:

www.gpx.com

Para descargar este Manual del Usuario en inglés, español y francés, o para obtener respuestas a preguntas frecuentes, visite la sección de apoyo en: www.gpx.com

Pour télécharger ce guide de l'utilisateur en anglais, espagnol ou français, ou pour obtenir des réponses à des questions fréquemment posées, consultez la rubrique d'assistance sur: www.gpx.com

Copyright © 2017 Digital Products International (DPI, Inc.) All other trademarks appearing herein are the property of their respective owners. Specifications are subject to change without notice.



*Protect for Today
Sustain for Tomorrow*