



MAGNAVOX

TOWER SPEAKER

with Bluetooth® Wireless Technology

OWNER'S MANUAL

PLEASE READ BEFORE OPERATING THIS EQUIPMENT.

MODEL: MHT843n

Size: 148.5(W) x 210(H)mm (A5)

IMPORTANT SAFETY INSTRUCTIONS



CAUTION
RISK OF ELECTRIC SHOCK
DO NOT OPEN



CAUTION: TO REDUCE THE RISK OF ELECTRIC SHOCK, DO NOT REMOVE COVER (OR BACK). NO USER-SERVICEABLE PARTS INSIDE. REFER SERVICING TO QUALIFIED SERVICE PERSONNEL.



The lightning flash with arrowhead symbol within an equilateral triangle is intended to alert the user to the presence of uninsulated dangerous voltage within the product's enclosure that may be of sufficient magnitude to constitute a risk of electric shock to persons.



The exclamation point within an equilateral triangle is intended to alert the user to the presence of important operating and maintenance(servicing) instructions in the literature accompanying the appliance.

WARNING:
TO REDUCE THE RISK OF FIRE OR ELECTRIC SHOCK, DO NOT EXPOSE THIS PRODUCT TO RAIN OR MOISTURE.

WARNING:
TO REDUCE THE RISK OF FIRE OR ELECTRIC SHOCK, AND ANNOYING INTERFERENCE, USE THE RECOMMENDED ACCESSORIES ONLY.

FCC NOTICE:

This equipment has been tested and found to comply with the limits for a Class B digital device, pursuant to part 15 of the FCC Rules. These limits are designed to provide reasonable protection against harmful interference in a residential installation. This equipment generates, uses and can radiate radio frequency energy and, if not installed and used in accordance with the instructions, may cause harmful interference to radio communications.

However, there is no guarantee that interference will not occur in a particular installation. If this equipment does cause harmful interference to radio or television reception, which can be determined by turning the equipment off and on, the user is encouraged to try to correct the interference by one or more of the following measures:

- Reorient or relocate the receiving antenna.
- Increase the separation between the equipment and receiver.
- Connect the equipment into an outlet on a circuit different from that to which the receiver is connected.
- Consult the dealer or an experienced radio/TV technician for help.

This equipment should be installed and operated with minimum distance 20cm between the radiator and your body.

FCC WARNING:

To assure continued compliance, follow the attached installation instructions and use only shielded cables when connecting to other devices. Modifications not authorized by the manufacturer may void user's authority to operate this device.

IMPORTANT SAFETY INSTRUCTIONS

Before using the unit, be sure to read all operating instructions carefully. Please note that these are general precautions and may not pertain to your unit.

For example, this unit may not have the capability to be connected to an outdoor antenna.

1) **Read these instructions.**

All the safety and operating instructions should be read before the product is operated.

2) **Keep these instructions.**

The safety and operating instructions should be retained for future reference.

3) **Heed all warnings.**

All warnings on the product and in the operating instructions should be adhered to.

4) **Follow all instructions.**

All operating and use instructions should be followed.

5) **Do not use this apparatus near water.**

Do not use this product near water and moisture, for example: near a bathtub, washbowl, kitchen sink or laundry tub; in a wet basement; or near a swimming pool.

6) **Clean only with dry cloth.**

Unplug this product from the wall outlet before cleaning. Do not use liquid cleaners or aerosol cleaners. Use a dry cloth for cleaning.

7) **Do not block any ventilation openings. Install in accordance with the manufacturer's instructions.**

Slots and openings in the cabinet and in the back or bottom are provided for ventilation, to ensure reliable operation of the product and to protect it from overheating. These openings must not be blocked or covered. The openings should never be blocked by placing the product on a bed, sofa, rug or other similar surface. This product should never be placed near or over a radiator or heat source. This product should not be placed in a built-in installation such as a bookcase or rack unless proper ventilation is provided or the manufacturer's instructions have been adhered to.

8) **Do not install near any heat sources such as radiators, heat registers, stoves, or other apparatus (including amplifiers) that produce heat.**

9) **Do not defeat the safety purpose of the polarized or grounding-type plug. A polarized plug has two blades with one wider than the other. A grounding type plug has two blades and a third grounding prong. The wide blade or the third prong are provided for your safety. If the provided plug does not fit into your outlet, consult an electrician for replacement of the obsolete outlet.**

10) **Protect the power cord from being walked on or pinched particularly at plugs, convenience receptacles, and the point where they exit from the apparatus.**

11) **Only use attachments/accessories specified by the manufacturer.**

12) **Use only with the cart, stand, tripod, bracket, or table specified by the manufacturer, or sold with the apparatus. When a cart is used, use caution when moving the cart/apparatus combination to avoid injury from tip-over.**

An appliance and cart combination should be moved with care.

Quick stop, excessive force and uneven surfaces may cause the appliance and cart combination to overturn.



Portable Cart Warning

13) **Unplug this apparatus during lightning storms or when unused for long periods of time.**

To protect your product from a lightning storm, or when it is left unattended and unused for long periods of time, unplug it from the wall outlet and disconnect the antenna or cable system. This will prevent damage to the product due to lightning and power-line surges.

14) **Refer all servicing to qualified service personnel. Servicing is required when the apparatus has been damaged in any way, such as power-supply cord or plug is damaged, liquid has been spilled or objects have fallen into the apparatus, the apparatus has been exposed to rain or moisture does not operate normally, or has been dropped.**

15) **Power source**

This product should be operated only from the type of power source indicated on the marking label.

If you are not sure of the type of power supply to your home, consult your appliance dealer or local power company. For products intended to operate from battery power, or other source, refer to the operation instructions.

16) **Power lines**

An outside antenna system should not be located in the vicinity of overhead power lines or other electric light or power circuits, or where it can fall into such power lines or circuits. When installing an outside antenna system, extreme care should be taken to keep from touching such power lines or circuits as contact with them might be fatal.

IMPORTANT SAFETY INSTRUCTIONS

17) Overloading

Do not overload wall outlets and extension cords as this can result in a risk of fire or electric shock.

18) Object and liquid entry

Never push objects of any kind into the product through openings as they may touch dangerous voltage points or short out parts that could result in fire or electric shock. Never spill or spray any type of liquid on the product.

19) Outdoor antenna grounding

If an outside antenna is connected to the product, be sure the antenna system is grounded so as to provide some protection against voltage surges and built up static charges. Section 810 of the National Electric Code ANSI/NFPA 70 provides information with respect to proper grounding of the mast and supporting structure, grounding of the lead-in wire to an antenna discharge product, size of grounding conductors, location of antenna-discharge product, connection to grounding electrodes and requirements for the grounding electrodes.

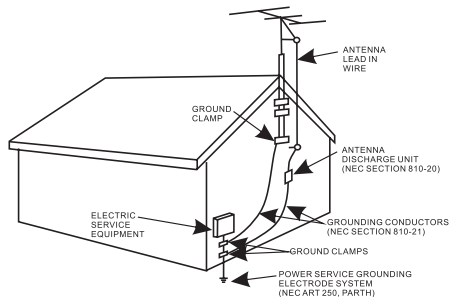

20) Service

Do not attempt to service this product yourself as opening or removing covers may expose you to dangerous voltage or other hazards. Refer all servicing to qualified service personnel.

21) Replacement parts

When replacement parts are required, be sure the service technician uses replacement parts specified by the manufacturer or those that have the same characteristics as the original parts. Unauthorized substitutions may result in fire or electric shock or other hazards.

22) Safety check

Upon completion of any service or repairs to this product, ask the service technician to perform safety checks to determine that the product is in proper operational condition.

23) Wall or ceiling mounting

The product should be mounted to a wall or ceiling only as recommended by the manufacturer.

24) Damage requiring service

Unplug this product from the wall outlet and refer service to qualified service personnel under the following conditions.

- When the power-supply cord or plug is damaged.
- If liquid has been spilled or objects have fallen into the product.
- If the product has been exposed to rain or water.
- If the product does not operate normally by following the operating instructions. Adjust only those controls that are covered by the operating instructions, as an adjustment of other controls may result in damage and will require extensive work by a qualified technician to restore in the product to its normal operation.
- If the product has been dropped or the cabinet has been damaged.
- When the product exhibits a distinct change in performance—this indicates a need for service.

25) Note to CATV system installer

This reminder is provided to call the CATV system installer's attention to Article 820-40 of the NEC that provides guidelines for proper grounding and, in particular, specifies that the cable ground shall be connected to the grounding system of the building, as close to the point of cable entry as practical.

NOTE: Refer all servicing to qualified service personnel. Servicing is required when the unit has been damaged in any way such as the following: the power-supply cord or plug has been damaged, liquid has been spilled into unit, the unit has been exposed to rain or moisture, the unit has been dropped or the unit does not operate normally.

LOCATION OF CONTROLS

TOP PANEL

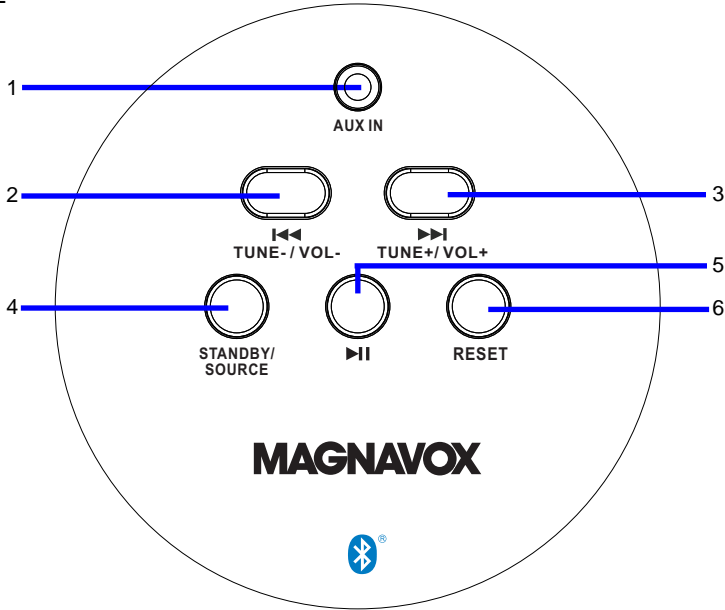

FRONT VIEW

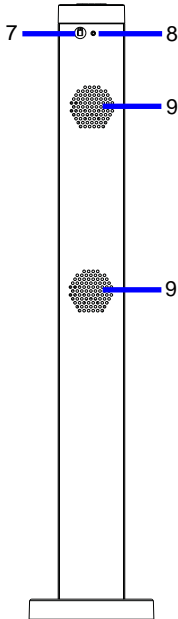

REAR PANEL

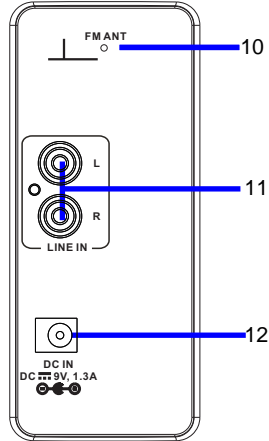

1. AUX IN Jack
2. ◀◀ /TUNE-/VOL- (Skip backward/Tuning down/Volume down) Button
3. ▶▶ /TUNE+/VOL+ (Skip forward/Tuning up/Volume up) Button
4. STANDBY/SOURCE Button
5. ▶|| (Play/Pause) Button
6. RESET Button
7. Remote Sensor
8. Indicator
9. Speakers
10. FM ANT (FM wire antenna)
11. LINE IN Jacks
12. DC IN Jack

REMOTE CONTROL

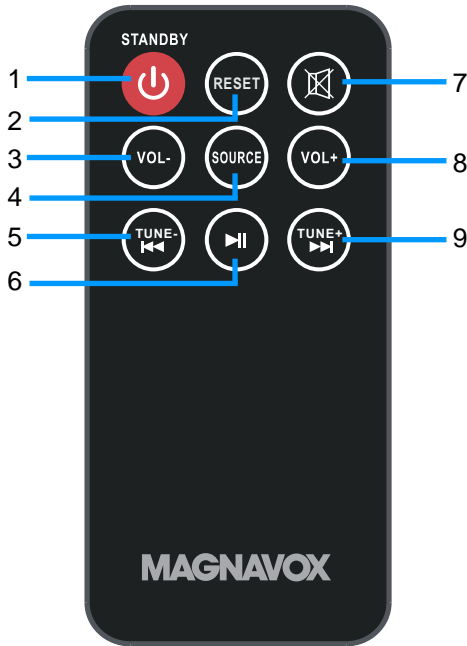

1. ⏻/STANDBY Button
2. RESET Button
3. VOL- (Volume Down) Button
4. SOURCE Button
5. ⏮/TUNE- (Skip backward/
Tuning down Button
6. ⏪ (Play/Pause) Button
7. 🔇 (Mute) Button
8. VOL+ (Volume Up) Button
9. ⏭/TUNE+ (Skip forward/
Tuning up Button

BATTERY INSTALLATION (REMOTE CONTROL)

First Time Use:

Remove and discard the insulation film as illustrated on the right.

If the button cell is drained, replace it by a new one as below:

1. Push and slide out the button cell holder as Fig.1 below.
2. Replace the button cell with a new CR2025 button cell as the polarity markings on the rear of the Remote Control as Fig.2 below.
3. Close the button cell holder as Fig.3 below.

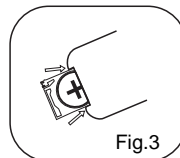
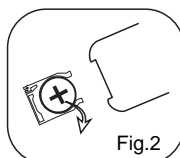
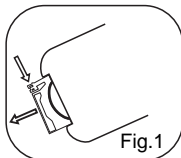
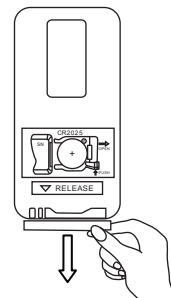

BATTERY PRECAUTIONS:

Follow these Battery Precaution when using a battery in this device:

1. Use only the size and type of battery specified.
2. Be sure to follow the correct polarity when installing the battery as indicated in the battery compartment. A reversed battery may cause damage to the device.
3. Do not mix different types of batteries together (e.g. Alkaline and Carbon-zinc) or old batteries with fresh ones.
4. If the batteries in the device are consumed or the device is not to be used for a long period of time, remove the batteries to prevent damage or injury from possible battery leakage.
5. Do not try to recharge the battery not intended to be recharged; it can overheat and rupture. (Follow battery manufacturer's instructions.)
6. Do not dispose of battery in fire. Battery may explodes or leak.
7. Clean the battery contacts and also those of the device prior to battery installation.

8.  This product contains a coin/button cell battery. If the coin/button cell battery is swallowed, it can cause severe internal burn in just 2 hours and can lead to death.

Keep new and used batteries away from children. If the battery compartment does not close securely, stop using the product and keep it away from children.

If you think batteries might have been swallowed or placed inside any part of the body, seek immediate medical attention.

EFFECTIVE DISTANCE OF REMOTE TRANSMITTER

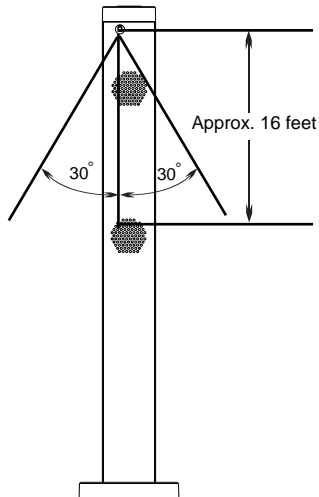

NOTES:

- When there is an obstacle between the unit and the transmitter, the unit may not operate.
- When direct sunlight, an incandescent lamp, fluorescent lamp or any other strong light shines on the REMOTE SENSOR of the unit, the operation of the remote may be unstable.

POWER SOURCE

Connect the small plug from supplied AC/DC Adaptor to the DC IN Jack on the rear of unit then plug the AC/DC Adaptor to a wall outlet having AC 100-240V~; 50/60Hz. The Red Standby Indicator on the top of unit will illuminate.

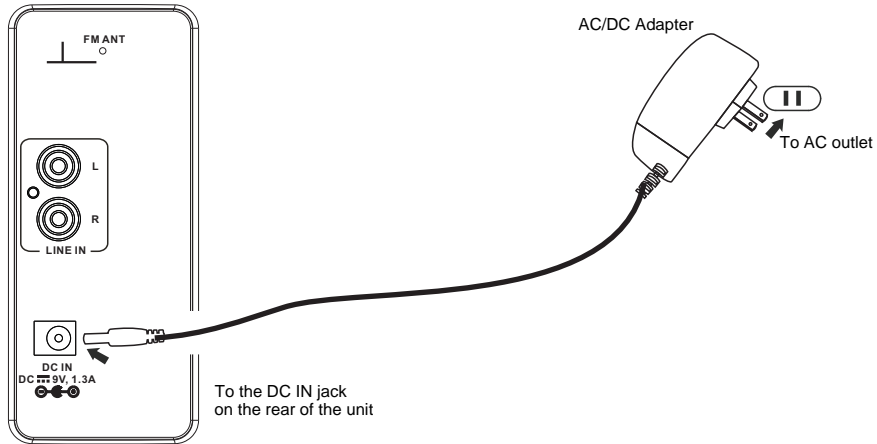

NOTES:

- If you will not use the unit for an extended period of time, unplug the AC/DC Adaptor from wall outlet.
- The AC/DC Adaptor is intended to be correctly orientated in a vertical or floor mount position.

OPERATION

GENERAL OPERATION:

1. Connect the supplied AC/DC Adaptor to the unit and wall outlet as previously instructed. The Red Standby Indicator on the top of unit will illuminate.
2. Press and hold the **STANDBY/SOURCE** Button on the top of unit or press the **⏻/STANDBY** Button on the Remote Control to turn on the unit from standby mode. The color of the indicator will turn to correspondent color. You will also hear an audible say "**Power on**".
3. Press the **STANDBY/SOURCE** Button on the top of unit or press the **SOURCE** Button on the Remote Control repeatedly to switch to desired playback mode. The color of the indicator will turn to correspondent with your selection (see list below):

<u>Playback Mode:</u>	<u>Color of Indicators:</u>
BT (Bluetooth)	Blue (and blinking)
FM Radio	Green
LINE IN	Purple (Red + Blue)
AUX IN	Orange (Red + Green)

4. During playback,
 - Press the **⏮/Tune -/VOL -** or **⏭/Tune +/VOL +** buttons on the unit or the **VOL +/-** buttons on the Remote Control to adjust volume level as desired.
 - Press the **🔇 (MUTE)** Button on the Remote Control to turn off the sound temporary, press again to turn it back.
 - Press and hold the **SOURCE/LED 1** Button on the top of unit to power On/Off all the Decorative LED Lights.
5. When finished, press and hold **STANDBY/SOURCE** Button on the top of unit or press the **⏻/STANDBY** Button the Remote Control to turn the unit to standby mode. The color of the Indicator will turn to Red.
6. If you will not use the unit for an extended period of time, unplug the AC/DC Adaptor from wall outlet.

BT (Bluetooth):

Listen music from external BT device:

BT (Bluetooth) pairing:

First time use or re-pairing the unit to a new BT Device, pair as follows:

1. Power on the unit as previously instructed.
2. Press the **STANDBY/SOURCE** Button on the top of unit or press the **SOURCE** Button on the Remote Control repeatedly until the color of the indicator turn to Blue and blink.
3. Power on the external BT Device and enter to BT searching mode. Start pairing following the on screen instructions from the external BT Device. After paired, the Blue Indicator will stop blinking.
4. If pairing is complete you may now play music with your external BT Device.
5. During playback:
 - Press the **▶||** Button on the unit or Remote Control to pause, press again to resume normal playback.
 - Press the **⏏ (MUTE)** Button on the Remote Control to turn off the sound temporary, press again to turn it back.
 - Press the **◀◀/Tune -/VOL -** or **▶▶/Tune +/VOL +** buttons on the unit or the **VOL +/-** buttons on the Remote Control to adjust volume level as desired.
 - Press and hold the **◀◀/Tune -/VOL -** or **▶▶/Tune +/VOL +** buttons on the unit or press the **◀◀/Tune -** or **▶▶/Tune +** buttons on the Remote Control to skip tracks.

Notes:

- When the external BT Device searched the unit, our model number "**MHT843n**" will appear on the display of external BT Device.
- If while pairing you are asked for a code please try "**0000**" or "**1234**".

Normal operation after pairing:

1. Power on the external BT Device and enter to BT playback mode.
2. Power on the unit and enter to BT mode as previously instructed. The color of the indicator will turn to Blue and blink.
3. Wait a few seconds until the unit is automatically paired to the external BT Device. (The Blue Indicator will stop blinking).
4. After pairing is complete you may now play music with your external BT Device.

FM Radio:

1. Power on the unit as previously instructed.
2. Press the **STANDBY/SOURCE** Button on the top of unit or press the **SOURCE** Button on the Remote Control repeatedly until the color of the indicator turn to Green.
3. Press and hold the **◀◀/Tune -/VOL -** or **▶▶/Tune +/VOL +** buttons on the unit or press the **◀◀/Tune -** or **▶▶/Tune +** buttons on the Remote Control to search and play the next/previous available FM station.
4. Repeat the same procedures until the desired station was search and play.
5. If you want researching the stations from beginning (87.5MHz), press the **RESET** Button on the unit or Remote Control then search the Radio station as point 3 above again.

Antennas:

This unit has a FM wire antenna on the rear of unit, which provides adequate reception in most areas. If reception is weak, unwound and extended to its full length or reassemble the other direction/location to improve reception.

AUX IN:

Listen music from external Audio Player such like MP3 Player; Discman ... etc:

1. Connect one side of supplied Audio Connection Cable to the Phones Jack; Line Out Jack or AUX Out Jack on the external Audio Player.
2. Connect the other side of the cable to the **AUX IN** Jack on the top of unit as illustrate below:

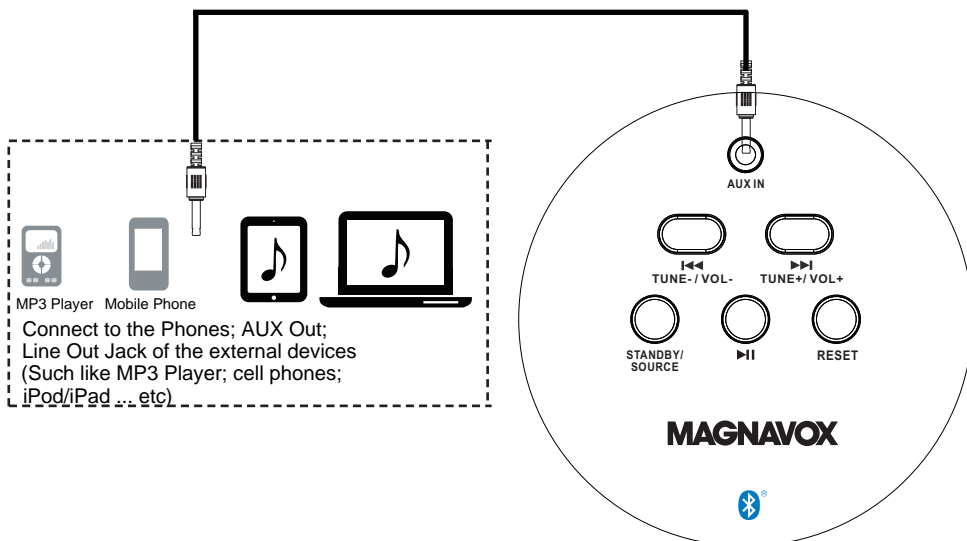

3. Power on the unit as the instructed earlier.
4. Press the **STANDBY/SOURCE** Button on the top of unit or press the **SOURCE** Button on the Remote Control repeatedly until the color of the indicator turn to Orange (Red + Green).
5. Plays the music on the connected external Audio Player as usual. (Make sure the volume level of the external Audio Player is in high level. Otherwise, sound from this unit may weak).

LINE IN:

Listen music from external Video/Audio Player DVD Player/TV etc:

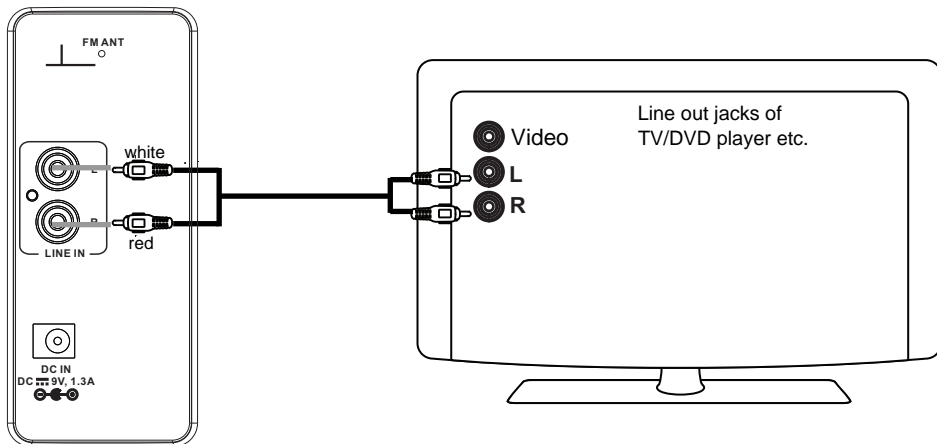

1. Connect one side of RCA Connection Cable (not included) to the RCA audio Jacks on the external Video/Audio Player.
2. Connect the other side of the cable to the **LINE IN** Jacks on the rear of unit as illustrate below:





3. Power on the unit as the instructed earlier.
4. Press the **STANDBY/SOURCE** Button on the top of unit or press the **SOURCE** Button on the Remote Control repeatedly until the color of the indicator turn to Purple (Red + Blue).
5. Plays the video/music on the connected external Video/Audio Player as usual. (Make sure the volume level of the external Video/Audio Player is in high level. Otherwise, sound from this unit may weak).

TROUBLESHOOTING GUIDE

If you are having problems with your unit, please review the guide below before requesting.

SYSTEM	POSSIBLE CAUSE	POSSIBLE SOLUTION
No power	The unit had not connect to AC power	Connect the supplied AC/DC Adaptor to the unit and wall outlet
	The unit is in standby mode	Press and hold the STANDBY/SOURCE Button on the top of unit or press the  /STANDBY Button on the Remote Control to turn on the unit
No sound	Volume is set to minimum	Press the  /Tune +/VOL + button on the unit or the VOL + button on the Remote Control
	Volume level of paired/connected device is in low level	Rise the volume level of the paired/connected device
Sound distortion	Volume level is too high	Press the  /Tune -/VOL - button on the unit or the VOL - button on the Remote Control
	Volume level of paired/connected device is too high	Reduce the volume level of the paired/connected device
Radio weak reception		Unwound and extended the wire antenna to its full length or reassemble the other direction/location to improve reception
Remote not functioning	The button cell in remote control is drained	Replace with new button cell
Bluetooth fail to pair	The external BT device is too far from the unit	Place the external BT device close to the unit
	The external BT device had NOT paired to the unit	Pair the external BT device to the unit as page 10 indicates

GENERAL SPECIFICATIONS

Power source.....	DC 9V  1300mA  
Speaker.....	8W x 4ohm per channel
Audio Power.....	5W per channel (Total 10 W, RMS)
Bluetooth version.....	V4.2
Bluetooth working range.....	≤ 32 feet in open area
FM radio frequency.....	87.5-108.0MHz

PACKAGE INCLUDES:

- 1 x Owner's Manual
- 1 x Remote Control (Uses 1 x CR2025 Button Cell, included)
- 1 x AC/DC Adapter (Input: 100-240V~ 50/60Hz 0.5A
Output: 9V  1300mA)
- 1 x Audio Connection Cable with 3.5mm plugs

LIMITED WARRANTY

Craig Electronics warrants this product to be free from manufacturing defects in material and workmanship under normal use for a period of 180 days from date of purchase. If service is required, please return the product to the store where it was purchased for exchange; or, pack the unit in the original packing material with all accessories if applicable, a copy of your sales receipt and a Cashier's check or Money Order for \$10 (to cover shipping and handling costs) payable to Craig Electronics Inc. For consumers in Canada, please make sure that the cashier check or money order is redeemable through a U.S. bank. Ship your product freight pre-paid. Your unit will be repaired, replaced or if the unit cannot be repaired or replaced, a refund will be forwarded to you within four weeks of receipt of your unit. Please ship your unit to:

Craig Electronics Inc.
1160 NW 163 Drive
Miami, FL 33269

This warranty is void if the product has been: a) Used in a commercial application or rental. b) Damaged through misuse, negligence, or abuse. c) Modified or repaired by anyone other than an authorized Craig service center. d) Damaged because it is improperly connected to any other equipment.

Note: This warranty does not cover: a) Ordinary adjustments as outlined in the Owner's Manual which can be performed by the customer. b) Damage to equipment not properly connected to the product. c) Any cost incurred in shipping the product for repair. d) Damage to the product not used in the USA.

This warranty is not transferable and only applies to the original purchase. Any implied warranties, including the warranty of merchantability, are limited in duration to the period of this expressed warranty and no warranty whether expressed or implied shall apply to the product thereafter.

Under no circumstance shall Craig be liable for any loss or consequential damage arising out of the use of this product. This warranty gives specific legal rights. However, you may have other rights which may vary from state to state. Some states do not allow limitations on implied warranties or exclusion of consequential damage. Therefore, these restrictions may not apply to you.

This product has been manufactured by and is sold under the responsibility of Craig Electronics Inc, and Craig Electronics Inc is the warrantor in relation to this product. MAGNAVOX and SMART. VERY SMART are registered trademarks of Koninklijke Philips N.V. and are used under license from Koninklijke Philips N.V.

To Obtain Service on your Product
email: service@craigelectronics.com