

JVC

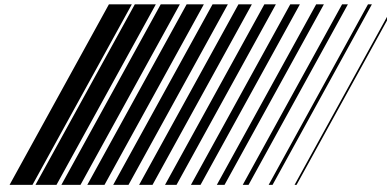

暫定版 Version 2
2004.10.13

DVD PLAYER & VIDEO CASSETTE RECORDER

HR-XV48E

FIRST
See
AUTO SET UP
on **PAGE 10**

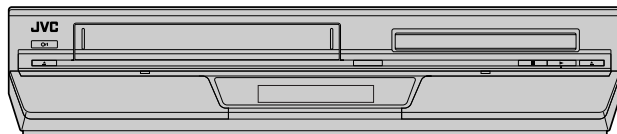

SHOWVIEW™

Hi-Fi **VHS**
PAL

SQP/B

DVD VIDEO™ **DOLBY DIGITAL** **dts™**
2.0+DIGITAL OUT

COMPACT disc DIGITAL VIDEO **COMPACT disc SUPER VIDEO** **COMPACT disc DIGITAL AUDIO**

HOME THEATER DIVX® CERTIFIED VIDEO™ **DIVX® VIDEO**

INSTRUCTIONS

EN

LPT0990-001A

2 EN

SAFETY FIRST

Safety Precautions

The rating plate and the safety caution are on the rear of the unit.

WARNING: DANGEROUS VOLTAGE INSIDE

WARNING: TO PREVENT FIRE OR SHOCK HAZARD, DO NOT EXPOSE THIS UNIT TO RAIN OR MOISTURE.

CAUTION

- When you are not using the unit for a long period of time, it is recommended that you disconnect the power cord from the mains outlet.
- Dangerous voltage inside. Refer internal servicing to qualified service personnel. To prevent electric shock or fire hazard, remove the power cord from the mains outlet prior to connecting or disconnecting any signal lead or aerial.

WARNING (VHS deck only)

There are two different types of SECAM colour systems: SECAM-L, used in FRANCE (also called SECAM-West), and SECAM-B, used in Eastern European countries (also called SECAM-East).

1. This unit can also receive SECAM-B colour television signals for recording and playback.
2. Recordings made of SECAM-B television signals produce monochrome pictures if played back on a video recorder of SECAM-L standard, or do not produce normal colour pictures if played back on a PAL video recorder with SECAM-B system incorporated (even if the TV set is SECAM-compatible).
3. SECAM-L prerecorded cassettes or recordings made with a SECAM-L video recorder produce monochrome pictures when played back with this unit.
4. This unit cannot be used for the SECAM-L standard. Use a SECAM-L recorder to record SECAM-L signals.

IMPORTANT

- Please read the various precautions on pages 2 and 3 before installing or operating the unit.
- It should be noted that it may be unlawful to re-record pre-recorded tapes, DVDs, or discs without the consent of the owner of copyright in the sound or video recording, broadcast or cable programme and in any literary, dramatic, musical, or artistic work embodied therein.

CAUTION

A DVD/VCR IS A CLASS 1 LASER PRODUCT. HOWEVER THIS DVD/VCR USES A VISIBLE LASER BEAM WHICH COULD CAUSE HAZARDOUS RADIATION EXPOSURE IF DIRECTED. BE SURE TO OPERATE THE UNIT CORRECTLY AS INSTRUCTED.

WHEN THIS DVD/VCR IS PLUGGED INTO THE WALL OUTLET, DO NOT PLACE YOUR EYES CLOSE TO THE OPENING OF THE DISC TRAY AND OTHER OPENINGS TO LOOK INTO THE INSIDE OF THIS DVD/VCR. USE OF CONTROLS OR ADJUSTMENTS OR PERFORMANCE OF PROCEDURES OTHER THAN THOSE SPECIFIED HEREIN MAY RESULT IN HAZARDOUS RADIATION EXPOSURE. DO NOT OPEN COVERS AND DO NOT REPAIR YOURSELF. REFER SERVICING TO QUALIFIED PERSONNEL.

CLASS 1 LASER PRODUCT

REPRODUCTION OF LABELS

WARNING LABEL INSIDE OF THE UNIT

CAUTION: Visible and invisible laser radiation when open and interlock failed or defeated. AVOID DIRECT EXPOSURE TO BEAM.	ADVARSEL: Synlig og usynlig laserstråling når maskinen er åben eller interlocken fejler. Undgå direkte eksponering til stråling.	WARNING : Synlig och osynlig laserstråling när den öppnas och spårren är urkopplad. Beträkta ej strålen.	VARO: Avattaessa ja suojaelukitus ohitettuna tai viallisena olet alttina näkyvälle ja näkymättömälle lasersäteilylle. Vältä säteen kohdistumista suoraan itseesi. (f)
--	---	---	--

Use only discs marked with the following.



DVD VIDEO
(8 cm /12 cm disc)



Audio CD
(8 cm /12 cm disc)



Video CD
(8 cm /12 cm disc)



Super Video CD
(8 cm /12 cm disc)



- Manufactured under license from Dolby Laboratories. "Dolby" and the double-D symbol are trademarks of Dolby Laboratories.
- "DTS" and "DTS 2.0+ Digital Out" are trademarks of Digital Theater Systems, Inc.
- Cassettes marked "VHS" (or "S-VHS") can be used with this video cassette recorder. However, S-VHS recording is not possible with this model.
- This model is equipped with S-QPB (S-VHS QUASI PLAYBACK) that makes it possible to play back S-VHS recordings in the SP mode with regular VHS resolution.
- HQ VHS is compatible with existing VHS equipment.
- SHOWVIEW is a trademark of Gemstar Development Corporation. The SHOWVIEW system is manufactured under licence from Gemstar Development Corporation.
- This product incorporates copyright protection technology that is protected by U.S. patents and other intellectual property rights. Use of this copyright protection technology must be authorized by Macrovision Corporation, and is intended for home and other limited viewing uses only unless otherwise authorized by Macrovision. Reverse engineering or disassembly is prohibited.
- "Official DivX Certified™ product"
"Plays DivX® 5, DivX® 4, DivX® 3, and DivX® VOD video content (in compliance with DivX Certified™ technical requirements)"
"DivX, DivX Certified, and associated logos are trademarks of DivX Networks, Inc. and are used under license."

For Italy:

"It is declared that this product, brand JVC, conforms to the Ministry Decree n. 548 of 28 Aug.'95 published in the Official Gazette of the Italian Republic n. 301 of 28 Dec.'95"

The STANDBY/ON ϕ /I button does not completely shut off mains power from the unit, but switches operating current on and off. " ϕ " shows electrical power standby and "I" shows ON.

Video tapes recorded with this unit in the LP (Long Play) mode cannot be played back on a single-speed video recorder. (VHS deck only)

When the equipment is installed in a cabinet or a shelf, make sure that it has sufficient space on all sides to allow for ventilation (10 cm or more on both sides, on top and at the rear.)

When discarding batteries, environmental problems must be considered and the local rules or laws governing the disposal of these batteries must be followed strictly.

Failure to heed the following precautions may result in damage to the unit, remote control or video cassette.

1. **DO NOT place the unit** —
 - in an environment prone to extreme temperatures or humidity.
 - in direct sunlight.
 - in a dusty environment.
 - in an environment where strong magnetic fields are generated.
 - on a surface that is unstable or subject to vibration.
2. **DO NOT block the unit's ventilation openings or holes.** (If the ventilation openings or holes are blocked by a newspaper or cloth, etc., the heat may not be able to get out.)
3. **DO NOT place heavy objects on the unit or remote control.**
4. **DO NOT place anything which might spill on top of the unit or remote control.** (If water or liquid is allowed to enter this equipment, fire or electric shock may be caused.)
5. **DO NOT expose the apparatus to dripping or splashing.**
6. **DO NOT use this equipment in a bathroom or places with water.** Also **DO NOT** place any containers filled with water or liquids (such as cosmetics or medicines, flower vases, potted plants, cups, etc.) on top of this unit.
7. **DO NOT place any naked flame sources, such as lighted candles, on the apparatus.**
8. **AVOID violent shocks to the unit during transport.**

MOISTURE CONDENSATION

Moisture in the air will condense on the unit when you move it from a cold place to a warm place, or under extremely humid conditions—just as water droplets form on the surface of a glass filled with cold liquid. Moisture condensation on the head drum will cause damage to the tape. In conditions where condensation may occur, keep the unit turned on for a few hours to let the moisture dry.

ATTENTION

To mobile phone users:

Using a mobile phone in the vicinity of the unit may cause picture vibration on the TV screen or change the screen to a blue back display.

On placing the unit:

Some TVs or other appliances generate strong magnetic fields. Do not place such appliances on top of the unit as it may cause picture disturbance.





Contents

SAFETY FIRST	2
Safety Precautions	2
DISC INFORMATION	4
About Discs	4
INDEX	6
INSTALLING YOUR NEW UNIT	9
Basic Connections	9
INITIAL SETTINGS	10
Auto Set Up	10
Preset Download	12
Monitor Set (DVD deck)	14
Language	15
OPERATIONS ON VHS DECK	18
Basic Playback	18
Playback Features	19
Basic Recording	21
Recording Features	22
B.E.S.T. Picture System	23
SHOWVIEW™ Timer Programming	24
Express Timer Programming	26
Automatic Satellite Programme Recording	28
OPERATIONS ON DVD DECK	30
Basic Playback	30
Playback Features	31
Using the On-Screen Bar	38
Audio/Video Files Playback	40
EDITING (VHS DECK)	44
Editing from a Camcorder	44
Editing to or from Another Video Recorder	45
Dubbing (from DVD to VHS)	46
EDITING (DVD DECK)	47
Digital Audio Dubbing	47
REMOTE CONTROL	48
Remote Control Functions	48
SYSTEM CONNECTIONS	50
Connecting to a Satellite Receiver	50
Connecting/Using a Decoder	51
Connecting to a Dolby Digital Decoder or an Amplifier with a Built-In DTS (DVD deck only)	51
SUBSIDIARY SETTINGS	52
Mode Set (VHS deck)	52
Mode Set (DVD deck)	55
Tuner Set	59
Video Channel Set	64
Clock Set	65
Child Lock	66
TROUBLESHOOTING	67
SPECIFICATIONS	70
LIST OF TERMS	71

About Discs





Playable Discs

You can use discs with the following logos for playback only.

 DVD VIDEO	 Video CD/Super Video CD
 Audio CD CD-DA files	 VIDEO CD

- The following discs also can be played back.
 - DVD-R/RW discs recorded in DVD VIDEO format and finalized.
 - CD-R/RW discs recorded in Video CD, SVCD (Super Video CD), or Audio CD format and finalized.
 - The DivX file on the DVD-R and DVD-RW discs written in the UDF format.
 - CD-R/RW discs written in MP3/JPEG/DivX in accordance with the "ISO 9660" format. (See page 40 for details.)
- This unit can also play back audio signals recorded in MIX-MODE CD, CD-G, CD-EXTRA, and CD TEXT.
- The image may be sometimes poor or noisy due to defects in the disc itself.
- With some discs, operations may not be possible.

Marks of discs in this instruction manual

	Allows operation with a DVD VIDEO disc.		Allows operation with a Video CD disc.
	Allows operation with a SVCD disc.		Allows operation with an Audio CD disc.

Unplayable Discs

The following types of discs cannot be played using this unit.

- CD-ROM discs (including PHOTO-CD)
- DVD AUDIO discs
- Super Audio CDs (SACD)
- DVD-RW discs recorded in VR format
- DVD-RAM discs
- DVD-ROM discs

In addition, this unit does not play:

- Unfinalized discs
- Discs of irregular shape or discs with tape, seals, or paste on either the label side or playback side. Playing back these discs may damage the unit.

Region Number

The world is divided into 6 regions for DVD VIDEO discs. DVD VIDEO discs are assigned a region number to indicate which region they may be played back in. A disc cannot be played back on this unit unless the region number of the disc matches that of the unit. The region number for this unit is "2." Only discs whose region number includes "2" can be played back such as shown below.







Examples of DVD VIDEO labels which can be played back using this unit.





DVD VIDEO Marks

Sometimes marks are printed on a DVD disc and/or on its packaging to indicate information regarding the contents and functions of a disc. Check marks indicating the contents and functions of a disc. Note, however, that in some cases a disc may not include a mark even for a function it supports.

Marks related to video

	Number of subtitles		Number of angles
	Recorded under the standard 4:3 aspect ratio		Screen includes black bands at top and bottom of image which has a standard 4:3 aspect ratio (letter box)
	Video playback is in Wide video mode (16:9) on wide televisions, but in letter box on televisions with standard 4:3 aspect ratio.		
	Video playback is in Wide video mode (16:9) on wide televisions, but pan and scan is used on televisions with standard 4:3 aspect ratio (either the left or right side of the image is cut-out).		

Marks related to audio

	Number of audio tracks
	Dolby Digital mark Dolby Laboratories has developed a digital surround system for the home. This mark indicates that you may enjoy 5.1-channel audio (front left and right, center, rear left and right, and a channel for LFE (Low-Frequency Effects)).
	DTS (Digital Theater System) You can enjoy DTS audio if you connect an amplifier with a built-in DTS decoder to the DIGITAL AUDIO OUT connector of the unit.

File Structure of Discs

DVD VIDEO

Typically, DVD VIDEO discs are made up of larger units called "titles." Each title has a number (title number) that can be used to select desired titles. Titles are further divided into units called "chapters." Each chapter has a number (chapter number) that can also be used to select desired chapters. Note that some discs are not divided into titles and chapters.

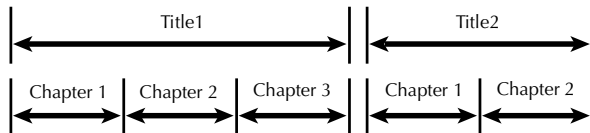

Audio CD/Video CD

Typically, Audio CD discs are divided into separate tracks each containing one song. Each track is assigned a number. For example, the third track is Track 3. The same is true for Video CD discs.

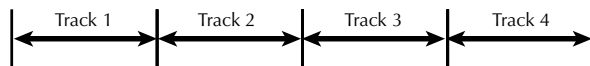

NOTE:

Video CD discs that support Playback Control (PBC)

The still image or motion image which follows a menu screen is called a "scene." Each scene has a scene number. For more details, refer to "Locating a Desired Scene Using the Menu of a Video CD/SVCD with Playback Control (PBC) Function" (pg. 31).

Placing a Disc

1 Open the disc tray.

Press on the DVD deck to open the disc tray.

- The unit's power comes on automatically.
- Do not block the disc tray with your hand while it is opening or closing as this may result in hardware failure.
- Do not place unplayable discs or any object other than a disc in the disc tray.
- Do not press down strongly on the disc tray or place any heavy objects on it.

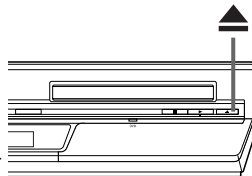

2 Place the disc.

Place the disc in the disc tray with the label side facing up.

- Since disc size changes depending on the disc to be played back, be sure to correctly align the disc with the grooves for its size. If the disc is not in its groove, it may be scratched or otherwise damaged.
- To insert an 8 cm disc, place it according to the inner groove.

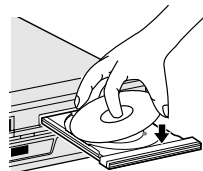

3 Press on the DVD deck to close the disc tray.

- Pressing also closes the disc tray.
- Playback begins automatically if an auto-playback DVD disc is loaded. Although the VHS deck is selected, the DVD deck is selected automatically (except when the VHS deck is in the timer mode or the Automatic Satellite Programme Recording mode.)

Care and Handling of Discs

How to handle discs

When handling a disc, do not touch the surface of the disc. Since discs are made of plastic, they are easily damaged. If a disc gets dirty, dusty, scratched or warped, the images and sound will not be picked up correctly, and such a disc may cause the unit to malfunction.

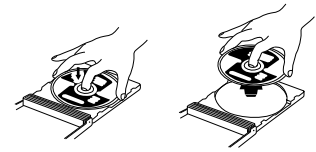

Label side

Do not damage the label side, stick paper to or use any adhesive on its surface.

Storage

Make sure that discs are kept in their cases. If discs are piled on top of one another without their protective cases, they can be damaged. Do not put discs in a location where they may be exposed to direct sunlight, or in a place where the humidity or temperature is high. Avoid leaving discs in your car!

Maintenance of discs

If there are fingerprints or other dirt adhering to a disc, wipe with a soft dry cloth, moving from the center outwards. If a disc is difficult to clean, wipe with a cloth moistened with water. Never use record cleaners, petrol, alcohol or any anti-static agents.



CAUTION

Sometimes during playback, noise or images may be garbled. This is sometimes due to the disc. (It may not be up to industry standards.) These symptoms are caused by the discs, not by the malfunction of the unit.

6 EN

INDEX

Front View

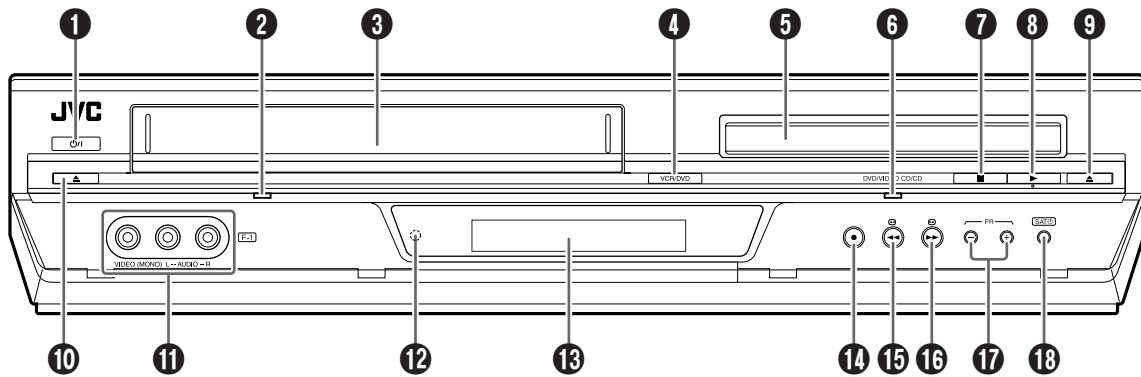

- 1 STANDBY/ON Button (⏻/⏻) ☞ pg. 10, 18, 40
- 2 VCR Indicator ☞ pg. 18, 21
- 3 Cassette Loading Slot ☞ pg. 18
- 4 VCR/DVD Button ☞ pg. 18, 21, 30, 40
- 5 Disc Tray ☞ pg. 30
- 6 DVD Indicator ☞ pg. 30
- 7 Stop Button (■) ☞ pg. 18, 21, 30, 41, 48
- 8 Play Button (▶) ☞ pg. 18, 21, 30, 41, 48
- 9 DVD Open/Close Button (⏏) ☞ pg. 30, 41
- 10 Cassette Eject Button (⏏) ☞ pg. 18, 21
- 11 Video/Audio Input Connectors (VIDEO/AUDIO) ☞ pg. 44
- 12 Infrared Beam Receiving Window
- 13 Front Display Panel ☞ pg. 7

- 14 Record Button (●) ☞ pg. 21, 22
- 15 Rewind Button (◀◀) ☞ pg. 18, 19, 32
- 16 Fast Forward Button (▶▶) ☞ pg. 18, 19, 32
- 17 Programme Button (PR +/-) ☞ pg. 21
- 18 Automatic Satellite Programming Button (SATⓂ) ☞ pg. 28

To access covered connectors or buttons, pull and open the cover.

Rear View

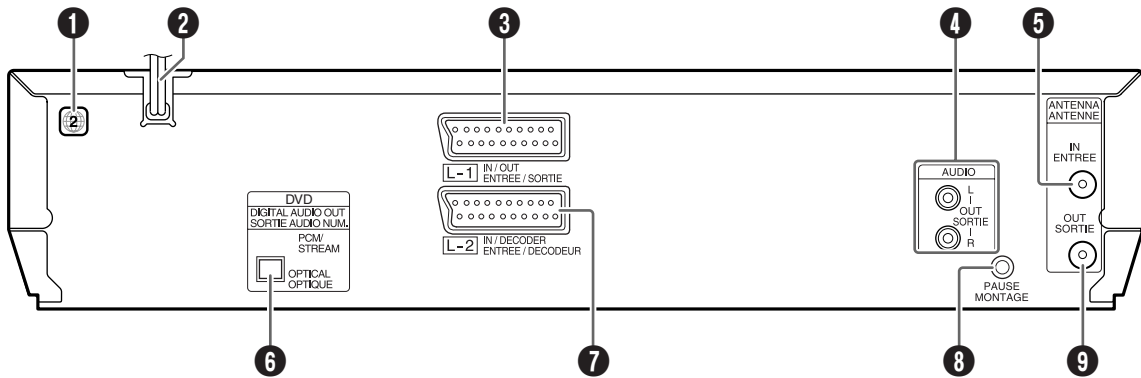

- 1 Region Number Label ☞ pg. 4
- 2 Mains Power Cord ☞ pg. 9
- 3 L-1 Input/Output Connector (L-1 IN/OUT) ☞ pg. 9, 45, 50, 51
- 4 Audio Output Connectors (AUDIO OUT (L/R))
- 5 Antenna Input Connector (ANTENNA IN) ☞ pg. 9, 50, 51

- 6 Digital Audio Output Connector (DIGITAL AUDIO OUT) ☞ pg. 47, 51
- 7 L-2 Input/Decoder Connector (L-2 IN/DECODER) ☞ pg. 45, 50, 51
- 8 Remote Pause Connector (PAUSE) ☞ pg. 44
- 9 Antenna Output Connector (ANTENNA OUT) ☞ pg. 9, 50, 51

Front Display Panel

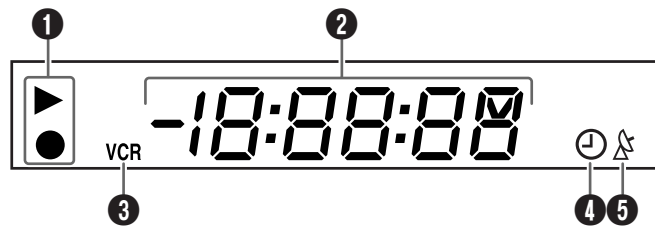

- ❶ VCR Mode Indicator ☞ pg. 21, 22
- ❷ Channel/Clock Display
Mode Display (L-1, L-2, F-1 or SAT*)
* When "L-2 SELECT" is set to "SAT" (☞ pg. 54), "SAT" appears instead of "L-2".
Counter Display
Tape Speed (SP/LP) ☞ pg. 21
Multi-information window*
* The current group/title/track/chapter number(s), time and status information.
- ❸ VCR Indicator ☞ pg. 22
- ❹ "Timer" Indicator ☞ pg. 25, 26, 29
- ❺ Automatic Satellite Programme Recording Indicator (Δ) ☞ pg. 29

On-Screen Display (VHS deck)

If you press **--:--** on the remote control when "O.S.D." is set to "ON" (☞ pg. 53), various operational indicators appear on the TV screen.
For the on-screen display for DVD deck, refer to "Using the On-Screen Bar" (☞ pg. 38).

- ❹ Audio Mode Display ☞ pg. 20
- ❺ Tape Speed (SP/LP)
- ❻ Tape Direction
- ❼ Index Mark Indicator (MARK) ☞ pg. 21
- ❽ Counter Display
- ❾ Tape Remaining Time Indicator ☞ pg. 22

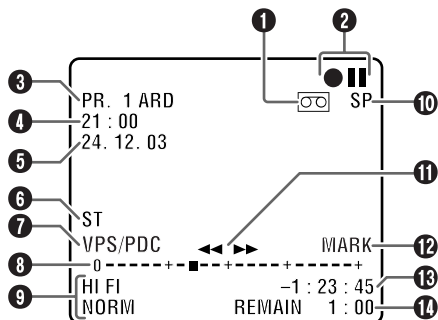

- ❶ "Cassette Loaded" Mark
- ❷ Operation Mode Indicators
- ❸ Channel Position Number and Station Name/Auxiliary Input Indicator (L-1, L-2, F-1 or SAT*)
* When "L-2 SELECT" is set to "SAT" (☞ pg. 54), "SAT" appears instead of "L-2".
- ❹ Clock Display
- ❺ Current Day/Month/Year
- ❻ Type of Broadcast ☞ pg. 23
- ❼ VPS/PDC Indicator ☞ pg. 24, 26
- ❽ Tape Position Indicator
The tape position indicator appears on the TV screen when you press **◀◀** or **▶▶** from the Stop mode or perform an Index Search. (☞ pg. 19) The position of "█" in relation to "0" (beginning) or "+" (end) shows you where you are on the tape.

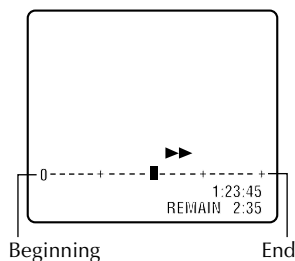

NOTE:

Depending on the type of tape being used, the tape position indicator may not appear correctly.

Remote Control

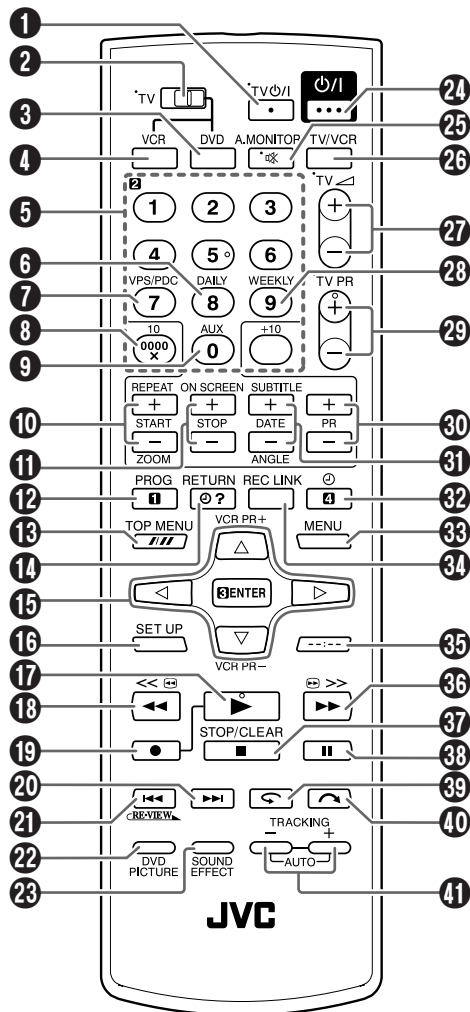

- 1 TV Standby/On Button (TV \updownarrow) \hookrightarrow pg. 49
- 2 TV/VCR/DVD switch \hookrightarrow pg. 12, 14, 18, 21, 30, 40, 49
- 3 DVD Button \hookrightarrow pg. 14, 30, 40
- 4 VCR Button \hookrightarrow pg. 14, 18, 21, 24, 26
- 5 Number Keys
- 6 Daily Button (DAILY) \hookrightarrow pg. 25, 27
- 7 VPS/PDC Button \hookrightarrow pg. 24, 26
- 8 Reset Button (0000) \hookrightarrow pg. 22
- 9 Cancel Button (X) \hookrightarrow pg. 24, 27
- 10 Auxiliary Button (AUX) \hookrightarrow pg. 44
- 11 Start Time Button (START +/-) \hookrightarrow pg. 26
- 12 Repeat Button (REPEAT) \hookrightarrow pg. 33
- 13 Zooming Button (ZOOM) \hookrightarrow pg. 32
- 14 Stop Time Button (STOP +/-) \hookrightarrow pg. 26
- 15 On Screen Button (ON SCREEN) \hookrightarrow pg. 38
- 16 Programming Button (PROG) \hookrightarrow pg. 24, 26
- 17 Tape Speed Button (///) \hookrightarrow pg. 21, 24, 26
- 18 Top Menu Button (TOP MENU) \hookrightarrow pg. 31
- 19 Programme Check Button (\odot ?) \hookrightarrow pg. 27
- 20 Return Button (RETURN) \hookrightarrow pg. 31
- 21 \triangleleft \triangleright Button
- 22 \triangleup \triangledown Button
- 23 ENTER Button
- 24 VCR Programme Button (VCR PR +/-)
- 25 Set Up Menu Button (SET UP) \hookrightarrow pg. 12, 14, 52, 55
- 26 Play Button (\blacktriangleright) \hookrightarrow pg. 18, 30
- 27 Rewind Button (\blacktriangleleft) \hookrightarrow pg. 18, 19, 32
- 28 Record Button (\bullet) \hookrightarrow pg. 21, 22
- 29 Forward Skip/Index Button ($\blacktriangleright\blacktriangleright$) \hookrightarrow pg. 19, 31
- 30 Reverse Skip/Index Button ($\blacktriangleleft\blacktriangleleft$) \hookrightarrow pg. 19, 31
- 31 Review Button (\blacktriangleleft REVIEW) \hookrightarrow pg. 20
- 32 DVD Picture Button (DVD PICTURE) \hookrightarrow pg. 36
- 33 Sound Effect Button (SOUND EFFECT) \hookrightarrow pg. 37
- 34 Standby/On Button (\updownarrow) \hookrightarrow pg. 10, 18, 40
- 35 TV Muting Button (\times) \hookrightarrow pg. 49
- 36 Audio Monitor Button (A.MONITOR) \hookrightarrow pg. 20, 23, 35
- 37 TV/VCR Button \hookrightarrow pg. 22
- 38 TV Volume Button (TV \triangleleft +/-) \hookrightarrow pg. 49
- 39 Weekly Button (WEEKLY) \hookrightarrow pg. 25, 27
- 40 TV Programme Button (TV PR +/-) \hookrightarrow pg. 49
- 41 Programme Button (PR +/-) \hookrightarrow pg. 21, 26
- 42 Date Button (DATE +/-) \hookrightarrow pg. 26
- 43 Subtitle Button (SUBTITLE) \hookrightarrow pg. 34
- 44 Angle Button (ANGLE) \hookrightarrow pg. 35
- 45 Timer Button (\odot) \hookrightarrow pg. 25, 26, 27
- 46 Menu Button (MENU) \hookrightarrow pg. 31
- 47 Automatic Satellite Programming Button (REC LINK) \hookrightarrow pg. 28
- 48 Display Button ($-:-:-$) \hookrightarrow pg. 22
- 49 Fast Forward Button ($\blacktriangleright\blacktriangleright$) \hookrightarrow pg. 18, 19, 32
- 50 Stop/Clear Button (\blacksquare) \hookrightarrow pg. 18, 21, 30
- 51 Pause Button (\parallel) \hookrightarrow pg. 19, 21, 30
- 52 One Touch Replay Button (\curvearrowright) \hookrightarrow pg. 40
- 53 Skip Search Button (\curvearrowright) \hookrightarrow pg. 19
- 54 Tracking Button (TRACKING +/-) \hookrightarrow pg. 20

Buttons with a small dot on the left side of the name can also be used to operate your TV. (\hookrightarrow pg. 49)

How To Use

The remote control can operate most of your unit's functions, as well as basic functions of TV sets of JVC and other brands. (\hookrightarrow pg. 49)

- Point the remote control toward the receiving window.
- The maximum operating distance of the remote control is about 8 m.

NOTES:

- When inserting the batteries, be sure to insert in the correct directions as indicated under the battery cover.
- If the remote control doesn't work properly, remove its batteries, wait a short time, replace the batteries and then try again.

INSTALLING YOUR NEW UNIT

EN 9

Basic Connections

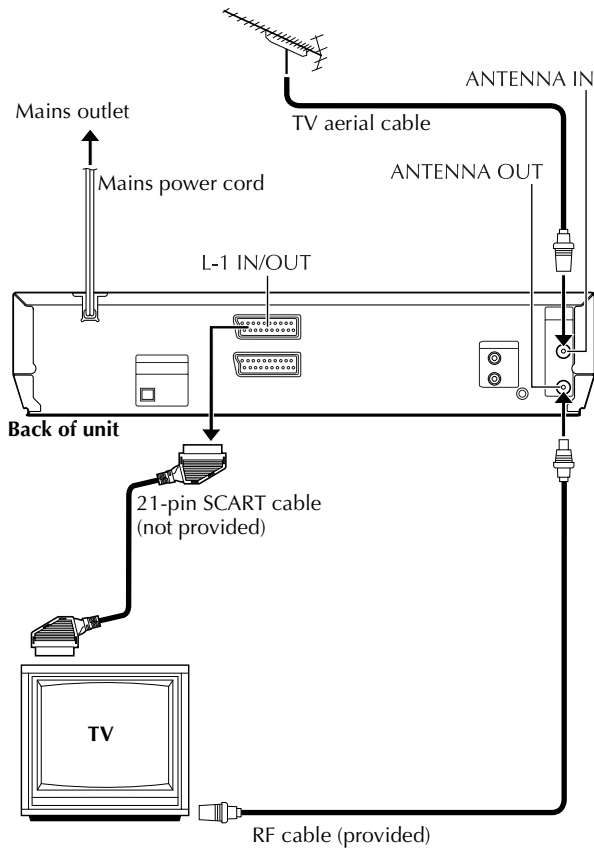

It's essential that your unit be properly connected.

THESE STEPS MUST BE COMPLETED BEFORE ANY VIDEO OPERATION CAN BE PERFORMED.

1 Check the contents.

Make sure the package contains all of the accessories listed in "SPECIFICATIONS" on page 70.

2 Situate the unit.

Place the unit on a stable, horizontal surface.

3 Connect the unit to TV.

The connection method you use depends on the type of TV you have.

RF Connection

■ **To connect to a TV with NO AV input connectors —**

- 1 Disconnect the TV aerial cable from the TV.
- 2 Connect the TV aerial cable to the ANTENNA IN connector on the rear panel of the unit.
- 3 Connect the provided RF cable between the ANTENNA OUT connector on the rear panel of the unit and the TV's aerial connector.

AV Connection

■ **To connect to a TV with AV input connectors —**

If your TV is equipped with a 21-pin SCART connector, perform AV connection to improve picture quality during tape playback.

- 1 Connect the aerial, unit and TV as per "RF Connection."
- 2 Connect an optional 21-pin SCART cable between the L-1 IN/OUT connector on the rear panel of the unit and the TV's 21-pin SCART connector.

4 Connect the unit to mains.

Plug the end of the mains power cord into a mains outlet.

After the connection is completed, perform "Auto Set Up" on page 10.

Auto Set Up



Auto Channel Set/Auto Clock Set/ Auto Guide Program Number Set

After the P/I button on the unit or remote control is pressed for the first time to power on the unit, by simply selecting your country*, the Auto Set Up function sets the tuner channels, clock** and Guide Program numbers automatically.

* If you live in Belgium (BELGIUM) or Switzerland (SUISSE), you also need to select your language.

** If you live in Hungary (MAGYARORSZÁG), Czech Republic (ČESKÁ REPUBLIKA), Poland (POLSKA) or other countries in Eastern Europe (OTHER EASTERN EUROPE), set the clock manually.

Before starting, make sure of the following:

- The TV aerial cable should be connected to the unit.
- The unit's mains power cord should be connected to a mains outlet.
- The TV should be set to its AV mode (with AV connection  pg. 9) or UHF channel 36 (with RF connection  pg. 9).
- Slide the TV/VCR/DVD switch on the remote control to the right.

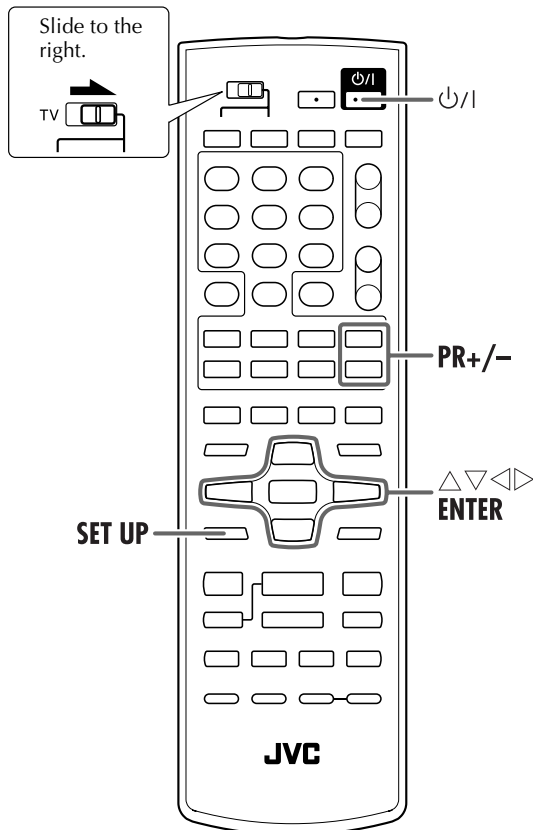

1 Turn on the unit.

Press P/I on the unit or remote control. The Country Set display appears on the TV screen.

NOTE:

If you have connected your TV to the unit with RF connection and the on-screen display appearing on UHF channel 36 looks distorted, perform "Video Channel Set" on page 64.



2 Select your country.

Press Δ/∇ to move the highlight bar (pointer) to your country's name.

(Example) DEUTSCHLAND is selected.



NOTES:

- If you have selected BELGIUM or SUISSE, go to step 3.
- If you have selected MAGYARORSZÁG, ČESKÁ REPUBLIKA, POLSKA or OTHER EASTERN EUROPE, press **ENTER**. The Clock Set screen appears. Set the clock manually ( pg. 65), then go to step 4.
- If you have selected any other country name, go to step 4.

3 Select the language.

Press **ENTER**. The Language Set display appears on the TV screen.

Press Δ/∇ to move the highlight bar (pointer) to the language of your choice.

(Example) DEUTSCH is selected.



NOTE:

The selected language is only available on the screen for VHS deck. Set manually the on-screen language for the DVD deck. ( pg. 16)

4 Perform Auto Set Up.

Press **ENTER**. The AUTO SET/T-V LINK display appears on the TV screen.

Press Δ / ∇ to move the highlight bar (pointer) to "AUTO SET" and press **ENTER** or \triangleright .

- When selecting "AUTO SET," "Auto" also appears on the front display panel.

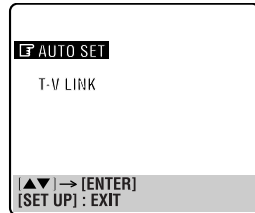
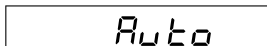

While Auto Set Up is in progress, do NOT press any button on the unit or remote control until the front display panel shows either the display as illustrated in step 5 or "—:—:" as illustrated on page 13.

- The AUTO SET screen will appear on the TV screen. As Auto Set Up progresses, the "█" mark on the TV screen moves from left to right.

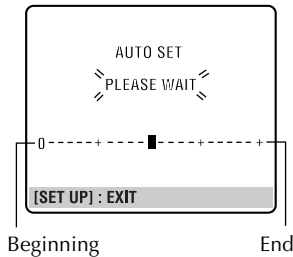

- When you have connected the unit to a TV offering T-V Link via a fully-wired 21-pin SCART cable (see pg. 9) and the TV is turned on, the unit automatically performs the Preset Download (see pg. 12) even if you select "AUTO SET" for Auto Set Up function.

5 Confirm/Set video channel.

With RF Connection

The video channel that is blinking on the front display panel is your video channel. Press **ENTER**.

- If you have selected MAGYARORSZÁG, ČESKÁ REPUBLIKA, POLSKA or OTHER EASTERN EUROPE in step 2 on page 10, "2" appears instead of "1."
- To view picture signals from the unit, set your TV to the video channel.

With AV Connection

Press **PR** — until the front display panel shows "1 ——" (or "2 —"). Now the video channel is set to off. Then press **ENTER**.

- To view picture signals from the unit, set your TV to its AV mode.

ATTENTION

Once you have performed Auto Set Up, even if the unit's memory backup has expired, all the stored stations and their Guide Program numbers remain in the unit's memory and the unit will not perform Auto Set Up again. The unit performs only Auto Clock Set when the unit is turned on. If you have moved to a different area, perform each setting as required.

- Video channel setting (for RF connection users) see pg. 64
- Tuner setting see pg. 59
- Clock setting see pg. 65

If a new station starts broadcasting in your area, perform tuner setting (see pg. 59) and, if necessary, video channel setting (see pg. 64).

NOTES:

- In areas where no TV station transmits a PDC (Programme Delivery Control) signal, the unit can perform neither Auto Clock Set nor Auto Guide Program Number Set.
- If there is a power cut, or if you press $\psi/1$ or **SET UP** while Auto Set Up is in progress, Auto Set Up will be interrupted; be sure to turn off the unit power once and try again from step 1.
- Auto Clock Set may not function properly depending on the reception condition.
- If no sound accompanies the picture or the audio sounds unnatural on some channels that have been stored by Auto Set Up, the TV system setting for those channels may be incorrect. Select the appropriate TV system for those channels. (see pg. 61, "INFORMATION")

After "Auto Set Up" is completed, perform "Monitor Set (DVD deck)" on page 14.

12 EN

INITIAL SETTINGS (cont.)

Preset Download Auto Channel Set by Downloading from TV/Auto Clock Set/Auto Guide Program Number Set

If you have connected the unit to your TV via the AV connection (☞ pg. 9), the unit will automatically perform Preset Download instead of the Auto Set Up in step 1 on page 11. After downloading, the unit sets the clock and Guide Program numbers automatically.

ATTENTION

You can use this function only with a TV offering T-V Link, etc.* Be sure to use a fully-wired 21-pin SCART cable.

* Compatible with TVs offering T-V Link, EasyLink, Megalogic, SMARTLINK, Q-Link or DATA LOGIC via fully-wired 21-pin SCART cable. The degree of compatibility and available functions may differ by system.

- Slide the TV/VCR/DVD switch on the remote control to the right.
- Perform steps 1 to 3 of "Auto Set Up" on page 10 before continuing.

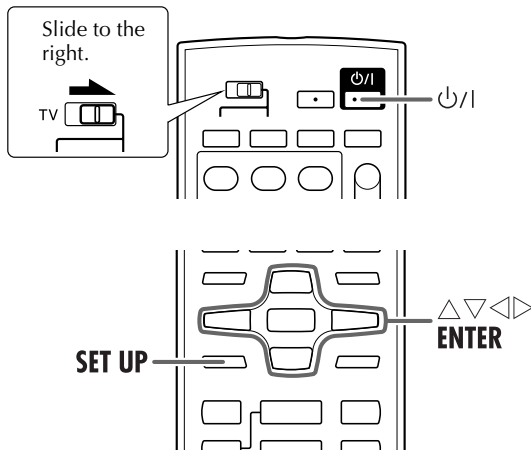

NOTES:

- For details, refer to the instruction manual of your TV.
- In areas where no TV station transmits a PDC (Programme Delivery Control) signal, the unit can perform neither Auto Clock Set nor Auto Guide Program Number Set.
- If there is a power cut, or if you press φ/I or SET UP while downloading or set up is in progress, it will be interrupted; be sure to turn off the unit power once and try again from the beginning.
- Auto Clock Set may not function properly depending on the reception condition.
- On this unit, the characters available for station names (ID) are A-Z, 0-9, -, *, + and _ (space). Some names of downloaded stations may differ from those of your TV. (☞ pg. 62)

1 Perform Preset Download.

Press ENTER. The AUTO SET/T-V LINK display appears on the TV screen.

Press Δ▽ to move the highlight bar (pointer) to "T-V LINK" and press ENTER or ▷.

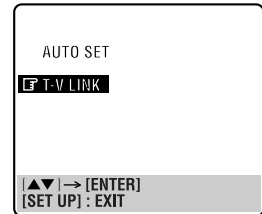

- When selecting "T-V LINK," "CH --" also appears on the front display panel.

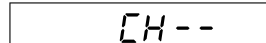

Preset positions on the front display panel increase from "1"; do NOT press any button on the unit or remote control until the front display panel shows clock time, "1" or "--:--" as illustrated on page 13.

- The T-V LINK screen will appear. Then the GUIDE PROG SET screen will appear during Guide Program Number Set. When Preset Download is completed, "COMPLETED" appears for about 5 seconds, then the normal screen appears.
- If you press any button on the unit or remote control while downloading is in progress, it will be interrupted.

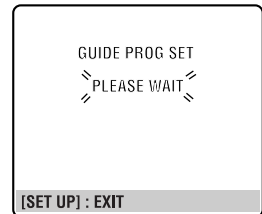
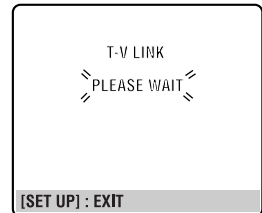

2 Set the video channel.

Set the video channel to off manually. (☞ pg. 64)

After "Preset Download" is completed, perform "Monitor Set (DVD deck)" on page 14.

Results of Auto Set Up/Preset Download Appear on the Front Display Panel

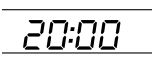
A  **If both Auto Channel Set and Auto Clock Set have been performed successfully, the correct current time is displayed.**

Turn on the TV and select its video channel or AV mode, then make sure that all necessary stations have been stored in the unit's memory by using the **PR** button(s).

- If station names (ID –  pg. 63) have also been stored in the unit's memory, the station name will be displayed at the top left corner of the TV screen for about 5 seconds when the unit is tuned to a different station.
- If you want to set the tuner manually such as to add or skip channels, to change channel positions, or to set or change station names, see pages 60 – 63.

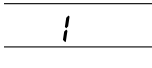
B  **If Auto Channel Set has succeeded but Auto Clock Set has not, "1" (channel position) is displayed.**

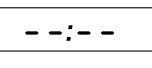

- 1 Turn on the TV and select its video channel or AV mode, then make sure that all necessary stations have been stored in the unit's memory by using the **PR** button(s).
- If station names (ID –  pg. 63) have also been stored in the unit's memory, the station name will be displayed at the top left corner of the TV screen for about 5 seconds when the unit is tuned to a different station.
- If you want to set the tuner manually such as to add or skip channels, to change channel positions, or to set or change station names, see pages 60 – 63.

2 Perform "Clock Set" on page 65.

C  **If both Auto Channel Set and Auto Clock Set have failed, "--:--" is displayed.**

Make sure the cables are connected properly and turn off the unit's power once, then turn the unit's power back on again. The Country Set display appears on the TV screen; perform "Auto Set Up" on page 10 or "Preset Download" on page 12 again.

IMPORTANT

- To check if the Guide Program numbers have been set correctly, perform the SHOWVIEW Timer Programming. ( pg. 24) (VHS deck only)
- In certain reception conditions, station names may not be stored correctly, and auto Guide Program Number Set may not work properly. If the Guide Program numbers are not set properly when you timer-record a TV programme using the SHOWVIEW system, the unit will record a TV programme of a different station. When programming the timer using the SHOWVIEW system, be sure to check the desired channel is selected correctly. ( pg. 24, "SHOWVIEW™ Timer Programming") (VHS deck only)
- Your unit memorizes all detected stations even if reception of some of them is poor. You can delete those stations with an unacceptable picture. ( pg. 61, "Deleting a Channel")

INFORMATION

Language for the on-screen display (VHS deck)

Auto Set Up also selects the language automatically for the on-screen display depending on the Country setting you have made in step 2 on page 10 (unless you have selected BELGIUM or SUISSE), as shown below.

SUOMI	→ SUOMI	ITALIA	→ ITALIANO
PORTUGAL	→ ENGLISH	MAGYARORSZÁG	→ MAGYAR
DEUTSCHLAND	→ DEUTSCH	ESPAÑA	→ CASTELLANO
POLSKA	→ POLSKI	NEDERLAND	→ NEDERLANDS
NORGE	→ NORSK	GREECE	→ ENGLISH
SVERIGE	→ SVENSKA	OTHER WESTERN	→ ENGLISH
DANMARK	→ DANSK	EUROPE	
ÖSTERREICH	→ DEUTSCH	OTHER EASTERN	→ ENGLISH
ČESKÁ	→ ČESTINA	EUROPE	
REPUBLIKA			

If you want to change the language setting manually, see "On-Screen Language Set (VHS deck)" on page 15.

Language for the on-screen display (DVD deck)

Set manually the on-screen language for the DVD deck. ( pg. 16)

Just Clock

Your unit is equipped with the Just Clock function which provides accurate time keeping through automatic adjustments at regular intervals, by reading data from a PDC signal. If you want to take advantage of this function, simply set it to "ON". ( pg. 65, "Just Clock")

T-V Link Functions

When you connect the unit to your TV via a fully-wired 21-pin SCART cable ( pg. 9), the following functions are available. You can use these functions only with a TV offering T-V Link, etc.*

For details, refer to the instruction manual of your TV.

* *Compatible with TVs offering T-V Link, EasyLink, Megalogic, SMARTLINK, Q-Link or DATA LOGIC via fully-wired 21-pin SCART cable. The degree of compatibility and available functions may differ by system.*

TV Auto Power On

The TV will turn on and be set to its AV mode automatically whenever you play a tape.

For details, refer to the instruction manual of your TV.

Unit Auto Standby

You can use your TV's remote control to turn off the unit. For details, refer to the instruction manual of your TV.

Direct Rec (VHS deck only)

You can easily start recording the programme that you are watching on your TV. When you use this function, set "DIRECT REC" to "ON." ( pg. 53)

Monitor Set (DVD deck)

You can select the monitor type depending on the TV used when you play back DVD VIDEO discs recorded for wide-screen TVs.

- Turn on the TV and select the video channel (or AV mode).
- Slide the **TV/VCR/DVD** switch on the remote control to the right.

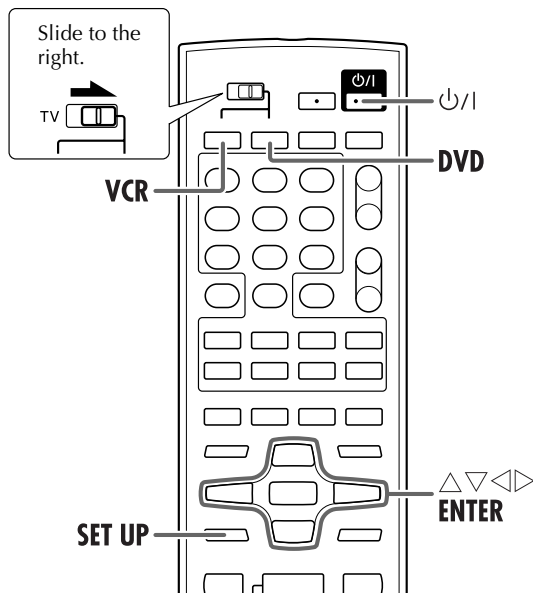

1 Turn on the unit.

Press **⏻**.

2 Select the DVD deck.

On the unit

Press **VCR/DVD** repeatedly so that the DVD indicator lights up.

On the remote control

Press **DVD** so that the DVD indicator lights up.

3 Access the DVD Set Up menu screen.

- 1 Press **SET UP**.
- 2 Press **◀▶** to select "PICTURE."

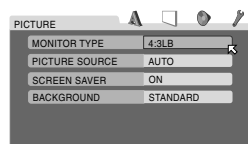

4 Select the mode.

Press **△▽** to move **↔** to "MONITOR TYPE," then press **ENTER**.

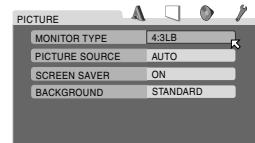

5 Select the mode setting.

Press **△▽** to select the desired setting, then press **ENTER**.

6 Return to the normal screen.

Press **SET UP**.

* The default setting is **bold** in the table below.

MONITOR TYPE

16:9 (Wide television conversion):

Select this when the aspect ratio of your TV is 16:9 (wide TV).

4:3 LB (Letter Box conversion):

Select this when the aspect ratio of your TV is 4:3 (conventional TV). While viewing a wide screen picture, the black bars appear on the top and the bottom of the screen.

4:3 PS (Pan&Scan):

Select this when the aspect ratio of your TV is 4:3 (conventional TV). While viewing a wide screen picture, the black bars do not appear; however, the left and right edges of the pictures will not be shown on the screen.

Pan&Scan/Letter Box

In general, DVD VIDEO disc are produced for a wide-screen TV with 16:9 aspect ratio.

Material with this ratio will not fit to a TV with 4:3 aspect ratio. There are two styles to display the image, "Pan&Scan" and "Letter Box."

Pan&Scan

The right and left side of the image are cut off. The image fills the screen.

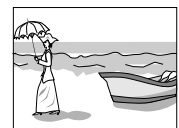

Letter Box

Black bands appear at the top and bottom of the image. The image itself appears in 16:9 aspect ratio.



Language

- Turn on the TV and select the video channel (or AV mode).
- Slide the **TV/VCR/DVD** switch on the remote control to the right.

On-Screen Language Set (VHS deck)

This VHS deck offers you the choice to view on-screen messages in 13 different languages. Though Auto Set Up selects the language automatically (pg. 13), you can change the language setting manually as required.

1 Turn on the unit.

Press **⏻/I**.

2 Select the VHS deck.

On the unit

Press **VCR/DVD** repeatedly so that the VCR indicator lights up.

On the remote control

Press **VCR** so that the VCR indicator lights up.

3 Access the Country Set screen.

- 1 Press **SET UP**.
- 2 Press **△▽** to move the highlight bar (pointer) to "AUTO CH SET," then press **ENTER** or **▷**.

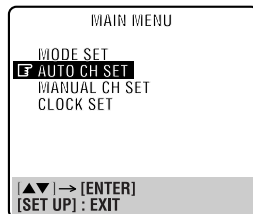

4 Select your country.

Press **△▽** to move the highlight bar (pointer) to your country's name, then press **ENTER** or **▷**.

5 Select the language.

Press **△▽** to move the highlight bar (pointer) to the language of your choice.

- You do not have to press **ENTER**; pressing **ENTER** enters AUTO SET/T-V LINK screen.



6 Return to the normal screen.

Press **SET UP**.

16^{EN}

INITIAL SETTINGS (cont.)

On-Screen Language Set (DVD deck)

This DVD deck offers you the choice to view on-screen messages in 3 different languages. You can change the language setting manually as required.

1 Turn on the unit.

Press ψ /I.

2 Select the DVD deck.

On the unit

Press **VCR/DVD** repeatedly so that the DVD indicator lights up.

On the remote control

Press **DVD** so that the DVD indicator lights up.

3 Access the DVD Set Up menu screen.

- 1 Press **SET UP**.
- 2 Press \triangleleft \triangleright to select "LANGUAGE."

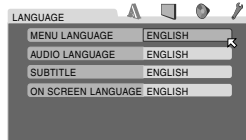

4 Select the mode.

Press \triangle ∇ to move \boxtimes to "ON SCREEN LANGUAGE," then press **ENTER**.

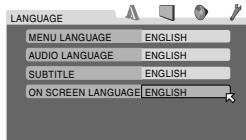

5 Select the mode setting.

Press \triangle ∇ to select the desired setting, then press **ENTER**.

6 Return to the normal screen.

Press **SET UP**.

Menu/Audio/Subtitle Language Set (DVD deck only)

Some DVD discs contain the DVD menu display, audio, subtitle in multiple languages. With these discs, you can set the default language as you like.

- The procedure shows how to set "MENU LANGUAGE" on the DVD menu screen as an example.

1 Turn on the unit.

Press ψ /I.

2 Select the DVD deck.

On the unit

Press **VCR/DVD** repeatedly so that the DVD indicator lights up.

On the remote control

Press **DVD** so that the DVD indicator lights up.

3 Access the DVD Set Up menu screen.

- 1 Press **SET UP**.
- 2 Press \triangleleft \triangleright to select "LANGUAGE."

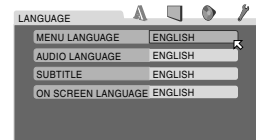

4 Select the mode.

Press \triangle ∇ to move \boxtimes to "MENU LANGUAGE," then press **ENTER**.

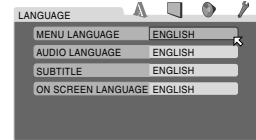

5 Select the mode setting.

Press \triangle ∇ to select the desired setting, then press **ENTER**.

- See "Language Code List" (pg. 17).

6 Return to the normal screen.

Press **SET UP**.

NOTE:

When the selected language is not available on the disc, the disc's default menu language is played back.

Language Code List

AA	Afar	IK	Inupiak	RN	Kirundi
AB	Abkhazian	IN	Indonesian	RO	Rumanian
AF	Afrikaans	IS	Icelandic	RU	Russian
AM	Ameharic	IW	Hebrew	RW	Kinyarwanda
AR	Arabic	JL	Yiddish	SA	Sanskrit
AS	Assamese	JW	Javanese	SD	Sindhi
AY	Aymara	KA	Georgian	SG	Sangho
AZ	Azerbaijani	KK	Kazakh	SH	Serbo-Croatian
BA	Bashkir	KL	Greenlandic	SI	Singhalese
BE	Byelorussian	KM	Cambodian	SK	Slovak
BG	Bulgarian	KN	Kannada	SL	Slovenian
BH	Bihari	KO	Korean (KOR)	SM	Samoan
BI	Bislama	KS	Kashmiri	SN	Shona
BN	Bengali, Bangla	KU	Kurdish	SO	Somali
BO	Tibetan	KY	Kirghiz	SQ	Albanian
BR	Breton	LA	Latin	SR	Serbian
CA	Catalan	LN	Lingala	SS	Siswati
CO	Corsican	LO	Laothian	ST	Sesotho
CS	Czech	LT	Lithuanian	SU	Sundanese
CY	Welsh	LV	Latvian, Lettish	SV	Swedish
DA	Danish	MG	Malagasy	SW	Swahili
DZ	Bhutani	MI	Maori	TA	Tamil
EL	Greek	MK	Macedonian	TE	Telugu
EO	Esperanto	ML	Malayalam	TG	Tajik
ET	Estonian	MN	Mongolian	TH	Thai
EU	Basque	MO	Moldavian	TI	Tigrinya
FA	Persian	MR	Marathi	TK	Turkmen
FI	Finnish	MS	Malay (MAY)	TL	Tagalog
FJ	Fiji	MT	Maltese	TN	Setswana
FO	Faroese	MY	Burmese	TO	Tonga
FY	Frisian	NA	Nauru	TR	Turkish
GA	Irish	NE	Nepali	TS	Tsonga
GD	Scots Gaelic	NL	Dutch	TT	Tatar
GL	Galician	NO	Norwegian	TW	Twì
GN	Guarani	OC	Occitan	UK	Ukrainian
GU	Gujarati	OM	(Afan) Oromo	UR	Urdu
HA	Hausa	OR	Oriya	UZ	Uzbek
HI	Hindi	PA	Panjabi	VI	Vietnamese
HR	Croatian	PL	Polish	VO	Volapuk
HU	Hungarian	PS	Pashto, Pushto	WO	Wolof
HY	Armenian	PT	Portuguese	XH	Xhosa
IA	Interlingua	QU	Quechua	YO	Yoruba
IE	Interlingue	RM	Rhaeto-Romance	ZU	Zulu

18_{EN}

OPERATIONS ON VHS DECK

Basic Playback

- Turn on the TV and select the video channel (or AV mode).
- Slide the **TV/VCR/DVD** switch on the remote control to the right.

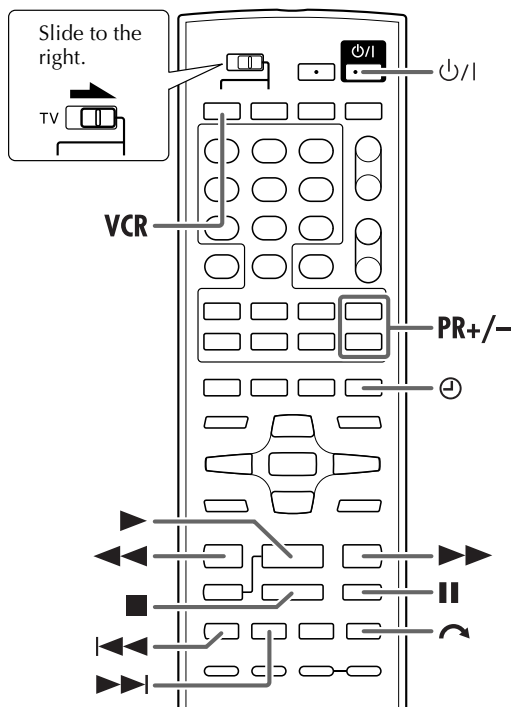
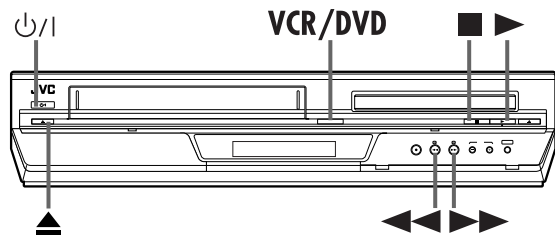

- Clean the video heads using a dry cleaning cassette — ECL-3F — when:**
- Rough, poor picture appears while a tape is played back.
 - The picture is unclear or no picture appears.
 - "USE CLEANING CASSETTE" appears on the screen (only with "O.S.D." set to "ON"). (☞ pg. 53)
- NOTE:**
The heads get dirty in the following cases:
- in an environment prone to extreme temperature or humidity
 - in a dusty environment
 - flaw, dirt or mold on video tapes
 - continuous usage for a long time

1 Load a cassette.

Make sure the window side is up, the rear label side is facing you and the arrow on the front of the cassette is pointed toward the unit.

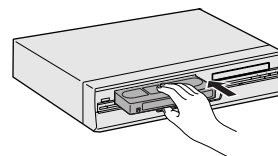

- Do not apply too much pressure when inserting.
- If the record safety tab has been removed, playback begins automatically. Although the DVD deck is selected, the VHS deck is selected automatically.
- The unit's power comes on automatically and the counter is reset to 0:00:00.

2 Select the VHS deck.

On the unit
Press **VCR/DVD** repeatedly so that the VCR indicator lights up.

On the remote control
Press **VCR** so that the VCR indicator lights up.

3 Find the programme start point.

If the tape is advanced past the start point, press ◀◀. To go forward, press ▶▶.

4 Start playback.

Press ▶. "bEst" appears blinking on the front display panel during automatic tracking. (☞ pg. 23)

5 Stop playback.

Press ■. Then press ▲ on the VHS deck to remove the cassette.

Usable cassettes

- Compact VHS camcorder recordings can be played on this unit. Simply place the recorded cassette into a VHS Cassette Adapter and it can be used just like any full-sized VHS cassette.
- This video recorder is equipped with SQPB (S-VHS QUASI PLAYBACK) that lets you watch tapes recorded in the S-VHS format and the SP mode with regular VHS resolution.
 - * SQPB does not deliver Super VHS resolution.
- This video recorder can record on regular VHS and Super VHS cassettes. However, it will record regular VHS signals only.
 - * S-VHS recording is not possible with this recorder.

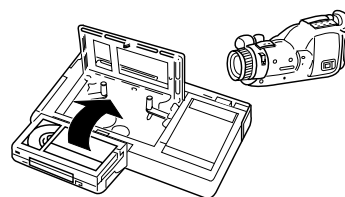

Playback Features

- Turn on the TV and select the video channel (or AV mode).
- Slide the **TV/VCR/DVD** switch on the remote control to the right.

ATTENTION
 In the search, still, slow-motion or frame-by-frame playback mode,

- the picture will be distorted.
- the noise bars will appear.
- there may be a loss of colour.
- you cannot hear the sound.

Still Picture/Frame-By-Frame Playback

1 Pause during playback.
 Press **II**.
 • If there is vertical jitter, press **PR +/-** on the remote control to correct the picture.

2 Activate frame-by-frame playback.
 Press **II**.

Slow Motion

While playback is paused, press and hold **II** for 2 seconds, then release. Press **II** and release again to return to still picture.

NOTE:
 During slow motion playback, some noise may appear on the TV screen. Press **PR +** or **-** on the remote control to eliminate the noises.

Variable Speed Search

During playback, press **▶▶** for forward variable speed search, or **◀◀** for reverse variable speed search.

- The speed changes for each direction by pressing **◀◀** and **▶▶** repeatedly.
 When pressing **▶▶**: +5x ↔ +7x
 When pressing **◀◀**: -1x ↔ -5x ↔ -7x
 (Once **◀◀** is pressed, reverse search starts in -1x normal playback speed. After this process, each press of **◀◀** changes the search speed between -5x and -7x.)

NOTE:
 The search speed changes in the same way for SP and LP mode.

To resume normal playback, press **▶**.

Skip Search

During playback, press **↶** 1 to 6 times to skip over unwanted sections. Each press initiates a 30-second period of fast-motion playback. Normal playback resumes automatically.

To resume normal playback during a Skip Search, press **▶**.

Index Search

Your unit automatically marks index codes at the beginning of each recording. This function gives you quick access to any one of 9 index codes in either direction.

NOTE:
 Before starting, make sure the unit is in the Stop mode.

Activate Index Search.

Press **◀◀** or **▶▶**. "◀◀ 1" or "▶▶ 1" is displayed on the TV screen and search begins in the corresponding direction.

- To access index codes 2 through 9, press **◀◀** or **▶▶** repeatedly until the correct index number is displayed.

Example:
 To locate the beginning of B from the current position, press **◀◀** twice.
 To locate the beginning of D from the current position, press **▶▶** once.

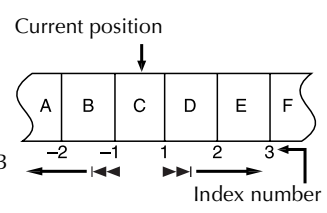

- When the specified index code is located, playback begins automatically.

Next Function Memory

The Next Function Memory "tells" the unit what to do after rewinding. Before continuing, make sure the unit is in the Stop mode.

- a- For Automatic Start Of Playback
 Press **◀◀**, then press **▶** within 2 seconds.
- b- For Automatic Power Off
 Press **◀◀**, then press **⏻** within 2 seconds.
- c- For Automatic Timer Standby
 Press **◀◀**, then press **⏸** within 2 seconds.
- d- For Automatic Cassette Ejection After Tape Rewind
 Press **◀◀**, then press **⏏** within 2 seconds.

One Touch Replay

Press **↶** during playback. Pressing **↶** once moves the playback position back to about 7 seconds before the current position. You can press **↶** up to 4 times each One Touch Replay.

20 EN

OPERATIONS ON VHS DECK (cont.)

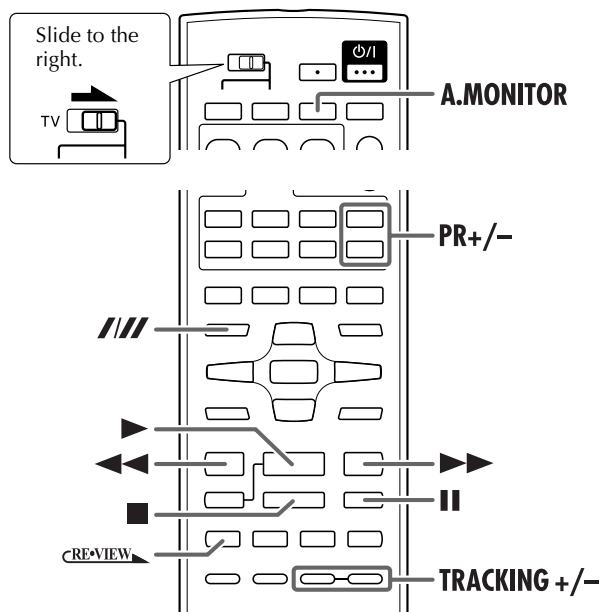

Manual Tracking

Your unit is equipped with automatic tracking control. During playback, you can override this and adjust the tracking manually by pressing the **TRACKING +/-** buttons.

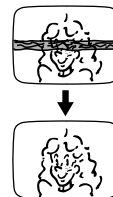

1 Override automatic tracking.

During playback, press **TRACKING +** and **-** at the same time.

2 Adjust the tracking manually.

Press **TRACKING +/-**.

- Press **TRACKING +** and **-** at the same time again to return to automatic tracking.

NOTE:

When a new tape is inserted, the unit enters the automatic tracking mode automatically.

Soundtrack Selection

Your unit is capable of recording three soundtracks (HI-FI L, HI-FI R and NORM) and will play back the one you select.

During Playback

Pressing **A.MONITOR** changes the soundtrack as follows:

Track	Use
On-screen display	
HI FI L R	For Hi-Fi stereo tapes
HI FI L	For main audio of Bilingual tapes
HI FI R	For sub audio of Bilingual tapes
NORM	For audio-dubbed tapes
HI FI NORM	For audio-dubbed tapes

NOTES:

- "HIFI L R" should normally be selected. In this mode, Hi-Fi stereo tapes are played back in stereo, and the normal audio track is played back automatically for tapes with only normal audio.
- For instructions on recording stereo and bilingual programmes, refer to page 23.
- "O.S.D." must be set to "ON" or the on-screen displays will not appear. (☞ pg. 53)

Instant ReView

Simply by pressing a single button, the unit power comes on, rewinds, and begins playback of the last timer-recorded programme. If you have several programmes recorded, you can easily access any of them.

NOTE:

Before starting, make sure that the unit is off and that the Timer mode is disengaged.

Activate Instant ReView.

Press **REVIEW**. The unit power comes on and the unit searches for the index code indicating the start of the last timer-recorded programme. Once it's found, playback begins automatically.

- To watch the first of the 3 programmes, press **REVIEW** three times. The unit searches and begins playback automatically. You can access a programme as far as 9 index codes away from the current tape position.

Repeat Playback

Your unit can automatically play back the whole tape 100 times repeatedly.

1 Start playback.

Press **▶**.

2 Activate Repeat Playback.

Press **▶** and hold for over 5 seconds, then release.

- The Play indicator (**▶**) on the front display panel blinks slowly.
- After playing back a tape 100 times, the unit stops automatically.

3 Stop Repeat Playback.

Press **■** at any time.

- Pressing **▶**, **◀◀**, **▶▶** or **||** also stops Repeat Playback.

Basic Recording

- Turn on the TV and select the video channel (or AV mode).
- Slide the **TV/VCR/DVD** switch on the remote control to the right.

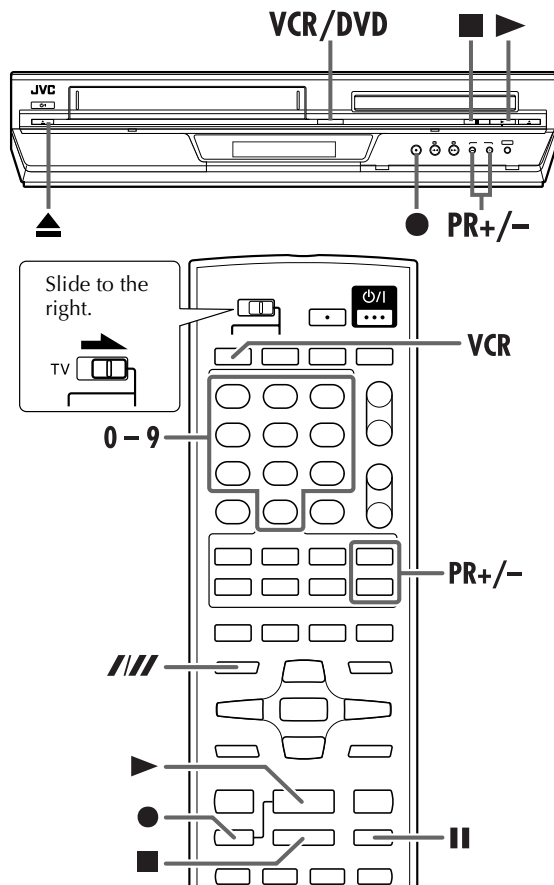

1 Load a cassette.

- Insert a cassette with the record safety tab intact.
- The unit's power comes on automatically and the counter is reset to 0:00:00.

2 Select the VHS deck.

- On the unit**
Press **VCR/DVD** repeatedly so that the VCR indicator lights up.
- On the remote control**
Press **VCR** so that the VCR indicator lights up.

3 Choose a programme.

Press **PR +/-** or the **number keys** to select the channel you wish to record.

4 Set the tape speed.

Press **///**. The current setting appears on the front display panel or TV screen. Press **///** again to change the setting while the tape speed is displayed on the TV screen.

5 Start recording.

- Press and hold **●** and press **▶** on the remote control, or press **●** on the unit.
- If "O.S.D." is set to "ON" (pg. 53), "MARK" blinks on the screen while an index code is being marked.
 - When "DIRECT REC" is set to "ON" (pg. 53), if you press any button just after pressing **●** on the unit (or **●** and **▶** on the remote control), the unit may not function properly.

B.E.S.T. works at the beginning of both the first SP and the first LP recording after inserting the cassette. (pg. 23)

If "DIRECT REC" is set to "ON," the programme that appears on the TV screen will be recorded. (pg. 53)

6 Pause/Resume recording.

- Press **||**. Press **▶** to resume recording.
- You can select channel during the Record Pause mode.

7 Stop recording.

Press **■**. Then press **▲** on the VHS deck to remove the cassette.

Recording Resume Function

If there is a power outage during recording, Instant Timer Recording, or timer recording (pg. 21, 22, 26), the recording will resume automatically when power is restored to the unit unless the unit's memory backup has expired.

Accidental erasure prevention

To prevent accidental recording on a recorded cassette, remove its safety tab. To record on it later, cover the hole with adhesive tape.



NOTE:

When the end of the tape is reached during recording, the unit stops and "O" and "▶" blink on the front display panel.

22 EN

OPERATIONS ON VHS DECK (cont.)

Recording Features

- Turn on the TV and select the video channel (or AV mode).
- Slide the **TV/VCR/DVD** switch on the remote control to the right.

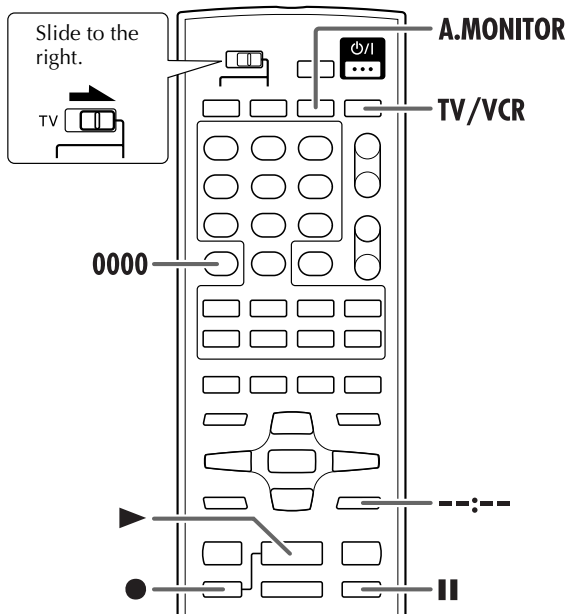

Recording One Programme While Watching Another

If your unit is connected to the TV via the AV connection, press **TV/VCR**. The unit's VCR indicator and the TV broadcast being recorded disappear. Once recording is in progress, all you need to do is to set the channel controls on the TV for the station you wish to view.

- The programme selected with the TV's channel controls appears on the TV screen, while the one selected with the unit's **PR** buttons is recorded on the tape.
- If a decoder is connected to the unit (see pg. 51), you can select a scrambled channel as well with the TV channel controls.

NOTE:

You can also use the DVD deck in the following cases. Before use, be sure to turn on the unit and select the DVD deck.

- During recording
- During timer recording
- During timer standby mode

Instant Timer Recording (ITR)

This easy method lets you record for from 30 minutes to 6 hours (selectable in 30-min. increments), and shuts the unit off after recording is finished.

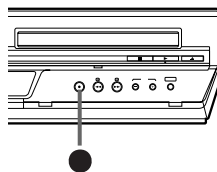

1 Start recording.

Press ● on the unit.

2 Engage the ITR mode.

Press ● again. "○" blinks and "0:30" appears on the front display panel.

3 Set the recording duration.

If you want to record for more than 30 minutes, press ● to extend the time. Each press extends recording time by 30 minutes.

NOTES:

- You can only perform ITR using the ● button on the unit's front panel.
- Still picture playback stops automatically after 5 minutes to protect the heads.
- When the end of the tape is reached during Instant Timer Recording or timer recording, the unit is turned off and "○" and "▷" blink on the front display panel.
- During Instant Timer Recording, any other timer programmed recording won't start even if their start time has come. In such a case, the timer programmed recording starts (if the end time of the timer programmed recording is set after the end of Instant Timer Recording) after the Instant Timer Recording finishes.

Elapsed Recording Time Indication

1 Set the counter display.

Press --:-- until a counter reading appears on the front display panel.

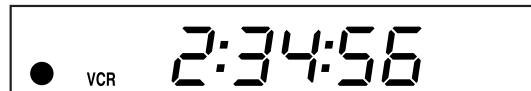

2 Reset the counter.

Press **0000** before starting recording or playback.

- The counter is reset to "0:00:00" and shows the exact elapsed time as the tape runs. You can check the exact time of a recording or playback.

Tape Remaining Time

Press --:-- until the time remaining on the tape appears.

- The front display panel shows the tape remaining time with ":" blinking.



- By pressing the --:-- button, you can change the display to show the channel position, clock time, counter reading, and tape remaining time.

* The channel position is not displayed during playback.

NOTES:

- When you press --:--, the on-screen display appears on the TV screen for 5 seconds, then the displays other than the counter disappears. To clear the counter display, press --:--.
- Depending on the type of tape being used, the tape remaining time reading may not appear right away, or is not correct. "--:--" may sometimes appear with ":" blinking, or the display may blink on occasion.

Receiving Stereo and Bilingual Programmes

Your unit is equipped with a Sound-Multiplex decoder (A2) and a Digital stereo sound decoder (NICAM) making reception of stereo and bilingual broadcasts possible.

When the channel is changed, the type of broadcast being received will be displayed on the TV screen for a few seconds.

Type of broadcast being received	On-screen display
A2 Stereo	ST
A2 Bilingual	BIL.
Regular Monaural	(none)
NICAM Stereo	ST NICAM
NICAM Bilingual	BIL. NICAM
NICAM Monaural	NICAM

- To listen to a stereo programme, press **A.MONITOR** until "HIFI L R" appears on the TV screen.
- To listen to a bilingual programme, press **A.MONITOR** until "HIFI L R" or "HIFI R" appears on the TV screen.
- To listen to the standard (Regular Monaural) audio while receiving a NICAM broadcast, press **A.MONITOR** until "NORM" appears on the TV screen.

NOTE:

"O.S.D." must be set to "ON," or the on-screen displays will not appear. (pg. 53)

To Record Stereo and Bilingual Programmes (A2)

Stereo programmes are automatically recorded in stereo on the Hi-Fi audio track (with the normal audio track recording mixed L and R channel sound).

- Bilingual programmes are automatically recorded in bilingual on the Hi-Fi audio track. The main soundtrack will be recorded on the normal audio track.

To Record NICAM Stereo and Bilingual Programmes

The NICAM audio programme will be recorded on the Hi-Fi audio track, and the standard audio programme will be recorded on the normal audio track.

NOTES:

- If the quality of stereo sound being received is poor, the broadcast will be received in monaural with better quality.
- Before playing back a programme recorded in stereo, or a bilingual programme, refer to "Soundtrack Selection" on page 20.

B.E.S.T. Picture System

The B.E.S.T. (Biconditional Equalised Signal Tracking) system checks the condition of the tape in use during playback and recording, and compensates to provide the highest-possible playback and recording pictures. You can set "B.E.S.T." to "ON" or "OFF" to your preference. (pg. 53)

Playback

The unit assesses the quality of the tape once you initiate playback.

- The unit adjusts the playback picture quality based on the quality of the tape in use.
- B.E.S.T. is active during automatic tracking. "bEst" appears blinking on the front display panel.
- "bEst" only appears at the beginning of automatic tracking. Even though it doesn't appear after that, the B.E.S.T. function is operative.

Recording

The unit assesses the quality of the tape once you initiate recording.

- The unit spends approximately 7 seconds assessing the condition of the tape, then begins recording.

ATTENTION

Since the B.E.S.T. system works before recording actually starts, there is a delay of approximately 7 seconds after ● and ► on the remote control are pressed, or ● on the unit is pressed. To make sure you record the desired scene or programme in its entirety, first perform the following steps:

- 1 Press and hold II and press ● to engage the Record Pause mode.
- The unit then automatically checks the condition of the tape and, after approximately 7 seconds, re-enters Record Pause mode.
- 2 Press ► to start recording.

If you want to bypass the B.E.S.T. system and begin recording immediately, set "B.E.S.T." to "OFF". (pg. 53)

24 EN

OPERATIONS ON VHS DECK (cont.)

SHOWVIEW™ Timer Programming

With the SHOWVIEW system, timer programming is greatly simplified because each TV programme has a corresponding code number which your unit is able to recognize.

Before performing the SHOWVIEW Timer Programming:

- Make sure that the unit's built-in clock is set properly.
- Insert a cassette with the safety tab in place. The unit will come on automatically.
- Turn on the TV and select the video channel (or AV mode).
- Slide the TV/VCR/DVD switch on the remote control to the right.

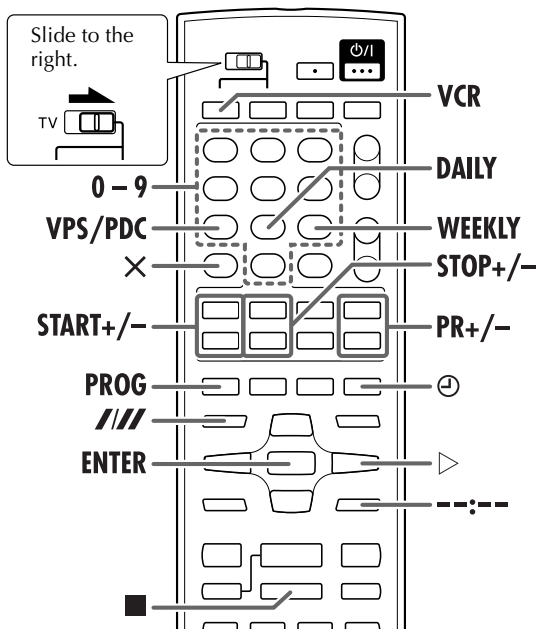

1 Select the VHS deck.

On the unit

Press **VCR/DVD** repeatedly so that the VCR indicator lights up.

On the remote control

Press **VCR** so that the VCR indicator lights up.

2 Access the SHOWVIEW screen.

Press **PROG**.

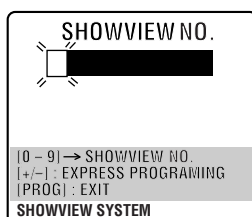

3 Enter the SHOWVIEW number.

Press the **number keys** to enter the SHOWVIEW number of a programme you wish to record.

- If you make a mistake, press **X** and input the correct number.

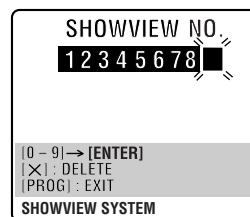

4 Access the SHOWVIEW Program screen.

Press **ENTER**, then the SHOWVIEW Program screen appears (if you're just starting out, "P1" appears).



IMPORTANT

Make sure the channel position number you wish to record is displayed; if not, or "TV PROG" shows "--", press **PR +/-** to input the channel position number on which your unit receives the station, then press **ENTER** or **>**.

- If the number you entered is invalid, "ERROR" appears on the TV screen. Press **X** and input a valid SHOWVIEW number.

5 Set the tape speed.

Press **///**.

6 Set the VPS/PDC mode.

Press **VPS/PDC** (number key "7") to select "ON" or "OFF."

- If "VPS/PDC ON" is displayed on the TV screen, "VPS/PDC" is set to "ON."
 - If "VPS/PDC OFF" is displayed on the TV screen, "VPS/PDC" is set to "OFF."
- ☞ "VPS/PDC Recording" on page 25.

7 Return to the normal screen.

Press **PROG** or **ENTER**. "PROGRAM COMPLETED" appears on the TV screen for about 5 seconds, then the normal screen appears.

- Repeat steps 2 – 7 for each additional programme.

8 Engage the unit's timer mode.

Press **⊖**. The unit turns off automatically and "⊖" appears on the front display panel.

- To disengage the timer mode, press **⊖** again.

NOTES:

- To Change The Stop Time:
— press **STOP +/-** after pressing **ENTER** in step 4. You can compensate for anticipated programme schedule delays.
- To Timer-Record Weekly Or Daily Serials:
— after pressing **ENTER** in step 4, press **WEEKLY** (number key "9") for weekly serials or **DAILY** (number key "8") for daily serials (Monday — Friday). Either "WEEKLY" or "DAILY" appears on the TV screen. Pressing the button again makes the corresponding indication disappear.
- You can programme this unit to timer-record as many as 8 programmes. If you try to programme the unit to record a ninth, "PROGRAM FULL" appears on the TV screen and "FULL" appears on the front display panel. To record the extra programme, you must first cancel any unnecessary programmes. (☞ pg. 27)
- If there is a conflict in the timer schedule and one programme overlaps with another, the programme starting earlier or programme with the lower programme number will be recorded.

Satellite Receiver Users

To timer-record a satellite broadcast using the SHOWVIEW system:

- 1 Set "L-2 SELECT" to "AV". (☞ pg. 54)
- 2 Perform steps 1 – 8.
- 3 Set the satellite receiver to the appropriate channel before the selected programme begins.
- 4 Leave the satellite receiver's power on.

VPS/PDC Recording

Now available from some TV stations, PDC (Programme Delivery Control) and VPS (Video Programme System) are service designed to assure safe, accurate timer recording. With this system, special code signals are transmitted together with the audio/video signals. These code signals control your unit and have precedence over the advertised times you may have preset into the timer. This means that your unit will start and stop recording when the preset TV programmes actually start and end — even if the broadcast time of a preset TV programme is changed.

NOTES:

- When you use Express Timer Programming, set the start time (VPS or PDC time) exactly as advertised in the TV listing. A different time than advertised will result in no recording.
- VPS/PDC recording is also possible when a satellite receiver or a cable system is connected to L-2 IN/DECODER connector on your unit.
- VPS/PDC recording is also possible via the L-1 IN/OUT connector.

How to check if the station being received transmits a VPS/PDC signal

- 1 Press **--:--** until the channel position appears on the front display panel.
- 2 Hold down **START +** for about 5 seconds. "VPS/PDC" appears blinking on the TV screen. If a VPS/PDC signal is detected from the station, "VPS/PDC" will stop blinking. If no VPS/PDC signal is detected from the station, "VPS/PDC" will blink at a slower rate.
- 3 Press **--:--** or **START +** again to return to normal display.

26 EN

OPERATIONS ON VHS DECK (cont.)

Express Timer Programming

If you do not know the SHOWVIEW number for the programme you wish to record, use the following procedure to set your unit to timer-record the programme.

Before performing Express Timer Programming:

- Make sure that the unit's built-in clock is set properly.
- Insert a cassette with the safety tab in place. The unit will come on automatically.
- Turn on the TV and select the video channel (or AV mode).
- Slide the TV/VCR/DVD switch on the remote control to the right.

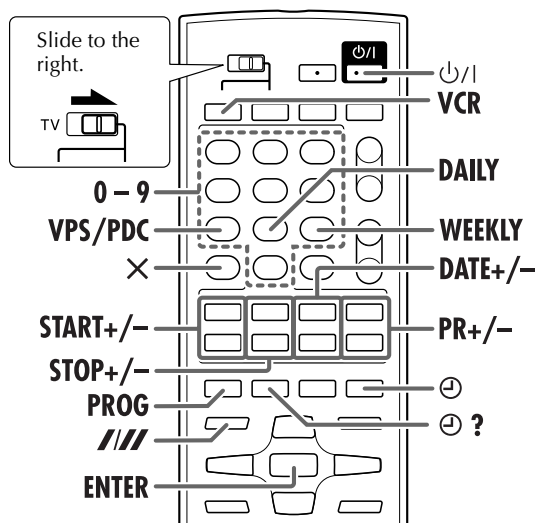

Example: To timer-record the programme from 21:00 to 22:00 on 25th December, on channel 1.

1 Select the VHS deck.

On the unit

Press **VCR/DVD** repeatedly so that the VCR indicator lights up.

On the remote control

Press **VCR** so that the VCR indicator lights up.

2 Access the SHOWVIEW screen.

Press **PROG**.

3 Access the Programme screen.

Press **START +/-**. (If you're just starting out, "P1" appears.)

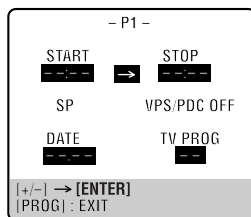

4 Enter the programme start time.

Press **START +/-** to enter the time you want recording to start.

- Press and hold **START +/-** to move in 30-minute increments, or press and release repeatedly to move 1 minute at a time.

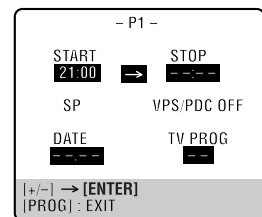

5 Enter the programme stop time.

Press **STOP +/-** to enter the time you want recording to stop.

- Press and hold **STOP +/-** to move in 30-minute increments, or press and release repeatedly to move 1 minute at a time.

6 Enter the programme date.

Press **DATE +/-**.

- The current date appears on the TV screen. The date you enter appears in its place.

7 Enter the channel position.

Press **PR +/-**.

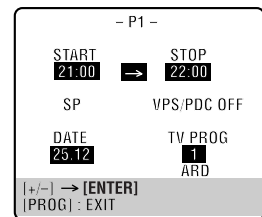

8 Set the tape speed.

Press **///**.

9 Set the VPS/PDC mode.

Press **VPS/PDC** (number key "7") to select "ON" or "OFF".

- If "VPS/PDC ON" is displayed on the TV screen, "VPS/PDC" is set to "ON".
- If "VPS/PDC OFF" is displayed on the TV screen, "VPS/PDC" is set to "OFF".
- ☞ "VPS/PDC Recording" on page 25.

10 Return to the normal screen.

Press **PROG** or **ENTER**. "PROGRAM COMPLETED" appears on the TV screen for about 5 seconds, then the normal screen appears.

- Repeat steps 2 - 10 for each additional programme.

11 Engage the unit's timer mode.

Press **⊙**. The unit turns off automatically and "⊙" appears on the front display panel.

- To disengage the timer mode, press **⊙** again.

To Timer-Record Weekly Or Daily Serials:

— anytime during steps 1 through 2, press **WEEKLY** (number key "9") for weekly serials or **DAILY** (number key "8") for daily serials (Monday – Friday). Either "WEEKLY" or "DAILY" appears on the TV screen. Pressing the button again makes the corresponding indication disappear.

NOTES:

- You can programme this unit to timer-record as many as 8 programmes. If you try to programme the unit to record a ninth, "PROGRAM FULL" appears on the TV screen and "FULL" appears on the front display panel. To record the extra programme, you must first cancel any unnecessary programmes. (See "To cancel or change a programme")
- If there is a conflict in the timer schedule and one programme overlaps with another, the programme starting earlier or programme with the lower programme number will be recorded.

Satellite Receiver Users

To timer-record a satellite broadcast using Express Timer Programming:

- 1 Set "L-2 SELECT" to "A/V". (See pg. 54)
- 2 Perform steps 1 – 3. Enter "L-2" for the channel position in step 2.
- 3 Set the satellite receiver to the appropriate channel before the selected programme begins.
- 4 Leave the satellite receiver's power on.

Check, Cancel and Change Programmes

1 Disengage the timer mode.

Press \ominus , then press \cup/\downarrow .

2 Access the Programme Check screen.

Press $\ominus ?$.

	START	STOP	CH	DATE
1	8:00	10:00	3	24.12
2	10:00	10:45	2	25.12
3	11:30	13:00	1	25.12
4				
5				
6				
7				
8				

$\ominus ?$: NEXT

3 Access the Programme screen.

Press $\ominus ?$ again to check more information. Each time you press $\ominus ?$, the next programme's information appears.

- P1 -	
START	STOP
8:00	10:00
SP	VPS/PDC OFF
DATE	TV PROG
24.12	3
	WDR

$\ominus ?$: NEXT

To cancel or change a programme

4 Cancel or change a programme.

Press \times to cancel a programme. To change programme settings, press the appropriate button: **START** +/-, **STOP** +/-, **DATE** +/-, **PR** +/-, **VPS/PDC** (number key "7"), **DAILY** (number key "8"), **WEEKLY** (number key "9") and/or **///**.

5 Return to the normal screen.

Press $\ominus ?$ as many times as necessary. If there are still some programmes remaining, go on to step 6.

6 Return to the timer mode.

Press \ominus .

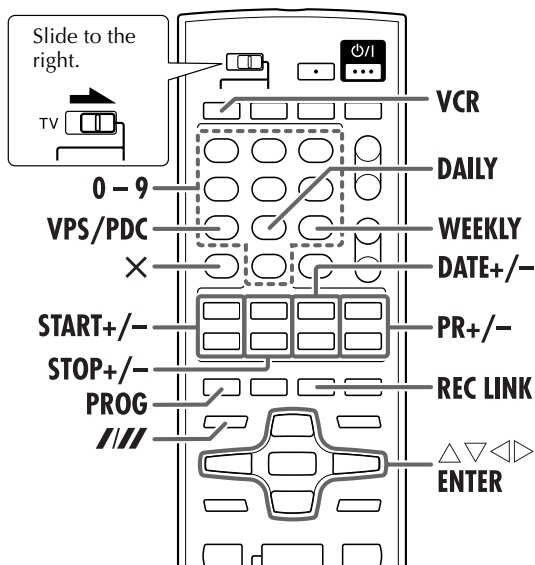

3 Cancel or change programme setting.

To cancel a programme, press X when the Programme screen you do not want is shown. "PROGRAM COMPLETED" appears on the TV screen for about 5 seconds, then the normal screen appears.

To change a programme, press the appropriate button: START +/-, STOP +/-, DATE +/-, PR +/-, VPS/PDC (number key "7"), DAILY (number key "8"), WEEKLY (number key "9") and/or /// when the Programme screen on which you want to make changes is shown, then press ENTER. "PROGRAM COMPLETED" appears on the TV screen for about 5 seconds, then the normal screen appears.

NOTE:

If the overlap is not yet solved, or another overlap occurs with the timer programme setting after making the last correction on a programme, the conflicting programmes will be shown on the Programme Check screen again. Repeat the above steps again until the overlap is solved.

When Programmes Overlap Each Other

If "PROGRAM OVERLAPPED" appears, you have another programme overlapping the programme you have just made. The Programme Check screen appears and conflicting programmes will start blinking.

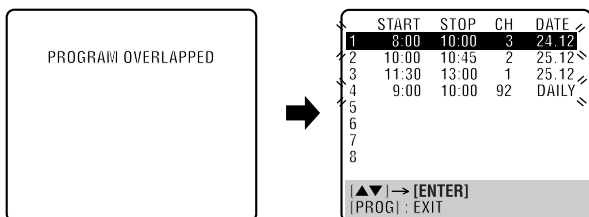

Example: Programme 1 (you have just made) and Programme 4 overlap each other.

1 Confirm the overlapping programmes.

Overlapping programmes blink on the TV screen.

2 Select the programme to modify.

Press ▲▼, then press ENTER or ▷.

- You can only select one of the overlapping programmes.

NOTE:

If you do not mind this overlap, press PROG to finish the timer programme setting. The programme with the lower programme number will be recorded and the other one will not be recorded correctly. If no changes are made for approximately 1 minute, the unit will return to the normal screen.

Automatic Satellite Programme Recording

This function allows you to automatically record a satellite programme which is timer-programmed on your external satellite receiver. Connect a satellite receiver to the unit's L-2 IN/DECODER connector and programme the timer on the satellite receiver. The unit starts or stops recording by the signals input from the satellite receiver. After recording, the unit's power shuts off automatically.

ATTENTION

- Be sure not to turn on the satellite receiver before the programme is executed; otherwise, the unit will start recording when the satellite receiver's power is turned on.
- If you have connected another appliance other than a satellite receiver to the L-2 IN/DECODER connector, be sure not to engage the Automatic Satellite Programme Recording mode; otherwise, the unit will start recording when the connected appliance's power is turned on.
- Automatic Satellite Programme Recording and timer-recording cannot be done at the same time.

Before performing the following steps:

- Make sure the satellite receiver is connected to the unit's L-2 IN/DECODER connector. (☞ pg. 50)
- Programme the timer on the satellite receiver.
- Insert a cassette with the safety tab in place.
- Slide the TV/VCR/DVD switch on the remote control to the right.

1 Select the VHS deck.

On the unit

Press **VCR/DVD** repeatedly so that the VCR indicator lights up.

On the remote control

Press **VCR** so that the VCR indicator lights up.

2 Select the L-2 SELECT mode.

Set "L-2 SELECT" to "AV" or "SAT." (☞ pg. 54)

- When you select "SAT", refer to "IMPORTANT" on page 50.

3 Set the tape speed.

Press **///**.

4 Engage the Automatic Satellite Programme Recording mode.

On the unit

Press and hold **SAT** for about 2 seconds.

On the remote control
Press and hold **REC LINK** for about 2 seconds.

- The "⏏" and "⏻" indicators light up and the unit turns off automatically.

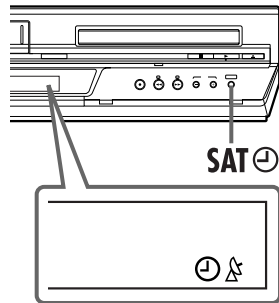

NOTES:

- Operations on the DVD deck are not possible when the Automatic Satellite Programme Recording mode is engaged or timer recording is in progress.
- To disengage the Automatic Satellite Programme Recording mode, press **REC LINK**. The "⏏" indicator goes off.
- If the unit's power is off, it is not possible to engage the Automatic Satellite Programme Recording mode.
- In step 4, if the "⏏" indicator does not light but instead blinks quickly even though your satellite receiver's power is off, Automatic Satellite Programme Recording will not work properly with that satellite receiver*. If this is the case, perform "Express Timer Programming" (☞ pg. 26) to timer-record a satellite programme.
** Some satellite receivers output signals even if the power is off. Automatic Satellite Programme Recording is not possible with those satellite receivers.*
- The "⏏" indicator blinks while Automatic Satellite Programme Recording is in progress.
- For timer programming of the satellite receiver, refer to the instruction manual of the satellite receiver.
- Automatic Satellite Programme Recording is not possible if your satellite receiver does not have a timer.
- Pressing the unit's ⏻ button while Automatic Satellite Programme Recording is in progress turns off the unit's power and disengages the Automatic Satellite Programme Recording mode.
- If there are more than one satellite programmes you wish to record with Automatic Satellite Programme Recording, it is not possible to set different tape speeds for each programme.
- Depending on the type of satellite receiver, the unit may not record a slight portion of the beginning of the programme or may record slightly longer than the actual length of the programme.
- If you engage the Automatic Satellite Programme Recording mode when the satellite receiver's power is on, the unit will not start Automatic Satellite Programme Recording even though the "⏏" and "⏻" indicators blink. When the satellite receiver shuts off once and is turned back on again, the unit starts recording.
- You can also record a programme from your cable system in the same way if the system has a timer.
- The B.E.S.T. system (☞ pg. 23) does not work while Automatic Satellite Programme Recording is in progress.
- Just Clock (☞ pg. 65) does not work when the Automatic Satellite Programme Recording mode is engaged.

30_{EN}

OPERATIONS ON DVD DECK

Basic Playback



- Turn on the TV and select the video channel (or AV mode).
- Slide the TV/VCR/DVD switch on the remote control to the right.

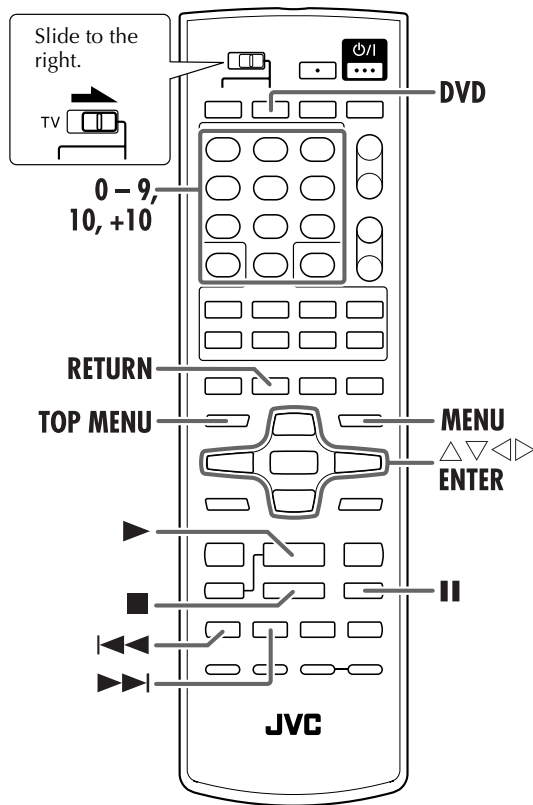
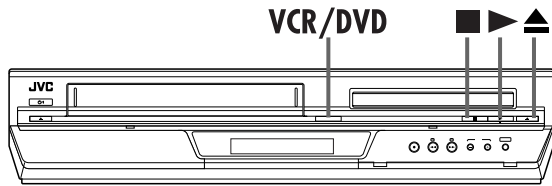

ATTENTION

- You can not use the DVD deck when the VHS deck is in the Automatic Satellite Programme standby and recording mode.
- You can use the DVD deck when the VHS deck is in the timer standby mode.
- If the unit does not accept an operation, ⊙ appears on the TV screen. (Operations are occasionally unacceptable even if ⊙ is not displayed.)

1 Load the disc.

- For details, refer to "Placing a Disc" (pg. 5).

2 Select the DVD deck.

On the unit

Press **VCR/DVD** repeatedly so that the DVD indicator lights up.

On the remote control

Press **DVD** so that the DVD indicator lights up.

3 Start playback.

Press **▶**.

Example: DVD VIDEO

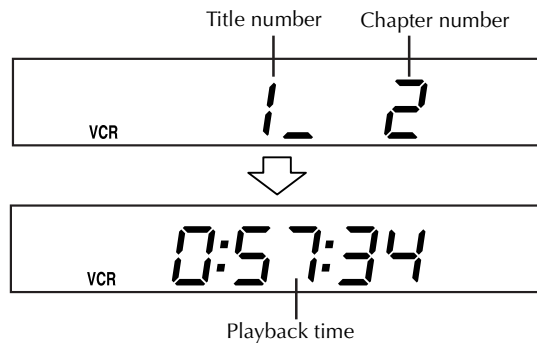

- You can switch the display on the front display panel between the title/chapter/track number and the playback time by pressing **-- --**.
- It may take a few seconds to start playback.
- When inserting a DVD or Video CD disc, a menu display may appear on the TV screen. To play back from the menu, refer to "Locating a Desired Scene Using the DVD Menu" (pg. 31) or "Locating a Desired Scene Using the Menu of a Video CD/SVCD with Playback Control (PBC) Function" (pg. 31).

4 Pause playback.

Press **||**.

- To resume normal playback, press **▶**.

5 Stop playback.

Press **■**.

- When "RESUME" (pg. 57) is "ON" or "DISC RESUME," the unit memorizes the position on the disc where you have interrupted playback.
 - To resume playback, press **▶**.
 - To stop playback completely, press **■** again.
- Press **▲** on the DVD deck to open the disc tray, then remove the disc.

Playback Features

- Turn on the TV and select the video channel (or AV mode).
- Slide the **TV/VCR/DVD** switch on the remote control to the right.

Locating a Desired Scene Using the DVD Menu



DVD VIDEO discs generally have their own menus which show the disc contents. These menus contain various items such as titles of movies, names of songs, or artist information, and display them on the TV screen. You can locate a desired scene using the DVD menu.

1 Access the DVD menu.

Press **TOP MENU** or **MENU**.

2 Start playback.

Press $\Delta \nabla \triangleleft \triangleright$ to select a desired item, then press **ENTER**.

- It may be possible to select the desired item using the **number** keys depending on the disc.

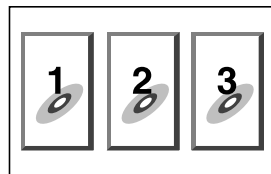

Example:

Locating a Desired Scene Using the Menu of a Video CD/SVCD with Playback Control (PBC) Function



Some Video CD/SVCD discs support the PBC function. PBC is an abbreviation of "PlayBack Control." A Video CD/SVCD disc recorded with PBC has its own menus, such as a list of the songs on the disc. You can locate a specific scene by using the menu.

1 Access the PBC menu.

In stop mode

Press **▶**.

- Depending on a disc, PBC menu may automatically appear on the TV screen by simply loading a disc on the unit. "Pbc" appears on the front display panel.

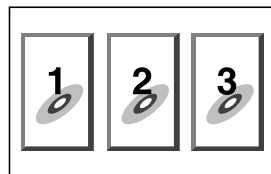

During playback

Press **RETURN**.

2 Start playback.

Press the appropriate **number keys**.

- The unit starts playback of the selected item.
- When "NEXT" or "PREVIOUS" appears on the TV screen: Pressing **▶▶** advances to the next page. Pressing **◀◀** returns to the previous page.
- The method of the operation is different depending on the disc.

To cancel PBC

Start playback by using the **number keys** instead of **▶**.

To reactivate PBC

- Press **TOP MENU** or **MENU**.
- Press **■** to stop playback, then press **▶**

Locating the Start Point of the Item or Skip the Item



Press **◀◀** or **▶▶** during playback.

Example:

To locate the beginning of item B from the current position, press **◀◀** twice. To locate the beginning of item D from the current position, press **▶▶** once.

- When the specified item is located, playback begins automatically.

Current position

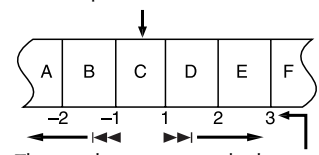

The number you press the button

Using the number keys

For DVD VIDEO

- While stopped: title is selected.
- While playing back: chapter is selected.

For Video CD/SVCD/Audio CD

Track is selected.

Examples:

To select 5, press the **number key "5."**

To select 25, press the **number key "+10," "+10,"** then **"5."**

To select 40, press **number key "+10"** three times, then **"10."**

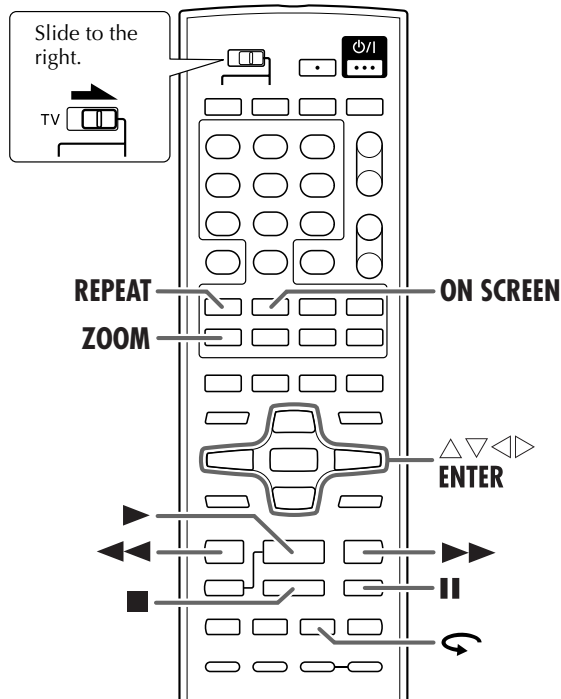

Still Picture/Frame-By-Frame Playback



1 Pause during playback.

Press **II**.

2 Activate frame-by-frame playback.

Press **II** to advance a still picture.
 • To resume normal playback, press **▶**.

Slow Motion



During playback, press **II**, then press **◀◀** for reverse slow motion playback, or **▶▶** for forward slow motion playback.

- Each press of **▶▶** changes the playback speed as follows: 1/32 → 1/16 → 1/4 → 1/2
- Each press of **◀◀** changes the playback speed as follows (only for DVD VIDEO discs): -1/32 → -1/16 → -1/4 → -1/2
- To resume normal playback, press **▶**.

NOTES:

- Reverse slow motion playback is possible only with the DVD VIDEO discs.
- This function may not work for some Video CD or SVCD.

Variable Speed Search



During playback, press **▶▶** for forward variable speed search, or **◀◀** for reverse variable speed search.

- The more times you press, the faster the playback picture moves.
- To resume normal playback, press **▶**.

OR

During playback, press and hold **▶▶** for forward variable speed search, or press and hold **◀◀** for reverse variable speed search.

- While you press and hold the button, the image is played back at 5x speed.
- To resume normal playback, release **◀◀** or **▶▶**.

NOTE:

During variable speed search the sound will be muted except when playing an Audio CD disc or when playing a DVD VIDEO disc at 1.5x speed search mode.

One Touch Replay



Press **↶** while playing back a DVD VIDEO disc. The playback position moves back about 10 seconds before the current position (only within the same title).

Zooming



Press **ZOOM** during playback or while paused.

- Each press of **ZOOM** changes the magnification as follows: 1.5x → 2x → 4x
- While zoomed, the picture may look coarse or distorted.

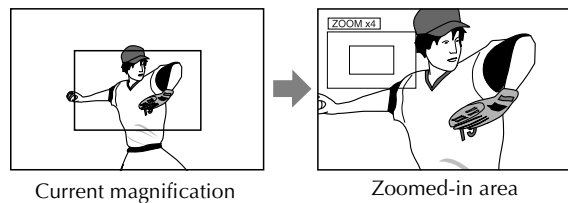

Press **△▽◀▶** to move the zoomed-in scene.

- To resume normal playback, press **ZOOM** repeatedly to select the normal size.

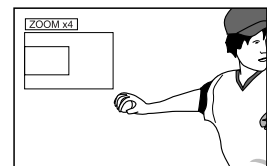

Repeat Playback



You can repeat playback as you like according to the type of disc.

- DVD VIDEO: during playback or in stop mode
- Audio CD: during playback or in stop mode
- Video CD/SVCD: in stop mode or during playback with PBC disactivated

1 Access the repeat mode.

Press **REPEAT**.

- Repeat mode is displayed on the TV.

2 Select the repeat mode.

Press **REPEAT** repeatedly to select the desired repeat mode, then press **ENTER**.

DVD VIDEO
 CHAP→TITLE→OFF→(Back to the beginning)

- | | |
|----------|--|
| CHAPTER: | The current chapter is played back repeatedly. |
| TITLE: | The current title is played back repeatedly. |
| OFF: | Each title and chapter is played back once. |

Video CD/SVCD/Audio CD
 TRACK→ALL→OFF→(Back to the beginning)

- | | |
|--------|--|
| TRACK: | The current track is played back repeatedly. |
| ALL: | All tracks are played back repeatedly. |
| OFF: | Each track is played back once. |

To cancel Repeat Playback,
 Press **REPEAT** repeatedly until "OFF" appears on the TV screen, then press **ENTER**.

NOTES:

- Repeat Playback is not possible with a Video CD or SVCD with PBC function.
- Repeat Playback may not work properly depending on the type of disc being used.
- You cannot select A-B Repeat Playback by pressing **REPEAT**.

A-B Repeat Playback



You can repeat the desired part.
 DVD VIDEO/Audio CD:during playback
 Video CD/SVCD:during playback with PBC disactivated

1 Access the on-screen bar.

Press **ON SCREEN** twice. The on-screen bar appears on the TV screen.

2 Select the menu item.

Press ◀▶ to move to , then press **ENTER**.

- The following pop-up window appears under the selected item.

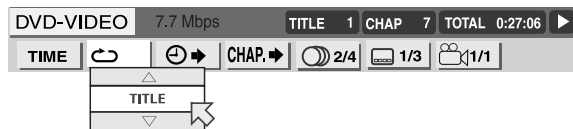

3 Select the repeat mode.

Press ▲▼ repeatedly to select "A-B."

4 Select the start point.

Press **ENTER** at the beginning of the part you want to repeat (point A).

- The following display appears in the on-screen bar.



5 Select the end point.

Press **ENTER** at the end of the part you want to repeat (point B).

- A-B Repeat Playback starts. The selected part of the disc (between point A and B) is played repeatedly.

To cancel A-B Repeat Playback

Repeat from step **1**, select "OFF" in step **3**, then press **ENTER**.

To clear the on-screen bar

Press **ON SCREEN**.

NOTE:

The points A and B must be set in the same title or track.

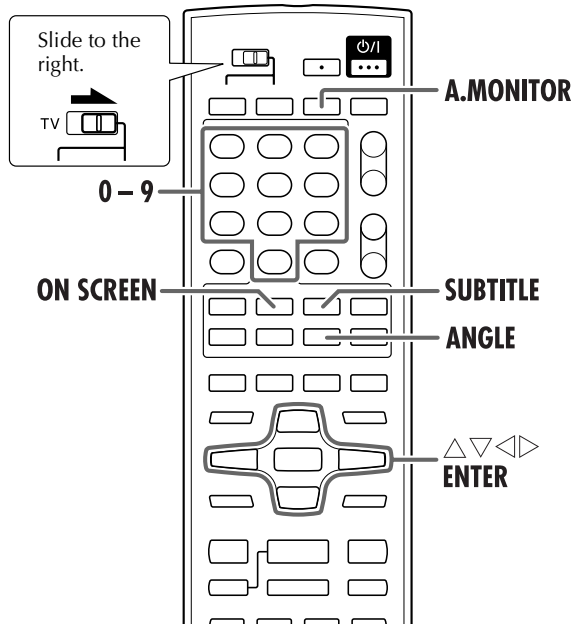

Example:

To play back from a point 2 (hours): 34 (minutes): 08 (seconds) elapsed

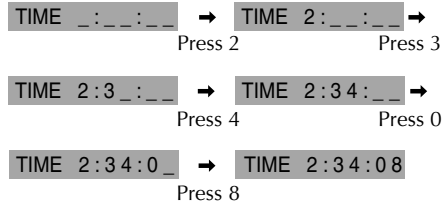

If you have specified a wrong selection, Press **<** repeatedly until the wrong number is erased, then press **number keys** to enter the correct numbers.

- The unit starts playback from the specified time.

To clear the on-screen bar Press **ON SCREEN**.

NOTES:

- Some DVD VIDEO discs do not contain time information, and it is not possible to use the Time Search function.
- Time Search cannot be used during Programme and Random Playback.

Time Search



You can play back a disc from the desired point by specifying the elapsed time from the beginning of the current title (for DVD VIDEO) or the disc (for Audio CD/Video CD) using the Time Search.

DVD VIDEO/Audio CD: during playback or in stop mode
Video CD/SVCD: during playback with PBC deactivated or in stop mode

1 Access the on-screen bar.

Press **ON SCREEN** twice. The on-screen bar appears on the TV screen.

2 Select the menu item.

Press **<>** to move **↔** to **⏪**, then press **ENTER**.
• The following pop-up window appears under the selected item.

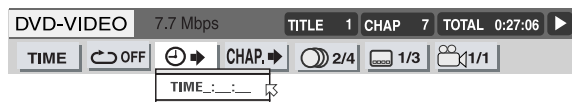

3 Select the time.

Press the **number keys** (0-9) to enter the time, then press **ENTER**.

Subtitle Selection



You can select subtitle language.

- During playback

1 Access the menu.

Press **SUBTITLE**.
• The following pop-up window appears on the TV screen.

Example (DVD): "ENGLISH" is selected out of 3 subtitle languages recorded.

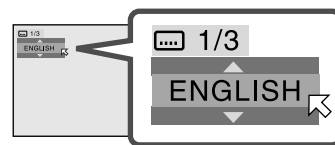

2 Select the subtitle language.

Press **Δ∇** or **SUBTITLE** repeatedly to select the desired subtitle language, then press **ENTER**.

- Each time you press the button, the subtitle language changes.
- The pop-up window disappears if no operation is done for about several seconds.

NOTES:

- **For DVD VIDEO**
Some subtitle languages are abbreviated in the pop-up window. See "Language Code List" (pg. 17).
- **For SVCD**
An SVCD can contain up to four subtitles. Pressing **SUBTITLE** changes the subtitles regardless of whether the subtitles are recorded or not.

Angle Selection



You can enjoy a variety of scene angles if the DVD VIDEO disc contains “multi-angle” parts, where multiple cameras were used to shoot the same scene from different angles.

- During playback

1 Access the menu.

Press **ANGLE**.

- The following pop-up window appears on the TV screen.

Example: The first view angle is selected out of 3 view angles recorded.

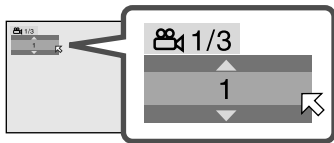

2 Select the view angle.

Press Δ / ∇ or **ANGLE** repeatedly to select the desired view angle, then press **ENTER**.

- Each time you press the button, the angle of the scene changes.
- The pop-up window disappears if no operation is done for about several seconds.

Example:

1/3 → 2/3 → 3/3 → (Back to the beginning)

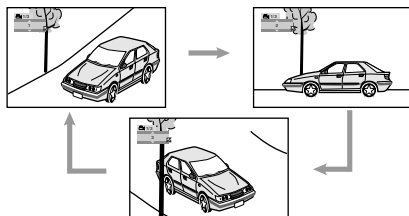

Audio Language and Sound Selection



The audio selection setting allows you to change the audio language of a movie, or to listen to karaoke with or without the vocal.

- During playback

1 Access the menu.

Press **A.MONITOR**.

- The following pop-up window appears on the TV screen.

Example: “ENGLISH” is selected out of 3 audio languages recorded during DVD VIDEO playback.

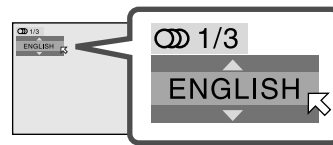

2 Select the audio language.

Press Δ / ∇ or **A.MONITOR** repeatedly to select the desired audio language, then press **ENTER**.

- Each time you press the button, the audio language changes.
- The pop-up window disappears if no operation is done for about several seconds.

DVD VIDEO (example)

1/3 ENGLISH → 2/3 FRENCH → 3/3 SPANISH → (Back to the beginning)

Video CD

ST → L → R → (Back to the beginning)

ST:	To listen to normal stereo playback.
L:	To listen to L (left) audio channel only.
R:	To listen to R (right) audio channel only.

SVCD

ST 1 → ST 2 → L 1 → R 1 → L 2 → R 2 → (Back to the beginning)

ST 1/ST 2:	To listen to normal stereo playback of ST 1 or ST 2 channel.
L 1/L 2:	To listen to the L (left) 1 or 2 audio channel.
R 1/R 2:	To listen to the R (right) 1 or 2 audio channel.

NOTE:

For DVD VIDEO disc, some audio languages are abbreviated in the pop-up window. See “Language Code List” (pg. 17).

36 EN

OPERATIONS ON DVD DECK (cont.)

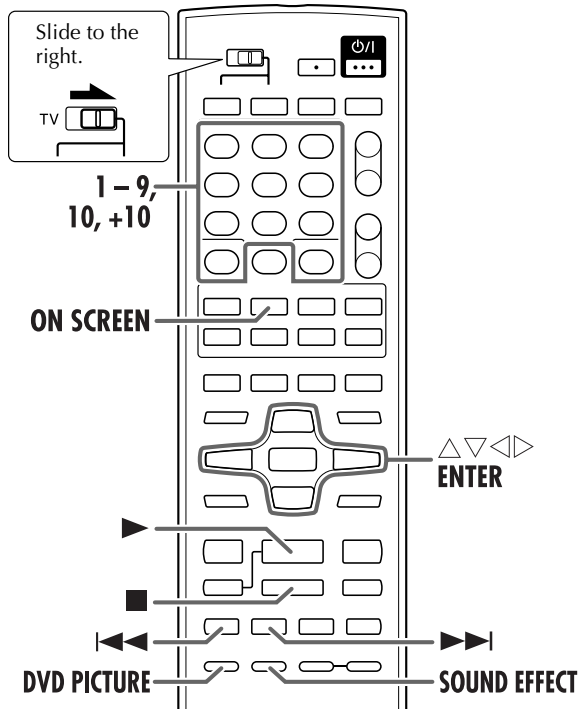

Examples:

- To select track 5, press the **number key "5."**
- To select 25, press the **number key "+10," "+10,"** then **"5."**
- To select 40, press **number key "+10"** three times, then **"10."**

If you have specified a wrong selection

Press $\Delta \nabla$ to move \boxtimes to the track to be corrected, then press \blacksquare . The track is erased and the next programmed tracks move up.

4 Start playback.

Press \blacktriangleright . Playback starts in the selected order.

- With an Audio CD disc, the programme table remains on the TV.
- When all of the programmed tracks have been played back, Programme Playback stops, but the programmed information remains.

To check the programme contents

During playback, press \blacksquare . Playback stops and the programme table appears on the TV screen.

- You can also check the programme contents through the on-screen bar during playback.

To clear the programme

Press \blacksquare while playback is stopped and the programme table appears on the TV screen.

To exit from Programme Playback

After clearing the programme, press ON SCREEN.

Programme Playback



You can play back up to 99 tracks in the desired order.

1 Access the on-screen bar.

Press ON SCREEN twice in stop mode.

2 Select the menu item.

Press $\triangleleft \triangleright$ to move \boxtimes to **PROG.**, then press ENTER.

- The programme table appears under the on-screen bar.



3 Select the tracks in the desired order.

Press the appropriate **number keys** to select the tracks.

Programme time

No.	Track
1	5
2	2
3	11
4	7
5	4
6	8
7	6
8	
9	
10	

Random Playback



You can play back all the tracks on the disc in random order.

1 Access the on-screen bar.

Press ON SCREEN twice in stop mode.

2 Select the menu item.

Press $\triangleleft \triangleright$ to move \boxtimes to **RND.**, then press ENTER.

- Playback starts in random order.



To clear the on-screen bar

Press ON SCREEN.

Sound Effect



Using the Sound Effect function, you can change the sound field.

- This function works only for analog audio output.

1 Access the selection menu.

Press **SOUND EFFECT** during playback.

- The current setting appears on the TV screen.

2 Select the Sound Effect mode.

Press **SOUND EFFECT** repeatedly to select the desired mode.

- Each time you press **SOUND EFFECT**, the Sound Effect mode changes as follows:
SOUND EFFECT:1→**SOUND EFFECT:2**→
SOUND EFFECT:3→**OFF**→(Back to the beginning)
- As the value becomes bigger, the Sound Effect works stronger.
- The selection menu disappears if no operation is done for about several seconds.

To deactivate Sound Effect

Press **SOUND EFFECT** repeatedly until "OFF" appears on the TV screen.

VFP Function

— Adjusting the Picture Quality



The VFP (Video Fine Processor) function enables you to adjust the picture character according to the type of programming, picture tone or personal preference.

1 Access the VFP setting menu.

Press **DVD PICTURE** during playback.

- The current setting appears on the TV screen.

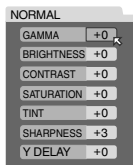

2 Select the VFP mode.

Press $\triangleleft \triangleright$ repeatedly.

- Each time you press $\triangleleft \triangleright$, the VFP mode changes as follows:
NORMAL→**CINEMA**→**USER 1**→**USER 2**→(Back to the beginning)

NORMAL:	For watching TV in a general room.
CINEMA:	For watching a movie software in a room with suppressed light.
USER 1/ USER 2:	You can adjust parameters that affect the picture appearance and store the settings. Go to step 3 .

To adjust picture appearance manually

3 Access the USER menu.

Press $\triangleleft \triangleright$ repeatedly to select "USER 1" or "USER 2."

4 Select the parameter.

Press $\triangle \nabla$ repeatedly to select a parameter you want to adjust, then press **ENTER**.

- Adjust gradually and confirm picture appearance results are as preferred.

GAMMA (LOW/MID/ HIGH):	Adjust this if the neutral color is bright or dark. The brightness of dark and bright portions is maintained.
BRIGHTNESS (-16 to +16):	Adjust this if the picture is bright or dark on the whole.
CONTRAST (-12 to +12):	Adjust this if the objects in far and near positions look unnatural.
SATURATION (-16 to +16):	Adjust this if the picture is whitish or blackish.
TINT (-16 to +16):	Adjust this if the appearance of flesh tone is unnatural.
SHARPNESS (LOW/ HIGH):	Adjust this if the picture is indistinct.
Y DELAY (-2 to +2):	Adjust this if the picture looks separately or overlapped.

- VFP menu disappears and the following pop-up window appears on the TV screen.

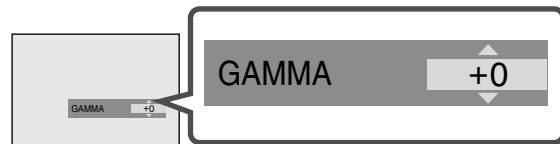

5 Adjust the parameter.

Press $\triangle \nabla$ repeatedly to change the setting, then press **ENTER**.

- The current VFP settings appear again. Repeat steps **4** and **5** to adjust other parameters.

To return to the normal screen

Press **DVD PICTURE**.

NOTE:

The VFP setting screen disappears if no operation is done for more than about 10 seconds.

Using the On-Screen Bar



You can check disc information while the disc is loaded and you can use some functions using the on-screen bar. The on-screen bar allows you the various playback operations.

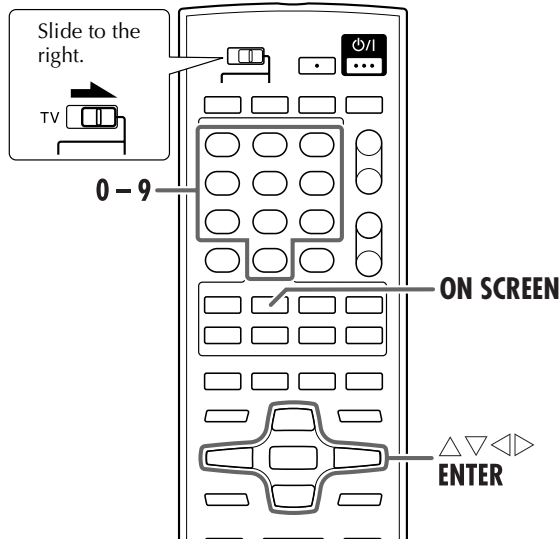

Basic Operation on the Menu Bar

1 Access the menu bar.

Press **ON SCREEN** twice. The menu bar appears on the TV screen.

- The currently selected item is highlighted.



2 Select the menu item.

Press $\triangleleft \triangleright$ to move \blacksquare to the item you want to work with, then press **ENTER**.

After pressing ENTER

- When a pull-down menu appears, press $\triangle \nabla$ to select the setting you want, then press **ENTER**.
- When a number-entry box appears, use the **number key** to enter the number you want, then press **ENTER**.
- When changing the indication of playback time, press **ENTER** repeatedly to select the setting you want.

For details about each function, see page 39.

How to Access the On-Screen Bar

1 Access the status bar.

Press **ON SCREEN** when a disc is loaded. The status bar appears on the TV screen.

Example: During DVD VIDEO playback

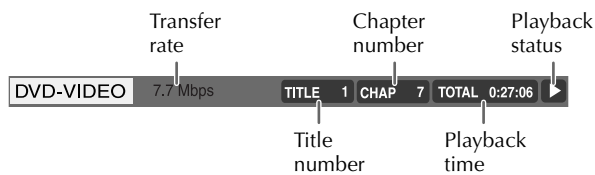

2 Access the menu bar.

Press **ON SCREEN** again. The menu bar appears under the status bar.



To clear the on-screen bar

Press **ON SCREEN**.

Menu Bar Functions for DVD VIDEO

■ Time mode selection

During playback, selects the time mode shown in the status bar and on the front display.

- **TOTAL:** Current title elapsed time
- **T.REM:** Current title remaining time
- **TIME:** Current chapter elapsed time
- **REM:** Current chapter remaining time

■ Repeat mode (See also page 33)

Selects the repeat mode during playback.

- **CHAPTER:** Current chapter repeat
- **TITLE:** Current title repeat
- **A-B:** A-B repeat
- **OFF:** Repeat mode deactivated

■ Time search (See also page 34)

Specifies a time from the beginning of the current title as the point from which to begin playback.

■ Chapter search

During playback, specifies a desired chapter to be played back from.

■ Audio selection (See also page 35)

During playback, selects the audio language or sound track.

■ Subtitle selection (See also page 34)

During playback, selects the subtitle language.

■ Angle selection (See also page 35)

During playback, selects a desired scene angle in a multi-angle part.

Menu Bar Functions for SVCD/Video CD/Audio CD

■ Time mode selection

Selects the time mode shown in the status bar and on the front display.

- **TIME:** Current track elapsed time
- **REM:** Current track remaining time (while in stop mode, current track total time)
- **TOTAL:** Disc elapsed time
- **T.REM:** Disc remaining time (while in stop mode, disc total time)

■ Repeat mode (See also page 33)

Selects the repeat mode.

- **TRACK:** Current track repeat
- **ALL:** All track repeat
- **A-B:** A-B repeat
- **OFF:** Repeat mode deactivated

■ Time search (See also page 34)

Specifies a time from the beginning of the disc as the point from which to begin playback.

■ Program playback (See also page 36)

While stopped, specifies the playback order of tracks.

■ Random playback (See also page 36)

While stopped, activates random playback.

■ Audio selection (See also page 35)

During Video CD/SVCD playback, selects the audio channel(s).

■ Subtitle selection (See also page 34)

During SVCD playback, selects the subtitle.

Audio/Video Files Playback

Outline

This unit can play back MP3 and JPEG files on a personally recorded on CD-R/RW and commercially available CD disc. This unit can also play back DivX files recorded on CD-R/RW and DVD-R/-RW disc. Some DVD-R and DVD-RW discs mastered as multi border (multi-session) may not be compatible with the unit.

- This unit may be unable to play back the disc due to the characteristics or recording conditions.

Precautions

About files and folders (groups) on the disc

- The unit recognizes up to the fifth layer of groups, 999 files per group, and up to 250 groups per disc. Files other than MP3/JPEG/DivX files count in the 999 total.
- Add the appropriate extension, such as "avi," "divx," "jpeg," and "mp3," to the file name.

For making your own disc:

- Use "UDF format" as the disc format for DVD-R/-RW.
- Use "ISO 9660" as the disc format for CD-R/RW.
- The unit does not support "packet writing" for CD-R/RW.
- The unit supports discs recorded with up to five multiple sessions.

For MP3 files:

MP3i and MP3 Pro are not available.

For JPEG files:

The unit cannot play back a picture of more than 5120 x 3413 pixels (baseline JPEG) or 2048 x 1536 pixels (progressive JPEG).

For DivX files:

- The unit supports DivX 5.x, 4.x and 3.11.
- The unit supports the DivX files whose resolution is 720 x 480 pixels or less (30 fps), and 720 x 576 pixels or less (25 fps).
- Audio stream should conform to MPEG 1 Audio Layer-2 or MPEG Audio Layer-3 (MP3).
- The unit does not support GMC (Global Motion Compression) and Q-Pel (Quarter Pixel).
- The file encoded in the interlaced scanning mode may not be played back correctly.
- The unit has its own Registration Code for DivX playback. If necessary, you can confirm the Registration Code of your player using the OTHERS menu screen. (☞ pg. 57)

Basic Operations

When you insert a disc with groups and files, the Control display that shows the contents of the disc automatically appears on the TV screen.

You can specify and play back the desired group/file from the Control display using the following procedure.

- Turn on the TV and select the video channel (or AV mode).
- Slide the **TV/VCR/DVD** switch on the remote control to the right.

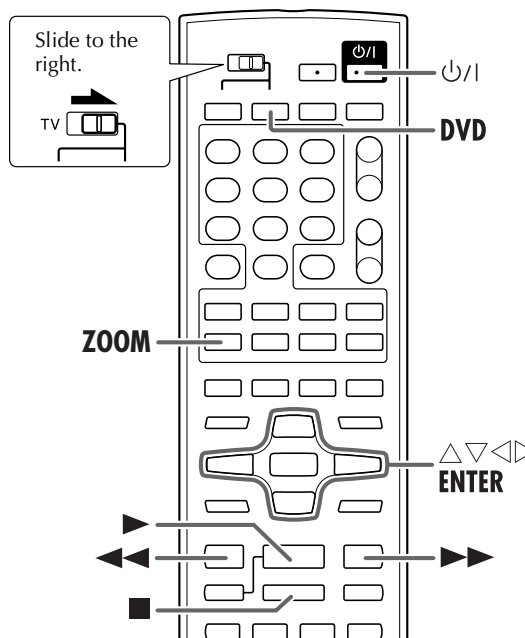
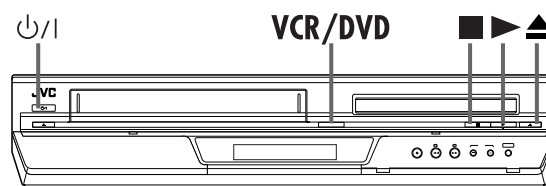

1 Turn on the unit.

Press **P/I**.

2 Select the DVD deck.

On the unit

Press **VCR/DVD** repeatedly so that the DVD indicator lights up.

On the remote control

Press **DVD** so that the DVD indicator lights up.

3 Load the disc.

- For details, refer to "Placing a Disc" (pg. 5).
- The Control display appears on the TV.

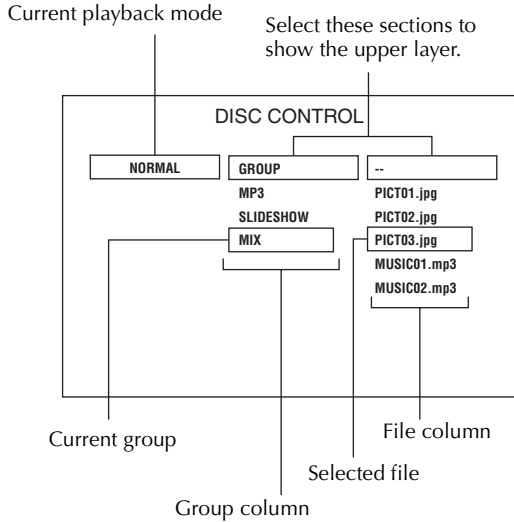

4 Select a group.

Press ◀▶ to select the desired group, then press ENTER.

5 Start playback.

Press △▽ to select the desired file, then press ENTER or ▶.

- When press ENTER, the unit play the selected file.
- When press ▶, the unit start continuous playback of the group from the selected file.

6 Stop playback.

Press ■. The Control display appears on the TV screen.

- Press ▲ on the DVD deck to open the disc tray, then remove the disc.

To reverse or advance DivX file playback rapidly

During playback of DivX file, press ◀◀ or ▶▶.

- Each time you press ◀◀ or ▶▶, the playback speed changes with the following indication on the TV screen:

◀◀ 1/▶▶ 1 → ◀◀ 2/▶▶ 2 → ◀◀ 3/▶▶ 3 → ◀◀ 4/▶▶ 4

The higher the value is, the faster the playback speed is.

Zooming

Press ZOOM during playback or while paused.

- Each time you press ZOOM, the magnification changes:
 - 2 times for DivX files
 - 1.5, 2 times, and 4 times for JPEG files (4 times magnification for JPEG file is possible only when its resolution is 640 x 480 pixels or more.)

Rotating/Reflecting a Still Picture

While a still picture is played back:

- Pressing ◀▶ rotates the picture by 90°.
- Pressing △ reflects the picture vertically.
- Pressing ▽ reflects the picture horizontally.

Repeat Playback

1 Change the playback mode.

Press ◀▶ to select the current playback mode on the Control display.

2 Select the repeat mode.

Press ENTER repeatedly to select the desired repeat mode.

REPEAT 1:	The current file is played back repeatedly.
REPEAT GROUP:	The all files in the current group are played back repeatedly.
REPEAT ALL:	All files on the disc is played back repeatedly.

3 Start Repeat Playback.

Press ◀▶ to move the cursor bar to the file column, then press ▶.

To cancel Repeat Playback, Select "NORMAL" in step 1 above.

Random Playback

1 Change the playback mode.

Press ◀▶ to select the current playback mode on the Control display.

2 Select the random playback mode.

Press ENTER repeatedly to select "RANDOM."

3 Start Random Playback.

Press ◀▶ to move the cursor bar to the file column, then press ▶.

- All files in the selected group are played back in random order.

To cancel Random Playback, Select "NORMAL" in step 1 above.

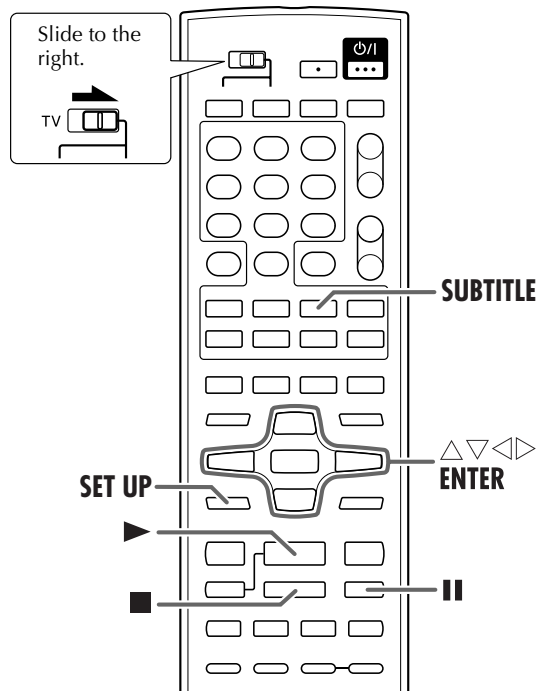

Slide Show Playback (JPEG Files)

You can display JPEG files (still pictures) one after another automatically.

Press ► while a JPEG file is selected on the Control display.

To keep showing the current picture
Press II

Changing the Picture of the Opening Display

You can change and set the opening display to your favorite image.

1 Play back a JPEG file of your favorite image.

2 Access the PICTURE menu screen.

Press SET UP, then press ◀▶ to show the PICTURE menu screen.

3 Select "BACKGROUND."

Press ▲▼ to select "BACKGROUND," then press ENTER.

4 Select "SAVE AS BACKGROUND."

Press ▲▼ to select "SAVE AS BACKGROUND," then press ENTER.

5 Register your image.

Press ▲▼ to select "YES," then press ENTER.
The player starts reading the JPEG file, and the opening screen is changed after reading the file.

To return to the normal screen
Press SET UP.

Programme Playback

1 Change the playback mode.

Press ◀▶ to select the current playback mode on the Control display.

2 Select the programme playback mode.

Press ENTER repeatedly to select "PROGRAM."

3 Select files.

Press ▲▼◀▶ to select the desired file, then press ENTER.

- Repeat step 3 until all the desired files are programmed.
- To erase the last programmed file, press ◀▶ to move the cursor bar to the programmed file column, then press ■.

4 Start Programme Playback.

Press ►.

To cancel Programme Playback,
Select "NORMAL" in step 2 above.

Playing Back DivX Files with Subtitle

1 Load a disc containing DivX files and associated subtitle files.

The Control display like the following appears on the TV screen.

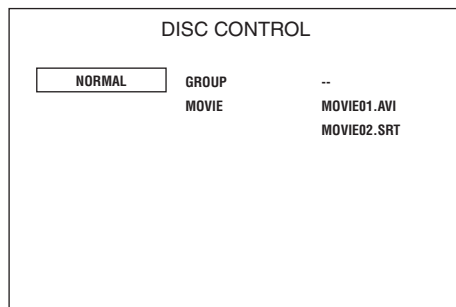

2 Select a subtitle file.

Press Δ / ∇ to select a subtitle file (having ".SRT" extension), then press **SUBTITLE**.

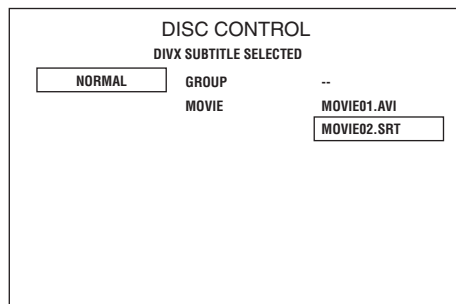

3 Select a DivX file.

Press Δ / ∇ to select a DivX file (.AVI) you want to play.

4 Start playback.

Press **ENTER** or **▶**.

The selected DivX file is played back with the associated subtitle.

NOTES:

- During playback, press **SUBTITLE** to select available fonts from the following:

LATIN 1, LATIN 2, CYRILLIC, SUBTITLE OFF

- LATIN 1 (ISO 8859-1) font supports the following languages: Danish, Dutch, English, Finnish, French, German, Italian, Norwegian, Spanish, Swedish
- LATIN 2 (ISO 8859-2) font supports the following languages: Czech, Hungarian, Polish
- CYRILLIC (ISO 8859-5) font supports the following language: Russian

Some other languages than above which are also supported by LATIN 1, LATIN 2, or CYRILLIC are not available on this unit.

- A DivX file and the associated subtitle file must be in the same folder.
- Only subtitles whose file extension is ".SRT" can be displayed.
- The subtitle may not be displayed if a font of the subtitle is not supported by the player.
- Once you stop playback, the subtitle is disabled. You need to select the subtitle file again to play back the DivX file with subtitle.
- During repeat playback, when playback returns to the beginning of the DivX file, subtitle is disabled.

Editing from a Camcorder

You can use a camcorder as the source player and your unit as the recording deck.

Slide the **TV/VCR/DVD** switch on the remote control to the right.

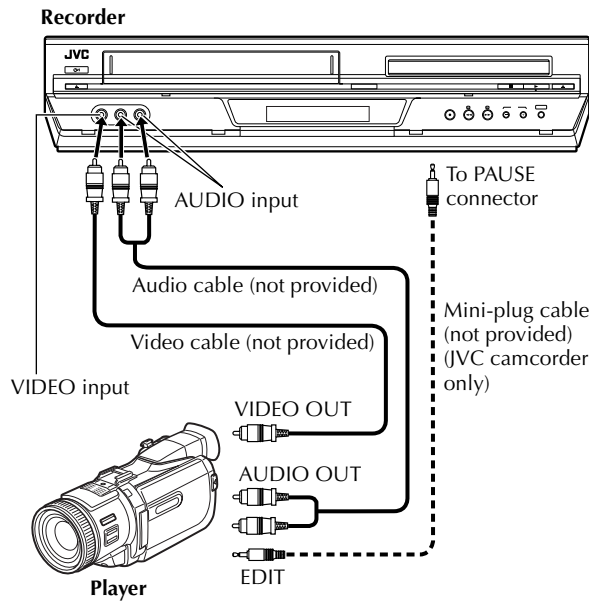

1 Make connections.

Connect the camcorder's AUDIO OUT and VIDEO OUT connectors to the unit's front panel AUDIO and VIDEO input connectors.

- When using a monaural camcorder, connect its AUDIO OUT connector to the AUDIO L input connector on your unit.
- When a Master Edit Control-equipped JVC camcorder is used, the camcorder is capable of controlling the unit. Refer to the camcorder's instruction manual for operating procedure.

2 Select the VHS deck.

On the unit

Press **VCR/DVD** repeatedly so that the VCR indicator lights up.

On the remote control

Press **VCR** so that the VCR indicator lights up.

3 Set the unit's input mode.

Press **AUX** (number key "0") and/or **PR** to select "F-1."

4 Set the edit mode.

See "PICTURE CONTROL" on page 53.

5 Engage the Record Pause mode.

Use **▶**, **◀◀**, or **▶▶** to locate the point where you start recording, then press and hold **||** and press **●** to engage the Record Pause mode.

6 Start the camcorder.

Engage the Play mode of the camcorder.

7 Start the unit.

Press **▶** to engage the Record mode of the unit.

NOTES:

- All necessary cables can be obtained from your dealer.
- When you select "EDIT" to dub tapes in step 4, be sure to select "AUTO" (or "NORM" when "B.E.S.T." is set to "OFF") after you finish dubbing the tapes.

Editing to or from Another Video Recorder

You can use your unit as the source player or as the recording deck.

1 When using your unit as the source player:

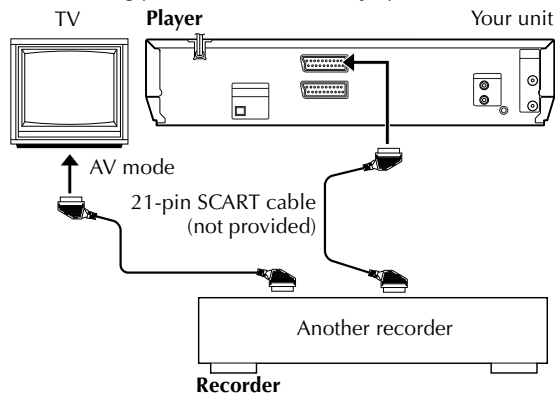

2 When using your unit as the recording deck:

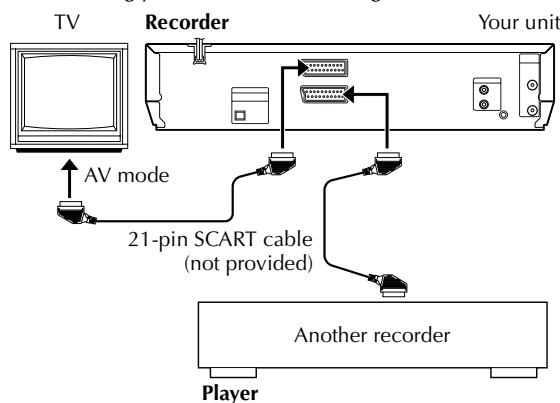

Slide the **TV/VCR/DVD** switch on the remote control to the right.

1 Make connections.

Connect the player's 21-pin SCART connector to the unit's 21-pin SCART connector as illustrated.

- 1 When using your unit as the source player:
 - connect its L-1 IN/OUT connector to the recording deck.
- 2 When using your unit as the recording deck:
 - connect its L-1 IN/OUT or L-2 IN/DECODER connector to the source player.

2 Select the VHS deck.

On the unit
Press **VCR/DVD** repeatedly so that the VCR indicator lights up.

On the remote control
Press **VCR** so that the VCR indicator lights up.

3 Set the input mode of recording deck.

With this unit, press **AUX** (number key "0") and/or **PR** to select "L-1" for the L-1 IN/OUT connector, or "L-2" for the L-2 IN/DECODER connector, depending on the connector being used.

- When using another recorder as the recording deck, refer to its instruction manual.
- When using the L-2 IN/DECODER connector, set "L-2 SELECT" to "AV". (ⓘ pg. 54)

4 Set the edit mode.

See "PICTURE CONTROL" on page 53.

5 Engage the Record Pause mode of the recording deck.

Locate the point where you start recording, then engage the Record Pause mode.

6 Start the source player.

Engage the Play mode of the source player.

7 Start the recording deck.

Engage the Record mode of the recording deck.

NOTES:

- All necessary cables can be obtained from your dealer.
- When you select "EDIT" to dub tapes in step 4, be sure to select "AUTO" (or "NORM" when "B.E.S.T." is set to "OFF") after you finish dubbing the tapes.
- When you use this unit as the source player for editing, be sure to set "O.S.D." to "OFF" before starting. (ⓘ pg. 53)

Dubbing (from DVD to VHS)

You can dub selected scenes from the DVD disc to a cassette, starting and stopping wherever you wish. However, it is not possible to dub copy-protected discs. In such case, "ERROR" appears on the front display panel.

- Turn on the TV and select the video channel (or AV mode).
- Slide the **TV/VCR/DVD** switch on the remote control to the right.

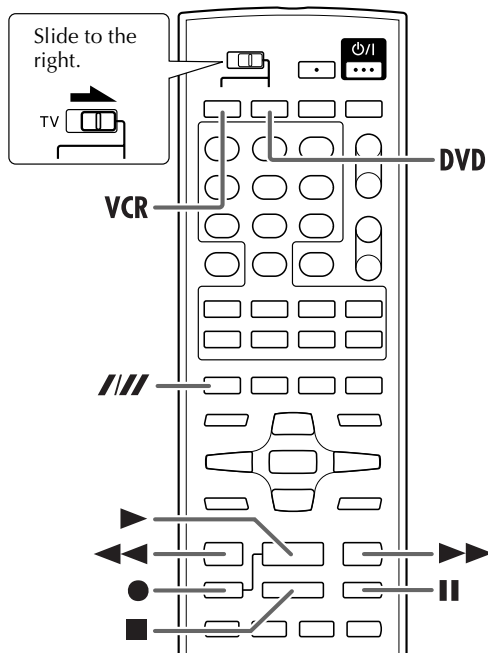

1 Load a cassette and place a disc.

For the VHS deck

Insert a cassette with the record safety tab intact.

For the DVD deck

- 1 Press **▲** on the DVD deck to open the disc tray.
- 2 Place the disc in the disc tray.
- 3 Press **▲** on the DVD deck to close the disc tray.

2 Prepare the VHS deck for dubbing.

- 1 Press **VCR**.
- 2 Press **///** to select recording speed.
- 3 Search for the point where you want to start dubbing by pressing **▶**, **▶▶** or **◀◀** then press **■**.

3 Prepare the DVD deck for dubbing.

- 1 Press **DVD**.
- 2 Start playback and search for the point where you want to start dubbing by pressing **▶**, **▶▶** or **◀◀**.

4 Start dubbing.

A little before the dubbing start point, press and hold **●**, then press **▶** on the remote control.

- "dub" lights on the front display panel.



5 End dubbing.

Press **■**.

- Be sure to press **■** while the VCR indicator lights up on the unit.
- If you press **■** or **▲** with the DVD deck selected, the dubbing stopped, but the opening screen is also recorded.
- When you have finished dubbing, press **DVD** to select the DVD deck and press **■** to stop playback.

NOTES:

- Set "ON SCREEN GUIDE" to "OFF" (pg. 57) if you do not want to record the on-screen display for DVD discs during dubbing.
- There may be a discrepancy of several seconds between where you intend editing to start, and where it actually starts.
- The superimposed indication during the operation or dubbing is not recorded.
- Set "PICTURE CONTROL" to "EDIT". (pg. 53)

Digital Audio Dubbing

- Turn on the TV and select the video channel (or AV mode).
- Slide the **TV/VCR/DVD** switch on the remote control to the right.

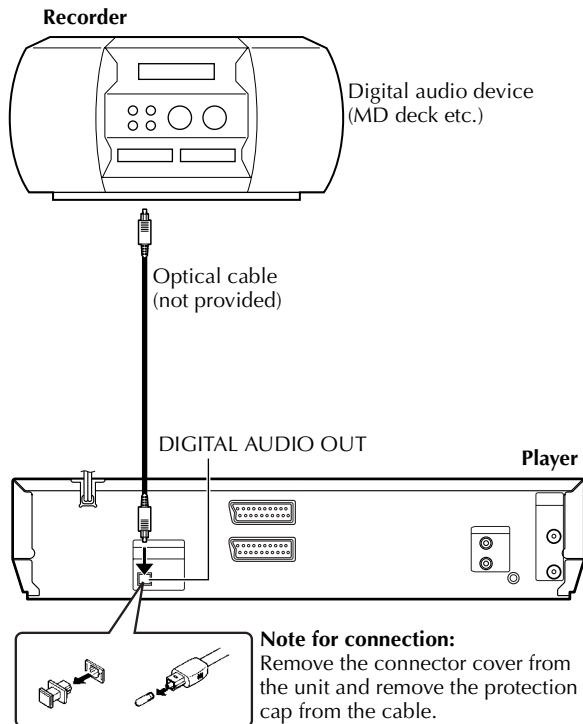

You can dub selected audio from the DVD or Audio CD disc to an MD etc.
However, it is not possible to dub copy-protected discs.

Example: Dubbing to an MD

1 Make connections.

Connect the optical cable between the unit and the digital audio device.

2 Place a disc and load an MD.

For the DVD deck

- 1 Press **▲** on the DVD deck to open the disc tray.
- 2 Place the disc in the disc tray.
- 3 Press **▲** on the DVD deck to close the disc tray.

For the digital audio device

Insert an MD.

3 Prepare the DVD deck for dubbing.

- 1 Press **DVD** and select the audio to be dubbed.
- 2 Search for the point where you want to start dubbing by pressing **▶**, **▶▶** or **◀◀** then press **■**.
- 3 Press **◀◀** a little, then press **▶** to start playback.
- 4 Press **||** to pause playback a little before the start point.

4 Prepare the audio device for dubbing.

Select the input mode.

5 Start dubbing.

- 1 Press **▶** to start playback on the DVD deck.
- 2 Start recording on the audio device.

6 End dubbing.

Stop recording on the audio device. Then press **■** to stop playback on the DVD deck.

NOTES:

- There may be a discrepancy of several seconds between where you intend editing to start, and where it actually starts.
- You can also dub audio from a Video CD or SVCD. Set "DIGITAL AUDIO OUTPUT" to "PCM ONLY". (ⓘ pg. 56)

Remote Control Functions

Remote A/B/C/D Code Switching

The remote control is capable of controlling four JVC video units independently. Each of the units can respond to one of four codes (A, B, C or D). The remote control is preset to send A code signals because your unit is initially set to respond to A code signals. You can easily modify your unit to respond to B, C or D code signals.

Before performing the following steps:

Slide the TV/VCR/DVD switch on the remote control to the right.

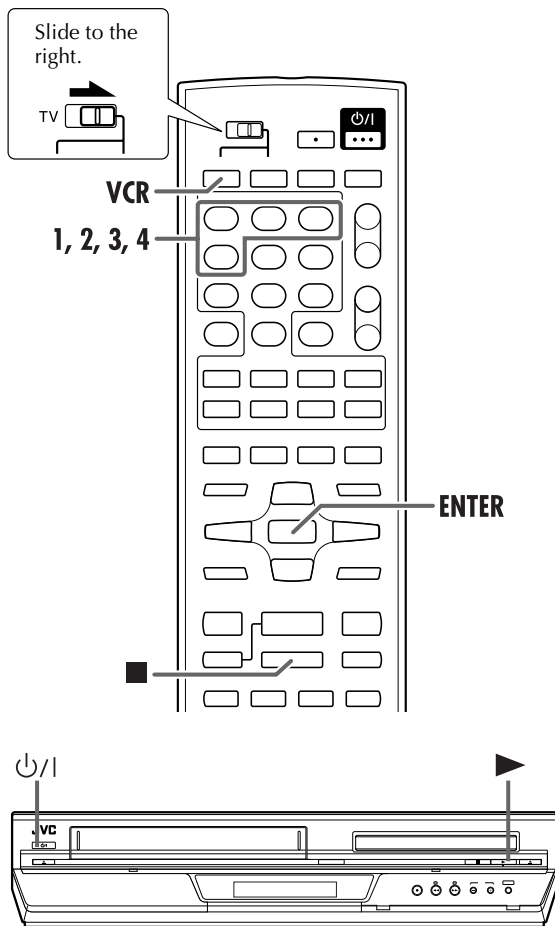

On the remote control

Keep pressing VCR down during steps 1 – 2.

1 Change the remote control code.

Press the number key “1” for A, “2” for B, “3” for C, or “4” for D.

2 Set the remote control code.

Press ENTER to set the code.

On the unit

3 Turn off the unit.

Press \odot /I.

4 Display the code.

Press \blacktriangleright on the unit for over 5 seconds while the unit is turned off. The code currently set appears on the front display panel.

- If the code displayed on the front display panel is different from the code set on the remote control, go to step 5.

5 Change the unit's code.

Press \blacksquare on the remote control. The code currently set on the remote control will be applied to the unit.

NOTE:

When “POWER SAVE” is set to “ON” (pg. 54), it is impossible to change the remote code.

TV Multi-Brand Remote Control

Your remote control can operate the basic functions of your TV set. In addition to JVC TVs, other manufacturer's TVs can also be controlled.

Before performing the following steps:

- Turn off the TV using its remote control.
- Slide the TV/VCR/DVD switch on the remote control to the left.

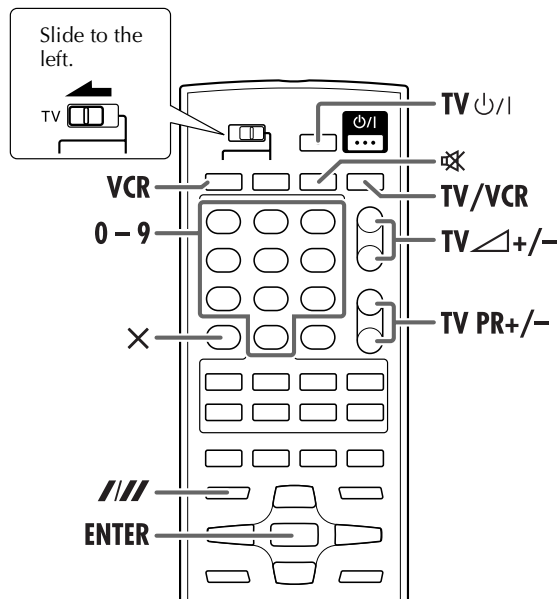

IMPORTANT

Although the provided remote control unit is compatible with JVC televisions, as well as many other models, it may not work with your TV, or in some instances, may have limited function capability.

Control Your TV Using Additional Buttons

Use the **number keys**, and the **///** button or X button to select the TV's channel.

- With televisions under Code 01, 02, 07, 10, 11, 14, 20, 23, 24, 25, 27, 33 or 35, the **///** button corresponds to the 1-digit/2-digit entry switching button (often labelled -/-) of your TV's remote control.
- With televisions under Code 01, 28, 29 or 34, the X button corresponds to the 10 + button of your TV's remote control.

NOTE:

The way these buttons are used is determined by your TV. Use these buttons as instructed for your TV's remote control.

1 Set the TV brand code.

Keep pressing **VCR** down during step **1**. Enter your TV's brand code using the **number keys**, then press **ENTER**.

Press **TV** \uparrow/\downarrow on the unit's remote control to turn on the TV and try operations (see step **2**).

- Once you have set the remote control to operate the TV, you do not have to repeat this step until you replace your remote control's batteries.
- Some brands of TVs have more than one code. If the TV does not function with one code, try entering another.

2 Operate the TV.

Press the corresponding button: **TV** \uparrow/\downarrow , **TV/VCR**, **TV** \triangle +/- (Volume), **TV PR** +/-, \otimes (TV Muting), **number keys**.

- For some brands of TVs, you must press **ENTER** after having pressed the **number keys**.

Brand name	Code
JVC	01, 23, 24, 25
BLAUPUNKT	19
BRANDT	26
FERGUSON	27
FINLUX	30
FUNAI	32
LG/GOLDSTAR	18
GRAETZ	28
GRUNDIG	19
HITACHI	10
ITT	28
LUXOR	28
MITSUBISHI	03
MIVAR	29
NEC	20
NOKIA	31
NORDMENDE	26
PANASONIC	11
PHILIPS	02
SABA	26
SALORA	28
SAMSUNG	02, 12, 33, 34, 35
SELECO	28
SHARP	06
SONY	07
TELEAVIA	26
TELEFUNKEN	26
THOMSON	26
TOSHIBA	14

Connecting to a Satellite Receiver

Simple Connections

This is an example of a simple connection if your TV has one 21-pin AV input (SCART) connector.

Connect the satellite receiver to the L-2 IN/DECODER connector, then connect the L-1 IN/OUT connector to the TV's connector.

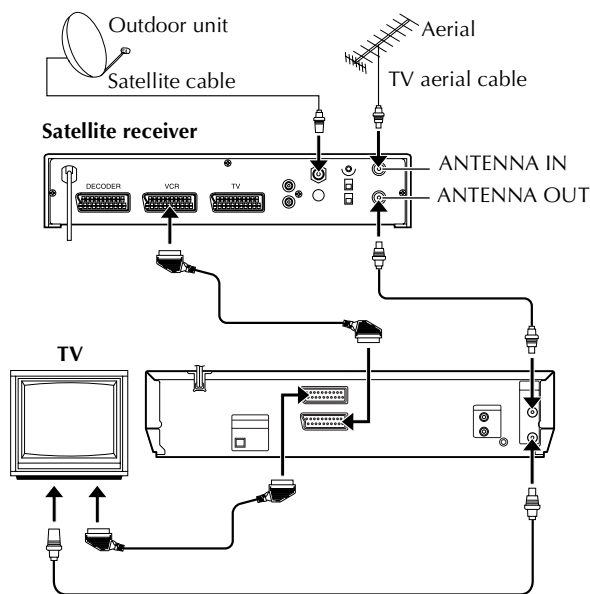

IMPORTANT

When you set "L-2 SELECT" to "SAT" (pg. 54), it is possible to view a satellite broadcast with the TV set to its AV mode even if the unit is turned off. When the unit is in Stop mode or recording, press **TV/VCR** on the remote control to turn off the VCR indicator on the front display panel.

- If you turn on the unit when the satellite receiver's power is off, nothing appears on the TV screen. In this case, turn on the satellite receiver, or set the TV to its TV mode, or press **TV/VCR** on the remote control to set the unit to the video mode.

NOTES:

- Set "L-2 SELECT" to "A/V". (pg. 54)
- You can use the Automatic Satellite Programme Recording function (pg. 28) with this connection. (VHS deck only)
- To record a programme via the satellite receiver, select L-2 mode by pressing **AUX (number key "0")** and/or **PR** so that "L-2" appears on the front display panel. (VHS deck only)
- For details, refer to the instruction manual of the satellite receiver.

Perfect Connections

This is an example of recommended connections if your TV has two 21-pin AV input (SCART) connectors.

Connect the decoder to the satellite receiver's connector if you have a decoder, L-1 IN/OUT connector to TV's connector, and L-2 IN/DECODER connector to the satellite receiver's connector. Then connect the satellite receiver and TV.

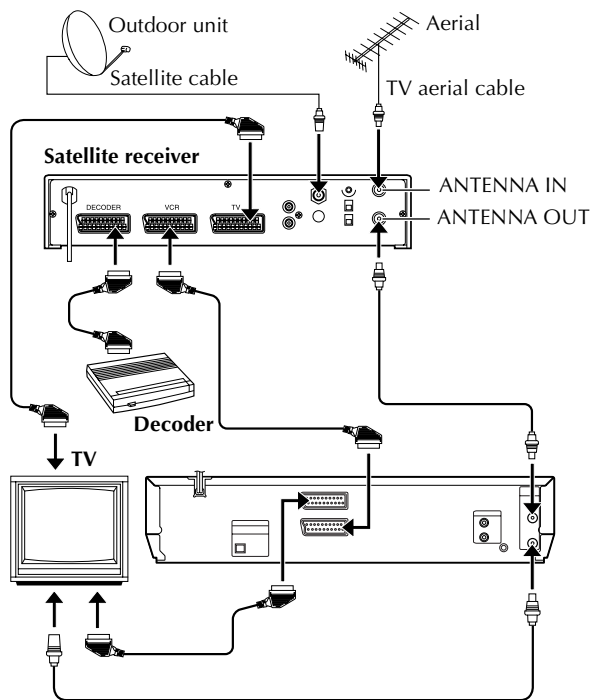

NOTES:

- Set "L-2 SELECT" to "A/V". (pg. 54)
- You can use the Automatic Satellite Programme Recording function (pg. 28) with this connection. (VHS deck only)
- To record a programme via the satellite receiver, select L-2 mode by pressing **AUX (number key "0")** and/or **PR** so that "L-2" appears on the front display panel. (VHS deck only)
- To receive a scrambled broadcast, descramble the signal with the decoder connected to the satellite receiver.
- For details, refer to the instruction manual of the satellite receiver and decoder.

Connecting/Using a Decoder

The L-2 IN/DECODER connector can be used as an input connector for an external decoder (descrambler). Simply connect a decoder and you can enjoy the variety of programming that is available through scrambled channels.

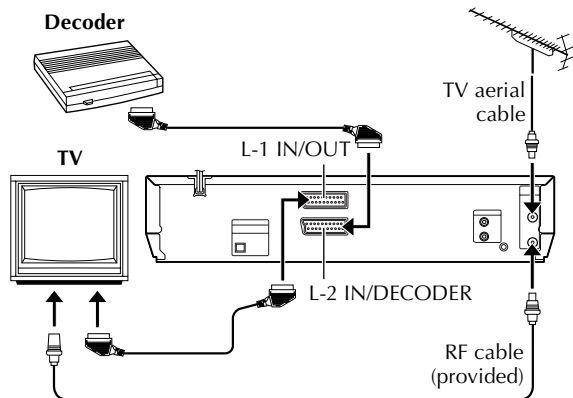

1 Select the input mode.

Set "L-2 SELECT" to "DECODER". (☞ pg. 54)

2 Connect the decoder.

Connect your unit's L-2 IN/DECODER connector to the decoder's 21-pin SCART connector using a 21-pin SCART cable.

3 Set the tuner.

Perform the procedure as described in "When Receiving a Scrambled Broadcast" on page 61.

Connecting to a Dolby Digital Decoder or an Amplifier with a Built-In DTS (DVD deck only)

These instructions enable you to connect your unit to a Dolby Digital Decoder or an amplifier with built-in DTS.

Make connections.

Connect the optical cable between the unit and the Dolby Digital Decoder or amplifier with a built-in DTS.

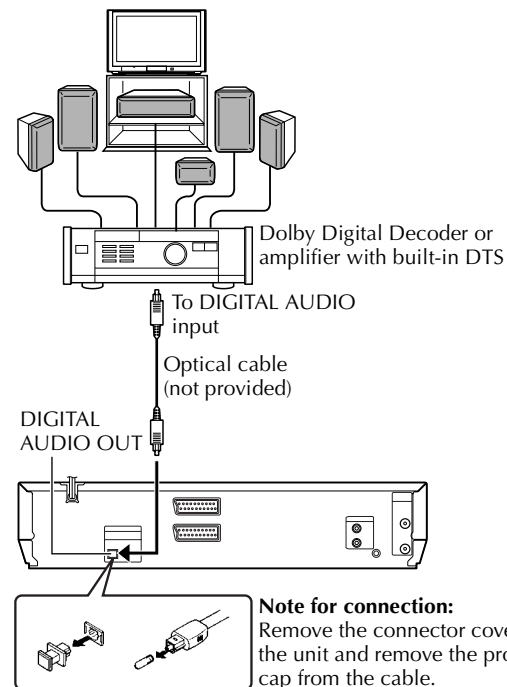

NOTES:

- For Dolby Digital sound, set "DIGITAL AUDIO OUTPUT" to "DOLBY DIGITAL/PCM". (☞ pg. 56)
- For DTS sound, set "DIGITAL AUDIO OUTPUT" to "STREAM/PCM". (☞ pg. 56)

CAUTIONS:

- This unit has a dynamic range of more than 80 dB with regards to its Hi-Fi audio capability. It is recommended that you check the maximum level if you are going to listen to the Hi-Fi audio signals through a stereo amplifier. A sudden surge in the input level to the speakers may damage them.
- Some speakers and televisions are specially shielded to prevent television interference. If both are of the non-shielded type, do not place the speakers adjacent to the TV set as this can adversely affect the video playback picture.

Mode Set (VHS deck)

You can change various mode settings on the Mode Set screen by following the procedure described below.

- For each mode setting, see pages 53 to 54.

- Turn on the TV and select the video channel (or AV mode).
- Slide the **TV/VCR/DVD** switch on the remote control to the right.

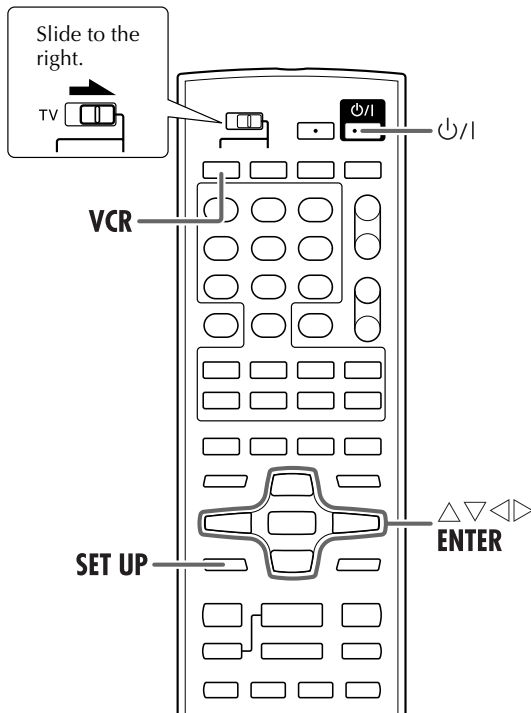

1 Turn on the unit.

Press **⏻/I**.

2 Select the VHS deck.

On the unit

Press **VCR/DVD** repeatedly so that the VCR indicator lights up.

On the remote control

Press **VCR** so that the VCR indicator lights up.

3 Access the Main Menu screen.

Press **SET UP**.

4 Access the Mode Set screen.

Press **▲▼** to move the highlight bar (pointer) to "MODE SET," then press **ENTER** or **▷**.

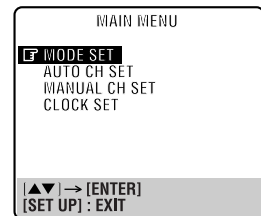

5 Select the mode.

Press **▲▼** to move the highlight bar (pointer) to the item you want to change.

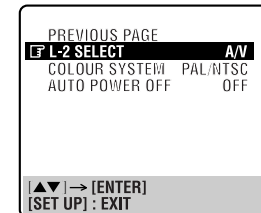
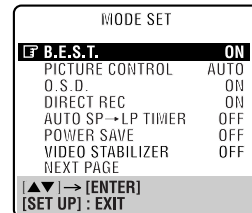

6 Select the mode setting.

Press **ENTER** or **▷**.

7 Return to the normal screen.

Press **SET UP**.

* The default setting is **bold** in the table below.

■ **B.E.S.T. — ON / OFF**

You can set the B.E.S.T. (Biconditional Equalised Signal Tracking) system to "ON" or "OFF". (☞ pg. 23)

NOTES:

- When watching a tape recorded with "B.E.S.T." set to "ON", it is recommended that you leave B.E.S.T. on during playback as well.
- When watching a rental tape or one recorded on another video recorder, or when using this unit as the player for editing, set B.E.S.T. to your preference.
- The B.E.S.T. system works for both SP and LP modes only after a tape has been inserted and the Record mode is first initiated. It does not work during recording.
- The B.E.S.T. system does not work while Automatic Satellite Programme Recording is in progress. (☞ pg. 28)
- In the case of timer recordings, the B.E.S.T. system works before recording is initiated.
- Once the cassette is ejected, the B.E.S.T. data is cancelled. The next time the cassette is used for recording, B.E.S.T. is re-performed.
- Pressing the unit's ● button while "BEST" is displayed does not start Instant Timer Recording. (☞ pg. 22)

■ **PICTURE CONTROL— AUTO / EDIT / SOFT**

This feature helps you to adjust the playback picture quality according to your preference. Normally select "AUTO."

AUTO: Provides the optimised picture benefits of the B.E.S.T. Picture System.

EDIT: Minimizes picture degradation during editing (recording and playback).

SOFT: Reduces image coarseness when viewing overplayed tapes containing a lot of noise.

NOTES:

- When you select "EDIT" or "SOFT," the selected mode will not change until you select another mode.
- When you select "EDIT" to dub tapes, be sure to select "AUTO" after you finish dubbing the tapes.
- When "B.E.S.T." is "OFF", "PICTURE CONTROL" switches automatically from "AUTO" to "NORM."

■ **O.S.D. — ON / OFF**

When this function is set to "ON," various operational indicators appear on the TV screen. Messages appear in the selected language. (☞ pg. 10, 15)

NOTES:

- When you use this unit as the source player for editing, be sure to set "O.S.D." to "OFF" before starting.
- During playback, the operation mode indicators may be disturbed depending on the type of tape being used.

■ **DIRECT REC — ON / OFF**

When this function is set to "ON," you can easily start recording the programme that you are watching on your TV. Press and hold ● and press ► on the remote control, or press ● on the unit.

NOTES:

- When you use the Direct Rec function, be sure to use a TV offering T-V LINK, etc. and connect a fully-wired 21-pin SCART cable between the unit and the TV. (☞ pg. 9)
- If "DIRECT REC" is set to "OFF", the ● button functions as described in "Basic Recording" (☞ pg. 21).
- During Direct Rec, "—" appears on the front display panel.
- When "DIRECT REC" is set to "ON", if you press any button just after pressing ● on the unit (or ● and ► on the remote control), the unit may not function properly.

■ **AUTO SP→LP TIMER — ON / OFF**

When this function is set to "ON", the unit automatically switches to LP mode to allow complete recording if there is not enough tape to record the entire programme while timer-recording in SP mode.

For Example:

Recording a programme of 210 minutes in length onto a 180-minute tape

Approximately 150 minutes	Approximately 60 minutes
SP mode	LP mode
Total 210 minutes	

Make sure you set this function to "ON," before the timer-recording starts.

NOTES:

- If you have programmed the unit to timer-record 2 or more programmes, the second programme and those thereafter may not fit on the tape if you set "AUTO SP→LP TIMER" to "ON." In this case, make sure the mode is not engaged, then set the tape speed manually during timer programming.
- In order to ensure that the recording fits on the tape, this feature may leave a slight non-recorded section at the end of the tape.
- There may be some noise and sound disturbance at the point on the tape where the unit switches from SP to LP mode.
- The Auto SP→LP Timer feature is not available during ITR (Instant Timer Recording), and the feature will not work properly with any tapes longer than E-180, or with some tapes of shorter lengths.
- If you perform timer recording with both VPS/PDC and the Auto SP→LP Timer activated, and the programme goes beyond its originally scheduled length, there may be times when the programme cannot be recorded in its entirety.

■ POWER SAVE — ON / OFF

When this function is set to "ON," you can reduce the power consumption while the unit is turned off.

NOTES:

- During Power Save mode:
 - the front display panel will be turned off.
 - the Just Clock function (☞ pg. 65) does not work.
 - the picture may be distorted momentarily when you turn on/off the unit.
- Power Save does not work when:
 - the unit is in the timer mode.
 - the unit's power is turned off after timer-recording or Instant Timer Recording.
 - the Automatic Satellite Programme Recording mode is engaged. (☞ pg. 28)
 - "L-2 SELECT" is set to "DECODER" or "SAT". (☞ pg. 54)

■ VIDEO STABILIZER — ON / OFF

When this function is set to "ON," you can automatically correct vertical vibration in the picture when playing back unstable recordings made on another recorder.

NOTES:

- When you finish viewing a tape, be sure to set this function to "OFF."
- Regardless of the setting, this function has no effect during recording and during special effects playback.
- The on-screen display may jitter vertically when this function is set to "ON."
- To watch recordings with close-caption, set this function to "OFF."

■ L-2 SELECT — A/V / DECODER / SAT

Set "L-2 SELECT" to the appropriate mode depending on the type of appliance connected to the unit's L-2 IN/DECODER connector.

A/V: To use this unit as the recording deck with the player connected to the L-2 IN/DECODER connector, or to use the satellite receiver connected to the L-2 IN/DECODER connector.

DECODER: To use a decoder connected to the L-2 IN/DECODER connector.

SAT: To view a satellite programme with the TV set while the unit is turned off. (☞ pg. 50)

NOTES:

- If you have a satellite receiver or a decoder connected to the L-2 IN/DECODER connector, be sure to set "L-2 SELECT" back to the appropriate mode after editing.
- If you are not connecting a satellite receiver or a decoder to the L-2 IN/DECODER connector, leave "L-2 SELECT" set to "A/V."
- When "L-2 SELECT" is set to "SAT," "SAT" appears on the TV screen or front display panel instead of "L-2."

■ COLOUR SYSTEM — PAL/NTSC / MESECAM

You can play back PAL, NTSC and MESECAM tapes, or record PAL and SECAM* signals on this unit. Select the appropriate colour system.

* *SECAM signals will be recorded as MESECAM on this unit; MESECAM is the designation for tapes with SECAM signals that have been recorded on a MESECAM-compatible PAL video cassette recorder.*

PAL/NTSC: To record PAL signals, or play back a PAL or NTSC tape.

MESECAM: To record SECAM signals, or play back a MESECAM tape.

NOTES:**About NTSC Playback**

- Some TVs shrink the picture vertically and place black bars at the top and bottom of the TV screen. This is not a malfunction on the part of either the unit or the TV.
- The picture may roll up and down. This can be corrected using the V-HOLD control found on some TVs. (This cannot be corrected if the TV does not have a V-HOLD control.)
- The counter and tape remaining time readings will be incorrect.
- During search, still, or frame-by-frame playback, the picture will be distorted, and there may be a loss of colour.
- Depending on the type of TV, the top and bottom portions of superimposed displays may be cut off during NTSC playback.

■ AUTO POWER OFF — 3H / OFF

When this function is set to "3H," the unit is turned off automatically if no operation is done within 3 hours. "AUTO POWER OFF IN 3 MIN" appears on the screen 3 minutes before the unit is turned off.

Mode Set (DVD deck)

You can change various mode settings on the Mode Set screen by following the procedure described below.

- For each mode setting, see corresponding pages.

LANGUAGE	MENU LANGUAGE (pg. 16) AUDIO LANGUAGE (pg. 16) SUBTITLE (pg. 16) ON SCREEN LANGUAGE (pg. 16)
PICTURE	MONITOR TYPE (pg. 14) PICTURE SOURCE (pg. 56) SCREEN SAVER (pg. 56) BACKGROUND (pg. 56)
AUDIO	DIGITAL AUDIO OUTPUT (pg. 56) ANALOG DOWN MIX (pg. 56) D. RANGE CONTROL (pg. 56) OUTPUT LEVEL (pg. 56)
OTHERS	RESUME (pg. 57) ON SCREEN GUIDE (pg. 57) DivX REGISTRATION (pg. 57) PARENTAL LOCK (pg. 57)

- Turn on the TV and select the video channel (or AV mode).
- Slide the TV/VCR/DVD switch on the remote control to the right.

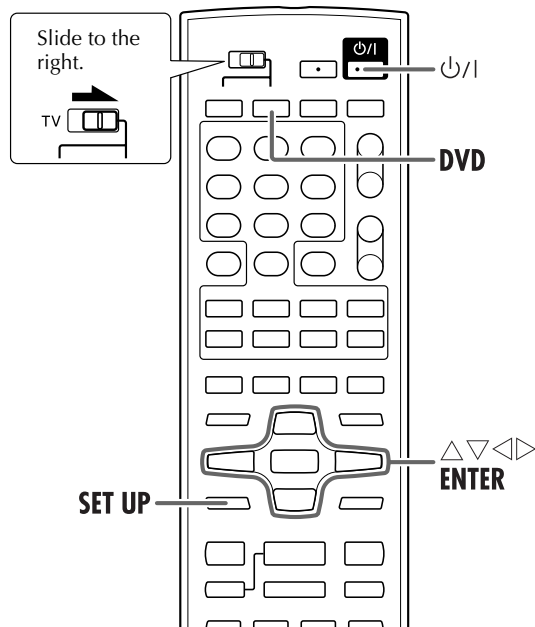

- The procedure shows how to set "RESUME" to "ON" on the DVD Set Up menu screen as an example.

1 Turn on the unit.

Press P/I.

2 Select the DVD deck.

On the unit

Press VCR/DVD repeatedly so that the DVD indicator lights up.

On the remote control

Press DVD so that the DVD indicator lights up.

3 Access the DVD Set Up menu screen.

1 Press SET UP.

2 Press < > to select "OTHERS."

- Each time you press the button, the setup menus change as follows;

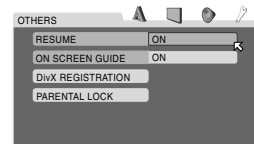

LANGUAGE → PICTURE → AUDIO → OTHERS
→ (Back to the beginning)

4 Select the mode.

Press Δ ∇ to move to "RESUME," then press ENTER.

5 Select the mode setting.

Press Δ ∇ to select "ON," then press ENTER.

6 Return to the normal screen.

Press SET UP.

* The default setting is **bold** in the table below.

Picture Settings

■ **MONITOR TYPE** —

16:9 / 4:3 LB / 4:3 PS

You can select the monitor type depending on the TV used when you play back DVD VIDEO discs recorded for wide-screen TVs. For more details, refer to "Monitor Set (DVD deck)" (pg. 14).

■ **PICTURE SOURCE** —

VIDEO (NORMAL) / VIDEO (ACTIVE) / FILM / **AUTO**

You can obtain optimal picture quality by selecting whether the content on the disc is processed by field (video source) or by frame (film source).

Normally set to "AUTO."

VIDEO (NORMAL): Suitable for playing back a video source disc with relatively a few movements.

VIDEO (ACTIVE): Suitable for playing back a video source disc with relatively a lot of movements.

FILM: Suitable for playing back a film or progressive source disc.

AUTO: Used to play back a disc containing both video and film source materials. This unit recognizes the picture type (film or video source) of the current disc according to the disc information.

- If the playback picture is unclear or noisy, or the oblique lines of the picture are rough, try to change to other modes.

■ **SCREEN SAVER** — ON / OFF

The TV screen may be burned out if a static picture is displayed for a long time. When this function is set to "ON," the unit automatically activates the screen saver function if a static picture, such as an on-screen display or menu is displayed for over 5 minutes.

NOTE:

This function is not available for Audio files playback.

■ **BACKGROUND** —

STANDARD / USER / SAVE AS BACKGROUND

You can use your favorite image as the opening display.

STANDARD: Select this to display the JVC original image.

USER: Select this to display your favorite image when a JPEG image is registered.

SAVE AS BACKGROUND: To register a new image, select this while a JPEG image is displayed on the TV screen.

Audio Settings

■ **DIGITAL AUDIO OUTPUT** —

PCM ONLY / DOLBY DIGITAL/PCM / **STREAM/PCM**

Set to the appropriate mode according to the type of the device connected to DIGITAL AUDIO OUT connector on the rear of unit.

It is not necessary to set this mode when you connect no device to the DIGITAL AUDIO OUT connector.

PCM ONLY: Select this when you connect the unit's DIGITAL AUDIO OUT connector to the linear PCM digital input connector of another audio device.

DOLBY DIGITAL/PCM: Select this when you connect the unit's DIGITAL AUDIO OUT connector to the digital input connector of a Dolby Digital decoder or an amplifier with a built-in Dolby Digital decoder.

STREAM/PCM: Select this when you connect the unit's DIGITAL AUDIO OUT connector to the digital input connector of an amplifier with a built-in DTS, Dolby Digital, or MPEG multichannel decoder.

■ **ANALOG DOWN MIX** — DOLBY SURROUND / **STEREO**

Set to the appropriate mode according to your audio system when you play back a DVD VIDEO disc recorded with surround multichannel audio. This setting affects only the analogue audio output signal from the AUDIO OUT connectors when playing back a DVD VIDEO disc recorded with surround multichannel audio.

DOLBY SURROUND: Select this when you enjoy multichannel surround audio by connecting the unit's analogue AUDIO OUTPUT connectors (DVD) to a surround decoder.

STEREO: Select this when you enjoy conventional 2-channel stereo audio by connecting the unit's analogue AUDIO OUTPUT connectors (DVD) to a stereo amplifier/receiver or TV, or when you dub audio of a DVD VIDEO disc recorded with surround audio to your MD, cassette, etc.

■ **D. RANGE CONTROL** —

WIDE RANGE / **NORMAL** / TV MODE

The dynamic range (the difference between the loudest sound and the quietest one) can be compressed during playback of a programme encoded in Dolby Digital format.

This function takes effect when a DVD VIDEO disc recorded in Dolby Digital format is played back at low or middle volume.

WIDE RANGE: Select this to inactivate this function when you enjoy wide dynamic range programme.

NORMAL: Normally select this setting to activate this function.

TV MODE: Select this when you hear the sound through the TV's speaker(s).

■ **OUTPUT LEVEL** — **STANDARD** / LOW

You can lower the output level of analog audio to accommodate the unit to the connected A/V equipment.

STANDARD: Normally select this.

LOW: Select this if the sound output from the speaker is distorted. The output level of analog audio is lowered.

Playback discs	Output		
	STREAM/PCM	DOLBY DIGITAL/PCM	PCM ONLY
DVD VIDEO with 48 kHz, 16/20/24 bit linear PCM	48 kHz, 16 bit linear PCM		
DVD VIDEO with DTS	DTS bitstream	48 kHz, 24 bit stereo linear PCM	
DVD VIDEO with Dolby Digital	Dolby Digital bitstream		48 kHz, 24 bit stereo linear PCM
Video CD/SVCD/Audio CD	44.1 kHz, 16 bit stereo linear PCM		
Audio CD with DTS	DTS bitstream	44.1 kHz, 24 bit stereo linear PCM	
CD-R/RW recorded MP3, CD-R/RW or DVD-R/RW recorded DivX	Linear PCM		

NOTES:

- The unit is not equipped with the DTS decoding function.
- When you play back a DVD VIDEO or Audio CD disc with DTS, use a DTS decoder to get correct signals from your speakers. Never use the unit's analog output connectors, which output incorrect signals that may damage your speakers.
- If you connect the analog outputs and digital outputs simultaneously, be sure to select the source of the amplifier correctly, or set the level control of the amplifier connected to the analog outputs to minimum.

Others Settings

■ **RESUME — ON / OFF / DISC RESUME**

You can select the resume playback mode.

ON: The unit resumes playback from the position where playback has been stopped if the disc is still in the disc tray.

OFF: This function is deactivated.

DISC RESUME: The unit resumes playback of the last 30 discs played. The unit retains a memory of the stopped position of each disc even if the disc is removed from the disc tray.

NOTE:

This function is not available for Audio CD discs and Audio/Video files playback.

■ **ON SCREEN GUIDE — ON / OFF**

When this function is set to "ON," the unit can display "on-screen guide" icons or characters which show the conditions of the unit or disc.

■ **DivX REGISTRATION**

The unit has its own Registration Code for DivX playback. You can confirm the code of your unit.

NOTE:

Once you played back a disc created by using the Registration Code, the unit's code is overwritten by a totally different new one for copyright protection purpose.

■ **PARENTAL LOCK**

Select this, then press **ENTER** to show the PARENTAL LOCK menu screen for limiting playback by children.

Parental Lock

This function restricts playback of DVD VIDEO discs which contains violent (and other) scenes according to the level set by the user. Scenes which are limited by this function are not played or replaced with other scenes.

■ **COUNTRY CODE**

Select the code of your country/area. (☞ pg. 58)

■ **SET LEVEL**

Select the level of restriction. ("1" is the strictest.)

■ **PASSWORD**

Enter your password by pressing the **number keys**(0-9).

■ **EXIT**

Select this, then press **ENTER** to go back to the OTHERS menu screen.

NOTES:

- Some DVD VIDEO discs cannot be played by this function. If you try to play such a disc, the PARENTAL LOCK menu screen appears on the TV screen and asks whether you want to release the lock or not. To release the lock and play, select "TEMPORARY RELEASE," press ENTER, then enter your password. Otherwise, eject the disc.
- To change the setting of the limitation, you need to enter your password.
- If you forget your pass word, enter "8888."

Country/Area Code List for Parental Lock

AD	Andorra	ES	Spain	LC	Saint Lucia	SA	Saudi Arabia
AE	United Arab Emirates	ET	Ethiopia	LI	Liechtenstein	SB	Solomon Islands
AF	Afghanistan	FI	Finland	LK	Sri Lanka	SC	Seychelles
AG	Antigua and Barbuda	FJ	Fiji	LR	Liberia	SD	Sudan
AI	Anguilla	FK	Falkland Islands (Malvinas)	LS	Lesotho	SE	Sweden
AL	Albania	FM	Micronesia (Federated States of)	LT	Lithuania	SG	Singapore
AM	Armenia	FO	Faroe Islands	LU	Luxembourg	SH	Saint Helena
AN	Netherlands Antilles	FR	France	LV	Latvia	SI	Slovenia
AO	Angola	FX	France, Metropolitan	LY	Libyan Arab Jamahiriya	SJ	Svalbard and Jan Mayen
AQ	Antarctica	GA	Gabon	MA	Morocco	SK	Slovakia
AR	Argentina	GB	United Kingdom	MC	Monaco	SL	Sierra Leone
AS	American Samoa	GD	Grenada	MD	Moldova, Republic of	SM	San Marino
AT	Austria	GE	Georgia	MG	Madagascar	SN	Senegal
AU	Australia	GF	French Guiana	MH	Marshall Islands	SO	Somalia
AW	Aruba	GH	Ghana	ML	Mali	SR	Suriname
AZ	Azerbaijan	GI	Gibraltar	MM	Myanmar	ST	Sao Tome and Principe
BA	Bosnia and Herzegovina	GL	Greenland	MN	Mongolia	SV	El Salvador
BB	Barbados	GM	Gambia	MO	Macao	SY	Syrian Arab Republic
BD	Bangladesh	GN	Guinea	MP	Northern Mariana Islands	SZ	Swaziland
BE	Belgium	GP	Guadeloupe	MQ	Martinique	TC	Turks and Caicos Islands
BF	Burkina Faso	GQ	Equatorial Guinea	MR	Mauritania	TD	Chad
BG	Bulgaria	GR	Greece	MS	Montserrat	TF	French Southern Territories
BH	Bahrain	GS	South Georgia and the South Sandwich Islands	MT	Malta	TG	Togo
BI	Burundi	GT	Guatemala	MU	Mauritius	TH	Thailand
BJ	Benin	GU	Guam	MV	Maldives	TJ	Tajikistan
BM	Bermuda	GW	Guinea-Bissau	MW	Malawi	TK	Tokelau
BN	Brunei Darussalam	GY	Guyana	MX	Mexico	TM	Turkmenistan
BO	Bolivia	HK	Hong Kong	MY	Malaysia	TN	Tunisia
BR	Brazil	HM	Heard Island and McDonald Islands	MZ	Mozambique	TO	Tonga
BS	Bahamas	HN	Honduras	NA	Namibia	TP	East Timor
BT	Bhutan	HR	Croatia	NC	New Caledonia	TR	Turkey
BV	Bouvet Island	HT	Haiti	NE	Niger	TT	Trinidad and Tobago
BW	Botswana	HU	Hungary	NF	Norfolk Island	TV	Tuvalu
BY	Belarus	ID	Indonesia	NG	Nigeria	TW	Taiwan, Province of China
BZ	Belize	IE	Ireland	NI	Nicaragua	TZ	Tanzania, United Republic of
CA	Canada	IL	Israel	NL	Netherlands	UA	Ukraine
CC	Cocos (Keeling) Islands	IN	India	NO	Norway	UG	Uganda
CF	Central African Republic	IO	British Indian Ocean Territory	NP	Nepal	UM	United States Minor Outlying Islands
CG	Congo	IQ	Iraq	NR	Nauru	US	United States
CH	Switzerland	IR	Iran (Islamic Republic of)	NU	Niue	UY	Uruguay
CI	Côte d'Ivoire	IS	Iceland	NZ	New Zealand	UZ	Uzbekistan
CK	Cook Islands	IT	Italy	OM	Oman	VA	Vatican City State (Holy See)
CL	Chile	JM	Jamaica	PA	Panama	VC	Saint Vincent and the Grenadines
CM	Cameroon	JO	Jordan	PE	Peru	VE	Venezuela
CN	China	JP	Japan	PF	French Polynesia	VG	Virgin Islands (British)
CO	Colombia	KE	Kenya	PG	Papua New Guinea	VI	Virgin Islands (U.S.)
CR	Costa Rica	KG	Kyrgyzstan	PH	Philippines	VN	Viet Nam
CU	Cuba	KH	Kambodia	PK	Pakistan	VU	Vanuatu
CV	Cape Verde	KI	Kiribati	PL	Poland	WF	Wallis and Futuna Islands
CX	Christmas Island	KM	Comoros	PM	Saint Pierre and Miquelon	WS	Samoa
CY	Cyprus	KN	Saint Kitts and Nevis	PN	Pitcairn	YE	Yemen
CZ	Czech Republic	KP	Korea, Democratic People's Republic of	PR	Puerto Rico	YT	Mayotte
DE	Germany	KR	Korea, Republic of	PT	Portugal	YU	Yugoslavia
DJ	Djibouti	KW	Kuwait	PW	Palau	ZA	South Africa
DK	Denmark	KY	Cayman Islands	PY	Paraguay	ZM	Zambia
DM	Dominica	KZ	Kazakhstan	QA	Qatar	ZR	Zaire
DO	Dominican Republic	LA	Lao People's Democratic Republic	RE	Réunion	ZW	Zimbabwe
DZ	Algeria	LB	Lebanon	RO	Romania		
EC	Ecuador			RU	Russian Federation		
EE	Estonia			RW	Rwanda		
EG	Egypt						
EH	Western Sahara						
ER	Eritrea						

Tuner Set

IMPORTANT

Perform the following steps only if —
 — Auto Channel Set has not been set correctly by Auto Set Up or by Preset Download. (☞ pg. 10, 12)
 — you have moved to a different area or if a new station starts broadcasting in your area.

Your unit needs to memorize all necessary stations in channel positions in order to record TV programmes. Auto Channel Set automatically assigns all receivable stations in your area to call them up by using the **PR** buttons without going through any vacant channels.

- Turn on the TV and select the video channel (or AV mode).
- Slide the **TV/VCR/DVD** switch on the remote control to the right.

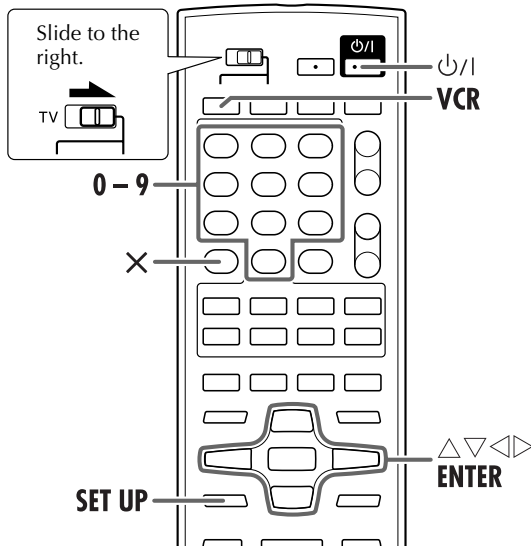

Auto Channel Set

1 Turn on the unit.

Press **⏻/I**.

2 Select the VHS deck.

On the unit
 Press **VCR/DVD** repeatedly so that the VCR indicator lights up.

On the remote control
 Press **VCR** so that the VCR indicator lights up.

3 Access the Main Menu screen.

Press **SET UP**.

4 Access the Auto Channel Set screen.

Press **△▽** to move the highlight bar (pointer) to “**AUTO CH SET**”, then press **ENTER** or **▷**.

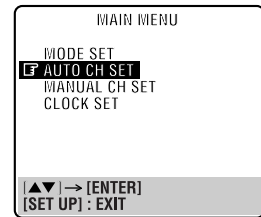

5 Select your country.

Press **△▽** to move the highlight bar (pointer) to your country's name, then press **ENTER** or **▷**.

6 Select the language.

Press **△▽** to move the highlight bar (pointer) to the language of your choice.

7 Perform Auto Channel Set.

Press **ENTER** twice.

- When you have connected the unit to a TV offering T-V Link via a fully-wired 21-pin SCART cable (☞ pg. 9), the unit automatically performs the Preset Download and the T-V LINK screen will appear. (☞ pg. 12)
- The Auto Set screen appears, and remains on screen while the unit searches for receivable stations.

As Auto Channel Set progresses, the “█” mark on the TV screen moves from left to right. Wait until the TV screen as shown in step 8 appears.

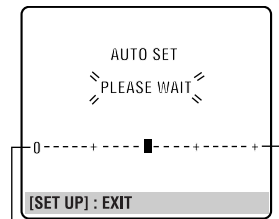

Beginning End

8 View the Confirmation screen.

After “SCAN COMPLETED” is displayed on the TV screen for about 5 seconds, the Confirmation screen looking like the one to the right appears. The stations your unit located appear on the Confirmation screen — channel positions (PR), channels (CH) and station names (ID — ☞ pg. 63). The blueback screen and the programme currently being broadcast by the blinking station appear alternately for 8 seconds each. To view the next page, use the **△▽◀▶** button on the remote control.

SPR	CH	ID	PR	CH	ID
01	25	ARD	08	C26	E-SP
02	C08	SKY1	09	55	WEST
03	10	ZDF	10	C24	SAT1
04	C65	RAI1	11	C23	OSF
05	C31	BBC1	12		
06	C32	BBC2	13		
07	C33	3SAT	14		

Navigation: [▲▼◀▶] | → [ENTER] : EDIT | → [X] : DELETE | [SET UP] : EXIT

- The stations located in the selected country appear at the top of the list.
- The Guide Program numbers will also be set automatically during Auto Channel Set.

9 Return to the normal screen.

Press **SET UP**.

60 EN

SUBSIDIARY SETTINGS (cont.)

- Using the Confirmation screen, you can skip or add channel positions, enter station names and perform other operations. Refer to pages 60 – 62 for the procedures.
- Depending on reception conditions, the stations may not be stored in order, and the station names may not be stored correctly.
- For information on scrambled broadcasts, refer to page 61.

IMPORTANT

- In certain reception conditions, station names may not be stored correctly, and Auto Guide Program Number Set may not work properly. If the Guide Program numbers are not set properly when you timer-record a TV programme using the SHOWVIEW system, the unit will record a TV programme of a different station. When programming the timer using the SHOWVIEW system, be sure to check the desired channel is selected correctly. (☞ pg. 24, "SHOWVIEW™ Timer Programming")
- Your unit memorizes all detected stations even if reception of some of them is poor. You can delete those stations with an unacceptable picture. (☞ pg. 61, "Deleting a Channel")

NOTES:

- Fine tuning is performed automatically during Auto Channel Set. If you want to perform tuning manually, refer to page 62.
- If you perform Auto Channel Set when the aerial cable is not connected properly, "SCAN COMPLETED –NO SIGNAL–" appears on the TV screen in step 2. When this happens, make sure of the aerial connection and press **ENTER**; Auto Channel Set will take place again.
- If no sound accompanies the picture or the audio sounds unnatural on some channels that have been stored by Auto Set Up, the TV system setting for those channels may be incorrect. Select the appropriate TV system for those channels. (☞ pg. 61, "INFORMATION")

Manual Channel Set

Store channels that were not stored during Auto Set Up (☞ pg. 10), Preset Download (☞ pg. 12) or Auto Channel Set (☞ pg. 59).

1 Access the Main Menu screen.

Press **SET UP**.

2 Access the Confirmation screen.

Press $\Delta \nabla$ to move the highlight bar (pointer) to "MANUAL CH SET", then press **ENTER** or \triangleright . The Confirmation screen appears.

3 Select the channel position.

Press $\Delta \nabla \triangleleft \triangleright$ until an open (Example) To store in position 12.

position in which you want to store a channel begins blinking, then press **ENTER**.

The Manual Channel Set screen appears.

- The blueback screen and the programme currently being broadcast by the selected channel appear alternately for 8 seconds each.

PR	CH	ID	PR	CH	ID
01	25	ARD	08	C26	E-SP
02	C08	SKY1	09	55	WEST
03	10	ZDF	10	C24	SAT1
04	C65	RAI1	11	C23	OSF
05	C31	BBC1	12	----	----
06	C32	BBC2	13	----	----
07	C33	3SAT	14	----	----

$\blacktriangleleft \blacktriangleright$: SELECT
 $\blacktriangle \blacktriangledown$: CURSOR \leftrightarrow
 \rightarrow [ENTER] : OK
 \rightarrow [X] : DELETE
 \rightarrow [SET UP] : EXIT

4 Select the band.

Press $\Delta \nabla$ to change the band between CH (regular) and CC (cable), then press \triangleright .

PR	CH	ID	FINE	DECODER
12	CH01	----	+/-	OFF

$\blacktriangle \blacktriangledown$: SELECT
 $\blacktriangleleft \blacktriangleright$: CURSOR \leftrightarrow
 \rightarrow [ENTER] : OK
 \rightarrow [SET UP] : EXIT

5 Input the channel.

Press the **number keys** to input the channel number you want to store.

- Input "0" before any single number entries.
- To input the registered station name (ID – ☞ pg. 63), press \triangleright until "----" (ID setting) begins blinking, then press $\Delta \nabla$.
- For fine tuning adjustment, press \triangleright until "+/-" begins blinking, then press $\Delta \nabla$. While tuning, "+" or "-" appears.
- When storing a channel that sends scrambled broadcasts, press \triangleright until "OFF" (Decoder setting) blinks, then press $\Delta \nabla$ to set "DECODER" to "ON" ("OFF" is the default setting).
- When "L-2 SELECT" is set to "AV" or "SAT", the "DECODER" setting cannot be changed. (☞ pg. 54)

6 Enter new channel information.

Press **ENTER** and the Confirmation screen appears.

- Repeat steps 3 – 5 as necessary.

7 Close the Confirmation screen.

Press **SET UP**.

- To change positions, see "Changing Station Channel Position" (☞ pg. 61).
- If you wish to set station names other than the ones registered in your unit, see "Setting Station Names Manually" (☞ pg. 62).

ATTENTION

Guide Program numbers are not set when channels are stored manually. (☞ pg. 24, "SHOWVIEW™ Timer Programming")

Deleting a Channel

Perform steps **1** and **2** of "Manual Channel Set" on page 60 to access the Confirmation screen before continuing.

1 Select the item.

Press $\Delta \nabla \triangleleft \triangleright$ until the item you want to delete begins blinking.

2 Delete a channel.

Press X.

- The item directly beneath the cancelled one moves up one line.
- Repeat steps **1** and **2** if necessary.

3 Close the Confirmation screen.

Press SET UP.

Changing Station Channel Position

Perform steps **1** and **2** of "Manual Channel Set" on page 60 to access the Confirmation screen before continuing.

1 Select the item.

Press $\Delta \nabla \triangleleft \triangleright$ until the item you want to move begins blinking. Then press ENTER and the station name (ID) and its channel (CH) number begin blinking.

2 Select the new position.

Press $\Delta \nabla \triangleleft \triangleright$ to move the station to the new channel position, then press ENTER.

Example: If you moved the station in position 4 to position 2, the stations originally in positions 2 and 3 each move down one space.

PR	CH	ID	PR	CH	ID
01	25	ARD	08	C26	E.SP
02	C08	SKY1	09	55	WEST
03	10	ZDF	10	C24	SAT1
04	C65	RAI1	11	C23	OSF
05	C31	BBC1	12	C25	ESPN
06	C32	BBC2	13		
07	C33	3SAT	14		

➔

PR	CH	ID	PR	CH	ID
01	25	ARD	08	C26	E.SP
02	C65	RAI1	09	55	WEST
03	C08	SKY1	10	C24	SAT1
04	10	ZDF	11	C23	OSF
05	C31	BBC1	12	C25	ESPN
06	C32	BBC2	13		
07	C33	3SAT	14		

- Repeat steps **1** and **2** if necessary.

3 Close the Confirmation screen.

Press SET UP.

When Receiving a Scrambled Broadcast

1 Select the decoder mode.

Set "L-2 SELECT" to "DECODER". (pg. 54)

2 Access the Confirmation screen.

Perform steps **1** and **2** of "Manual Channel Set" on page 60.

3 Select the position.

Press $\Delta \nabla \triangleleft \triangleright$ to select the channel position broadcasting scrambled programmes, then press ENTER twice.

4 Change the decoder setting.

Press \triangleright until "OFF" (decoder setting) begins blinking, and set it to "ON" by pressing $\Delta \nabla$.

5 Return to the Confirmation screen.

Press ENTER.
 • Repeat steps **3** – **5** if necessary.

6 Close the Confirmation screen.

Press SET UP.

INFORMATION

If you live in Eastern Europe, "TV SYSTEM" setting appears instead of "DECODER" setting on the Manual Channel Set screen. When you can see the picture but can hear no audio, select appropriate TV system (D/K or B/G). Normally, TV programmes are broadcasted as follows.

For Eastern Europe : D/K

For Western Europe : B/G

- 1 Select a country in Eastern Europe in step **5** on page 59.
- 2 Press \triangleright until the TV system (D/K or B/G) starts blinking on the Manual Channel Set screen in step **4** on page 60.
- 3 Press $\Delta \nabla$ to select appropriate TV System (D/K or B/G).

62 EN

SUBSIDIARY SETTINGS (cont.)

Setting Station Names by ID Code

Set station names by ID codes ("ID") that are registered in your unit.

Perform steps **1** and **2** of "Manual Channel Set" on page 60 to access the Confirmation screen before continuing.

1 Select the item.

Press $\Delta \nabla \triangleleft \triangleright$ until the item you want begins blinking.

2 Access the Manual Channel Set screen.

Press **ENTER** twice.

3 Select the new station.

Press \triangleright until the station name (ID) begins blinking, then press $\Delta \nabla$ until the new station's name (ID) you want to store begins blinking. Registered station names (see pg. 63) appear as you press $\Delta \nabla$.

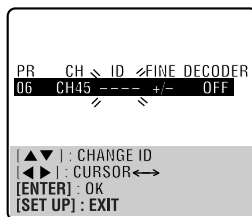

4 Switch the stations.

Press **ENTER**.
 • The Confirmation screen appears.
 • Repeat steps **1** – **4** if necessary.

5 Close the Confirmation screen.

Press **SET UP**.

Setting Station Names Manually

You can set station names manually.

Perform steps **1** and **2** of "Manual Channel Set" on page 60 to access the Confirmation screen and then perform steps **1** and **2** of "Setting Station Names by ID Code" above before continuing.

1 Select the character for station name.

Press \triangleright until the first letter of the station name begins blinking.

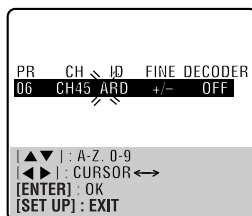

2 Enter the new character.

Press $\Delta \nabla$ to cycle through the characters (A–Z, 0–9, –, *, +, _ (space)) and stop when the desired character is indicated, then press \triangleright to enter. Enter the remaining characters the same way (maximum of 4). After entering all characters, press **ENTER**.

- The Confirmation screen appears.
- If you make a mistake, press \triangleleft until the incorrect character begins blinking. Then enter the correct character by pressing $\Delta \nabla$.

3 Close the Confirmation screen.

Press **SET UP**.

NOTE:

The characters available for the station name (ID) are A–Z, 0–9, –, *, +, _ (space) (maximum of 4).

Fine-Tuning a Stored Channel

Perform steps **1** and **2** of "Manual Channel Set" on page 60 to access the Confirmation screen before continuing.

1 Select the channel to fine-tune.

Press $\Delta \nabla \triangleleft \triangleright$ until the channel you want to tune begins blinking.

2 Access the Manual Channel Set screen.

Press **ENTER** twice. The Manual Channel Set screen appears.

3 Perform tuning.

Press \triangleright until "+/–" begins blinking, then press $\Delta \nabla$ to obtain the best picture quality. After finishing adjustment, press **ENTER**.

- The Confirmation screen appears.
- Repeat steps **1** – **3** if necessary.

4 Close the Confirmation screen.

Press **SET UP**.

TV Station and ID List

* The "ID" abbreviation is what is shown on-screen in lieu of the station name. The "ID" abbreviation is listed in the Confirmation screen and is displayed on the TV screen when the unit is tuned to a different station.

ID*	STATION NAME	ID*	STATION NAME	ID*	STATION NAME
1000	TV1000	JIM	JIM TV	SHOW	SHOW
3SAT	3SAT	JSTV	JSTV	SIC	SOCIEDADE
9LIV	9LIVE	KA2	KA2	SKY	SKY CHANNEL
AB3	AB3	KAB1	KABEL1	SKYN	SKY NEWS
ADLT	ADULT	KAN2	KANAL2	SPEK	SPEKTRUM
ANIM	Animal Planet	KAN5	KANAL5	SPRT	SPORT
ANT3	ANTENA3	KBH	Kbh. Kanal	SRTL	SUPER RTL
ARD	ARD	KIKA	Kinder kanal	STAR	STAR-TV
ARTE	ARTE	LA7	LA7	SVT1	SVT1
ATV	ATV	LIB	Liberty TV	SVT2	SVT2
B1	BERLIN 1	LOCA	LOCAL	SV24	News
BBC	BBC GROUP	M6	M6	SWR	SUEDWEST3
BBC1	BBC1	MBC	MBR	TCC	TCC
BBC2	BBC2	MCM	MCM	TCM	TCM
BBCW	BBC WORLD	MDR	MDR	TELE	TELE
BIO+	TV BIO+	MOVE	MOVIE	TELE5	TELE5
BLOO	BLOOMBERG	MTV	MTV	TF1	TF1
BR3	BAYERN3	MTV1	MTV1	TM	TM
C+	CANAL PLUS	MTV2	MTV2	TMC	TELEMONTECARLO
C1	PORTUGUSES	MTV3	MTV3	TMF	TMF
C9	C9	NGEO	NGEO	TNT	TNT INT
CAN5	CANALE5	N24	News 24	TRT	TRT INT
CANV	KETNET CANVAS	N3	NORD3	TSI1	TSI
CANZ	KANAAL Z	N-TV	N-TV	TSI2	TSI2
CH4	CHANNEL4	NBC	NBC SUPER	TSR1	TSR
CH5	CHANNEL5	NDR	NDR	TSR2	TSR2
CHILD	CHILD	NED1	NED1	TV1	BRTN TV1
CINE	CINEMA	NED2	NED2	TV2	TV2
CLUB	TELECLUB	NED3	NED3	TV2Z	TV2 Z
CMT	CMT	NET5	Net 5	TV3	TV3
CNN	CNN	NEWS	NEWS	TV3+	TV3 plus
CSUR	ANDALUCIA	NICK	NICKELODEON	TV4	TV4
CT1	CT 1	NOVA	NOVA TV	TV5	TV5
CT2	CT 2	NRK1	NRK	TV6	TV6
DISC	DISCOVERY	NRK2	NRK2	TV8	TV8
DK1	TV Denmark 1	ODE	ODEON	TVE1	TVE1
DK2	TV Denmark 2	ORF1	ORF1	TVE2	TVE2
DK4	Denmark 4	ORF2	ORF2	TVG	TV GALICIA
DR1	DR TV	PHOE	PHOENIX	TVI	TV INDEPENDENT
DR2	DR2	POLS	POLST	TVN	TV NORGE
DSF	DSF	PREM	PREMIERE	TV24	TVN24
DUNA	DUNA TV	PRIM	PRIMA TV	TVP1	TVP1
ETB1	ETB1	PRO7	PRO7	TVP2	TVP2
ETB2	ETB2	RAI1	RAI1	TV P	TV Polonia
ETV	Game/Shop/Music	RAI2	RAI2	V8	V8
EUNW	EURO NEWS	RAI3	RAI3	VCR	VIDEO
EURO	EURONEWS	RET4	RETE4	VH-1	VH-1
EUSP	EUROSPORTS	RTB1	TELE21	VIT	VIT
FEMM	FEMMAN	RTB2	RTBF 2	VIVA	VIVA
FILM	FILM	RTL	RTL	VIV2	VIVA2
FNET	FILMNET	RTL2	RTL2	VMTV	VIDEO MUSIC
FR2	France2	RTL4	RTL4	VOX	VOX
FR3	France3	RTL5	RTL5	VSAT	VIASAT3
FR5	France5	RTL7	RTL7	VT4	VT4
GALA	GALAVISION	RTLK	RTL KLUB	VTM	VTM
HBO	HBO	RTP	RTP	WDR3	West3
HR3	HESSEN3	RTV4	RTV4	WRLD	WRLD
HSEU	HSEU	SAT1	SAT1	YLE1	YLE1
INFO	INFO-KANAL	SBS6	SBS	YLE2	YLE2
ITA1	ITALIA1	SERV	Service	YORN	YORIN
ITA7	ITALIA7	SF1	SF1	ZDF	ZDF
ITV1	ITV	SF2	SF2	ZTV	ZTV

Video Channel Set

Video channel (RF output channel) is the channel on which your TV receives picture and sound signals from the unit through the RF cable.

IMPORTANT

- Perform the following steps only if —
- Video Channel Set has not been done correctly by the Auto Set Up function (pg. 10),
 - interference appears in the TV picture after you have moved to a different area or a new station has started broadcasting in your area.
 - you change the connection between your unit and TV from RF connection to AV connection, or vice versa.

If you have connected the unit to your TV via the AV connection (pg. 9), you have to set the video channel to off.

If you have connected the unit to your TV via the RF connection (pg. 9), you have to set the correct video channel.

Before performing the following steps:

- Make sure there is no cassette inserted in the unit.
- Press VCR/DVD on the unit or VCR on the remote control so that the VCR indicator lights up, then press 1 to turn off the unit.

1 Access the Video Channel Set mode.

Hold down 1 on the unit until the front display panel shows the following.

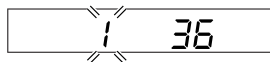

2 Set the RF output system.

The blinking number on the display indicates the RF output system of your country.

- If you have selected MAGYARORSZÁG, ČESKÁ REPUBLIKA, POLSKA or OTHER EASTERN EUROPE for the country setting (pg. 10, 15), press 2 to set to "2."
 - For other countries, set to "1". Then press ENTER.
- (1: B/G 2: D/K)

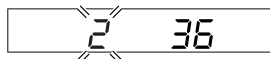

3 Set the video channel.

With AV Connection

Press PR - until the front display panel shows "1 --" (or "2 --").

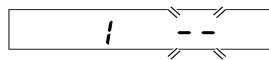

- Now the video channel is set to off.

With RF Connection

Press PR + or - to set the unit to a vacant channel between 22 and 69 which is not occupied by any local station in your area.

(Example) If channel 50 is available in your area

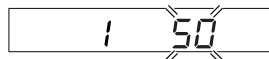

Then set your TV to UHF channel 50.

- If the two vertical white bars appear clearly on the TV screen as shown to the right, go to step 4.
- If the two vertical white bars do not appear clearly, re-set the unit to another vacant channel and try again.

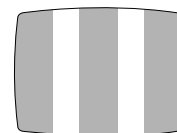

NOTES:

- If you set the unit to a channel which is occupied by a local station or has neighbouring channels that are occupied by local stations, the picture reception quality will be affected and some interference noise will appear on the TV screen. Be sure to select a vacant channel which has no broadcast on neighbouring channels.
- If you cannot obtain the two vertical white bars clearly with any channel between 22 and 69, consult your JVC dealer.

4 Exit the Video Channel Set mode.

Press ENTER.

With AV Connection

To view picture signals from the unit, set your TV to its AV mode.

With RF Connection

The channel you have set in step 3 above is your video channel.

To view picture signals from the unit, set your TV to this video channel.

Clock Set

- Turn on the TV and select the video channel (or AV mode).
- Slide the **TV/VCR/DVD** switch on the remote control to the right.

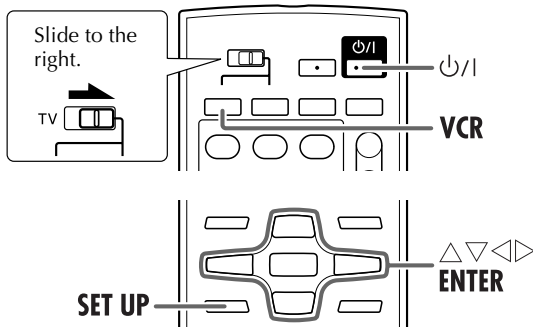

IMPORTANT

If you performed Auto Set Up (pg. 10) or Preset Download (pg. 12), without ever having set the clock previously, the unit's built-in clock is also set automatically. Perform the following steps only if —
 —Auto Clock Set has not been performed correctly by Auto Set Up or Preset Download.
OR
 —you want to change the Just Clock setting. (pg. 65, "Just Clock")

1 Turn on the unit.

Press **⏻/I**.

2 Select the VHS deck.

On the unit

Press **VCR/DVD** repeatedly so that the VCR indicator lights up.

On the remote control

Press **VCR** so that the VCR indicator lights up.

3 Access the Main Menu screen.

Press **SET UP**.

4 Access the Clock Set screen.

Press **△▽** to move the highlight bar (pointer) to "CLOCK SET," then press **ENTER** or **▷**. The Clock Set screen appears.

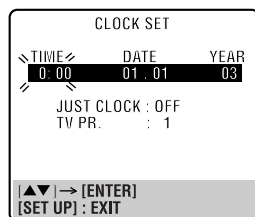
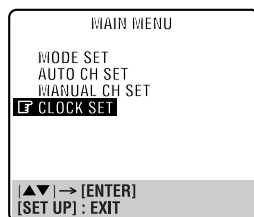

NOTE:

When you have selected MAGYARORSZÁG, ČESKÁ REPUBLIKA, POLSKA or OTHER EASTERN EUROPE for the country setting (pg. 10, 15), you cannot use the Just Clock function. Skip steps 5 and 7.

5 Set the date and time.

Press **△▽** to set the time, then press **ENTER** or **▷**. The "DATE" display begins blinking. Repeat the same procedure to set the date and year.

- When you set the time/date, press and hold **△▽** to change the time by 30 minutes/15 days.

6 Set Just Clock.

The default setting is "OFF". Set as desired by pressing **△▽**, then press **ENTER** or **▷**.

- For the Just Clock function, refer to "Just Clock" on page 65.
- If you set it "OFF," press **SET UP** to finish the clock setting.

Just Clock

The Just Clock function provides accurate time keeping through automatic adjustments at regular intervals, by reading data from a PDC signal.

The Just Clock option can be set "ON" or "OFF" at the Clock Set screen (the default setting is "OFF"). Press **ENTER** until the Just Clock setting begins blinking, then press **△▽** to change the setting.

IMPORTANT: If you turn off Just Clock, the accuracy of the built-in clock may be reduced, which could adversely effect timer recording. We recommend you to set Just Clock on. In cases where the clock setting data from a PDC signal is incorrect, however, you are advised to set it "OFF."

7 Set the source channel position for clock data.

The unit is preset to receive clock setting and adjustment data from channel position 1.

Press **△▽** to set the channel position to the number representing the station transmitting clock setting data, then press **ENTER** or **▷**.

8 Start the clock operation.

Press **SET UP**.

NOTES:

- Just Clock (when set to "ON") adjusts the unit's built-in clock every hour, except for 23:00, 0:00, 1:00 and 2:00.
- Just Clock is not effective when:
 - the unit's power is on.
 - the unit is in the timer mode. (VHS deck only)
 - a difference of more than 3 minutes exists between the built-in clock's time and the actual time.
 - the unit is in the Automatic Satellite Programme Recording mode. (pg. 28) (VHS deck only)
 - the unit is in the Power Save mode. (pg. 54) (VHS deck only)
 - "L-2 SELECT" is set to "SAT". (pg. 54) (VHS deck only)
- If Just Clock is set to "ON", the unit's clock is automatically adjusted at the start/end of Summer Time.
- Just Clock may not function properly depending on the reception condition.

Child Lock

You can disable the unit's operation.

- Turn on the TV and select the video channel (or AV mode).
- Slide the **TV/VCR/DVD** switch on the remote control to the right.

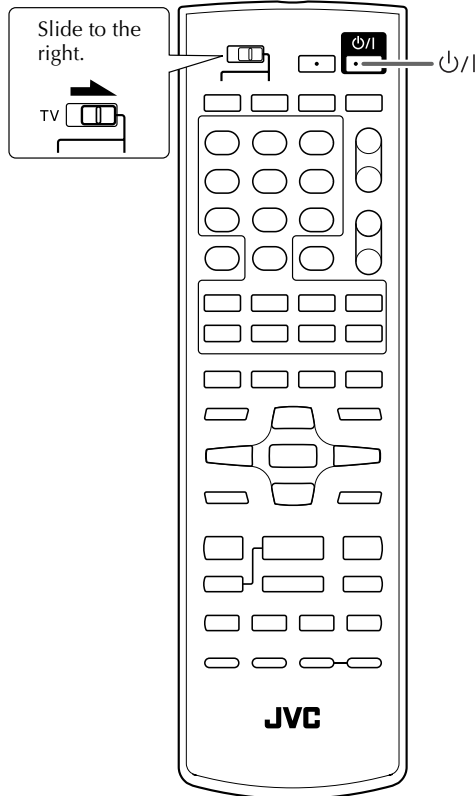

1 Set the Child Lock.

Press and hold ⏻ on the remote control for more than 10 seconds while the unit is turned on. The unit turns off, and "CL" appears on the front display panel.



- To release the child lock, press and hold ⏻ on the remote control until the unit turns on.

NOTES:

- When the child lock function is in use, keep the remote control out of the children's reach.
- Timer recording programmes will be performed even if the child lock function is activated.

TROUBLESHOOTING

EN 67

Before requesting service for a problem, use this chart and see if you can repair the trouble yourself. Small problems are often easily corrected, and this can save you the trouble of sending your unit off for repair.

Power

No power is supplied to the unit.

- The mains power cord is disconnected.
- Connect the mains power cord.

The remote control won't function.

- The batteries are discharged.
- Replace the dead batteries with new ones.

Tape Transport (VHS deck)

During recording, the tape does not run. "●" lights up on the front display panel.

- The unit is in the Record Pause mode.
- Press ▶ to resume recording.

The tape will not rewind or fast-forward.

- The tape is already fully rewound or fast-forwarded.
- Check the cassette.

Playback (VHS deck)

The VHS deck can not be operated.

- The VHS deck is not selected.

On the unit

→ Press **VCR/DVD** repeatedly so that the VCR indicator lights up.

On the remote control

→ Press **VCR** so that the VCR indicator lights up.

The playback picture does not appear while the tape is running.

- If you are using the RF connection,
 - the TV receiver's channel selector is not set to the video channel.
 - the unit's video channel has not been correctly set.
- If you are using the RF connection,
 - set the TV receiver to the video channel.
 - perform "Video Channel Set" (ⓘ pg. 64).
- If you are using the AV connection, the TV receiver is not set to the AV mode.
- If you are using the AV connection, set the TV to its AV mode.

Noise appears during visual search.

- This is normal.

Noise appears during normal playback.

- The automatic tracking mode is engaged.
- Try manual tracking. (ⓘ pg. 20)

The playback picture is blurred or interrupted while TV broadcasts are clear or "USE CLEANING CASSETTE" message appears on the screen.

- The video heads may be dirty.
- Use a dry cleaning cassette ECL-3F, or consult your JVC dealer.

Breaks are noticeable in Hi-Fi soundtrack.

- The automatic tracking mode is engaged.
- Try manual tracking. (ⓘ pg. 20)

Playback (DVD deck)

The button does not work.

- The operation is prohibited on the placed disc.

The DVD deck can not be operated.

- The DVD deck is not selected.

On the unit

→ Press **VCR/DVD** repeatedly so that the DVD indicator lights up.

On the remote control

→ Press **DVD** so that the DVD indicator lights up.

"⊙" appears on the TV screen.

- The operation is prohibited on the placed disc.

"REGION CODE ERROR!" appears on the TV screen.

- The disc's region number does not match that of the unit.
- Use the discs whose region number includes "ALL" or "2". (ⓘ pg. 4)

The disc cannot be played back.

- The disc's region number does not match that of the unit.
- Use the discs whose region number includes "ALL" or "2". (ⓘ pg. 4)
- This type of disc cannot be played back.
- See "Unplayable Discs" (ⓘ pg. 4).
- The disc is not placed properly.
- Remove the disc, then place the disc properly in the disc tray. (ⓘ pg. 5, "Placing a Disc")
- The Parental Lock is engaged, and the placed disc is rated higher than the set level.
- Release the Parental Lock temporarily (ⓘ pg. 57), or change the set level (ⓘ pg. 57).

The language is not played back as you set.

- The disc does not contain the language you set.

68 EN**TROUBLESHOOTING (cont.)****Changing audio/subtitle language is not possible.**

- The disc does not contain audio/subtitles in multiple languages.
- With some discs, the language should be set on the disc menu. (☞ pg. 31)

The subtitles do not appear on the TV screen.

- The disc does not contain subtitles.
- The subtitle display is set to off.
- Set the subtitles display to on. (☞ pg. 34)
- A-B Repeat Playback is in progress. (☞ pg. 33)
- The subtitles recorded around point A-B may not appear.

Angle cannot be changed.

- The scene is not recorded from multiple angles.

Audio/Video Files Playback (DVD deck)**No sound and/or no picture comes out.**

- MP3 disc is recorded with the "packet writing (UDF format)." It cannot be played back.
- Check the files if they are playable or unplayable.

Files (tracks) are not played in the recorded order.

- The unit plays the files in the alphabetic order. So, the playback order can vary.

DivX files are played back without sound.

- The unit can play back the MP3 sound for the audio part of the DivX files. Select the proper audio CODEC when making DivX files.

Recording (VHS deck)**Recording cannot be started.**

- There is no cassette loaded, or the cassette loaded has had its record safety tab removed.
- Insert a cassette, or using adhesive tape, cover the hole where the tab was removed.

TV broadcasts cannot be recorded.

- "L-1," "L-2" or "F-1" has been selected as the input mode.
- Set to the desired channel.

Tape-to-tape editing is not possible.

- The source (another video recorder, camcorder) has not been properly connected.
- Confirm that the source is properly connected.
- All necessary power switches have not been turned on.
- Confirm that all units' power switches are turned on.
- The input mode is not correct.
- Set the input mode to "L-1," "L-2" or "F-1."

Camcorder recording is not possible.

- The camcorder has not been properly connected.
- Confirm that the camcorder is properly connected.
- The input mode is not correct.
- Set the input mode to "L-1," "L-2" or "F-1."

"●" and "▶" on the front display panel won't stop blinking.

- The end of the tape was reached during recording.
- The programme may not have been recorded in its entirety. Next time make sure you have enough time on the tape to record the entire programme.

Timer Recording (VHS deck)

Timer recording won't work.

- The clock and/or the timer have been set incorrectly.
→ Re-perform the clock and/or timer settings.
- The timer is not engaged.
→ Press  and confirm that "Ⓢ" is displayed on the front display panel.

Timer programming is not possible.

- Timer recording is in progress.
→ Timer programming can't be performed while a timer recording is in progress. Wait until it finishes.



"Ⓢ" on the front display panel won't stop blinking.

- The timer is engaged but there's no cassette loaded.
→ Load a cassette with the record safety tab intact.

"Ⓢ", "●" and "▶" on the front display panel won't stop blinking.

- The loaded cassette has had its record safety tab removed.
→ Remove the cassette and cover the hole with adhesive tape, or insert a cassette with the record safety tab intact.
- The end of the tape was reached during timer recording.
→ The programme may not have been recorded in its entirety. Next time make sure you have enough time on the tape to record the entire programme.

"Ⓢ" blinks for 10 seconds and the timer mode is disengaged.

-  has been pressed when there are no programs in memory, or the timer record information has been programmed incorrectly.
→ Check the programmed data and re-program as necessary, then press  again.

The SHOWVIEW system does not timer-record properly.

- The unit's channel positions have been set incorrectly.
→ Refer to "SHOWVIEW™ Timer Programming" (☞ pg. 24) and re-perform the procedure.

"●" and "▶" on the front display panel won't stop blinking.

- The end of the tape was reached during Instant Timer Recording.
→ The programme may not have been recorded in its entirety. Next time make sure you have enough time on the tape to record the entire programme.

"Ⓢ", "●" and "▶" on the front display panel won't stop blinking.

- The loaded cassette has had its record safety tab removed.
→ Remove the cassette and cover the hole with adhesive tape, or insert a cassette with the record safety tab intact.
- The end of the tape was reached during Automatic Satellite Programme Recording.
→ The programme may not have been recorded in its entirety. Next time make sure you have enough time on the tape to record the entire programme.

Other Problems

The image of the TV broadcast appears distorted on the TV screen.

- The unit is left turned on and the DVD deck is selected.
→ Turn off the unit, or press **VCR** to select the VHS deck, then press **TV/VCR** so that the VCR indicator disappears from the front display panel.

Whistling or howling is heard from the TV during camcorder recording.

- The camcorder's microphone is too close to the TV.
→ Position the camcorder so its microphone is away from the TV.
- The TV's volume is too high.
→ Turn the TV's volume down.

When scanning channels, some of them are skipped over.

- Those channels have been designated to be skipped.
→ If you need the skipped channels, restore them. (☞ pg. 60)

The channel cannot be changed.

- Recording is in progress.
→ Press **II** to pause the recording, change channels, then press **▶** to resume recording.

Channel settings that were made manually seem to have changed or disappeared.

- After the manual settings were made, Auto Channel Set was performed.
→ Perform the manual settings again.

No channels are stored in the unit's memory.

- The TV aerial cable was not connected to the unit when Auto Set Up was performed.
→ Turn off the unit once and connect the TV aerial cable to the unit properly, then turn on the unit again. Then perform Auto Set Up again. (☞ pg. 10)
- The fully-wired 21-pin SCART cable was not connected between the TV and the unit when Preset Download was performed.
→ Turn off the unit once and connect the fully-wired 21-pin SCART cable to the unit properly, then turn on the unit again. Then perform Preset Download again. (☞ pg. 12)

ATTENTION

This unit contains microcomputers. External electronic noise or interference could cause malfunctioning. In such cases, switch the unit off and unplug the mains power cord. Then plug it in again and turn the unit on. Take out the cassette. After checking the cassette, operate the unit as usual.

70_{EN}

SPECIFICATIONS

GENERAL

Power requirement : AC 220 V – 240 V ~ , 50 Hz/60 Hz
 Power consumption
 Power on : 23 W
 Power off : 4.0 W
 Temperature
 Operating : 5°C to 40°C
 Storage : -20°C to 60°C
 Operating position : Horizontal only
 Dimensions (WxHxD)
 : 435 mm x 93 mm x 272 mm
 Weight : 4.2 kg
 Format : VHS PAL standard
 Maximum recording time
 (SP) : 240 min. with E-240 video cassette
 (LP) : 480 min. with E-240 video cassette

VIDEO/AUDIO (VHS deck)

Signal system : PAL-type colour signal and CCIR monochrome signal, 625 lines
 50 fields
 Recording system : DA4 (Double Azimuth) head helical scan system
 Signal-to-noise ratio: 45 dB
 Horizontal resolution : 250 lines
 Frequency range : 70 Hz to 10,000 Hz (Normal audio)
 20 Hz to 20,000 Hz (Hi-Fi audio)
 Input/Output : 21-pin SCART connectors:
 IN/OUT x 1, IN/DECODER x 1
 RCA connectors:
 VIDEO IN x 1, AUDIO IN x 1,
 AUDIO OUT x 1

VIDEO/AUDIO (DVD deck)

Signal system : PAL
 Applicable disc : DVD VIDEO, DVD-R (Video format), DVD-RW (Video format), Video CD, SVCD, Audio CD (CD-DA), CD-R/RW (CD-DA, Video CD, SVCD, MP3 format, JPEG, DivX)
 Frequency response
 DVD : 4 Hz – 22 KHz
 CD : 4 Hz – 20 KHz
 S/N Ratio : 90 dB
 Wow and flutter : Below Measurable Level
 Dynamic range : 90 dB
 Output
 Audio : (RCA) 2 Vrms, 1 Kohm
 Digital Audio : -21 dBm to -15 dBm (peak)

TUNER/TIMER (VHS deck)

TV channel storage capacity : 99 positions (+AUX position)
 Tuning system : Frequency synthesized tuner
 Channel coverage : VHF 47 MHz – 89 MHz/
 104 MHz – 300 MHz/
 302 MHz – 470 MHz
 UHF 470 MHz – 862 MHz
 Aerial output : UHF channels 22 – 69 (Adjustable)
 Memory backup time : Approx. 10 min.

ACCESSORIES

Provided accessories : RF cable,
 Infrared remote control unit,
 “R6” battery x 2

Specifications shown are for SP mode unless otherwise specified.
 E. & O.E. Design and specifications subject to change without notice.

LIST OF TERMS

EN 71

A			
A-B Repeat Playback	33	SUBTITLE	16
About Discs		Mode Set (VHS deck)	
Placing a Disc	5	AUTO POWER OFF	54
Playable Discs	4	AUTO SP→LP TIMER	53
Region Number	4	B.E.S.T.	53
Unplayable Discs	4	COLOUR SYSTEM	54
Angle Selection	35	DIRECT REC	53
Audio Language and Sound Selection	35	L-2 SELECT	54
Auto Channel Set	59	O.S.D.	53
Auto Set Up	10	PICTURE CONTROL	53
Automatic Satellite Programme Recording	28	POWER SAVE	54
		VIDEO STABILIZER	54
C		N	
Changing Station Channel Position	61	Next Function Memory	19
Changing the Picture of the Opening Display	42	O	
Check, Cancel and Change Programmes	27	One Touch Replay	19, 32
Child Lock	66	On-Screen Language Set (DVD deck)	16
Clock Set	65	On-Screen Language Set (VHS deck)	15
Connecting to a Dolby Digital Decoder or an Amplifier with a Built-In DTS	51	OPERATIONS ON DVD DECK	30 – 43
Connecting to a Satellite Receiver	50	OPERATIONS ON VHS DECK	18 – 29
Connecting/Using a Decoder	51	P	
Country/Area Code List for Parental Lock	58	Pan&Scan	14
D		Playback Control (PBC) Function	31
Deleting a Channel	61	Playing Back DivX Files with Subtitle	43
Digital Audio Dubbing	47	Preset Download	12
Dubbing (from DVD to VHS)	46	Programme Playback	36, 42
DVD Menu	31	R	
E		Random Playback	36, 41
Editing from a Camcorder	44	Recording	21 – 23
Editing to or from Another Video Recorder	45	Recording One Programme While Watching Another	22
Elapsed Recording Time Indication	22	Recording Resume Function	21
Express Timer Programming	26	Remote Control Functions	48
F		Repeat Playback	20, 33, 41
Fine-Tuning a Stored Channel	62	S	
I		Setting Station Names by ID Code	62
INDEX	6	Setting Station Names Manually	62
Index Search	19	SHOWVIEW™ Timer Programming	24
Instant ReView	20	Skip Search	19
Instant Timer Recording (ITR)	22	Slide Show Playback (JPEG Files)	42
J		Slow Motion	19, 32
Just Clock	13, 65	Sound Effect	37
L		Soundtrack Selection	20
Language Code List	17	Still Picture/Frame-By-Frame Playback	19, 32
Letter Box	14	Subtitle Selection	34
Locating the Start Point of the Item or Skip the Item	31	T	
M		Tape Position Indicator	7
Manual Channel Set	60	Tape Remaining Time	22
Manual Tracking	20	Time Search	34
Menu/Audio/Subtitle Language Set (DVD deck only)	16	Timer Recording	24 – 29
Mode Set (DVD deck)		Tuner Set	59 – 63
ANALOG DOWN MIX	56	T-V LINK	13
AUDIO LANGUAGE	16	TV Station and ID List	63
BACKGROUND	56	V	
D. RANGE CONTROL	56	Variable Speed Search	19, 32
DIGITAL AUDIO OUTPUT	56	VFP Function	37
DivX REGISTRATION	57	Video Channel Set	64
MENU LANGUAGE	16	VPS/PDC Recording	25
MONITOR TYPE	14, 56	W	
ON SCREEN GUIDE	57	When Programmes Overlap Each Other	28
ON SCREEN LANGUAGE	16	When Receiving a Scrambled Broadcast	61
OUTPUT LEVEL	56	Z	
PARENTAL LOCK	57	Zooming	32, 41
PICTURE SOURCE	56		
RESUME	57		
SCREEN SAVER	56		

EN

HR-XV48E

JVC
VICTOR COMPANY OF JAPAN, LIMITED