

# JVC



ENGLISH

ESPAÑOL

FRANÇAIS

**DVD/CD RECEIVER**  
**RECEPTOR CON DVD/CD**  
**RÉCEPTEUR DVD/CD**

## KD-ADV49/KD-AVX44



For canceling the display demonstration, see page 7.

Para cancelar la demostración en pantalla, consulte la página 7.

Pour annuler la démonstration des affichages, référez-vous à la page 7.

For installation and connections, refer to the separate manual.

Para la instalación y las conexiones, refiérase al manual separado.

Pour l'installation et les raccordements, se référer au manuel séparé.

**For customer Use:**

Enter below the Model No. and Serial No. which are located on the top or bottom of the cabinet. Retain this information for future reference.

Model No. \_\_\_\_\_

Serial No. \_\_\_\_\_

## INSTRUCTIONS

MANUAL DE INSTRUCCIONES  
MANUEL D'INSTRUCTIONS

LVT1797-001A  
[J/C]

Thank you for purchasing a JVC product.

Please read all instructions carefully before operation, to ensure your complete understanding and to obtain the best possible performance from the unit.

## IMPORTANT FOR LASER PRODUCTS

- CLASS 1 LASER PRODUCT
- CAUTION:** Do not open the top cover. There are no user serviceable parts inside the unit; leave all servicing to qualified service personnel.
- CAUTION:** (For U.S.A.) Visible and/or invisible class II laser radiation when open. Do not stare into beam.  
(For Canada) Visible and/or invisible class 1M laser radiation when open. Do not view directly with optical instruments.
- REPRODUCTION OF LABEL: CAUTION LABEL, PLACED OUTSIDE THE UNIT.

<b>CAUTION</b> VISIBLE AND/OR INVISIBLE CLASS 1M LASER RADIATION WHEN OPEN. DO NOT VIEW DIRECTLY WITH OPTICAL INSTRUMENTS. IEC60825-1:2001 (ENG)	<b>ATTENTION</b> RAYONNEMENT LASER VISIBLE ET/OU INVISIBLE DE CLASSE 1M UNE FOIS OUVERT. NE PAS REGARDER DIRECTEMENT AVEC DES INSTRUMENTS OPTIQUES. (FRA)	<b>AVISO</b> RADIACIÓN LÁSER DE CLASE 1M VISIBLE Y/O INVISIBLE CUANDO ESTÁ ABIERTO. NO MIRAR DIRECTAMENTE CON INSTRUMENTAL ÓPTICO. (ESP)	<b>VARNING</b> SYNLIG OCH/ELLER OSYNLIG LASERSTRÅLNING, KLASS 1M, NÅR DENNA DEL ÄR ÖPPNAD. BETRAKTA EJ STRÅLEN MED OPTISKA INSTRUMENT. (SWE)	<b>注意</b> ここを開くと可視 及び/または不可視 のクラス1M レーザー放射が 出ます。 光学装置で直接 見ないでください。 (JPN)	<b>CAUTION</b> VISIBLE AND/OR INVISIBLE CLASS II LASER RADIATION WHEN OPEN. DO NOT STARE INTO BEAM. FDA 21 CFR (ENG) LV44603-003A
--	---	--	--	--	---

### INFORMATION (For U.S.A.)

This equipment has been tested and found to comply with the limits for a Class B digital device, pursuant to Part 15 of the FCC Rules. These limits are designed to provide reasonable protection against harmful interference in a residential installation. This equipment generates, uses, and can radiate radio frequency energy and, if not installed and used in accordance with the instructions, may cause harmful interference to radio communications. However, there is no guarantee that interference will not occur in a particular installation. If this equipment does cause harmful interference to radio or television reception, which can be determined by turning the equipment off and on, the user is encouraged to try to correct the interference by one or more of the following measures:

- Reorient or relocate the receiving antenna.
- Increase the separation between the equipment and receiver.
- Connect the equipment into an outlet on a circuit different from that to which the receiver is connected.
- Consult the dealer or an experienced radio/TV technician for help.

### Caution

Changes or modifications not approved by JVC could void the user's authority to operate the equipment.



[European Union only]

### WARNINGS:

#### To prevent accidents and damage

- DO NOT install any unit or wire any cable in a location where;
  - it may obstruct the steering wheel and gearshift lever operations.
  - it may obstruct the operation of safety devices such as air bags.
  - it may obstruct visibility.
- DO NOT operate the unit while driving. If you need to operate the unit while driving, be sure to look around carefully.
- The driver must not watch the monitor while driving.
- The driver must not put on the headphones while driving.

### Cautions on the monitor:

- The monitor built in this unit has been produced with high precision, but it may have some ineffective dots. This is inevitable and is not malfunction.
- Do not expose the monitor to direct sunlight.
- When the temperature is very cold or very hot...
  - Chemical changes occur inside, causing malfunction.
  - Pictures may not appear clearly or may move slowly. Pictures may not be synchronized with the sound or picture quality may decline in such environments.

## How to reset your unit

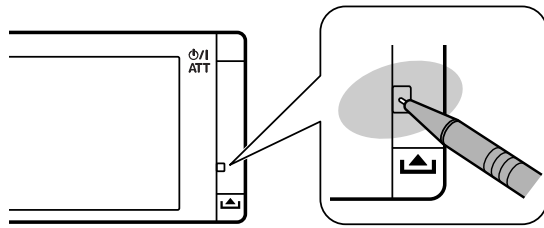

- Your preset adjustments (except for the registered Bluetooth devices) will also be erased.

## How to forcibly eject a disc

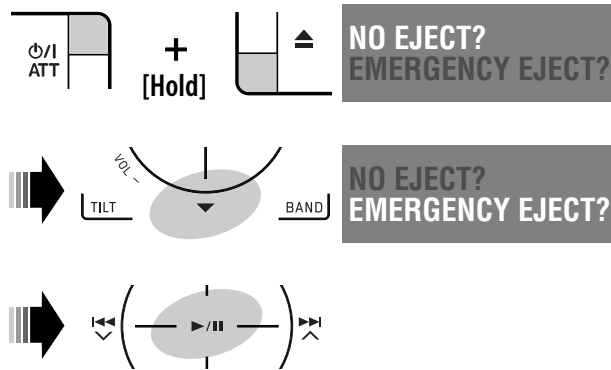

- If this does not work, reset the unit.

### For safety...

- Do not raise the volume level too much, as this will block outside sounds, making driving dangerous.
- Stop the car before performing any complicated operations.

### Temperature inside the car...

If you have parked the car for a long time in hot or cold weather, wait until the temperature in the car becomes normal before operating the unit.

This product incorporates copyright protection technology that is protected by U.S. patents and other intellectual property rights. Use of this copyright protection technology must be authorized by Macrovision, and is intended for home and other limited viewing uses only unless otherwise authorized by Macrovision. Reverse engineering or disassembly is prohibited.

# Contents

## INTRODUCTION

Playable disc type .....	4
Before operations .....	5

## OPERATIONS

Basic operations—AV menu .....	6
Basic operations—Control panel .....	8
Basic operations— Remote controller (RM-RK252) .....	10
Listening to the radio .....	12
Disc operations .....	14
Dual Zone operations .....	26
USB operations .....	29
Bluetooth® operations— Cellular phone/audio player .....	31

## EXTERNAL DEVICES

Listening to the iPod .....	38
Listening to the CD changer .....	41
Listening to the satellite radio .....	43
Listening to the HD Radio™ Broadcast .....	46
Listening to other external components .....	48

## SETTINGS

Sound equalization .....	50
Assigning titles to the sources .....	51
Menu items .....	52

## REFERENCES

Maintenance .....	61
More about this unit .....	62
Troubleshooting .....	68
Specifications .....	74

# Playable disc type

Disc type	Recording format, file type, etc.	Playable
DVD	DVD Video (Region Code: 1)* <sup>1</sup> 	✓OK
	DVD Audio	✗NO
	DVD-ROM	✗NO
<b>DVD Recordable/Rewritable</b> (DVD-R/-RW* <sup>2</sup> , +R/+RW* <sup>3</sup> ) <ul style="list-style-type: none"> <li>• DVD Video: UDF bridge</li> <li>• DVD-VR</li> <li>• DivX/MPEG1/MPEG2/JPEG/MP3/WMA/WAV/ AAC: Compliant to ISO 9660 level 1, level 2, Romeo, Joliet</li> </ul>	DVD Video	✓OK
	DVD-VR	
	DivX/MPEG1/MPEG2	
	JPEG	
	MP3/WMA/WAV/AAC* <sup>4</sup>	✗NO
	MPEG4	
	DVD+VR	
DVD-RAM	✗NO	
DualDisc	DVD side	✓OK
	Non-DVD side	✗NO
CD/VCD	Audio CD/CD Text (CD-DA)/DTS-CD	✓OK
	VCD (Video CD)	✗NO
	SVCD (Super Video CD)	
	CD-ROM	
	CD-I (CD-I Ready)	
<b>CD Recordable/Rewritable</b> (CD-R/-RW) <ul style="list-style-type: none"> <li>• Compliant to ISO 9660 level 1, level 2, Romeo, Joliet</li> </ul>	CD-DA	✓OK
	MP3/WMA/WAV/AAC* <sup>4</sup>	
	JPEG	
	DivX/MPEG1/MPEG2	
	MPEG4	✗NO

\*<sup>1</sup> If you insert a DVD Video disc of an incorrect Region Code, "Region code error" appears on the monitor.

\*<sup>2</sup> DVD-R recorded in multi-border format is also playable (except for dual layer discs).  
DVD-RW dual layer discs are not playable.

\*<sup>3</sup> It is possible to play back finalized +R/+RW (Video format only) discs.  
+RW double layer discs are not playable.

\*<sup>4</sup> This unit can play back AAC files encoded using iTunes.

### Caution for DualDisc playback

The Non-DVD side of a "DualDisc" does not comply with the "Compact Disc Digital Audio" standard. Therefore, the use of Non-DVD side of a DualDisc on this product may not be recommended.

# Before operations

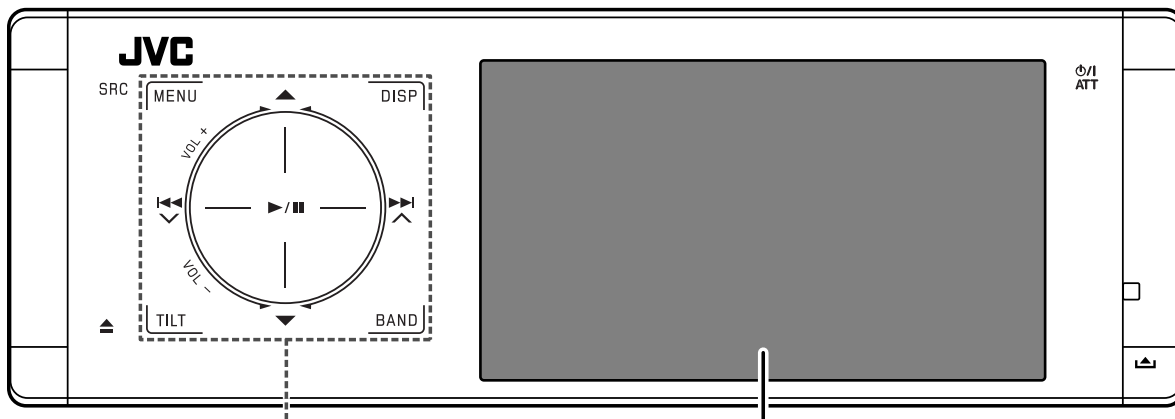

Touch pad controls

Monitor

The lights of the touch pad controls and monitor are turned off when no operation is done for about 10 seconds.

The lights are turned on in the following cases:

- When you move your hand close to the touch pad controls.\*
- When your finger touches the touch pad controls.\*
- When you use the remote controller.
- When a call/text message comes in.
- When the signal from the rear view camera comes in.

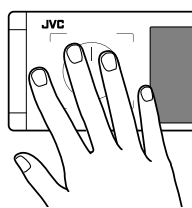

\* Depending on the setting. To change the setting, page 57.

The lights are always turned on in the following cases:

- While **<AV Menu>** is displayed.
- While **<Source Menu>** is displayed.
- While the control panel is open.
- When **<Illumination>** is set to **<Normal>**. ( page 57)

## How to operate the unit by the touch pad controls

You can operate the unit by touching the appropriate part of the touch pad controls.

- To adjust the volume, move your finger on the touch pad knob as illustrated below to display the animation on the monitor, then press ▲ or ▼ repeatedly.
  - You can also adjust the volume by just continuing to move your finger on the touch pad knobs as illustrated below.

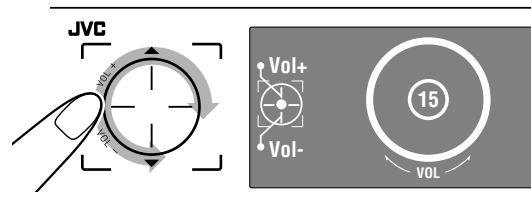

- When you slide your finger on the touch pad knob as illustrated below, it functions in the same way as touching ▲ / ▼ / ◀◀ / ▶▶.

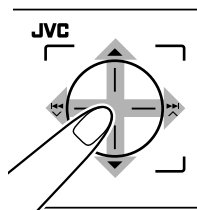

- Operations are explained mainly using the touch pad controls and buttons of the unit; however, the buttons on the remote controller can work in the same way if they have the same names or marks.
- In the explanation, the screen names are highlighted. For example, **<AV Menu>**.

# Basic operations— AV menu

You can use the menus to set up various settings from **<AV Menu>**. For details of each menu and setting, see “Menu items.” (pages 52 to 60)

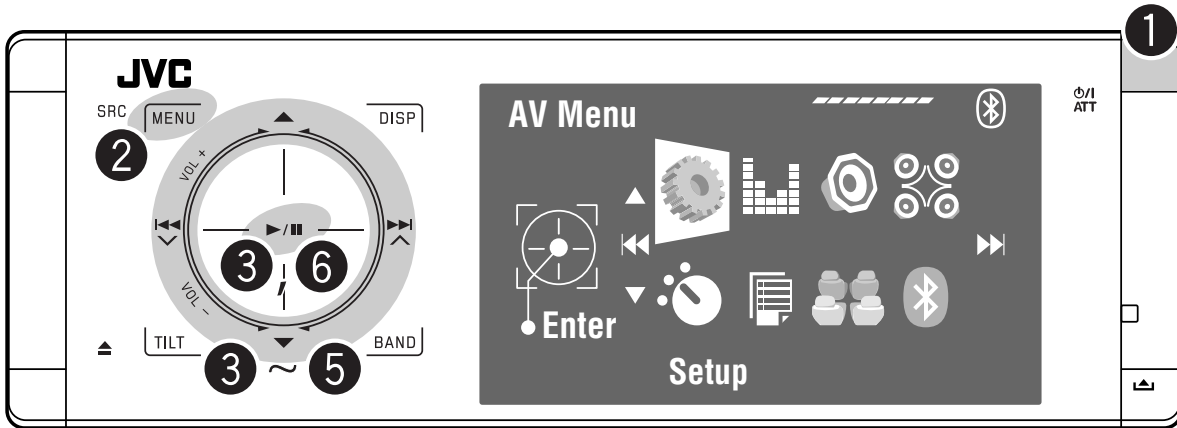

**1 Turn on the power.**

The lights of the touch pad controls and monitor are turned on.

**2 Enter <AV Menu>.**

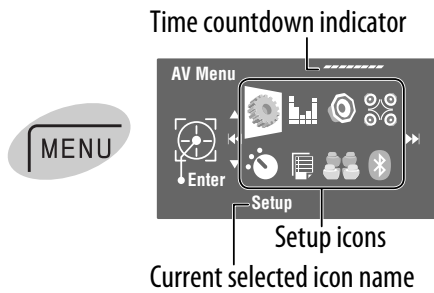

- Non-available items will be shaded.

**3 Select an icon to enter the setup screen.**

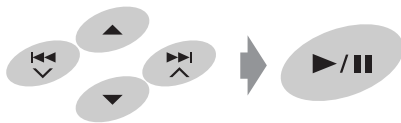

**4 Select an item.**

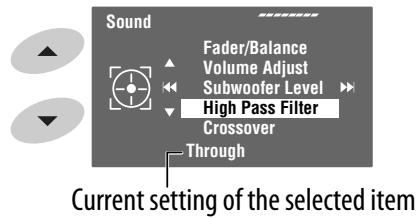

**5 Enter the next screen.**

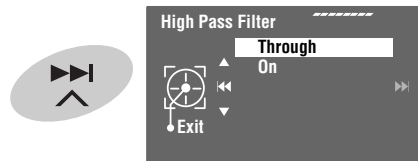

- To return to the previous screen:
- Repeat steps 4 and 5 to set the sub-item if needed.

**6 Finish the procedure.**



In this manual, English indications are used for purpose of explanation. You can select the indication language on the monitor. (page 53)

# Canceling the display demonstration and setting the clock

ENGLISH

1



2

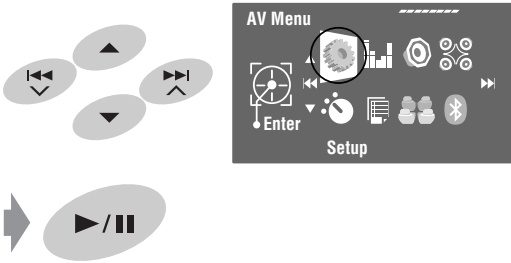

3

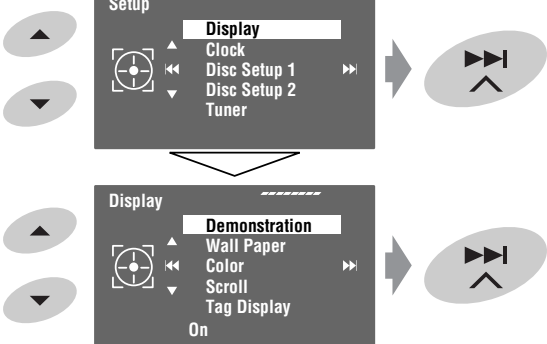

4

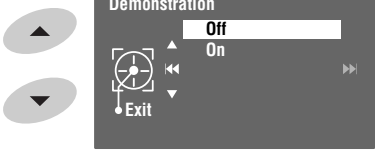

5 Return to **<Setup>** by touching **◀◀** repeatedly.

6

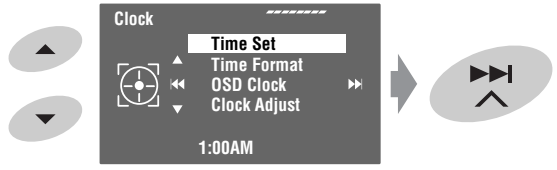
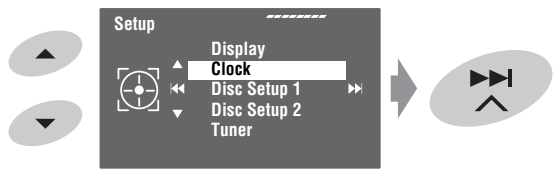

7

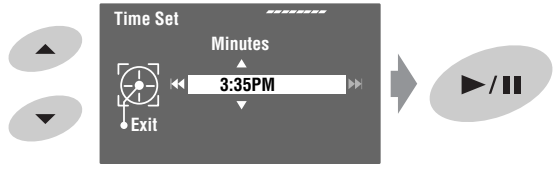

# Basic operations — Control panel

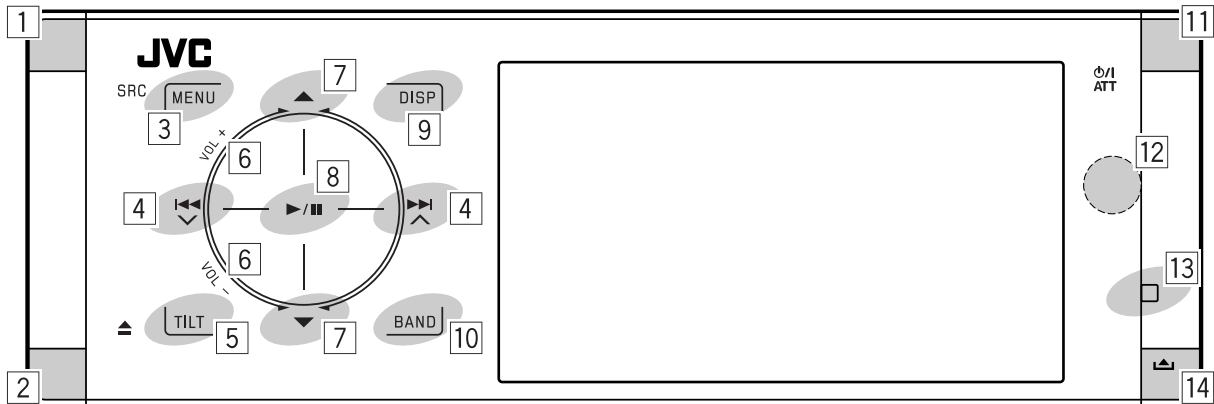

- 1 Selects sources.\*1  
 "Tuner" or "HD Radio" → "Satellite Radio (SIRIUS/XM)" → "Disc" → "USB" or "USB iPod" → "Changer," "iPod," or "External Input" → "Bluetooth" → "AV Input"  
 • You can also select sources by touching ▲ / ▼ / |◀◀ / ▶▶| after holding SRC for entering <Source Menu>.
- 2 • Ejects the disc.
- 3 • Enters or exits <AV Menu>.  
 • Activates Voice Dialling [Hold].  
 • While talking: Adjusts the built-in microphone volume.
- 4 • "Tuner" and "HR Radio": Searches for stations.  
 • "Satellite Radio": Selects channels.  
 • "Disc," "USB," "USB iPod," "Changer," "iPod," and "Bluetooth": Reverse skip/forward skip  
 • On menus:  
 – Enters the previous/next screen.  
 – Selects items.
- 5 Tilts the control panel. (☞ page 9)
- 6 Adjusts the volume level. (☞ page 5)
- 7\*2 • "Tuner": Selects preset stations.  
 • "HD Radio": Selects multicast channels.  
 • "Satellite Radio": Selects categories.  
 • "Disc," "USB," and "Changer": Selects titles/folders.  
 • "USB iPod": Selects the next/previous items.  
 • "iPod": Enters the player's menu and pauses playback.  
 • "Bluetooth": Selects group/folder.  
 • On menus: Selects items.
- 8 • "Disc," "USB," "USB iPod," and "Changer": Starts and pauses playback.  
 • "Bluetooth": Starts playback.  
 • On menus: Enters the next screen or exits the displayed screen.
- 9 Changes the display information. (☞ page 9)
- 10 • "Tuner," "HD Radio," and "Satellite Radio": Selects the bands.  
 • "Disc" and "USB": Stops playback.  
 • "Bluetooth": Pauses playback.
- 11 • Turns on the power.  
 • Turns off the power [Hold].  
 • Attenuates the sound (when the power is on).
- 12 Remote sensor
- 13 Resets the unit.  
 • Use only when the internal system malfunctions.
- 14 Detaches the control panel. (☞ page 9)

\*1 You cannot select these sources if they are not ready.

\*2 By holding ▲ / ▼, you can display the list accessible for the selected source.



**To tilt the control panel**

Touch TILT repeatedly.

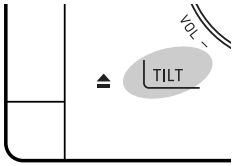

**To attach the control panel**

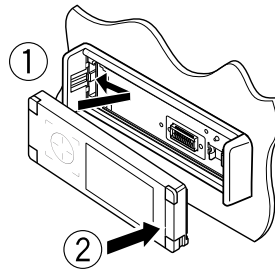

**Changing the display information**

Available display information varies among the playback sources.

Each time you touch **DISP**, the display changes to show the various information.



Ex.: When the playback source is a DVD video disc.

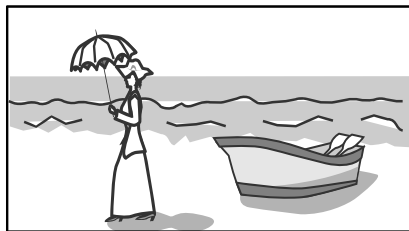

Playback picture screen (only for video sources)

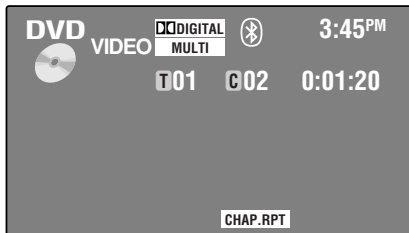

Source information screen

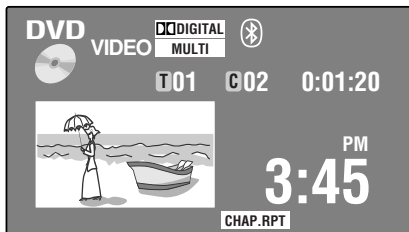

Playback picture and the source information screen



Navigation screen

- This screen is displayed when <Navigation> is selected for <AV Input>. (☞ page 56)

Back to the beginning

# Basic operations — Remote controller (RM-RK252)

ENGLISH

## Installing the battery

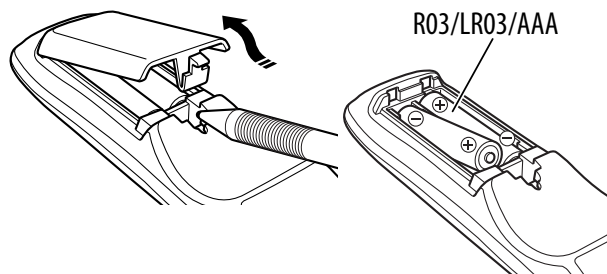

Insert the batteries into the remote controller by matching the polarity (+ and -) correctly.

### Caution:

Battery shall not be exposed to excessive heat such as sunshine, fire or the like.

If the range or effectiveness of the remote controller decreases, replace both batteries.

### Before using the remote controller:

- Aim the remote controller directly at the remote sensor on the unit.
- DO NOT expose the remote sensor to bright light (direct sunlight or artificial lighting).

The unit is equipped with the steering wheel remote control function.

- See the Installation/Connection Manual (separate volume) for connection.

### IMPORTANT:

When Dual Zone is activated (☞ page 26), the remote controller functions only for operating the DVD/CD player.

## Main elements and features

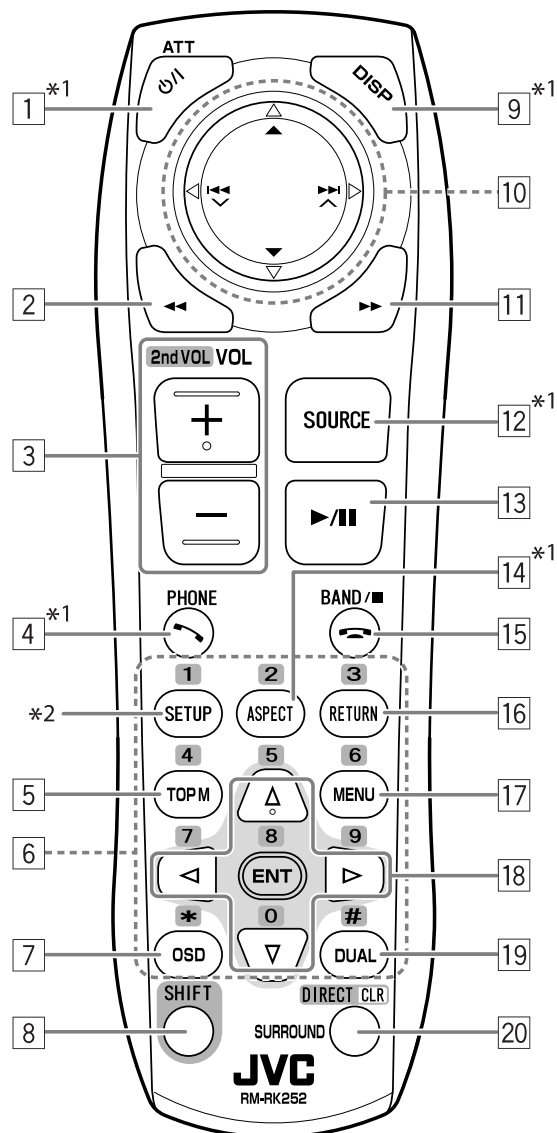

- Turns on the power.  
• Turns off the power [**Hold**].  
• Attenuates the sound (when the power is on).
- “Disc,” “USB,” and “USB iPod”: Reverse search
- Adjusts the volume level.  
• Adjusts the volume level through the 2nd AUDIO OUT plug (while holding SHIFT). (☞ page 26)
- Answers incoming calls.  
• Enters **<Redial>** [**Hold**].  
• You can enter **<Dial Menu>** by pressing the button then touching **▶/||** on the unit.
- DVD/DivX 6: Displays the disc menu.  
• VCD: Resumes PBC playback (☞ page 21).  
• DVD-VR: Displays the Original Program screen.

- 6 • Enters numbers (while holding SHIFT). (☞ pages 13, 19 to 22, 36, and 45)
  - Selects the preset phone number.
  - “Tuner,” “HD Radio,” and “Satellite Radio”:  
Selects the preset stations.
- 7 Displays the on-screen bar.
- 8 Functions with other buttons (see 3, 6, and 20)
- 9 Displays the display information.
- 10 “Tuner”:  
  - ▲ / ▼: Selects preset stations.
  - ◀◀ / ▶▶: Searches for stations.
    - Auto Search
    - Manual Search [Hold]
- “HD Radio”:  
  - ▲ / ▼: Selects multicast channels.
  - ◀◀ / ▶▶: Searches for stations.
    - Auto Search
    - Manual Search [Hold]
- “Satellite Radio”:  
  - ▲ / ▼: Selects categories.
  - ◀◀ / ▶▶:  
    - Selects channels.
    - Selects channels rapidly. [Hold]
- “Disc” and “Changer”:  
  - ▲ / ▼:  
    - DVD: Selects the title.
    - DVD-VR: Selects the program/play list.
    - Other discs (except VCD/CD): Selects the folders.
  - ◀◀ / ▶▶:  
    - Reverse skip/forward skip
    - Reverse search/forward search [Hold]
- “USB”:  
  - ▲ / ▼: Selects the folders.
  - ◀◀ / ▶▶:  
    - Reverse skip/forward skip
    - Reverse search/forward search [Hold]
- “USB iPod”:  
  - ▲ / ▼: Selects previous/next item.
  - ◀◀ / ▶▶:  
    - Reverse skip/forward skip
    - Reverse search/forward search [Hold]
- “iPod”:  
  - ▼: Pauses or resumes playback.
  - ▲: Enters the main menu (then ▲ / ▼ / ◀◀ / ▶▶ work as the menu selecting buttons).<sup>\*3</sup>

- ◀◀ / ▶▶:  
    - Reverse skip/forward skip
    - Reverse search/forward search [Hold]
  - In menu selecting mode:  
    - Selects an item. (Then, press ▼ to confirm the selection.)
    - Skips 10 items at a time [Hold].
  - “Bluetooth”:  
    - ▲ / ▼: Selects group/folder.
    - ◀◀ / ▶▶:  
      - Reverse skip/forward skip
      - Reverse search/forward search [Hold]
  - 11 “Disc,” “USB,” and “USB iPod”: Forward search
  - 12 Selects the source.
  - 13 • “Disc,” “USB,” and “USB iPod”: Starts and pauses playback.
    - “Bluetooth”: Starts playback.
    - Answers incoming calls.
  - 14 Changes the aspect ratio of the playback pictures.
  - 15 • “Tuner,” “HD Radio,” and “Satellite Radio”:  
Selects the bands.
    - “Disc” and “USB”: Stops playback.
    - “Bluetooth”: Pauses playback.
    - Ends the call.
  - 16 VCD: Returns to the PBC menu.
  - 17 • DVD Video/DivX 6: Displays the disc menu.
    - VCD: Resumes PBC playback. (☞ page 21)
    - DVD-VR: Displays the Play List screen.
  - 18 • Makes selection/settings.
    - ◀ / ▶: Skips back or forward by 5 minutes for DivX/MPEG1/MPEG2.
    - △ / ▽: Changes discs for “Changer.”
  - 19 Activates or deactivates Dual Zone.
  - 20 • Changes the surround mode.<sup>\*1</sup> (☞ page 23)
    - “Disc” and “USB”: Switches the number entry mode (while holding SHIFT).
    - Erases the misentry after entering a wrong number (while holding SHIFT).
- <sup>\*1</sup> When Dual Zone is activated, these buttons cannot be used.
- <sup>\*2</sup> Functions as a number button only (see 6).
- <sup>\*3</sup> ▲ : Returns to the previous menu.  
▼ : Confirms the selection.

# Listening to the radio

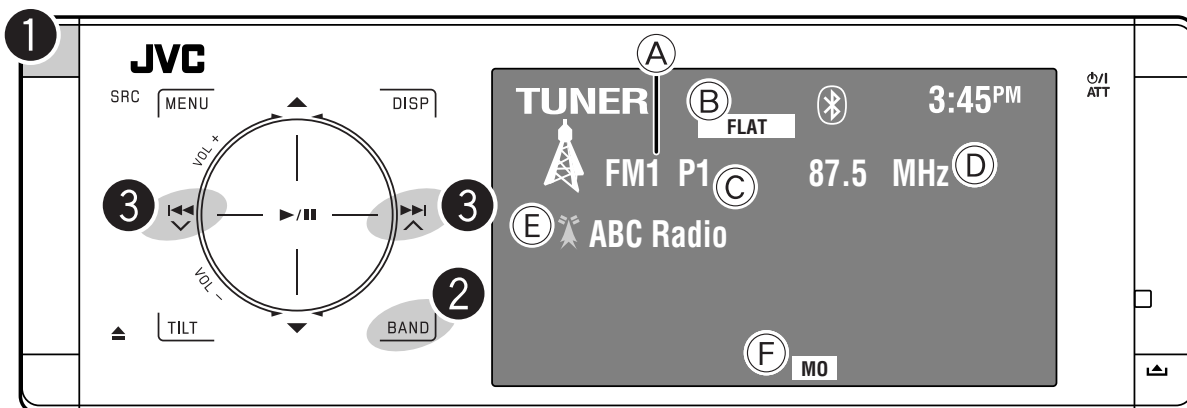

- (A) Band
- (B) Sound mode (see page 50)
- (C) Preset no.
- (D) Frequency
- (E) Assigned station name (see page 51)
- (F) FM reception indicator

**1** Select "Tuner."

**2** Select the band.

→ FM1 → FM2 → FM3 → AM

**3** Search for a station—Auto Search.

- Manual Search: Hold either ◀◀ or ▶▶ until "Manual Search" appears on the monitor, then touch it repeatedly.
- The ST indicator lights up when receiving an FM stereo broadcast with sufficient signal strength.

## When an FM stereo broadcast is hard to receive

**1**



**2**

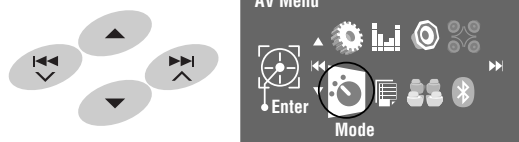

**3**

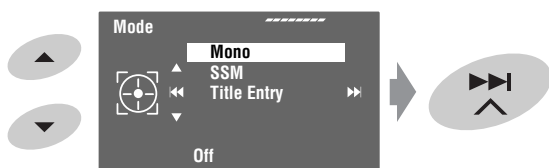

**4**



Reception improves, but the stereo effect will be lost.

- The MO indicator lights up.

To restore the stereo effect, select <Off> in step 4.

## FM station automatic presetting —SSM (Strong-station Sequential Memory)

This function works only for FM bands. You can preset six stations for each band.

**1**



2

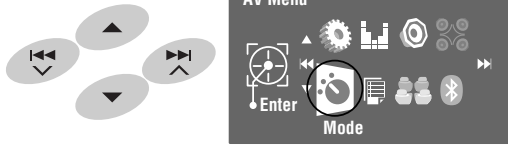

3



Local FM stations with the strongest signals are searched and stored automatically in the FM band.

- When an HD Radio tuner box is connected (page 46), you can also search and store the AM station automatically.

## Manual presetting

Ex.: Storing the FM station of 92.5 MHz into preset number 4 of the FM1 band.

1



2 Tune in to a station you want to preset.



3

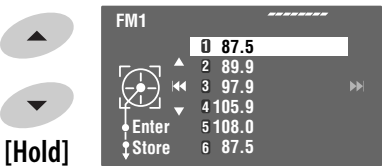

The Preset List appears

- For FM: Each time you hold ▲ / ▼, you can change the bands.

4 Select a preset number.

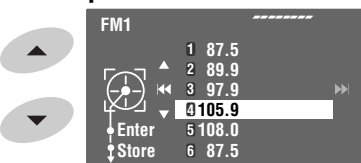

5 Store the station.

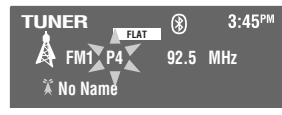

The station selected in step 2 is now stored in preset number 4.

## Selecting preset stations

On the remote:

1

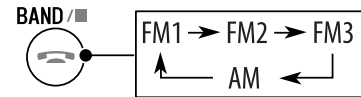

2



On the unit:

To select directly

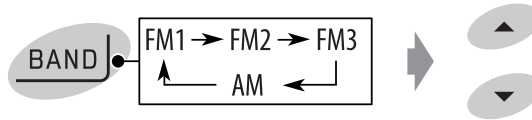

To select from the Preset List

1

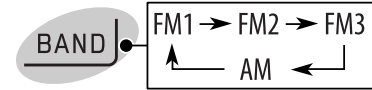

2

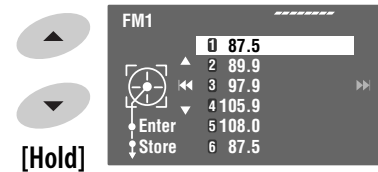

- For FM: Each time you hold ▲ / ▼, you can change the bands.

3 Select the preset number.

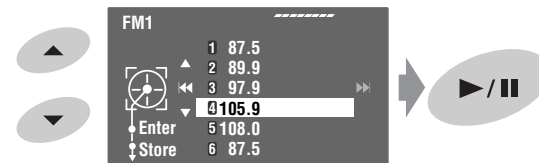

The Preset List can also be accessed through **<AV Menu>** → **<List>**.

## Disc operations

The disc type is automatically detected, and playback starts automatically (for some discs: automatic start depends on its internal program).

If a disc does not have any disc menu, all tracks in it will be played repeatedly until you change the source or eject the disc.

If "⊘" appears on the monitor, the unit cannot accept the operation you have tried to do.

- In some cases, without showing "⊘," operations will not be accepted.

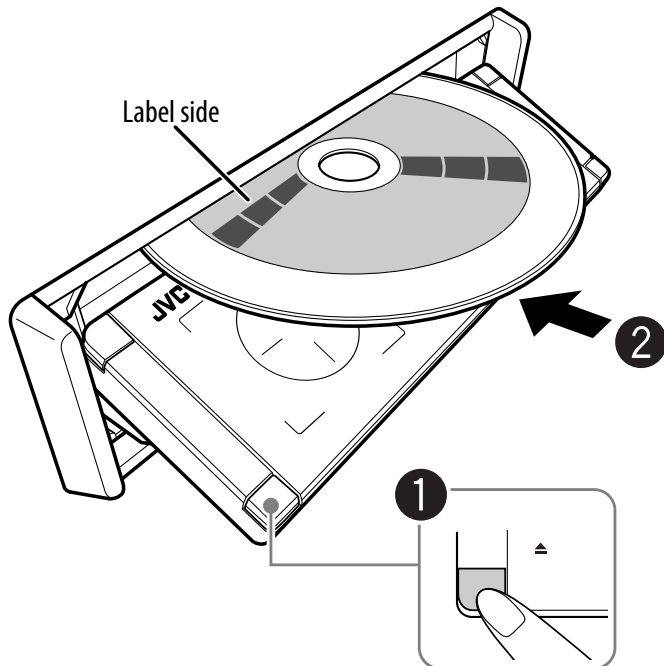

**1** Open the front panel.

**2** Insert the disc.

Playback starts automatically.

### Caution:

Do not place your finger behind the control panel.

### Caution on volume setting:

Discs and connected USB devices produce very little noise compared with other sources. Lower the volume before playing a disc to avoid damaging the speakers by the sudden increase of the output level.

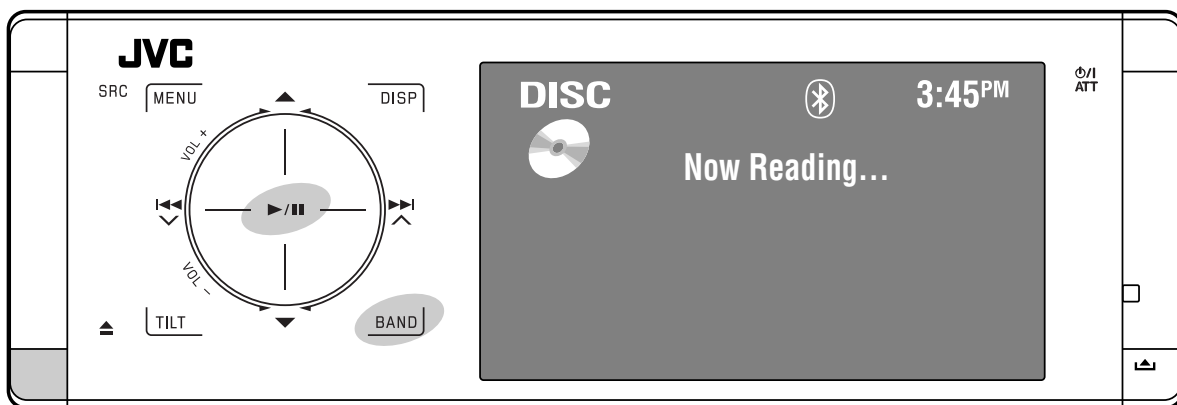

- ▲: Ejects the disc.
- ▶/||: Starts and pauses playback.
- BAND: Stops playback.

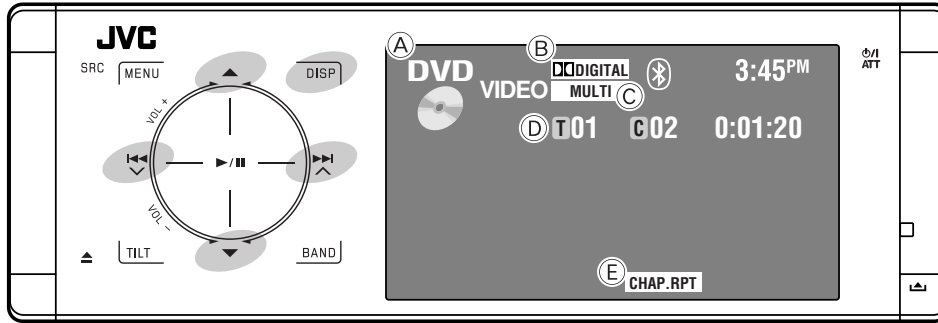

◀◀▶▶: Touch: Selects chapter.  
Hold: Reverse/forward search\*1

▲ ▼: Selects title.

DISP: Touch if necessary (☞ page 9).

- Ⓐ Disc type
- Ⓑ Audio format
- Ⓒ Sound/surround mode (☞ pages 22 and 50)
- Ⓓ Title no./Chapter no./Playing time
- Ⓔ Playback mode

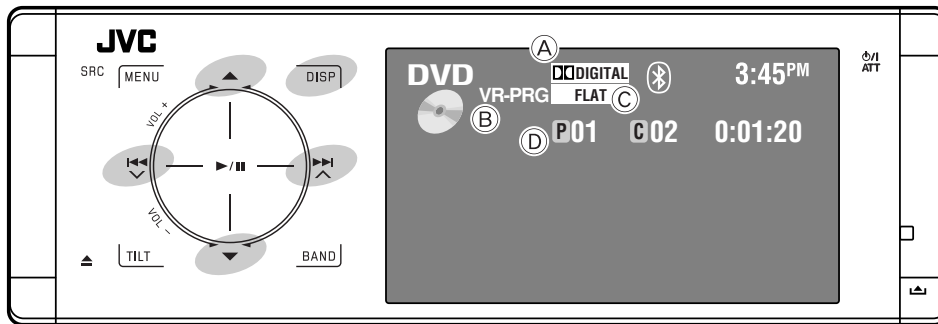

◀◀▶▶: Touch: Selects chapter.  
Hold: Reverse/forward search\*1

▲ ▼: Selects program no./Play List no.

DISP: Touch if necessary (☞ page 9).

- Ⓐ Audio format
- Ⓑ VR-PRG: Original program  
VR-PL: Play List
- Ⓒ Sound/surround mode (☞ pages 22 and 50)
- Ⓓ Program no. (or Play List no.)/Chapter no./Playing time

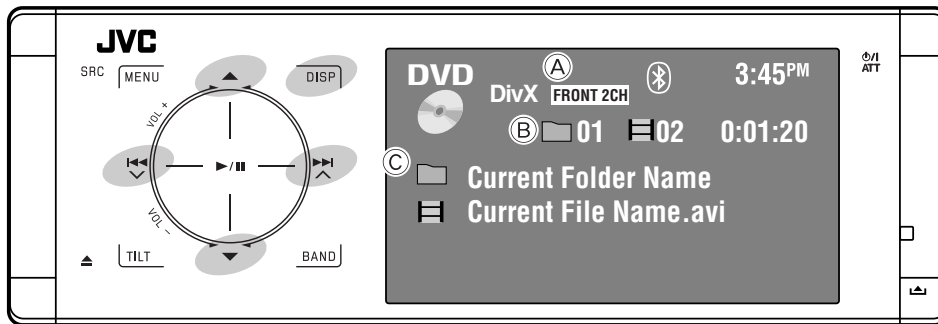
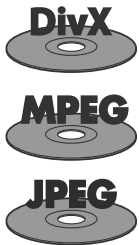

◀◀▶▶: Touch: Selects track.  
Hold: Reverse/forward search for DivX/MPEG\*2

▲ ▼: Touch: Selects folder.  
Hold: Displays Folder List.

DISP: Touch if necessary (☞ page 9).

- Ⓐ Sound/surround mode (☞ pages 22 and 50)
- Ⓑ For DivX/MPEG: Folder no./Track no./Playing time  
For JPEG: Folder no./File no.
- Ⓒ Current folder name/current file name

\*1 Search speed: x2 ⇔ x10

\*2 Search speed: ▶▶ 1 ⇔ ▶▶▶ 2

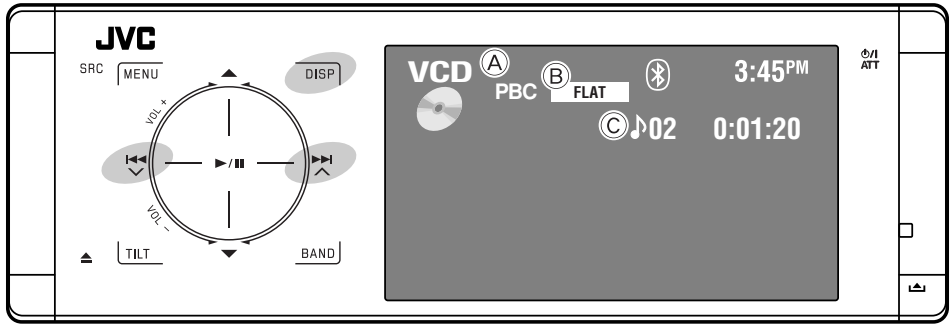

◀◀▶▶▶▶: Touch: Selects track.  
Hold: Reverse/forward search\*1

DISP: Touch if necessary (☞ page 9)

- (A) PBC indicator lights up when PBC is in use.
- (B) Sound/surround mode (☞ pages 22 and 50)
- (C) Track no./Playing time

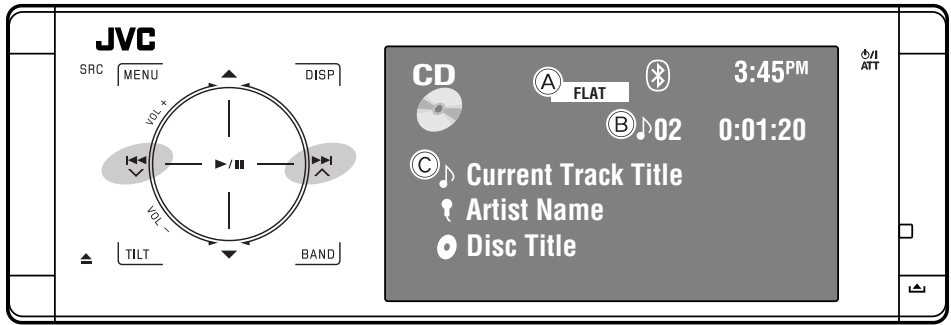

◀◀▶▶▶▶: Touch: Selects track.  
Hold: Reverse/forward search\*1

- (A) Sound/surround mode (☞ pages 22 and 50)
- (B) Track no./Playing time
- (C) Track title (only for CD Text)/Artist Name/Disc title\*2

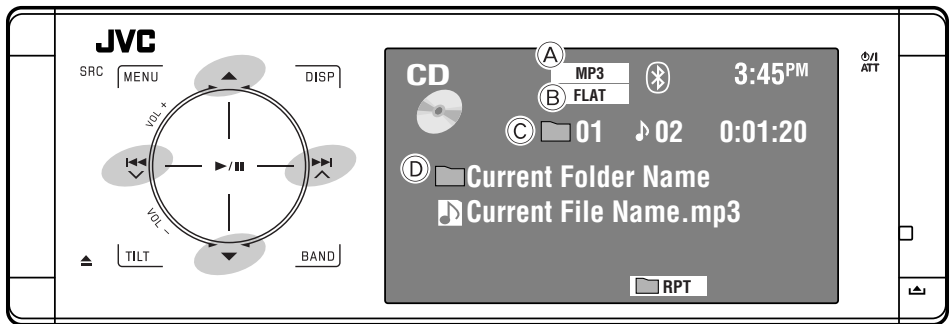

◀◀▶▶▶▶: Touch: Selects track.  
Hold: Reverse/forward search\*1

▲ ▼: Touch: Selects folder.  
Hold: Displays Folder List.

- (A) Audio format (MP3/WMA/WAV/AAC)
- (B) Sound/surround mode (☞ pages 22 and 50)
- (C) Folder no./Track no./Playing time
- (D) Current folder name/current file name\*3

\*1 Search speed: x2 ⇔ x10

\*2 "No Name" appears for conventional CDs.

\*3 Tag data will be shown instead of folder/file names when they are recorded and <Tag Display> is set to <On>. (☞ page 52)



# Selecting playback modes

You can use Repeat or Random playback mode.

Ex.: To select Track Repeat

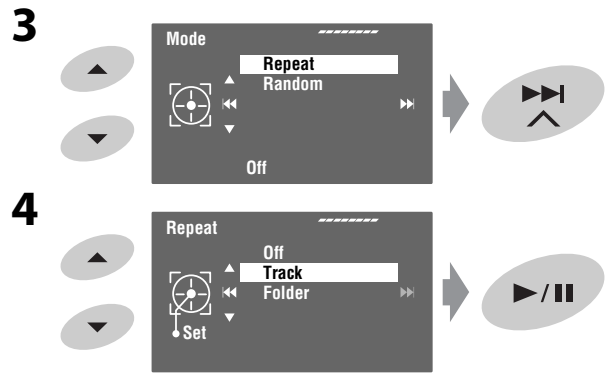
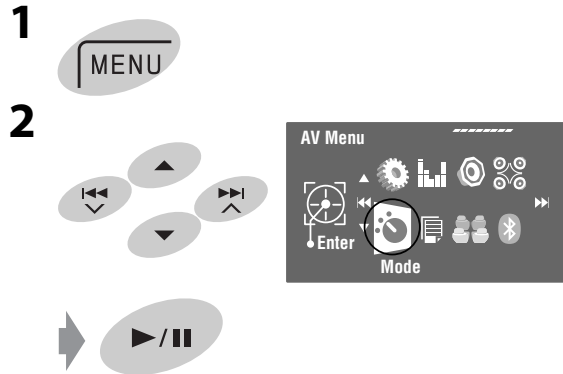

When one of the playback modes is selected, the corresponding indicator lights up on the source information screen.

To cancel, select <Off> in step 4.

ENGLISH

Disc type	Repeat	Random
	<b>Chapter:</b> Repeats current chapter. <b>Title:</b> Repeats current title.	—
	<b>Chapter:</b> Repeats current chapter. <b>Program:</b> Repeats current program (not available for Playlist playback).	—
 	<b>Track:</b> Repeats current track (for VCD: PBC not in use).	<b>Disc (All):</b> Randomly plays all tracks (for VCD: PBC not in use).
	<b>Track:</b> Repeats current track. <b>Folder:</b> Repeats all tracks of the current folder.	<b>Folder:</b> Randomly plays all tracks of current folder, then tracks of next folders. <b>Disc (All):</b> Randomly plays all tracks.
 	<b>Track:</b> Repeats current track. <b>Folder:</b> Repeats all tracks of the current folder.	<b>Folder:</b> Randomly plays all tracks of current folder, then tracks of next folders. <b>Disc (All):</b> Randomly plays all tracks.
	<b>Folder:</b> Repeats all tracks of the current folder.	—

## Selecting tracks on the list

If a disc includes folders, you can display the Folder/Track (File) Lists, then start playback.

### 1 Enter <Folder List>.



- Hold the button to display the next/previous folders.

### 2 Select a folder.

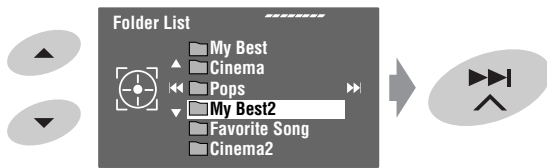

### 3 Select a file.

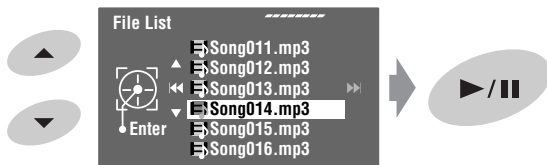

The Folder List can also be accessed through <AV Menu> → <List>.

## Prohibiting disc ejection

You can lock a disc in the loading slot.

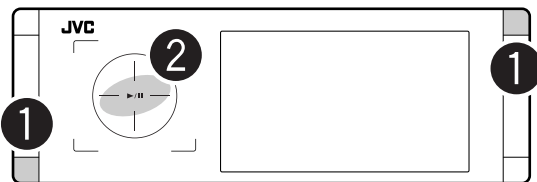

### 1 Hold the buttons at the same time.



### 2 Activate the prohibition.

"No Eject" appears.

To cancel the prohibition, repeat the same procedure to select <EJECT OK?>.

## Operations using the remote controller—RM-RK252

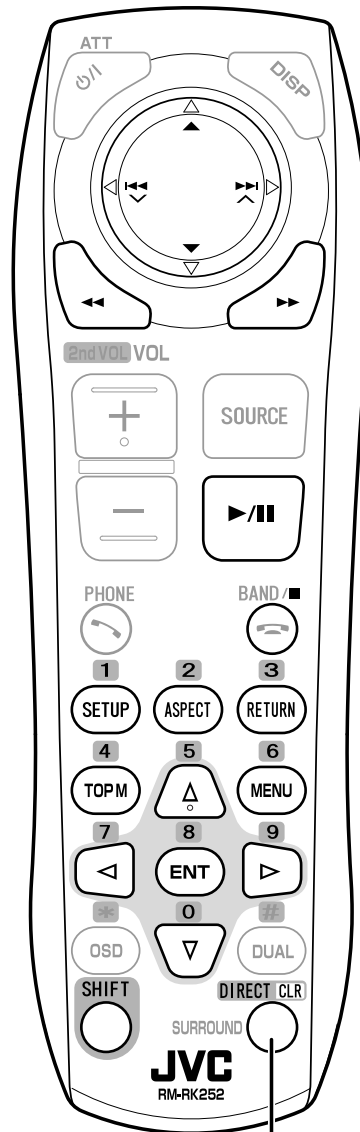

Also functions as CLR (clear): Erases a misentry if pressed while holding SHIFT.



	Stops playback.
	Starts or pauses playback.
	<ul style="list-style-type: none"> <li>Reverse/forward search*<sup>1</sup> (No sound can be heard.)</li> <li>Slow motion*<sup>2</sup> during pause. (No sound can be heard.)</li> </ul>
	<ul style="list-style-type: none"> <li>Selects chapter (during playback or pause).</li> <li>Reverse/forward search*<sup>3</sup> [Hold]</li> </ul>
	Selects title (during playback or pause).
	<ul style="list-style-type: none"> <li>Selects chapter.</li> <li>Selects title (when not playing).</li> </ul>
	<ul style="list-style-type: none"> <li>Selects chapter.</li> <li>Selects program (when not playing).</li> </ul>
	Changes the aspect ratio of the playback pictures.

### Using menu driven features

- 
- Select an item you want to start playback.
- 



	Stops playback.
	Starts or pauses playback.
	<ul style="list-style-type: none"> <li>Reverse/forward search*<sup>1</sup> (No sound can be heard.)</li> <li>Forward slow motion*<sup>2</sup> during pause. (No sound can be heard.)</li> <li>Reverse slow motion does not work.</li> </ul>
	<ul style="list-style-type: none"> <li>Select chapter (during playback or pause).</li> <li>Reverse/forward search*<sup>3</sup> [Hold]</li> </ul>
	<ul style="list-style-type: none"> <li>Selects program.</li> <li>Selects Play List (during playback or pause).</li> </ul>
	<ul style="list-style-type: none"> <li>Selects chapter.</li> <li>Selects program (when not playing).</li> </ul>
	<ul style="list-style-type: none"> <li>Selects program/Play List (during playback or pause).</li> </ul>
	Changes the aspect ratio of the playback pictures.

### Using Original Program/Play List screens (page 28)

- For Original Programs:
- For Play List:
- Select the item you want to start playback.
- 

\*<sup>1</sup> Search speed: x2 ⇨ x5 ⇨ x10 ⇨ x20 ⇨ x60

\*<sup>2</sup> Slow motion speed: 1/32 ⇨ 1/16 ⇨ 1/8 ⇨ 1/4 ⇨ 1/2

\*<sup>3</sup> Search speed: x2 ⇨ x10

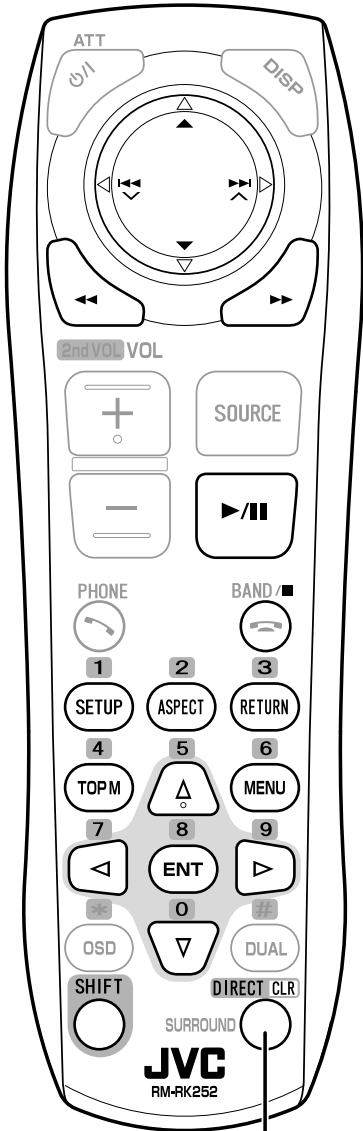

Also functions as CLR (clear):  
Erases a misentry if pressed while  
holding SHIFT.



	Stops playback.
	Starts or pauses playback.
	Reverse/forward search*1 (No sound can be heard.)
	<ul style="list-style-type: none"> <li>Selects track.</li> <li>Reverse/forward search*2 [Hold] (No sound can be heard.)</li> </ul>
	Selects folder.
	Selects track (within the same folder).
	[Twice] Selects folder.
	Changes the aspect ratio of the playback pictures.

**While playing...**

Back/advance the scenes by 5 minutes.

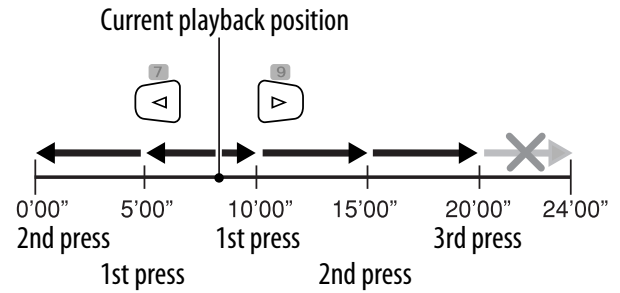

**For DivX6: Using menu driven features**

- 
- Select the item you want to start playback.
-



	Stops playback.
	Starts or pauses playback. (Slide show: each file is shown for a few seconds.) Shows the current file until you change it if pressed during Slide show.
	Selects track.
	Selects folder.
	Selects track (within the same folder).
	Selects folder.
	Changes the aspect ratio of the playback pictures.



	Stops playback.
	Starts or pauses playback.
	<ul style="list-style-type: none"> <li>Reverse/forward search*3</li> <li>Forward slow motion*4 during pause. (No sound can be heard.)</li> <li>Reverse slow motion does not work.</li> </ul>
	<ul style="list-style-type: none"> <li>Selects track.</li> <li>Reverse/forward search*5 [Hold] (No sound can be heard.)</li> </ul>
	Selects track.
	Changes the aspect ratio of the playback pictures.

### During PBC playback...

	Selects an item on the menu.
	Returns to the previous menu.

### To cancel PBC playback

- 
- Start the desired track.

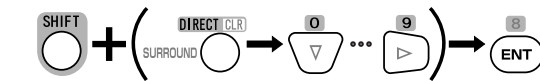

### To resume PBC:



	Stops playback.
	Starts or pauses playback.
	Reverse/forward search*3
	<ul style="list-style-type: none"> <li>Selects track.</li> <li>Reverse/forward search*5 [Hold]</li> </ul>
	Selects folder.
	Selects track (within the same folder).
	Selects folder.

\*1 Search speed: ►►1 ⇌ ►►►2 ⇌ ►►►►3

\*2 Search speed: ►►►1 ⇌ ►►►►2

\*3 Search speed: x2 ⇌ x5 ⇌ x10 ⇌ x20 ⇌ x60

\*4 Slow motion speed: 1/32 ⇌ 1/16 ⇌ 1/8 ⇌ 1/4 ⇌ 1/2

\*5 Search speed: x2 ⇌ x10

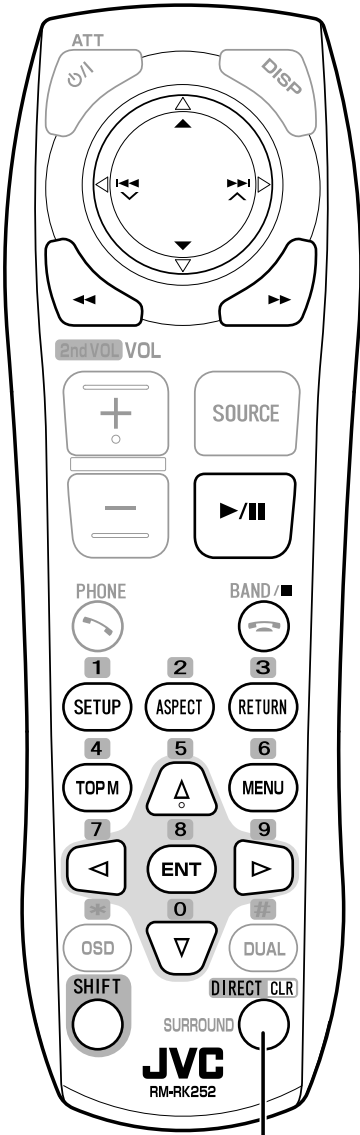

Also functions as CLR (clear):  
Erases a misentry if pressed while holding SHIFT.



	Stops playback.
	Starts or pauses playback.
	Reverse/forward search*1
	<ul style="list-style-type: none"> <li>Selects track.</li> <li>Reverse/forward search*2 [Hold]</li> </ul>
	Selects track.

## Enjoying surround sounds

You can enjoy multi-channel surround playback through the front, center, surround speakers.

- After connecting the center speaker, make sure to activate the center speaker; otherwise, no sound comes out of the center speaker (see page 55).
- You cannot activate this function in the following cases:
  - When “USB iPod” is selected as the source.
  - When Dual Zone is in use.

### MULTI:

For multi-channel encoded sources such as Dolby Digital\*3 and DTS\*4. (When activated, “MULTI” is shown on the source information screen.)

### Dolby Pro Logic II (Movie/Music):

For 2 channel sources except for DivX/MPEG1/MPEG2 discs.

\*3 Manufactured under license from Dolby Laboratories. Dolby, Pro Logic, and the double-D symbol are trademarks of Dolby Laboratories.

\*4 “DTS” and “DTS Digital Surround” are registered trademarks of DTS, Inc.

\*1 Search speed: x2 ⇒ x5 ⇒ x10 ⇒ x20 ⇒ x60

\*2 Search speed: x2 ⇒ x10

## To turn on the surround

1



2

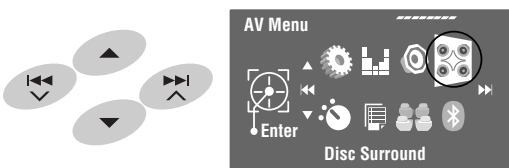

3

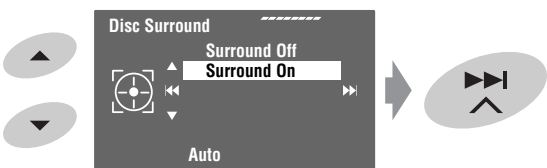

### Surround Off:

Deactivates surround.

### Surround On:

Activates surround. → Go to the following step.

4

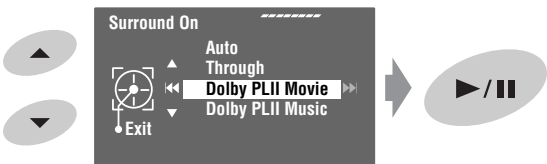

### Auto:

- When multi-channel digital signals come in, "MULTI" surround is activated.
- When 2-channel or 2.1-channel signals\*5 come in, "4CH STEREO" is activated.

### Through:

All incoming channel signals are sent to the corresponding speakers.

### Dolby PLII Movie:

Activates Dolby Pro Logic II Movie.

### Dolby PLII Music:

Activates Dolby Pro Logic II Music. You can adjust <Panorama> and <Center Width> settings. (→ right column)

\*5 Except signals of DivX/MPEG1/MPEG2 discs.

## To change the <Dolby PLII Music> setting

In step 4 in the left column...

1 Select <Dolby PLII Music>.

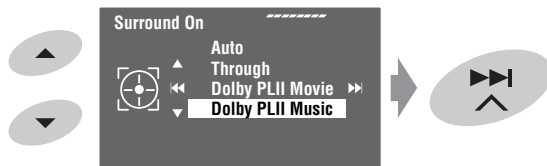

2 Enter each sub-screen then select the desired setting.

EX.: When <Panorama> is selected in step 1.

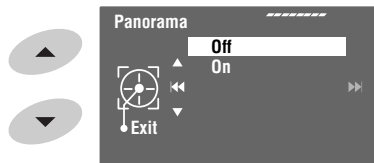
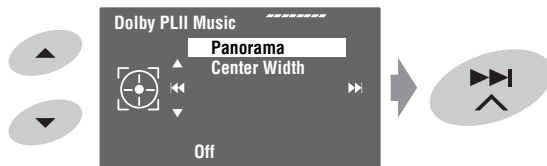

### Panorama:

Select <On> to add wraparound sound effect.

### Center Width:

Adjust the center image so it may be heard only from the center speaker, only from the left/right front speaker as a "phantom" center image, or various combination of these speakers.

As the number increases, the "phantom" effect becomes stronger (normally select <04>).

3



### On the remote:



- You cannot change the <Dolby PL II Music> settings using the remote controller.

# Operations using the on-screen bar (DVD/VCD/DivX/MPEG1/MPEG2/JPEG)

These operations are possible on the monitor using the remote controller.

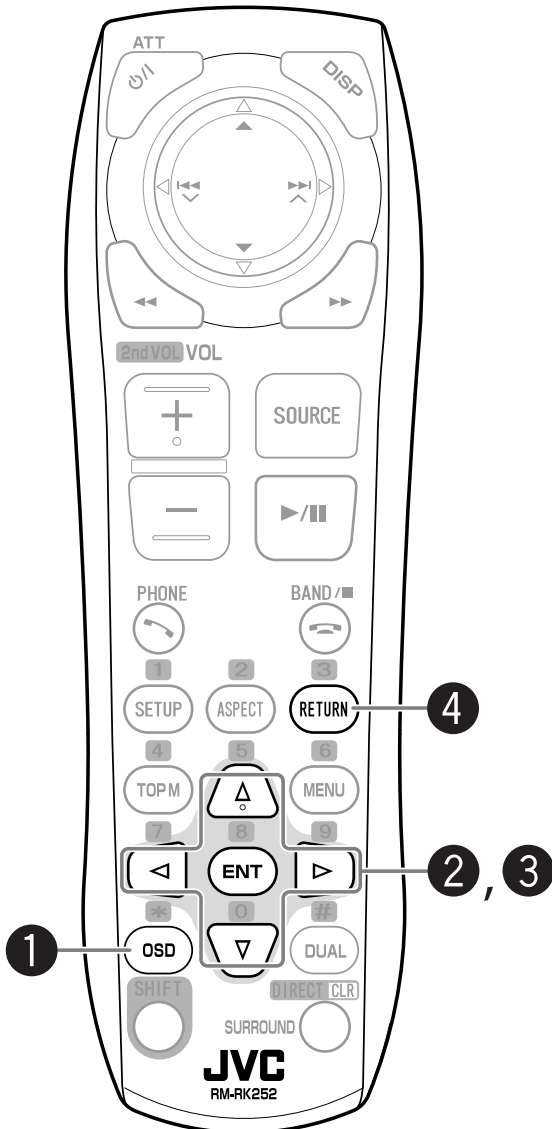

## 1 Display the on-screen bar. (☞ page 25)

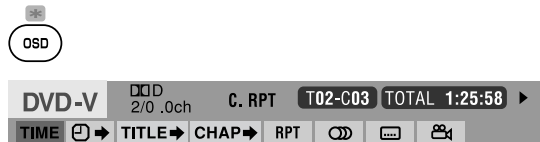

## 2 Select an item.



## 3 Make a selection.

- When a pop-up menu appears...

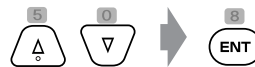

- For entering time/numbers...

To move the entry position:



To select a number:

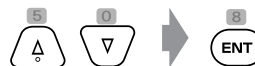

## 4



Repeat steps 2 and 3 to set other items if needed.

## To remove the on-screen bar





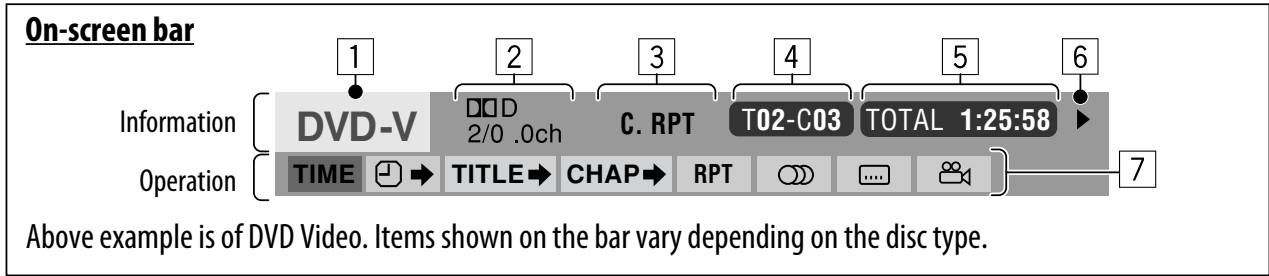

**1** Disc type

- 2** • DVD: Audio signal format
- DTS-CD: DTS
- VCD: PBC

**3** Playback mode\*<sup>1</sup>

DVD Video	C. RPT: Chapter repeat T. RPT: Title repeat
DVD-VR	C. RPT: Chapter repeat PG. RPT: Program repeat
DivX/ MPEG1/ MPEG2	T. RPT: Track repeat F. RPT: Folder repeat F. RND: Folder random A. RND: All (disc) random
JPEG	F. RPT: Folder repeat
VCD	T. RPT: Track repeat A. RND: All (Disc) random

**4** Playback information

<b>T02-C03</b>	Current title/chapter
<b>PG-001 C-002</b>	Current program/chapter
<b>PL-003 C-004</b>	Current playlist/chapter
<b>TRACK 01</b>	Current track
<b>F001-T001</b>	Current folder/track
<b>F002-F002</b>	Current folder/file

**5** Time indication

<b>TOTAL</b>	Elapsed playing time of the disc
<b>T. REM</b>	• Remaining title time (for DVD) • Remaining disc time (for others)
<b>TIME</b>	Elapsed playing time of the current chapter/track* <sup>2</sup>
<b>REM</b>	Remaining time of the current chapter/track* <sup>2</sup>

**6** Playback status

	Play
	Reverse/forward search
	Reverse/forward slow-motion
	Pause
	Stop

**7** Operation icons

<b>TIME</b>	Change time indication (see <b>5</b> )
	Time Search (Specify a certain scene by entering the time.)
<b>TITLE</b>	Title Search (by its number)
<b>CHAP</b>	Chapter Search (by its number)
<b>TRACK</b>	Track Search (by its number)
<b>RPT</b>	Repeat play* <sup>1</sup>
<b>RND</b>	Random play* <sup>1</sup>
	Change the audio language, audio channel or audio stream
	Change the subtitle language
	Change the view angle

\*<sup>1</sup> page 17

\*<sup>2</sup> Not applicable for DVD-VR.

# Dual Zone operations

You can enjoy disc playback on the external monitor connected to the VIDEO OUT and 2nd AUDIO OUT plugs, while listening to any source other than "USB" through the speakers.

- When Dual Zone is in use, you can only operate the DVD/CD player using the remote controller.

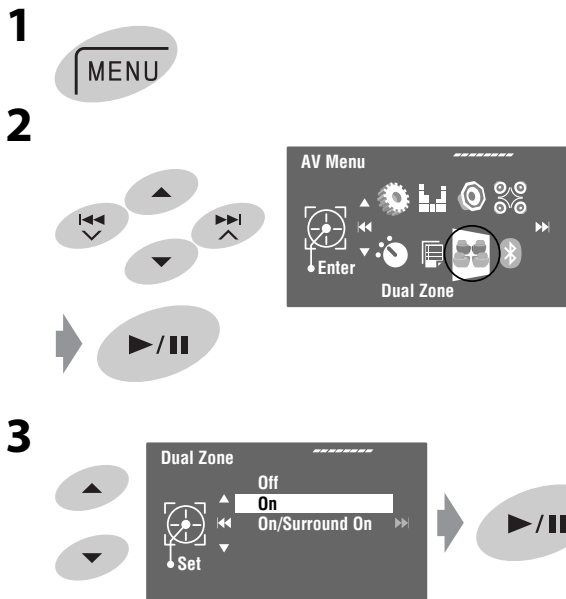

**Off:**

Deactivates Dual Zone.

**On:**

Activates Dual Zone without applying Headphone Surround\*. The DUAL indicator lights up.

**On/Surround On:**

Activates Dual Zone and applies Headphone Surround. "Headphone Surround" appears and the DUAL-SURROUND indicator lights up.

When Dual Zone is activated, the main source is changed to "Disc."

**To select a different source (main source) to listen to through the speakers:**

Press SRC on the control panel.

- By using the touch pad controls, you can operate the newly selected source without affecting Dual Zone (Disc) operations.
- You cannot select "USB" for the main source.

**On the remote:**

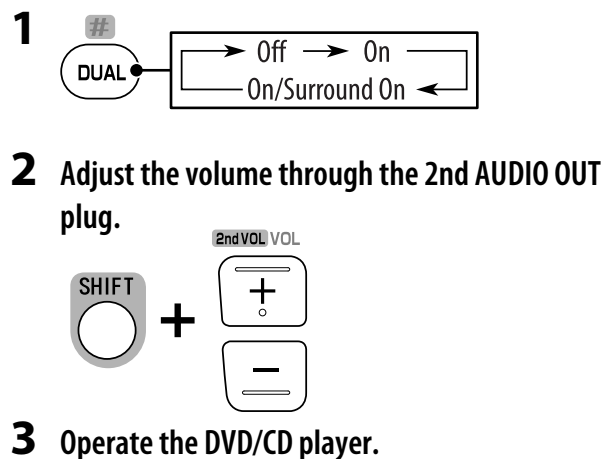

\* JVC original headphone virtual surround system. This surround will also work for the main source "Disc" if "On/Surround On" is selected as the sub-source. This surround does not work for DivX/MPEG1/MPEG2 discs.

## Operations using the control screen

**For discs except DVD and VCD:**

While Dual Zone is on, these operations are possible on the external monitor using the remote controller. The control screen automatically appears when you insert a disc. (For DivX/MPEG1/MPEG2/JPEG; while not playing.)



Ex.: MP3/WMA

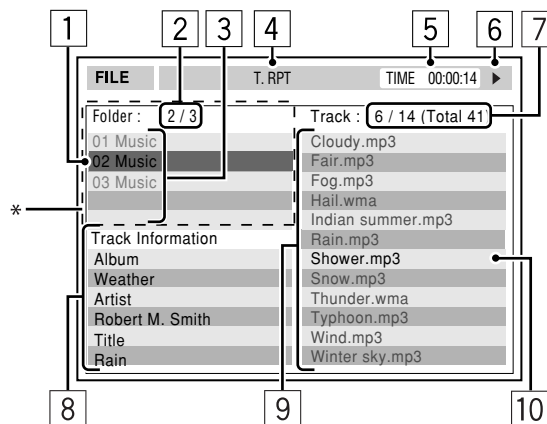

- 1 Current folder (highlighted bar)
  - 2 Current folder no./total folder no.
  - 3 Folder list
- \* If tag data includes "Jacket Picture" (baseline JPEG), it will be displayed. If you press **OSD**, the playback mode selection window appears. (☞ below)
- 4 Selected playback mode (☞ below)
  - 5 Elapsed playing time of the current track (not displayed for JPEG)
  - 6 Operation status
  - 7 Current track no./total number of tracks in the current folder (total number of tracks on the disc)
  - 8 Track information (only for MP3/WMA/WAV/AAC)
  - 9 Track list
  - 10 Current track (highlighted)



Ex.: CD Text

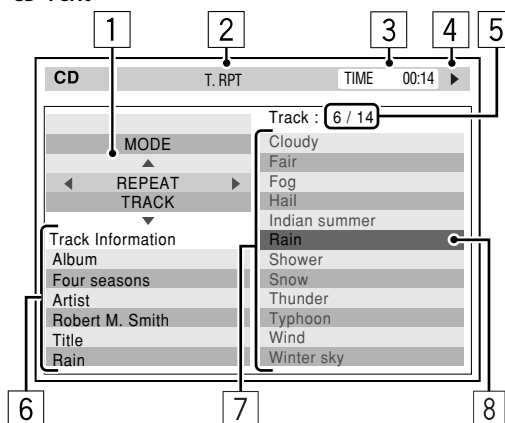

- 1 The playback mode selection window: appears when **OSD** is pressed (☞ below).
- 2 Selected playback mode (☞ below)
- 3 Elapsed playing time of the current track
- 4 Operation status
- 5 Current track number/total number of tracks on the disc
- 6 Track information
- 7 Track list
- 8 Current track (highlighted bar)

**To select a folder or track**

1 Select "Folder" column or "Track" column on the control screen.



2 Select a folder or track.



• If necessary, press ▶/⏸ to start playback.

**To select a track**



• If necessary, press ▶/⏸ to start playback.

**Selecting playback modes**

You can also change the playback modes using the playback mode selection window.

• For JPEG, Random cannot be selected.

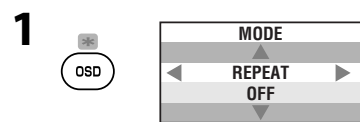

2 Except for JPEG: Select a playback mode.



3 Select your desired option.



**Selectable playback mode**

- DivX/MPEG1/MPEG2/JPEG: ☞ page 25
- MP3/WMA/WAV/AAC:
  - T. RPT: Track repeat
  - F. RPT: Folder repeat
  - F. RND: Folder random
  - A. RND: All (Disc) random
- CD:
  - T. RPT: Track repeat
  - A. RND: All (Disc) random

# Operations using the list screen

For discs other than DVD, VCD, and CD

While Dual Zone is on, these operations are possible on the external monitor using the remote controller.

While not playing...

## 1 Display the list screen.

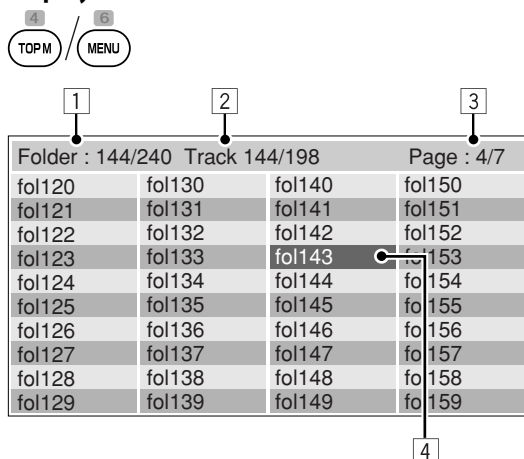

## 2 Select a folder on the list.

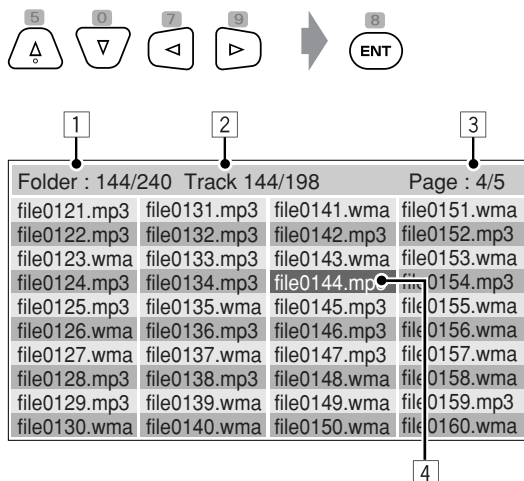

## 3 Select a track on the list.



- 1 Current folder number/total folder number
- 2 Current track number/total number of tracks in the current folder
- 3 Current page/total number of the pages included in the list
- 4 Current folder/track (highlighted bar)

## List screen for DVD-VR

You can use the Original Program and Play List screen anytime while playing DVD-VR with its data recorded.

- These screens can be displayed on the built-in monitor and the external monitor.

## 1 Display the Original Program/Play List screen.

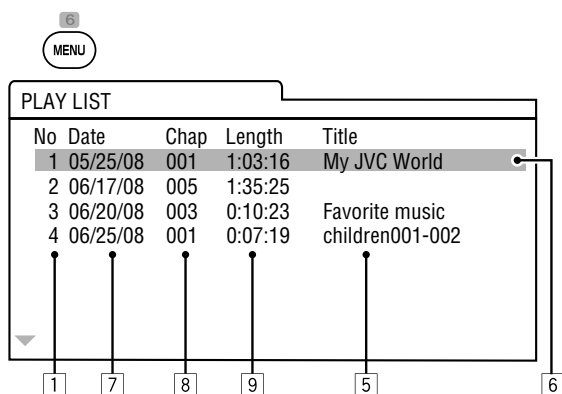
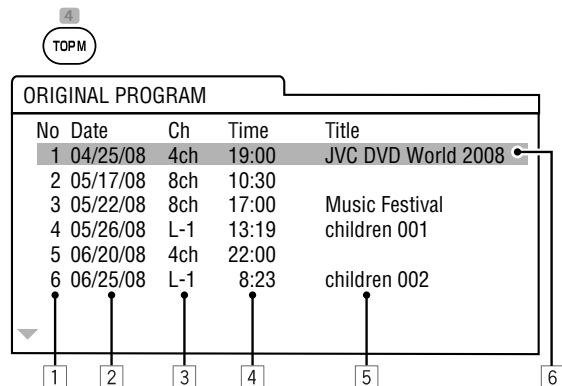

## 2 Select the item you want.



- 1 Program/Play List number
- 2 Recording date
- 3 Recording source (TV station, the input terminal of the recording equipment, etc.)
- 4 Start time of recording
- 5 Title of the program/Play List\*
- 6 Highlighted bar (current selection)
- 7 Creating date of Play Lists
- 8 Total number of chapters
- 9 Playback time

\* The title of the original program or Play List may not be displayed depending on the recording equipment.

# USB operations

You can connect a USB mass storage class device such as a USB memory, Digital Audio Player, portable HDD, etc. to the unit.

- You can also connect the iPod to the USB terminal of the unit. For details of the operations, see pages 38 and 39.

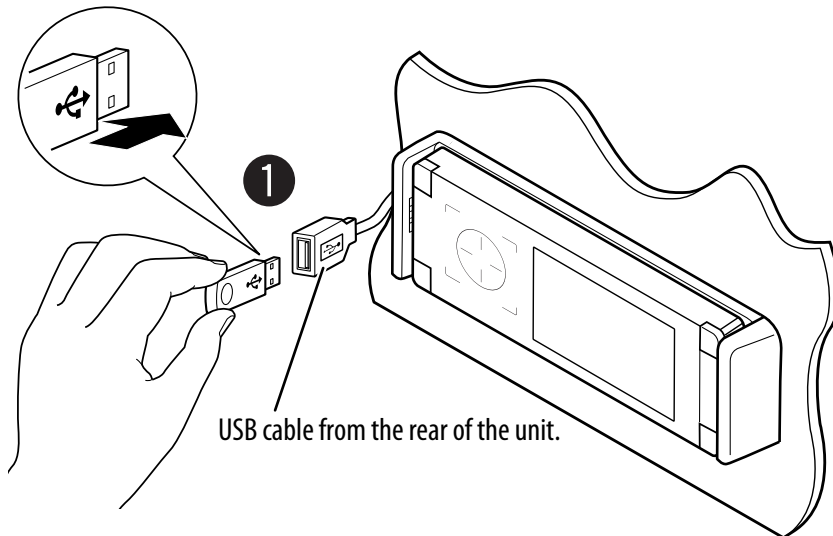

- You cannot connect a computer to the USB ( ) terminal of the unit.

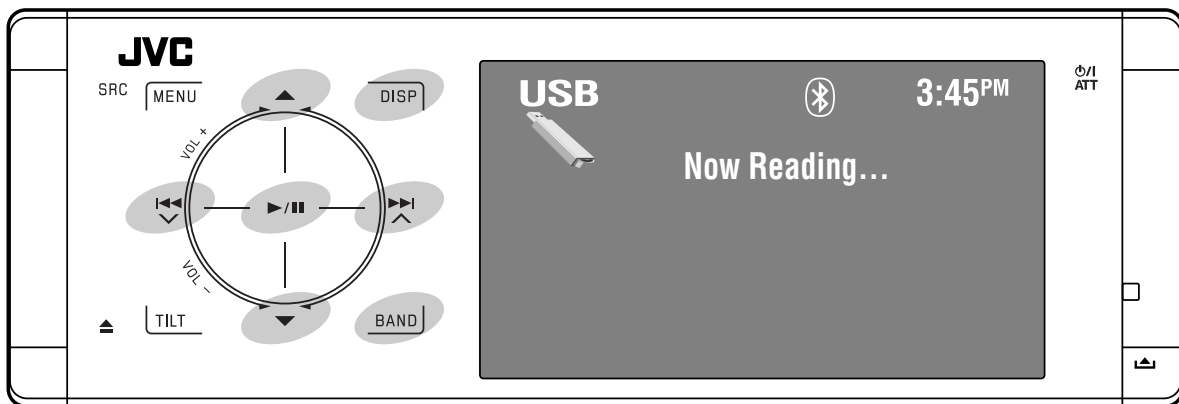

◀◀▶▶▶▶:	Touch: Selects track Hold: Reverse/forward search
▲ ▼:	Touch: Selects folder Hold: Displays Folder List
▶ /   :	Starts/pauses playback.
DISP:	Touch if necessary. (see page 9)
BAND:	Stops playback.

## 1 Connect a USB device.

"USB" is selected as the source and playback starts automatically.

This unit can play JPEG/MPEG1/MPEG2\*<sup>1</sup>/MP3/WMA/WAV/AAC\*<sup>2</sup> files stored on a USB mass storage class device.

- You can operate the USB device in the same way you operate the files on discs. (see pages 17 to 25)
- You cannot select "USB" when Dual Zone is in use.
- All tracks on the USB device will be played repeatedly until you change the source.

\*<sup>1</sup> Except for MPEG2 files recorded by JVC Everio camcorder (extension code <.mod>).

\*<sup>2</sup> This unit can play back AAC files encoded using iTunes. This unit cannot play back FairPlay-encrypted files.

**Caution:**

- Avoid using the USB device if it might hinder your safety driving.
- Do not pull out and attach the USB device repeatedly while “Now Reading...” is flashing on the monitor.
- Do not start the car engine if a USB device is connected.
- Stop playback before disconnecting a USB device.
- Make sure all important data has been backed up to avoid losing the data.
- Do not leave a USB device in the car, expose to direct sunlight, or high temperature to avoid deformation or cause damages to the device.
- For more details about USB operations,  page 64.

## Selecting playback modes

You can use Repeat or Random playback mode.

Ex.: To select Track Repeat

1



2

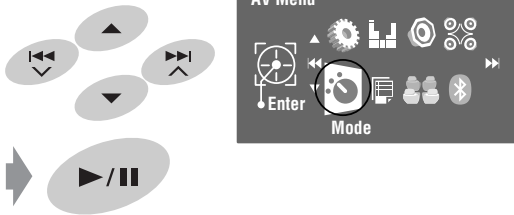

3



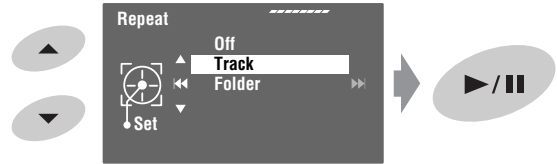

4



When one of the playback modes is selected, the corresponding indicator lights up on the source information screen.

To cancel, select <Off> in step 4.

File type	Repeat	Random
	<p><b>Track:</b> Repeats current track.</p> <p><b>Folder:</b> Repeats all tracks of the current folder.</p>	<p><b>Folder:</b> Randomly plays all tracks of current folder, then tracks of next folders.</p> <p><b>USB (All):</b> Randomly plays all tracks.</p>
	<p><b>Track:</b> Repeats current track.</p> <p><b>Folder:</b> Repeats all tracks of the current folder.</p>	<p><b>Folder:</b> Randomly plays all tracks of current folder, then tracks of next folders.</p> <p><b>USB (All):</b> Randomly plays all tracks.</p>
	<p><b>Folder:</b> Repeats all tracks of the current folder.</p>	—

## Bluetooth®

Bluetooth is a short-range wireless radio communication technology for the mobile device such as mobile phones, portable PCs, and other devices. The bluetooth devices can be connected without cables and communicate with each other.

- Refer to the list (included in the box) to see the countries where you may use the Bluetooth® function.

### Bluetooth profile

This unit supports the following Bluetooth profiles;  
HFP (Hands-Free Profile) 1.5  
OPP (Object Push Profile) 1.1  
A2DP (Advanced Audio Distribution Profile) 1.2  
AVRCP (Audio/Video Remote Control Profile) 1.3

### Features

You can operate Bluetooth devices through the unit as follows:

- Receiving a call
- Making a call—from phone book, from call history (Redial and Received Call), by dialing number, by preset numbers, by voice command
- Receiving the text message
- Playing back a Bluetooth audio player

Refer also to the instructions supplied with the Bluetooth device.

- The Bluetooth word mark and logos are owned by the Bluetooth SIG, Inc. and any use of such marks by Victor Company of Japan, Limited (JVC) is under license. Other trademarks and trade names are those of their respective owners.

## Connecting a Bluetooth device for the first time

### Pairing and PIN Code

When you connect a Bluetooth device to the unit for the first time, make pairing between the unit and the device. Pairing allows Bluetooth devices to communicate each other.

To make pairing, you may need to enter the PIN (Personal Identification Number) code of your Bluetooth device you want to connect.

- Once the connection is established, it is registered in the unit even if you reset the unit. Up to five devices can be registered in total.
- Only one device for Bluetooth phone and one for Bluetooth audio can be connected at a time.
- To use the Bluetooth function, you need to turn on Bluetooth function of the device.

**Preparation:** Operate the device to turn on its Bluetooth function.

### Registration (Pairing) method

Register and establish the connection with a device.

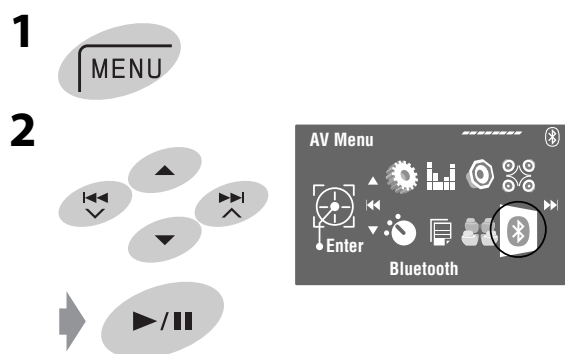

Continued on the next page

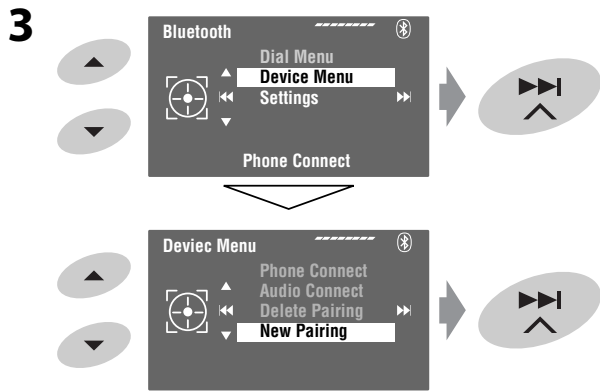

**4 Enter a PIN (Personal Identification Number)\* code to the unit.**

- You can enter any number you like (1-digit to 16-digit number).
- \* Some devices have their own PIN code. Enter the specified PIN code to the unit.

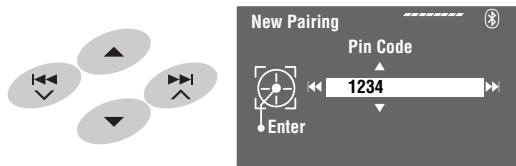

- To delete an unwanted digit, select a blank.



starts flashing.

**6 Operate the target Bluetooth device. (While "Open..." is flashing on the monitor.)**

Enter the same PIN code (as entered in the above step) on the device to be connected.

**Connected**

Now connection is established and you can use the device through the unit.

turns blue and the following icon appears when the connection is established.

	Appears when the Bluetooth phone is connected.
	Appears when the Bluetooth audio player is connected.
	Appears when the Bluetooth phone and the Bluetooth audio player are connected.

The device remains registered even after you disconnect the device. Use <Phone Connect> (or activate <Auto Connect>) to connect the same device from next time on. (👉 page 60)

**Connecting/disconnecting a registered device**

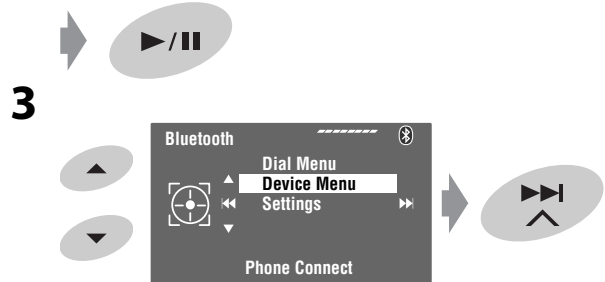
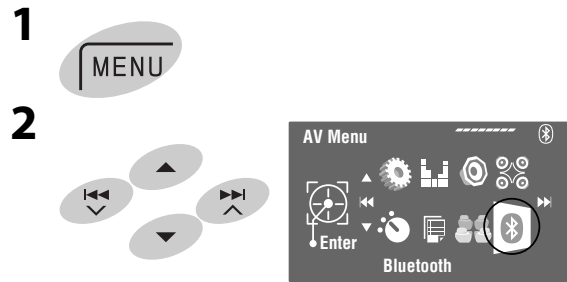

**4 Select the desired setting.**

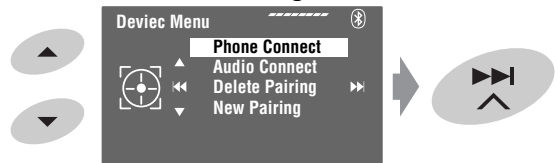

- For connecting: Select <Phone Connect>/<Audio Connect> then go to the next step.\*
- For disconnecting: Select <Phone Disconnect>/<Audio Disconnect>.

**5 Select the registered device you want to connect.**



You can set the unit to connect a Bluetooth device automatically when the unit is turned on. (👉 page 60)

\* When a device has already connected to the unit, <Phone Connect> and <Audio Connect> do not appear and vice versa.



## Deleting a registered device

1



2

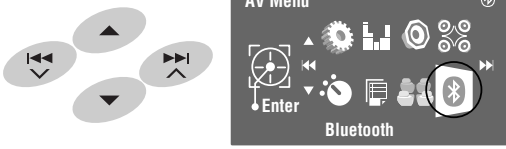

3

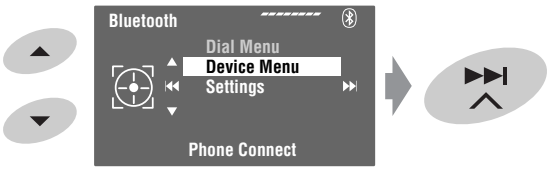

4 Select the registered device you want to delete.

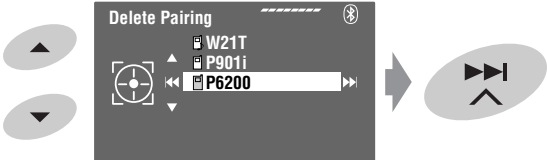

5

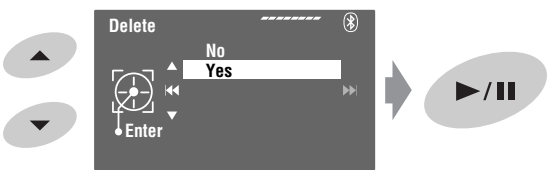

## Making a call

You can make hands-free calls using the unit.

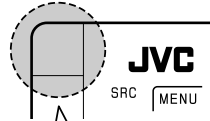

The built-in microphone is behind the upper left hand corner of the unit.

The sound comes out from the connected speakers.

1



2

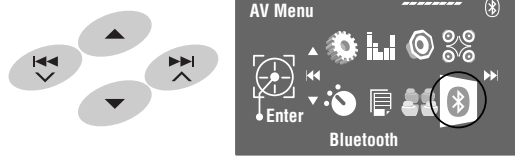

3

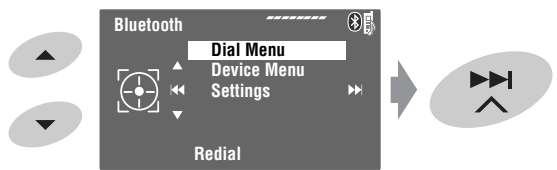

Continued on the next page

## 4 Select the method to make a call.

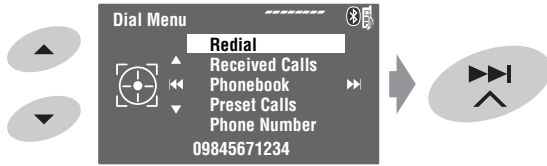

### Redial\*1

Shows the list of phone numbers you have dialed.  
→ Go to the following step.

### Received Calls\*1

Shows the list of the received calls. → Go to the following step.

### Phonebook\*2

Shows the phone book copied from a cellular phone. → Go to the following step.

### Preset Calls\*3

Shows the list of preset numbers. → Go to the following step.

### Phone Number

Shows the phone number entry screen. → "How to enter a phone number" page 35

### Voice Dialling

(Only when the connected cellular phone has the voice recognition system):

Speak the name you want to call. (Refer to the instruction manual supplied with your cellular phone.)

## 5 Select the name/phone number/preset number you want to call.

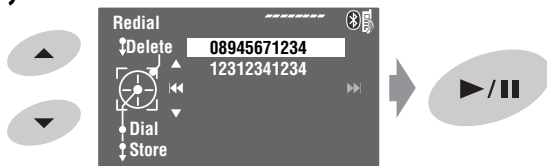

- When the sound is stopped or interrupted during the use of a Bluetooth device, turn off, then turn on the unit.
  - If the sound is not yet restored, connect the device again. ( "Connecting/disconnecting a registered device" on page 32)
- While talking, you can enter **<MIC Setting>** to adjust the built-in microphone volume level by touching **MENU**. ( page 60)

\*1 Displays only when the dialed or received number is made through the unit.

\*2 For copying, page 35.

\*3 For presetting, page 36.

You can also enter **<Dial Menu>** by pressing on the remote controller then touching on the unit.

### When a call comes in...

#### Receiving Call

**Jack** Name and phone number  
**09845671234** (if acquired)

The source is automatically changed to "Bluetooth."

#### When **<Auto Answer>** is activated...

The unit answers the incoming calls automatically. ( page 60)

- When **<Auto Answer>** is deactivated, press **SRC** or touch any control to answer the incoming call.

#### To end the call or reject an incoming call

Hold **SRC** or any control.

#### Answering a waiting call

If your cellular phone is equipped with the call waiting function, you can put the current call on hold and answer the waiting call.

Press **SRC** or touch any control.

- To restore the on-hold call, press **SRC** or touch any control again.
- When you end one call, you can connect to the other.

#### When a Text message comes in...

If the cellular phone is compatible with Text message and **<SMS Notify>** is set to **<On>** ( page 60), the unit rings and "Receiving Message" appears on the monitor to inform you of the arrival of the message.

## How to enter a phone number

- 1** Select a number. Move the entry position.



- To delete an unwanted digit, select a blank.
- To erase all digits, hold DISP.

**2**



## How to delete the phone numbers/names

- Make sure that the Bluetooth phone is connected.

- 1** Display the list of phone numbers/names using <Redial>, <Received Calls>, or <Phonebook> in <Dial Menu>.

- Follow steps 1 to 4 of “Making a call” on pages 33 and 34.

- 2** Select the phone number/name you want to delete.

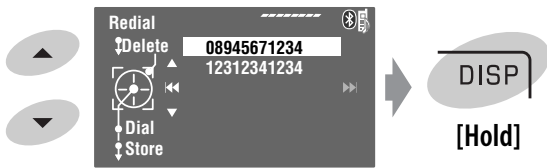

**3**



**No:** Cancels.

**One:** Deletes the selected phone number/name.

**All:** Deletes the phone numbers/names listed in step 1.

## To copy the phone book

You can copy the phone book memory of a cellular phone into the unit.

**1**



**2**

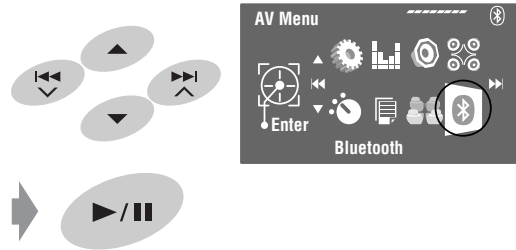

**3**

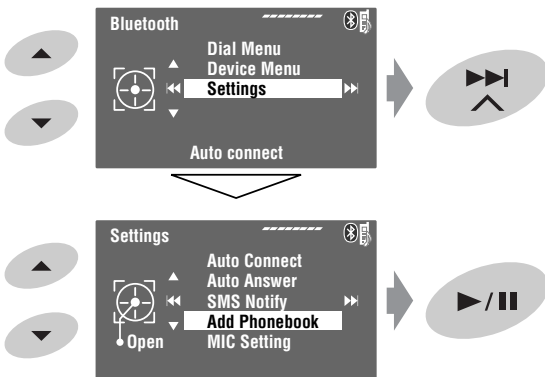

- 4** Enter a PIN\* code to the unit.

- You can enter any number you like (1-digit to 16-digit number).

- \* Some cellular phones have their own PIN code. Enter the specified PIN code to the unit.

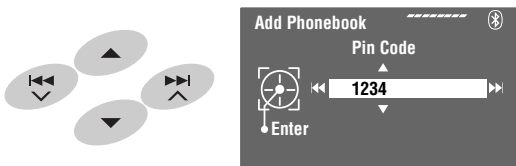

- To delete an unwanted digit, select a blank.

Continued on the next page

5  Receiving...

6 Operate the target cellular phone.  
Enter the same PIN code (as entered in the above step) on the cellular phone then transfer the phone book memory to the unit. (Refer to the instruction manual supplied with your cellular phone.)

7 Finish the procedure.



- If you try to copy a 51st phone book entry, "Phonebook Full" appears on the monitor. Delete unwanted names before copying (☞ page 35).

## Presetting the phone numbers ■

You can preset up to six phone numbers.

1 Display the phone number you want to preset by using <Redial>, <Received Calls>, <Phonebook>, or <Phone Number>.

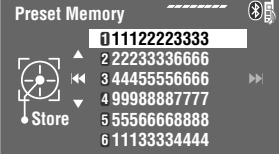
2  [Hold] 

3 Select a preset number.

4 Store the phone number.



The phone number selected in step 1 is now stored in preset number 5.

## To call a preset number ■

**On the remote:**

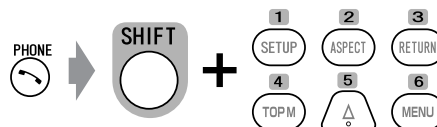

**On the unit:**

See "Making a call." (☞ pages 33 and 34)  
In step 4...

- 1 Select <Preset Calls>.  
The Preset Calls List appears.
- 2 Select the preset number.

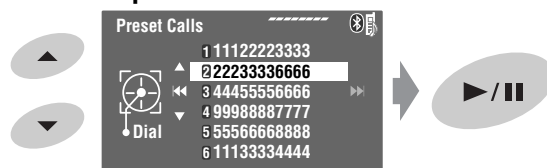

## Switching conversation media (the unit/cellular phone) ■

During a phone call conversation...

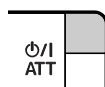

Then, continue your conversation using the other media.

You can use the following buttons on the remote controller for the Bluetooth phone operations. For details, ☞ pages 10 and 11.



# Using the Bluetooth audio player

- Operations and display indications differ depending on their availability on the connected audio player.

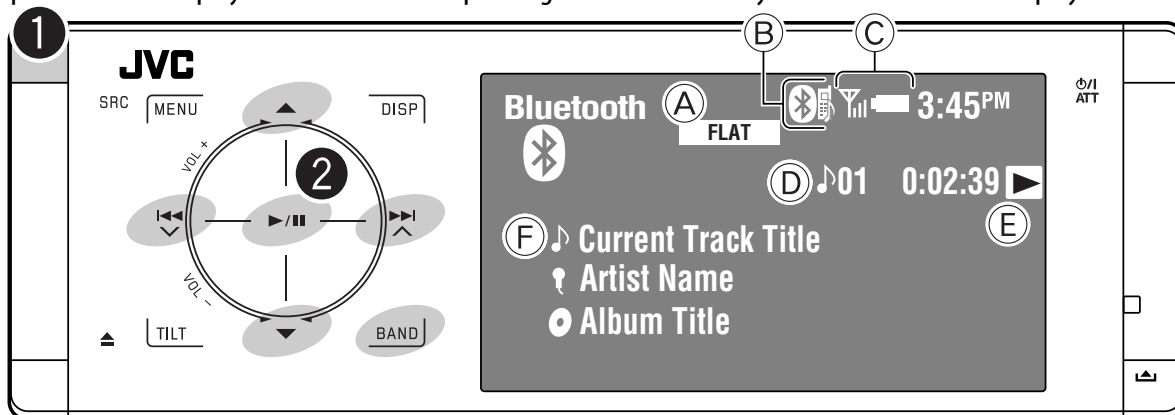

ENGLISH

⏮⏪⏩⏭:	Touch: Reverse/forward skip Hold: Reverse/forward search
▲ ▼:	Selects group/folder.
▶/⏸:	Starts playback.
BAND:	Pauses playback.

## Selecting playback modes

You can use Repeat or Random playback mode.

- Enter <AV Menu> → <Mode>.
- Select <Repeat> or <Random>.
- Select a playback mode.

- (A) Sound mode (page 50)
- (B) page 32
- (C) Status of the device\*  
Signal strength/Battery remainder
- (D) Track no./Playing time
- (E) Indicates the touched control or pressed button. It may be different from the operation status.
- (F) Track title/Artist Name/Album title

<b>Repeat:</b>	<b>Off:</b> Cancels. <b>Track:</b> Repeats current track. <b>Group:</b> Repeats all tracks of the current group/folder. <b>All:</b> Repeats all tracks.
<b>Random:</b>	<b>Off:</b> Cancels. <b>Group:</b> Randomly plays all tracks of current group/folder, then tracks of next groups/folders. <b>All:</b> Randomly plays all tracks.

\* Appears only when the information comes from the device.

- Select "Bluetooth."
- Start playback.

- See pages 31 and 32 for connecting a new device.
- See page 32 for connecting/disconnecting a registered device.
- See page 33 for deleting a registered device.
- When the sound is stopped or interrupted during the use of a Bluetooth device, turn off, then turn on the unit.
  - If the sound is not yet restored, connect the device again. (page 32 "Connecting/disconnecting a registered device")

When one of the playback modes is selected, the corresponding indicator lights up on the source information screen.

To cancel, select <Off> in step 3.

You can use the following buttons on the remote controller for the Bluetooth audio operations. For details, pages 10 and 11.

**Bluetooth Information:**  
If you wish to receive more information about Bluetooth, visit the following JVC web site: <<http://www.jvc-victor.co.jp/english/car/>>

# Listening to the iPod

You can connect the iPod using the following cable or adapter:

	Cable/adapter	To operate
To listen to the music	USB 2.0 cable (supplied for the iPod)	☞ "When connected with the USB cable" below.
	Interface Adapter for iPod—KS-PD100 (not supplied)	☞ "When connected with the interface adapter" on page 40.
To watch the video	USB Audio and Video cable for iPod—KS-U20K (not supplied)	☞ "When connected with the USB cable" below. • Make sure <iPod (Off)> is selected for <AV Input>. (☞ page 56)

## When connected with the USB cable

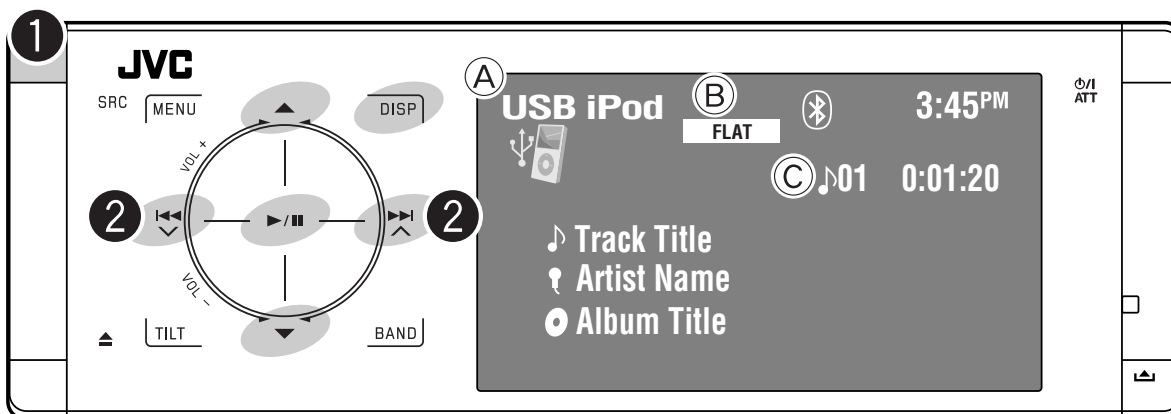

- (A) Source name
- (B) Sound mode (☞ page 50)
- (C) Track or video no./Playing time

- 2** Select a track/video\*2.  
Touch: Selects track/video.  
Hold: Reverse/forward search

▶/  :	Starts/pauses playback.
▲ ▼:	Moves to the previous/next item of a category (ex.: another album, artist, playlist, etc.).*1
DISP:	Touch if necessary. (☞ page 9)

\*2 You cannot resume playback for video sources.

You can display iPod Artwork on the monitor. (☞ pages 54 and 65)

\*1 ▲ / ▼ may not function depending on how you select the current track/video.

### 1 Select "USB iPod."

Playback starts automatically.

- When you connect the iPod to the USB terminal, "USB iPod" is selected as the source and playback starts automatically.

## Selecting a track/video from <Search Mode>

### 1 Enter <Search Mode>.

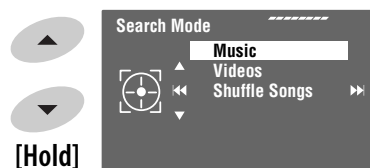

### 2 Select <Music> or <Videos>.

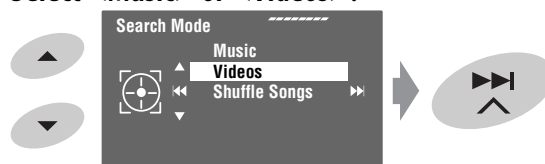

**3 Select an item.**

EX.: When <Music> is selected in step 2.

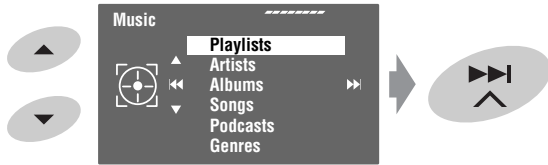

- Repeat the procedure to select the desired track/video.

**4 Confirm the selection.**



<Search Mode> can also be accessed through <AV Menu> → <List>.

**4**

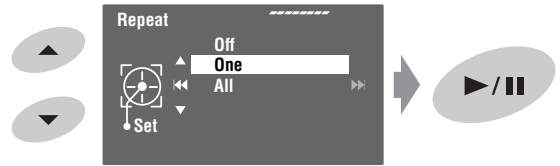

<b>Repeat:</b>	<b>One:</b> Functions the same as “Repeat One” of the iPod. <b>All:</b> Functions the same as “Repeat All” of the iPod.
<b>Random:</b>	<b>Song:</b> Functions the same as “Shuffle Songs” of the iPod.* <b>Album:</b> Functions the same as “Shuffle Albums” of the iPod.

When playback modes are selected, the corresponding indicators light up on the source information screen.

**Selecting playback modes**

You can use Repeat or Random playback mode.

Ex.: To select Track Repeat

**1**



**2**

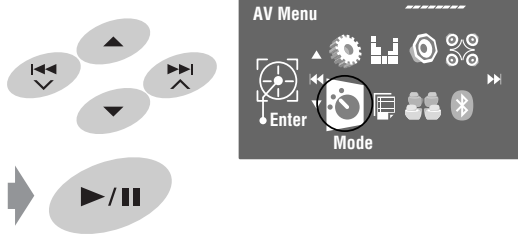

**3**



To cancel, select <Off> in step 4.

\* You can also activate the playback mode through <Search Mode>.

To activate, select <Shuffle Songs> then touch ►/|| in step 2 on page 38.

**Changing the play speed of the audiobooks**

You can change the play speed of the audiobooks.

Follow steps 1 to 3 in the left column.

In step 3...

**1**

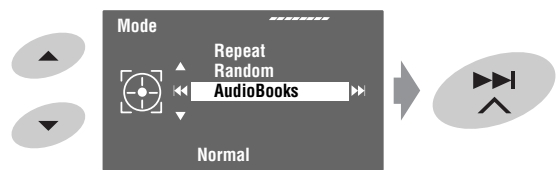

**2 Select the desired speed.**

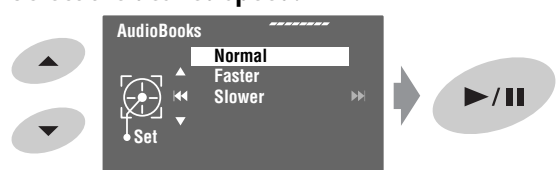

# When connected with the interface adapter

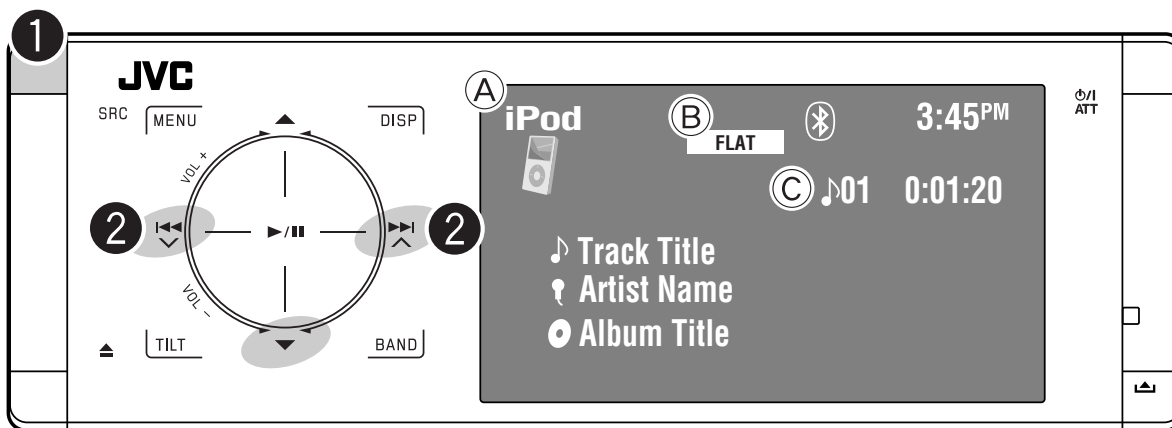

▼: Pauses playback  
– To resume, touch again

- (A) Source name
- (B) Sound mode (page 50)
- (C) Track no./Playing time

## Preparation:

When operating through the CD changer jack, make sure <iPod> is selected for the external input setting. (page 56)

- 1** Select "iPod."  
Playback starts automatically.
- 2** Select a track.  
Touch: Selects track.  
Hold: Reverse/forward search

## Selecting a track from the player's menu

- 1** Enter the player's menu.
  - This mode will be canceled if no operations are done for about 5 seconds.



The SEARCH indicator lights up.

- 2** Select the desired item.



Touch: Select an item  
Hold: Skip 10 items at a time

<Playlists> ↔ <Artists> ↔ <Albums>  
↔ <Songs> ↔ <Genres> ↔  
<Composers> ↔ (back to the beginning)

- 3** Confirm the selection.



- 4** Repeat steps 2 and 3 to select a track.
  - When a track is selected finally, playback starts.
  - To return to the previous menu, touch ▲.

## Selecting playback modes

Operations are exactly the same as explained on page 39.\*

\* "AudioBooks" is not displayed in step 3.



# Listening to the CD changer

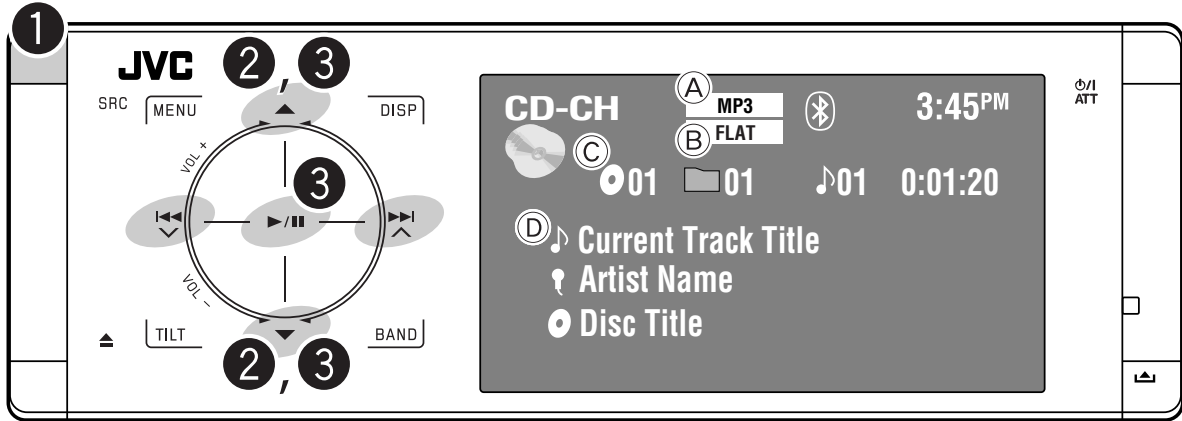

- ◀▶▶▶:** Touch: Selects track.  
Hold: Reverse/forward search
- ▲▼:** Touch: Selects folder (MP3 only).  
Hold: Displays Disc List.

## 3 Select a disc to start playing.



- (A) MP3 indicator (MP3 only)
- (B) Sound mode (see page 50)
- (C) Disc no./Folder no./Track no./Playing time
- (D) Current track title/Artist name/Disc title  
"No Name" appears for conventional CDs.

It is recommended to use a JVC MP3-compatible CD changer with your unit.

- You can play only CDs (CD-DA) and MP3 discs.

### Preparation:

Make sure <Changer> is selected for the external input setting. (see page 56)

## 1 Select "Changer."

## 2 Enter <Disc List>.



- Each time you hold the button, you can display the other list of the remaining discs.

While playing an MP3 disc, you can select and start playing a track in the disc using the Lists:

<Disc List> (select the current disc) →  
<Folder List> → <File List> then start playing a track you want.

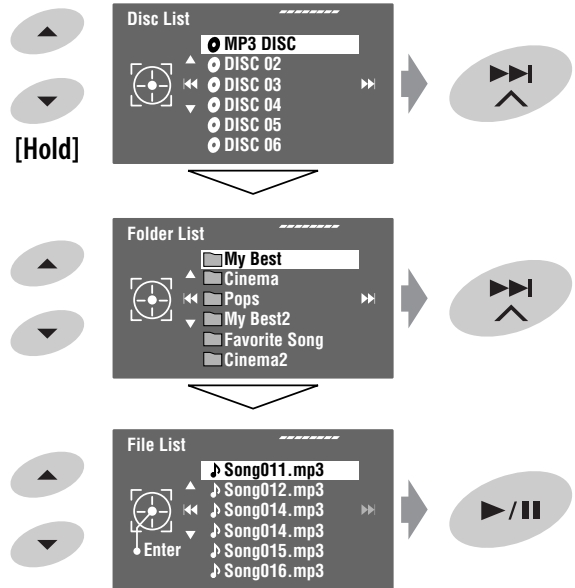

Each List can also be accessed through <AV Menu>  
→ <List> → <Disc List> → <Folder List> → <File List>.

# Selecting playback modes

ENGLISH

You can use Repeat or Random playback mode.  
Ex.: To select Track Repeat

1



2

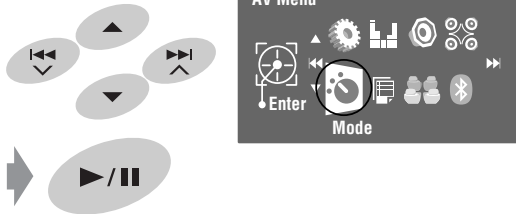

3



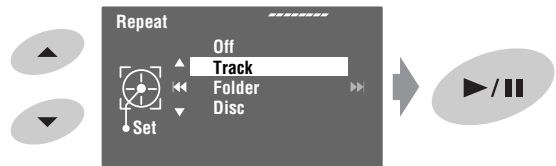

4



When one of the playback modes is selected, the corresponding indicator lights up on the source information screen.

To cancel, select <Off> in step 4.

Disc type	Repeat	Random
	<p><b>Track:</b> Repeats current track.</p> <p><b>Disc:</b> Repeats all tracks of the current disc.</p>	<p><b>Disc:</b> Randomly plays all tracks of the current disc.</p> <p><b>All:</b> Randomly plays all tracks of all loaded discs.</p>
	<p><b>Track:</b> Repeats current track.</p> <p><b>Folder:</b> Repeats all tracks of the current folder.</p> <p><b>Disc:</b> Repeats all tracks of the current disc.</p>	<p><b>Folder:</b> Randomly plays all tracks of current folder, then tracks of next folders.</p> <p><b>Disc:</b> Randomly plays all tracks of the current disc.</p> <p><b>All:</b> Randomly plays all tracks of all loaded discs.</p>

You can use the following buttons on the remote controller to operate the CD changer. For details,  pages 10 and 11.

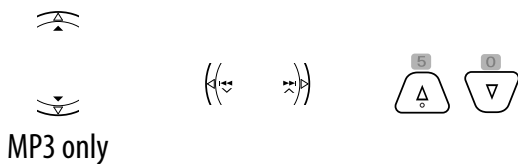

# Listening to the satellite radio

Before operating, connect either one of the following (separately purchased) to the CD changer jack on the rear of this unit.

- JVC SIRIUS Satellite radio interface, KS-SRA100, for listening to SIRIUS Satellite radio.
- JVC Smart Digital Adaptor, XMDJVC100, for listening to XM Satellite radio.

## ■ For SIRIUS Radio

### Activate your subscription after connection:

#### 1 Turn on the power.

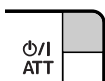

#### 2 Select "Satellite Radio."



The SIRIUS Satellite radio starts updating all the SIRIUS channels. (☞ "GCI update" column below.)

- Once completed, SIRIUS Satellite radio tunes in to the preset channel, CH184.

#### 3 Check your SIRIUS ID, ☞ page 56.

#### 4 Contact SIRIUS on the internet at <<http://activate.siriusradio.com/>> to activate your subscription, or you can call SIRIUS toll-free at 1-888-539-SIRIUS (7474).

"Subscription updated Press any Key to continue" appears on the monitor once subscription has been completed.

## ■ For XM Radio

### Activate your subscription after connection:

- Only Channel 0, 1, and 247 are available before activation.

#### 1 Turn on the power.

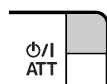

#### 2 Select "Satellite Radio."



The XMDirect™ Universal Tuner Box starts updating all the XM channels. "Channel 1" is tuned in automatically. (☞ "GCI update" column below.)

#### 3 Check your XM Satellite radio ID labelled on the casing of the XMDirect™ Universal Tuner Box, or tune in to "Channel 0" (☞ page 44).

#### 4 Contact XM Satellite radio on the internet at <<http://xmradio.com/activation/>> to activate your subscription, or you can call 1-800-XM-RADIO (1-800-967-2346).

Once completed, the unit tunes in to one of the available channels (Channel 4 or higher).

#### GCI (Global Control Information) update:

- If channels are updated after subscription, updating starts automatically, and no sound can be heard.  
For SIRIUS: "Channel is updating XX% completed" appears.  
For XM: "UPDATING" appears.
- Update takes a few minutes to complete.
- Do not touch any touch pad control, press any button, or perform any operation until updating is completed.

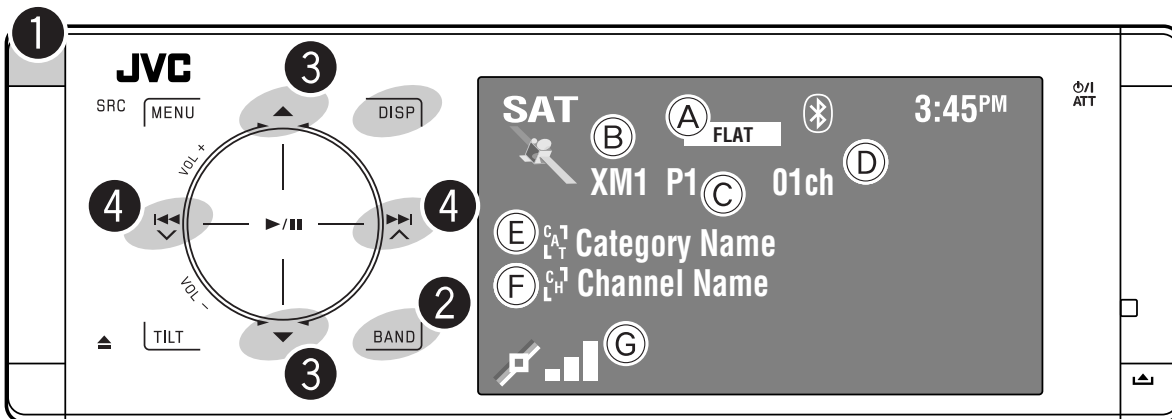

**DISP:** Touch to display the program information—artist name/song name (/composer name: only for SIRIUS Satellite radio).

- (A) Sound mode (see page 50)
- (B) SIRIUS/XM Band
- (C) Preset no.
- (D) Channel no.
- (E) Category name
- (F) Channel name
- (G) Signal strength

**For SIRIUS Radio**

- 1 Select "Satellite Radio."
- 2 Select the band.
  - SR1 → SR2 → SR3 →
- 3 Select a category.
  - To select a channel from all categories, select <All>.
- 4 Make a channel to listen.
  - Holding either or changes the channels rapidly.
  - While searching, invalid and unsubscribed channels are skipped.

**For XM Radio**

- 1 Select "Satellite Radio."
- 2 Select the band.
  - XM1 → XM2 → XM3 →
- 3 Select a category.
  - To select a channel from all categories (including non-categorised channels), skip this step.
  - If you do not select a channel within 15 seconds, the category selected is canceled. You can select a channel from all categories now.
- 4 Select a channel to listen.
  - Holding either or changes the channels rapidly.
  - While searching, invalid and unsubscribed channels are skipped.

- "SIRIUS" and the SIRIUS dog logo are registered trademarks of SIRIUS Satellite Radio Inc.
- XM and its corresponding logos are registered trademarks of XM Satellite Radio Inc.
- "SAT Radio", the SAT Radio logo and all related marks are trademarks of SIRIUS Satellite Radio Inc., and XM Satellite Radio, Inc.

**Checking the XM Satellite radio ID**

**Select Channel "0."**  
 The 8-digit (alphanumeric) ID number is displayed on the monitor.

**To cancel the ID number display,** select any channel other than channel "0."

## Storing channels in memory

You can preset six channels for each band.

Ex.: Storing a channel into preset number 5

### 1 Tune in to a channel you want to preset.

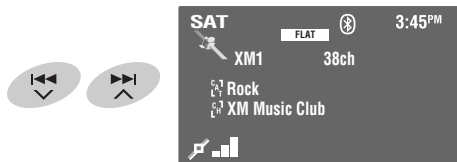

### 2 Display the Preset List.

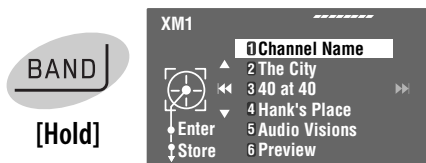

### 3 Select a preset number.

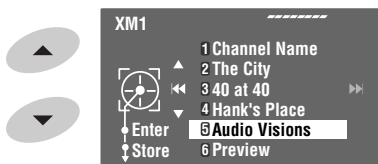

### 4 Store the channel.



## Selecting preset channels

On the remote:

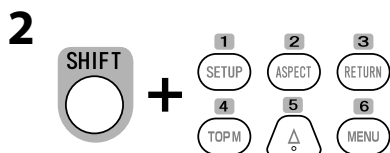
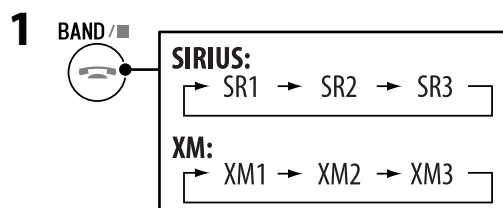

On the unit:

See "Selecting on the lists" in the right column.

## Selecting on the lists

You can select a channel using one of the following lists—Preset List/Category List/Channel List.

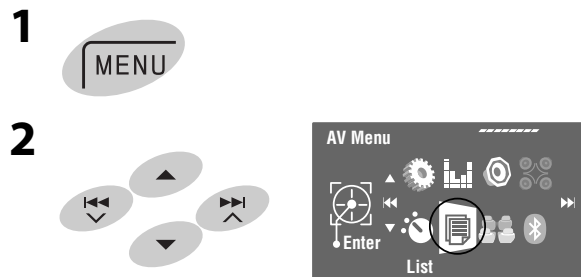

### 3 Select a desired list.

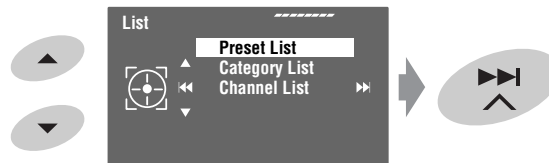

- **Preset List:** Displays your preset channels. step 5
- **Category List:** Displays the categories. step 4
- **Channel List:** Displays all channels within the selected category. step 5

### 4 Select a desired category.

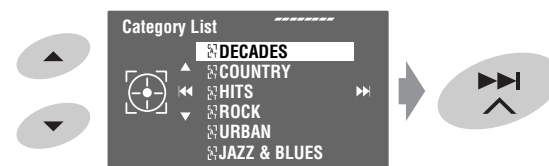

### 5 Select a desired channel.

EX.: When <Preset List> is selected in step 3.

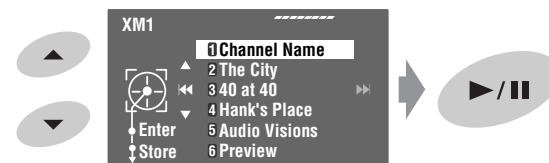

- Category List can also be accessed by... [Hold]
- Preset List can also be accessed by... [Hold]

# Listening to the HD Radio™ Broadcast

Before operating, connect HD Radio tuner box, KT-HD300 (separately purchased) to the CD changer jack on the rear of the unit.

## What is HD Radio Technology?

HD Radio Technology can deliver high-quality digital sound—AM digital will have FM-like quality (in stereo) and FM digital will have CD-like quality—with static-free and clear reception. Furthermore, stations can offer text and data, such as artist names and song titles.

- When the HD Radio tuner box is connected, it can also receive conventional analog broadcasts.
- Many HD Radio stations also offer more than one channel of programming. This service is called multicasting.
- To find HD Radio stations in your area, visit [www.hdradio.com](http://www.hdradio.com) <<http://www.hdradio.com/>>.

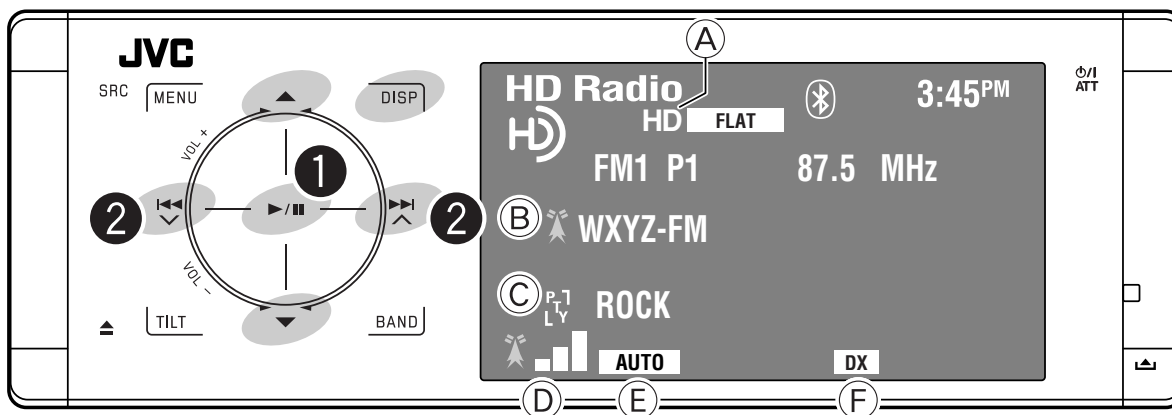

▲ ▼:	Selects multicast channels.
DISP:	Touch to display the program information—song name/artist name/album title.

- (A) Flashes first then lights up when a digital audio broadcast is tuned in.
- (B) Station Call Sign\*
- (C) Program type
- (D) Signal strength
- (E) HD Radio reception indicators (☞ page 47)
- (F) DX/Local indicator (☞ page 47)

\* When an HD Radio multicast channel is received, the first four letters of Call Sign and channel number are displayed.

Refer also to page 12 for basic radio operations.

## When receiving HD Radio multicast channels...

Select your desired channel.

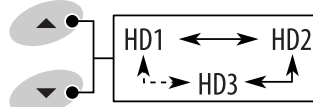

"LINKING" appears while linking to a multicast channel.

## Searching for HD Radio stations only:



The "HD SEARCH" indicator appears.



## Changing HD Radio reception mode

While receiving an HD Radio broadcast, the unit tunes to digital or analog audio automatically due to the receiving condition.

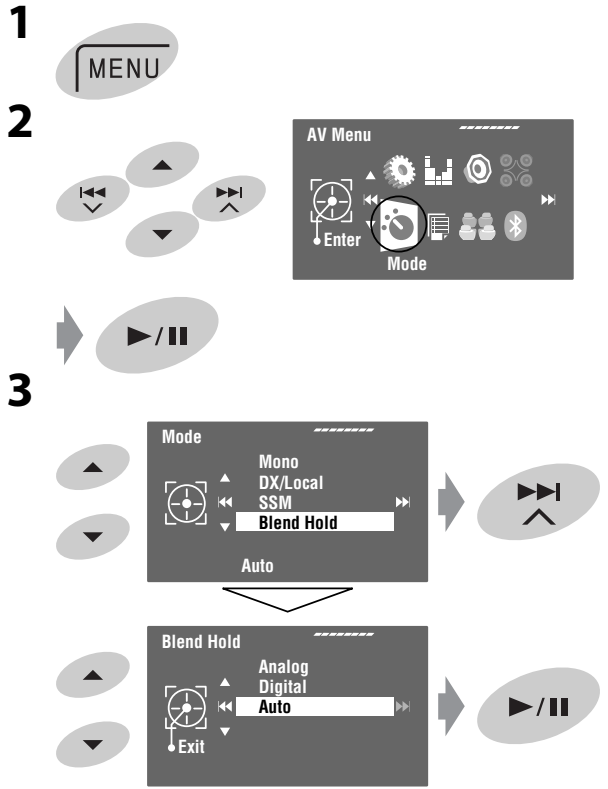

**Analog:** Tuning to analog audio only

**Digital:** Tuning to digital audio only

**Auto:** Switch between digital and analog audio automatically

- If no sound can be heard from the selected setting, change the setting to <ANALOG> or <DIGITAL>.
- The setting automatically changes to <AUTO> if you tuned in to or change to another station, or if you turned off the power.
- This setting cannot take effect for the conventional FM/AM stations.
- If the radio station forces the reception mode to digital, the DIGITAL indicator flashes.

## Tuning in to stations with sufficient signal strength

This function works only for FM bands.

Once you have activated this function (selected <Local>), it always works when searching for FM stations.

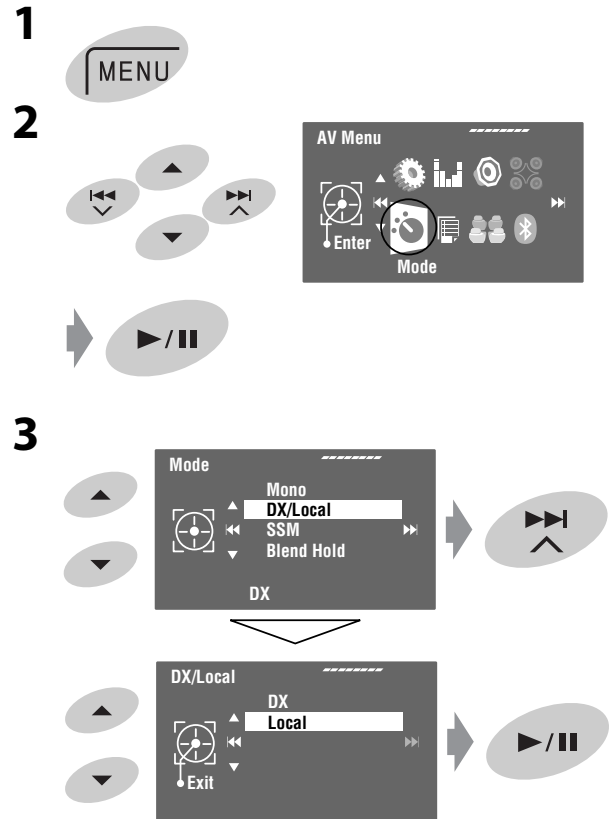

Only stations with sufficient signal strength will be detected.

- The DX indicator goes off, then the LO indicator lights up.
- During SSM search (page 12), this function cancels temporarily.

# Listening to other external components

## AV-INPUT

You can connect an external component to the LINE IN/VIDEO IN plugs.

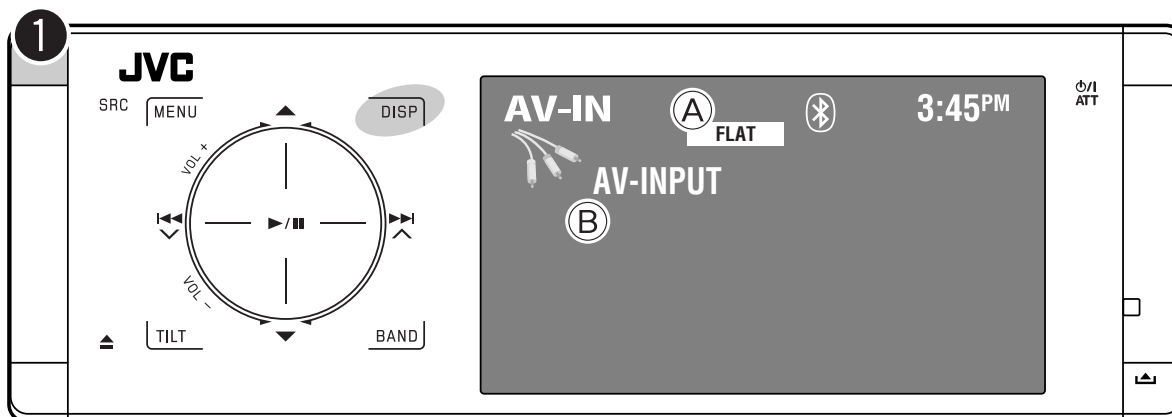

**DISP:** Touch if necessary. (☞ page 9)

- Ⓐ Sound mode (☞ page 50)
- Ⓑ Assigned title (☞ page 51)

### Preparation:

Make sure the appropriate <AV Input> setting is selected for the connected component. (☞ page 56)

- 1 Select "AV Input."
- 2 Turn on the connected component and start playing the source.

### Navigation screen

When you connect a Navigation System to the unit, you can view the navigation screen regardless of the source.

#### Preparation:

Make sure <AV Input> setting is selected for <Navigation>. (☞ page 56)

To watch the navigation screen, touch **DISP** repeatedly. (☞ page 9)

- The aspect ratio of the navigation screen is fixed to <Full> regardless of the <Aspect> setting. (☞ page 53)
- When you do not connect the Navigation System but connect an audio component to LINE IN plugs, you can use "AV Input" for listening to the audio source.



## EXT-INPUT

You can connect an external component to the CD changer jack on the rear using the Line Input Adapter—KS-U57 (not supplied) or AUX Input Adapter—KS-U58 (not supplied).

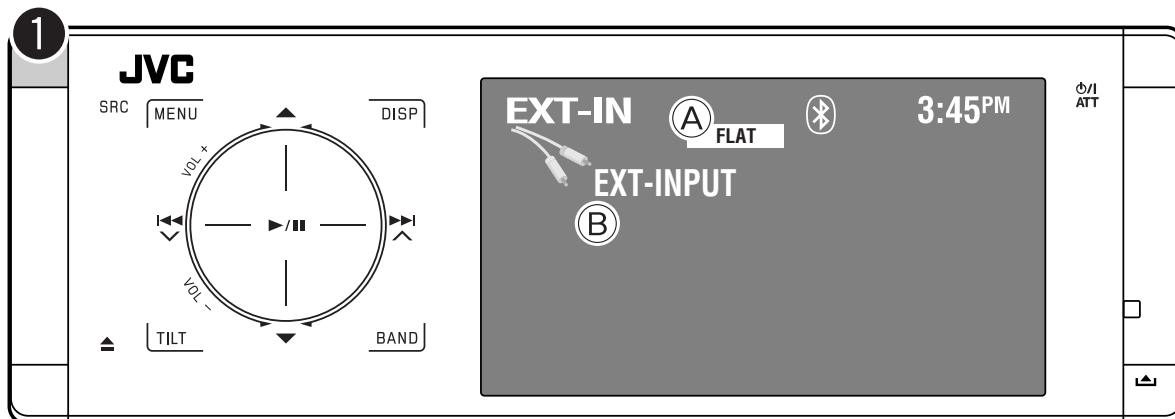

Ⓐ Sound mode (➔ page 50)

Ⓑ Assigned title (➔ page 51)

### **Preparation:**

Make sure <External Input> is selected for <External Input>. (➔ page 56)

- 1 Select "External Input."
- 2 Turn on the connected component and start playing the source.

# Sound equalization

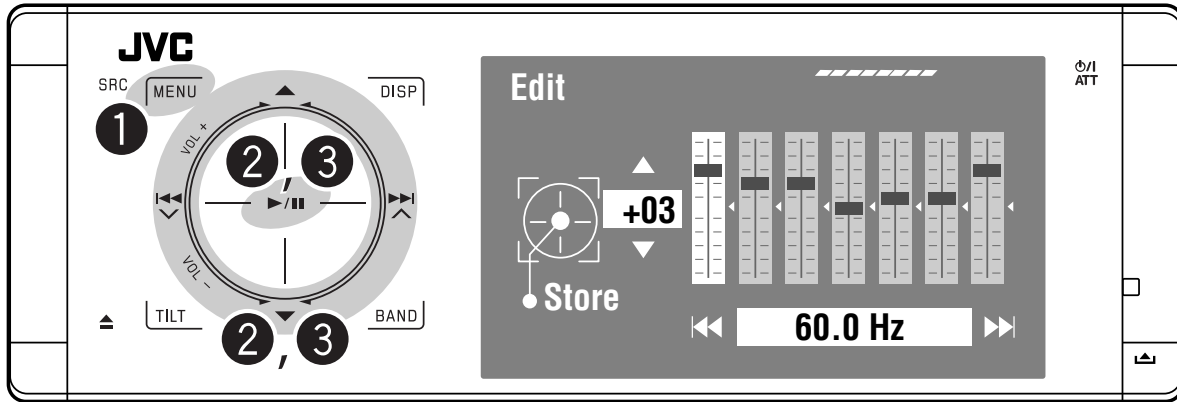

## Selecting a sound mode

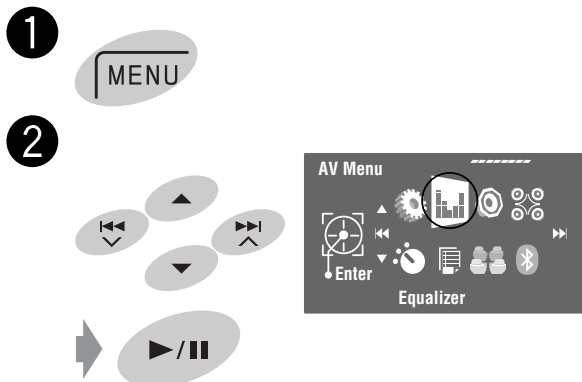

### 3 Select a sound mode.



You can select one of the following sound modes:

<Flat>, <Hard Rock>, <R&B>, <Pop>, <Jazz>, <Dance>, <Country>, <Reggae>, <Classic>, <User1>, <User2>, or <User3>

- For preset equalizing values of each sound mode, see page 67.
- For multi-channel source, the sound mode is temporarily canceled.

## Storing your own adjustments

You can store your adjustments into <User1>, <User2>, and <User3>.

- 1 Follow steps 1 and 2 on the left.
- 2 Select the item you want to adjust.



### 3 Adjust each setting.

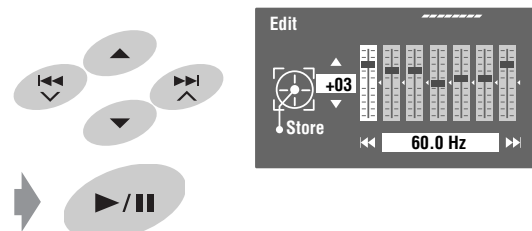

- 4 Select <User1>, <User2>, or <User3> then store the setting.



# Assigning titles to the sources

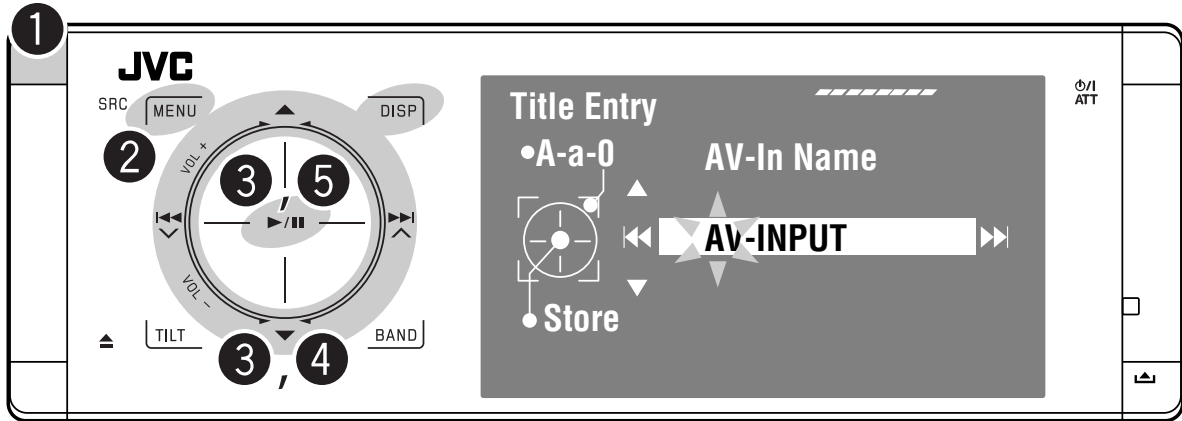

You can assign titles as follows.

FM/AM stations*	Up to 16 characters—up to 30 stations
“AV Input” “External Input”	Up to 16 characters

- If you try to assign a title to a 31st station, “Name Full” flashes on the monitor. Delete unwanted titles before assignment.

\* You cannot assign titles to the HD Radio stations.

Ex.: Assigning title to “AV Input”

## 1 Select “AV Input.”

- For FM/AM stations: Select the band, then tune into a station.

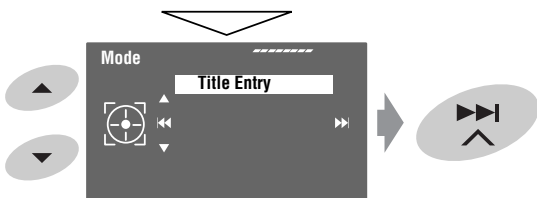
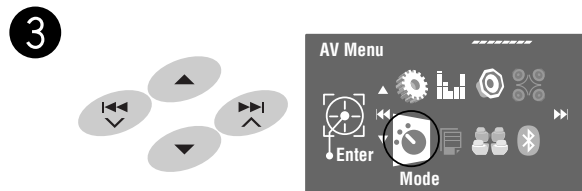

## 4 Assign a title.

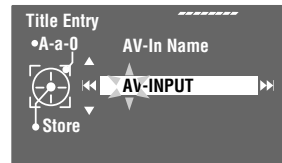

- 1 Select a character, then move the entering position.

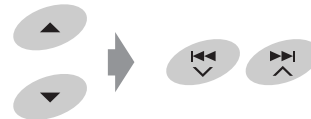

- To change the character set, touch DISP. (For available characters, see page 66.)
- To erase the whole characters, hold DISP.

- 2 Repeat step 1 until you finish entering the title.

## 5 Finish the procedure.



# Menu items

ENGLISH

## Menu operations

For details of the menu operations, page 6.

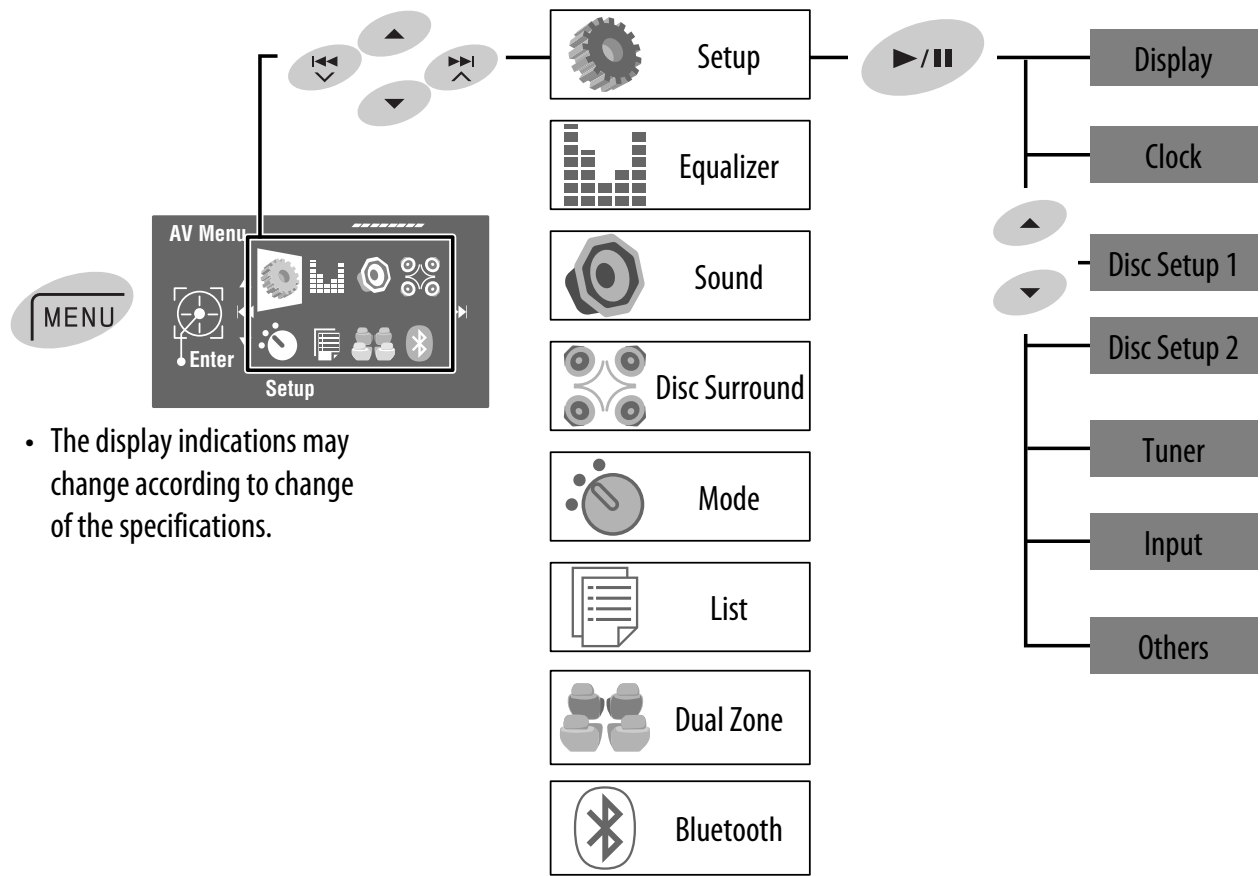







- The display indications may change according to change of the specifications.

Initial: Underlined

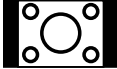
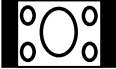

## Setup

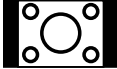
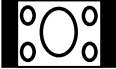
	Menu items	Selectable settings, [reference page]
<b>Display</b>	Demonstration	<b>Off:</b> Cancels. <b>On:</b> Activates the demonstration on the monitor.
	Wall Paper	You can select the background picture of the monitor. <b>Grid, Silk, Metal, Plain</b>
	Color	You can select the background color of the monitor. <b>Blue, Light-Blue, Red, Orange, Yellow, Green, Purple, Dark-Blue, Dark-Green, Brown, Light-Brown, Black</b>
	Scroll	<b>Off:</b> Cancels. <b>Once:</b> Scrolls the source information once. <b>Auto:</b> Repeats scrolling (5-second intervals). • Holding <b>DISP</b> (on the unit) scrolls the information regardless of this setting.
	Tag Display	<b>Off:</b> Cancels. <b>On:</b> Shows the Tag data while playing MP3/WMA/WAV/AAC tracks.

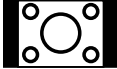
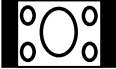
Menu items	Selectable settings, [reference page]															
<b>Dimmer</b>	<b>Off:</b> Cancels. <b>On:</b> Activates dimmer. <b>Auto:</b> Dims the monitor when you turn on the headlights.*1 <b>Time Set:</b> Touch ►►1 to display the time setting screen, then set the Dimmer On/Off times.															
<b>Bright</b>	You can adjust brightness of the monitor. –15 (darkest) to +15 (brightest); Initial <b>00</b>															
<b>Picture Adjust</b> *2	You can adjust the following to make the monitor clear and legible for watching the playback picture. The setting will be stored for “Disc/USB” and “AV Input.” –15 to +15; Initial <b>0</b> <b>Bright:</b> Adjust if the picture is too bright or too dark. <b>Contrast:</b> Adjust the contrast. <b>Color:</b> Adjust the color of the picture—lighter or darker. <b>Tint:</b> Adjust the tint if the human skin color is unnatural.															
<b>Aspect</b> *3	You can change the aspect ratio of the picture. <table border="1" data-bbox="935 821 1429 1306"> <thead> <tr> <th data-bbox="935 821 1183 867"></th> <th colspan="2" data-bbox="1183 821 1429 867">Aspect ratio of incoming signal</th> </tr> <tr> <th data-bbox="935 867 1183 913"></th> <th data-bbox="1183 867 1260 913">4:3</th> <th data-bbox="1260 867 1429 913">16:9</th> </tr> </thead> <tbody> <tr> <td data-bbox="935 913 1183 1003"> <b>Full:</b>            For 16:9 original pictures         </td> <td data-bbox="1183 913 1260 1003">  </td> <td data-bbox="1260 913 1429 1003">  </td> </tr> <tr> <td data-bbox="935 1003 1183 1220"> <b>Auto:</b> </td> <td colspan="2" data-bbox="1183 1003 1429 1220"> <ul style="list-style-type: none"> <li>• For “Disc”: Aspect ratio is automatically selected to match to the incoming signals.</li> <li>• For other video sources: Aspect ratio is fixed at &lt;Regular&gt;.</li> </ul> </td> </tr> <tr> <td data-bbox="935 1220 1183 1306"> <b>Regular:</b>            For 4:3 original pictures         </td> <td data-bbox="1183 1220 1260 1306">  </td> <td data-bbox="1260 1220 1429 1306">  </td> </tr> </tbody> </table>		Aspect ratio of incoming signal			4:3	16:9	<b>Full:</b> For 16:9 original pictures			<b>Auto:</b>	<ul style="list-style-type: none"> <li>• For “Disc”: Aspect ratio is automatically selected to match to the incoming signals.</li> <li>• For other video sources: Aspect ratio is fixed at &lt;Regular&gt;.</li> </ul>		<b>Regular:</b> For 4:3 original pictures		
		Aspect ratio of incoming signal														
		4:3	16:9													
	<b>Full:</b> For 16:9 original pictures															
<b>Auto:</b>	<ul style="list-style-type: none"> <li>• For “Disc”: Aspect ratio is automatically selected to match to the incoming signals.</li> <li>• For other video sources: Aspect ratio is fixed at &lt;Regular&gt;.</li> </ul>															
<b>Regular:</b> For 4:3 original pictures																
<b>Language</b> *4	Select the indication language shown on the monitor. <b>English, Español, Français, Deutsch, Italiano, Nederlands, Svenska, Dansk, Русский, Português</b> <ul style="list-style-type: none"> <li>• The characters you can enter for assigning the titles also change according to the language selected, [66]</li> </ul>															







\*1 The ILLUMINATION CONTROL lead connection is required. (☞ “Installation/Connection Manual”)

\*2 Adjustable only when the source is a disc or USB containing pictures or movies, or “AV Input.”

\*3 Not adjustable for audio sources.

\*4 After you change the indication language setting, turn off then on the power so that your setting takes effect.

	Menu items	Selectable settings, [reference page]
Clock	Time Set	Initial <b>1:00 AM</b> , [7]
	Time Format	<b>12Hours, 24Hours</b>
	OSD Clock	<b>Off:</b> Cancels. <b>On:</b> Displays the clock time while playing back a video source.
	Clock Adjust	<b>Off:</b> Cancels. <b>Auto:</b> The built-in clock is automatically adjusted using the clock time data provided via the satellite radio channel.
	Time Zone <sup>*1*2</sup>	Select your residential area from one of the following time zones for clock adjustment. <b>Alaska, Pacific, Mountain, Central, Eastern, Atlantic, Newfoundland</b>
	DST <sup>*1*2</sup> (Daylight Saving Time)	Activates this if your residential area is subject to DST. <b>Off:</b> Cancels. <b>On:</b> Activates daylight saving time.
Disc Setup 1 <sup>*3</sup>	Menu Language	Select the initial disc menu language; Initial <b>English</b> ([7] also page 67).
	Audio Language	Select the initial audio language; Initial <b>English</b> ([7] also page 67).
	Subtitle	Select the initial subtitle language or erase the subtitle (<Off>); Initial <b>Off</b> ([7] also page 67).
	Monitor Type	Select the monitor type to watch a wide screen picture on the external monitor. <b>16:9:</b> Select when the aspect ratio of the external monitor is 16:9. <b>4:3 Letterbox/4:3 Pan Scan:</b> Select when the aspect ratio of the external monitor is 4:3. Refer to the illustrations on the left to see how the pictures are shown on the monitor.
	OSD Position	Select the position of the on-screen bar, [25]. <b>1:</b> Higher position <b>2:</b> Lower position
	File Type	Select playback file type when a disc/USB contains different types of files. You can store this setting separately for each source — “Disc” and “USB.” <b>Audio:</b> Plays back audio files. <b>Still Picture:</b> Plays back JPEG files. <b>Video:</b> Plays back DivX/MPEG1/MPEG2 files. <b>Audio&amp;Video:</b> Plays back audio files and DivX/MPEG1/MPEG2 files.
	DivX Regist. (Registration)	This unit has its own Registration Code. Once you have played back a file with which the Registration Code recorded, this unit’s Registration Code is overwritten for copyright protection.
	iPod Artwork	<b>Off:</b> Cancels. <b>On:</b> Activates artwork display. To display artwork, touch <b>DISP</b> repeatedly. [9] • Refer also to page 65.

Menu items	Selectable settings, [reference page]
<p><b>D. (Dynamic) Range Compres. (Compression)</b></p>	<p>You can enjoy a powerful sound at a low volume level while playing Dolby Digital software.  <b>Auto:</b> Select to apply the effect to multi-channel encoded software.  <b>On:</b> Select to always use this function.</p>
<p><b>Speaker Size</b></p> <p>Select the speaker </p> <p>Adjust the speaker size </p>	<p>You can adjust the speaker size setting.</p> <ul style="list-style-type: none"> <li>• <b>Front SPK:</b> <u>S</u>mall, <u>L</u>arge</li> <li>• <b>Center SPK:</b> <u>N</u>one, <u>S</u>mall, <u>L</u>arge</li> <li>• <b>Rear SPK:</b> <u>N</u>one, <u>S</u>mall, <u>L</u>arge</li> <li>• <b>Subwoofer:</b> <u>O</u>n, <u>O</u>ff</li> <li>• Speaker size: &lt;Large&gt; for 13 cm (5-1/4 inch) diameter or more; &lt;Small&gt; for 13 cm (5-1/4 inch) or less.</li> <li>• Front speakers and rear speakers cannot be adjusted separately the left and right.</li> </ul> <p><b>Regardless of the setting above...</b></p> <ul style="list-style-type: none"> <li>• No sound comes out of the subwoofer while playing Dolby Pro Logic II Movie or Music if the front speaker is set to &lt;Large&gt;.</li> <li>• No sound comes out of the center speaker when surround is deactivated.</li> </ul>
<p><b>Speaker Level</b></p> <p>Select the speaker </p> <p>Adjust the speaker level </p>	<p>You can adjust the output level of the activated speakers (👉 &lt;Speaker Size&gt; above), monitoring the test tone.</p> <p><b>Front Lch/Center Ch/Front Rch/Rear Rch/Subwoofer*4/Rear Lch:</b>  Adjust the output level of each speaker in the range of <b>-10dB</b> to <b>+10dB</b>; Initial <b>0dB</b>.</p> <ul style="list-style-type: none"> <li>• Hold <b>▶/■</b> to turn on and off the test tone.</li> </ul>
<p><b>Speaker Distance</b></p> <p>Select the speaker </p> <p>Adjust the speaker distance </p>	<p>You can adjust the speaker output timing.</p> <p><b>Front Lch/Center Ch/Front Rch/Rear Rch/Rear Lch:</b>  Adjust the speaker distance from the listening position in the range of <b>15 cm/6 inches</b> to <b>600 cm/240 inches</b> in 15 cm/6 inch step; Initial <b>120 cm/48 inch</b> (for center speaker), <b>150 cm/60 inch</b> (for other speakers).</p> <ul style="list-style-type: none"> <li>• Hold <b>DISP</b> to change the measuring unit—<b>cm</b> and <b>inch</b>.</li> </ul>

\*1 Appears only when SIRIUS Satellite Radio or XM Satellite Radio is connected.

\*2 Set <Clock Adjust> to <Auto> then touch **▶▶1** to display these setting items.

\*3 Selectable only for "Disc" and "USB." (Playback stops when you select one of the items.)

\*4 This subwoofer level setting takes effect only when surround is activated. (👉 also pages 22 and 23)

	Menu items	Selectable settings, [reference page]
TUNER	IF Band Width <sup>*1</sup>	<p><b>Auto:</b> Increases the tuner selectivity to reduce interference noises between adjacent stations. (Stereo effect may be lost.)</p> <p><b>Wide:</b> Subject to the interference from adjacent stations, but sound quality will not be degraded and the stereo effect will remain.</p>
	Area Setting	<p><b>US:</b> When using in North/Central/South America. FM/AM intervals are set to 200 kHz/10 kHz.</p> <p><b>Europe:</b> When using in any other areas. FM/AM intervals are set to 50 kHz (100 kHz during auto search)/9 kHz.</p> <p><b>South America:</b> When using in South American countries where FM interval is 100 kHz. AM interval is set to 10 kHz.</p>
	SIRIUS ID <sup>*2</sup>	Your SIRIUS identification number appears on the monitor.
Input	AV Input <sup>*3</sup>	<p>You can determine the use of LINE IN and VIDEO IN plugs.</p> <p><b>Off:</b> Select when no component is connected (“AV Input” is skipped while selecting the source).</p> <p><b>iPod (Off):</b> Select when connecting the iPod using the USB Audio and Video cable for iPod. 🗨 [38]</p> <p><b>Audio&amp;Video:</b> Select when connecting an AV component such as a VCR.</p> <p><b>Audio:</b> Select when connecting an audio component such as a portable audio player.</p> <p><b>Camera<sup>*4</sup>:</b> Select when connecting the rear view camera.</p> <p><b>Navigation:</b> Select when connecting a Navigation System. 🗨 [48]</p>
	External Input <sup>*5</sup>	<p>For connecting an external component to the CD changer jack on the rear.</p> <p><b>Changer/iPod<sup>*6</sup>:</b> CD changer or iPod 🗨 [40, 41]</p> <p><b>External Input:</b> Any other than the above. 🗨 [49]</p> <ul style="list-style-type: none"> <li>For connecting KS-SRA100/XMDJVC100, this setting is not required. It is automatically detected.</li> </ul>
Others	Beep	<p><b>Off:</b> Cancels.</p> <p><b>On:</b> Activates the key-touch tone.</p>
	Telephone Muting <sup>*7</sup>	<p><b>Off:</b> Cancels.</p> <p><b>Muting1, Muting2:</b> Select either one which mutes the sounds while using the cellular phone.</p>



Menu items	Selectable settings, [reference page]																		
Others	<b>Illumination</b> You can turn off the touch pad controls and monitor lights while turning on the unit. 🗨️ [5]																		
	<table border="1"> <thead> <tr> <th></th> <th>Touch pad controls</th> <th>Monitor</th> </tr> </thead> <tbody> <tr> <td><b>Normal:</b></td> <td colspan="2">Always lights.</td> </tr> <tr> <td><b>Proximity/Motion:</b></td> <td>Lights up when your hand moves close to the controls.</td> <td>Always lights.</td> </tr> <tr> <td><b>Proxi/Motion-LCD:</b></td> <td colspan="2">Light up when your hand moves close to the controls.</td> </tr> <tr> <td><b>Touch Pad:</b></td> <td>Lights up when your finger touches the controls.</td> <td>Always lights.</td> </tr> <tr> <td><b>Touch Pad-LCD:</b></td> <td colspan="2">Light up when your finger touches the controls.</td> </tr> </tbody> </table>		Touch pad controls	Monitor	<b>Normal:</b>	Always lights.		<b>Proximity/Motion:</b>	Lights up when your hand moves close to the controls.	Always lights.	<b>Proxi/Motion-LCD:</b>	Light up when your hand moves close to the controls.		<b>Touch Pad:</b>	Lights up when your finger touches the controls.	Always lights.	<b>Touch Pad-LCD:</b>	Light up when your finger touches the controls.	
		Touch pad controls	Monitor																
	<b>Normal:</b>	Always lights.																	
	<b>Proximity/Motion:</b>	Lights up when your hand moves close to the controls.	Always lights.																
	<b>Proxi/Motion-LCD:</b>	Light up when your hand moves close to the controls.																	
<b>Touch Pad:</b>	Lights up when your finger touches the controls.	Always lights.																	
<b>Touch Pad-LCD:</b>	Light up when your finger touches the controls.																		
<b>Initialize</b>	Initialize all settings you have made in <b>&lt;AV Menu&gt;</b> . Hold <b>▶/  </b> , then reset the unit. 🗨️ [3]																		



## Equalizer

**Flat/Hard Rock/R&B/Pop/Jazz/Dance/Country/Reggae/Classic/User1/User2/User3**, 🗨️ [50]

- \*1 *Appears only when an HD Radio tuner box is connected.*
- \*2 *Appears only when a SIRIUS Satellite Radio is connected.*
- \*3 *Not selectable when "AV Input" is selected as the source.*
- \*4 *The REVERSE GEAR SIGNAL lead connection is required. 🗨️ "Installation/Connection Manual." The rear view through the camera appears on the monitor in "Full" aspect ratio (regardless of the aspect ratio setting) when you shift the gear to the reverse (R) position.*
- \*5 *Not selectable when the component connected to the CD changer jack is selected as the source.*
- \*6 *The name of the component detected through the CD changer jack is shown.*
- \*7 *The TEL MUTING lead connection is required. 🗨️ "Installation/Connection Manual."*



## Sound

Menu items	Selectable settings, [reference page]
<b>Fader/Balance</b> Adjusts fader  Adjust balance 	Adjust fader—speaker output balance between the front and rear speakers. <ul style="list-style-type: none"> <li>• Upmost—front only</li> <li>• Downmost—rear only</li> </ul> When using a two-speaker system, set the fader to the center ( <b>00</b> ). Adjust balance—speaker output balance between the left and right speakers. <ul style="list-style-type: none"> <li>• Leftmost—left only</li> <li>• Rightmost—right only</li> </ul>
<b>Volume Adjust</b>	Adjust and store auto-adjustment volume level for each source, comparing to the FM volume level. The volume level will automatically increase or decrease when you change the source. –12 to +12; Initial <b>00</b> <ul style="list-style-type: none"> <li>• For digital sources: You can make the adjustments separately depending on the audio format—Dolby Digital/DTS and the others.</li> </ul>
<b>Subwoofer Level</b> *1	Adjust the subwoofer output level. –06 to +08; Initial <b>00</b>
<b>High Pass Filter</b>	<b>Through:</b> Select when the subwoofer is not connected. <b>On:</b> Select when the subwoofer is connected.
<b>Crossover</b>	Adjust the crossover frequency between the front/rear speakers and the subwoofer. <b>80Hz, 120Hz, 150Hz</b>
<b>Amplifier Gain</b>	You can change the maximum volume level of this unit. <b>Off:</b> Deactivates the built-in amplifier. <b>Low Power:</b> Select this if the maximum power of the speakers is less than 50 W. <b>High Power</b>
<b>Rear Speaker</b> *2	You can activate/deactivate the rear speakers. <b>Off, On</b>



## Disc Surround\*3

Menu items	Selectable settings, [reference page]
<b>Surround Off</b>	Select to deactivate the surround function.
<b>Surround On</b>	Select to activate the surround function.  [23] <b>Auto, Through, Dolby PLII Movie, Dolby PLII Music</b> <ul style="list-style-type: none"> <li>• When you select &lt;Dolby PLII Music&gt;, you can adjust &lt;Panorama&gt; and &lt;Center Width&gt;.*4</li> </ul>



## Mode\*5

Menu items	Selectable settings, [reference page]
<b>Mono</b>	Only for FM bands. ( <b>Off, On</b> ), [12]
<b>SSM</b>	Only for FM bands of "Tuner" and FM/AM bands of "HD Radio." [12, 47]
<b>DX/Local*6</b>	Only for FM bands of "HD Radio." ( <b>DX, Local</b> ), [47]
<b>Blend Hold*6</b>	Only for "HD Radio." [47]
<b>Title Entry</b>	Only for FM/AM stations of "Tuner," "AV Input," and "External Input." [51]
<b>Repeat/Random</b>	Only for "Disc," "USB," "USB iPod," "Changer," "iPod," and "Bluetooth." [17, 30, 37, 39, 40, 42]
<b>AudioBooks</b>	Only for "USB iPod." ( <b>Normal, Faster, Slower</b> ) [39]



## List

The accessible lists differ depending on the source. [13, 18, 38, 41, 45]



## Dual Zone

**Off, On, On/Surround On**, [26]



## Bluetooth

	Menu items	Selectable settings, [reference page]
<b>Dial Menu*7</b>	Redial	Select one of the call methods, [34]
	Received Calls	
	Phonebook	
	Preset Calls	
	Phone Number	
	Voice Dialling	

\*1 This setting takes effect only when surround is deactivated. (also pages 22 and 23)

\*2 This setting takes effect only when Dual Zone is activated. (also page 26)

\*3 Selectable only for "Disc" and "USB."

\*4 This setting takes effect only when the center speaker is activated.

\*5 Items listed under <Mode> vary among the playback sources.

\*6 Appears only when an HD Radio tuner box is connected.

\*7 Only for the device connected for Bluetooth phone.

	Menu items	Selectable settings, [reference page]
Device Menu	Phone Connect/Audio Connect	Only for the registered devices. Establish the connection with the registered device,  [32]
	Phone Disconnect/Audio Disconnect	Only for the device being connected. Disconnect the current device before connecting another device,  [32]
	Delete Pairing	Only for the registered devices. Delete the registered devices,  [33]
	New Pairing	Enter the PIN code to establish the connection,  [32] Once the connection is established, it is registered in the unit. You can connect the unit and the device by using <Phone Connect>/<Audio Connect> ( above) from the next time on.
Settings	Auto Connect	When the unit is turned on, the connection is established automatically with... <b>Off:</b> No Bluetooth device. <b>Last:</b> The last connected Bluetooth device.
	Auto Answer	<b>Off:</b> The unit does not answer the calls automatically. Answer the calls manually. <b>On:</b> The unit answers the incoming calls automatically. <b>Reject:</b> The unit refuses all incoming calls.
	SMS Notify	<b>On:</b> The unit informs you of the arrival of a message by ringing and displaying "Receiving Message." <b>Off:</b> The unit does not inform you of the arrival of a message.
	Add Phonebook	Copy the phone book memory of a cellular phone into the unit. You can register up to 50 phone numbers,  [35]
	MIC Setting	Adjust the built-in microphone volume. <b>01, 02, 03</b>
	Phone Volume	Adjust the phone volume. <b>00 to 30 or 50*1, Initial 15</b>
	Initialize	Initialize all settings you have made in <Bluetooth>. <b>Yes:</b> Initializes the settings. <b>No:</b> Cancels.
	Information	The following information is shown: <b>Name:</b> The unit name <b>Address:</b> The Mac address of the unit <b>Version:</b> The Bluetooth software/hardware versions*2 <b>Phone Device/Audio Device:</b> The connected device names

\*1 Depends on the amplifier gain control. ( page 58)

\*2 If you wish to receive more information about Bluetooth, visit the following JVC web site:  
<<http://www.jvc-victor.co.jp/english/car/>>

When operating the Bluetooth device, refer also to the instructions supplied with the device.

# Maintenance

## How to clean the connector

Frequent detachment will deteriorate the connectors. To minimize this possibility, periodically wipe the connectors with a cotton swab or cloth moistened with alcohol, being careful not to damage the connectors.

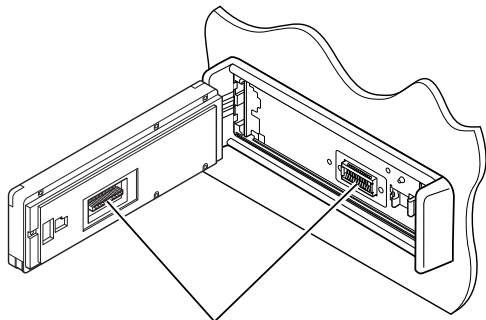

Connectors

## Moisture condensation

Moisture may condense on the lens inside the unit in the following cases:

- After starting the heater in the car.
- If it becomes very humid inside the car.

Should this occur, the unit may malfunction. In this case, eject the disc and leave the unit turned on for a few hours until the moisture evaporates.

## How to handle discs

When removing a disc from its case, press down the center holder of the case and lift the disc out, holding it by the edges.

Center holder



- Always hold the disc by the edges. Do not touch its recording surface.

When storing a disc into its case, gently insert the disc around the center holder (with the printed surface facing up).

- Make sure to store discs into the cases after use.

## To keep discs clean

A dirty disc may not play correctly. If a disc does become dirty, wipe it with a soft cloth in a straight line from center to edge.



- Do not use any solvent (for example, conventional record cleaner, spray, thinner, benzene, etc.) to clean discs.

## To play new discs

New discs may have some rough spots around the inner and outer edges. If such a disc is used, this unit may reject the disc.



To remove these rough spots, rub the edges with a pencil or ball-point pen, etc.

### Do not use the following discs:



Single CD—8 cm (3-3/16") disc



Warped disc

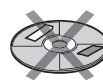

Sticker and sticker residue



Stick-on label



Unusual shape

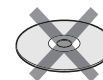

C-thru Disc (semi-transparent disc)

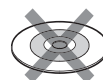

Transparent or semi-transparent parts on its recording area

## More about this unit

### ■ General

#### Turning on the power

- By pressing SRC (source) on the unit, you can also turn on the power. If the source is ready, playback starts.

### ■ Tuner (FM only)

#### Storing stations in memory

- When SSM is over, received stations are preset in No. 1 (lowest frequency) to No. 6 (highest frequency).

### ■ Disc

#### General

- In this manual, words “track” and “file” are interchangeably used.
- This unit can only play back audio CD (CD-DA) files if different type of audio files (MP3/WMA/WAV/AAC) are recorded in the same disc.
- This unit can display only one-byte characters. No other characters can be correctly displayed.

#### Inserting a disc

- When a disc is inserted upside down or has no playable files, “Cannot play this disc Check the disc” appears on the monitor. Eject the disc.

#### Ejecting a disc

- If the ejected disc is not removed within 15 seconds, the disc is automatically inserted again into the loading slot to protect it from dust.

### Changing the source

- If you change the source, playback also stops without ejecting the disc.  
Next time you select “Disc” for the playback source, disc play starts from where it stopped previously.

### Playing Recordable/Rewritable discs

- This unit can recognize a total of 5 000 files and 250 folders (a maximum of 999 files per folder).
- Use only “finalized” discs.
- This unit can play back multi-session discs; however, unclosed sessions will be skipped while playing.
- This unit can recognize a total 25 characters for file/folder names.
- Some discs or files may not be played back due to their characteristics or recording conditions.

### Playing DVD-VR

- For details about DVD-VR format and play list, refer to the instructions supplied with the recording equipment.

### ■ File playback

#### Playing DivX files

- This unit can play back DivX files with the extension code <.divx>, <.div>, <.avi> (regardless of the letter case—upper/lower).
- This unit supports the DivX files whose resolution is 720 x 576 pixels or less.
- Audio stream should conform to MP3 or Dolby Digital.
- The file encoded in the interlaced scanning mode may not be played back correctly.
- The maximum bit rate for video signals (average) is 4 Mbps .

## **Playing MPEG1/MPEG2 files**

- This unit can play back MPEG1/MPEG2 files with the extension code <.mpg>, <.mpeg>, or <.mod>\*.
  - \* <.mod> is an extension code used for the MPEG2 files recorded by JVC Everio camcorders. The MPEG2 files with the <.mod> extension code cannot be played back when stored on a USB mass storage class device.
- The stream format should conform to MPEG system/program stream.
- The file format should be MP@ML (Main Profile at Main Level)/SP@ML (Simple Profile at Main Level)/MP@LL (Main Profile at Low Level).
- Audio streams should conform to MPEG1 Audio Layer-2 or Dolby Digital.
- The maximum bit rate for video signals (average) is 4 Mbps.

## **Playing JPEG files**

- This unit can play back JPEG files with the extension code <.jpg>, or <.jpeg>.
- It is recommended that you record a file at 640 x 480 resolution.
- This unit can play back baseline JPEG files. Progressive JPEG files or lossless JPEG files cannot be played.

## **Playing MP3/WMA/WAV/AAC files**

- This unit can play back files with the extension code <.mp3>, <.wma>, <.wav>, or <.m4a> (regardless of the letter case—upper/lower).
- This unit can play back the files meeting the conditions below:
  - Bit rate:
    - MP3/WMA: 32 kbps — 320 kbps
    - AAC: 16 kbps — 320 kbps
  - Sampling frequency:
    - 48 kHz, 44.1 kHz, 32 kHz (for MPEG1)
    - 24 kHz, 22.05 kHz, 16 kHz (for MPEG2)
    - 48 kHz, 44.1 kHz, 32 kHz, 22.05 kHz (for WMA)
    - 44.1 kHz (for WAV)
    - 48 kHz, 44.1 kHz (for AAC)

- This unit can show ID3 Tag Version 1.0/1.1/2.2/2.3/2.4 (for MP3). This unit can also show WAV/WMA/AAC Tag.
- This unit can play back files recorded in VBR (variable bit rate).
  - Files recorded in VBR have a discrepancy in elapsed time indication.
- This unit cannot play back the following files:
  - MP3 files encoded with MP3i and MP3 PRO format.
  - MP3 files encoded with Layer 1/2.
  - WMA files encoded with lossless, professional, and voice format.
  - WMA files which are not based upon Windows Media® Audio.
  - WMA/AAC files copy-protected with DRM.
  - AAC files copy-protected with FairPlay (except those stored on an iPod).
  - Files which have the data such as AIFF, ATRAC3, etc.

## **Enjoying surround sounds**

- If <Surround On> is selected, “MULTI” surround playback automatically starts for multi-channel encoded discs regardless of the <Surround On> setting.
- You cannot activate surround for MPEG multi-channel DVD Video, DivX 2-channel and MPEG 2-channel sources. If <Surround On> is selected, stereo sounds are emitted only through the front speakers. “FRONT 2CH” appears on the source information screen.
- When “FIX” appears on the source information screen, no sound comes out of the subwoofer.
- When <AUTO> is selected, downsampling is performed for DVD Video (LPCM only) and DVD-VR (LPCM only).

## ■ USB

- If “No USB device” appears after removing a device, reattach a device or select another playback source.
- When the USB device has no playable files, or has not been formatted correctly, “Cannot play this device Check the device” appears on the monitor.
- The unit cannot recognize a USB device whose rating is other than 5 V and exceeds 500 mA.
- While playing from a USB device, the playback order may differ from other players.
- This unit may be unable to play back some USB devices or some files due to their characteristics or recording conditions.
- USB devices equipped with special functions such as data security functions cannot be used with the unit.
- Do not use a USB device with 2 or more partitions.
- Depending on the shape of the USB devices and connection ports, some USB devices may not be attached properly or the connection might be loose.
- When connecting a USB device, refer also to its instructions.
- Connect only one USB device to the unit at a time. Do not use a USB hub.
- This unit may not recognize a USB device connected through a USB card reader.
- When connecting with a USB cable, use the USB 2.0 cable.
- This unit may not play back files in a USB device properly when using a USB extension cord.
- This unit cannot assure proper functions or supply power to all types of the devices.
- This unit can recognize a total of 5 000 files and 250 folders (a maximum of 999 files per folder).
- This unit can recognize a total of 25 characters for file/folder names.
- For MPEG1/2 files: The maximum bit rate for video signals (average) is 2 Mbps.

## ■ Bluetooth operations

### General

- While driving, do not perform complicated operation such as dialing the numbers, using phone book, etc. When you perform these operations, stop your car in a safe place.
- Some Bluetooth devices may not be connected to this unit depending on the Bluetooth version of the device.
- This unit may not work for some Bluetooth devices.
- Connecting condition may vary depending on circumstances around you.
- When the unit is turned off, the device is disconnected.

### Warning messages for Bluetooth operations

#### **Connection Error:**

The device is registered but the connection has failed. Use <Phone Connect>/<Audio Connect> to connect the device again. (☞ page 32)

#### **Error:**

Try the operation again. If “Error” appears again, check if the device supports the function you have tried.





#### **Please Wait...:**

The unit is preparing to use the Bluetooth function. If the message does not disappear, turn off and turn on the unit, then connect the device again (or reset the unit).



## Icons for phone types

- These icons indicate the phone type set on the device.

	Cellular phone
	Household phone
	Office
	General
	Other than above

## iPod operations

- You can control the following types of iPods:
  - **Through the USB 2.0 cable**
    - iPod video (5th Generation)\*
    - iPod nano
    - iPod nano (2nd Generation)
  - **Through the interface adapter**
    - iPod with dock connector (3rd Generation)
    - iPod with Click Wheel (4th Generation)
    - iPod mini
    - iPod photo
    - iPod nano
    - iPod video (5th Generation)
- \* To watch the video, connect the iPod using USB Audio and Video cable (not supplied).
- If the iPod does not play correctly, update your iPod software to the latest version. For details about updating your iPod, visit <<http://www.apple.com>>.
- When you turn on this unit, the iPod is charged through the unit.
- While the iPod is connected, all operations from the iPod are disable. Perform all operations from this unit.
- The text information may not be displayed correctly.
- The text information scrolls on the monitor. This unit can display up to 40 characters when using the interface adapter and up to 128 characters when using the USB 2.0 cable or USB Audio and Video cable.

### Notice:

When operating an iPod, some operations may not be performed correctly or as intended. In this case, visit the following JVC web site:

- For the USB connection: <<http://www.jvc-victor.co.jp/english/car/>>
- For the interface adapter connection: <<http://www.jvc.co.jp/english/car/support/ks-pd100/index.html>>

### For the USB connection:

When <iPod Artwork> is set to <On>:

Do not press any keys during the first 30 seconds or more of playing back any track containing artwork\*. It takes 30 seconds or more to display artwork and no operations are available while loading it.

\* The picture displayed on the iPod's screen while playing back a track.

## HD Radio reception

- During SSM search...
  - All stations including conventional FM/AM stations are searched and stored for the selected band.

## Satellite radio operations

- You can also connect the JVC SIRIUS radio PnP (Plug and Play), using the JVC SIRIUS radio adapter, KS-U100K (not supplied) to the CD changer jack on the rear. (Select "External Input" as the source.) By turning on/off the power of the unit, you can turn on/off the JVC PnP. However, you cannot control it from this unit.
- To know more about SIRIUS Satellite radio or to sign up, visit <<http://www.sirius.com>>.
- For the latest channel listings and programming information, or to sign up for XM Satellite radio, visit <<http://www.xmradio.com>>.

### Menu items

- If you change the <Amplifier Gain> setting from <High Power> to <Low Power> while the volume level is set higher than “30,” the unit automatically changes the volume level to “VOL 30.”
- After you change any of <Menu Language/Audio Language/Subtitle> settings, turn off then on the power, and re-insert the disc (or insert another disc) so that your setting takes effect.
- When you select <16:9> for a picture whose aspect ratio is 4:3, the picture slightly changes due to the process for converting the picture width.
- Even if <4:3 Pan Scan> is selected, the screen size may become <4:3 Letterbox> for some discs.

#### About sounds reproduced through the rear terminals

- Speaker out/analog discrete output—LINE OUT (FRONT/REAR)/CENTER OUT/SUBWOOFER OUT: Multi-channel signals are emitted for a multi-channel encoded software. (When Dual Zone is activated, the same signal emitted through 2nd AUDIO OUT plugs are emitted for the main source “Disc.”)
  - 2nd AUDIO OUT: 2-channel signal is emitted when Dual Zone is activated. When playing a multi-channel encoded disc, multi-channel signals are downmixed.
- “DVD Logo” is a trademark of DVD Format/Logo Licensing Corporation registered in the US, Japan and other countries.
  - DivX, DivX Ultra Certified, and associated logos are trademarks of DivX, Inc. and are used under license.
  - Official DivX® Ultra Certified product
  - Plays all versions of DivX® video (including DivX® 6) with enhanced playback of DivX® media files and the DivX® Media Format
  - Microsoft and Windows Media are either registered trademarks or trademarks of Microsoft Corporation in the United States and/or other countries.
  - iPod and iTunes are trademarks of Apple Inc., registered in the U.S. and other countries.
  - HD Radio™ and the HD Radio Ready logo are proprietary trademarks of iBiquity Digital Corp.

### Characters you can enter for titles

In addition to the roman alphabet (A – Z, a – z), you can use the following characters to assign titles. (page 51)

- When <Русский> is selected for <Language>. (page 53)

#### Upper and lower cases

А	Б	В	Г	Д	Е	Ж	З	И	Й	К	Л	М	Н
О	П	Р	С	Т	У	Ф	Х	Ц	Ч	Ш	Щ	Ъ	Ы
Ь	Э	Ю	Я	Ё	space								

а	б	в	г	д	е	ж	з	и	й	к	л	м	н
о	п	р	с	т	у	ф	х	ц	ч	ш	щ	ъ	ы
ь	э	ю	я	ё	space								

#### Numbers and symbols

0	1	2	3	4	5	6	7	8	9	!	”	#	\$
%	&	'	(	)	*	+	,	-	.	/	:	;	=
?	@	`	space										

- When any language other than <Русский> is selected for <Language>. (page 53)

#### Upper and lower cases

Á	À	Â	Ä	Ã
Å	Æ	Œ	Č	Ć
Ç	É	È	Ê	Ë
Ğ	Í	Ì	Î	Ï
Ñ	Ó	Ò	Ô	Ö
Õ	Ø	Ř	Ŕ	Š
Ś	Ş	Ú	Û	Û
Ü	Ý	Ž	Ž	ß
ı	ı	đ		

á	à	â	ä	ã
å	æ	œ	č	ć
ç	é	è	ê	ë
ğ	í	ì	î	ï
ñ	ó	ò	ô	ö
õ	ø	ř	ŕ	š
ś	ş	ú	û	ü
ý	ÿ	ÿ	ÿ	ÿ
ı	ı	ı	ı	ı
đ				

#### Numbers and symbols

0	1	2	3	4
5	6	7	8	9
!	”	#	\$	%
&	'	(	)	`
=	-	+	*	/
@	?	;	:	,
.	space			

## ■ Preset equalizing values

Frequency	60.0 Hz	150.0 Hz	400.0 Hz	1.0kHz	2.5kHz	6.3kHz	15.0kHz
<b>Sound mode</b>							
Flat	00	00	00	00	00	00	00
Hard Rock	+03	+03	+01	00	00	+02	+01
R&B	+03	+02	+02	00	+01	+01	+03
Pop	00	+02	00	00	+01	+01	+02
Jazz	+03	+02	+01	+01	+01	+03	+02
Dance	+04	+02	00	-02	-01	+01	+01
Country	+02	+01	00	00	00	+01	+02
Reggae	+03	00	00	+01	+02	+02	+03
Classic	+02	+03	+01	00	00	+02	00
User1/2/3	00	00	00	00	00	00	00

## ■ Language codes (for DVD/DivX language selection)

Code	Language	Code	Language	Code	Language	Code	Language	Code	Language
AA	Afar	FA	Persian	KK	Kazakh	NO	Norwegian	ST	Sesotho
AB	Abkhazian	FI	Finnish	KL	Greenlandic	OC	Occitan	SU	Sundanese
AF	Afrikaans	FJ	Fiji	KM	Cambodian	OM	(Afan) Oromo	SW	Swahili
AM	Ameharic	FO	Faroese	KN	Kannada	OR	Oriya	TA	Tamil
AR	Arabic	FY	Frisian	KO	Korean (KOR)	PA	Panjabi	TE	Telugu
AS	Assamese	GA	Irish	KS	Kashmiri	PL	Polish	TG	Tajik
AY	Aymara	GD	Scots Gaelic	KU	Kurdish	PS	Pashto, Pushto	TH	Thai
AZ	Azerbaijani	GL	Galician	KY	Kirghiz	QU	Quechua	TI	Tigrinya
BA	Bashkir	GN	Guarani	LA	Latin	RM	Rhaeto-Romance	TK	Turkmen
BE	Byelorussian	GU	Gujarati	LN	Lingala	RN	Kirundi	TL	Tagalog
BG	Bulgarian	HA	Hausa	LO	Laothian	RO	Rumanian	TN	Setswana
BH	Bihari	HI	Hindi	LT	Lithuanian	RW	Kinyarwanda	TO	Tonga
BI	Bislama	HR	Croatian	LV	Latvian, Lettish	SA	Sanskrit	TR	Turkish
BN	Bengali, Bangla	HU	Hungarian	MG	Malagasy	SD	Sindhi	TS	Tsonga
BO	Tibetan	HY	Armenian	MI	Maori	SG	Sangho	TT	Tatar
BR	Breton	IA	Interlingua	MK	Macedonian	SH	Serbo-Croatian	TW	Twi
CA	Catalan	IE	Interlingue	ML	Malayalam	SI	Singhalese	UK	Ukrainian
CO	Corsican	IK	Inupiak	MN	Mongolian	SK	Slovak	UR	Urdu
CS	Czech	IN	Indonesian	MO	Moldavian	SL	Slovenian	UZ	Uzbek
CY	Welsh	IS	Icelandic	MR	Marathi	SM	Samoan	VI	Vietnamese
DZ	Bhutani	IW	Hebrew	MS	Malay (MAY)	SN	Shona	VO	Volapuk
EL	Greek	JA	Japanese	MT	Maltese	SO	Somali	WO	Wolof
EO	Esperanto	JL	Yiddish	MY	Burmese	SQ	Albanian	XH	Xhosa
ET	Estonian	JW	Javanese	NA	Nauru	SR	Serbian	YO	Yoruba
EU	Basque	KA	Georgian	NE	Nepali	SS	Siswati	ZU	Zulu

# Troubleshooting

What appears to be trouble is not always serious. Check the following points before calling a service center.

	Symptoms	Remedies/Causes
General	<ul style="list-style-type: none"> <li>No sound comes out of the center speaker.</li> </ul>	<ul style="list-style-type: none"> <li>Center speaker is not activated. (☞ page 55) Once you have reset the unit, make sure to activate the speaker again.</li> <li>Center speaker is used only for surround playback. No sound comes out for stereo playback.</li> </ul>
	<ul style="list-style-type: none"> <li>The monitor is not clear and legible.</li> </ul>	Sunshine from the windshield may cause this symptom. Adjust <Bright>. (☞ page 53)
	<ul style="list-style-type: none"> <li>The unit does not work at all.</li> </ul>	Reset the unit. (☞ page 3)
	<ul style="list-style-type: none"> <li>The remote controller does not work.</li> </ul>	Deactivate Dual Zone. (☞ page 26) (While Dual Zone is activated, the remote controller only functions for operating the DVD/CD player.)
	<ul style="list-style-type: none"> <li>"No Signal" appears.</li> </ul>	<ul style="list-style-type: none"> <li>Change the source.</li> <li>Start the playback on the external component connected to VIDEO IN plug.</li> <li>Check the cords and connections.</li> <li>Signal input is too weak.</li> </ul>
	<ul style="list-style-type: none"> <li>"Mecha Error Push Reset" appears on the monitor, and the control panel does not move.</li> </ul>	Reset the unit. (☞ page 3)
	<ul style="list-style-type: none"> <li>The touch pad controls do not respond properly.</li> <li>&lt;Illumination&gt; function does not work properly.</li> </ul>	<ul style="list-style-type: none"> <li>Keep your hands and controls clean and dry.</li> <li>Eliminate static electricity and do not place magnetic items near the unit.</li> <li>Leave the unit until the temperature becomes stable in the car.</li> <li>A rubber mat on the floor may cause this symptom. In this case, do not use the rubber mat.</li> </ul>

	Symptoms	Remedies/Causes
FM/AM	• SSM automatic presetting does not work.	Store stations manually. (👉 page 13)
	• Static noise while listening to the radio.	Connect the antenna firmly.
Disc playback	• Disc can be neither recognized nor played .	Eject the disc forcibly. (👉 page 3)
	• Disc cannot be ejected.	Unlock the disc. (👉 page 18)
	• Recordable/Rewritable discs cannot be played back. • Tracks on the Recordable/Rewritable discs cannot be skipped.	<ul style="list-style-type: none"> <li>• Insert a finalized disc.</li> <li>• Finalize the discs with the component which you used for recording.</li> </ul>
	• Playback does not start.	<ul style="list-style-type: none"> <li>• Insert the disc correctly again.</li> <li>• Region code of the DVD is not correct. (👉 page 4)</li> <li>• The format of files is not supported by the unit.</li> </ul>
	• The playback picture is not clear and legible.	Adjust items in <Picture Adjust>. (👉 page 53)
	• Sound and pictures are sometimes interrupted or distorted.	<ul style="list-style-type: none"> <li>• Stop playback while driving on rough roads.</li> <li>• Change the disc.</li> </ul>
	• No playback picture appears on the monitor.	Parking brake lead is not connected properly. (👉 "Installation/Connection Manual")
	• No picture appears on the external monitor.	<ul style="list-style-type: none"> <li>• Connect the video cord correctly.</li> <li>• Select the correct input on the external monitor.</li> </ul>
	• "Eject Error" or "Loading Error" appears on the monitor.	Changing the source by pressing <b>SRC</b> will solve this error.
	• Disc cannot be played back.	<ul style="list-style-type: none"> <li>• Change the disc.</li> <li>• Record the tracks using a compliant application in the appropriate discs. (👉 page 4)</li> <li>• Add appropriate extension codes to the file names.</li> </ul>
File playback	• Noise is generated.	The track played back is not a playable file format. Skip to another file.
	• Tracks are not played back as you have intended them to play.	Playback order may differ from the one played back using other players.
	• Elapsed playing time is not correct.	This sometimes occurs during playback. This is caused by how the tracks are recorded.
	• "Not Support" appears on the monitor and track skips.	The track is unplayable.

	Symptoms	Remedies/Causes
USB playback	<ul style="list-style-type: none"> <li>Noise is generated.</li> </ul>	<ul style="list-style-type: none"> <li>The track played back is not a playable file format (MP3/WMA/WAV/AAC). Skip to another file.</li> <li>Do not add the extension code &lt;.mp3&gt;, &lt;.wma&gt;, &lt;.wav&gt; or &lt;.m4a&gt; to non-MP3/WMA/WAV/AAC tracks.</li> </ul>
	<ul style="list-style-type: none"> <li>Tracks cannot play back as you have intended them to play.</li> </ul>	Playback order may differ from the one played back using other players.
	<ul style="list-style-type: none"> <li>"Now Reading..." keeps flashing on the monitor.</li> </ul>	<ul style="list-style-type: none"> <li>Readout time varies depending on the USB device.</li> <li>Do not use too many hierarchy, folders and empty folders.*               <ul style="list-style-type: none"> <li>* Folder that is physically empty or folder that contains data but does not contain valid MP3/WMA/WAV/AAC track.</li> </ul> </li> <li>Turn off the power then on again.</li> <li>Do not pull out or connect the USB device repeatedly while "Now Reading..." is displayed on the monitor.</li> </ul>
	<ul style="list-style-type: none"> <li>Correct characters are not displayed (e.g. album name).</li> </ul>	For available characters,  page 66.
	<ul style="list-style-type: none"> <li>While playing a track, sound is sometimes interrupted.</li> </ul>	The tracks have not been properly copied into the USB device. Copy tracks again into the USB device, and try again.

	Symptoms	Remedies/Causes
Bluetooth	<ul style="list-style-type: none"> <li>Bluetooth device does not detect the unit.</li> </ul>	<ul style="list-style-type: none"> <li>Search from the Bluetooth device again.</li> <li>Reset the unit. When “Open...” appears on the monitor, search from the Bluetooth device again.</li> </ul>
	<ul style="list-style-type: none"> <li>The unit does not make pairing with the Bluetooth device.</li> </ul>	<ul style="list-style-type: none"> <li>Enter the same PIN code for both the unit and target device. If the PIN code of the device is not indicated on its manuals, try “0000” or “1234.”</li> </ul>
	<ul style="list-style-type: none"> <li>Phone sound quality is poor.</li> </ul>	<ul style="list-style-type: none"> <li>Reduce the distance between the unit and the Bluetooth cellular phone.</li> <li>Move the car to place where you can get a better signal reception.</li> </ul>
	<ul style="list-style-type: none"> <li>The sound is interrupted or skipped while using a Bluetooth audio player.</li> </ul>	<ul style="list-style-type: none"> <li>Reduce the distance between the unit and the Bluetooth audio player.</li> <li>Disconnect the device connected for Bluetooth phone.</li> <li>Turn off, then turn on the unit.</li> <li>(When the sound is not yet restored,) connect the device again.</li> </ul>
	<ul style="list-style-type: none"> <li>The connected audio player cannot be controlled.</li> </ul>	Check whether the connected audio player supports AVRCP (Audio/Video Remote Control Profile).
	<ul style="list-style-type: none"> <li>The unit does not response when you tried to copy the phone book to the unit.</li> </ul>	You may have tried to copy the same entries (as stored) to the unit. Touch <b>BAND</b> to exit.
	<ul style="list-style-type: none"> <li>“No Audio Device” appears on the monitor.</li> </ul>	Connect this unit and the Bluetooth audio player correctly.
	<ul style="list-style-type: none"> <li>“No Voice Device” appears on the monitor.</li> </ul>	The connected cellular phone does not have the voice recognition system.
iPod playback	<ul style="list-style-type: none"> <li>The iPod does not turn on or does not work.</li> </ul>	<ul style="list-style-type: none"> <li>Check the connecting cable and its connection.</li> <li>Charge the battery.</li> </ul>
	<ul style="list-style-type: none"> <li>The sound is distorted.</li> </ul>	Deactivate the equalizer either on this unit or the iPod.
	<ul style="list-style-type: none"> <li>“Disconnect” appears on the monitor.</li> </ul>	Check the connecting cable and its connection.
	<ul style="list-style-type: none"> <li>Playback stops.</li> </ul>	The headphones are disconnected during playback. Restart playback.
	<ul style="list-style-type: none"> <li>“No Files” appears on the monitor.</li> </ul>	No tracks are stored. Import tracks to the iPod.
	<ul style="list-style-type: none"> <li>“Reset 01” – “Reset 07” appears on the monitor.</li> </ul>	Disconnect the adapter from both this unit and iPod. Then, connect them again.
	<ul style="list-style-type: none"> <li>“Reset 08” appears on the monitor.</li> </ul>	Check the connection between the adapter and this unit.
	<ul style="list-style-type: none"> <li>The iPod’s controls do not work after disconnecting from this unit.</li> </ul>	Reset the iPod.
<ul style="list-style-type: none"> <li>“Restricted Device” appears on the monitor.</li> </ul>	Check whether the connected iPod is compatible with this unit. (👉 page 65)	
<ul style="list-style-type: none"> <li>No operations are available while playing back a track containing artwork.</li> </ul>	Operate the unit after the artwork is loaded. (👉 page 65)	

	Symptoms	Remedies/Causes
CD changer	• "No Disc" appears on the monitor.	Insert a disc into the magazine.
	• "No Magazine" appears on the monitor.	Insert the magazine.
	• "Cannot play this disc Check the disc" appears on the monitor.	Disc does not include playable files. Replace the disc with playable files.
	• "Reset 08" appears on the monitor.	Connect this unit and the CD changer correctly and press the reset button of the CD changer.
	• "Reset 01" – "Reset 07" appears on the monitor.	Press the reset button of the CD changer.
	• The CD changer does not work at all.	Reset the unit. (👉 page 3)
Satellite radio	• "CALL 1-888-539-SIRIUS TO SUBSCRIBE" appears on the monitor.	Starts subscribing SIRIUS Satellite radio. (👉 page 43)
	• "No Signal" or "NO SIGNAL" appears on the monitor.	Move to an area with stronger signals.
	• "No Antenna" or "CHECK ANTENNA" appears on the monitor.	Connect the antenna firmly.
	• "Invalid Channel" appears on the monitor for about 5 seconds, then returns to the previous display when listening to the SIRIUS Satellite radio.	No broadcast on the selected channel. Select another channel or continue listening to the previous channel.
	• "CHANNEL----" appears on the display for about 2 seconds, then returns to the previous channel while listening to the XM Satellite radio.	Selected channel is no longer available or is unauthorized. Select another channel or continue listening to the previous channel.



	Symptoms	Remedies/Causes
Satellite radio	• “No Name” or “----” appears on the monitor.	No text information for the selected channel.
	• “Channel is Updating XX% completed” or “UPDATING” appears on the monitor and no sound can be heard.	The receiver is updating the channel information and it takes a few minutes to complete.
	• “OFF AIR” appears on the monitor while listening to the XM Satellite radio.	Selected channel is not broadcasting at this time. Select another channel or continue listening to the previous channel.
	• “LOADING” appears on the monitor while listening to the XM Satellite radio.	The unit is loading the channel information and audio. Text information is temporarily unavailable.
	• “Reset08” flashes on the monitor.	Reconnect this unit and the Satellite radio correctly and reset the unit.
	• Satellite radio does not work at all.	Reconnect the Satellite radio after a few seconds.
HD Radio reception	• Sound quality changes when receiving HD Radio stations.	Fix the reception mode either to <Digital> or <Analog> (👉 page 47).
	• No sound can be heard.	<ul style="list-style-type: none"> <li>• &lt;Analog&gt; is selected when receiving all digital broadcast of HD Radio station. Select &lt;Digital&gt; or &lt;Auto&gt; (👉 page 47).</li> <li>• &lt;Digital&gt; is selected when receiving weak digital signals or receiving conventional radio broadcast. Select &lt;Analog&gt; or &lt;Auto&gt; (👉 page 47).</li> </ul>
	• “Reset 8” appears on the display.	Reconnect this unit and the HD Radio tuner box correctly, then reset the unit.
AV-IN	• No picture appears on the monitor.	<ul style="list-style-type: none"> <li>• Turn on the video component if it is not on.</li> <li>• This unit is not connected to the video component correctly. Connect it correctly.</li> </ul>
	• The playback picture is not clear and legible.	Adjust items in <Picture Adjust>. (👉 page 53)

# Specifications

AMPLIFIER	Power Output:	<b>20 W RMS × 4 Channels at 4 Ω and ≤ 1% THD+N</b>		
	Signal-to-Noise Ratio:	80 dBA (reference: 1 W into 4 Ω)		
	Load Impedance:	4 Ω (4 Ω to 8 Ω allowance)		
	Equalizer Control Range:	Frequencies:	60.0 Hz, 150.0 Hz, 400.0 Hz, 1.0kHz, 2.5kHz, 6.3kHz, 15.0kHz	
		Level:	±10 dB	
	Audio Output Level LINE OUT (FRONT/ REAR)/CENTER OUT/ SUBWOOFER OUT:	Line-Out Level/Impedance:	5.0 V/20 kΩ load (full scale)	
		Output Impedance:	1 kΩ	
	Color System:	NTSC		
	Video Output (composite):	1 V <sub>p-p</sub> /75 Ω		
	Other Terminals:	Input:	LINE IN, VIDEO IN, USB input terminal, Antenna input	
Output:		2nd AUDIO OUT, VIDEO OUT		
Others:		CD changer, OE REMOTE		
FM/AM TUNER	Frequency Range:	FM (with channel interval set to 100 kHz or 200 kHz):	87.5 MHz to 107.9 MHz	
		FM (with channel interval set to 50 kHz):	87.5 MHz to 108.0 MHz	
		AM (with channel interval set to 10 kHz):	530 kHz to 1 710 kHz	
		AM (with channel interval set to 9 kHz):	531 kHz to 1 602 kHz	
	FM Tuner:	Usable Sensitivity:	11.3 dBf (1.0 μV/75 Ω)	
		50 dB Quieting Sensitivity:	16.3 dBf (1.8 μV/75 Ω)	
		Alternate Channel Selectivity (400 kHz):	65 dB	
		Frequency Response:	40 Hz to 15 000 Hz	
		Stereo Separation:	35 dB	
	AM Tuner:	Sensitivity/Selectivity:	20 μV/35 dB	
DVD/CD	Signal Detection System:	Non-contact optical pickup (semiconductor laser)		
	Frequency Response:	DVD, f <sub>s</sub> =48 kHz:	16 Hz to 22 000 Hz	
		DVD, f <sub>s</sub> =96 kHz:	16 Hz to 44 000 Hz	
		VCD/CD:	16 Hz to 20 000 Hz	
	Dynamic Range:	93 dB		
	Signal-to-Noise Ratio:	94 dB		
Wow and Flutter:	Less than measurable limit			

<b>MONITOR</b>	Screen Size:	3.5 inch wide liquid crystal display		
	Number of Pixel:	211 200 pixels: 960 (horizontal) × 220 (vertical)		
	Drive Method:	TFT (Thin Film Transistor) active matrix format		
	Color System:	PAL/NTSC		
	Aspect Ratio:	16:9 (wide)		
	Allowable Storage Temperature:	-10°C to +60°C (14°F to 140°F)		
	Allowable Operating Temperature:	0°C to +40°C (32°F to 104°F)		
<b>USB</b>	USB Standards:	USB 2.0 Full Speed		
	Data Transfer Rate:	Full Speed: Maximum 12 Mbytes Low Speed: Maximum 1.5 Mbytes		
	Compatible Device:	Mass storage class		
	Compatible File System:	FAT 32/16/12		
	Max. Current:	Less than 500 mA/5 V		
<b>BLUETOOTH</b>	Version:	Bluetooth 1.2 certified		
	Output Power:	+4 dBm Max. (Power class 2)		
	Service Area:	Within 10 m (10.9 yd)		
	Profile:	HFP (Hands-Free Profile) 1.5 OPP (Object Push Profile) 1.1 A2DP (Advanced Audio Distribution Profile) 1.2 AVRCP (Audio/Video Remote Control Profile) 1.3		
<b>GENERAL</b>	Power Requirements:	Operating Voltage:	DC 14.4 V (11 V to 16 V allowance)	
	Grounding System:	Negative ground		
	Allowable Operating Temperature:	0°C to +40°C (32°F to 104°F)		
	Dimensions (W × H × D):	Installation Size (approx.):	182 mm × 52 mm × 160 mm (7-3/16" × 2-1/16" × 6-5/16")	
		Panel Size (approx.):	188 mm × 58 mm × 12 mm (7-7/16" × 2-5/16" × 1/2")	
Mass (approx.):	2.2 kg (4.9 lbs) (excluding accessories)			

Design and specifications are subject to change without notice.

If a kit is necessary for your car, consult your telephone directory for the nearest car audio speciality shop.



**Having TROUBLE with operation?**

**Please reset your unit**

Refer to page of How to reset your unit

**Still having trouble??**

USA ONLY

**Call 1-800-252-5722**

**<http://www.jvc.com>**

**We can help you!**

**JVC**



EN, SP, FR

© 2008 Victor Company of Japan, Limited

0108MNMMDWJEIN

# JVC

## KD-ADV49 KD-AVX44

LVT1797-002A  
[J/C]

### Installation/Connection Manual Manual de instalación/conexión Manuel d'installation/raccordement

0108MNMMDWJEIN  
EN, SP, FR

©2008 Victor Company of Japan, Limited

ENGLISH

This unit is designed to operate on **12 V DC, NEGATIVE ground electrical systems**. If your vehicle does not have this system, a voltage inverter is required, which can be purchased at JVC car audio dealers.

#### WARNINGS

- DO NOT install any unit or wire any cable in a location where;
  - it may obstruct the steering wheel and gearshift lever operations, as this may result in a traffic accident.
  - it may obstruct the operation of safety devices such as air bags, as this may result in a fatal accident.
  - it may obstruct visibility.
- DO NOT operate any unit while manipulating the steering wheel, as this may result in a traffic accident.
- The driver must not watch the monitor while driving. It may lead to carelessness and cause an accident.
- The driver must not put on the headphones while driving. It is dangerous to shut off the outside sounds while driving.
- If you need to operate the unit while driving, be sure to look around carefully.
- If the parking brake is not engaged, "Parking Brake" appears on the monitor, and no playback picture will be shown.
  - This warning appears only when the parking brake lead is connected to the parking brake system built in the car.

#### Notes on electrical connections:

- Replace the fuse with one of the specified rating. If the fuse blows frequently, consult your JVC car audio dealer.
- It is recommended to connect speakers with a maximum power of more than 50 W (both at the rear and at the front, with an impedance of **4 Ω to 8 Ω**).  
If the maximum power is less than 50 W, change "Amplifier Gain" setting to prevent the speakers from being damaged (see page 58 of the INSTRUCTIONS).
- To prevent short circuits, cover the terminals of the UNUSED leads with insulating tape.
- The heat sink becomes very hot after use. Be careful not to touch it when removing this unit.

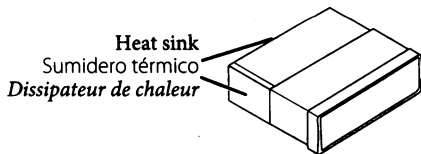

ESPAÑOL

Esta unidad está diseñada para funcionar con **12 V de CC, con sistemas eléctricos de masa NEGATIVA**. Si su vehículo no posee este sistema, será necesario un inversor de tensión, que puede ser adquirido en los concesionarios de JVC de equipos de audio para automóviles.

#### ADVERTENCIAS

- NO instale ningún receptor o tienda ningún cable en una ubicación donde;
  - Donde pueda obstruir la maniobra del volante de dirección y del cambio de engranajes, con el consiguiente riesgo de accidentes de tráfico.
  - Donde pueda obstruir el funcionamiento de dispositivos de seguridad tales como bolsas de aire, pues podría resultar en un accidente fatal.
  - Donde pueda obstruir la visibilidad.
- NO OPERE la unidad mientras está maniobrando el volante de dirección, pues podría producirse un accidente de tráfico.
- El conductor no debe mirar el monitor mientras conduce. Podría producirse un descuido, y causar un accidente.
- El conductor no deberá ponerse los auriculares mientras conduce. Es muy peligroso no escuchar los ruidos exteriores durante la conducción.
- Si es necesario operar la unidad mientras maneja, asegúrese de mirar atentamente en todas las direcciones.
- Si el freno de mano no está en uso, aparecerá "Parking Brake (Freno de Mano)" en la pantalla y no se mostrará ninguna secuencia de imagen.
  - Esta advertencia aparece únicamente cuando el cable del freno de estacionamiento se encuentra conectado al sistema del freno de estacionamiento incorporado al automóvil.

#### Notas sobre las conexiones eléctricas:

- Reemplace el fusible por uno con la corriente especificada. Si el fusible se quemase frecuentemente consulte con su concesionario de JVC de equipos de audio para automóviles.
- Se recomienda conectar los altavoces con una potencia máxima de más de 50 W (tanto atrás como adelante, con una impedancia de **4 Ω a 8 Ω**).  
Si la potencia máxima es de menos de 50 W, cambie "Amplifier Gain" para evitar daños en los altavoces (consulte la página 58 del MANUAL DE INSTRUCCIONES).
- Para evitar cortocircuitos, cubra los cables NO UTILIZADOS con cinta aislante.
- El sumidero térmico estará muy caliente después del uso. Asegúrese de no tocarlo al desmontar esta unidad.

FRANÇAIS

Cet appareil est conçu pour fonctionner sur des sources de **courant continu de 12 V à masse NEGATIVE**. Si votre véhicule n'offre pas ce type d'alimentation, il vous faut un convertisseur de tension, que vous pouvez acheter chez un revendeur d'autoradios JVC.

#### AVERTISSEMENTS

- **N'INSTALLEZ aucun appareil ni aucun câble dans un endroit où:**
  - où il peut gêner l'accès au volant ou au levier de vitesse car cela peut entraîner un accident de la circulation.
  - où il peut gêner la manipulation de dispositifs de sécurité tels que les airbags car cela peut entraîner un accident fatal.
  - où il peut gêner la visibilité.
- **NE COMMANDEZ pas l'appareil lors de la manipulation du volant car cela peut entraîner un accident de la circulation.**
- **Le conducteur ne doit pas regarder le moniteur lorsqu'il conduit. Cela peut lui faire perdre sa concentration et causer un accident.**
- **Le conducteur ne doit pas utiliser un casque d'écoute quand il est au volant. Il est en effet dangereux de bloquer les sons de la circulation routière pendant la conduite d'un véhicule.**
- **Si vous devez commander l'appareil pendant que vous conduisez, assurez-vous de bien regarder autour de vous.**
- **Si le frein à main n'est pas engagé, "Parking Brake (Frein à Main)" s'affiche sur le moniteur et aucune image de lecture n'apparaît.**
  - Cet avertissement apparaît uniquement quand le fil du frein de stationnement est connecté au système de frein de stationnement intégré à la voiture.

#### Remarques sur les connexions électriques:

- Remplacer le fusible par un de la valeur précisée. Si le fusible saute souvent, consulter votre revendeur d'autoradios JVC.
- Il est recommandé de connecter des enceintes avec une puissance de plus de 50 W (les enceintes arrière et les enceintes avant, avec une impédance comprise entre **4 Ω et 8 Ω**).  
Si la puissance maximum est inférieure à 50 W, changez "Amplifier Gain" pour éviter d'endommager vos enceintes (voir page 58 du MANUEL D'INSTRUCTIONS).
- Pour éviter les court-circuits, couvrir les bornes des fils qui ne sont PAS UTILISÉS avec de la bande isolante.
- Le dissipateur de chaleur devient très chaud après usage. Faire attention de ne pas le toucher en retirant cet appareil.

#### Required space for installation Espacio requerido para la instalación Espace nécessaire pour l'installation

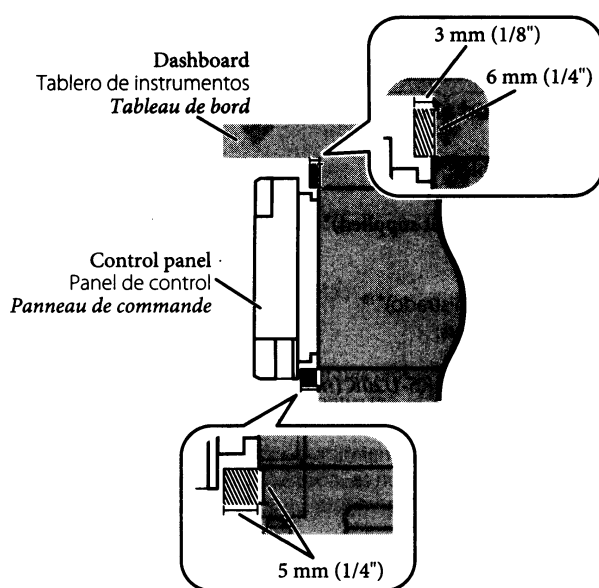

Trim plate is detached on this illustration for explanation.  
Para fines explicativos, se ha retirado la placa de guarnición en esta ilustración.  
La plaque de garniture est montrée détachée sur cette illustration pour les besoins de l'explication.

#### Parts list for installation and connection Lista de piezas para instalación y conexión Liste des pièces pour l'installation et raccordement

The following parts are provided for this unit. After checking them, please set them correctly.  
Con esta unidad se suministran las siguientes piezas. Después de inspeccionarlas, colóquelas correctamente.  
Les pièces suivantes sont fournies avec cet appareil. Après vérification, veuillez les placer correctement.

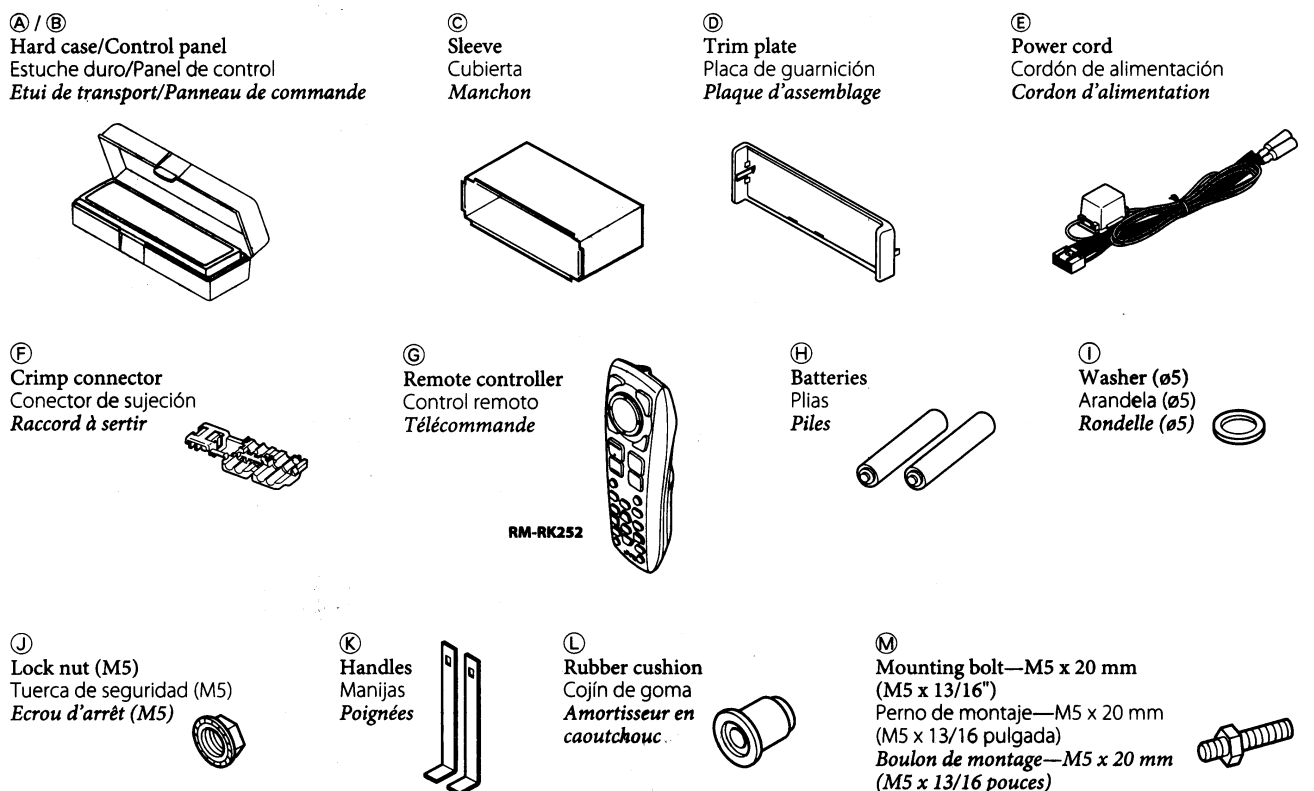

## INSTALLATION (IN-DASH MOUNTING)

The following illustration shows a typical installation. If you have any questions or require information regarding installation kits, consult your JVC car audio dealer or a company supplying kits.

- If you are not sure how to install this unit correctly, have it installed by a qualified technician.
- Make sure not to block the fan on the rear to maintain proper ventilation when installing the unit.
- You cannot install the unit on the car which has any obstacles in the space shown in "Required space for installation" on page 1.

### Caution when installing

Fit the unit into the mounting sleeve by using four corners of the trim plate.

- DO NOT press the panel (shaded in the illustration).

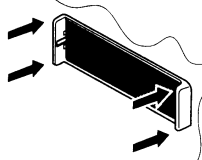

## INSTALACIÓN (MONTAJE EN EL TABLERO DE INSTRUMENTOS)

La siguiente ilustración muestra una instalación típica. Si tiene alguna pregunta o necesita información acerca de las herramientas para instalación, consulte con su concesionario de JVC de equipos de audio para automóviles o a una compañía que suministra tales herramientas.

- Si usted no está seguro de cómo instalar correctamente la unidad, hágala instalar por un técnico cualificado.
- Asegúrese de no bloquear las rendijas de ventilación del panel trasero, para poder mantener una buena ventilación una vez instalado.
- No podrá instalar la unidad en un coche en que haya algún obstáculo en el espacio indicado en "Espacio requerido para la instalación" en la página 1.

### Precaución en la instalación

Introduzca el receptor en la manga de montaje utilizando las cuatro esquinas de la placa decorativa.

- NO presione el panel (sombreado en la ilustración).

## INSTALLATION (MONTAGE DANS LE TABLEAU DE BORD)

L'illustration suivante est un exemple d'installation typique. Si vous avez des questions ou avez besoin d'information sur des kits d'installation, consulter votre revendeur d'autoradios JVC ou une compagnie d'approvisionnement.

- Si l'on n'est pas sûr de pouvoir installer correctement cet appareil, le faire installer par un technicien qualifié.
- Lors de l'installation assurez-vous de ne pas bloquer le ventilateur à l'arrière afin de permettre une ventilation correcte.
- Vous ne pouvez pas installer l'appareil sur une voiture qui a certains obstacles dans l'espace montré dans "Espace nécessaire pour l'installation" à la page 1.

### Précautions lors de l'installation

Fixez l'autoradio sur le manchon de montage en utilisant les quatre coins de la plaque de garniture.

- NE PUSSEZ PAS sur le panneau (en gris sur l'illustration).

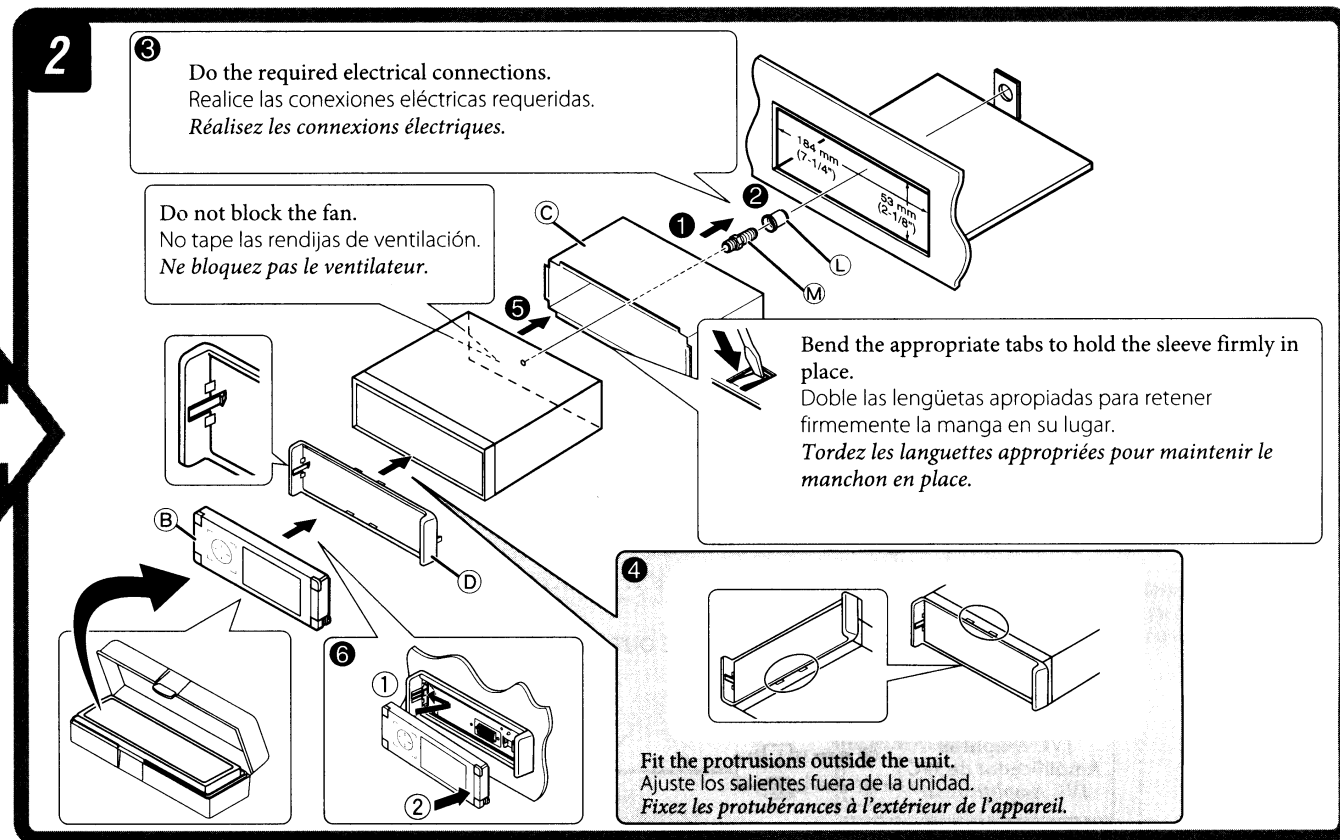
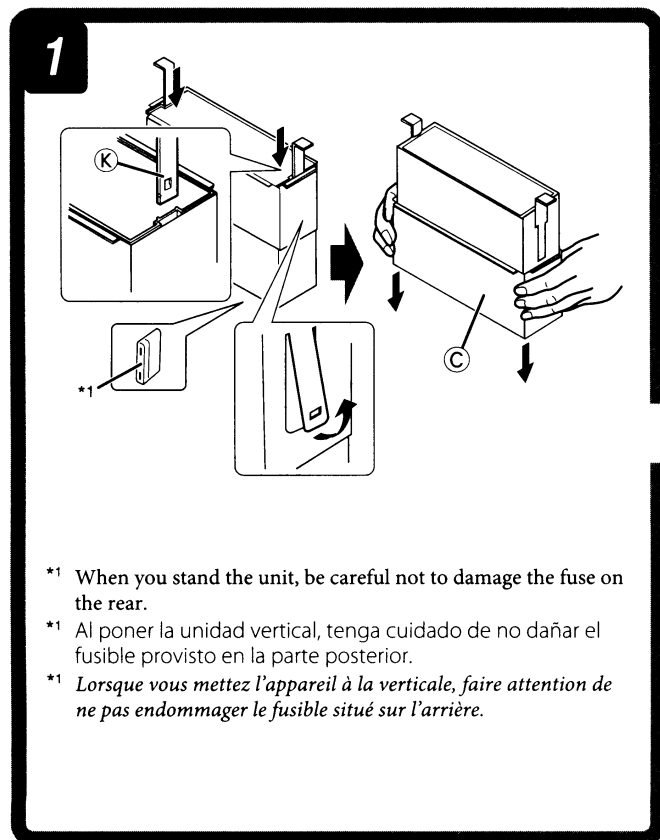

### When using the optional stay Cuando emplea un soporte opcional Lors de l'utilisation du hauban en option

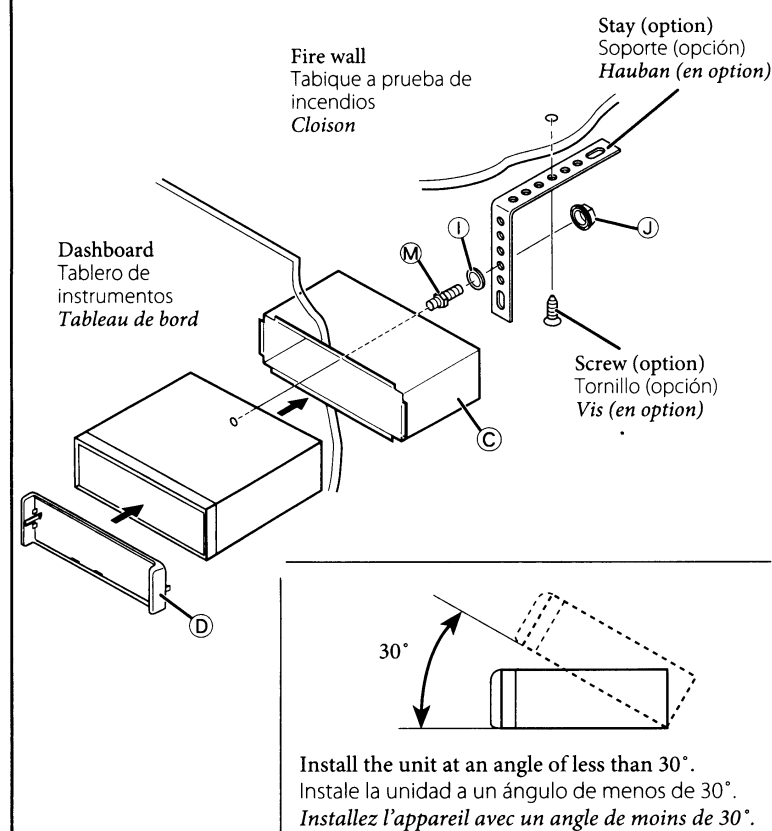

### When installing the unit without using the sleeve Instalación de la unidad sin utilizar la cubierta Lors de l'installation de l'appareil sans utiliser de manchon

In a car having the "Required space for installation" (see page 1), first remove the car radio and install the unit in its place.  
En un automóvil que disponga del "Espacio requerido para la instalación" (véase la página 1), primero desmonte la autorradio, e instale el receptor en su lugar.  
Dans une voiture avec l'"Espace nécessaire pour l'installation" (voir page 1), retirez d'abord l'ancien autoradio et installez cet autoradio à sa place.

Flat type screws—M5 x 8 mm (M5 x 3/8") \*2  
Tornillos tipo plano—M5 x 8 mm (M5 x 3/8 pulgada) \*2  
Vis à tête plate—M5 x 8 mm (M5 x 3/8 pouces) \*2

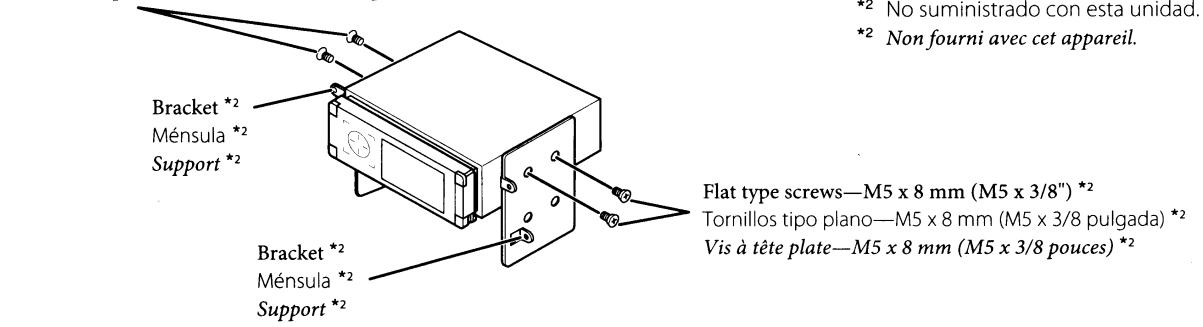

**Note:** When installing the unit on the mounting bracket, make sure to use the 8 mm (3/8") -long screws. If longer screws are used, they could damage the unit.  
**Nota:** Cuando instala la unidad en la ménsula de montaje, asegúrese de utilizar los tornillos de 8 mm (3/8 pulgada) de longitud. Si se utilizan tornillos más largos, éstos pueden dañar la unidad.  
**Remarque:** Lors de l'installation de l'appareil sur le support de montage, s'assurer d'utiliser des vis d'une longueur de 8 mm (3/8 pouces). Si des vis plus longues sont utilisées, elles peuvent endommager l'appareil.

### Removing the unit

Before removing the unit, release the rear section.

### Extracción de la unidad

Antes de extraer la unidad, libere la sección trasera.

### Retrait de l'appareil

Avant de retirer l'appareil, libérer la section arrière.

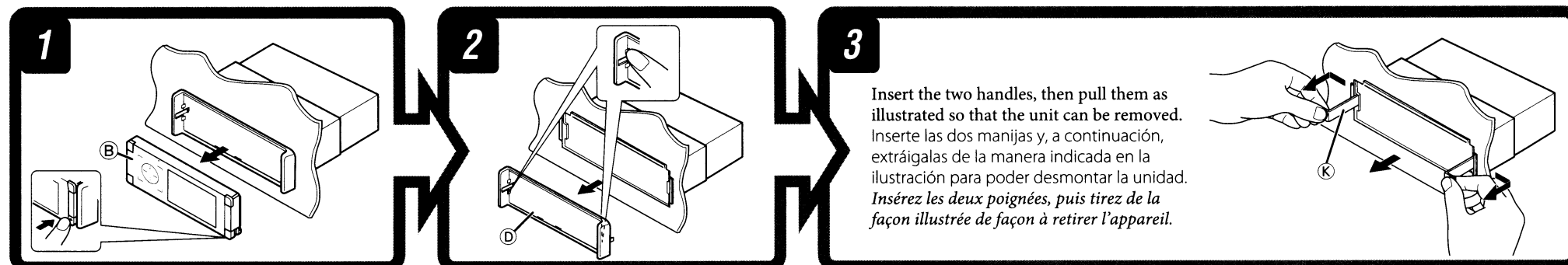

## ELECTRICAL CONNECTIONS

To prevent short circuits, we recommend that you disconnect the battery's negative terminal and make all electrical connections before installing the unit.

- Be sure to ground this unit to the car's chassis again after installation.

### PRECAUTIONS on power supply and speaker connections:

- DO NOT connect the speaker leads of the power cord to the car battery; otherwise, the unit will be seriously damaged.
- BEFORE connecting the speaker leads of the power cord to the speakers, check the speaker wiring in your car.

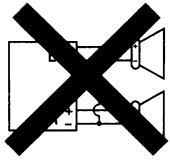

### Typical connections

**Before connecting:** Check the wiring in the vehicle carefully. Incorrect connection may cause serious damage to this unit. The leads of the power cord and those of the connector from the car body may be different in color.

- 1 Connect the colored leads of the power cord in the order specified in the illustration below.
- 2 Connect the antenna cord.
- 3 Finally connect the wiring harness to the unit.

## CONEXIONES ELECTRICAS

Para evitar cortocircuitos, recomendamos que desconecte el terminal negativo de la batería y que efectúe todas las conexiones eléctricas antes de instalar la unidad.

- Asegúrese de volver a conectar a masa esta unidad al chasis del automóvil después de la instalación.

### PRECAUCIONES sobre las conexiones de la fuente de alimentación y de los altavoces:

- NO conecte los conductores de altavoz del cable de alimentación a la batería de automóvil, pues podrían producirse graves daños en la unidad.
- ANTES de conectar a los altavoces los conductores de altavoz del cable de alimentación, verifique el conexionado de altavoz de su automóvil.

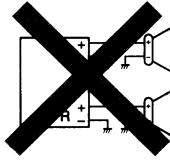

### Conexiones típicas

**Antes de la conexión:** Verifique atentamente el conexionado del vehículo. Una conexión incorrecta podría producir daños graves en la unidad.

Los cordones del cable de alimentación y los del conector procedentes de la carrocería del automóvil podrían ser de diferentes en color.

- 1 Conecte los conductores de color del cable de alimentación en el orden especificado en la ilustración de abajo.
- 2 Conecte el cable de antena.
- 3 Por último, conecte el cable de alimentación a la unidad.

## RACCORDEMENTS ELECTRIQUES

Pour éviter tout court-circuit, nous vous recommandons de débrancher la borne négative de la batterie et d'effectuer tous les raccordements électriques avant d'installer l'appareil.

- Assurez-vous de raccorder de nouveau la mise à la masse de cet appareil au châssis de la voiture après l'installation.

### PRÉCAUTIONS sur l'alimentation et la connexion des enceintes:

- NE CONNECTEZ PAS les fils d'enceintes du cordon d'alimentation à la batterie; sinon, l'appareil serait sérieusement endommagé.
- AVANT de connecter les fils d'enceintes du cordon d'alimentation aux enceintes, vérifiez le câblage des enceintes de votre voiture.



### Raccordements typiques

**Avant de commencer la connexion:** Vérifiez attentivement le câblage du véhicule. Une connexion incorrecte peut endommager sérieusement l'appareil.

Le fil du cordon d'alimentation et ceux des connecteurs du châssis de la voiture peuvent être différents en couleur.

- 1 Connectez les fils colorés du cordon d'alimentation dans l'ordre spécifié sur l'illustration ci-dessous.
- 2 Connectez le cordon d'antenne.
- 3 Finalement, connectez le faisceau de fils à l'appareil.

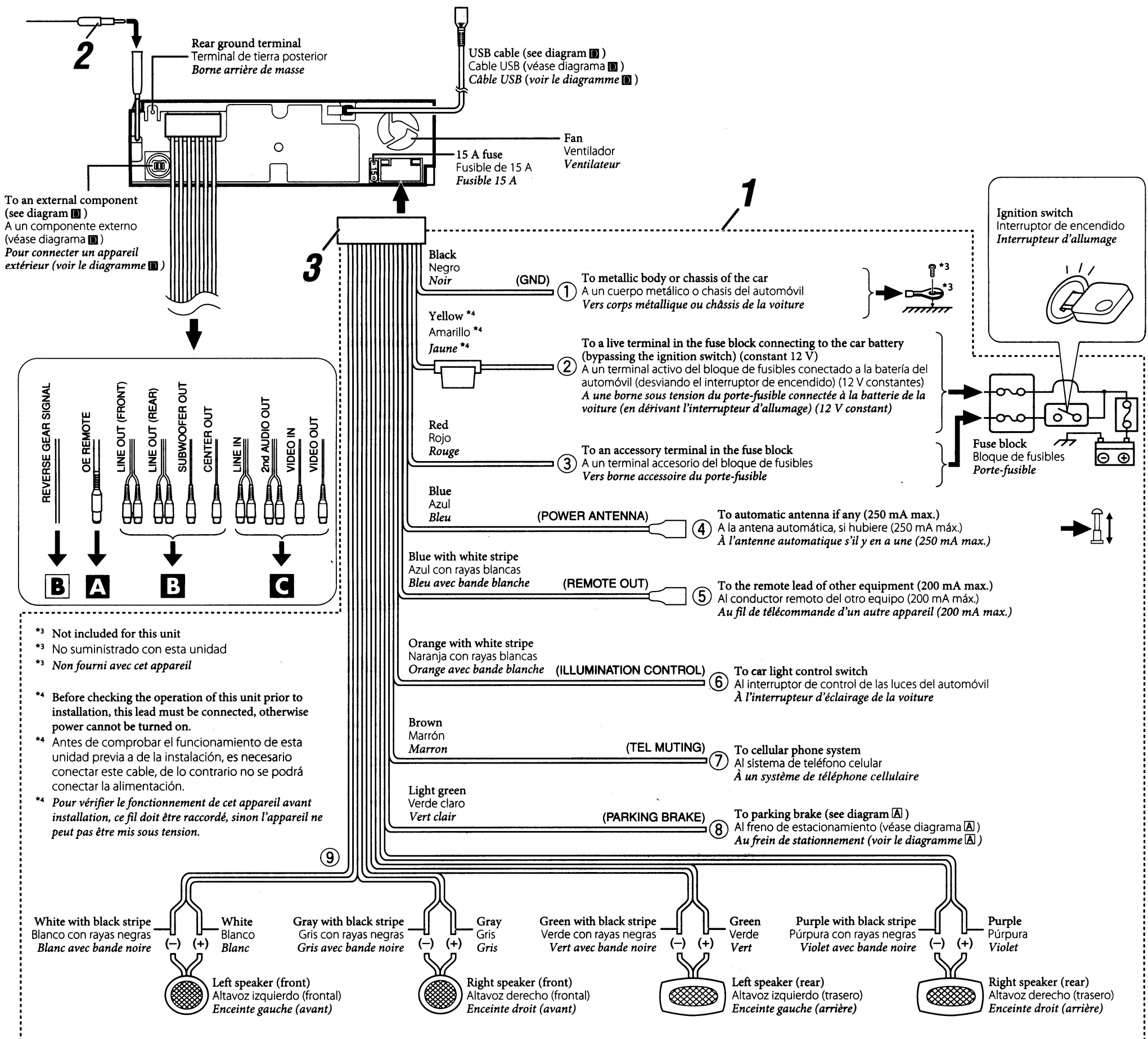

**A Connecting the parking brake lead / Conexión del cable del freno de estacionamiento / Connexion du cordon de frein de stationnement**

Connect the parking brake lead to the parking brake system built in the car.  
 Conecte el cable del freno de estacionamiento al sistema de freno de estacionamiento del automóvil.  
 Connectez le fil de frein de stationnement au système de frein de stationnement.

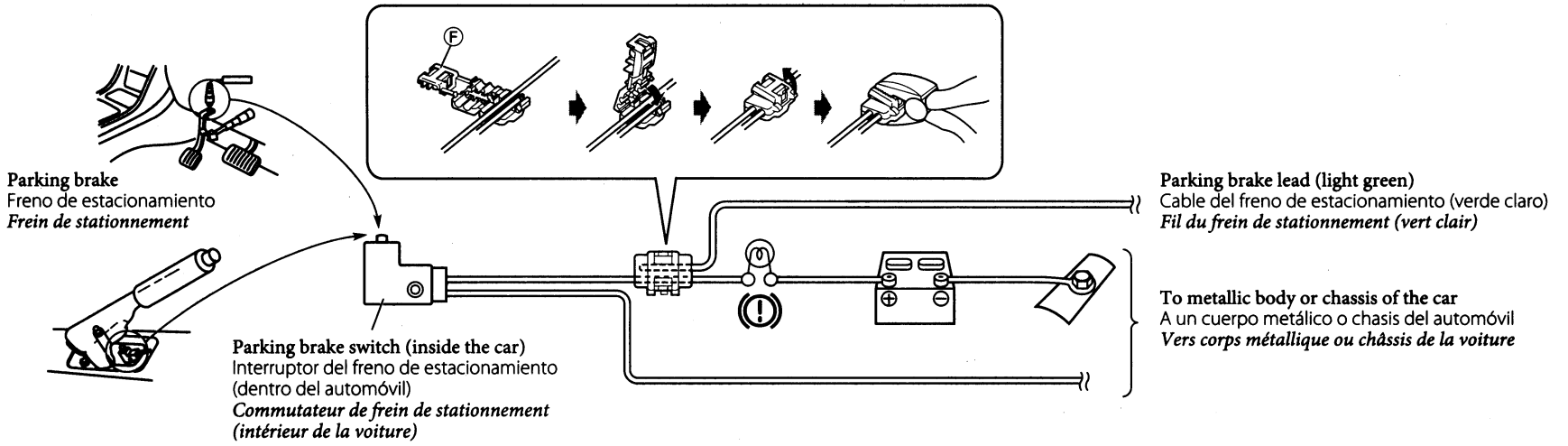

**B Connecting the reverse gear signal lead (for rear view camera) / Conexión del cable de señal del engranaje de marcha atrás (para la cámara trasera) / Connexion du fil de signal de marche arrière (pour la caméra du rétroviseur) (REVERSE GEAR SIGNAL)**

Locate the reverse lamp lead in the trunk.  
 Localice el conductor de la luz trasera en el compartimiento de equipajes.  
 Localisez le fil des feux de recul dans le coffre.

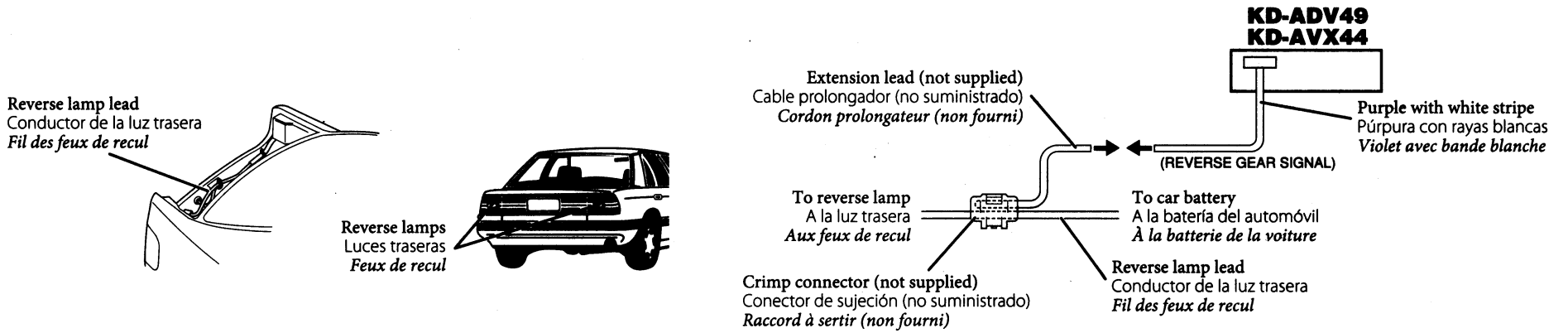

**A Connecting to the steering wheel remote controller / Conexión al control remoto del volante de dirección / Connexion de la télécommande de volant**

If your car is equipped with the steering wheel remote controller, you can operate this unit using the controller. For connection, an exclusive remote adapter (not supplied) which matches your car is required. For details, consult the same car audio dealer as where the unit is purchased.

Si su vehículo está equipado con control remoto en el volante de dirección, podrá hacer funcionar este receptor utilizando dicho control. Para la conexión, se requiere un adaptador remoto exclusivo (no suministrado) que sea adecuado para su automóvil. Para los detalles, consulte con el concesionario car audio donde compró el receptor.

Si votre voiture est munie d'une télécommande de volant, vous pouvez commander cet autoradio en utilisant la télécommande. Pour la connexion, un adaptateur de télécommande exclusif (non fourni) correspondant à votre voiture est requis. Pour en savoir plus, consultez le revendeur autoradio auprès duquel vous avez acheté cet autoradio.

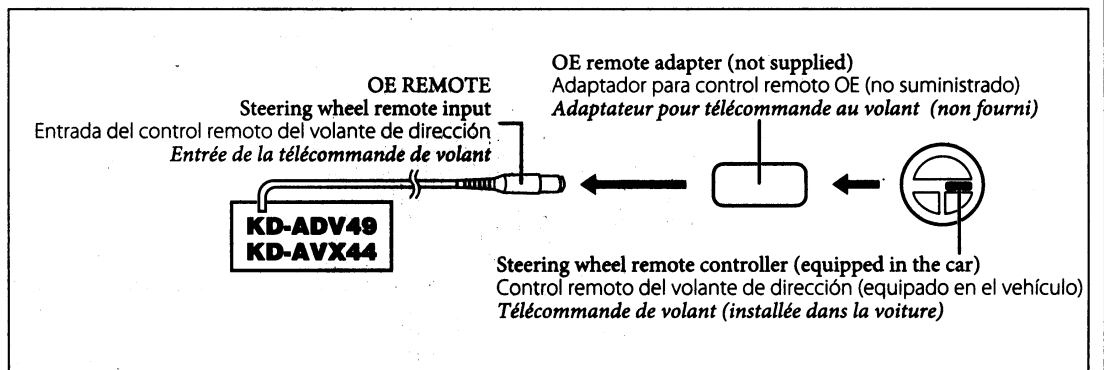

**TROUBLESHOOTING**

- **The fuse blows.**
  - \* Are the red and black leads connected correctly?
- **Power cannot be turned on.**
  - \* Is the yellow lead connected?
- **No sound from the speakers.**
  - \* Is the speaker output lead short-circuited?
- **Sound is distorted.**
  - \* Is the speaker output lead grounded?
  - \* Are the "-" terminals of L and R speakers grounded in common?
- **Noise interferes with sounds.**
  - \* Is the rear ground terminal connected to the car's chassis using shorter and thicker cords?
- **Unit becomes hot.**
  - \* Is the speaker output lead grounded?
  - \* Are the "-" terminals of L and R speakers grounded in common?
- **This unit does not work at all.**
  - \* Have you reset your unit?

**LOCALIZACION DE AVERIAS**

- **El fusible se quema.**
  - \* ¿Están los conductores rojo y negro correctamente conectados?
- **No es posible conectar la alimentación.**
  - \* ¿Está el cable amarillo conectado?
- **No sale sonido de los altavoces.**
  - \* ¿Está el cable de salida del altavoz cortocircuitado?
- **El sonido presenta distorsión.**
  - \* ¿Está el cable de salida del altavoz conectado a masa?
  - \* ¿Están los terminales "-" de los altavoces L y R conectados a una masa común?
- **Perturbación de ruido.**
  - \* ¿El terminal de tierra trasero está conectado al chasis del automóvil utilizando los cordones más corto y más grueso?
- **La unidad se calienta.**
  - \* ¿Está el cable de salida del altavoz conectado a masa?
  - \* ¿Están los terminales "-" de los altavoces L y R conectados a una masa común?
- **Esta unidad no funciona en absoluto.**
  - \* ¿Ha reinicializado su unidad?

**EN CAS DE DIFFICULTES**

- **Le fusible saute.**
  - \* Les fils rouge et noir sont-ils raccordés correctement?
- **L'appareil ne peut pas être mise sous tension.**
  - \* Le fil jaune est-elle raccordée?
- **Pas de son des enceintes.**
  - \* Le fil de sortie d'enceinte est-il court-circuité?
- **Le son est déformé.**
  - \* Le fil de sortie d'enceinte est-il à la masse?
  - \* Les bornes "-" des enceintes gauche et droit sont-elles mises ensemble à la masse?
- **Interférence avec les sons.**
  - \* La prise arrière de mise à la terre est-elle connectée au châssis de la voiture avec un cordon court et épais?
- **L'appareil devient chaud.**
  - \* Le fil de sortie d'enceinte est-il à la masse?
  - \* Les bornes "-" des enceintes gauche et droit sont-elles mises ensemble à la masse?
- **Cet appareil ne fonctionne pas du tout.**
  - \* Avez-vous réinitialisé votre appareil?



## B Connecting the external amplifiers / Conexión a los amplificadores externos / Connexion d'amplificateurs extérieurs

You can connect amplifiers to upgrade your car stereo system.

- Connect the remote lead (blue with white stripe) to the remote lead of the other equipment so that it can be controlled through this unit.
- **For amplifier only:**
  - After you have connected the center speaker, make sure to activate the center speaker; otherwise, no sound comes out of the connected center speaker, see page 55 of the INSTRUCTIONS.
  - Disconnect the speakers from this unit, connect them to the amplifier. Leave the speaker leads of this unit unused.
  - You can switch off the built-in amplifier and send the audio signals only to the external amplifier(s) to get clear sounds and to prevent internal heat buildup. See page 58 of the INSTRUCTIONS.

Usted podrá conectar amplificadores para mejorar el sistema estéreo de su automóvil.

- Conecte el conductor remoto (azul con rayas blancas) al conductor remoto del otro equipo para poderlo controlar a través de esta unidad.
- **Sólo para el amplificador:**
  - Asegúrese de activar el altavoz central después de conectarlo; de lo contrario, no saldrá sonido a través del mismo, consulte la página 55 del MANUAL DE INSTRUCCIONES.
  - Desconecte los altavoces de esta unidad y conéctelos al amplificador. Los cables de los altavoces de esta unidad quedan sin usar.
  - Podrá desconectar el amplificador incorporado y enviar las señales de audio solamente al(los) amplificador(es) externo(s) para obtener sonidos nítidos y evitar que se caliente el interior de la unidad. Véase la página 58 de las MANUAL DE INSTRUCCIONES.

Vous pouvez connecter des amplificateurs pour améliorer votre système autoradio.

- Connectez le fil de commande à distance (bleu avec bande blanche) au fil de commande à distance de l'autre appareil de façon qu'il puisse être commandé via cet appareil.
- **Pour l'amplificateur seulement:**
  - Après avoir connecté l'enceinte centrale, assurez-vous de mettre en service l'enceinte centrale; sinon, aucun son ne sort de l'enceinte centrale connectée, référez-vous à la page 55 du MANUEL D'INSTRUCTIONS.
  - Déconnectez les enceintes de cet appareil et connectez-les à l'amplificateur. Laissez les fils d'enceintes de cet appareil inutilisés.
  - Vous pouvez désactiver l'amplificateur intégré et envoyer les signaux audio uniquement à un ou plusieurs amplificateurs extérieurs afin d'obtenir un son clair et pour éviter un échauffement interne de l'appareil. Référez-vous à la page 58 du MANUEL D'INSTRUCTIONS.

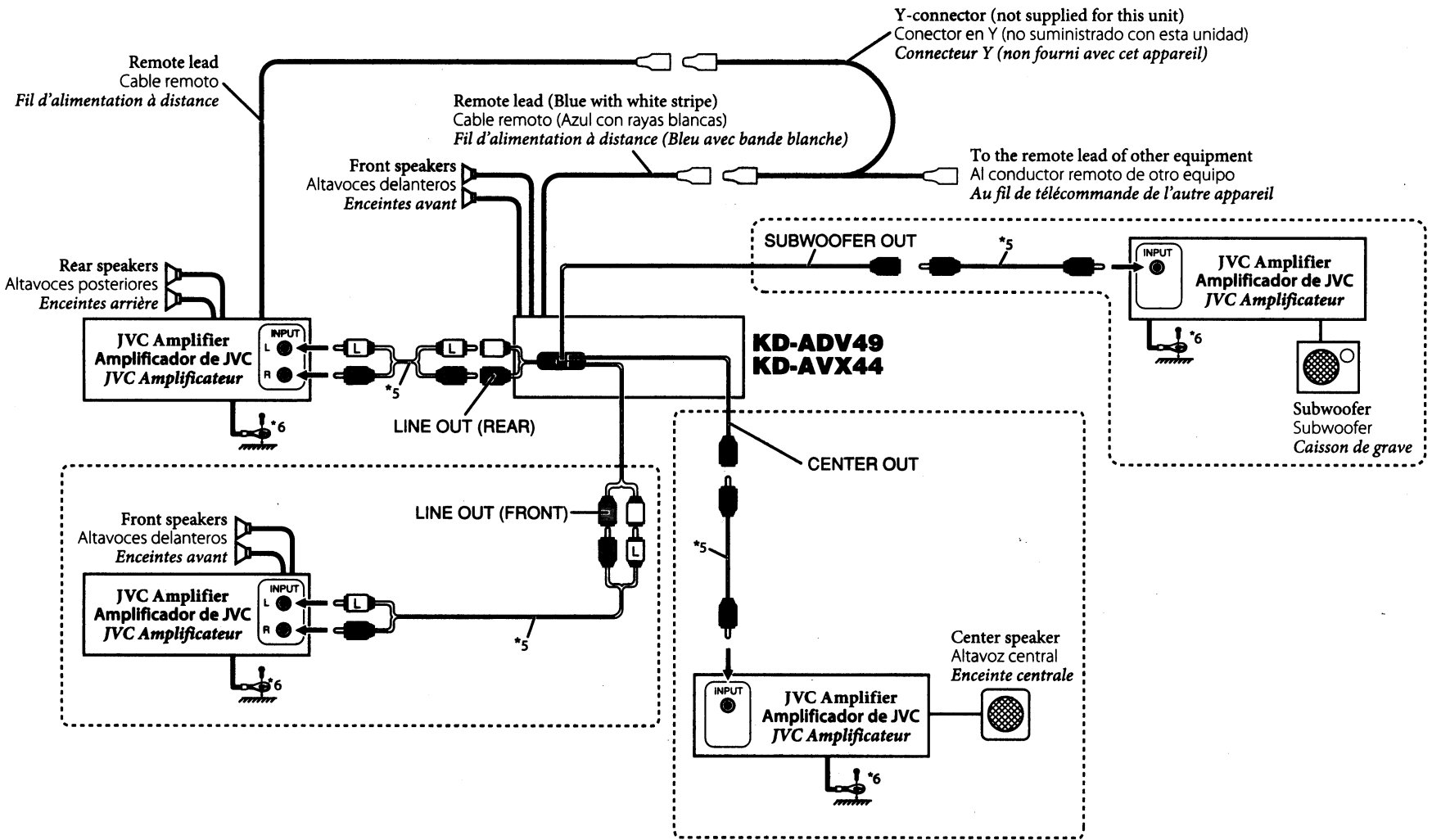

- \*5 Audio cord (not supplied)
- \*5 Cable de audio (no suministrado)
- \*5 Cordon audio (non fourni)

- \*6 Firmly attach the ground wire to the metallic body or to the chassis of the car—to the place uncoated with paint (if coated with paint, remove the paint before attaching the wire). Failure to do so may cause damage to the unit.
- \*6 Fije firmemente el cable de tierra a la carrocería metálica o al chasis—a un lugar no cubierto con pintura (si está cubierto con pintura, quítela antes de fijar el cable). De lo contrario, se podrían producir daños en la unidad.
- \*6 Attachez solidement le fil de mise à la masse au châssis métallique de la voiture—à un endroit qui n'est pas recouvert de peinture (s'il est recouvert de peinture, enlevez d'abord la peinture avant d'attacher le fil). L'appareil peut être endommagé si cela n'est pas fait correctement.

## C Connections for external component playback / Conexiones para la reproducción del componente externo / Connexions pour un appareil de lecture extérieur

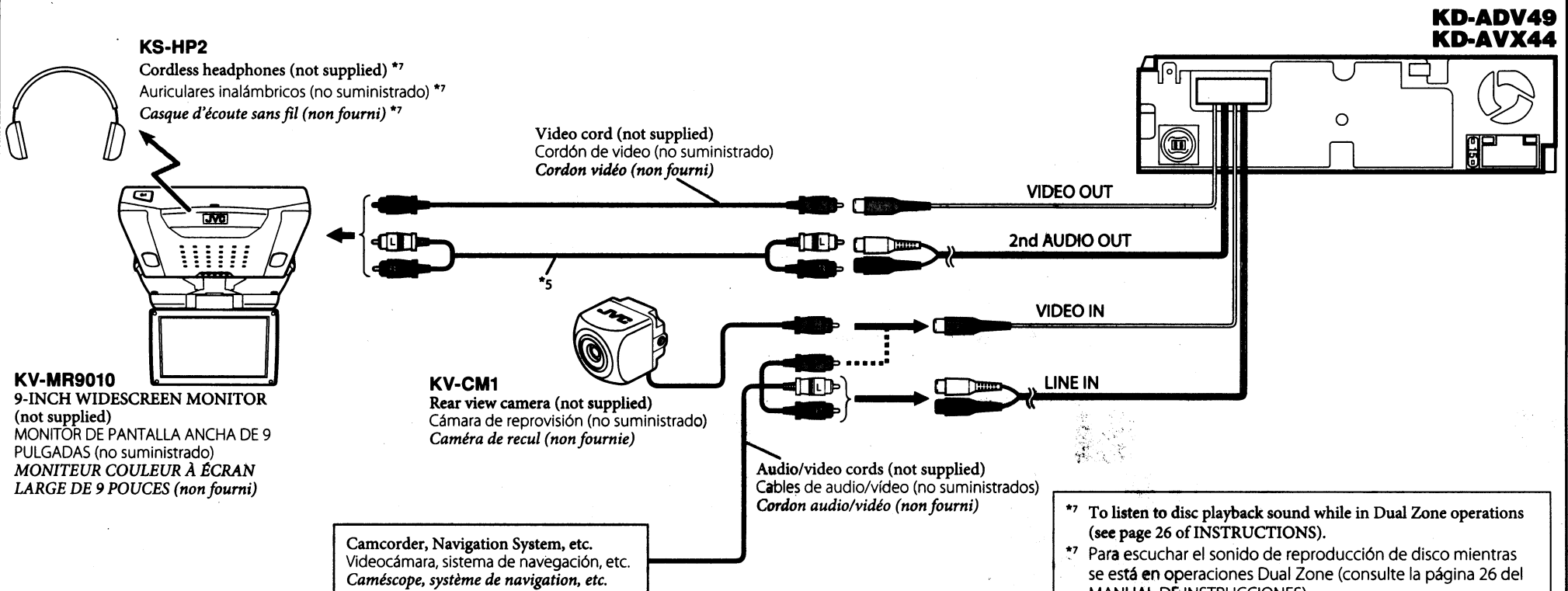

- \*7 To listen to disc playback sound while in Dual Zone operations (see page 26 of INSTRUCTIONS).
- \*7 Para escuchar el sonido de reproducción de disco mientras se está en operaciones Dual Zone (consulte la página 26 del MANUAL DE INSTRUCCIONES).
- \*7 Pour écouter le son de lecture des disque lors de l'utilisation du mode Dual Zone (voir page 26 du MANUEL D'INSTRUCTIONS).

## D Connecting the external components / Conexión de los componentes externos / Connexion des appareils extérieurs

When connecting the external components, refer also to the manuals supplied for the components and adapter.

Cuando conecte componentes externos, consulte, también, los manuales suministrados con los componentes y el adaptador.

Lors de la connexion des appareils extérieurs, référez-vous aussi aux manuels fournis avec les appareils et les adaptateurs.

You can connect the following JVC components to the CD changer jack.

Puede conectar los siguientes componentes JVC al jack del cambiador de CD.

Vous pouvez connecter les appareils JVC suivants à la prise de changeur de CD.

CD changer (CD-CH)	CH-X1500, etc.
HD Radio™ tuner box	KT-HD300

Cambiador de CD (CD-CH)	CH-X1500, etc.
Sintonizador HD Radio™	KT-HD300

Changeur de CD (CD-CH)	CH-X1500, etc.
Tuner HD Radio™	KT-HD300

You can also connect the following components through the various JVC adapters.

También puede conectar los siguientes componentes mediante los diversos adaptadores JVC.

Vous pouvez aussi connecter les appareils suivants en utilisant divers adaptateurs JVC.

- Connection cords may need to be purchased separately.

- Puede ser necesario comprar los cables de conexión por separado.

- Vous pouvez avoir besoin d'acheter certains cordons de connexion séparément.

iPod	Interface adapter for iPod	KS-PD100
XMDirect™ Universal Tuner Box	Smart Digital Adapter	XMDJVC100
SIRIUS satellite radio	SIRIUS satellite radio interface	KS-SRA100
JVC SIRIUS PnP	SIRIUS radio adapter	KS-U100K
Portable audio player with line output jacks	Line input adapter	KS-U57
Portable audio player with 3.5 mm (3/16") stereo mini jack	AUX input adapter	KS-U58

iPod	Adaptador de interfaz para iPod	KS-PD100
Sintonizador universal XMDirect™	Adaptador digital inteligente	XMDJVC100
Radio por satélite SIRIUS	Interfaz para radio por satélite SIRIUS	KS-SRA100
SIRIUS PnP de JVC	Adaptador para radio SIRIUS	KS-U100K
Reproductor de audio portátil con jacks de salida de línea	Adaptador de entrada por línea	KS-U57
Reproductor de audio portátil con jack mini estéreo de 3,5 mm (3/16 pulgada)	Adaptador de entrada AUX	KS-U58

iPod	Adaptateur d'interface pour iPod	KS-PD100
Tuner universel XMDirect™	Adaptateur numérique intelligent	XMDJVC100
Radio satellite SIRIUS	Interface pour radio satellite SIRIUS	KS-SRA100
JVC SIRIUS PnP	Adaptateur radio SIRIUS	KS-U100K
Lecteur audio portable avec prises de sortie de ligne	Adaptateur d'entrée de ligne	KS-U57
Lecteur audio portable avec mini fiche stéréo de 3,5 mm (3/16 pouces)	Adaptateur d'entrée auxiliaire	KS-U58

When connecting more than one component (maximum: three), it is recommended that you connect the components in series as explained below.

Cuando conecte más de un componente (máximo: tres), se recomienda que conecte los componentes en serie, como se explica a continuación.

Lors de la connexion de plus d'un appareil (maximum: trois), il est recommandé que vous connectiez les appareils en série comme nous l'expliquons ci-dessous.

- XM Radio and SIRIUS satellite radio cannot be used together.

- No puede utilizar juntas la radio XM y la radio satelital SIRIUS.

- La radio XM et SIRIUS ne peuvent pas être utilisées en même temps.

### When connecting two components in series

#### Cuando conecta dos componentes en serie

#### Lors de la connexion de deux appareils en série

**KD-ADV49**  
**KD-AVX44**

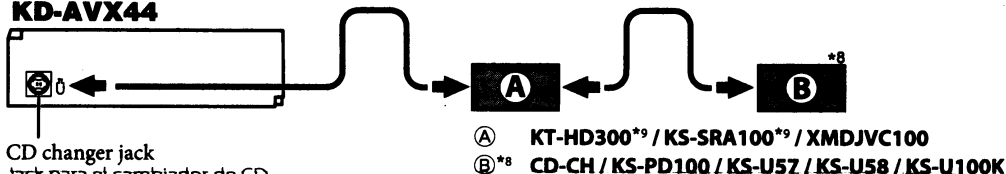

<sup>\*8</sup> To use these components, set the external input setting correctly (see page 56 of the INSTRUCTIONS).

<sup>\*9</sup> Power cannot be supplied to the component through the CD changer jack. You need to connect the power cord supplied for the component separately.

<sup>\*8</sup> Para utilizar estos componentes, configure el ajuste de entrada externa correctamente (consulte la página 56 del MANUAL DE INSTRUCCIONES).

<sup>\*9</sup> No puede suministrar energía eléctrica al componente a través del jack del cambiador de CD. Es necesario conectar, aparte, el cable de alimentación suministrado con el componente.

### When connecting three components in series

#### Cuando conecta tres componentes en serie

#### Lors de la connexion de trois appareils en série

**KD-ADV49**  
**KD-AVX44**

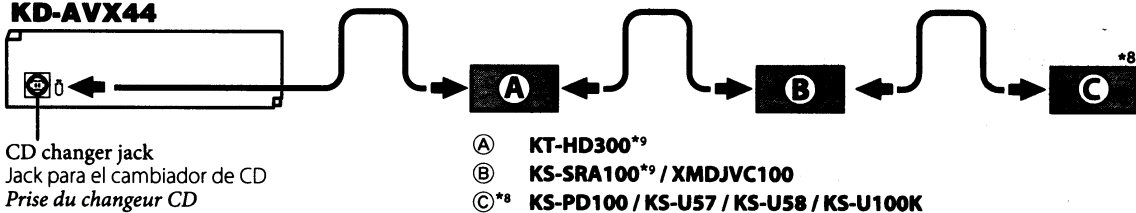

<sup>\*8</sup> Pour utiliser ces appareils, réglez l'entrée extérieure correctement (voir page 56 du MANUEL D'INSTRUCTIONS).

<sup>\*9</sup> L'alimentation ne peut pas être fournie à l'appareil par la prise de changeur de CD. Vous devez connecter séparément le cordon d'alimentation fourni pour l'appareil.

### To disconnect the connector / Para desconectar el cable / Pour déconnecter le connecteur

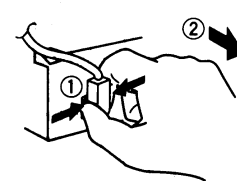

Hold the connector top tightly (①), then pull it out (②).  
Sujete firmemente la parte superior del conector (①) y seguidamente, extráigalo (②).  
Tenez fermement le connecteur par-dessus (①) et tirez vers l'extérieur (②).

## USB devices / Dispositivos USB / Périphériques USB

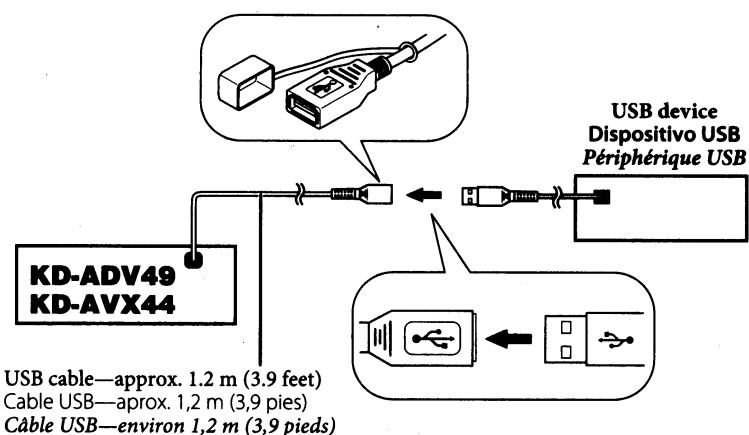

You cannot connect a computer to the USB (Ⓕ) terminal of the unit.  
No se puede conectar un ordenador al terminal (Ⓕ) USB de la unidad.  
Vous ne pouvez pas connecter un ordinateur à la prise USB (Ⓕ) de l'appareil.

## Connecting the iPod to the USB terminal / Conectar el iPod al terminal USB / Connexion du iPod à la prise USB

You can connect the iPod to the USB terminal using the following cables:

- To listen to the music: USB 2.0 cable (supplied for the iPod)

- To watch the video: USB Audio and Video cable for iPod—KS-U20K (not supplied)<sup>\*10</sup>

Puede conectar el iPod al terminal USB utilizando los siguientes cables:

- Para escuchar la música: Cable USB 2.0 (suministrado con el iPod)

- Para ver vídeo: Cable USB audio y vídeo para iPod—KS-U20K (no suministrado)<sup>\*10</sup>

Vous pouvez connecter le iPod à la prise USB en utilisant les câbles suivants:

- Pour écouter la musique: Câble USB 2.0 (fourni pour le iPod)

- Pour regarder une séquence vidéo: Câble USB Audio et Vidéo pour iPod—KS-U20K (non fourni)<sup>\*10</sup>

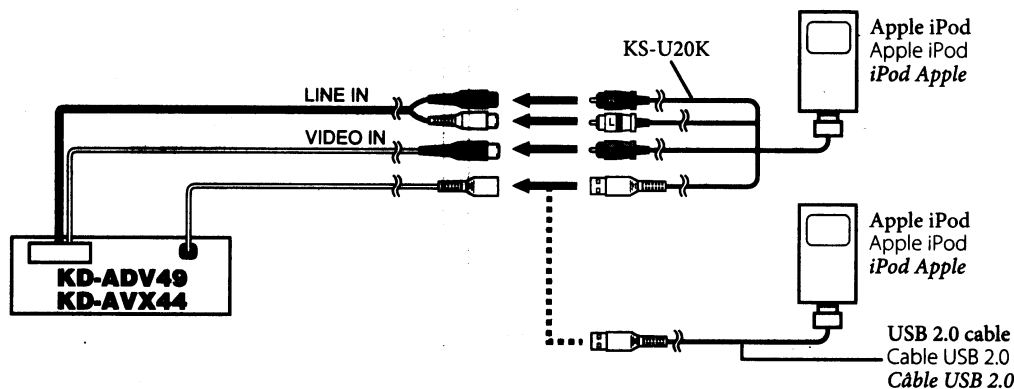

<sup>\*10</sup> When using the cable, make sure <iPod (Off)> is selected for <AV Input> (see page 56 of the INSTRUCTIONS).

<sup>\*10</sup> Cuando utilice el cable, asegúrese de haber seleccionado <iPod (Off)> para <AV Input> (consulte la página 56 del MANUAL DE INSTRUCCIONES).

<sup>\*10</sup> Lors de l'utilisation de ce câble, assurez-vous que <iPod (Off)> est choisi pour <AV Input> (voir page 56 du MANUEL D'INSTRUCTIONS).

• HD Radio™ is a proprietary trademark of iBiquity Digital Corp.  
• iPod is a trademark of Apple Inc., registered in the U.S. and other countries.

• HD Radio™ es una marca comercial de iBiquity Digital Corp.  
• iPod es una marca comercial de Apple Inc., registrada en los EE. UU. y otros países.

• HD Radio™ est une marque de commerce d'iBiquity Digital Corp.  
• iPod est une marque de commerce d'Apple Inc., enregistrée aux États-Unis et dans les autres pays.

REMOVE THIS LABEL FROM CABLE BEFORE USE.  
RETIRE LA ÉTIQUETA DEL CABLE ELÉCTRICO ANTES DE USAR.  
RETIREZ CETTE ÉTIQUETTE DU CÂBLE AVANT UTILISATION.



## CAUTION

CONNECT BLACK WIRE (① GND) TO GROUND FIRST. OTHERWISE, DAMAGE TO YOUR UNIT MAY OCCUR.

INCORRECT CONNECTION CAUSES SERIOUS DAMAGE TO THIS UNIT  
PLEASE READ INSTALLATION/CONNECTION MANUAL CAREFULLY.

①

CONNECT GROUND FIRST



METALLIC BODY OR CHASSIS  
OF THE CAR

②

CONNECT OTHER WIRES

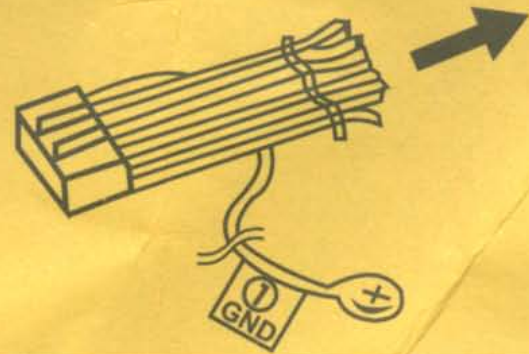

③

CONNECT ANTENNA TERMINAL

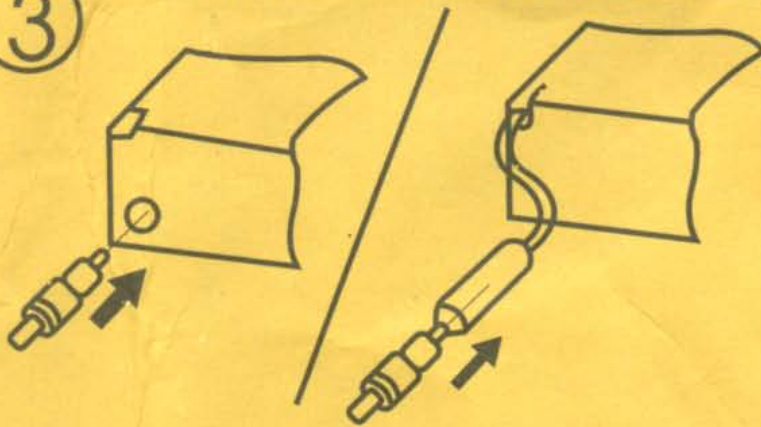

④

CONNECT POWER CORD TO  
THE UNIT

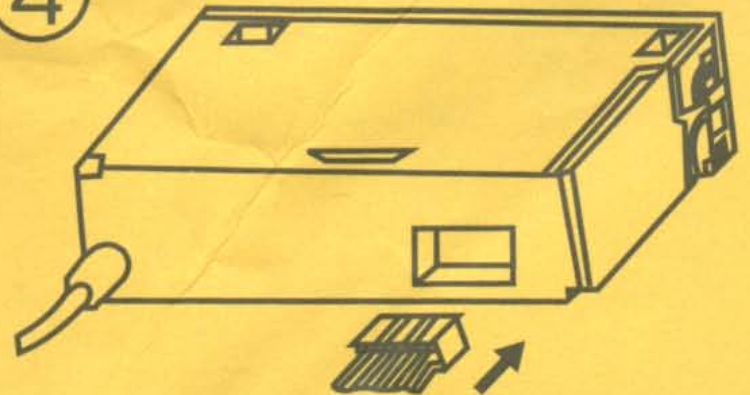



When it is not required to detach the front control panel from the main unit, use the provided screws to attach the control panel to the main unit.

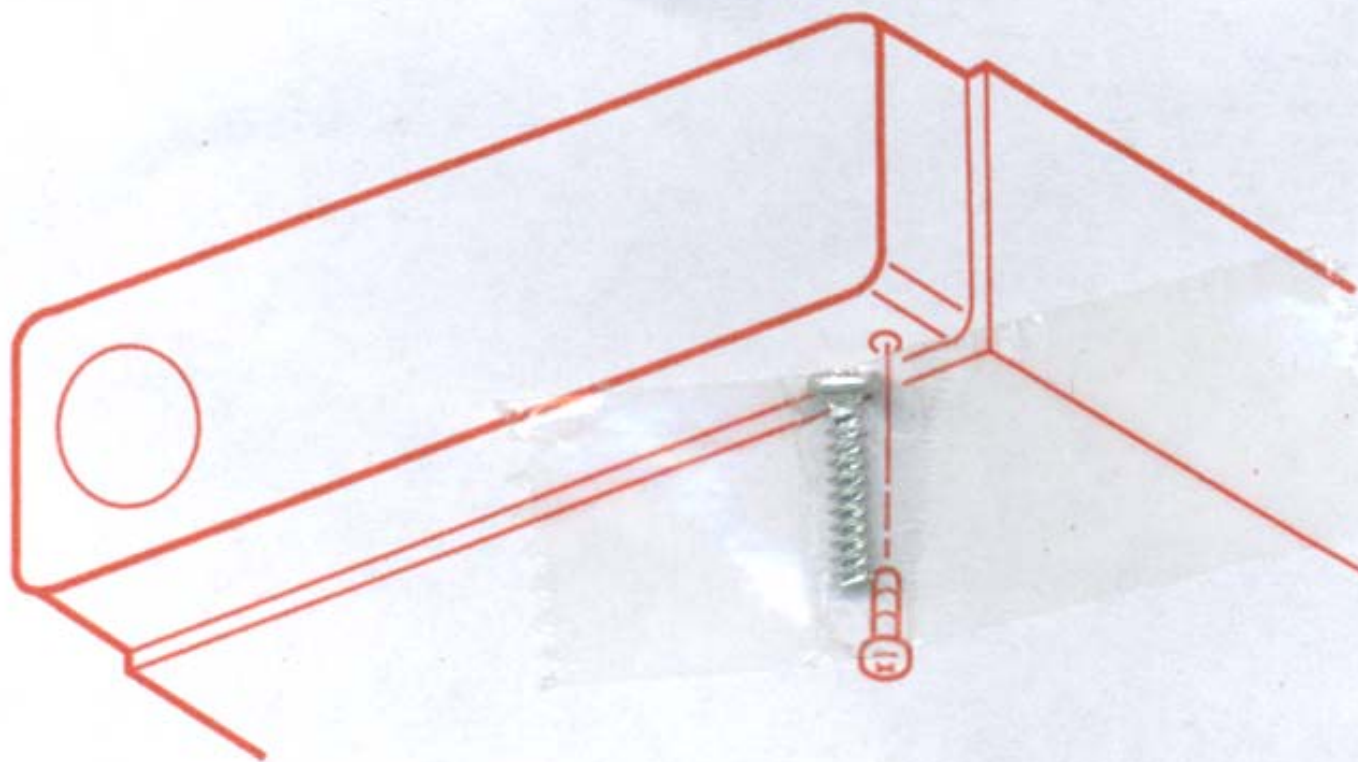

LV42208-001A



LVT1865-001A

**Cautions on displaying iPod Artwork / Vorsichtsmaßnahmen zur Anzeige von iPod Cover /  
Précautions sur l'affichage de l'illustration / Voorzorgen voor het tonen van iPod Illustratie  
/ Precauciones sobre la visualización de iPod Ilustración / Avvertenze sulla visualizzazione  
di illustrazioni / Försiktighetsåtgärder vid visning av iPod Bildmaterial / Предупреждения  
относительно отображения обложки / Cuidados com a visualização de Grafismos do iPod**

**ENGLISH**

Do not press any keys during the first 30 seconds or more of playing back any track containing Artwork\*. It takes 30 seconds or more to display Artwork and no operations are available while loading it.

\* *The picture displayed on the iPod's screen while playing back a track.*

**To activate the Artwork display**

Set "iPod Artwork" to "On" in the Menu.

**To display Artwork**

Press DISP repeatedly to display the Artwork of the track being played back.

**DEUTSCH**

Drücken Sie während mindestens der ersten 30 Sekunden der Wiedergabe eines Cover\* enthaltenden Tracks keine Tasten. Es dauert 30 Sekunden oder mehr, bis Cover angezeigt wird, und während des Ladevorgangs stehen keine Bedienungen zur Verfügung.

\* *Das auf dem Bildschirm des iPod während der Wiedergabe angezeigte Bild.*

**Zur Aktivierung der Anzeige von Cover**

Stellen Sie "iPod Cover" im Menü auf "On".

**Zur Anzeige von Cover**

Drücken Sie DISP wiederholt zur Anzeige von Cover für den abgespielten Track.

**FRANÇAIS**

N'appuyez sur aucune touche pendant les 30 premières secondes ou plus de la lecture d'une plage contenant une illustration\*. Il faut 30 secondes ou plus pour afficher l'illustration et aucune opération ne peut être effectuée pendant son chargement.

\* *L'image affichée sur l'écran du iPod pendant la lecture d'une plage.*

**Pour mettre en service l'affichage de l'illustration**

Réglez "Illustration" sur "On" dans le menu.

**Pour afficher l'illustration**

Appuyez répétitivement sur DISP pour afficher l'illustration correspondant à la plage en cours de lecture.

**NEDERLANDS**

Druk tijdens tenminste de eerste 30 seconden van weergave van een fragment met Illustratie\* niet op een van de toetsen. Het duurt 30 seconden of langer om Illustratie te tonen en u kunt tijdens het laden van Illustratie geen bediening uitvoeren.

\* *Het beeld dat op het scherm van de iPod wordt getoond tijdens weergave van een fragment.*

**Activeren van het Illustratie display**

Stel "iPod Illustratie" op "On" in het menu.

**Tonen van Illustratie**

Druk herhaaldelijk op DISP om de Illustratie van het spelende fragment te tonen.

**ESPAÑOL**

No pulse ninguna tecla durante los primeros 30 segundos o más de cualquier pista que contenga una Ilustración\*. Se tardan 30 segundos o más en visualizar la Ilustración y mientras se carga, no se podrá realizar ninguna operación.

\* *Imagen visualizada en la pantalla del iPod mientras se reproduce una pista.*

**Para activar la visualización de Ilustración**

Ajuste "iPod Ilustración" a "On" en el menú.

**Para visualizar la Ilustración**

Pulse DISP repetidamente para visualizar la Ilustración de la pista que se está reproduciendo.

**ITALIANO**

Non premere alcun tasto durante i primi 30 o più secondi di riproduzione di una traccia a cui è associata un'illustrazione\*. Per la visualizzazione di illustrazioni sono necessari almeno 30 secondi: durante questo periodo l'illustrazione viene caricata e non è possibile eseguire alcuna operazione.

\* *Immagine visualizzata sullo schermo dell'iPod durante la riproduzione di una traccia.*

**Per attivare la visualizzazione di illustrazione**

Impostare "Illustrazione" su "On" nel menu.

**Per visualizzare un'illustrazione**

Per visualizzare l'illustrazione della traccia in riproduzione premere più volte DISP.

**SVENSKA**

Tryck inte på några tangenter under de första 30 sekunderna eller mer vid uppspelning av ett spår som innehåller bildmaterial\*. Det tar 30 sekunder eller mer att visa bildmaterial och det går inte att använda några funktioner medan du hämtar det.

\* *Bilden visas på iPod-spelarens skärm medan ett spår spelas upp.*

**Aktivera visning av bildmaterial**

Ställ in "Bildmaterial" på "On" i menyn.

**Visa bildmaterial**

Tryck på DISP flera gånger för att visa bildmaterialet till spåret som spelas upp.

**РУССКИЙ**

Не нажимайте какие-либо клавиши в течение первых как минимум 30 секунд воспроизведения дорожки, содержащей обложку\*. Для отображения обложки требуется не менее 30 секунд, и во время загрузки все операции недоступны.

\* *Картинка, отображаемая на экране iPod во время воспроизведения дорожки.*

**Включение отображения обложки**

Установите для настройки "Обложка" значение "On" в меню.

**Отображение обложки**

Для отображения обложки воспроизводимой дорожки повторно нажимайте кнопку DISP.

**PORTUGUÊS**

Não prima nenhuma tecla durante os primeiros 30 segundos ou mais de reprodução de uma faixa com Grafismos\*. Demora 30 segundos ou mais a aparecerem os Grafismos e, durante esse tempo, não estarão disponíveis operações.

\* *A imagem que aparece no ecrã do iPod durante a reprodução de uma faixa.*

**Para activar a visualização dos Grafismos**

Defina "iPod Grafismos" como "On", no Menu.

**Para ver os Grafismos**

Prima DISP repetidamente para ver os Grafismos da faixa que estiver a ser reproduzida.

**احتیاطات در ورد کار با آرت و رک / iPod Çizimlerini gösterme hakkında uyarılar / iPod**  
**Застереження щодо відтворення зображень, закріплених за музичними альбомами iPod (Artwork) /**  
**顯示 iPod 插圖的注意事項 / iPod عرض صورة حول تنبيهات /**  
**iPod 아트웍 표시 관련 주의 사항 / ข้อควรระวังเกี่ยวกับการแสดง iPod Artwork /**  
**Waspada saat menampilkan iPod Artwork**

**TÜRKÇE**

İlk 30 saniye boyunca veya Artwork (Çizim)\* içeren herhangi bir parça çalınırken hiçbir tuşa basmayın. Çizimin gösterilmesi 30 saniye veya biraz daha fazla sürebilir ve bunu yüklerken herhangi bir işlem yapılamaz.

\* Bir parça çalınırken iPod ekranında görüntülenen resim.

**Çizim gösterimini etkinleştirmek için:**

Menü'de "iPod Artwork" öğesini "On" (Açık) olarak ayarlayın.

**Çizimi Göstermek için:**

Çalınan parçanın çizimini göstermek için DISP düğmesine arka arkaya basın.

**فارسی**

هیچ کلیدی را در ۳۰ ثانیه اول یا هنگام پخش تراکی که حاوی آرت و رک است فشار ندهید\*. حدود ۳۰ ثانیه یا بیشتر طول می کشد تا آرت و رک نمایش داده شود و هیچ عملیاتی هنگام بارگذاری آن نمی توان انجام داد.

\* تصویر نمایش داده شده در صفحه iPod هنگام پخش یک تراک

**برای فعال کردن نمایش آرت و رک**

در منو "iPod Artwork" را روی "On" قرار دهید.

**برای نمایش آرت و رک**

DISP را مکرراً فشار دهید تا آرت و رک تراکی که در حال نمایش است پخش شود.

**УКРАЇНА**

Протягом перших 30 або більше секунд відтворення доріжок, що містять зображення, закріплені за музичними альбомами (Artwork\*), не натискайте будь-яких кнопок. Для відтворення зображень Artwork потрібно 30 секунд або більше, і під час завантаження жодні операції недоступні.

\* Зображення, що відтворюється на екрані iPod під час програвання доріжки.

**Активация відтворення зображень Artwork**

В меню встановіть режим "On" для "iPod Artwork".

**Відтворення зображень Artwork**

Щоб відтворити зображення Artwork для поточної доріжки, декілька разів натисніть DISP.

**中文**

在播放含有插圖\*的任何曲目前 30 秒或更長的時間內，切勿按任何按鍵。將需要 30 秒或更長的時間顯示插圖，裝載時無法進行任何操作。

\* 當播放曲目時，圖像在 iPod 屏幕上出現。

**如何啟動插圖顯示窗**

在菜單中將 "iPod Artwork" 設定為 "On"。

**如何顯示插圖**

反復按 DISP 鍵，顯示所播放曲目的插圖。

**عربي**

لا تضغط أي مفاتيح أثناء أول ٣٠ ثانية أو أكثر من تشغيل أي مسار يحتوي على صورة\*. يستغرق عرض الصورة ٣٠ ثانية أو أكثر ولا تتوافر أي عمليات أثناء تحميلها.

\* الصورة المعروضة على شاشة iPod أثناء تشغيل مسار.

**لتنشيط عرض الصورة**

اضبط "iPod Artwork" على "On" من القائمة.

**لعرض الصورة**

اضغط DISP بشكل متكرر لعرض صورة المسار الذي يتم تشغيله.

**한국어**

아트웍\*이 포함된 트랙을 재생할 경우 처음 30초 동안 아무 키도 누르지 마십시오. 아트웍이 표시되는 데 30초 이상이 소요되며 그 동안에는 아무런 조작도 할 수 없습니다.

\* 트랙을 재생하는 동안 iPod 화면에 영상이 표시됩니다.

**아트웍 디스플레이를 활성화하려면**

메뉴에서 "iPod Artwork" 을 "On" 으로 설정합니다.

**아트웍을 표시하려면**

DISP를 여러 번 눌러서 재생할 트랙의 아트웍을 표시합니다.

**ไทย**

ห้ามกดปุ่มใดๆ ในระหว่าง 30 วินาทีแรกขึ้นโป๊ของการเล่นแทร็กที่มี Artwork\* ระบบจะใช้เวลา 30 วินาทีขึ้นไปในการแสดง Artwork และในระหว่างที่โหลด Artwork อยู่ นั้น จะไม่สามารถใช้งานฟังก์ชันใดๆ ได้

\* รูปภาพที่ปรากฏบนหน้าจอของ iPod ระหว่างเล่นแทร็ก

**การเปิดใช้งานการแสดงผล Artwork**

ตั้ง "iPod Artwork" ไว้ที่ "On" ในเมนู

**การแสดงผล Artwork**

กด DISP ซ้ำๆ เพื่อแสดง Artwork ของแทร็กที่กำลังเล่น

**INDONESIA**

Jangan tekan tombol apapun selama 30 detik pertama atau lebih sewaktu memutar kembali trek apapun yang berisi Artwork\*. Diperlukan waktu 30 detik atau lebih untuk menampilkan Artwork dan tidak ada pengoperasian yang tersedia sewaktu memuatkan artwork tersebut.

\* Gambar ditampilkan pada layar iPod sewaktu memutar kembali trek.

**Untuk mengaktifkan tampilan Artwork**

Atur "iPod Artwork" ke "On" dalam Menu.

**Untuk menampilkan Artwork**

Tekan DISP berulang kali untuk menampilkan Artwork trek yang sedang diputar.

## Notes on the front panel control / Hinweise an der Frontplattensteuerung / Remarques sur la commande du panneau avant / Opmerkingen aangaande bediening met het voorpaneel / Notas sobre el control del panel frontal / Note sul pannello di comando anteriore / Meddelanden på frontpanelens kontrollpanel / Notas no controlo do painel frontal

To turn on the unit, press the  / I / ATT button or SRC (source) button.

Zum Einschalten der Einheit drücken Sie die Taste  / I / ATT oder die Taste SRC (Quelle).

Pour mettre l'appareil sous tension, appuyez sur la touche  / I / ATT ou sur la touche SRC (source).

Druk op de  / I / ATT toets of SRC (bron) toets om het toestel in te schakelen.

Para encender la unidad, pulse el botón  / I / ATT o SRC (fuente).

Per accendere l'unità, premere il pulsante  / I / ATT o il pulsante SRC (sorgente).

Sätt igång apparaten genom att trycka på knappen  / I / ATT eller SRC (källa).

Para ligar a unidade, prima no botão  / I / ATT ou SRC (Origem).

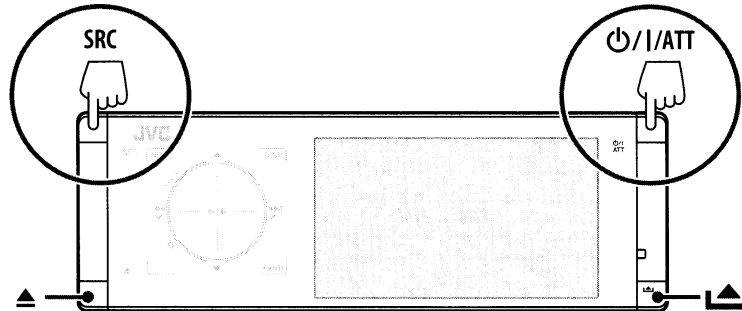

While the unit is turned on... / Bei eingeschalteter Einheit... / Pendant que l'appareil est sous tension... / Met het toestel ingeschakeld... / Mientras la unidad está encendida... / Quando l'unità è accesa... / Medan apparaten är påslagen... / Com a unidade ligada...

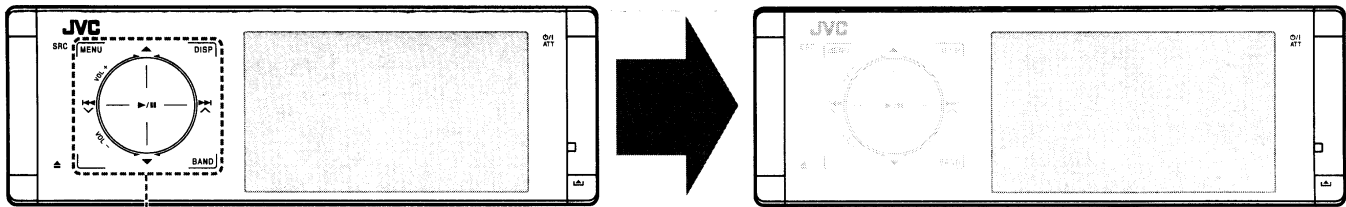

Touch pad controls / Touchpad-Bedienelemente / Panneau tactile / Aanraak-bedieningspaneel  
Controles de la almohadilla táctil / Comandi sensibili al tocco / Reglage på pekpanelen / Controlos do ecrã táctil

The lights of the touch pad controls are turned off if no operation is done for about 10 seconds. (The unit remains turned on.)

**To turn on the lights:** Move your hand close to the touch pad controls. For details, see the INSTRUCTIONS.

Die Lampen der Touchpad-Bedienelemente werden ausgeschaltet, wenn ca. 10 Sekunden lang keine Bedienung erfolgt. (Die Einheit bleibt eingeschaltet.)

**Zum Einschalten der Lampen:** Bewegen Sie Ihre Hand in die Nähe der Touchpad-Bedienelemente. Einzelheiten siehe BEDIENUNGSANLEITUNG.

L'éclairage du panneau tactile s'éteint quand aucune opération n'est effectuée pendant environ 10 secondes. (L'appareil reste sous tension.)

**Pour allumer l'éclairage:** Approchez votre main près du panneau tactile. Pour les détails, référez-vous au MANUEL D'INSTRUCTIONS.

De verlichting van het aanraak-bedieningspaneel wordt uitgeschakeld wanneer er gedurende ongeveer 10 seconden geen bediening wordt uitgevoerd. (Het toestel blijft gewoon ingeschakeld.)

**Weer inschakelen van de verlichting:** Breng uw hand in de buurt van het aanraak-bedieningspaneel. Zie de GEBRUIKSAANWIJZING voor details.

Las luces de los controles de la almohadilla táctil se apagan tras un período de inactividad de aproximadamente 10 segundos. (La unidad permanece encendida.)

**Para encender las luces:** Mueva su mano cerca de los controles de la almohadilla táctil. Para obtener más detalles, consulte el MANUAL DE INSTRUCCIONES.

Le luci dei comandi sensibili al tocco si spengono se il dispositivo non viene utilizzato per 10 secondi circa. (L'unità rimane accesa.)

**Per accendere le luci:** Avvicinare la mano ai comandi sensibili al tocco. Per ulteriori dettagli fare riferimento alle ISTRUZIONI.

Belysningen av reglagen på pekpanelen och skärmen släcks när ingen åtgärd görs på cirka 10 sekunder. (Apparaten förblir påslagen.)

**Slå på belysningen:** Flytta handen nära reglagen på pekpanelen. Se BRUKSANVISNINGEN för mer information.

As luzes dos controlos do ecrã táctil são desligadas se, durante 10 segundos, não for efectuada nenhuma operação. (A unidade permanece ligada.)

**Para ligar as luzes:** Mova a mão para perto dos controlos do ecrã táctil. Para informações mais detalhadas, consulte as INSTRUÇÕES.

Замечания по управлению с помощью передней панели / Примітки на передній панелі керування / Ön panel düğmesi ile ilgili notlar / نکاتی در مورد پانل کنترل جلو / ملاحظات حول التحكم من اللوحة الأمامية / 前面板控制的注意事項 / 전면 제어판의 노트/전면 제어판의 노트 / หมายเหตุสำหรับตัวควบคุมแผงด้านหน้า

Для включения устройства нажмите кнопку  / I/ATT или SRC (источник).

Для включения пристрою натисніть кнопку  / I/ATT чи SRC (джерело).

Üniteyi açmak için,  / I/ATT düğmesine veya SRC (kaynak) düğmesine basın.

برای روشن کردن دستگاه، دکمه  / I/ATT یا دکمه SRC (منبع) را فشار دهید.

لتشغيل الوحدة، اضغط زر  / I/ATT أو زر SRC (المصدر).

想要啓動本機，按  / I/ATT 鍵或 SRC (播放源鍵)。

제품을 켜려면  / I/ATT 버튼이나 SRC (소스) 버튼을 누릅니다.

ในการเปิดเครื่องเล่น ให้กดปุ่ม  / I/ATT หรือปุ่ม SRC (ซอร์ส)

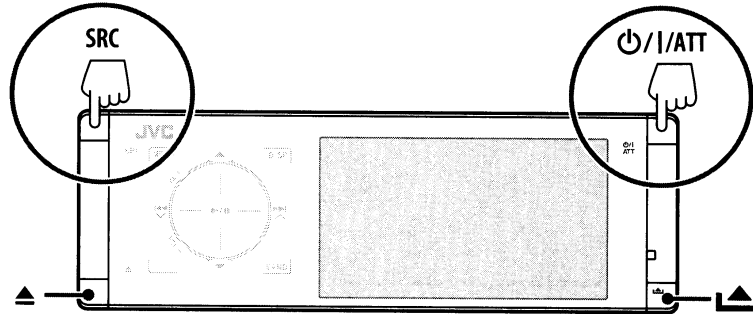

Когда устройство включено... / При увімкненому живленні... / Ünite açık olduğunda... / در حالیکه دستگاه روشن شده است... / عندما تكون الوحدة في وضع التشغيل... / 當本機已啓動時... / 제품이 켜진 동안... / ขณะที่เครื่องเล่นเปิดอยู่...

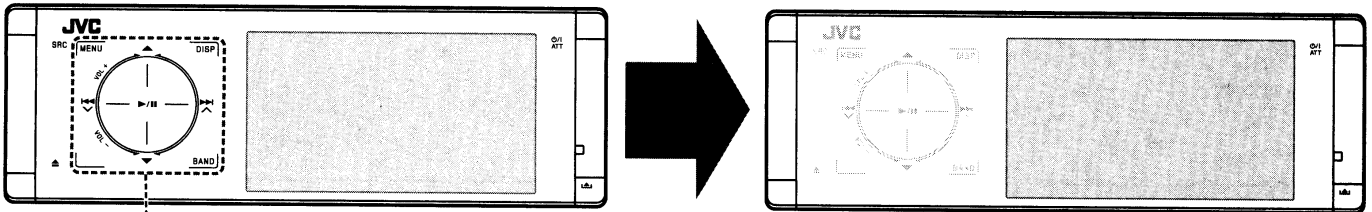

Элементы управления сенсорной панели / Керування через сенсорну панель / Dokunmatik yüzey düğmeleri / کنترلهای صفحه لمسی / أزرار التحكم في اللوحة التي تعمل باللمس / 觸摸控制面板 / 터치 패드 컨트롤 / ตัวควบคุมการทำงานด้วยระบบสัมผัส

Индикаторы элементов управления сенсорной панели выключаются, если в течение приблизительно 10 секунд не выполняется каких-либо операций. (Устройство остается включенным.)

**Для включения индикаторов:** Поднесите руку к элементам управления сенсорной панели. Дополнительные сведения см. в ИНСТРУКЦИЯХ.

Підсвічування органів керування на сенсорній панелі згасає, якщо протягом 10 секунд не здійснено жодної операції. (Живлення залишається увімкненим.)

**Для ввімкнення підсвічування:** Піднесіть руку впритул до органів керування на сенсорній панелі. Детальну інформацію наведено у ІНСТРУКЦІЇ.

Yaklaşık 10 saniye boyunca herhangi bir işlem yapılmazsa, dokunmatik yüzey düğmelerinin ışıkları söner. (Ünite açık kalır.)

**İşıkları açmak için:** Elinizi dokunmatik yüzey düğmelerine yaklaştırın. Ayrıntılar için, TALİMATLARA bakın.

چراغهای کنترلهای صفحه لمسی و مونیتر هنگامی که عملیاتی بمدت ۱۰ ثانیه انجام نشود خاموش خواهند شد. (و مونیتر هنگامی که عملیاتی بمدت)

برای روشن کردن چراغها: دستهای خود را به کنترلهای صفحه لمسی کنید. برای جزئیات بیشتر، به دستورالعملها مراجعه کنید.

تنظيف أزرار التحكم في اللوحة التي تعمل باللمس في حالة عدم إجراء أي عملية خلال ۱۰ ثوان تقريباً. (نظّل الوحدة في وضع التشغيل.)

لتشغيل الأضواء: حرك يدك بالقرب من أزرار التحكم في اللوحة التي تعمل باللمس. للحصول على التفاصيل، انظر التعليمات.

如果大約 10 秒鐘內沒有進行任何操作，觸摸控制面板的照明將關閉。(本機仍然處於啓動狀態。)

想要啓動照明：將手指移至觸摸控制面板。詳情，參閱使用說明書。

약 10초 동안 아무런 조작도 하지 않으면 터치 패드 컨트롤 표시등이 꺼집니다. (제품은 켜진 채로 유지됩니다.)

표시등을 켜려면: 손을 터치 패드 컨트롤 가까이로 가져옵니다. 자세한 내용은 지침을 참조하십시오.

แสงไฟของตัวควบคุมการทำงานด้วยระบบสัมผัสจะดับลง ถ้าไม่มีการใช้งานเครื่องเล่นเป็นเวลาประมาณ 10 วินาที (แต่เครื่องเล่นยังคงเปิดอยู่)

หากต้องการให้แสงไฟติดสว่าง ให้เลื่อนมือเข้าไปใกล้ตัวควบคุมการทำงานด้วยระบบสัมผัส ดูรายละเอียดเพิ่มเติมได้ในคำแนะนำในการใช้





**The countries where you may use the Bluetooth® function/**

*Die Länder, in denen Sie die Bluetooth® Funktion verwenden können/*

*Pays où vous pouvez utiliser la fonction Bluetooth®/*

**De landen waar u de Bluetooth®-functie mag gebruiken/**

*Países en los que se puede utilizar la función Bluetooth®/*

*Paesi nei quali è possibile utilizzare la funzione Bluetooth®/*

**Länder där du kan använda Bluetooth®-funktionen/**

*Lande, hvor du kan bruge Bluetooth®-funktioner/*

*Land hvor du kan bruke Bluetooth®-funksjonen/*

**Maat, joissa voi käyttää Bluetooth®-toimintoa/**

*Países onde pode usar a função Bluetooth®/*

*Οι χώρες όπου μπορείτε να χρησιμοποιήσετε τη λειτουργία Bluetooth®/*

**Страны, где можно воспользоваться функцией Bluetooth®/**

*Země, ve kterých můžete využívat funkci Bluetooth®/*

*Azok az országok, amelyekben használhatjuk a Bluetooth®-funkciót/*

**Kraje, w których można używać funkcji Bluetooth®/**

*Države, kjer lahko uporabljate funkcijo Bluetooth®/*

*Krajiny, v ktorých môžete využívať funkciu Bluetooth®/*

**Valtis, kur jūs varat izmantot Bluetooth® funkciju/**

*Šalys, kuriose galite naudotis „Bluetooth®“ funkcija/*

*Il-pajjiżi fejn tista' tuża l-funzjoni Bluetooth®/*

**Lönd þar sem hægt er að nota Bluetooth®/**

*Riigid, kus on võimalik kasutada Bluetooth® funktsiooni/*

*Bluetooth® fonksiyonunu kullanabileceğiniz ülkeler/*

**ประเทศที่ท่านสามารถใช้ Bluetooth® ฟังก์ชัน/**

*Na tíortha inar féidir leat feidhmiú Bluetooth® a úsáid/*

*Länner an denen der d'Bluetooth® Funktioun benotze kënnt./*

**Ở những quốc gia mà bạn có thể sử dụng chức năng Bluetooth®/**

**Els països on podrà fer servir la funció Bluetooth®/**

*Zemlje u kojima je dozvoljena upotreba Bluetooth® funkcije./*

*Zemlje u kojima možete koristiti Bluetooth® funkciju/*

**Zemlje u kojima je dopušteno koristiti Bluetooth®./**

**Земји каде можете да ја користите функцијата Bluetooth®/**

Andorra
Australia
Österreich
Bosna i Hercegovina
Belgien
Belgique
Canada
Schweiz
Suisse
Κύπρος
Kıbrıs
Česká republika
Deutschland
Danmark
Eesti
España
Suomi
Finland
France
United Kingdom
Ελλάδα
Hrvatska
Magyarország
Ireland
Éire
Ísland

Italia
Lichtenstein
Lietuva
Luxemburg
Luxembourg
Lëtzebuerg
Latvija
Monaco
Crna Gora
Македонија
Malta
Nederland
Norge
New Zealand
Polska
Portugal
Srbija
Россия
Sverige
Slovenija
Slovensko
ประเทศไทย
Türkiye
United States of America
Vietnam
Việt Nam

Thank you for purchasing

**JVC<sup>®</sup>**

Instructions  
Fold so opening is at the top.  
Tape in middle or on front.

Please do not send products or other  
correspondence to this address.

JVC AMERICAS CORP  
1700 Valley Road  
Wayne, NJ 07470

307C



PLACE  
FIRST-CLASS  
STAMP  
HERE

**JVC<sup>®</sup>**  
**PO BOX 9580**  
**PEORIA IL 61612-9580**



**PRODUCT REGISTRATION CARD/QUESTIONNAIRE**

**US CUSTOMERS ONLY**

Registering your product will allow us to contact you in the unlikely event a product safety notification is required.

This form is for Product Registration purposes only. Failure to return this form does not diminish your rights during the warranty period.

**THANK YOU FOR PURCHASING THIS JVC PRODUCT**

**REGISTER ONLINE AT: [WWW.JVC.COM](http://WWW.JVC.COM)**

First Name: \_\_\_\_\_

Last Name: \_\_\_\_\_

Address: \_\_\_\_\_

Apt #": \_\_\_\_\_

City: \_\_\_\_\_

State: \_\_\_\_\_

Zip: \_\_\_\_\_

Phone: \_\_\_\_\_

Email Address: \_\_\_\_\_

**Thank you! We appreciate your responses to this questionnaire.**  
**The information you choose to share with us will be used by JVC to offer you product information and other communications that may interest you.**  
**If you prefer not to be contacted about these special offers, please check here. { }**

Date of Purchase \_\_\_\_\_

Model Number \_\_\_\_\_

Serial Number \_\_\_\_\_

Purchase Price \_\_\_\_\_

Dealer \_\_\_\_\_

**1) Did you:**

- Purchase this product your self?
- Receive this product as a gift?

**5) Your Gender:**

- Male
- Female

**2) Is this Product:**

- The first product of this type you have ever owned?
- A replacement for a similar JVC product?
- A replacement for a similar product made by another company?
- An addition to a similar product you are still using?

**6) Your Marital Status**

- Married
- Single

**3) What factors most influenced your decision to purchase this product?**

- JVC brand reputation
- Previous experience with JVC products
- Price
- Specific product features
- Style/appearance
- Salesperson's recommendation
- Friend/relative's recommendation
- Warranty coverage
- Other

**7) What is your approximate annual household income level?**

- Under \$25,000
- \$25,000 – \$49,000
- \$50,000 – \$74,000
- \$75,000 – \$99,000
- \$100,000 and over

**Comments:**

\_\_\_\_\_

\_\_\_\_\_

\_\_\_\_\_

\_\_\_\_\_

\_\_\_\_\_

\_\_\_\_\_

**4) How did you learn about this product?**

- Magazine Advertisement
- Newspaper Advertisement
- TV/Radio Announcement
- Product Brochure
- Direct Mail
- Mail Order Catalog
- Friend/Relative Recommendations
- Salesperson/Store Recommendation
- Internet
- Dealer Event
- Other

**JVC Thanks you for completing this questionnaire.**  
**Your responses will help us reach you with offers that may interest you.**  
**If you prefer not to receive these offers please check here { }**

CANADA  
ONLY

# JVC

CANADA  
SEULEMENT

## OWNER'S COPY OF WARRANTY CARD COPIE D'ENREGISTREMENT DE LA GARANTIE DU PROPRIÉTAIRE

(Save sales docket together with this warranty card, as a proof of date of purchase.  
La facture et cette garantie sont vos preuves de la date d'achat; rangez-les.)

MODEL MODÈLE	SERIAL NO. NO DE SÉRIE		
Purchase from Acheté chez	Date purchased Date acheté		
Dealer's Address Adresse du Vendeur			
No. No	Street Rue		
City or Town Ville			
Prov. Prov.	Postal Code Code Postal		
Owner's Name Nom du Propriétaire			
Owner's Address Adresse du Propriétaire			
No. No	Street Rue	Apt. App.	
City or Town Ville			
Prov. Prov.	Postal Code Code Postal		

BT-52008-1  
(1007)

Detach here.

à découper ici

Printed in Indonesia

## WARRANTY CONTROL CARD CARTE DE CONTRÔLE DE LA GARANTIE

**IMPORTANT:** This warranty control card must be filled in and posted to the address indicated on the back hereof or register via internet within 7 (seven) days from the date of purchase.

**IMPORTANT:** Cette carte doit être renvoyée dûment remplie à l'adresse indiquée au verso, dans les 7 jours de la date d'achat ou aller sur le site par internet pour l'enregistrement.

(PLEASE PRINT/EN LETTRES MOULÉES)

MODEL MODÈLE	SERIAL NO. NO DE SÉRIE		
Purchased from Acheté chez	Date purchased Date acheté		
Dealer's Address Adresse du Vendeur			
No. No	Street Rue		
City or Town Ville			
Prov. Prov.	Postal Code Code Postal		
Owner's Name Nom du Propriétaire			
Owner's Address Adresse du Propriétaire			
No. No	Street Rue	Apt. App.	
City or Town Ville			
Prov. Prov.	Postal Code Code Postal		

You may also register on-line  
at: [www.jvc.ca](http://www.jvc.ca)

Vous pouvez également vous  
inscrire par internet à: [www.jvc.ca](http://www.jvc.ca)

WARRANTY APPLIES ONLY TO PRODUCT  
DISTRIBUTED IN CANADA BY JVC CANADA INC.

LA GARANTIE S'APPLIQUE SEULEMENT AUX PRODUITS  
DISTRIBUES AU CANADA PAR JVC CANADA INC.

Warranty applies only  
to PRODUCT distributed  
in Canada by JVC Canada  
Inc.

# JVC

La garantie s'applique  
seulement aux PRODUITS  
distribués au Canada par  
JVC Canada Inc.

# WARRANTY GARANTIE

JVC CANADA INC.

21 Finchdene Square, Toronto, ON M1X 1A7

TEL: (416) 293-1311 FAX: (416) 293-8208

<http://www.jvc.ca>

JVC CANADA INC. (hereafter called "JVC") gives the following express warranty for each new JVC product distributed in Canada by JVC and sold by an authorized JVC dealer.

JVC warrants that this JVC product is free, under normal use and maintenance, from any defects in material and workmanship subject to the following terms and conditions:

### 1. To Obtain Warranty Service:

- The JVC Warranty Control Card herein provided must be completed in full and posted or registered via internet within 7 days of date of purchase of the JVC product.
- This JVC Warranty Control Card must be completed in full and presented together with proof of purchase of the JVC product requiring service.
- The JVC product must be brought in for service to an authorized JVC Service Centre.

### 2. Limitation:

This Warranty shall not apply to:

- Repair or replacement of any cabinets, batteries, plates, connection cords, antennas, dust covers, knobs, speaker grills, speaker cones, projection screens, projection screen savers, and all accessories.
- Any defects caused or repairs required as a result of misuse, abusive operation, negligence, improper use and/or insufficient care.
- Any defect caused or repairs required as a result of not following the instructions in the operation manual.
- Any JVC product tampered with, adjusted or repaired by any party other than JVC or authorized JVC Service Centre personnel.

JVC CANADA INC. (ci-après appelé "JVC") énonce la garantie expresse suivante pour tout nouveau produit JVC distribué au Canada par JVC et vendu par un détaillant JVC autorisé.

JVC vous garantit que ce produit est déposé, sous utilisation et entretien normal, de tout défaut matériel et de fabrication sous réserve des modalités et conditions suivantes :

### 1. Pour obtenir un service de garantie :

- La carte de contrôle de garantie JVC ci-incluse doit être complétée avec les renseignements complets et être postée ou enregistrée via internet dans les 7 jours suivant l'achat du produit JVC.
- Cette carte de contrôle de garantie JVC doit être dûment remplie et être présentée avec la preuve d'achat du produit JVC nécessitant une réparation.
- Le produit JVC doit être apporté pour service chez un centre de service JVC autorisé.

### 2. Restrictions:

Cette garantie ne s'applique pas aux :

- Réparation ou remplacement de tout cabinet, batteries, panneau avant, cordons de raccord, antennes, housses de protection, boutons, couverts de haut-parleur, cônes de haut-parleur, écrans de projection, protecteurs d'écran de projection et tous les accessoires.
- Tous défauts occasionnés ou réparations requises suite à une utilisation abusive, mauvaise, négligente et/ou une utilisation incorrecte.
- Tous défauts occasionnés ou réparations requises suite à l'omission de suivre les recommandations du manuel d'instruction.
- Tout produit JVC altéré, ajusté ou réparé par tout autre entreprise que JVC ou un centre de service d'entretien ou de service autorisé JVC.

- (e) Any JVC products on which the serial number has been defaced, modified or removed.
- (f) Maintenance, cleaning or periodic check-up
- (g) Conversion to foreign or domestic voltage or frequency.
- (h) Any JVC product without the Canadian Electrical Safety Regulations ID.
- (i) Any JVC products used for commercial or institutional, rental, or display purposes.  
Parts.....1 year (except video head - 90 days)  
Labour... 90 days
- (j) Any JVC product which has been resold and no longer owned by the original purchaser.
- (k) Product purchased from "outside Canada", "bankruptcy" or "liquidator".

- (e) Tout produit JVC dont le numéro de série a été altéré, modifié ou enlevé.
- (f) L'entretien, les vérifications périodiques et nettoyage.
- (g) La conversion à une fréquence ou une tension étrangère ou domestique.
- (h) Tout produit JVC n'ayant pas le sigle d'identification conforme aux normes électriques Canadiennes (CSA).
- (i) Pour tout produit utilisé à des fins commerciales, institutionnelles, de location ou utilisé à des fins d'étalage.  
Pièces..... 1 An (Excepté les têtes vidéo- 90 jours)  
Main d'œuvre... 90 Jours
- (j) Tout produit JVC ayant été revendu et qui n'est plus la propriété de l'acheteur original.
- (k) Produit acheté à "l'extérieur du Canada", provenant d'une "faillite" ou d'un "liquidateur".

- (l) Any defects caused by fire, flood, lightning, power surge, or other events beyond the control of JVC.
- (m) FOR AUTO PRODUCTS  
Warranty does not cover elimination of car static or electrical interferences, cleaning of head, adjustments, or labour cost for the removal or reinstallation of the unit for repair.

- (l) Tout dommage causé par le feu, une inondation, un éclair, une surtension ou tout autre événement hors du contrôle de JVC.
- (m) POUR LES PRODUITS D'AUTOMOBILE  
La garantie ne couvre pas l'élimination d'interférences statiques ou électriques de la voiture, le nettoyage de tête, les ajustements et les coûts de main d'œuvre associés à l'enlèvement ou à la réinstallation de l'unité pour réparation.

**WARRANTY TERM (VALID FROM THE DATE OF PURCHASE)  
CONDITIONS DE GARANTIE (VALABLE À PARTIR DE LA DATE D'ACHAT)**

PRODUCT PRODUIT	PARTS (Years) PIECES (années)	Labour (Years) MAIN-D'OEUVRE (années)
Projection TV In-Home Service Colour TV In-Home (25" and above) D-ILA Rear Projection In-Home Service LCD TV In-Home Service (25" and above) Écrans de projection Service à Domicile Écrans de TV Couleur Service à Domicile (25" et plus) TV projection arrière D-ILA Service à Domicile Écrans de LCD Service à Domicile (25" et plus)	1	1
<p>* In-home service to be provided where available Where it is not available, the Purchaser must assume the responsibility and expense for the proper packing, shipment and all costs associated with the delivery of the equipment to and from the closest JVC Authorized Service Centre. * Service à domicile fourni par un détaillant disponible. S'il n'y a pas de service JVC disponible à proximité, l'acheteur doit assumer la responsabilité et les coûts pour un emballage adéquat, l'expédition, ainsi que tous les coûts associés à la livraison de l'équipement chez et depuis le détaillant JVC autorisé le plus près pour un service d'entretien.</p>		
Receivers and Home Speakers purchased separately, Front Projection and Car Audio "ARSENAL" Series Récepteurs et Hauts-Parleurs achetés séparément, Projecteur Avant et Audio d'Auto de Série « ARSENAL »	2	2
AC Adapters, Remote Controls, Headphones, Microphones and Projector Lamps Adaptateurs AC, Télécommande, Casque D'écoute, Microphones et Lampe de Projecteur	90 DAYS 90 JOURS	90 DAYS 90 JOURS
Wood Cone Speakers Enceinte à Cône en Bois	5	5
All Other Categories Toutes les autres catégories	1	1

**3. Standards:**

If any defects should be found in a JVC product within the applicable terms, necessary repairs shall be made at no cost to the purchaser for parts or labour when JVC acknowledges that such defects are due to faulty material or workmanship.

**4. Exclusion of All Other Express Warranties:**

This warranty constitutes the entire express warranty given by JVC for JVC products and no dealer or service centre personnel or his, its or their agent or employee is, or are authorized to extend or enlarge this warranty on behalf of JVC.

**5. Disclaimer of Consequential Damage:**

To the extent the law permits JVC disclaims any responsibility for loss of time or use of its product, transportation costs, or any other indirect, incidental or consequential damage or inconvenience.

**3. Critères:**

Si un produit JVC s'avérait défectueux, selon les conditions applicables, les réparations nécessaires seront effectués sans coûts additionnels à l'acheteur pour les pièces et la main d'œuvre lorsque JVC reconnaît que de telles déficiences sont causées par une défectuosité de matériel ou de fabrication.

**4. Exclusion de toutes autres garanties expresses :**

Cette garantie constitue l'entière garantie express donnée par JVC pour les produits JVC. Nul représentant ou employé d'un détaillant ou d'un service d'entretien n'est autorisé à prolonger cette garantie au nom de JVC.

**5. Dénégation des dommages indirects :**

Dans la mesure permise par la loi, JVC nie toute responsabilité pour perte de temps ou d'usage de ses produits, des coûts de transport ou tout autre dommage ou inconvénient indirect, accidentel et consécutif.

**New**

And mail to the address below.  
**You may also register on-line  
at: [www.jvc.ca](http://www.jvc.ca)**

Detach here.

**Nouveau**

Veillez poster à l'adresse ci-dessous.  
**Vous pouvez également vous  
enregistrer par internet à: [www.jvc.ca](http://www.jvc.ca)**

à découper ici

**Place stamp  
here  
Placez votre  
timbre ici**

**JVC CANADA INC.**

21 Finchdene Square  
Toronto, ON M1X 1A7

# **TO OUR VALUED CUSTOMER** \_\_\_\_\_

THANK YOU FOR PURCHASING THIS JVC PRODUCT.  
WE WANT TO HELP YOU ACHIEVE A PERFECT EXPERIENCE.

**NEED HELP ON HOW TO HOOK UP?  
NEED ASSISTANCE ON HOW TO OPERATE?  
NEED TO LOCATE A JVC SERVICE CENTER?  
LIKE TO PURCHASE ACCESSORIES?**

**JVC<sup>®</sup> IS HERE TO HELP!**  
**TOLL FREE: 1(800)252-5722**  
**<http://www.jvc.com>**

Remember to retain your Bill of Sale for Warranty Service.

\_\_\_\_\_ **Do not attempt to service the product yourself** \_\_\_\_\_

**Caution**

To prevent electrical shock, do not open the cabinet.  
There are no user serviceable parts inside.  
Please refer to qualified service personnel for repairs.

---



# LIMITED WARRANTY

1-1 USA ONLY

ONLY FOR PRODUCT PURCHASED IN U.S.A.

JVC Americas Corp. (JVC) warrants this product and all parts thereof, except as set forth below ONLY TO THE ORIGINAL RETAIL PURCHASER to be FREE FROM DEFECTIVE MATERIALS AND WORKMANSHIP from the date of original purchase for the period shown below. ("The Warranty Period")

PARTS	<b>1 YR</b>	LABOR	<b>1 YR</b>
-------	-------------	-------	-------------

**THIS LIMITED WARRANTY IS VALID ONLY IN THE FIFTY (50) UNITED STATES, THE DISTRICT OF COLUMBIA AND IN THE COMMONWEALTH OF PUERTO RICO.**

### WHAT WE WILL DO:

If this product is found to be defective within the warranty period, JVC will repair or replace defective parts with new or rebuilt equivalents at no charge to the original owner. Such repair and replacement services shall be rendered by JVC during normal business hours at JVC authorized service centers. Parts used for replacement are warranted only for the remainder of the Warranty Period. All products may be brought to a JVC authorized service center on a carry-in basis. Color televisions with a screen size of 27" or greater qualify for in-home service. In such cases, a technician will come to your home and either repair the TV there or remove and return it if it cannot be repaired in your home.

### WHAT YOU MUST DO FOR WARRANTY SERVICE:

**Please do not return your product to the retailer** instead, return your product to the JVC authorized service center nearest you. If shipping the product to the service center, please be sure to package it carefully, preferably in the original packaging, and include a brief description of the problem(s). Please call 1-800-252-5722 to locate the nearest JVC authorized service center. Service locations can also be obtained from our website <http://www.jvc.com>. If your product qualifies for in-home service, the service representative will require clear access to the product.

If you have any questions concerning your JVC Product, please contact our Customer Care Center at 800-252-5722

### WHAT IS NOT COVERED:

This limited warranty provided by JVC does not cover:

1. Products which have been subject to abuse, accident, alteration, modification, tampering, negligence, misuse, faulty installation, lack of reasonable care, or if repaired or serviced by anyone other than a service facility authorized by JVC to render such service, or if affixed to any attachment not provided with the products, or if the model or serial number has been altered, tampered with, defaced or removed;
2. Initial installation, installation and removal from cabinets or mounting systems.
3. Operational adjustments covered in the Owner's Manual, normal maintenance, video and audio head cleaning;
4. Damage that occurs in shipment, due to act of God, and cosmetic damage;
5. Signal reception problems and failures due to line power surge;
6. User Removal Memory Devices/Video Pick-up Tubes/CCD Image Sensors are covered for 90 days from the date of purchase;
7. Accessories;
8. Batteries (except that Rechargeable Batteries are covered for 90 days from the date of purchase);
9. Products used for commercial purposes, including, but not limited to rental.
10. Loss of data resultant from malfunction of hard drive or other data storage device;

There are no express warranties except as listed above.

THE DURATION OF ANY IMPLIED WARRANTIES, INCLUDING THE IMPLIED WARRANTY OF MERCHANTABILITY, IS LIMITED TO THE DURATION OF THE EXPRESS WARRANTY HEREIN.

JVC SHALL NOT BE LIABLE FOR ANY LOSS OF USE OF THE PRODUCT, INCONVIENCE, OR ANY OTHER DAMAGES, WHETHER DIRECT, INCIDENTAL OR CONSEQUENTIAL (INCLUDING, WITHOUT LIMITATION, DAMAGE TO TAPES, RECORDS OR DISCS) RESULTING FROM THE USE OF THIS PRODUCT, OR ARISING OUT OF ANY BREACH OF THIS WARRANTY. ALL EXPRESS AND IMPLIED WARRANTIES, INCLUDING THE WARRANTIES OF MERCHANTABILITY AND FITNESS FOR PARTICULAR PURPOSE, ARE LIMITED TO THE WARRANTY PERIOD SET FORTH ABOVE.

Some states do not allow the exclusion of incidental or consequential damages or limitations on how long an implied warranty lasts, so these limitations or exclusions may not apply to you. This warranty gives you specific legal rights and you may also have other rights which vary from state to state.

### JVC AMERICAS CORP.

1700 Valley Road, Wayne, New Jersey 07470  
<http://www.jvc.com>

REFURBISHED PRODUCTS CARRY A SEPARATE WARRANTY, THIS WARRANTY DOES NOT APPLY. FOR DETAIL OF REFURBISHED PRODUCT WARRANTY, PLEASE REFER TO THE REFURBISHED PRODUCT WARRANTY INFORMATION PACKAGED WITH EACH REFURBISHED PRODUCT.

### For customer use:

Enter below the Model No. and Serial No. which is located either on the rear, bottom or side of the cabinet. Retain this information for future reference.

Model No. : \_\_\_\_\_

Serial No. : \_\_\_\_\_

Purchase date : \_\_\_\_\_

Name of dealer : \_\_\_\_\_