

JVC

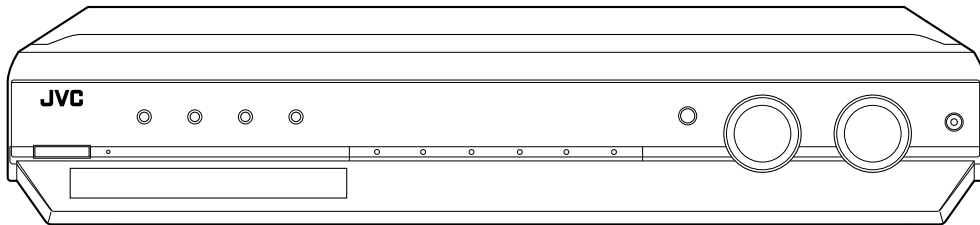

HOME CINEMA CONTROL CENTER DVD VIDEO PLAYER

RX-ES1SL XV-NK58SL

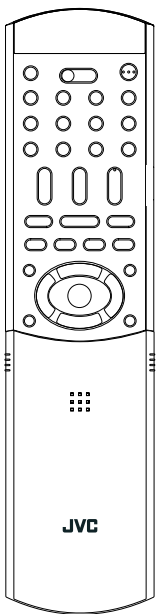

AV COMPU LINK

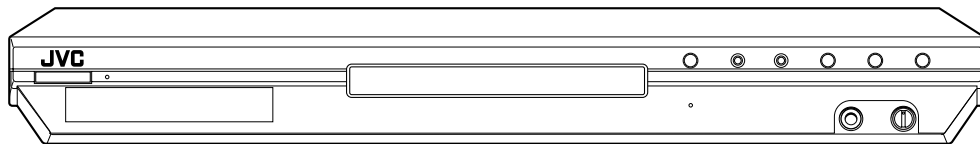

AV COMPU LINK MPEG) Multichannel

INSTRUCTIONS

For Customer Use:

Enter below the Model No. and Serial No. which are located either on the rear, bottom or side of the cabinet. Retain this information for future reference.

Model No. _____

Serial No. _____

Warnings, Cautions, and Others

Caution — STANDBY/ON button!

Disconnect the mains plug to shut the power off completely. The STANDBY/ON  button in any position does not disconnect the mains line. The power can be remote controlled.

CAUTION

To reduce the risk of electrical shocks, fire, etc.:

1. Do not remove screws, covers or cabinet.
2. Do not expose this appliance to rain or moisture.

CAUTION

- Do not block the ventilation openings or holes. (If the ventilation openings or holes are blocked by a newspaper or cloth, etc., the heat may not be able to get out.)
- Do not place any naked flame sources, such as lighted candles, on the apparatus.
- When discarding batteries, environmental problems must be considered and local rules or laws governing the disposal of these batteries must be followed strictly.
- Do not expose this apparatus to rain, moisture, dripping or splashing and that no objects filled with liquids such as vases, shall be placed on the apparatus.

Caution

The model number, supply ratings and identifications are located on the bottom.

IMPORTANT FOR LASER PRODUCTS

1. CLASS 1 LASER PRODUCT
2. **CAUTION:** Do not open the top cover. There are no user serviceable parts inside the Unit; leave all servicing to qualified service personnel.
3. **CAUTION:** Visible and invisible laser radiation when open and interlock failed or defeated. Avoid direct exposure to beam.
4. REPRODUCTION OF LABEL: CAUTION LABEL, PLACED INSIDE THE UNIT.

CAUTION : Visible and invisible laser radiation when open and interlock failed or defeated. AVOID DIRECT EXPOSURE TO BEAM.	ADVARSEL : Synlig og usynlig laserstråling når maskinen er åben eller interlocken fejler. Undgå direkte eksponering til stråling.	VARNING : Synlig og osynlig laserstråling når den öppnas och spärren är urkopplad. Betrakta ej strålen.	VARO : Avattaessa ja suojalukitus ohitettuna tai viallisena olet allittuna näkyvälle ja näkymättömälle lasersäteilylle. Vältä säteen kohdistumista suoraan itseesi.
(e)	(d)	(s)	(f)

Caution: Proper Ventilation / RX-ES1SL

To avoid risk of electric shock and fire and to protect from damage.

Locate the apparatus as follows:

- Front: No obstructions open spacing.
- Sides: No obstructions in 10 cm from the sides.
- Top: No obstructions in 10 cm from the top.
- Back: No obstructions in 15 cm from the back
- Bottom: No obstructions, place on the level surface.

In addition, maintain the best possible air circulation as illustrated.

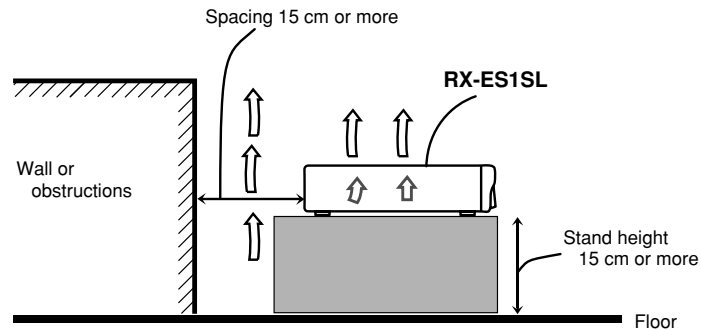

Caution: Proper Ventilation / XV-NK58SL

To avoid risk of electric shock and fire and to protect from damage.

Locate the apparatus as follows:

- Front: No obstructions open spacing.
- Sides: No obstructions in 3 cm from the sides.
- Top: No obstructions in 5 cm from the top.
- Back: No obstructions in 15 cm from the back
- Bottom: No obstructions, place on the level surface.

In addition, maintain the best possible air circulation as illustrated.

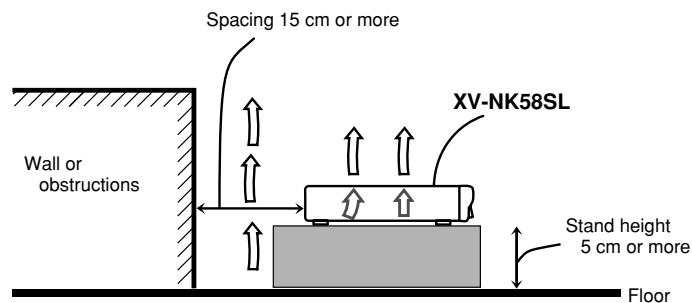

* Do not stack RX-ES1SL and XV-NK58SL.

Table of Contents

Parts identification	2	XV-NK58SL	
Getting started	5	Before operation	33
Precautions	5	About this manual	33
Checking the supplied accessories	5	About discs	33
Putting batteries in the remote control	5	Basic operations	34
Setting the voltage selector (RX-ES1SL)	5	Turning on/off the player	34
Connecting the FM and AM antennas	6	Initial setup	34
Connecting the speakers and DVD player	7	Basic playback	35
Connecting other video components	9	Resuming playback	36
Connecting the power cord	12	Various speed playback	37
		Locating the beginning of a scene or song	38
RX-ES1SL		Advanced operations	39
Basic operations	13	Playing from a specific position	39
1 Turn on the power	13	Changing the playback order	40
2 Select the source to play	13	Repeat playback	42
3 Adjust the volume	14	Changing the language, sound and scene angle	43
Selecting the digital decode mode	14	Special picture/sound effect	44
Turning off the sounds temporarily—Muting	15	Menu bar functions	45
Turning off the power with the Sleep Timer	15	MP3/WMA disc playback	47
Changing the display brightness	15	Operations	47
Speaker settings	16	JPEG disc playback	49
Setting the speakers information automatically		About JPEG discs	49
—Smart Surround Setup	16	Basic operations	49
Setting the speakers and subwoofer information quickly		Viewing pictures continuously (slide show mode)	50
—Quick Setup	17	KARAOKE operation	52
Setting the speakers and subwoofer information manually		Preparation	52
—Manual Setup	18	Reserving songs	52
Basic settings	20	Selecting audio	53
Operating procedure	20	Adding an effect to your voice	55
Setting the digital input (DIGITAL IN) terminals		Shifting the musical key	56
—DIGITAL IN	20	Changing the initial settings	57
Setting Auto Surround—AUTO SR	21	Selecting preferences	57
Setting the video component input mode		Limiting playback by children	60
—DVD VIDEO/DBS VIDEO	21	Additional information	62
Sound adjustments	22	Appendix A: Country/Area code list for Parental Lock	62
Operating procedure	22	Appendix B: Table of languages and their abbreviations	63
Adjusting the tone—BASS, TREBLE	22	Appendix C: Digital output signal chart	63
Adjusting the subwoofer output level—SUBWFR	22	Appendix D: Glossary	64
Adjusting the front speakers output balance—BAL	23		
Reinforcing the bass—B.BOOST	23	AV COMPLU LINK remote control system	65
Attenuating the input signal—ATT	23	Operating other JVC products	67
Tuner operations	24	Operating other manufacturers' equipment	68
Tuning in to stations manually	24	Troubleshooting	70
Using preset tuning	24	Specifications	73
Selecting the FM reception mode	25		
Creating realistic sound fields	26		
Reproducing theater ambience	26		
Introducing the Surround/DSP modes	26		
About relations between speaker layout			
and Surround/DSP modes	28		
Using Surround modes	28		
Using DSP modes	30		
Using the DVD MULTI playback mode	32		
Activating the DVD MULTI playback mode	32		
Adjusting the speaker output level	32		

Parts identification

Remote control

- When operating this receiver (RX-ES1SL), set the mode selector (1) to "AUDIO/TV/VCR/DBS."
- When operating the player (XV-NK58SL), set the mode selector (1) to "DVD."
- When using KARAOKE function, set the mode selector (1) to "KARAOKE."

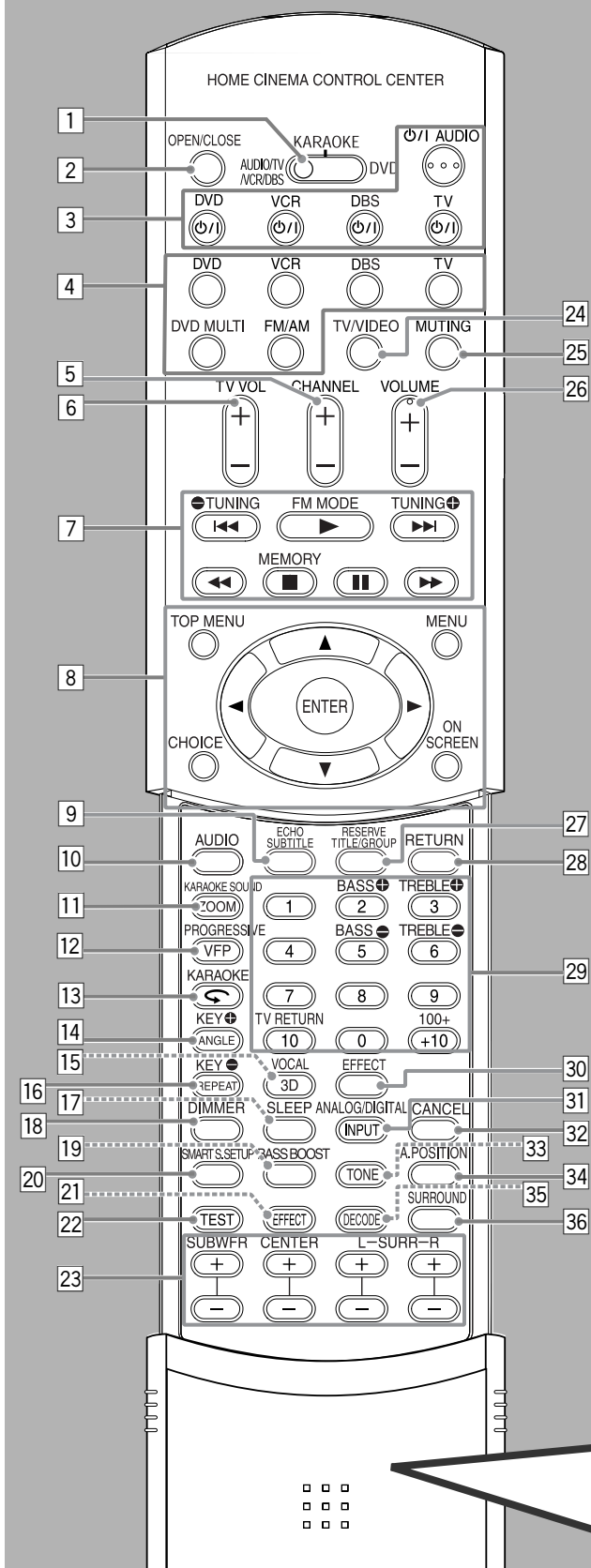

See pages in parentheses for details.

- 1 Mode selector
AUDIO/TV/VCR/DBS, KARAOKE, DVD
- 2 OPEN/CLOSE button (35)
- 3 Standby/on buttons (13, 67 – 69)
⏻/I AUDIO, DVD ⏻/I, VCR ⏻/I, DBS ⏻/I, TV ⏻/I
- 4 Source selecting buttons (13)
DVD, VCR, DBS, TV, DVD MULTI, FM/AM
- 5 CHANNEL +/- buttons (67 – 69)
- 6 TV VOL (volume) +/- buttons (67, 69)
- 7 • Operating buttons for video components (67, 69)
◀, ▶, ▶▶, ◀◀, ■, II, ▶▶
• Operating buttons for tuner (24, 25)
TUNING ⏪, TUNING ⏩, FM MODE, MEMORY
- 8 Operating buttons for DVD
TOP MENU, MENU, CHOICE, ON SCREEN, ENTER, ▶, ◀, ▲, ▼
- 9 • ECHO button (55)
• SUBTITLE button (43)
- 10 AUDIO button (43, 53)
- 11 • KARAOKE SOUND button (54)
• ZOOM button (44, 50)
- 12 • PROGRESSIVE button (10)
• VFP button (44)
- 13 • KARAOKE button (52)
• ↻ button (38)
- 14 • KEY ⏪ button (56)
• ANGLE button (43)
- 15 • VOCAL button (55)
• 3D button (45)
- 16 • KEY ⏩ button (56)
• REPEAT button (42, 48, 51)
- 17 SLEEP button (15)
- 18 DIMMER button (15, 35)
- 19 BASS BOOST button (23)
- 20 SMART S (surround). SETUP button (16)
- 21 EFFECT button (31)
- 22 TEST button (29 – 31)
- 23 Adjusting buttons for speaker and subwoofer output levels (22, 29, 31, 32)
SUBWFR (subwoofer) +/-, CENTER +/-, SURR L (left surround) +/-, SURR R (right surround) +/-
- 24 TV/VIDEO button (67, 69)
- 25 MUTING button (15)
- 26 VOLUME +/- buttons (14)
- 27 • RESERVE button (52)
• TITLE/GROUP button (39, 48, 50)
- 28 RETURN button (39)
- 29 • Numeric buttons for adjusting tone (22)
BASS ⏪/⏩, TREBLE ⏪/⏩
• Numeric buttons for selecting preset channels (25)
• Numeric buttons for operating video components
- 30 EFFECT button (55)
- 31 ANALOG/DIGITAL INPUT button (13, 14)
- 32 CANCEL button (41, 52)
- 33 TONE button (22)
- 34 A (audio).POSITION button (23)
- 35 DECODE button (14)
- 36 SURROUND button (28, 30, 31)

To open the cover of the remote control, push here then slide downward.

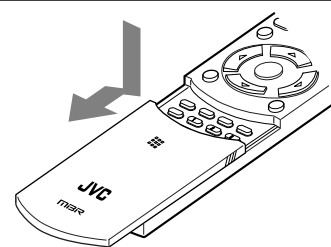

RX-ES1SL

See pages in parentheses for details.

Front panel

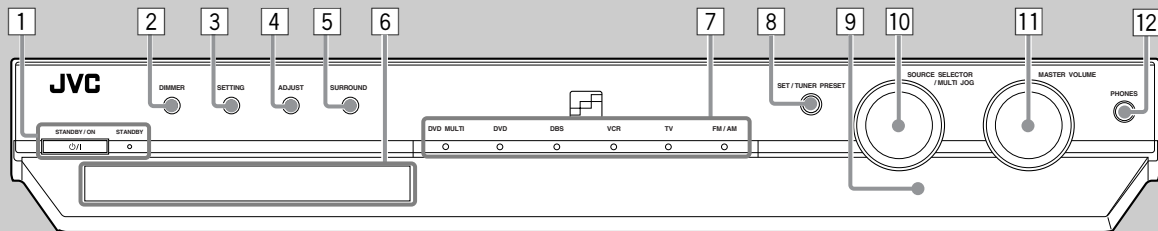

- | | |
|---|--|
| <ul style="list-style-type: none"> 1 STANDBY/ON Φ/I button and STANDBY lamp (13) 2 DIMMER button (15) 3 SETTING button (17, 18, 20) 4 ADJUST button (22, 29, 31, 32) 5 SURROUND button (29, 31) 6 Display window (see below) 7 Source indicators
DVD MULTI, DVD, DBS, VCR, TV, FM/AM | <ul style="list-style-type: none"> 8 • SET button (17, 18, 20, 22, 29 – 32)
• TUNER PRESET button (25) 9 Remote sensor (5) 10 SOURCE SELECTOR
MULTI JOG (17, 18, 20, 22, 25, 29 – 32) 11 MASTER VOLUME control (14) 12 PHONES jack (14) |
|---|--|

Display window

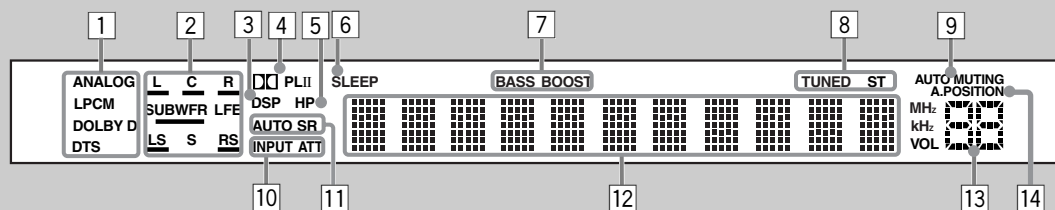

- | | |
|---|---|
| <ul style="list-style-type: none"> 1 Signal format indicators (13, 14)
ANALOG, LPCM (Linear PCM), DOLBY D (Dolby Digital), DTS 2 Signal and speaker indicators (15) 3 DSP indicator (27, 30, 31) 4 \square PLII indicator (26) 5 HP (headphone) indicator (14) 6 SLEEP indicator (15) 7 BASS BOOST indicator (23) | <ul style="list-style-type: none"> 8 Tuner operation indicators (24)
TUNED, ST (stereo) 9 AUTO MUTING indicator (25) 10 INPUT ATT (attenuator) indicator (23) 11 AUTO SR (surround) indicator (21) 12 Main display 13 Volume level indicator (13) 14 A (audio).POSITION indicator (23) |
|---|---|

Rear panel

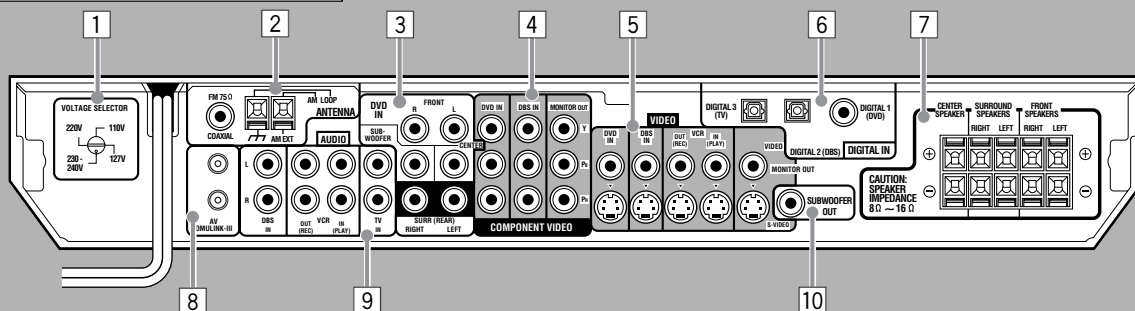

- | | |
|--|---|
| <ul style="list-style-type: none"> 1 VOLTAGE SELECTOR (5) 2 ANTENNA terminals (6) 3 DVD IN terminals (8, 11)
FRONT, CENTER, SURR (REAR), SUBWOOFER 4 COMPONENT VIDEO terminals (8, 9, 11)
DVD IN, DBS IN, MONITOR OUT 5 VIDEO terminals (8 – 11)
DVD IN, DBS IN, VCR OUT (REC)/IN (PLAY), MONITOR OUT | <ul style="list-style-type: none"> 6 DIGITAL IN terminals (8, 12)
DIGITAL 1 (DVD), DIGITAL 2 (DBS), DIGITAL 3 (TV) 7 Speaker terminals (7)
FRONT SPEAKERS, SURROUND SPEAKERS, CENTER SPEAKER 8 AV COMPULINK-III terminals (65) 9 AUDIO terminals (9 – 11)
DBS IN, VCR OUT (REC)/IN (PLAY), TV IN 10 SUBWOOFER OUT jack (7) |
|--|---|

XV-NK58SL

See pages in parentheses for details.

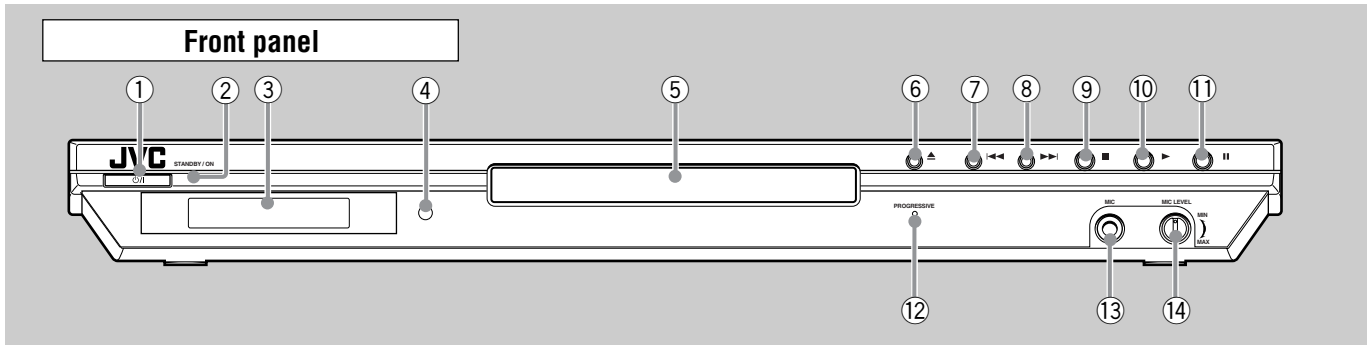

- | | |
|------------------------------|------------------------------|
| ① ⏻ button (34) | ⑧ ⏮ button (37, 39) |
| ② STANDBY/ON indicator (34) | ⑨ ■ button (35, 36) |
| ③ Display window (see below) | ⑩ ▶ button (35, 36) |
| ④ Remote sensor (5) | ⑪ button (36, 37) |
| ⑤ Disc tray (35) | ⑫ PROGRESSIVE indicator (10) |
| ⑥ ▲ button (35) | ⑬ MIC jack (52) |
| ⑦ ◀ button (37, 39) | ⑭ MIC LEVEL control (52) |

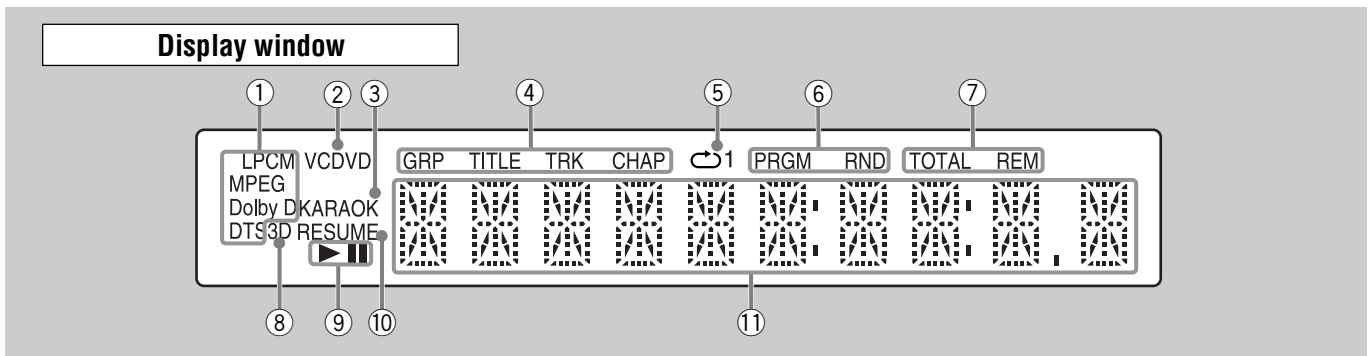

- | | |
|--|--|
| ① Audio format indicators | ⑦ Total time/remaining time indicators |
| ② Disc indicator | ⑧ 3D indicator |
| ③ Karaoke indicator | ⑨ ▶ (play)/ (pause) indicators |
| ④ Group/title/track/chapter indicators | ⑩ Resume indicator |
| ⑤ Repeat mode indicator | ⑪ Multi-information window |
| ⑥ Program/random indicators | |

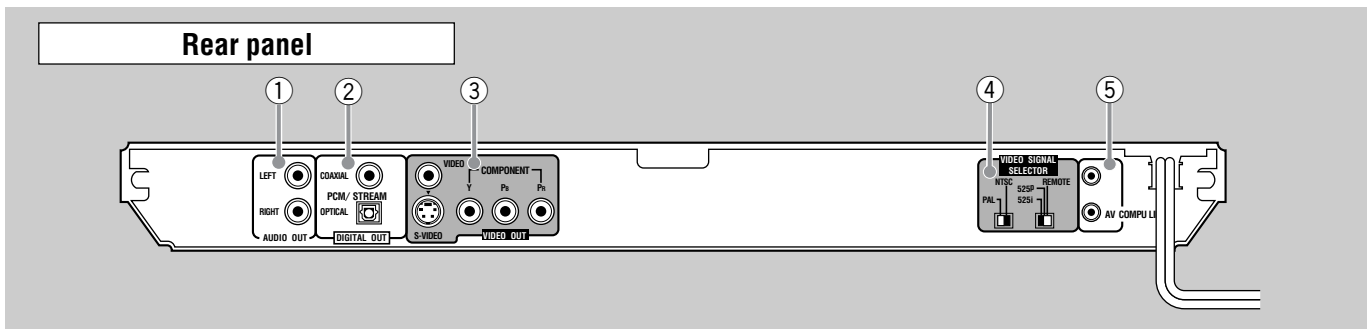

- ① AUDIO OUT LEFT/RIGHT jacks
- ② DIGITAL OUT jacks (8)
COAXIAL, OPTICAL
- ③ VIDEO OUT jacks*
VIDEO, S-VIDEO, COMPONENT
- ④ VIDEO SIGNAL SELECTOR (9)
NTSC, PAL
REMOTE, 525p, 525i
- ⑤ AV COMPU LINK terminals

NOTE

* **When connecting the DVD player (XV-NK58SL) to the receiver (RX-ES1SL) or TV**
Connect only one of the following jacks—the VIDEO (composite), S-VIDEO, or COMPONENT jacks.
Color and brightness do not display correctly if you connect them using more than two types of jacks at the same time.

Getting started

Precautions

General precautions

- DO NOT disassemble the unit or remove screws, covers, or cabinet.
- DO NOT expose the unit to rain or moisture.
- DO NOT expose the unit to direct sunlight or place it near a heating device.

Locations

- Install the receiver in a location that is level and protected from moisture and dust.
If water gets inside the unit, turn off the power and remove the plug from the outlet, then consult your dealer. Using the unit in this state may cause a fire or electrical shock.
- Select a place which is level, dry and neither too hot nor too cold between 5°C and 35°C
- Make sure there is good ventilation around the receiver. Poor ventilation could cause overheating and damage the receiver.
- Leave sufficient distance between the unit and the TV.
- Do not install the unit in a place subject to vibrations.

Handling the receiver

- DO NOT touch the power cord with wet hands.
- DO NOT pull on the power cord to unplug the cord. When unplugging the cord, always grasp the plug so as not to damage the cord.
- Keep the power cord away from the connecting cords and the antenna. The power cord may cause noise or screen interference. It is recommended to use a coaxial cable for antenna connection, since it is well-shielded against interference.
- When a power failure occurs, or when you unplug the power cord, the preset settings such as preset FM or AM channels and sound adjustments may be erased in a few days.
- When you are away on travel or otherwise for an extended period or time, remove the plug from the wall outlet. A small amount of power is always consumed while the power cord is connected to the wall outlet.

To prevent the malfunction

- There are no user-servicable parts inside. If anything goes wrong, unplug the power cord and consult your dealer.
- Do not insert any metallic objects, such as wires, hairpins, coins, etc. into the unit.
- Do not block the vents. Blocking the vents may damage the unit.

To clean the cabinet

- Use a soft cloth. Follow the relevant instructions on the use of chemically-coated cloths.
- Do not use benzene, thinner or other organic solvents and disinfectants. These may cause deformation or discoloring.

Checking the supplied accessories

Check to be sure you have all of the following supplied accessories. The number in parentheses indicates the quantity of each piece supplied.

- Remote control (1)
- Batteries (2)
- AM loop antenna (1)
- FM antenna (1)
- Digital coaxial cord (1)
- Audio/video cord (1)

If anything is missing, contact your dealer immediately.

Putting batteries in the remote control

Before using the remote control, put two supplied batteries first.

- When using the remote control, aim the remote control directly at the remote sensor on the front panel.

1 Press and slide the battery cover on the back of the remote control.

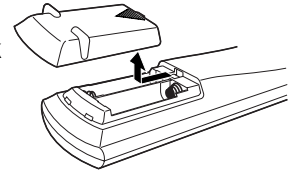

2 Insert batteries.

Make sure to match the polarity: (+) to (+) and (-) to (-).

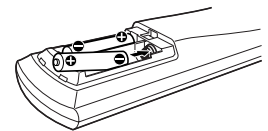

3 Replace the cover.

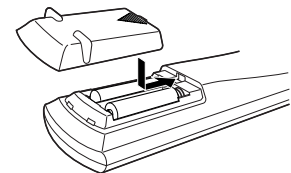

If the range or effectiveness of the remote control decreases, replace the batteries. Use two R6P(SUM-3)/AA(15F) type dry-cell batteries.

- Supplied batteries are for initial setup. Replace for continued use.

CAUTION:

Follow these precautions to avoid leaking or cracking cells:

- Place batteries in the remote control so they match the polarity: (+) to (+) and (-) to (-).
- Use the correct type of batteries. Batteries that look similar may differ in voltage.
- Always replace both batteries at the same time.
- Do not expose batteries to heat or flame.

Setting the voltage selector (RX-ES1SL)

Before connections, always do the following first if necessary.

Select the correct voltage in VOLTAGE SELECTOR on the rear of the receiver by using a screw driver. Check to be sure if the voltage mark is set to the voltage for your area where this unit plugs in.

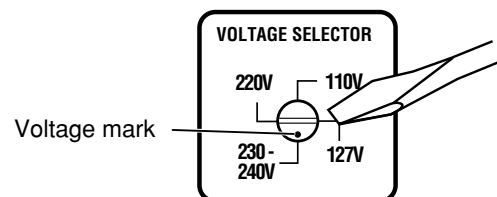

Connecting the speakers and DVD player

Turn off all components before connections.

Speaker Layout Diagram

After connecting the front, center and surround speakers, and/or a subwoofer, set the speaker setting information properly to obtain the best possible surround effect. For details, see pages 16 to 19.

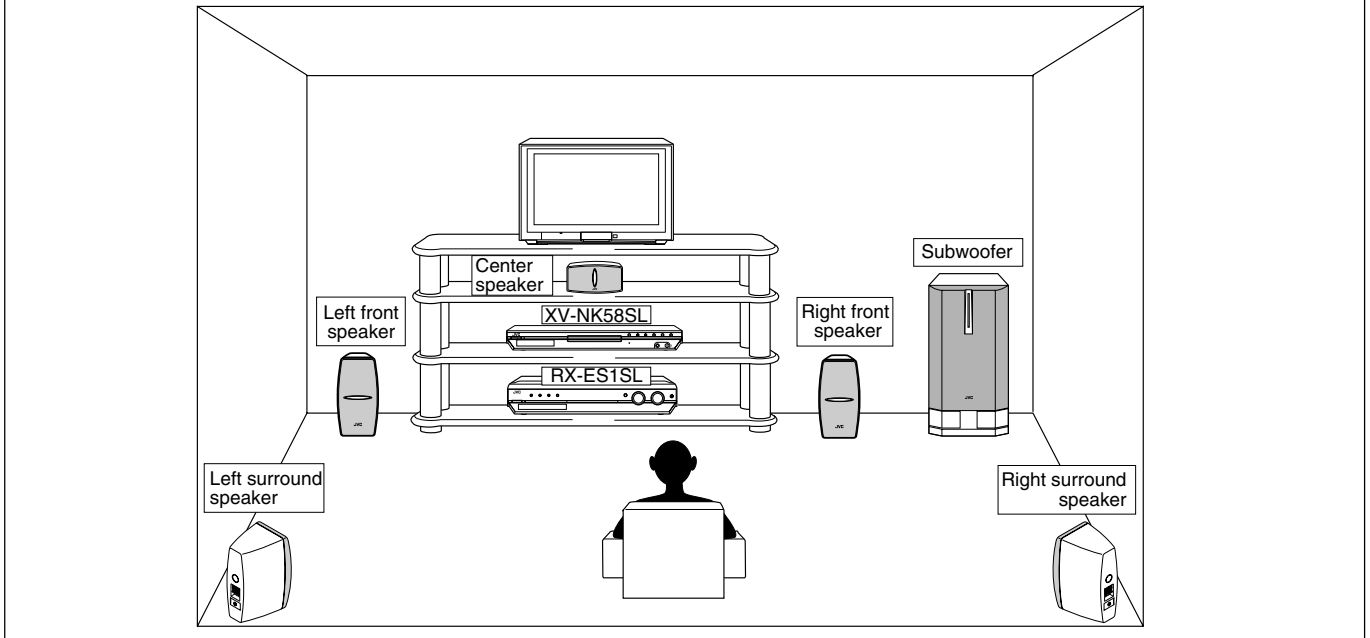

Connecting the front, center, and surround speakers

For each speaker, connect the (+) and (-) terminals on the rear panel to the (+) and (-) terminals marked on the speakers respectively.

- 1** Twist and remove the insulation at the end of each speaker cord (not supplied).
- 2** Press and hold the clamp of the speaker terminal (1), then insert the speaker cord (2).
- 3** Release the finger from the clamp.

CAUTION:

Use speakers with the SPEAKER IMPEDANCE indicated by the speaker terminals.

Connecting the subwoofer

By connecting a subwoofer, you can enhance the bass or reproduce the original LFE signals recorded in the digital software.

Connect the input jack of a powered subwoofer to the SUBWOOFER OUT jack on the rear panel, using a cord with RCA pin plugs (not supplied).

• Refer also to the manual supplied with your subwoofer.

NOTE

You can place a subwoofer wherever you like since bass sound is non-directional. Normally place it in front of you.

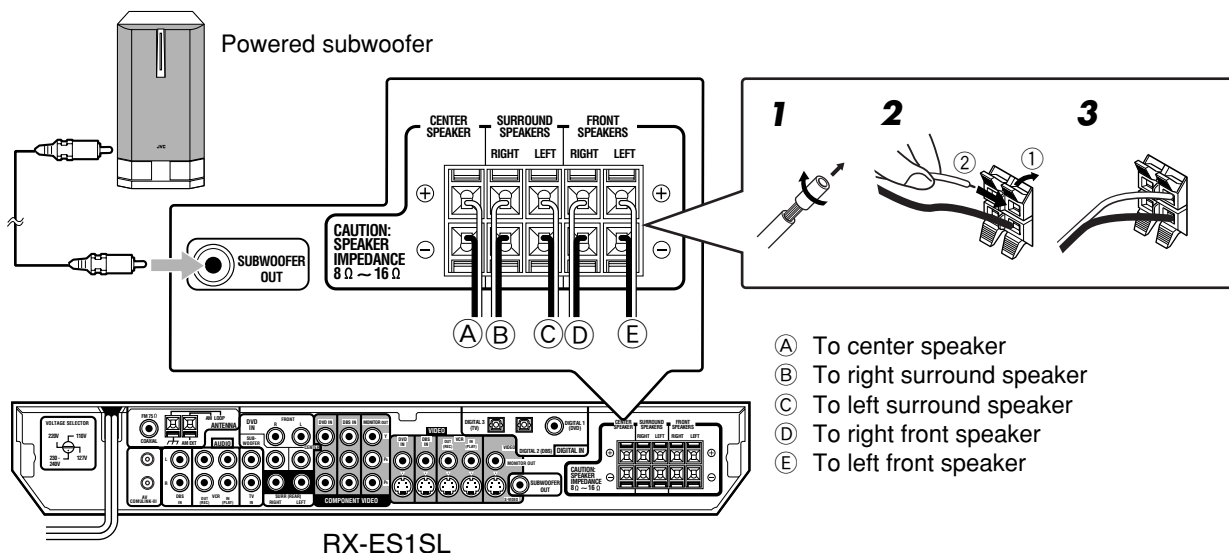

Connecting the DVD player (XV-NK58SL)

Notes for video connection:

- You can use component video cord in addition to composite video cord and S-video cord.
- By using S-video cord or component video cord, you can get a better picture quality—in the order: composite < S-video < component.
- To view the picture from the DVD player, connect your TV to this receiver using the same type of cord.

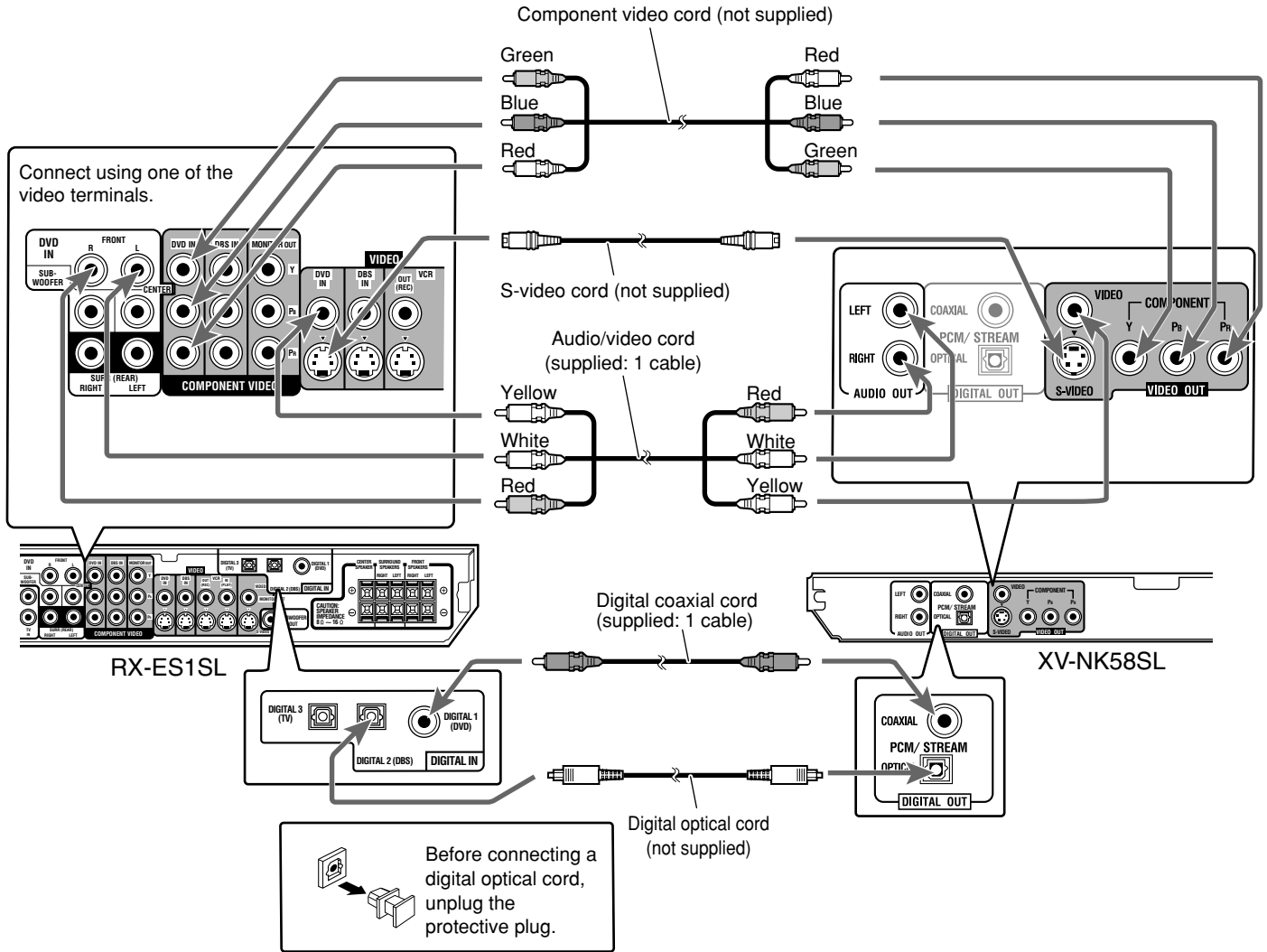

NOTES

- When shipped from the factory, the DIGITAL IN terminals have been set for use with the following components:
 - DIGITAL 1 (coaxial): For DVD player
 - DIGITAL 2 (optical): For DBS tuner
 - DIGITAL 3 (optical): For TV tuner
 If you connect other components, change the digital input (DIGITAL IN) terminal setting correctly. See "Setting the digital input (DIGITAL IN) terminals—DIGITAL IN" on page 20.
- Select the correct digital input mode. See "Selecting the analog or digital input mode" on page 13.
- To enjoy the digital sound, digital connection is required—Digital optical connection or Digital coaxial connection.

Connecting other video components

Turn off all components before making connections.

- Illustrations of the input/output terminals are typical examples. When you connect other components, refer also to their manuals since the terminal names actually printed on the rear vary among different components.

Notes for video connection:

- You can use composite video cord or S-video cord for connecting the VCR to this receiver.
- You can use component video cord in addition to composite video cord and S-video cord for connecting your DVD player, TV and DBS tuner to this receiver.
- By using S-video cord or component video cord, you can get a better picture quality—in the order: composite < S-video < component.
- To view the picture from the DVD player, DBS tuner or VCR on your TV, connect your TV to this receiver using the same type of cord for connecting the DVD player, DBS tuner or VCR to this receiver.

TV connection

DO NOT use a TV through a VCR or a TV with a built-in VCR; Otherwise, the picture may be distorted.

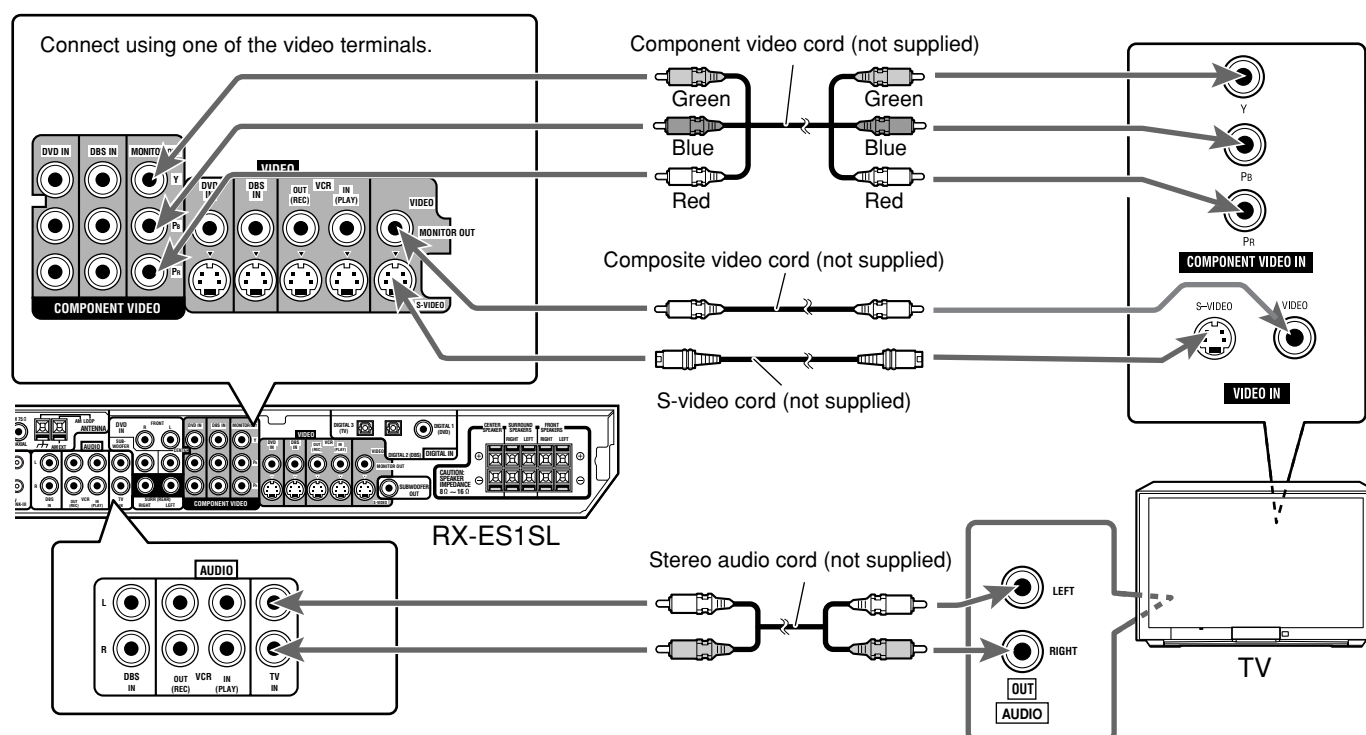

About VIDEO SIGNAL SELECTOR on XV-NK58SL

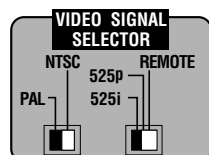

Selecting PAL or NTSC

Set the PAL/NTSC selector on the rear panel to "PAL" or "NTSC" to match the color system of your TV. Make sure that the color system of a DVD VIDEO/SVCD/video CD disc labeled on the package matches your TV.

If you use a multi-color system TV, you can play discs recorded on both PAL and NTSC systems by setting the PAL/NTSC selector appropriately.

- Change the PAL/NTSC selector position in stop mode or with no disc inserted. The changed setting is not effective if you change the selector position in playback mode.

Selecting the 525i/525p/REMOTE selector position

You must change the 525i/525p/REMOTE selector position while the player power is off. Otherwise, the changed setting is not effective.

- If your television equipped with component jacks does not support the progressive scanning mode, set the selector to "525i."
- If your television equipped with component jacks supports the progressive scanning mode, set the selector to "525p."
- If you want to select the scanning mode between the interlace and progressive modes (depending on the source condition, or when connecting more than one television, etc.), set the selector to "REMOTE."

Getting started

Activating the Progressive scanning mode using the remote control unit

When the player is turned on and the 525i/525p/REMOTE selector is set to "REMOTE," press and hold down PROGRESSIVE for a few seconds.

The scanning mode switches between the Progressive scanning and Interlaced scanning modes.

When the scanning mode is set to the Progressive mode, the PROGRESSIVE indicator on the front panel turns on.

Depending on the [PICTURE SOURCE] setting on the [PICTURE] preference display and whether the current DVD VIDEO disc is film-source or video-source, the color of the indicator differs, as shown in the table below.

Setting of [PICTURE SOURCE]	Source type of DVD VIDEO	
	Film source	Video source
AUTO	Green	Red
FILM	Green	Green
VIDEO (NORMAL)/ (ACTIVE)	Red	Red

* While stopped in the Progressive scanning mode, the PROGRESSIVE indicator is lit in red regardless of the [PICTURE SOURCE] selection.

NOTES

- The Progressive scanning mode works only when you connect the player's COMPONENT VIDEO OUT jacks to your TV.
- The Progressive scanning mode works only when the signal format is NTSC.
- There are some progressive TV and High-Definition TV sets that are not fully compatible with the player, resulting in the unnatural picture when playing back a DVD VIDEO disc in the Progressive scanning mode. In such a case, use the Interlaced scanning mode. To check the compatibility of your TV set, contact your local JVC customer service center.
- All JVC progressive TV and High-Definition TV sets are fully compatible with the player (Example: AV-61S902).
- The VIDEO jack, S-VIDEO jack and COMPONENT VIDEO OUT jacks cannot be used at the same time. Connect cable(s) only to the jack(s) you want to use.

Progressive scan video playback available

In the Progressive scanning mode, you can enjoy high quality picture with less flickers when the COMPONENT VIDEO OUT jacks are connected to a TV or monitor that supports the progressive video input.

About the scanning mode

Depending on the material source format, DVD VIDEO discs can be classified into two types; film source and video source (note that some DVD VIDEO discs contain both film source and video source). Film sources are recorded as 24-frame-per-second information, while (NTSC) video sources are recorded as 30-frame-per-second (60-field-per-second interlaced) information.

When the player plays back a film source material, uninterlaced progressive output signals are created using the original information. When a video source material is played back, the player interleaves lines between the interlaced lines on each to create the interpolated picture and outputs as the progressive signal.

VCR connection

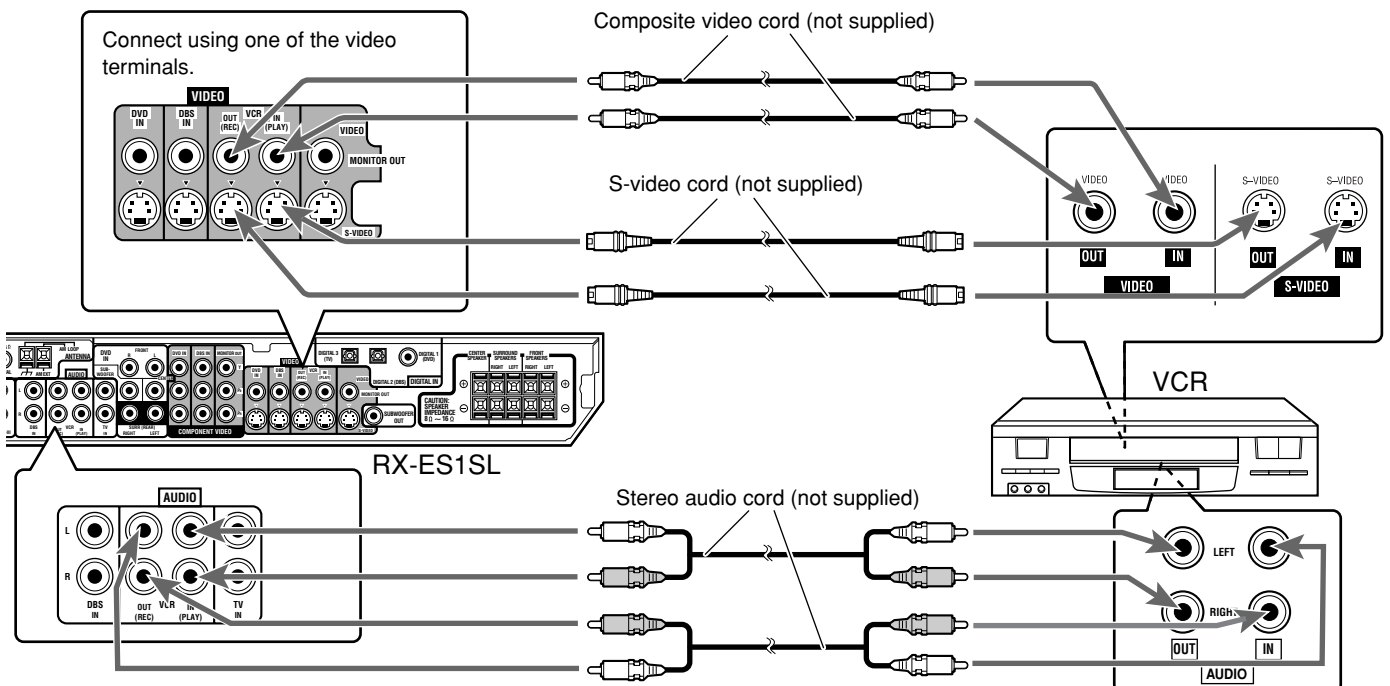

DBS tuner connection

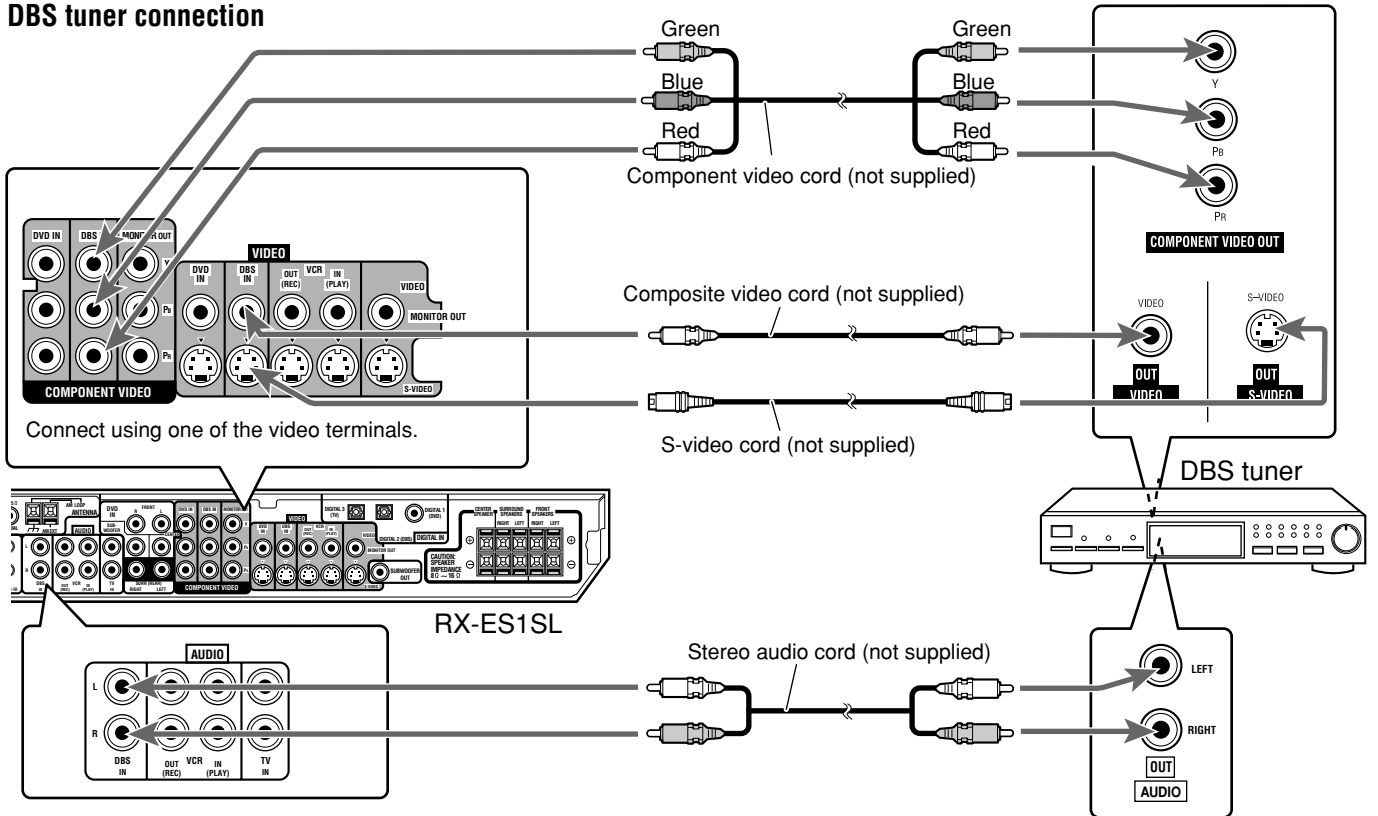

Analog connection for DVD MULTI playback (see page 32)

- DVD MULTI playback is not available for XV-NK58SL. See page 8 for how to connect XV-NK58SL.

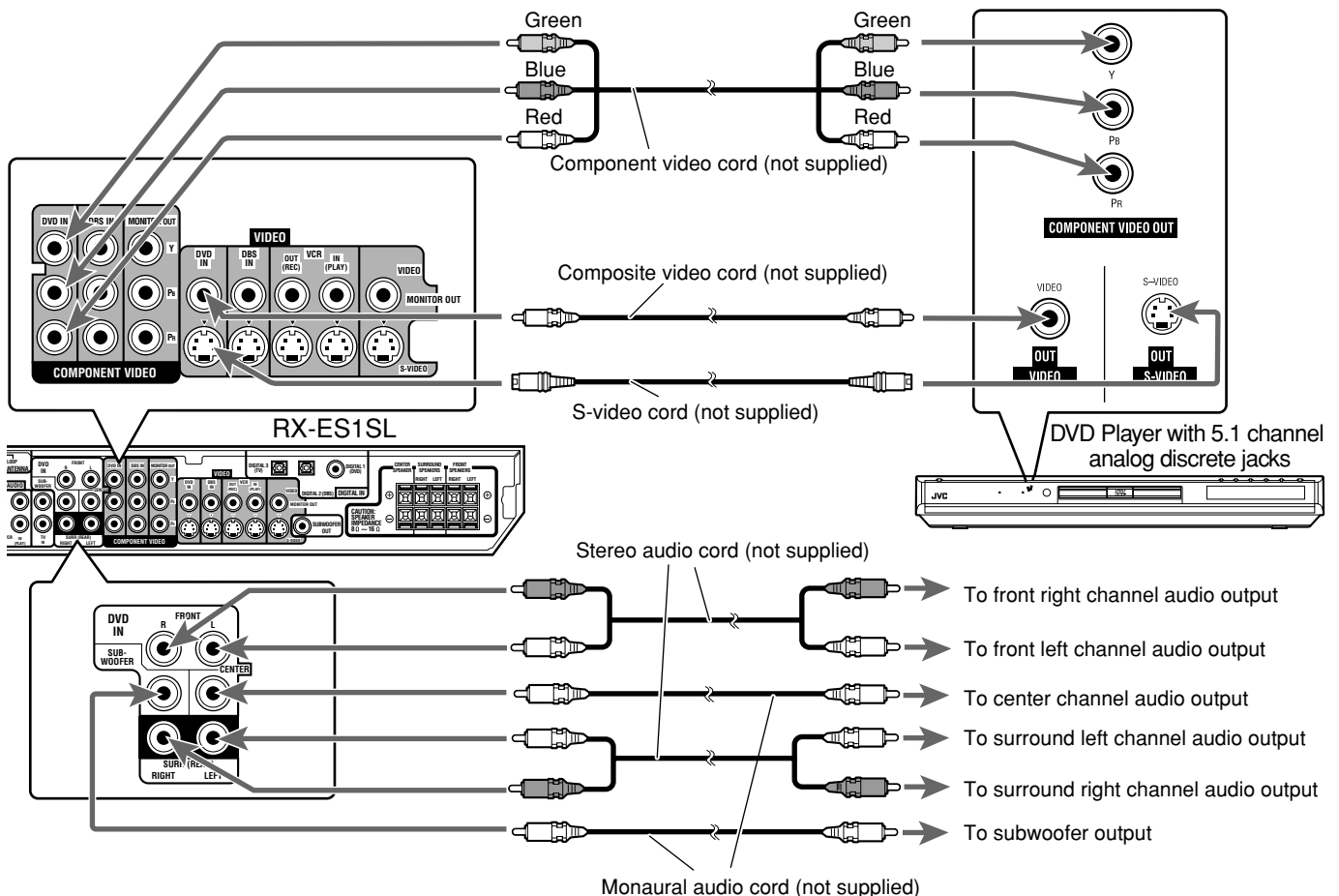

CONTINUED ON THE NEXT PAGE

Digital connection

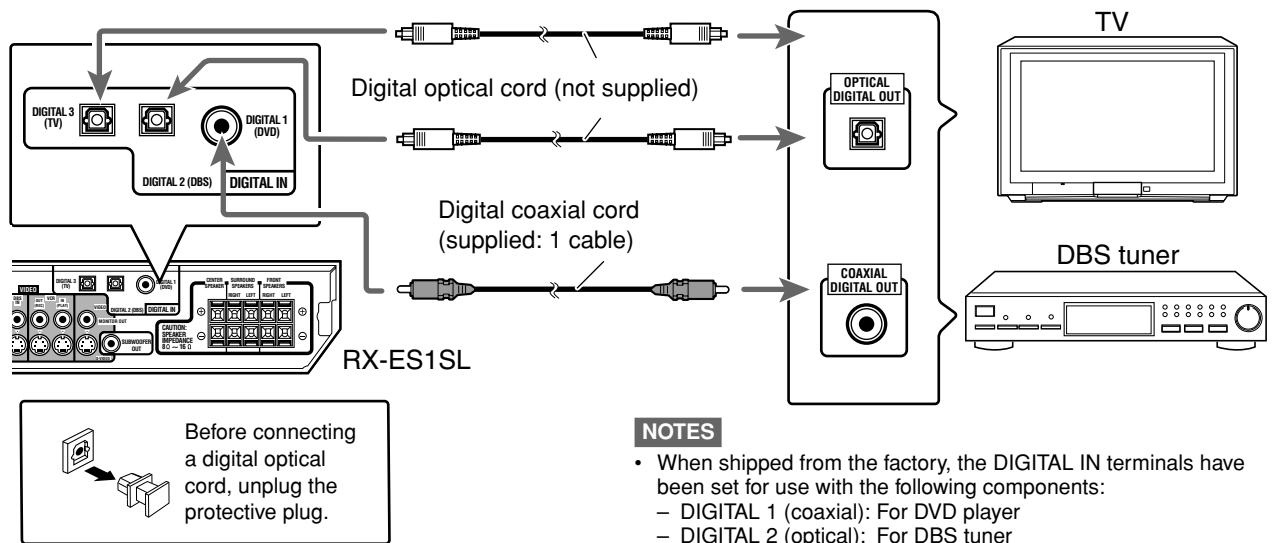

NOTES

- When shipped from the factory, the DIGITAL IN terminals have been set for use with the following components:
 - DIGITAL 1 (coaxial): For DVD player
 - DIGITAL 2 (optical): For DBS tuner
 - DIGITAL 3 (optical): For TV tunerIf you connect other components, change the digital input (DIGITAL IN) terminal setting correctly. See “Setting the digital input (DIGITAL IN) terminals—DIGITAL IN” on page 20.
- Select the correct digital input mode. See “Selecting the analog or digital input mode” on page 13.

Connecting the power cord

When all the audio/video connections have been made, connect the AC power plug to the wall outlet. Make sure that the plugs are inserted firmly. The STANDBY lamp on the receiver and indicator on the DVD player light in red.

- Keep the power cord away from the connecting cables and the antenna. The power cord may cause noise or screen interference.

NOTES

- The preset settings such as preset channels and sound adjustment may be erased in a few days in the following cases:
 - when you unplug the power cord.
 - when a power failure occurs.
- Disconnect the power cord:
 - if you are not going to use the player for a long period of time.
 - before cleaning the player.
 - before moving the player.

CAUTIONS:

- Do not touch the power cord with wet hands.
- Do not alter, twist or pull the power cord, or put anything heavy on it, which may cause fire, electric shock, or other accidents.
- If the cord is damaged, consult a dealer and have the power cord replaced with a new one.
- Do not plug in before setting the voltage selector switch on the rear of the receiver and all connection procedures are completed.

RX-ES1SL

Basic operations

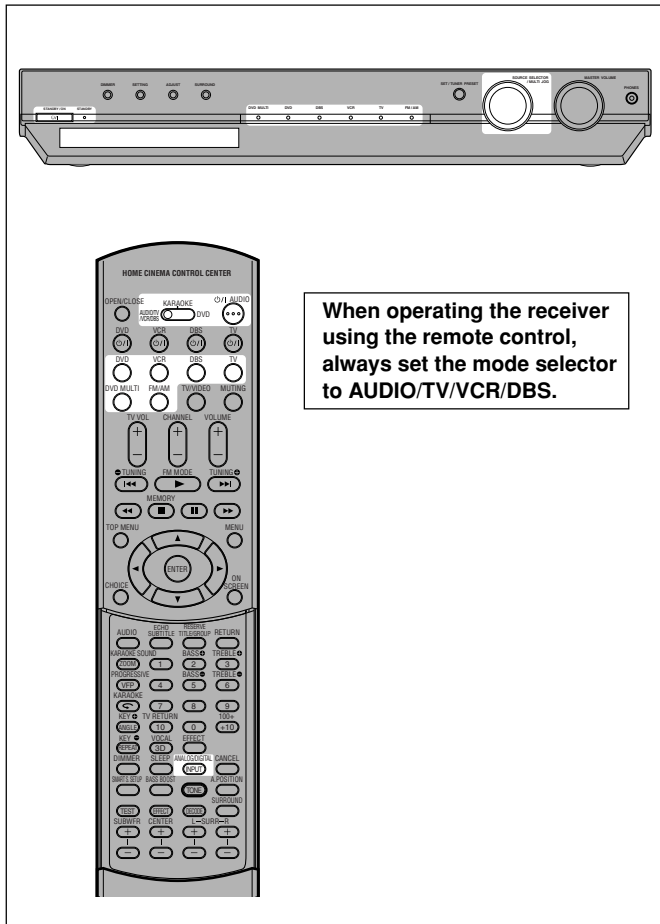

2 Select the source to play

On the front panel:

Turn **SOURCE SELECTOR** until the source name you want appears on the display.

The source indicator corresponding to the selected source lights in red.

- As you turn SOURCE SELECTOR, the source changes as follows:

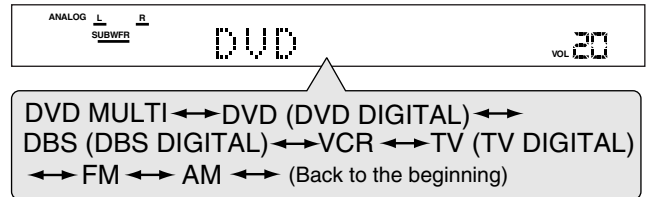

From the remote control:

Press one of the source selecting buttons.

- Each time you press FM/AM, FM and AM changes alternately.

DVD MULTI: Select the DVD player using the analog discrete output mode (5.1 channel reproduction). To enjoy the DVD MULTI playback, see page 32.

DVD (DIGITAL)*: Select the DVD player.

DBS (DIGITAL)*: Select the DBS tuner.

VCR: Select the VCR.

TV (DIGITAL)*: Select the TV tuner.

FM: Select an FM broadcast.

AM: Select an AM broadcast.

1 Turn on the power

Press **STANDBY/ON** (or **AUDIO** on the remote control).

The STANDBY lamp goes off. The current source indicator lights in red. The name of the current source (or station frequency) appears on the display.

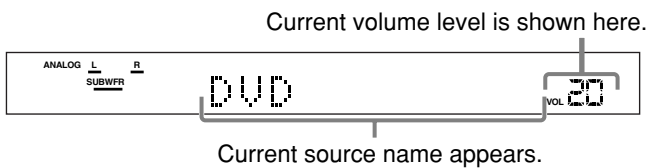

To turn off the power (into standby)

Press **STANDBY/ON** again (or **AUDIO** on the remote control). The STANDBY lamp lights up.

NOTE

A small amount of power is consumed in standby mode. To turn the power off completely, unplug the AC power cord.

* Selecting the analog or digital input mode

When you have connected the DVD player, DBS tuner, or TV tuner using both the analog connection and the digital connection methods (see pages 8 to 12), you need to select the correct input mode.

- You can select the digital input only for sources which you have selected digital input terminals for. (See "Setting the digital input (DIGITAL IN) terminals—DIGITAL IN" on page 20.)

From the remote control ONLY:

Press **ANALOG/DIGITAL INPUT** to select the analog or digital input mode.

- Each time you press the button, the input mode alternates between the analog input ("ANALOG") and the digital input ("DGTL AUTO").

DGTL AUTO: Select for the digital input mode. The receiver automatically detects the incoming signal format, then the digital signal format indicator (DOLBY D, DTS or LPCM) for the detected signals lights up.

ANALOG*: Select for the analog input mode.

* Initial setting

NOTE

You cannot select the digital input mode when selecting "DVD MULTI" as the playing source.

Basic operations

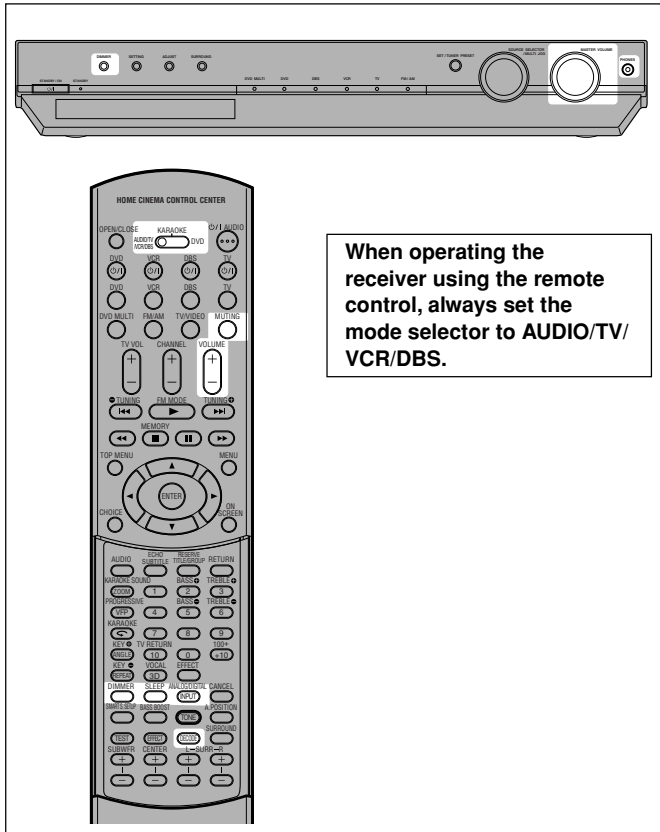

3 Adjust the volume

To increase the volume, turn **MASTER VOLUME** control clockwise (or press **VOLUME +** on the remote control).

To decrease the volume, turn **MASTER VOLUME** control counterclockwise (or press **VOLUME -** on the remote control).

CAUTION:

Always set the volume to the minimum before starting any sources. If the volume is set at its high level, the sudden blast of sound energy can permanently damage your hearing and/or ruin your speakers.

NOTE

The volume level can be adjusted within the range of "0" (minimum) to "50" (maximum).

Listening with headphones

Connect a pair of headphones to the PHONES jack on the front panel. This cancels the Surround mode currently selected, deactivates speakers, and activates the HEADPHONE mode. The HP (headphone) indicator lights up on the display.

- Disconnecting a pair of headphone from the PHONES jack cancels the HEADPHONE mode and activates the speakers.

HEADPHONE mode

When using the headphones, the following signal is output regardless of your speaker setting:

- For 2 channel sources, the front left and right channel signal is output directly from the left and right headphones.
- For multi-channel sources, the front left and right, center and surround channel signal is down-mixed and then output from the headphones without missing bass element. You can enjoy multi-channel sound source using the headphones.

CAUTION:

Be sure to turn down the volume:

- Before connecting or putting on headphones, as high volume can damage both the headphones and your hearing.
- Before removing headphones, as high volume may output from the speakers.

Selecting the digital decode mode

If the following symptoms occur while playing Dolby Digital or DTS Digital Surround software with "DGTL AUTO" selected (see page 13), follow the procedure below:

- Sound does not come out at the beginning of playback.
- Noise comes out while searching for or skipping chapters or tracks.

From the remote control ONLY:

1 Press **ANALOG/DIGITAL INPUT** to select "DGTL AUTO."

2 Press **DECODE** to select "DGTL D.D." or "DGTL DTS."

- Each time you press the button, the digital decode mode changes as follows:

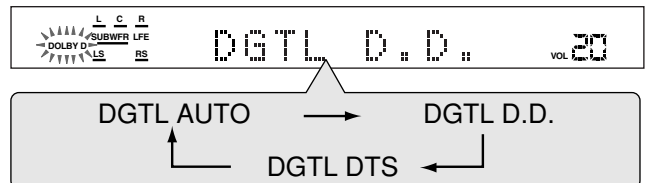

- To play back software encoded with Dolby Digital, select "DGTL D.D."
- To play back software encoded with DTS Digital Surround, select "DGTL DTS."

NOTE

When you turn off the power or select another source, "DGTL DTS" or "DGTL D.D." is canceled and the digital decode mode is automatically reset to "DGTL AUTO."

The following are the analog/digital signal format indicators on the display to indicate what type of signal comes into the receiver.

- ANALOG:** Lights when analog input is selected.
- LPCM:** Lights when Linear PCM signal comes in.
- DOLBY D:**
 - Lights when Dolby Digital signal comes in.
 - Flashes when "DGTL D.D." is selected for software not encoded with Dolby Digital.
- DTS:**
 - Lights when DTS signal comes in.
 - Flashes when "DGTL DTS" is selected for software not encoded with DTS.

NOTE

When "DGTL AUTO" cannot recognize the incoming signal, no digital signal format indicator lights up on the display.

Turning off the sounds temporarily—Muting

From the remote control ONLY:

Press **MUTING** to turn off the sound through all connected speakers.

“MUTING” appears on the display and the volume turns off (the volume level indicator goes off).

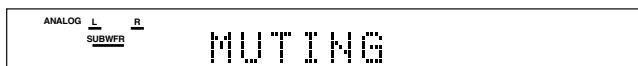

To restore the sound, press **MUTING** again.

- Pressing **VOLUME +/-** (or turning **MASTER VOLUME** control on the front panel) also restores the sound.

Turning off the power with the Sleep Timer

You can fall asleep while listening to music—Sleep Timer.

From the remote control ONLY:

Press **SLEEP** repeatedly.

The **SLEEP** indicator lights up on the display, and the shut-off time changes in 10 minutes intervals.

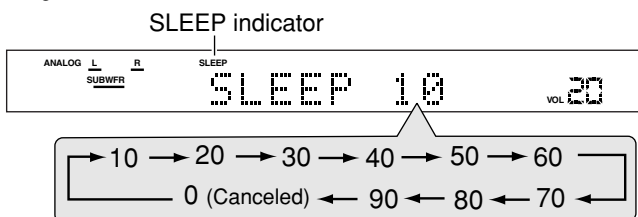

When the shut-off time comes:

The receiver turns off automatically.

To check or change the remaining time until the shut-off time:

Press **SLEEP** once.

The remaining time (in minutes) until the shut-off time appears.

- To change the shut-off time, press **SLEEP** repeatedly.

To cancel the Sleep Timer:

Press **SLEEP** repeatedly until “SLEEP 0” appears on the display. (The **SLEEP** indicator goes off.)

- Turning off the power also cancels the Sleep Timer.

Changing the display brightness

You can dim the display.

Press **DIMMER** repeatedly.

- Each time you press the button, the indication changes as follows:

- DIMMER 1:**
 - Dims the display slightly.
 - Dims the blue indication lighting source lamps.
- DIMMER 2:**
 - Dims the display more than DIMMER 1.
 - Dims the blue indication lighting source lamps (same as DIMMER 1).
- DIMMER 3:** Turns off the display and the blue indication lighting source lamps.
- DIMMER OFF:** Cancels the dim (normal display).

NOTES

- When setting speakers and basic items or adjusting sound, select “**DIMMER OFF**” to confirm the setting you make on the display.
- When selecting DVD or DVD MULTI as a source using the remote control, **DIMMER** functions for the DVD player. To dim the display and indication on the receiver, select a source except DVD or DVD MULTI on the remote control, and then press **DIMMER**.

Basic adjustment of auto memory

This receiver memorizes sound settings for each source:

- when you turn off the power,
- when you change the source, and
- when you change the analog/digital input mode (see page 13).

When you change the source, the memorized settings for the newly selected source are automatically recalled.

The following can be stored for each source:

- Analog/digital input mode (see page 13)
- Tone adjustment (see page 22)
- Subwoofer output level (see page 22)
- Bass boost (see page 23)
- Input attenuator mode (see page 23)
- Balance (see page 23)
- Subwoofer audio position (see page 23)
- Surround/DSP mode selection (see pages 26 – 31)

NOTES

- If the source is FM or AM, you can assign a different setting for each band.
- You cannot assign and store different settings for digital input mode and analog input mode.

Signal and speaker indicators on the display

Signal indicators

Speaker indicators

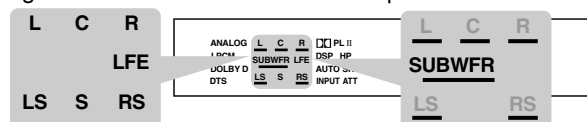

The following signal indicators light up —:

- L:**
 - When digital input is selected: Lights up when the left channel signal comes in.
 - When analog input is selected: Always lights up.
- R:**
 - When digital input is selected: Lights up when the right channel signal comes in.
 - When analog input is selected: Always lights up.
- C:** Lights up when the center channel signal comes in.
- LS:** Lights up when the left surround channel signal comes in.
- RS:** Lights up when the right surround channel signal comes in.
- S:** Lights up when the monaural surround channel signal comes in.
- LFE:** Lights up when the LFE channel signal comes in.

The speaker indicators light up as follows:

- The subwoofer indicator (**SUBWFR**) lights up when “**USE**” for Quick Setup (see page 17) or to “**YES**” for Manual Setup (see page 18).
- The other speaker indicators light up only when the corresponding speaker is set to “**SML**” or “**LRG**,” and also when required for the current playback.

RX-ES1SL

Speaker settings

To obtain the best possible surround effect from Surround/DSP modes (see pages 26 to 31), you need to set up the speaker and subwoofer information after all the connections are completed. You can set the speaker information using one of the following three methods.

- Smart Surround Setup:** Set the speakers information automatically by one simple action—clapping hands. The delay time and output level for the center and surround speakers are set automatically.
- Quick Setup:** Set the speakers and subwoofer information quickly by entering the use of the subwoofer, the number of the speakers, and your room size.
- Manual Setup:** Set the speakers and subwoofer information manually.

- Before starting the speaker setting, connect and position the speakers and subwoofer (see page 7) and turn on the receiver.

Setting the speakers information automatically—Smart Surround Setup

The distance from your listening point to the speakers is one of the important element to obtain the best possible sound effect for the Surround/DSP modes.

You need to set the delay time of the center and surround speakers relative to the front speakers so that sounds through all the speakers can reach you at the same time (see also page 19).

By using Smart Surround Setup, the speaker delay time and output level are automatically calculated by one simple action—clapping hands.

- To set the speaker information effectively using Smart Surround Setup, unplug the power cords of all the components connected to this receiver such as a TV, DVD player, DBS tuner, and VCR which may cause noise.
- To use Smart Surround Setup effectively, connect both the center and surround speakers.
- You can also set the crossover frequency, the low frequency effect attenuator and the dynamic range compression manually (see page 19).
- When you change your speakers, do the following steps again.

From the remote control ONLY:

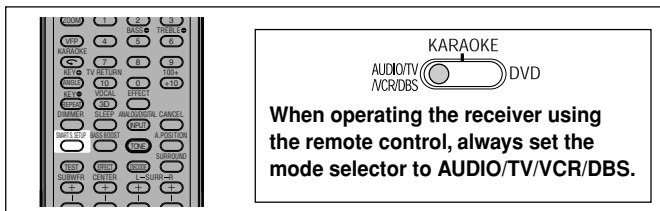

Before you start, remember...

There is a time limit in doing the following steps. If the setting is canceled before you finish, start from step **2** again.

1 Take your position where you listen to the sound.

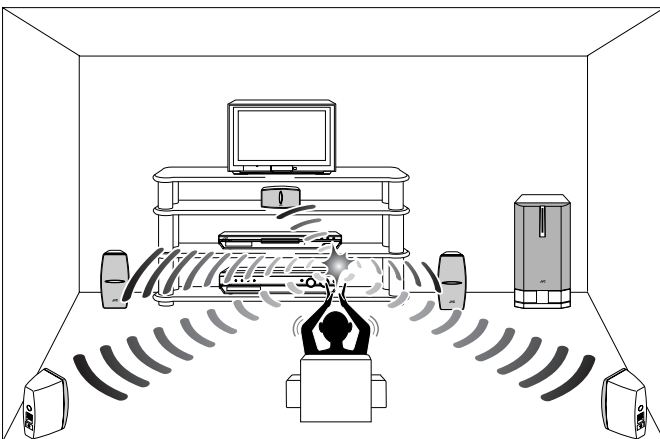

2 Press and hold SMART S. SETUP.

“SETTING UP” flashes on the display.



3 Confirm “SETTING UP” stops flashing and clap your hands over your head once while “SETTING UP” appears on the display.

The receiver starts detecting the level of the sound coming through all speakers (except the subwoofer). After detecting the sound, one of the following indications appears on the display.

- SUCCESSFUL:** Sound of your clapping is successfully detected. The receiver sets the delay time and the output level of the center and surround speakers automatically.
- SILENT:** The receiver cannot detect sound from some speakers.
- SILENT-ALL:** The receiver cannot detect any sound from all speakers.
- FAILED:** The receiver cannot detect both right and left channels for the front and/or surround speakers correctly.

- When the receiver cannot detect the sound correctly (“SILENT,” “SILENT-ALL” or “FAILED” appears on the display), “SETTING UP” appears on the display again then repeat step **3**.
- The speaker delay time and output levels are set automatically when:
 - the receiver detects the sound as “SILENT” twice in succession.
 - the receiver detects the sound as “SILENT” at the third time after detecting “SILENT,” “SILENT-ALL” and/or “FAILED” twice.
- When the receiver detects the sound as “SILENT-ALL” or “FAILED” three times, “MANUAL” appears on the display. Set the speaker and subwoofer information using Quick Setup (see page 17) or Manual Setup (see page 18), and the speakers’ output levels for the center and surround speakers (see pages 29 to 31).

To cancel Smart Surround Setup, press SMART S. SETUP while “SETTING UP” flashes on the display.

- Any other operations cannot be done after “SETTING UP” stops flashing. Complete the Smart Surround Setup.

NOTES

- You need to set the subwoofer information and output level manually (see pages 18 and 22).
- When you use Smart Surround Setup, the speaker delay time and output levels you have set before will be ineffective.
- Set the speakers information using Quick Setup (see page 17) or Manual Setup (see page 18), and the speakers’ output levels for the center and surround speakers (see pages 29 to 31) when:
 - you like to change the speaker setting made by Smart Surround Setup
 - Smart Surround Setup is not done correctly due to some factors such as the environment, speaker types and clapping strength.
- Smart Surround Setup will not be done correctly if your body or other object blocks the sound.
- Do not clap your hands hard because it may hurt your hands.

Setting the speakers and subwoofer information quickly—Quick Setup

Entering the use of the subwoofer, the number of the speakers, and your room size, the center and surround speakers' delay time is automatically calculated.

- When you change your speakers, register the information about the speakers again.
- You can also set the crossover frequency, the low frequency effect attenuator and the dynamic range compression manually (see page 19).

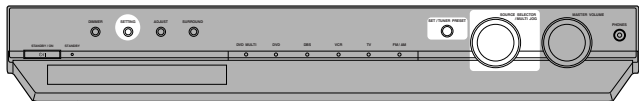

On the front panel ONLY:

Before you start, remember...

There is a time limit in doing the following steps. If the setting is canceled before you finish, start from step 1 again.

1 Press SETTING.

MULTI JOG now works for the setting operation.

2 Turn MULTI JOG until "QUICK SETUP" appears on the display.

- As you turn MULTI JOG, the indication changes as follows:

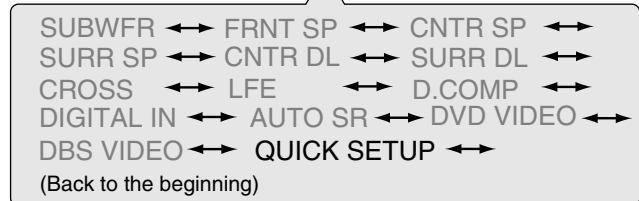

3 Press SET.

- "ENTER THE NUMBER OF SPEAKERS" scrolls on the display.
- Once you have selected "QUICK SETUP," previously adjusted speaker setting is cleared.

4 Turn MULTI JOG to select the number of the speakers you have connected.

- As you turn MULTI JOG, the indication changes as follows:



- 5 SPEAKERS*:** Select when the front, center and surround speakers are connected.
- 4 SPEAKERS:** Select when the front and surround speakers are connected.
- 3 SPEAKERS:** Select when the front and center speakers are connected.

* Initial setting

Each speaker size is registered appropriately according to the number of the connected speakers. For details, see the list "Speaker size according to the number of speakers" on the right.

5 Press SET.

"ENTER USE OF SUBWOOFER" scrolls on the display.

6 Turn MULTI JOG to select whether or not you have connected a subwoofer.

- As you turn MULTI JOG, the indication changes as follows:

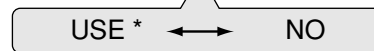

* Initial setting

7 Press SET.

"ENTER ROOM SIZE" scrolls on the display.

8 Turn MULTI JOG to select the room size.

- As you turn MULTI JOG, the indication changes as follows:



* Initial setting

The center and surround speakers' delay time is registered appropriately according to the room size. For details, see the list "Speaker delay time according to room size" below.

9 Press SET to finish the setting.

"SETUP END" appears for a while, then the indication of the previously selected source appears on the display.

NOTES

- The setting you have made is not registered until "SETUP END" appears on the display.
- Performing any operation other than volume and dimmer adjustment cancels Quick Setup process.
- When you want to change the speaker and subwoofer information after Quick Setup, use Manual Setup (see page 18).

Speaker size according to the number of speakers

Number of speakers	Subwoofer	Front	Center	Surround
3	NO	LRG (large)	SML (small)	NO
3	USE (YES)	SML (small)	SML (small)	NO
4	NO	LRG (large)	NO	SML (small)
4	USE (YES)	SML (small)	NO	SML (small)
5	NO	LRG (large)	SML (small)	SML (small)
5	USE (YES)	SML (small)	SML (small)	SML (small)

Speaker delay time according to room size

When selecting "SMALL ROOM,"

- Center speaker delay time is set to 1 msec.
- Surround speakers delay time is set to 3 msec.

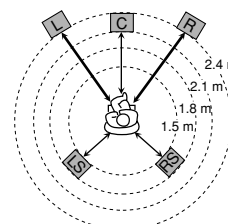

Speaker settings

When selecting "MEDIUM ROOM,"

- Center speaker delay time is set to 1 msec.
- Surround speakers delay time is set to 2 msec.

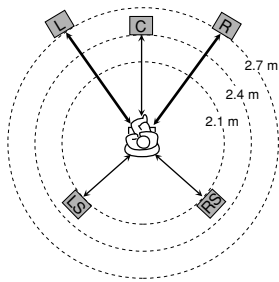

When selecting "LARGE ROOM,"

- Center speaker delay time is set to 0 msec.
- Surround speakers delay time is set to 0 msec.

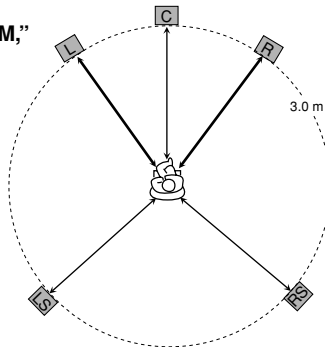

Setting the speakers and subwoofer information manually—Manual Setup

You can set the following speakers and subwoofer information manually as you prefer. When you change your speakers, register the information again.

- Subwoofer information—SUBWFR
- Speaker size—FRNT SP, CNTR SP, SURR SP
- Speaker delay time—CNTR DL, SURR DL
- Crossover frequency—CROSS
- Low frequency effect attenuator—LFE
- Dynamic range compression—D.COMP

Operating procedure

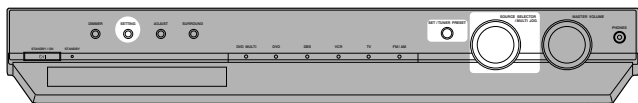

On the front panel ONLY:

Before you start, remember...

There is a time limit in doing the following steps. If the setting is canceled before you finish, start from step 1 again.

1 Press SETTING.

MULTI JOG now works for the setting operation.

2 Turn MULTI JOG until the setting item you want to set appears on the display, then press SET.

- As you turn MULTI JOG, the indication changes as follows:



SUBWFR ↔ FRNT SP ↔ CNTR SP ↔
 SURR SP ↔ CNTR DL ↔ SURR DL ↔
 CROSS ↔ LFE ↔ D.COMP ↔
 DIGITAL IN ↔ AUTO SR ↔ DVD VIDEO ↔
 DBS VIDEO ↔ QUICK SETUP ↔
 (Back to the beginning)

3 Turn MULTI JOG to select the appropriate setting for the item selected in step 2, then press SET.

Your setting is stored.



EX.: When selecting "NO" for "SUBWFR."

4 If you would like to set other items, repeat steps 2 and 3.

Setting the subwoofer information —SUBWFR (subwoofer)

Register whether you have connected a subwoofer or not.

- YES*:** Select when you have connected a subwoofer. The subwoofer speaker indicator (**SUBWFR**) lights up on the display (see page 15). You can adjust the subwoofer output level (see page 22).
- NO:** Select when you have not connected or have disconnected a subwoofer.

* Initial setting

Setting the speakers size

—FRNT SP (front speakers), CNTR SP (center speaker), SURR SP (surround speakers)

Register the sizes of all the connected speakers.

- LRG (large):** Select when the cone speaker size is larger than 12 cm.
- SML (small)*:** Select when the cone speaker size is smaller than 12 cm.
- NO:** Select when you have not connected a speaker. (Not selectable for the front speakers.)

* Initial setting

NOTES

- If you have selected "SML (small)" for the front speaker size, you cannot select "LRG (large)" for the center and surround speaker sizes.
- If you have selected "NO" for the subwoofer setting (see above and page 17), you can only select "LRG (large)" for the front speaker size.

Setting the speaker delay time

— CNTR DL (center speaker delay),
SURR DL (surround speakers delay)

You can set the speaker delay time easily by using Smart Surround Setup (see page 16) or Quick Setup (see page 17).

The distance from your listening point to the speakers is one of the important elements to obtain the best possible surround sound for the Surround modes.

You need to set the delay time of the center and surround speakers relative to the front speakers so that sounds through all the speakers can reach you at the same time.

- 1 msec increase (or decrease) in delay time corresponds to 30 cm increase (or decrease) in distance.

CNTR DL*:	Set the delay time for the center speaker within a range of 0 msec to 5 msec (in 1 msec intervals).
SURR DL*:	Set the delay time for the surround speakers within a range of 0 msec to 15 msec (in 1 msec intervals).

* "0ms" is the initial setting.

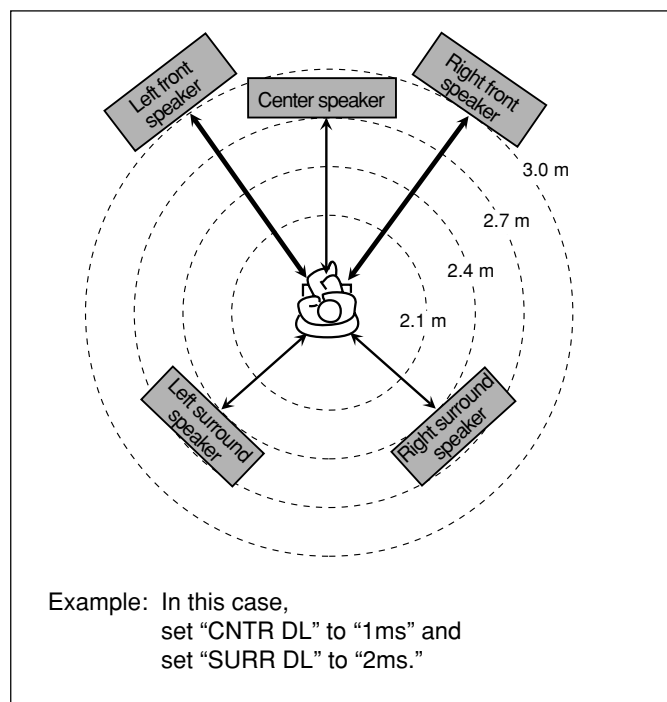

NOTE

If the center and/or surround speakers are not connected (see pages 17 and 18), you cannot set the speaker delay time for the center and/or surround speakers.

Setting the crossover frequency—CROSS

Small speakers cannot reproduce the bass sounds efficiently. If you use a small speaker in any position, this receiver automatically reallocates the bass sound elements assigned to the small speaker to the large speakers.

To use this function properly, set this crossover frequency level according to the size of the small speaker connected.

- If you have selected "LRG (large)" for all speakers (see page 18), this function will not take effect.

80HZ:	Select when the cone speaker unit built in the speaker is about 12 cm.
100HZ:	Select when the cone speaker unit built in the speaker is about 10 cm.
120HZ:	Select when the cone speaker unit built in the speaker is about 8 cm.
150HZ*:	Select when the cone speaker unit built in the speaker is about 6 cm.
200HZ:	Select when the cone speaker unit built in the speaker is less than 5 cm.

* Initial setting

NOTE

Crossover frequency is not valid for the HEADPHONE mode.

Setting the low frequency effect attenuator—LFE

If the bass sound is distorted while playing back software encoded with **Dolby Digital** or **DTS**, set the LFE level to eliminate distortion.

- This function takes effect only when the LFE signals come in.

0dB*:	Normally select this.
-10dB:	Select when the bass sound is distorted.

* Initial setting

Setting the dynamic range compression—D.COMP

You can compress the dynamic range (difference between maximum sound and minimum sound) of the reproduced sound. This is useful when listening to surround sound at night.

- This function takes effect only when playing back a source encoded with **Dolby Digital**.

OFF:	Select when you want to enjoy surround with its full dynamic range. (No effect applied.)
MID*:	Select when you want to reduce the dynamic range a little.
MAX:	Select when you want to apply the compression effect fully. (Useful at night.)

* Initial setting

RX-ES1SL

Basic settings

Operating procedure

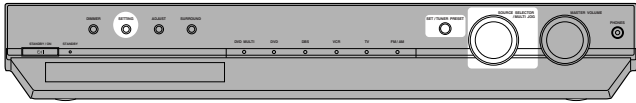

On the front panel ONLY:

Before you start, remember...

There is a time limit in doing the following steps. If the setting is canceled before you finish, start from step **1** again.

1 Press SETTING.

MULTI JOG now works for the setting operation.

2 Turn MULTI JOG until the setting item you want to set appears on the display, then press SET.

• As you turn MULTI JOG, the indication changes as follows:

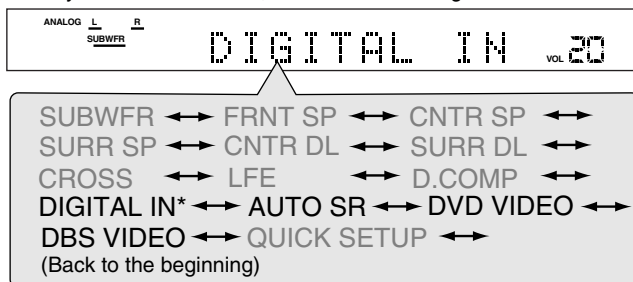

* Setting item you can select appears on the display after "DIGITAL IN" appears for a few seconds.

3 Turn MULTI JOG to select the appropriate setting for the item selected in step 2, then press SET.

Your setting is stored.



Ex.: When selecting "1DVD2DBS3TV" for "DIGITAL IN".

Setting the digital input (DIGITAL IN) terminals—DIGITAL IN

When you use the digital input terminals, register what components are connected to which terminals—DIGITAL 1/2/3 (see pages 8 and 12) so that the correct source name will appear when you select the digital source.

1DVD2DBS3TV* : Select when connecting the following components;
DIGITAL 1: DVD player
DIGITAL 2: DBS tuner
DIGITAL 3: TV tuner

1DVD2TV3DBS : Select when connecting the following components;
DIGITAL 1: DVD player
DIGITAL 2: TV tuner
DIGITAL 3: DBS tuner

1DBS2DVD3TV : Select when connecting the following components;
DIGITAL 1: DBS tuner
DIGITAL 2: DVD player
DIGITAL 3: TV tuner

1DBS2TV3DVD : Select when connecting the following components;
DIGITAL 1: DBS tuner
DIGITAL 2: TV tuner
DIGITAL 3: DVD player

1TV2DVD3DBS : Select when connecting the following components;
DIGITAL 1: TV tuner
DIGITAL 2: DVD player
DIGITAL 3: DBS tuner

1TV2DBS3DVD : Select when connecting the following components;
DIGITAL 1: TV tuner
DIGITAL 2: DBS tuner
DIGITAL 3: DVD player

* Initial setting

Setting Auto Surround—AUTO SR

You can enjoy Surround mode simply by selecting the source (with digital input selected for that source).

Select "ON" when activating Auto Surround.

- ON:**
- If multi-channel signal comes in, an appropriate Surround mode will be turned on.
 - If Dolby Digital 2 channel or DTS 2 channel signal including surround signal comes in, "PLII MOVIE" will be selected.
 - If Dolby Digital 2 channel or DTS 2 channel signal not including surround signal comes in, "STEREO" will be selected.
 - If Linear PCM signal comes in, nothing will change.

The AUTO SR indicator lights up on the display.

OFF*: Select this to deactivate Auto Surround.

* Initial setting

NOTES

- This function does not take effect in the following cases:
 - While playing an analog source, and
 - While selecting "DGTL D.D." or "DGTL DTS" as the fixed digital decode mode (see page 14).
- If Surround mode is automatically activated by Auto Surround, any other Surround mode in use will be canceled temporarily. When the multi-channel digital signal stops coming in, "PLII MOVIE" activates.
- If you press SURROUND with Auto Surround activated, Auto Surround will be canceled temporarily for the currently selected source. Auto Surround setting will be restored in the following cases:
 - When you turn the receiver off and on,
 - When you change the source,
 - When you change the analog/digital input, and
 - When you reset "AUTO SR" to "ON" again.

Setting the video component input mode—DVD VIDEO/DBS VIDEO

When you use the component video inputs for the DVD player and/or DBS tuner, you have to register the type of input terminals.

Without setting this correctly, you cannot view the correct input on the TV.

S/C*: Select when connecting the video component to the composite video or S-video input terminals.

COMP.: Select when connecting the video component to the component video input terminals.

* Initial setting

RX-ES1SL

Sound adjustments

When operating the receiver using the remote control, always set the mode selector to AUDIO/TV/VCR/DBS.



Operating procedure

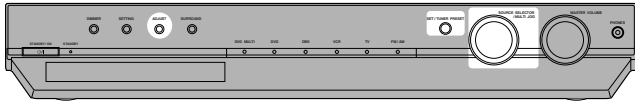

On the front panel:

Before you start, remember...

There is a time limit in doing the following steps. If the setting is canceled before you finish, start from step 1 again.

1 Press ADJUST.

MULTI JOG now works for the sound adjustment.

2 Turn MULTI JOG until the setting item you want to set appears on the display, then press SET.

- As you turn MULTI JOG, the indication changes as follows:



BASS	↔	TREBLE	↔	SUBWFR	↔
CENTER	↔	SURR L	↔	SURR R	↔
EFFECT	↔	PANORAMA	↔	BAL	↔
B.BOOST	↔	ATT	↔	(Back to the beginning)	

3 Turn MULTI JOG to adjust the item selected in step 2, then press SET.

Your setting is stored.



Ex.: When selecting "+10 (dB)" for "BASS".

Adjusting the tone—BASS, TREBLE

You can adjust the bass and treble sounds to your preference.

- You have to make these adjustments for each source.

BASS*: To adjust the bass (from -10 dB to +10 dB).

TREBLE*: To adjust the treble (from -10 dB to +10 dB).

* "0" is the initial setting.

When using the remote control:

1 Press TONE.

2 Press BASS \oplus/\ominus or TREBLE \oplus/\ominus to adjust the sound level (from -10 dB to +10 dB).

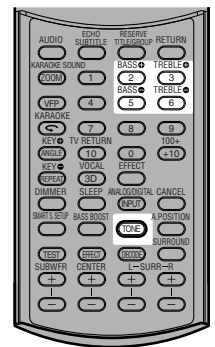

NOTE

When you use the 10 keys to operate your target source after tone adjustments, press the corresponding source selecting button first so that the 10 keys work for your target source.

Adjusting the subwoofer output level—SUBWFR

You can adjust the subwoofer output level if you have connected a subwoofer and set the subwoofer information correctly—"USE" for the Quick Setup or "YES" for the Manual Setup (see pages 17 and 18).

- You have to make this adjustment for each source.

SUBWFR*: To adjust the subwoofer output level (from -10 dB to +10 dB).

* "0" is the initial setting.

When using the remote control:

Press SUBWFR +/- to adjust the subwoofer output level (from -10 dB to +10 dB).



Setting the subwoofer audio position

When a stereo source is played back, the subwoofer sound is reinforced compared to the sound from a multi-channel source. Once you have set the subwoofer audio position, the subwoofer output level is decreased by the selected value when a stereo source is played back. The A (audio).POSITION indicator lights up when this function is activated.

- You have to make this adjustment for each source.

From the remote control ONLY:

Press **A.POSITION** repeatedly to select the subwoofer audio position level from “-2 (dB),” “-4 (dB),” and “-6 (dB).”

The smaller the number becomes, the more the level decreases automatically when listening in stereo.

- If no adjustment is required, select “OFF” (initial setting).

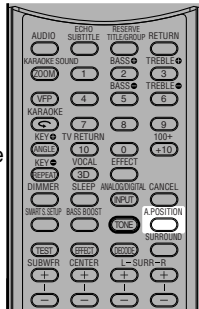

NOTES

- The maximum subwoofer output level is -10 dB.
Ex.:
When setting the subwoofer output level to “-8 (dB)” and the subwoofer audio position to “-4 (dB),” the subwoofer output level when listening in stereo will be -10 dB.
- This function does not take effect when activating a Surround mode.

Adjusting the front speakers output balance—BAL

If the sounds you hear from the front right and left speakers are unequal, you can adjust the speakers output balance.

- You have to make this adjustment for each source.
- You cannot use the remote control for this setting.

BAL*: To adjust the front speakers balance.

- “CENTER” to “L-21”: Decrease the left channel output.
- “CENTER” to “R-21”: Decrease the right channel output.

* “CENTER” is the initial setting.

Reinforcing the bass—B.BOOST

You can boost the bass level—Bass Boost.

- You have to make these adjustments for each source.

ON: Select to boost the bass level (Bass Boost).
The BASS BOOST indicator lights up on the display.

OFF*: Select to deactivate Bass Boost.

* Initial setting

NOTE

This function affects the sound coming out only through the front speakers.

When using the remote control:

Press **BASS BOOST**.

- Each time you press the button, Bass Boost turns on and off alternately.

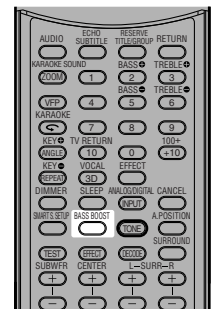

Attenuating the input signal—ATT

When the input level of **analog source** is too high, the sound will be distorted. If this happens, you need to attenuate the input signal level to prevent the sound distortion.

- You have to make this adjustment for each analog source.
- You cannot use the remote control for this setting.

ON: Select to attenuate the input signal level.
The INPUT ATT indicator lights up on the display.

NORMAL*: Select to deactivate attenuation.

* Initial setting

RX-ES1SL

Tuner operations

The buttons on the remote control are mainly used for tuner operations. To use buttons on the remote control, press **FM/AM** before operation.

When operating this receiver using the remote control, always set the mode selector to **AUDIO/TV/VCR/DBS**.

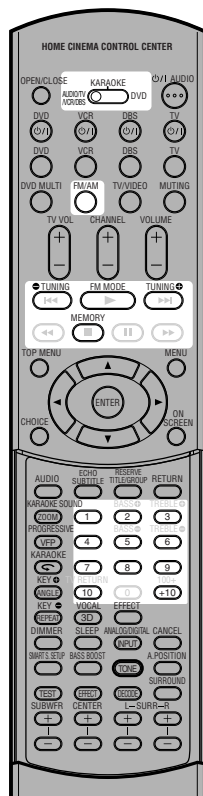

Tuning in to stations manually

From the remote control ONLY:

1 Press FM/AM to select the band.

The last received station of the selected band is tuned in.

- Each time you press the button, the band alternates between FM and AM.



You can also select "FM" or "AM" by turning SOURCE SELECTOR on the front panel.

2 Press repeatedly or hold TUNING \oplus or TUNING \ominus until you find the frequency you want.

If you select "FM" or "AM" using SOURCE SELECTOR on the front panel, press FM/AM on the remote control before this operation.

- Pressing (or holding) TUNING \oplus increases the frequency.
- Pressing (or holding) TUNING \ominus decreases the frequency.

NOTES

- When you hold and release TUNING \oplus or TUNING \ominus , the frequency keeps changing until a station is tuned in.
- When a station of sufficient signal strength is tuned in, the TUNED indicator lights up on the display.
- When an FM stereo program is received, the ST (Stereo) indicator also lights up.

Using preset tuning

Once a station is assigned to a channel number, the station can be quickly tuned. You can preset up to 30 FM and 15 AM stations.

To store the preset stations

Before you start, remember...

There is a time limit in doing the following steps. If the setting is canceled before you finish, start from step 2 again.

From the remote control ONLY:

1 Tune in to the station you want to preset (see "Tuning in to stations manually" above).

- If you want to store the FM reception mode for this station, select the FM reception mode you want. See "Selecting the FM reception mode" on page 25.



2 Press MEMORY.

The channel number position starts flashing on the display for about 5 seconds.



3 Press the numeric buttons (1 – 10, +10) to select a channel number while the channel number position is flashing.

- For channel number 5, press 5.
- For channel number 15, press +10, then 5.
- For channel number 30, press +10, +10, then 10.



4 Press MEMORY again while the selected channel number is flashing on the display.

- The station is assigned to the selected channel number.
- The selected channel number stops flashing.



5 Repeat steps 1 to 4 until you store all the stations you want.

To erase a stored preset station

Storing a new station on a used channel number erases the previously stored one.

To tune in a preset station

From the remote control:

1 Press FM/AM to select the band.

The last received station of the selected band is tuned in and the numeric buttons now work for tuner operations.

- Each time you press the button, the band alternates between FM and AM.



2 Press the numeric buttons (1 – 10, +10) to select a channel number.

If you select "FM" or "AM" using SOURCE SELECTOR on the front panel, press FM/AM on the remote control before this operation.

- For channel number 5, press 5.
- For channel number 15, press +10, then 5.
- For channel number 30, press +10, +10, then 10.



On the front panel:

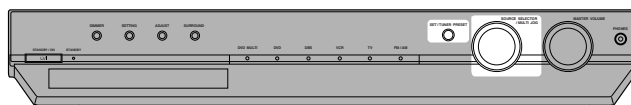

Before you start, remember...

There is a time limit in doing the following steps. If the setting is canceled before you finish, start from step 2 again.

1 Turn SOURCE SELECTOR to select "FM" or "AM."

The last received station of the selected band is tuned in.

2 Press TUNER PRESET.

"P" appears on the display and MULTI JOG now works for selecting preset channels.

3 Turn MULTI JOG to select a preset channel number during "P" appears on the display.

- Turning MULTI JOG clockwise increases the preset channel numbers.
- Turning MULTI JOG counterclockwise decreases the preset channel numbers.



Selecting the FM reception mode

When an FM stereo broadcast is hard to receive or noisy, you can change the FM reception mode while receiving an FM broadcast.

- You can store the FM reception mode for each preset station (see page 24).

From the remote control ONLY:

While listening to an FM station, press FM MODE.

If you select "FM" using SOURCE SELECTOR on the front panel, press FM/AM on the remote control before this operation.

- Each time you press the button, the FM reception mode alternates between "AUTO MUTING" and "MONO."

AUTO MUTING*:

Normally select this.

When a program is broadcast in stereo, you will hear stereo sound; when in monaural, you will hear monaural sound. This mode is also useful to suppress static noise between stations. The AUTO MUTING indicator lights up on the display.

MONO:

Select this to improve the reception (but stereo effect will be lost). In this mode, you will hear noise while tuning in to the stations. The AUTO MUTING indicator goes off from the display. (The ST indicator also goes off.)

* Initial setting

RX-ES1SL

Creating realistic sound fields

Reproducing theater ambience

In a movie theater, many speakers are located on the walls to reproduce impressive multi-surround sound, reaching you from all directions.

With these many speakers, sound localization and sound movement can be expressed.

Surround/DSP modes built in this receiver can create almost the same surround sound as you can feel in a real movie theater.

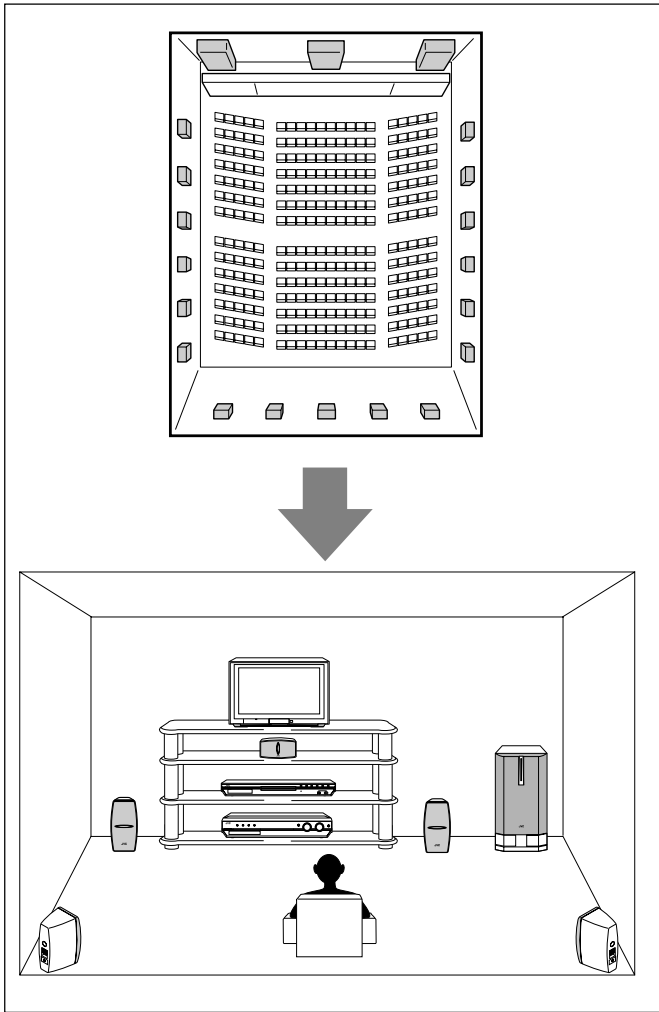

Introducing the Surround/DSP modes

You can use the following Surround/DSP modes with this receiver.

- Surround modes
 - Dolby Pro Logic II
 - Dolby Digital
 - DTS
- DSP (Digital Signal Processor) modes
 - DAP (Digital Acoustic Processor) modes
 - All Channel Stereo

■ Surround modes

Dolby Pro Logic II*

Dolby Pro Logic II has a newly developed multi-channel playback format to decode all 2 channel sources—stereo source and Dolby Surround encoded source—into 5.1 channel.

Matrix-based encoding/decoding method for Dolby Pro Logic II makes no limitation for the cutoff frequency of the surround treble and enables stereo surround sound compared to conventional Dolby Pro Logic.

Dolby Pro Logic II enables you to reproduce spacious sound from original sound without adding any new sounds and tonal colorations. Dolby Pro Logic II has two modes—**Movie mode** and **Music mode**:

Pro Logic II Movie—suitable for reproduction of Dolby Surround encoded sources bearing the mark . You can enjoy a sound field very close to the one created with discrete 5.1 channel sounds.

Pro Logic II Music—suitable for reproduction of any 2-channel stereo music sources. You can enjoy wide and deep sound by using this mode. For this mode, Panorama control can be selected, which gives “wraparound” sound effect with side-wall image.

- When Dolby Pro Logic II is activated, the  PLII indicator lights up on the display.

Dolby Digital*

Dolby Digital is a digital signal compression method, developed by Dolby Laboratories, and enables multi-channel encoding and decoding (1 channel up to 5.1 channel).

Dolby Digital 5.1 channel encoding method records and digitally compresses the left front channel, right front channel, center channel, left surround channel, right surround channel, and LFE channel signals (total 6 channels, but the LFE channel is counted as 0.1 channel. Therefore, it is called 5.1 channel).

Dolby Digital enables stereo surround sounds, and sets the cutoff frequency of the surround treble at 20 kHz, compared to 7 kHz for Dolby Pro Logic. As such, the sound movement and “being-there” feeling are enhanced much more than Dolby Pro Logic.

- To enjoy software encoded with Dolby Digital, connect the source component using the digital terminal on the rear of this receiver. (See pages 8 and 12.)

NOTE

Dolby Digital software can be roughly grouped into two categories—multi-channel (up to 5.1 channel) and 2 channel software. To enjoy surround sound while playing Dolby Digital 2 channel software, you can use Dolby Pro Logic II.

* Manufactured under license from Dolby Laboratories. “Dolby”, “Pro Logic”, and the double-D symbol are trademarks of Dolby Laboratories.

**“DTS” and “DTS Digital Surround” are registered trademarks of Digital Theater Systems, Inc.

DTS**

DTS is another digital signal compression method, developed by Digital Theater Systems, Inc., and enables multi-channel encoding and decoding.

DTS Digital Surround is another discrete 5.1 channel digital audio format available on CD, LD, and DVD software.

Compared to Dolby Digital, the DTS Digital Surround format has a lower audio compression rate, which enables it to add breadth and depth to the sounds reproduced. As such, DTS Digital Surround features natural, solid and clear sound.

- To enjoy the software encoded with DTS Digital Surround, connect the source component using the digital terminal on the rear of this receiver. (See pages 8 and 12.)

DSP (Digital Signal Processor) modes

DAP (Digital Acoustic Processor) modes

DAP modes have been designed to create important acoustic surround elements.

The sound heard in a live club, dance club, hall or pavilion consists of direct sound and indirect sound—early reflections and reflections from behind. Direct sounds reach the listener directly without any reflection. On the other hand, indirect sounds are delayed by the distances of the ceiling and walls (see the diagram below). These indirect sounds are important elements of the acoustic surround effects. The DAP mode can create these important elements, and give you a real “being there” feeling.

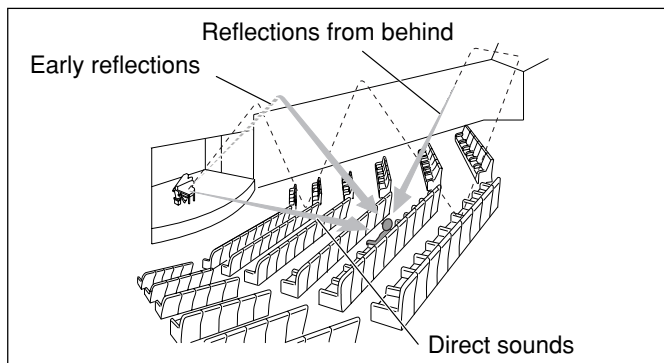

DAP modes can be used when the front and surround speakers are connected to this receiver (without respect to the center speaker connection: no sound comes out of the center speaker even if it is connected).

The following DAP modes are provided with this receiver:

LIVE CLUB:	Reproduces the spatial feeling of a live music club with a low ceiling.
DANCE CLUB:	Reproduces the spatial feeling of a rocking dance club.
HALL:	Reproduces the spatial feeling of a hall for classical recitals.
PAVILION:	Reproduces the spatial feeling of an exhibition hall.

These DAP modes can be used to add acoustic surround effects while reproducing 2 channel stereo software, either analog or Linear PCM digital signal, and can give you a real “being there” feeling.

- When one of the DAP modes is selected, the DSP indicator lights up on the display.

All Channel Stereo

This mode can reproduce a larger stereo sound field using all the connected (and activated) speakers.

All Channel Stereo can be used when the front and surround speakers are connected to this receiver without respect to the center speaker connection.

- If the center speaker is connected and activated, the same phase of the front left and right signals are mixed and output through the center speaker.

All Channel Stereo can be used while reproducing 2 channel stereo software, either analog or Linear PCM digital signal.

- When All Channel Stereo is selected, the DSP indicator lights up on the display.

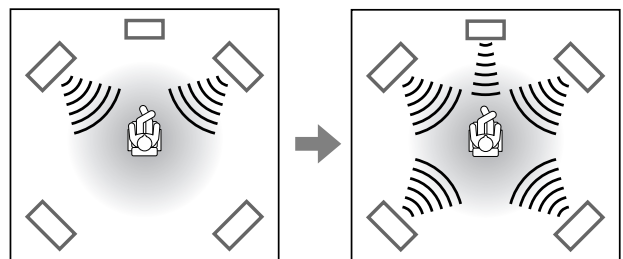

Normal stereo reproduction

Sound reproduced from All Channel Stereo

NOTE

MPEG Multichannel signals cannot be reproduced.

Available Surround/DSP modes for each input signal

○: Possible ×: Impossible

Mode Signals	STEREO	DOLBY DIGITAL	DTS SURROUND	PROLOGIC II MOVIE	PROLOGIC II MUSIC	LIVE CLUB	DANCE CLUB	HALL	PAVILION	ALL CH ST.
Dolby Digital (Multi-channel)	○	○	×	×	×	×	×	×	×	×
Dolby Digital (2-channel)	○	×	×	○	○	×	×	×	×	×
DTS Digital Surround (Multi-channel)	○	×	○	×	×	×	×	×	×	×
DTS Digital Surround (2-channel)	○	×	×	○	○	×	×	×	×	×
Linear PCM	○	×	×	○	○	○	○	○	○	○
Analog	○	×	×	○	○	○	○	○	○	○
DVD MULTI	×	×	×	×	×	×	×	×	×	×

About relations between speaker layout and Surround/DSP modes

Available Surround/DSP modes will vary depending on how many speakers are used with this receiver.

Make sure that you have set the speakers information correctly (see pages 16 to 19).

- If only front speakers are connected, you cannot use the Surround modes.
- If surround speakers are not connected, you cannot use DSP modes.

When multi-channel digital software such as Dolby Digital or DTS Digital Surround is played back, the appropriate multichannel Surround mode is automatically activated ("DOLBY D" or "DTS") by pressing SURROUND (with the digital input mode selected).

- For Dolby Digital 2 channel software, you can select "PLII MUSIC" or "PLII MOVIE" by pressing SURROUND.
- For more details, see "Available Surround/DSP modes for each input signal" on page 27.

When connecting 5 speakers and 4 speakers

Available Surround modes:
 PLII MOVIE (Pro Logic II MOVIE)
 PLII MUSIC (Pro Logic II MUSIC)

Available DSP modes:
 LIVE CLUB
 DANCE CLUB
 HALL
 PAVILION
 ALL CH ST. (All Channel Stereo)

When connecting 3 speakers

Available Surround modes:
 PLII MOVIE (Pro Logic II MOVIE)
 PLII MUSIC (Pro Logic II MUSIC)

NOTE

When "AUTO SR (Auto Surround)" is turned "ON" (see page 21), Surround mode is automatically activated when you select and start playing back a multi-channel digital source.

Using Surround modes

Once you have adjusted the Surround modes, the adjustment is memorized for each source.

- If you set the speaker information using Smart Surround Setup (see page 16), you do not have to adjust speaker output level.

When operating this receiver using the remote control, always set the mode selector to AUDIO/TV/VCR/DBS.



Before you start, remember...

Make sure that you have set the speaker information correctly (see pages 16 to 19).

From the remote control:

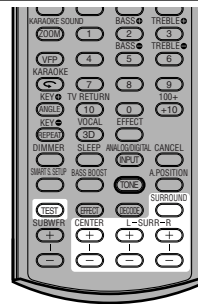

It will be convenient for you to use the remote control for the sound adjustments, since you can make adjustments from your listening point, and use the test signal.

- For selecting Panorama control for Pro Logic II Music, use the buttons on the front panel.

1 Select and play software you like.

If "AUTO SR (Auto Surround)" is set to "ON"

Playing a digital source automatically activates an appropriate Surround mode. (See page 21.) → **Go to step 3.**

2 Press SURROUND to select an appropriate Surround mode.

- Each time you press the button, the Surround/DSP modes change as follows:

When playing back multi-channel digital software such as Dolby Digital or DTS Digital Surround:



DOLBY D or DTS ↔ STEREO (Surround/DSP off)

When playing back 2 channel digital software such as Dolby Digital or DTS Digital Surround:

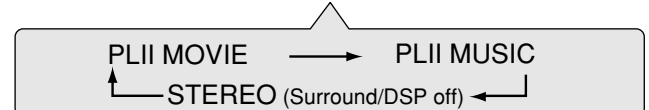

When playing back any software other than above:



3 Press TEST to check the speakers output balance.

“TEST L” starts flashing on the display, and a test tone comes out of the speakers as follows:

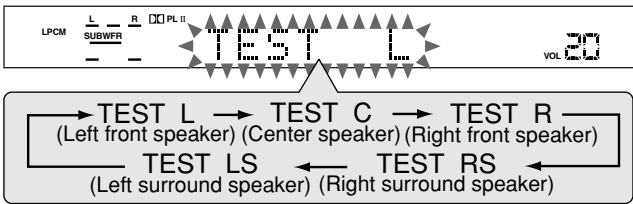

4 Adjust the following speaker output levels (from -10 dB to +10 dB).

- Make adjustments so that the sound level of the selected speaker is set at the same level as that of the front speakers.

To adjust the center speaker level, press CENTER +/-.

To adjust the left surround speaker level, press SURR L +/-.

To adjust the right surround speaker level, press SURR R +/-.

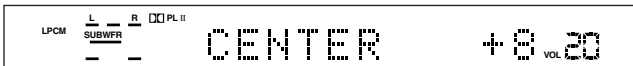

Ex.: When selecting “+8 (dB)” for “CENTER.”

5 Press TEST again to stop the test tone.

The currently selected source name appears on the display.

On the front panel:

- No test tone is available when using the buttons on the front panel.

Before you start, remember...

There is a time limit in doing the following steps. If the setting is canceled before you finish, start from step 2 again.

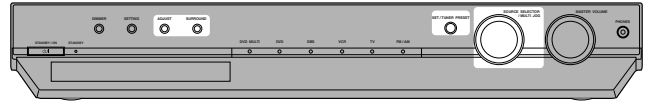

1 Select and play software you like.

If “AUTO SR (Auto Surround)” is set to “ON”
 Playing a digital source automatically activates an appropriate Surround mode. (See page 21.) → Go to step 4.

2 Press SURROUND.

MULTI JOG now works for the Surround/DSP mode selection.

3 Turn MULTI JOG to select an appropriate Surround mode.

- As you turn MULTI JOG, the indication changes as follows:

When playing back multi-channel digital software such as Dolby Digital or DTS Digital Surround:

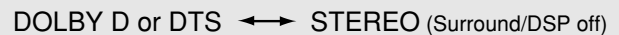

When playing back 2 channel digital software such as Dolby Digital or DTS Digital Surround:

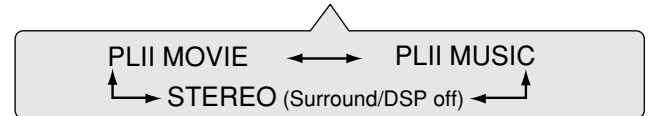

When playing back any software other than above:



4 Press ADJUST.

MULTI JOG now works for the sound adjustment.

5 Turn MULTI JOG until the setting item you want to set appears on the display, then press SET.

- As you turn MULTI JOG, the indication changes as follows:

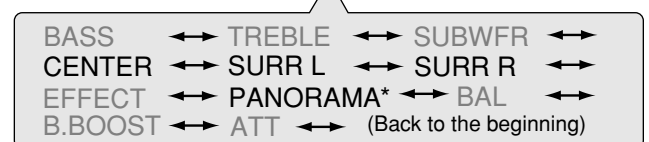

* Available only for “PLII MUSIC.”

Creating realistic sound fields

CENTER*1:	To adjust the center speaker output level (from -10 dB to +10 dB).
SURR L*1:	To adjust the left surround speaker output level (from -10 dB to +10 dB).
SURR R*1:	To adjust the right surround speaker output level (from -10 dB to +10 dB).
PANORAMA control*2:	<ul style="list-style-type: none"> • Select "ON" when you would like to enjoy "wraparound" sound effect with side-wall image. • Select "OFF" when you would like to hear originally recorded sound.

*1 "0" is the initial setting for each speaker setting.

*2 "OFF" is the initial setting.

6 Turn MULTI JOG to adjust the item selected in step 5, then press SET.

Your setting is stored.

- When adjusting the speaker output levels, make adjustments so that the sound level of the selected speaker is set at the same level as that of the front speakers.



Ex.: When selecting "+8 (dB)" for "CENTER."

7 Repeat steps 5 and 6 to adjust the other settings.

To cancel Surround mode

Press SURROUND repeatedly on the remote control or press SURROUND then turn MULTI JOG on the front panel so that "STEREO" appears on the display.

- If Surround mode is canceled while playing back multi-channel digital software, all channel signals are mixed and output through the front speakers (and subwoofer if you have connected a subwoofer and set the subwoofer setting correctly—"USE" for Quick Setup or "YES" for Manual Setup—see pages 17 and 18).

NOTES

- You can adjust the speaker output levels using the remote control without outputting the test tone.
- You cannot adjust the center speaker output level and no test tone comes out of the center speaker when "CNTR SP" is set to "NO."
- You cannot adjust the surround speaker output levels and no test tone comes out of the surround speakers when "SURR SP" is set to "NO."
- Remember not to change the speaker setting while using any Surround modes; otherwise, the Surround mode may be canceled when you deactivate the speakers required for it.
- You cannot use any Surround modes when selecting DVD MULTI as a playback source.

Using DSP modes

Once you have adjusted the DSP modes, the adjustment is memorized for each source.

- You cannot use the DSP modes if no surround speakers are connected.
- You cannot adjust the effect level for "ALL CH ST."

When operating this receiver using the remote control, always set the mode selector to AUDIO/TV/VCR/DBS.



Before you start, remember...

Make sure that you have set the speaker information correctly (see pages 16 to 19).

From the remote control:

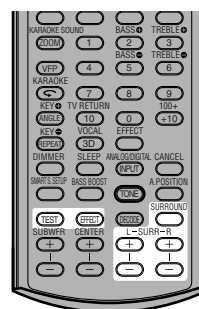

It will be convenient for you to use the remote control for the sound adjustments, since you can make adjustments from your listening point, and use the test signal.

1 Start playing 2 channel software—either Linear PCM or analog signal—and select the source.

2 Press SURROUND repeatedly until one of the DSP modes you want to apply appears on the display.

The DSP indicator lights up on the display.

- Each time you press the button, the DSP modes change as follows:



3 Press TEST to check the speakers output balance.

"TEST L" starts flashing on the display, and a test tone comes out of the speakers as follows:

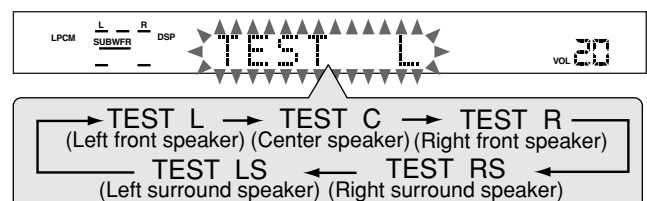

4 Adjust the surround speaker output levels (from -10 dB to +10 dB).

- Make adjustments so that the sound level of the selected speaker is set at the same level as that of the front speakers.

To adjust the left surround speaker level, press SURR L +/-.

To adjust the right surround speaker level, press SURR R +/-.



Ex.: When selecting “-8 (dB)” for “SURR R.”

5 Press TEST again to stop the test tone.

6 Only for DAP modes: Press EFFECT to select the DAP effect level (1 to 5) you want.

- As the number increases, the DAP effect becomes stronger (normally set it to “EFFECT 3”).

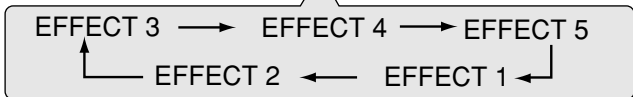

On the front panel:

- No test tone is available when using the buttons on the front panel.

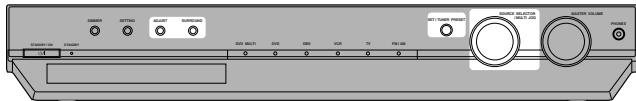

Before you start, remember...

There is a time limit in doing the following steps. If the setting is canceled before you finish, start from step 2 again.

1 Start playing 2 channel software—either Linear PCM or analog signal—and select the source.

2 Press SURROUND.

MULTI JOG now works for the Surround/DSP mode selection.

3 Turn MULTI JOG until one of the DSP modes you want to apply appears on the display.

The DSP indicator lights up on the display.

- As you turn MULTI JOG, the indication changes as follows:



4 Press ADJUST.

MULTI JOG now works for the sound adjustment.

5 Turn MULTI JOG until the setting item you want to set appears on the display, then press SET.

- As you turn MULTI JOG, the indication changes as follows:

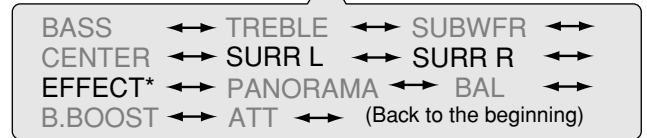

* Available only for DAP modes.

SURR L*1: To adjust the left surround speaker output level (from -10 dB to +10 dB).

SURR R*1: To adjust the right surround speaker output level (from -10 dB to +10 dB).

EFFECT (available only for DAP modes) *2: To adjust the DAP effect level. As the number increases, the effect becomes stronger (normally set it to “EFFECT 3”).

*1 “0 (dB)” is the initial setting for each speaker setting.

*2 “3” is the initial setting.

6 Turn MULTI JOG to adjust the item selected in step 5, then press SET.

Your setting is stored.

- When adjusting the speaker output levels, make adjustments so that the sound level of the selected speaker is set at the same level as that of the front speakers.



Ex.: When selecting “-8 (dB)” for “SURR R.”

7 Repeat steps 5 and 6 to adjust the other settings.

To cancel DSP Modes

Press SURROUND repeatedly on the remote control or press SURROUND then turn MULTI JOG on the front panel so that “STEREO” appears on the display. The DSP indicator goes off from the display.

NOTES

- You can adjust the speaker output levels using the remote control without outputting the test tone.
- You cannot adjust the center speaker output level and no test tone comes out of the center speaker when “CNTR SP” is set to “NO.”
- You cannot adjust the surround speaker output levels and no test tone comes out of the surround speakers when “SURR SP” is set to “NO.”

RX-ES1SL

Using the DVD MULTI playback mode

This receiver provides the DVD MULTI playback mode for reproducing the analog discrete output mode (5.1 channel reproduction) of the DVD player.

In addition, the DVD MULTI playback mode can be used for reproducing a DVD Audio sound.

Before playing back a DVD, refer also to the manual supplied with the DVD player.

- When using the DVD MULTI playback mode, connect the DVD player with its analog discrete output jacks to the DVD IN jacks on the rear panel (see page 11).
- DVD MULTI playback mode cannot be used for XV-NK58SL.

When operating this receiver using the remote control, always set the mode selector to AUDIO/TV/VCR/DBS.



Activating the DVD MULTI playback mode

On the front panel:

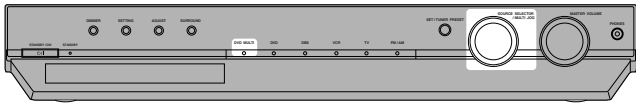

- 1 Turn SOURCE SELECTOR until "DVD MULTI" appears on the display.

The DVD MULTI indicator lights in red.

- 2 Select the analog discrete output mode on the DVD player, and start playing a DVD.

From the remote control:

- 1 Press DVD MULTI.

The DVD MULTI indicator lights in red.

- 2 Select the analog discrete output mode on the DVD player, and start playing a DVD.

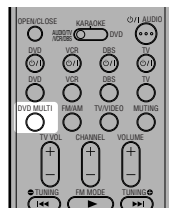

Adjusting the speaker output level

You can adjust the speaker output level while playing a DVD using the analog discrete output mode on the DVD player.

Once you have adjusted the sound, the adjustment is memorized.

- The test tone does not output through the speakers to adjust the speakers output levels when selecting DVD MULTI.

From the remote control:

It will be convenient for you to use the remote control for the sound adjustments, since you can make adjustments from your listening point.

Adjust the following speaker output levels (from -10 dB to +10 dB).

- Make adjustments so that the sound level of the selected speaker is set at the same level as that of the front speakers.

To adjust the center speaker level, press CENTER +/-.

To adjust the left surround speaker level, press SURR L +/-.

To adjust the right surround speaker level, press SURR R +/-.

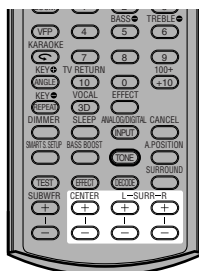

On the front panel:

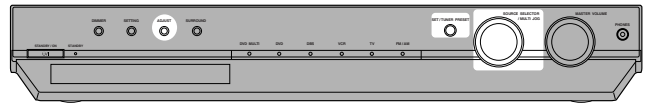

Before you start, remember...

There is a time limit in doing the following steps. If the setting is canceled before you finish, start from step 1 again.

- 1 Press ADJUST.

MULTI JOG now works for the sound adjustment.

- 2 Turn MULTI JOG until the setting item you want to set appears on the display, then press SET.

- As you turn MULTI JOG, the indication changes as follows:

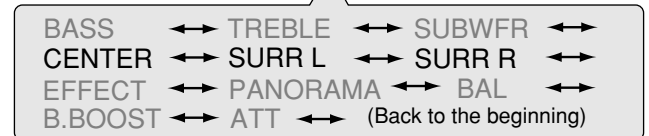

CENTER*: To adjust the center speaker output level (from -10 dB to +10 dB).

SURR L*: To adjust the left surround speaker output level (from -10 dB to +10 dB).

SURR R*: To adjust the right surround speaker output level (from -10 dB to +10 dB).

* "0 (dB)" is the initial setting.

- 3 Turn MULTI JOG to adjust the item selected in step 2, then press SET.

Your setting is stored.

- Make adjustments so that the sound level of the selected speaker is set at the same level as that of the front speakers.



Ex.: When selecting "+8 (dB)" for "CENTER."

- 4 Repeat steps 2 and 3 to adjust the other settings.

NOTES

- When you select DVD MULTI as a source to play, the selected Surround/DSP mode is canceled, and the SURROUND button does not work.
- When using a pair of headphones, the sounds of front left and right channels are output from the headphones.

XV-NK58SL

Before operation

About this manual

- The display window information and OSD (On Screen Display) menu items are put in brackets [] in the operation procedures.
- Usable disc(s) for each operation/function is (are) referred to by the icons;



About discs

Playable disc types

Discs with the following marks can be played back on the player.

DVD VIDEO 	SVCD 	Video CD 	Audio CD
---------------	----------	--------------	--------------

The DVD Logo is a trademark.

The player can also play back the following discs:

- DVD-R and DVD-RW discs written in the DVD VIDEO format and finalized
- CD-R and CD-RW discs written in the SVCD, Video CD or Audio CD format and finalized
- CD-R and CD-RW discs written in MP3 or WMA in accordance with the "ISO 9660" format (See page 47 for details.)
- CD-R and CD-RW discs written in JPEG in accordance with the "ISO 9660" format (See page 49 for details.)

NOTE

If a disc gets dirty, scratched or warped, or due to the disc characteristics or recording conditions, it may take considerable time for the player to read the content, or the player may not be able to play back such discs.

The player can play back audio signals recorded in MIX-MODE CD, CD-G, CD-EXTRA and CD TEXT.

Region code of DVD VIDEO

DVD VIDEO players and DVD VIDEO discs have their own Region Code numbers. This player can play back DVD VIDEO discs whose Region Code numbers include the player's Region Code, which is indicated on the region code symbol on the rear panel.

Example of playable DVD discs when the player's Region Code is "4":



Color system format

This player is compatible with the PAL and NTSC systems. You can select "PAL" or "NTSC" while using the PAL/NTSC selector on the rear panel (for details, see page 9).

Unplayable discs

The player does not play back discs listed below. If you try to play back these discs, noise may generate causing damage to speakers.

- DVD-RW discs written in the VR format
- DVD-ROM, DVD-RAM, DVD AUDIO, CD-ROM, PHOTO CD, SACD

In addition, the player does not play:

- Unfinalized discs

- Discs of irregular shape or discs with tape, seals or paste on either the label side or playback side. Playing back these discs may damage the player.

Digital audio formats

The player supports the following digital audio formats (see page 64 "Appendix D: Glossary" for descriptions of each audio format):

Linear PCM, Dolby Digital, MPEG Multichannel, DTS (Digital Theater Systems)

NOTE

Depending on the player's [DIGITAL AUDIO OUTPUT] setting, digital audio signals may not be output as they are recorded on the disc. See "DIGITAL AUDIO OUTPUT" on page 59 for details.

Notes on discs

- With some DVD VIDEO discs, the player starts playback automatically after inserting the disc.
- The image may be sometimes poor or noisy due to defects in the disc itself.
- With some discs, operations described in this manual may not be possible.

Care and handling of discs

If a disc gets dirty, dusty, scratched or warped, playback sound and picture may be deteriorated. Take proper precautions when handling discs.

Handling

- Do not touch the surface of the disc.
- Do not damage, stick paper to, or use any adhesive on either the label side or playback side.

Storing discs

- Keep discs in their cases. If discs are piled on top of one another without their protective cases, they can be damaged.
- Do not put discs in a location where they may be exposed to direct sunlight, or where the humidity or temperature is high. Avoid leaving discs in a car!

Cleaning discs

- Wipe with a soft dry cloth, moving from the center outwards. If a disc is difficult to clean, wipe with a cloth moistened with water.

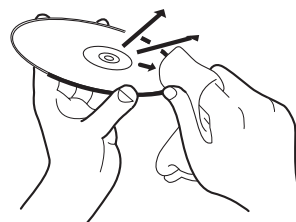

- Never use record cleaners, petrol, alcohol or any anti-static agents.

Notes on copyright

Check the copyright laws in your country before recording from DVD VIDEO, SVCD, Video CD, Audio CD, MP3, WMA and JPEG discs.

Recording of copyrighted material may infringe copyright laws.

This product incorporates copyright protection technology that is protected by method claims of certain U.S. patents and other intellectual property rights owned by Macrovision Corporation and other rights owners. Use of this copyright protection technology must be authorized by Macrovision Corporation, and is intended for home and other limited viewing uses only unless otherwise authorized by Macrovision Corporation. Reverse engineering or disassembly is prohibited.

XV-NK58SL

Basic operations

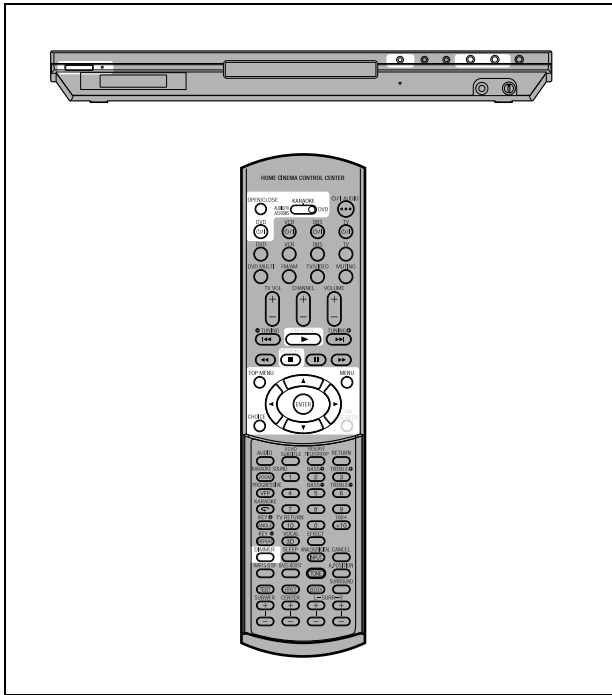



NOTE





When operating the player, set the mode selector to "DVD."

About invalid operation icon

When you press a button, and if the player does not accept its operation,  appears on your TV screen. Operations are occasionally unacceptable even if  is not displayed. Note that some operations may not be accepted. For example, some discs may not allow rapid advance/reverse or slow-motion playback.

Turning on/off the player

Press DVD  on the remote control unit or press  on the front panel.

The STANDBY/ON indicator on the front panel, which lights in red during standby, lights in green.

The left and right sides of the display window are illuminated.

The opening display appears on the TV screen, and the following messages may appear at the bottom of the opening display.



Message area

- NOW READING (The player is reading the disc information.)
- REGION CODE ERROR! (The region code of the DVD VIDEO disc does not match the player. The disc cannot be played back.)
- OPEN
- CLOSE
- NO DISC

NOTE

Even if you turn off the player, the player is not disconnected from the AC power source as long as it is connected to the wall outlet. This state is called standby mode. In this state, the player consumes a very small amount of power.

Initial setup

When you turn on the player for the first time after purchase, the following message appears on the TV screen.

EXECUTE DVD PLAYER SETUP? - BASIC PICTURE/AUDIO SETTING
YES - PRESS ENTER NO - CANCEL

You can set the display language, TV monitor type and digital output before using the player, by following the procedure below.

1 Press ENTER.

The first page of the DVD PLAYER SET UP display appears. The pull-down menu of the [ON SCREEN LANGUAGE] is already open.

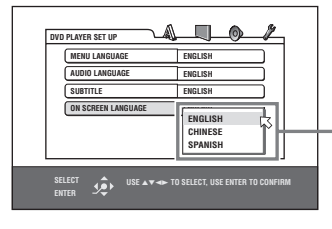

ON SCREEN LANGUAGE options

2 Press ▲/▼ to select the desired language.

You can select the on-screen language for the preference displays, etc. from among ENGLISH, CHINESE and SPANISH.

3 Press ENTER.

The second page is shown, in which the pull-down menu of the [MONITOR TYPE] is already open.

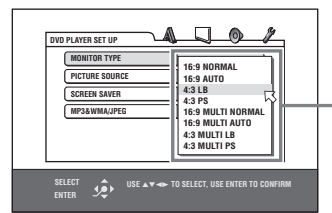

MONITOR TYPE options

4 Press ▲/▼ to select the desired monitor type.

For a normal (conventional) TV, select [4:3 LB] or [4:3 PS]. For a wide-screen TV, select [16:9 NORMAL] or [16:9 AUTO]. (See page 58.)

5 Press ENTER.

The third page is shown, in which the pull-down menu of the [DIGITAL AUDIO OUTPUT] is already open.

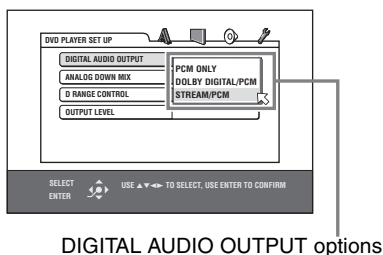

6 Press ▲/▼ to select a desired digital output signal type.

Set this item correctly when you connect the player to an external surround decoder or D/A converter. (If you do not connect the player to such a device, you do not have to set this item.)

- When connecting to a Dolby Digital decoder, select [DOLBY DIGITAL/PCM].
- When connecting to a DTS decoder, select [STREAM/PCM].
- When connecting to other digital device, select [PCM ONLY].

7 Press ENTER.

The TV screen returns to the opening display.

To bring up the DVD PLAYER SET UP display later

Press CHOICE for a few seconds until the DVD PLAYER SET UP display appears.

To change the brightness of the display window

Press DIMMER on the remote control unit. You can select the display window brightness from three levels, or off. If the brightness is set to off, nothing will be shown on the display.

Basic playback



1 Press ▲ (or OPEN/CLOSE on the remote control unit) to open the disc tray.

2 Place a disc in the disc tray.

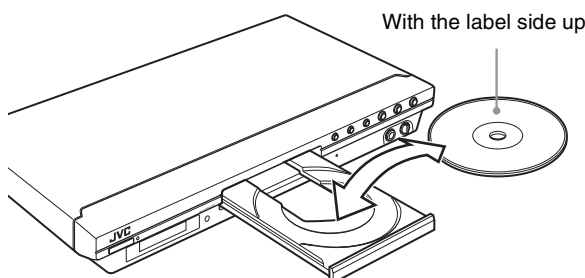

- To insert an 8-cm disc, place it in the inner recess.

3 Press ►.

The player starts playback from the beginning.

If a menu is shown on the TV screen

When inserting a DVD VIDEO, SVCD or Video CD disc, a menu may be shown on the TV screen. From the menu, you can select a desired item to be played back.

For DVD VIDEO

- 1 Press ▲/▼/◀/▶ to select a desired item.
- 2 Press ENTER.

The player starts playback of the selected item.

For SVCD/Video CD

Press the numeric buttons to select a desired item. The player starts playback of the selected item.

NOTES

- Do not insert an unplayable disc. (See page 33.)
- When inserting a disc on the disc tray, be sure to position the disc inside the recess. Otherwise, the disc may be damaged when the disc tray is closed, or you may not be able to remove the disc from the player.

About PBC (Playback Control)

Some SVCD/Video CD discs support the PBC function. The PBC function allows you to enjoy menu-driven operation and high-resolution still images which have a resolution four times greater than moving pictures.

- To play a PBC-compatible SVCD/Video CD disc without activating the PBC function, press the numeric buttons instead of ► to start playback.
- To activate the PBC function again,
 - 1) press TOP MENU or MENU,
 - or
 - 2) press ■ to stop playback, then press ►.

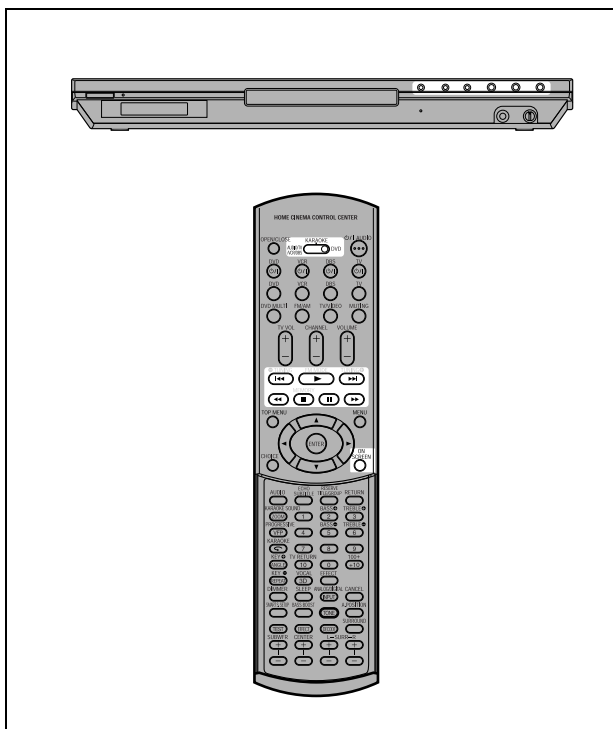

To check the playback status

You can see the current selection number (the title/chapter number for DVD VIDEO or track number for SVCD/Video CD/Audio CD), time information (the track or chapter time while stopped, or elapsed track or chapter time during playback) and the transport status (stop, playback, pause, etc.) on the TV screen.

Press ON SCREEN.

Example: for DVD VIDEO

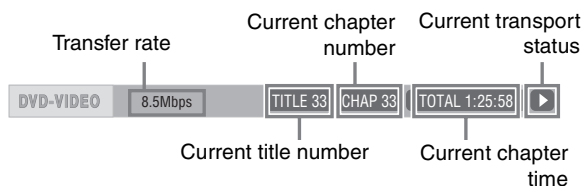

Note that pressing ON SCREEN again brings up the menu bar under the status bar, from which you can access various functions. See page 45 for details about the menu bar.

To turn off the status bar

Press ON SCREEN repeatedly until the status bar goes off.

To stop playback completely

Press ■.

Hint

If you press ▲ during playback, the player stops playback and opens the disc tray.

To stop playback temporarily

Press II.

To resume playback, press ►. (See the following item.)

NOTE

When playback is stopped temporarily while the KARAOKE function is turned on, the input signal from the MIC jack is not output.

About On-screen guide icons

You may see the following icons displayed over the picture. They have the following meanings.

- : Appears at the beginning of a scene recorded from multiple angles (see page 43).
- : Appears at the beginning of a scene recorded with multiple audio languages (see page 43).
- : Appears at the beginning of a scene recorded with multiple subtitle languages (see page 43).

Resuming playback



The player can memorize the position on a disc where you interrupt playback, and resume playback from that position later. There are three resume modes; ON, OFF and DISC RESUME. The mode is initially set to ON when you purchased the player.

- You can select the mode using the preference display (see page 59).

When the resume mode is “ON”

When you press ■, the player stops playback and memorizes the interrupted position. The TV screen shows [RESUME STOP] and the [RESUME] indicator lights up in the display window. The memory of the interrupted position is not cleared if you turn off the player.

When you turn off the player after setting the resume function, simply press ►. The player is turned on, and playback starts from the interrupted position. If you turn on the player by pressing ⏻ then press ►, playback starts from the beginning of the disc. Note that the memory is cleared if you open the disc tray.

When the resume mode is “DISC RESUME”

When you press ■, the player stops playback and memorizes the interrupted position. The TV screen shows [RESUME STOP] and the [RESUME] indicator lights up in the display window.

The memory of the interrupted position is not cleared if you open the disc tray or turn off the player.

Hint

The player memorizes interrupted positions for the last 30 discs played. Storing a new interrupted position will erase the interrupted position stored for the first disc.

To clear the memory

Press ■ while the disc is stopped.

To resume playback

When the resume mode is “ON”

While the disc you interrupted playback is still on the disc tray, press ►.

The player resumes playback from the position where playback was interrupted. The TV screen shows [RESUME PLAY].

To play back from the beginning

Press ■ before pressing ► to start playback.

When the resume mode is “DISC RESUME”

1 Press ▲ to insert a disc for which the player has stored an interrupted position.

The TV screen shows [RESUME STOP].

2 Press ►.

The TV screen shows [RESUME PLAY] and the player resumes playback from the position where playback was interrupted.

To play back from the beginning

After inserting the disc, press ■ before pressing ► to start playback.

NOTES

- If you change the [RESUME] setting from [DISC RESUME] to [OFF] or [ON], you cannot resume playback of a disc whose “resuming” position is stored. However, when you again set [RESUME] to [DISC RESUME], you will then be able to resume playback of the disc.
- If you interrupt the playback of a disc for which an interrupted position has already been stored, the memory will be updated with the new interrupted position.
- For a double-sided DVD VIDEO disc, the player regards each side as a different disc. Therefore, to resume playback of such a disc, the disc must be inserted with the same side down.
- When the player memorizes an interrupted point for a disc, it also memorizes Audio, Subtitle and Angle settings.
- The player may not resume playback exactly from the interrupted point. In the case of an SVCD/Video CD disc with PBC function, the player may resume playback from a point slightly earlier or later than the point where playback was interrupted.

Various speed playback

To advance or reverse playback rapidly while monitoring



During playback, press ►► or ◀◀ on the remote control unit.

You can select from 1.5 times, 5 times, 20 times and 60 times normal speed. Pressing ► returns the player to normal playback.

During playback, hold down ►► or ◀◀.

Playback is advanced or reversed at 5 times normal speed.

NOTE

During rapid playback, the sound will be muted except when playing an Audio CD, and when playing a DVD VIDEO or Video CD at 1.5 times normal speed. For Audio CD discs, the sound will be heard intermittently.

x1.5 Quick Playback with sound



When you select 1.5 times normal speed playback, the disc is played back with sound.

- For DVD VIDEO discs, the subtitle does not go off.
- If the sound of a DVD VIDEO disc is recorded in Dolby Digital or DTS format, stereo linear PCM signals are output. With some DVD VIDEO discs, the sound quality and volume may alter, or the sound may be out of tune.
- To switch from rapid reverse playback to x1.5 Quick Playback, first press ►, then press ►► once.
- When the KARAOKE function is turned on, no sound will be heard during x 1.5 Quick Playback. Also, note that you cannot change the KARAOKE function settings during x 1.5 Quick Playback, though the input signal from the MIC jack is output from the player.

To advance a still picture frame by frame



While paused, press II.

Each time you press II, the still picture advances to the next frame.

Pressing ► returns to normal playback.

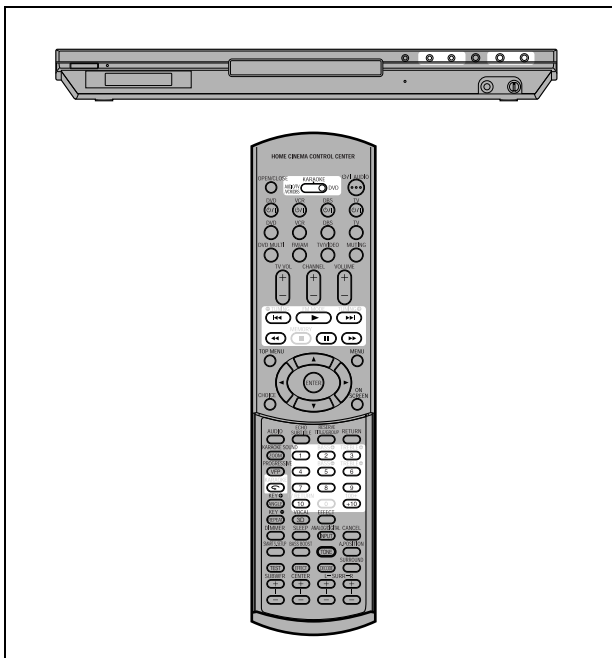

Locating the beginning of a scene or song



For DVD VIDEO: During playback, you can skip a chapter or title, depending on the disc configuration.
 For SVCD/Video CD: During playback without PBC function, you can skip a track.
 For Audio CD: During playback or while in stop mode, you can skip a track.

To skip forward, press ►►.

To skip backward, press ◀◀.

Using the numeric buttons

For DVD VIDEO/Audio CD: During playback or while in stop mode

For SVCD/Video CD: During playback without PBC function or while in stop mode

Press the numeric buttons to specify the number.

To select 5: press 5.

To select 23: press +10, +10, then 3.

To select 40: press +10, +10, +10, then 10.

The player starts playback from the beginning of the selection.

NOTES

- Depending on the disc type and the player status, what is specified differs:

Player status	Disc type	What is specified
While stopped	DVD VIDEO	title
	SVCD/Video CD/Audio CD	track
During playback	DVD VIDEO	chapter
	SVCD/Video CD/Audio CD	track

- During DVD VIDEO playback, if a menu is shown on the TV screen, the numeric buttons may be used for selecting an item in the menu.

To play back in slow motion



You can select from 1/32 times, 1/16 times, 1/4 times and 1/2 times normal speed.

During playback, press II, then press ►► (to play forward slow motion), or ◀◀ (to play reverse slow motion, for DVD VIDEO disc only).

Pressing ► returns to normal playback.

NOTES

- During slow motion playback, the sound will be muted.
- Reverse slow motion playback is not possible for an SVCD and Video CD.
- When a DVD VIDEO disc is played in reverse slow motion while the KARAOKE function is turned on, the input signal from the MIC jack is not output.

To replay the previous scenes (One touch replay function)



During DVD VIDEO playback, press ↶.

The playback position moves back 10 seconds before the current position.

NOTES

- This function works only within the same title, though it works between chapters.
- This function may not work with some DVD VIDEO discs.
- Before using this function while the KARAOKE function is turned on, be sure to set the mode selector on the remote control unit to "DVD."

About screen saver function

A television monitor may have an image burned into it if a static image is displayed for a long time. To prevent this, the player automatically activates the screen saver function if a static picture, such as an on-screen display or menu, is displayed for over 5 minutes.

When the screen saver function is activated, the TV screen gets darker.

Pressing any buttons will release the screen saver function.

XV-NK58SL

Advanced operations

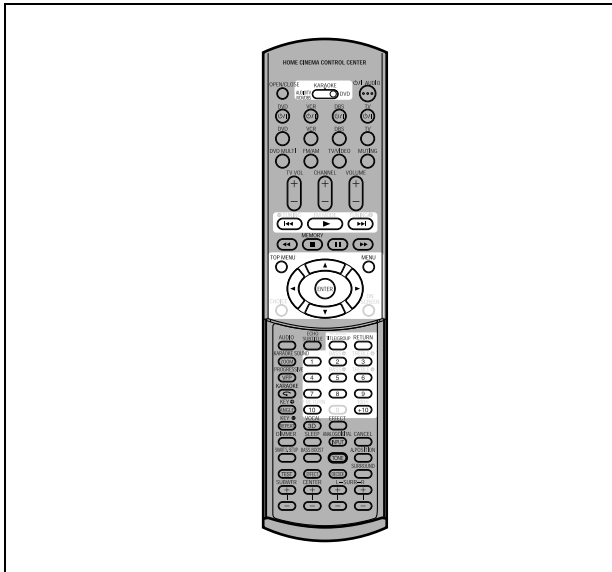

NOTE



When operating the player, set the mode selector to "DVD."

Playing from a specific position

Locating a desired scene from the DVD menu



DVD VIDEO discs generally have their own menus which show the disc contents. These menus contain various items such as titles of movies, names of songs, or artist information, and display them on the TV screen. You can locate a desired scene using the DVD menu.

1 While a DVD VIDEO disc is inserted, press TOP MENU or MENU.

The menu appears on the TV screen.

2 Press ▲/▼/◀/▶ to select a desired item, then press ENTER.

The player starts playback of the selected item.

Hints

- Some DVD VIDEO discs may also have a different menu which appears when MENU is pressed.
- See the instructions of each DVD VIDEO disc for its particular menu.
- With some discs, you can select items by entering the corresponding number using the numeric buttons, which may cause the player to automatically start playback.

NOTE

The MENU button does not work while stopped.

Locating a desired scene from the menu of a SVCD/Video CD with PBC



Some SVCD/Video CD discs support the PBC function. PBC is an abbreviation of "Playback Control." Some SVCD/Video CD discs recorded with PBC have their own menus, such as a list of the songs of the disc. You can locate a specific scene by using the PBC menu.

1 In stop mode, press ► or TOP MENU.

A disc menu appears on the TV screen.

2 Press the numeric buttons to select the desired item.

To select 5: press 5.

To select 23: press +10, +10, then 3.

To select 40: press +10, +10, +10, then 10.

The player starts playback of the selected item.
To return to the menu, press RETURN.

Hint

If something like [NEXT] or [PREVIOUS] appears on the TV screen, pressing ►| advances to the next page, and pressing ◀| returns to the previous page.

Specifying a desired title



1 During playback, press TITLE/GROUP.

[--] is shown in the title display area of the display window.

2 Press the numeric buttons to specify a title to be played.

To select 5: press 5.

To select 23: press +10, +10, then 3.

To select 40: press +10, +10, +10, then 10.

The player starts playback from the specified title.

NOTE

This function may not work with some DVD VIDEO discs.

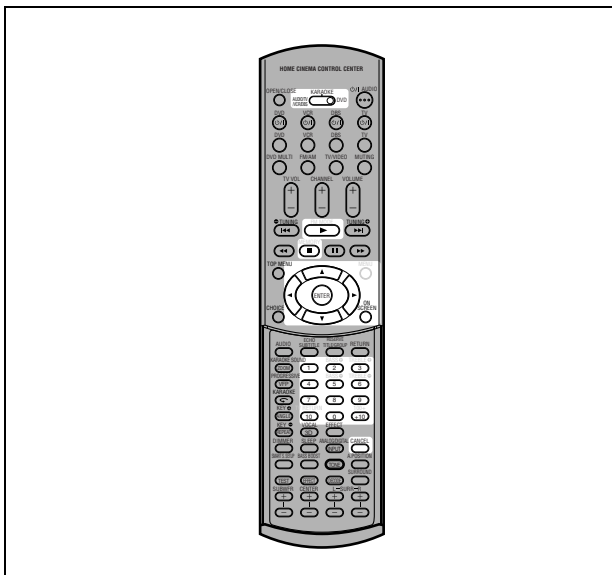

Locating a desired position in the current title or track (Time search)



You can play a disc from the desired position by specifying the time from the beginning of the current title (for DVD VIDEO) or the disc (for SVCD/Video CD/Audio CD).

For DVD VIDEO/Audio CD: During playback or while in stop mode

For SVCD/Video CD: In any condition except SVCD/Video CD playback with PBC

1 Press ON SCREEN twice.

The menu bar appears on the TV screen.

2 Press ◀▶ to move ↻ to ⏮▶, then press ENTER.

The pull-down menu for entering time appears.

Screen example for DVD VIDEO

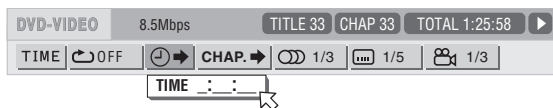

Screen example for Audio CD

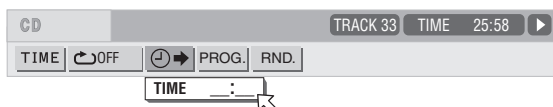

3 Press the numeric buttons (0 to 9) to enter the desired time.

The specified time is displayed in the pull-down menu.

Example (for DVD VIDEO)

To play back from 2(H):34(M):00(S)

Press 2, 3, then 4.

TIME 2:34:__

Example (for SVCD/Video CD/Audio CD)

To play back from 23(M):40(S)

Press 2, 3, then 4.

TIME 23:4_

You do not have to press "0" to enter the trailing zeros (for the last two digits in the example above).

To correct a mistake

Press ◀ repeatedly to move back to the digit where you entered a wrong number, and reenter the correct one.

4 Press ENTER.

The player starts playback from the specified time.

To dismiss the menu bar

Press ON SCREEN.

Hint

"10" and "+10" buttons are not used with this function.

NOTES

- Some DVD VIDEO discs do not contain time information, and the time search function cannot be used.
- The time search function cannot be used during program playback.

Changing the playback order

To play back in a specific order (Program play)



By programming tracks, you can play up to 99 tracks in any order. You may program the same track more than once.

1 In stop mode, press ON SCREEN twice.

The menu bar appears on the TV screen.

2 Press ◀▶ to move ↻ to ⏮▶, then press ENTER.

Screen example for Audio CD

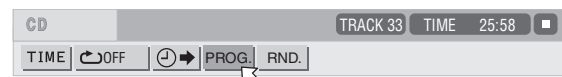

3 Press ENTER.

The program table appears.

The [PRGM] indicator lights up in the display window.

4 Press the numeric buttons to specify tracks in the desired order.

To select 5: press 5.
 To select 23: press +10, +10, then 3.
 To select 40: press +10, +10, +10, then 10.

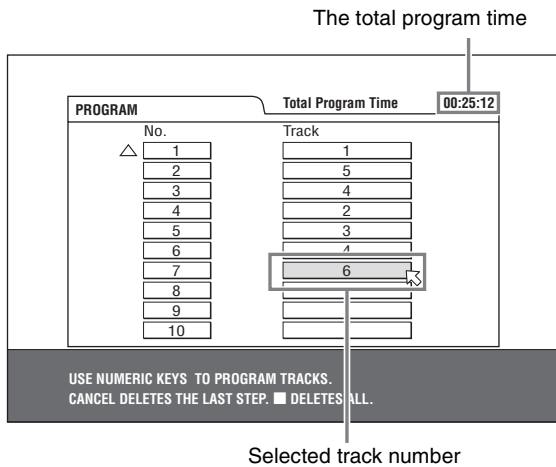

To correct the program

Press ▲/▼ to move \leftarrow to the track to be corrected, then press CANCEL. The track is erased and the subsequent programmed tracks move up.
 Pressing ■ clears all the programmed tracks.

5 Press ► to start program playback.

With an Audio CD disc, the program table remains on the TV screen during program playback. (Pressing ON SCREEN brings up the status bar.)

When all of the programmed tracks have finished playback, the player stops and the program table appears again.
 Note that the program remains.

- During program playback, you cannot edit the program contents.

To check the program contents

During playback, press ■. Playback stops and the program table is shown.

When the player is playing back an Audio CD and the program table is not shown, you can bring up the table by carrying out steps 1 to 3.

During SVCD/Video CD playback, you can check the program contents via the menu bar.

To stop program playback

Press ■.

To clear the program

While stopped and the program table is shown, press ■.

To exit the program mode

After clearing the program, press ON SCREEN.

NOTE

When the disc tray is opened or the player is turned off, the program is cleared.

To play back in random order (Random play)



1 In stop mode, press ON SCREEN twice.

The menu bar appears on the TV screen.

2 Press ◀▶ to move \leftarrow to [RND].

Screen example for Audio CD

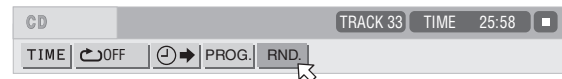

3 Press ENTER.

The player starts random playback.

With an SVCD/Video CD disc, the menu bar is automatically dismissed.

During random playback, the [RND] indicator lights up in the display window.

After playing all tracks of the disc, the player stops the disc and exits the random playback mode.

To stop and quit random playback

Press ■. The player stops playback and exits the random playback mode.

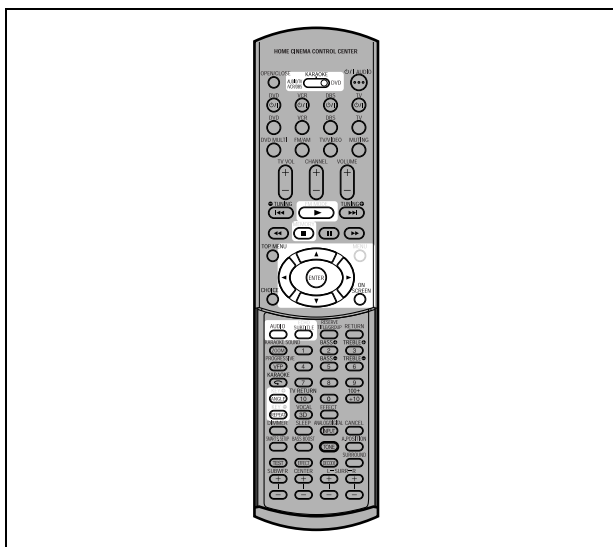

Repeat playback

To repeat the current selection or all tracks



For DVD VIDEO: During playback
For SVCD/Video CD/Audio CD: In any condition except SVCD/
Video CD playback with PBC

Press REPEAT.

If you press REPEAT in stop mode, press ► to start playback.

Each time you press REPEAT, the repeat mode cycles among All repeat, Repeat 1 and off.

The indication on the display window shows the selected repeat mode.

: Repeats the current title for DVD VIDEO or all tracks for SVCD/Video CD/Audio CD.

1: Repeats the current chapter for DVD VIDEO or the current track for SVCD/Video CD/Audio CD.

No indication: The repeat mode is off.

A window which indicates the current repeat mode will be displayed on the TV screen. The mode indication on the window is same as the one on the menu bar.

(Repeat mode example on the TV screen)



To stop repeat playback

Press ■.

When a DVD VIDEO disc is set, the player stops playback and quits the repeat mode.

When an SVCD, Video CD or Audio CD disc is set, the player stops playback but does not quit the repeat mode.

To quit repeat playback

Press REPEAT until the repeat mode indicator goes off in the display window.

Hint

When the program playback mode is active with an SVCD, Video CD or Audio CD, the repeat mode changes in the same manner.

Note, however, that in the " " mode the player repeats all the programmed tracks instead of all tracks on the disc.

NOTE

The repeat playback may not work with some discs, even if you select one of the repeat modes.

To repeat a desired part (A-B repeat playback)



First make sure:

- The player is in playback mode except SVCD/Video CD playback with PBC.

1 Press ON SCREEN twice.

The menu bar appears on the TV screen.

2 Press ◀▶ to move to , then press ENTER.

The pull-down menu for repeat mode selection appears.

3 Press ▲▼ to select [A-B].

4 Press ENTER at the beginning of the part you want to repeat (point A).

The pull down menu disappears.

The repeat icon shows A- .

5 Press ENTER at the end of the part you want to repeat (point B).

The repeat icon shows A-B .

The player locates "A" and starts repeat playback between "A" and "B."

The [] indicator lights in the display window.

To quit A-B repeat playback

Press ◀▶ to move to A-B , and press ENTER. The A-B repeat mode turns off, then normal playback continues.

NOTES

- The A and B points must be set in the same title/track.
- The A-B repeat playback cannot be made when the KARAOKE function is turned on.

Changing the language, sound and scene angle

To select the subtitle language (SUBTITLE)



Some DVD VIDEO and SVCD discs contain more than one subtitle language. You can choose a desired one from them.

Hint

At the beginning of the part where the subtitles are recorded,  appears on the TV screen (except when the [ON SCREEN GUIDE] preference is set to [OFF]).

1 During playback, press SUBTITLE.

The subtitle selection window appears on the TV screen.

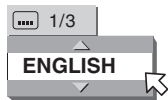

2 Press ▲/▼ or SUBTITLE to select the subtitle.

Each time you press ▲/▼ or SUBTITLE, the subtitle language changes.

3 Press ENTER.

Subtitles are displayed in the selected language. The subtitle selection window is dismissed.

NOTES

- An SVCD disc can have up to four subtitles. Pressing ▲/▼ cycles through those channels regardless of whether the subtitles are recorded or not.
- The subtitle selection window will automatically disappear if you do not change the subtitle for several seconds.
- For DVD VIDEO, the selected language may be abbreviated on the TV screen. See “Appendix B: Table of languages and their abbreviations” on page 63.

To change the audio language or sound (AUDIO)



The audio selection setting allows you to change the audio language of a movie, or to listen to karaoke with or without the vocal.

Hint

At the beginning of the part where multiple audio tracks are recorded,  appears on the TV screen (except when the [ON SCREEN GUIDE] preference is set to [OFF]).

1 During playback, press AUDIO.

The audio selection window appears on the TV screen.

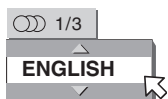

2 Press ▲/▼ or AUDIO to select the desired audio.

Each time you press ▲/▼ or AUDIO, the audio changes.

For DVD VIDEO (example)



For SVCD

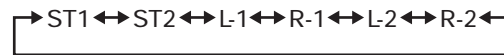

For Video CD



3 Press ENTER.

You can hear the selected audio. The audio selection window is dismissed.

NOTES

- The audio selection window will automatically disappear if you do not change the audio for several seconds.
- For DVD VIDEO, the selected language may be abbreviated on the TV screen. See “Appendix B: Table of languages and their abbreviations” on page 63.

To select a scene angle of DVD VIDEO (ANGLE)



You can enjoy a variety of scene angles if the DVD VIDEO disc contains “multi-angle” parts, where multiple cameras were used to shoot the same scene from different angles.

Hint

At the beginning of a “multi-angle” part,  appears on the TV screen (except when the [ON SCREEN GUIDE] preference is set to [OFF]).

1 During playback, press ANGLE.

The angle selection window appears on the TV screen.

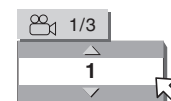

2 Press ▲/▼ or ANGLE to select the desired angle.

Each time you press ▲/▼ or ANGLE, the angle changes.

3 Press ENTER.

You can see the picture from the selected angle. The angle selection window is dismissed.

NOTE

The angle selection window will automatically disappear if you do not change the angle for several seconds.

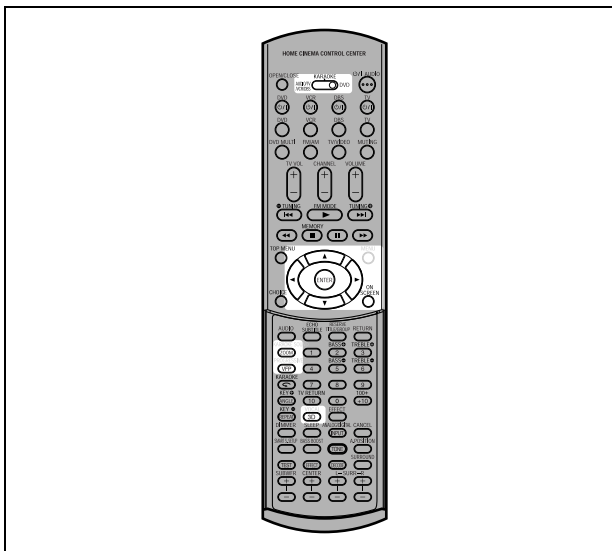

Special picture/sound effect

To zoom in pictures



1 During playback or while paused, press ZOOM.

Pressing ZOOM causes the player to zoom in on the image. At the top left of the screen, the information for the current magnification appears for about 5 seconds. Each time you press ZOOM, the magnification is doubled (1.8, 4, 8, 16, 32 and 64 times).

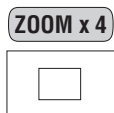

When a picture of a DVD VIDEO disc is viewed on a normal TV screen (4:3, Letter Box), black bars may appear at the top and bottom of the screen. In this case, if you select the "ZOOM x1.8" mode, the black bars become almost invisible. When a 1:2.35 or 1:1.85 DVD VIDEO source is played back, however, the black bars are visible on the screen.

2 Press ▲/▼/◀/▶ to move the zoomed position.

To return to the normal playback

Press ENTER.

NOTES

- While zoomed, the picture may look coarse.
- When the KARAOKE function is turned on, you cannot zoom in pictures even if the mode selector on the remote control unit is set to "DVD."

To adjust the picture character (VFP)



The VFP (Video Fine Processor) function allows you to adjust the picture character according to the type of programming, picture tone or personal preferences.

1 During playback, press VFP.

The VFP mode selection window appears on the TV screen.

2 Press ◀/▶ to select the desired preset.

Each time you press the button, the VFP mode changes as follows. Set the video type most suitable to the current program or the room conditions.



Selected preset

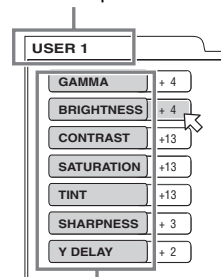

Parameter

[NORMAL]: for watching TV in a general room.

[CINEMA]: for watching a movie software in a room with suppressed light.

[USER 1] [USER 2]: you can adjust parameters that affect the picture character and store the settings as a user preset. See the next step.

3 To define a user setting, press ▲/▼ to select a parameter to be edited from the following.

- **GAMMA**
Adjust this if the neutral color is bright or dark. The brightness of dark and bright portion is maintained. Available range: -4 (darkest) to +4 (brightest).
- **BRIGHTNESS**
Adjust this if the picture is bright or dark on the whole. Available range: -16 (darkest) to +16 (brightest).
- **CONTRAST**
Adjust this if the far and near position is unnatural. Available range: -16 to +16.
- **SATURATION**
Adjust this if the picture is whitish or blackish. Available range: -16 (blackest) to +16 (whitest).
- **TINT**
Adjust this if the appearance of flesh tone is unnatural. Available range: -16 to +16.
- **SHARPNESS**
Adjust this if the picture is indistinct. Available range: 0 to +3.
- **Y DELAY**
Adjust this if the picture looks separately/overlapped. Available range: -2 to +2.

4 Press ENTER.

A window for setting parameters appears.



Selected parameter

5 Press ▲/▼ to adjust the level of the parameter.

The higher value enhances the effect.

6 Press ENTER.

Repeat steps 3 to 6 if you want to set other parameters.

To dismiss the VFP mode selection window

Press VFP.

NOTES

- The window for VFP mode selection and parameter setting disappear if no operation is made for about 10 seconds.
- When the KARAOKE function is turned on, the VFP function cannot be activated even if the mode selector on the remote control unit is set to "DVD."

To simulate surround sound (3D PHONIC)



Using the 3D PHONIC function, you can get a simulated surround effect from your stereo system.

1 During playback, press 3D.

The 3D PHONIC window appears on the TV screen.

2 Press ◀▶ to select the desired mode.

Each time you press the button, the 3D PHONIC mode changes as follows:

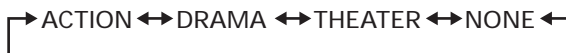

Selected effect mode

- **ACTION**
Suitable for action movies and sports programs in which the sound source moves.
- **DRAMA**
Natural and warm sound. You can enjoy movies in a relaxed mood.
- **THEATER**
You can enjoy sound effects like in a theater.

3 Press ▲/▼ to adjust the effect level.

You can set the effect level from [1] to [5].
The higher value enhances the effect.

To dismiss the 3D PHONIC window

Press 3D.

NOTES

- The 3D PHONIC window disappears if no operation is made for about 10 seconds.
- The 3D PHONIC function works correctly only when playing back a DVD VIDEO disc recorded with Dolby Digital.
- When playing back a DVD VIDEO disc recorded with Dolby Digital that does not contain the rear signal, you can change the 3D PHONIC setting, but you will not be able to achieve a correct 3D effect.
- The 3D PHONIC function does not affect the Dolby Digital bitstream signal from the DIGITAL OUT jack.
- When the 3D PHONIC function is active, the [ANALOG DOWN MIX] setting in the [AUDIO] setting display is not available.
- When the KARAOKE function is turned on, the 3D PHONIC function is deactivated.

Menu bar functions

To bring up the menu bar

1 When a disc is inserted, press ON SCREEN.

A status bar for the type of disc inserted will appear on the TV screen.

See page 36 for details about the status bar.

2 Press ON SCREEN again.

A menu bar for the type of disc inserted will appear under the status bar.

(for DVD VIDEO)



(for SVCD)

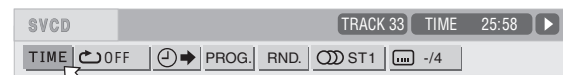

(for Video CD)



(for Audio CD)

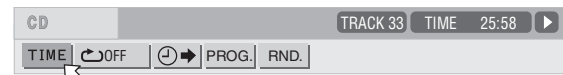

To dismiss the menu bar and status bar

Press ON SCREEN.

Basic operation procedure

1 Press ◀▶ to select the icon you want to work with.

The selected icon is pointed by ↗.

2 Press ENTER.

With many icons, an appropriate pull-down window appears, however, there are some exceptions.

NOTES

- A mark or text on the menu icon for the function or mode currently selected is shown in green.
- Some functions are not available during playback. (You cannot move ↗ to the associated icon when it is not available.)

Menu bar functions for DVD VIDEO

Time mode selection

During playback, selects the time mode shown in the display window and in the status bar.

Press ENTER to select the time mode from the following.

- TOTAL: Current title elapsed time
- T.REM: Current title remaining time
- TIME: Current chapter elapsed time
- REM: Current chapter remaining time

Repeat mode (See also page 42)

Selects the repeat mode during playback.

1. Open the pull-down window.
2. Press ▲/▼ to select the repeat mode from the following.
 - CHAPTER: Current chapter repeat
 - TITLE: Current title repeat
 - A-B: A-B repeat
 - OFF: Repeat mode deactivated
3. Press ENTER to make the selected repeat function active.

Time search (See also page 40)

Specifies a time from the beginning of the current title as the point from which to begin playback.

Chapter search

During playback, specifies a desired chapter to be played back from.

1. Open the pull-down window.
2. Press numeric buttons (0 to 9) to enter a desired chapter number. (For example, to specify "10," press 1, then 0.)
3. Press ENTER to begin playback from the specified chapter.

Audio selection (See also page 43)

During playback, selects the audio language or sound track.

1. Open the pull-down window.
2. Press ▲/▼ to select a desired audio language or sound track.
3. Press ENTER to begin playback with the selected audio.

Subtitle selection (See also page 43)

During playback, selects the subtitle language.

1. Open the pull-down window.
2. Press ▲/▼ to select a desired subtitle language.
3. Press ENTER to begin playback with the selected subtitle.

Angle selection (See also page 43)

During playback, selects a desired scene angle in a multi-angle part.

1. Open the pull-down window.
2. Press ▲/▼ to select a scene angle.
3. Press ENTER to begin playback with the selected scene angle.

Menu bar functions for SVCD/Video CD/ Audio CD

Time mode selection

Selects the time mode shown in the display window and in the status bar.

Press ENTER to select the time mode from the following.

- TIME: Current track elapsed time
- REM: Current track remaining time (while in stop mode, current track total time)
- TOTAL: Disc elapsed time
- T.REM: Disc remaining time (while in stop mode, disc total time)

Repeat mode (See also page 42)

Selects the repeat mode.

1. Open the pull-down window.
2. Press ▲/▼ to select the repeat mode from the following.
 - TRACK: Current track repeat
 - ALL: All track repeat
 - A-B: A-B repeat
 - OFF: Repeat mode deactivated
3. Press ENTER to make the selected repeat function active.

Time search (See also page 40)

Specifies a time from the beginning of the disc as the point from which to begin playback.

Program playback (See also pages 40 and 41)

While stopped, specifies the playback order of tracks.

Random playback (See also page 41)

While stopped, activates random playback.

Audio selection (See also page 43)

During SVCD/Video CD playback, selects the audio channel(s).

1. Open the pull-down window.
2. Press ▲/▼ to select a desired audio channel(s).
3. Press ENTER to play back with the selected audio channel(s).

Subtitle selection (See also page 43)

During SVCD playback, selects the subtitle.

1. Open the pull-down window.
2. Press ▲/▼ to select a desired subtitle.
3. Press ENTER to begin playback with the selected subtitle.

XV-NK58SL MP3/WMA disc playback

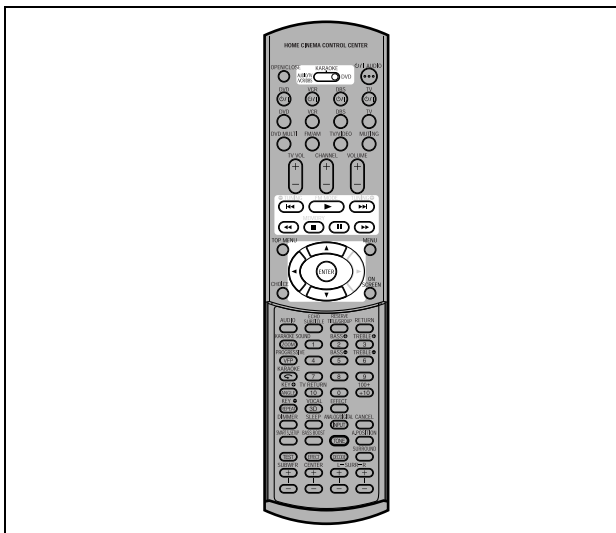

NOTE



When operating the player, set the mode selector to "DVD."

Operations

The player can play back MP3 files and WMA files on a home recorded CD-R/RW disc or commercially available CD. We refer to a disc that contains MP3 and/or WMA files as an "MP3/WMA disc" in this manual.

Note that if a disc contains both of MP3/WMA files and JPEG files, you can only play back files of the type selected by the [MP3&WMA/JPEG] setting in the [PICTURE] preference display. (see page 59).

About MP3/WMA discs

On an MP3/WMA disc, each song is recorded as a file (track). Files are sometimes grouped into folders by artists, album, etc.

- Each file is regarded as a track.
- A folder which has one or more files is regarded as a group.
- A folder which does not directly contain any tracks is ignored.
- Files which do not belong to any folder are grouped into "group 1."
- The player recognizes up to 150 tracks per group, and up to 99 groups per disc. If there are files other than MP3/WMA files, they also count in the 150-file total.

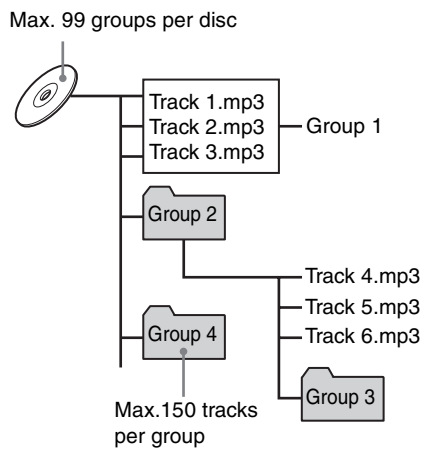

Notes for making your own MP3/WMA disc using a CD-R/CD-RW disc

- Select "ISO 9660" as the disc format.

- As for MP3 files, we recommend you to record your material at a 44.1 kHz sampling rate, using the 128 kbps data transfer rate.
- As for WMA files, make sure that the copyright feature is set to off.
- As for WMA files, we recommend you to record your material at a bit rate of 64 kbps or higher.

Basic operations

Use the following buttons to control MP3/WMA disc playback.

- ENTER: Starts playback while stopped.
- ▶: Starts playback while stopped or paused.
- : Stops playback.
- ⏸: Pauses playback.
- ⏮/⏭: Skips back or forward a track during playback. Selects the previous or next track while stopped.

If you press ▶ during playback, or press ■ to stop playback followed by ▶, the player starts playback from the beginning of the current track.

NOTES

- The player does not support "packet writing (UDF file)" discs.
- The player does not support the ID3 tag.
- The player supports discs recorded with multiple sessions.
- Some discs may not play due to disc characteristics or recording conditions.
- Programmed and random playback functions do not work with MP3/WMA discs.
- When an MP3/WMA disc is played back, the KARAOKE function cannot be turned on.
- As for MP3, the player only can play back tracks with the following file extensions; ".MP3," ".Mp3," ".mp3" and ".mP3."
- As for WMA, the player only can play back tracks with the following file extensions; ".WMA," ".wma," and any other combination of upper case and lower case letters (such as ".Wma").
- Time required for reading the disc contents may vary for different discs, depending on the numbers of groups (folders) and tracks (files) recorded, etc.
- You cannot advance or reverse playback by pressing ▶▶ or ◀◀, or by holding down ▶▶| or |◀◀ during MP3/WMA disc playback.
- The player supports WMA files recorded with a bit rate of 48 kbps or higher. The player cannot play back WMA files recorded with a bit rate under 48 kbps.

Selecting the desired group and track

When inserting an MP3/WMA disc, after the disc contents are read, the MP3/WMA CONTROL display automatically appears on the TV screen.

You can specify the desired group/track from the display using the following procedure.

- 1 Make sure that the black (cursor) bar is in the left (group) column.**
If it is in the right column, press ◀ to move it to the left column.
- 2 Press ▲/▼ to move the bar to a desired group.**
On the right column, tracks in the selected group are shown.
- 3 Press ⏮/⏭ to select a desired track, then press ENTER or ▶.**

or

Press the numeric buttons to directly specify a desired track number.

To select 5: press 5.

MP3/WMA disc playback

To select 23: press +10, +10, then 3.
To select 40: press +10, +10, +10, then 10.

The player starts playback from the selected track.

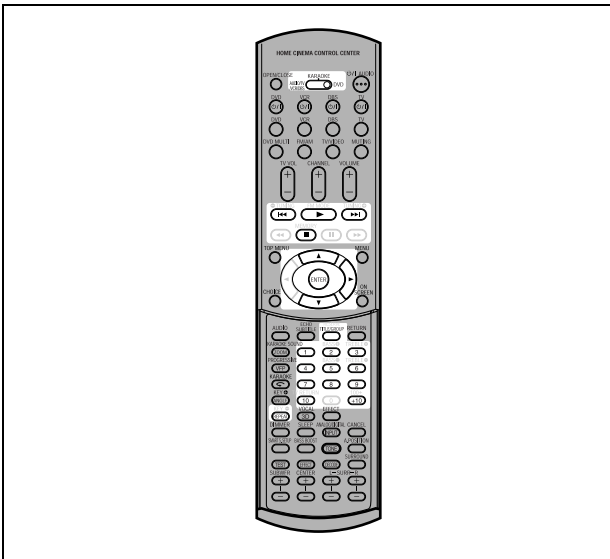

Current track elapsed time

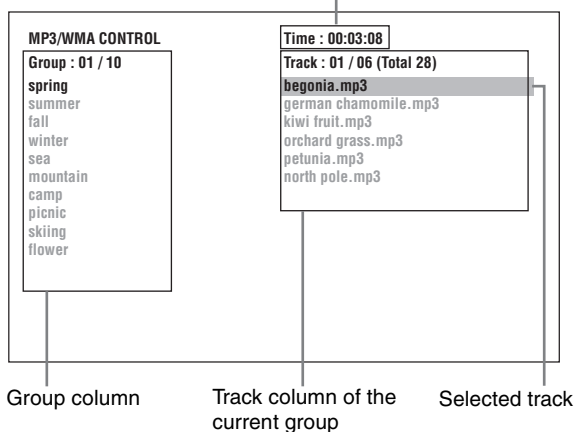

Hint

You can also select a desired track by pressing ► to move the black bar to the right (track) column then using ▲/▼.

NOTES

- If an MP3/WMA file name includes any 2-byte character, the player cannot show the file name correctly.
- Only MP3/WMA files are shown on the MP3/WMA CONTROL display.
- The order of groups/tracks shown in the MP3/WMA CONTROL display may differ from the order shown on your personal computer when you set the disc on your computer.

Direct selection

You can select a desired group directly by specifying the group number.

1 During playback or while stopped, press TITLE/GROUP.

[--] is shown in the group display area of the display window.

2 Press the numeric buttons to specify a desired group number.

To select 5: press 5.
To select 23: press +10, +10, then 3.
To select 40: press +10, +10, +10, then 10.

Specify the group number within several seconds after pressing TITLE/GROUP (i.e. while the display window shows [--]).

The player starts playback from track 1 of the selected group.

3 Press the numeric buttons to specify a desired track number.

The player starts playback from the specified track. You can also use ◀◀/▶▶ or ▲/▼ to specify a track, instead of the numeric buttons.

Repeat playback

During playback or while stopped, press REPEAT.

Each time you press REPEAT, the repeat mode changes as follows.

If you press REPEAT while stopped, you need to press ENTER or ► to start repeat playback.

MP3/WMA CONTROL display	Display window	Function
REPEAT TRACK	1	Repeats the current track.
REPEAT GROUP	2	Repeats all tracks in the current group.
REPEAT ALL	3	Repeats all tracks on the disc.
No indication	The repeat mode is off.	

(TV screen)

Selected repeat mode

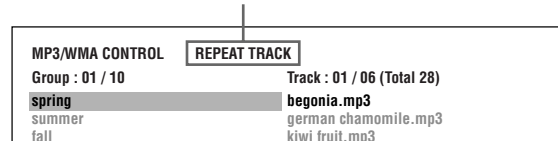

To stop repeat playback

Press ■. Note that the repeat mode remains active.

To quit repeat playback

During playback, press REPEAT until no repeat icon is shown on the display window.

While stopped, press REPEAT until repeat mode indication on the MP3/WMA CONTROL display goes off.

XV-NK58SL

JPEG disc playback

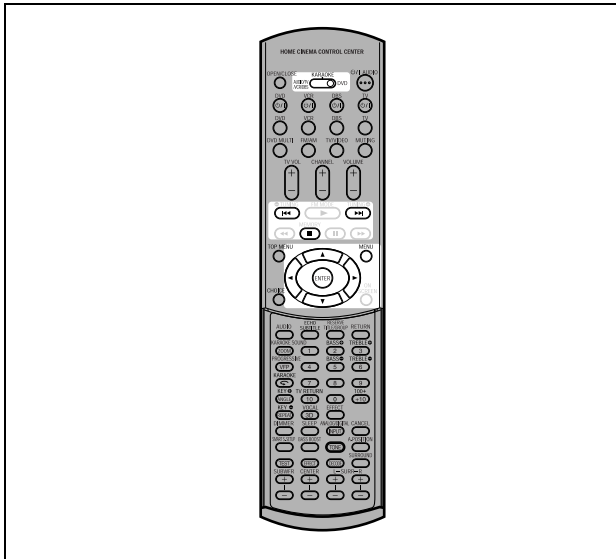

NOTE



When operating the player, set the mode selector to "DVD."

The player can play back JPEG files on a home recorded CD-R/RW disc. We refer to a disc that contains JPEG files as a "JPEG disc" in this manual.

Note that if a disc contains both of MP3/WMA files and JPEG files, you can only play back files of the type selected by the [MP3&WMA/JPEG] setting in the [PICTURE] preference display. (see page 59).

About JPEG discs

On a JPEG disc, each picture is recorded as a file. Files are sometimes grouped into folders by category, etc.

- A folder which has one or more files is regarded as a group.
- A folder which does not directly contain any files is ignored.
- Files which do not belong to any folder are grouped into "group 1."
- The player recognizes up to 150 files per group, and up to 99 groups per disc. If there are files other than JPEG files, they also count against the 150-file total.

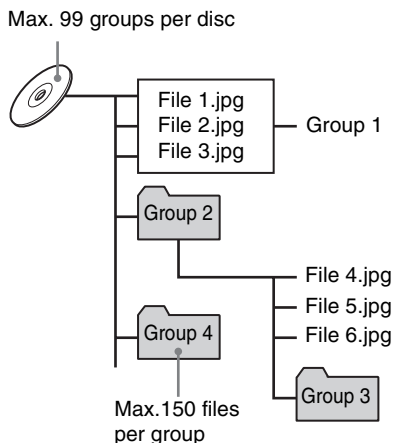

Notes for making your own JPEG disc using a CD-R/CD-RW disc

- Select "ISO 9660" as the disc format.
- We recommend you to record your material at a 640 x 480 pixel resolution.
- This player supports the baseline JPEG format.

Basic operations

To see a desired picture

When inserting a JPEG disc, after the disc contents are read, the JPEG CONTROL display automatically appears on the TV screen.

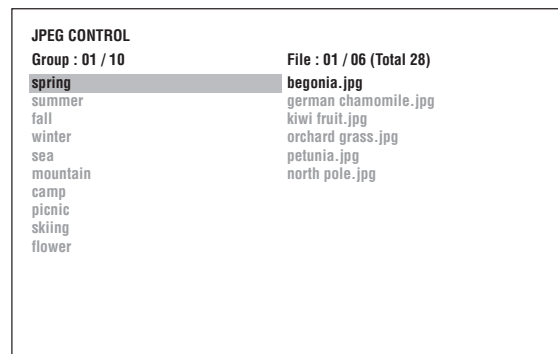

You can select a desired file for playback via this display.

1 Make sure that the black (cursor) bar is in the left (group) column.

If it is in the right column, press ◀ to move it to the left column.

2 Press ▲/▼ to move the bar to a desired group.

On the right column, files in the selected group are shown.

3 Press ◀◀/▶▶ to select a desired file, then press ENTER.

The selected file (still picture) is shown on the TV.

Hint

You can also select a desired file by pressing ▶ to move the black bar to the right (file) column then using ▲/▼.

NOTE

If the selected file is unplayable, a black screen appears.

To display another picture

Press ◀◀/▶▶ or ▲/▼ to select the desired picture.

To dismiss the picture

Press ■ or MENU.

The TV screen returns to the JPEG CONTROL display.

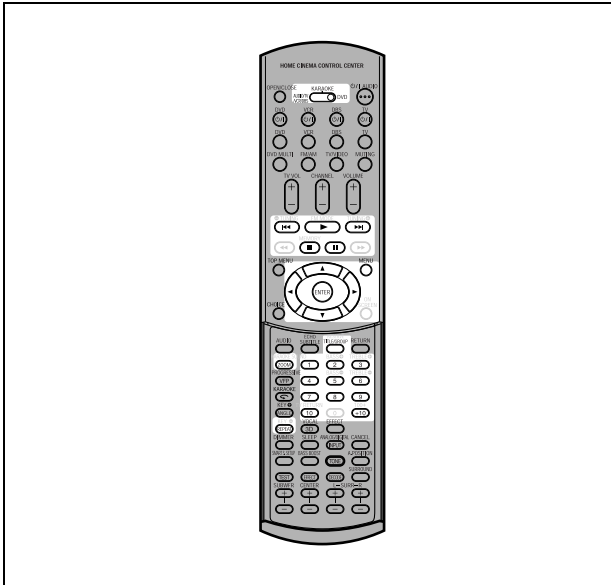

NOTES

- The player supports the baseline JPEG format.
- The player does not support “packet writing (UDF file)” discs.
- The player supports discs recorded with multiple sessions.
- The player may not be able to read some discs, or may take a long time to display a picture on the disc, due to disc characteristics, recording conditions, or numbers of groups (folders), etc.
- Programmed and random playback functions do not work with JPEG discs.
- When a JPEG disc is played back, the KARAOKE function cannot be turned on.
- The screen saver function will be activated if the same picture is displayed for more than 5 minutes except during slide show playback.
- The player only can play back files with the following file extensions; “.jpg,” “.jpeg,” “.JPG,” “.JPEG” and any other combination of upper case and lower case letters (such as “.Jpg”).
- If a JPEG file name includes any 2-byte character, the player may not show the file name correctly.
- If a picture has been saved at greater than 640 x 480 pixel resolution, it may take some time to display the picture.
- The player does not support pictures of more than 2400 pixels in horizontal resolution. Make sure that the horizontal resolution of the picture is 2400 pixels or less.

To zoom in the picture

1 While in pause mode, press ZOOM.

Pressing ZOOM causes the player to zoom in on the image. Each time you press ZOOM, the magnification is doubled (1.8, 4, 8, 16, 32 and 64 times).

2 Press ▲/▼/◀/▶ to move the zoomed position.

Viewing pictures continuously (slide show mode)

You can see files (still pictures) one after another automatically.

To start the slide show

Press ►.

The slide show starts from the beginning of the disc. Each file (still picture) is displayed for approximately 3 seconds.

To stop slide show playback in the middle

Press ■ or MENU.

The TV screen returns to the JPEG CONTROL display.

Pressing ► resumes slide show playback from the last picture displayed.

To keep showing the current picture

Press || or ENTER.

Pressing ► resumes the slide show playback.

To select the start point of the slide show

From the JPEG CONTROL display

1 Make sure that the black (cursor) bar is in the left (group) column.

If it is in the right column, press ◀ to move it to the left column.

2 Press ▲/▼ to move the bar to a desired group.

3 Press |◀◀/▶▶| to select a desired file.

4 Press ►.

The slide show starts from the specified file.

Direct selection

1 During playback or while stopped, press TITLE/GROUP.

2 Press the numeric buttons to specify a desired group number.

To select 5: press 5.

To select 23: press +10, +10, then 3.

To select 40: press +10, +10, +10, then 10.

3 Press the numeric buttons to specify a desired file number.

The player starts slide show playback from the specified file.

If you do not specify a file, the player starts slide show playback from the first file in the group.

Repeat function

In the slide show mode, you can repeat playback of JPEG files in a group or on the disc.

1 While the JPEG CONTROL display is shown, press REPEAT.

Pressing REPEAT switches the repeat mode.

When the repeat mode is turned on, the [↺] indicator lights in the display window.

The selected repeat mode is shown on the JPEG CONTROL display.

REPEAT ALL: All files on the disc are repeated.

REPEAT GROUP: All files in the current group are repeated.

No indication: The repeat mode is off.

2 Press ► to start repeat playback.

To stop repeat playback

Press ■.

The repeat mode remains active.

To quit repeat playback

Press ■ or MENU while the JPEG CONTROL display is shown, and press REPEAT until the repeat mode indication goes off.

XV-NK58SL KARAOKE operation

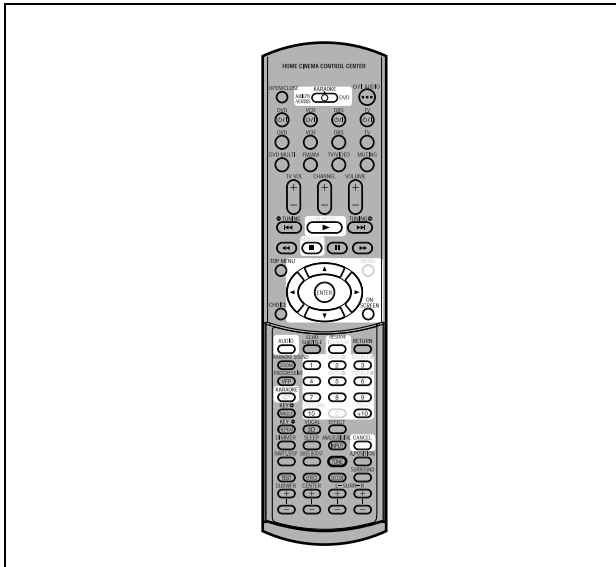

NOTE



When using the KARAOKE function, set the mode selector to "KARAOKE."

Preparation

Turning on the KARAOKE function



Press KARAOKE.

The KARAOKE function turns on, the [KARAOKE] indicator lights up on the display window, and the KARAOKE menu appears on the TV screen.

TV screen

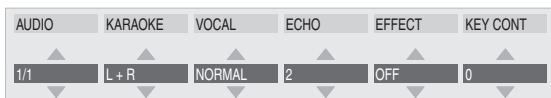

To turn on and off the KARAOKE menu

Press ON SCREEN.

Each time you press ON SCREEN, the KARAOKE menu appears and disappears, while the KARAOKE function remains active.

To deactivate the KARAOKE function

Press KARAOKE again.

The KARAOKE function is turned off, and the [KARAOKE] indicator goes off.

NOTES

- During program or random playback, you cannot turn on the KARAOKE function.
- When an MP3/WMA or JPEG disc is played back, the KARAOKE function cannot be turned on.
- When the KARAOKE menu is displayed on the TV screen, the DVD VIDEO disc picture cannot be manipulated with ▲/▼/◀/▶ on the remote control unit.
- The A-B repeat playback cannot be made when the KARAOKE function is turned on.

Connecting a microphone

Connect a microphone to the MIC jack on the front panel.



To adjust the microphone volume

Turn MIC LEVEL on the front panel.

Turning it clockwise raises the level, while turning it counter-clockwise lower the level.

NOTES

- When a DVD VIDEO, SVCD, Video CD or Audio CD disc is inserted, you can enjoy the input signal from the MIC jack with the DIGITAL OUT jacks.
- When the KARAOKE mode is turned on, "PCM ONLY" is forcibly applied to the type of the digital output signal, regardless of the [DIGITAL AUDIO OUTPUT] setting in the [AUDIO] preference (see page 59).
- While playback is stopped temporarily or while a DVD VIDEO disc is played in reverse slow motion, the input signal from the MIC jack is not output.

Reserving songs

You can reserve up to 12 songs to play in the desired order. You may reserve the same song more than once.

Playing back songs reserved



Turn on the KARAOKE function, and proceed as follows:

1 Press RESERVE.

The reservation table appears on the TV screen, and the [PRGM] indicator lights up in the display window.

2 Press the numeric buttons to specify tracks in the desired order.

To select 5: press 5.

To select 23: press +10, +10, then 3.

To select 40: press +10, +10, +10, then 10.

NO	Track
1	5
2	4
3	2
4	3
5	6
6	

To correct the reservation

Press ▲/▼ to move to the song to be corrected, then press CANCEL. The song is erased and the subsequent reserved songs move up.

Pressing clears all the reserved songs.

3 Press ►.

The player starts playback of the first reserved song.

A song which has started playback is deleted from the reservation table.

After playing back all reserved songs, the player stops.



To turn off and on the reservation table

Press RESERVE to turn off the reservation table. To turn on the reservation table, for example in order to check the reservation contents, press RESERVE again.

To reserve additional songs

Make sure that  points the next to the last song in the reservation table, and press the numeric buttons to select the song(s) you want to reserve.

To insert a song to be reserved

Press  to move  to the position where you want to insert a song, then press the numeric button to select the song you want to reserve.

NOTE

You cannot reserve songs during SVCD/Video CD playback with PBC. To reserve songs, press  before operating the above.

Selecting audio

Most KARAOKE discs have the capability of adding a "guide vocal" or "guide melody" to the KARAOKE accompaniment.

Selecting audio track (AUDIO)



With most DVD VIDEO or SVCD KARAOKE discs, you can choose an audio track that gives an option such as "with guide vocal," "with guide melody" and "accompaniment only."

Using the KARAOKE menu

See page 52 for how to turn on the KARAOKE menu.

- 1** Press  to move  to [AUDIO].
- 2** Press  to select the desired audio track to be played back.

Example for DVD VIDEO

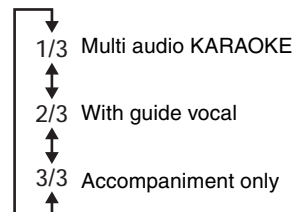

Example for SVCD

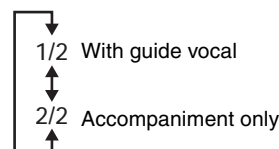



Using the AUDIO button

You can select an audio track without activating the KARAOKE menu.

- 1** Press AUDIO.

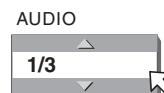
The [AUDIO] selection window appears on the TV screen.



- 2** Press  to select the desired audio track.
- 3** Press ENTER, or wait until the [AUDIO] selection window goes off.

KARAOKE operation

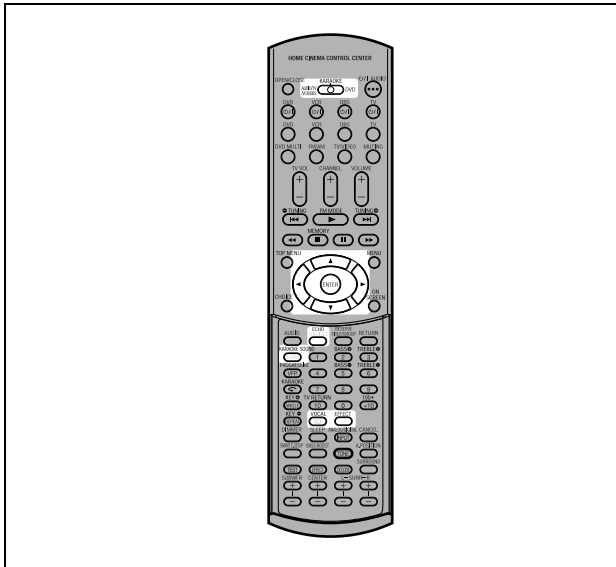

Example for SVCD, Video CD or Audio CD with KARAOKE

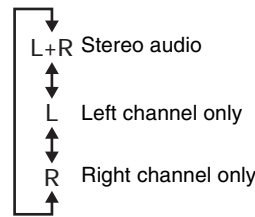

Using the KARAOKE SOUND button

You can select sound without activating the KARAOKE menu.

1 Press KARAOKE SOUND.

The [KARAOKE] selection window appears on the TV screen.

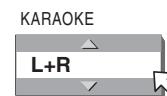

2 Press ▲/▼ to select the desired sound.

3 Press ENTER, or wait until the [KARAOKE] selection window goes off.

Selecting KARAOKE sound (KARAOKE SOUND)



Among KARAOKE DVD VIDEO discs, there are "multi-sound KARAOKE" discs. With such a disc, for example, you can sing along with the other vocal part recorded on a disc.

Using the KARAOKE menu

See page 52 for how to turn on the KARAOKE menu.

NOTES

- When playing back a "multi-sound KARAOKE" disc, [AUDIO] should be set to [1] (see page 53).
- With a DVD VIDEO disc which does not contain "multi-sound KARAOKE," the KARAOKE SOUND cannot be changed.

1 Press ◀▶ to move ↻ to [KARAOKE].

2 Press ▲/▼ to select the desired sound to be played back.

Example for multi-sound KARAOKE DVD VIDEO

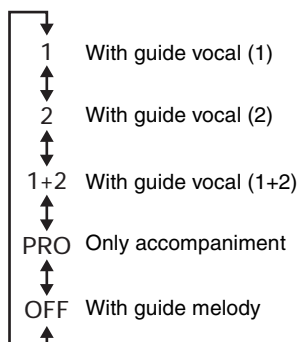

Using convenient functions for practicing KARAOKE (VOCAL)



You can mask a vocal recorded on normal non-KARAOKE discs, or have the guide vocal replace your voice automatically when you stop singing.

Using the KARAOKE menu

See page 52 for how to turn on the KARAOKE menu.

1 Press ◀▶ to move ↻ to [VOCAL].

2 Press ▲/▼ to select the desired function.



[NORMAL]: normal playback.

[MASK]: a vocal recorded on normal non-KARAOKE disc is masked.

[REPLACE]: the guide vocal automatically replaces your voice when you stop singing.

Using the VOCAL button

You can select a desired function without activating the KARAOKE menu.

1 Press VOCAL.

The [VOCAL] selection window appears on the TV screen.

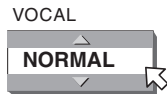

2 Press ▲/▼ to select the desired function.

3 Press ENTER, or wait until the [VOCAL] selection window goes off.

NOTES

- If [KARAOKE SOUND] is set to [L] or [R], the "MASK" and "REPLACE" functions do not work correctly.
- With some materials, such as those recorded in monaural and sung by multiple voices, the voice may not be satisfactorily masked.
- When playing back a disc with the multiplex audio or with multi-sound KARAOKE, the guide vocal is not played back at all. With other discs, the voice may not be satisfactorily masked.
- The "MASK" and "REPLACE" functions may not work with some SVCD and Video CD discs.

Adding an effect to your voice

You can add various effects to your voice using the echo and vocal effect functions.

Adding an echo effect (ECHO)



Using the KARAOKE menu

See page 52 for how to turn on the KARAOKE menu.

1 Press ◀▶ to move ⏏ to [ECHO].

2 Press ▲/▼ to adjust the echo level.

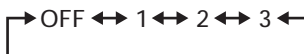

The higher the number, the stronger the echo effect.

Using the ECHO button

You can adjust the echo level without activating the KARAOKE menu.

1 Press ECHO.

The [ECHO] selection window appears on the TV screen.



2 Press ▲/▼ to adjust the echo level.

3 Press ENTER, or wait until the [ECHO] selection window goes off.

NOTE

If you select an effect (VOCAL EFFECT) after adjusting the echo level, the echo level will be reset to OFF.

Adding various effects to the vocal (VOCAL EFFECT)



Using the KARAOKE menu

See page 52 for how to turn on the KARAOKE menu.

1 Press ◀▶ to move ⏏ to [EFFECT].

2 Press ▲/▼ to select the desired effect.



[FLANGER]: adds a wet, metallic sweeping sound to your voice, similar to some electric guitar sounds.

[CHORUS]: produces a doubling effect on your vocal, as if another person is singing in unison.

Using the EFFECT button

You can select a desired vocal effect without activating the KARAOKE menu.

1 Press EFFECT.

The [EFFECT] selection window appears on the TV screen.

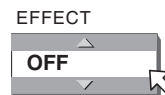

2 Press ▲/▼ to select the desired effect.

3 Press ENTER, or wait until the [EFFECT] selection window goes off.

NOTE

If you adjust the echo level after selecting an effect, the effect will be reset to OFF.

KARAOKE operation

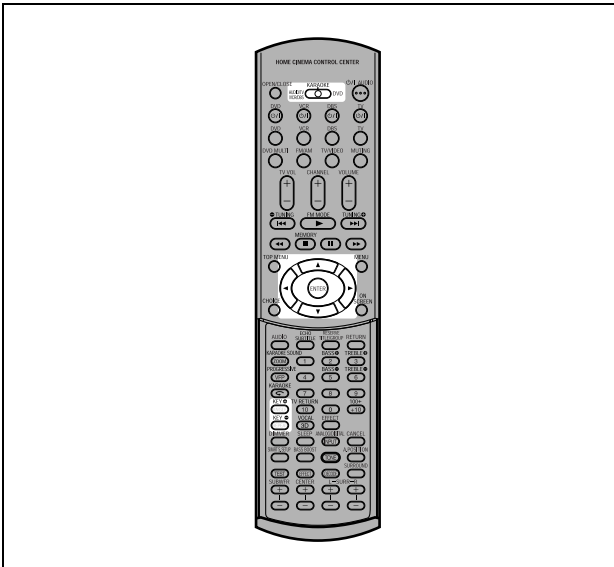

NOTES

- The key returns to the normal key after the current song ends.
- You cannot shift the musical key when playing back a disc listed below:
 - Audio CD with DTS
 - DVD with DTS
 - DVD with MPEG Multichannel
 - DVD with 96 kHz linear PCM

Shifting the musical key



You can shift the musical key of a song recorded on a disc to fit to your voice.

Using the KARAOKE menu

See page 52 for how to turn on the KARAOKE menu.

- 1** Press to move to [KEY CONT].
- 2** Press to raise up the key, and to drop down the key.

The adjustable range is from -4 to +4.

Using the KEY /KEY buttons

You can shift the musical key without activating the KARAOKE menu.

- 1** Press KEY or KEY .
- The [KEY CONT] selection window appears on the TV screen.

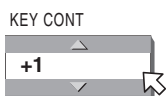

- 2** Press KEY /KEY to raise up or drop down the key.
- 3** Press ENTER, or wait until the [KEY CONT] selection window goes off.

XV-NK58SL

Changing the initial settings

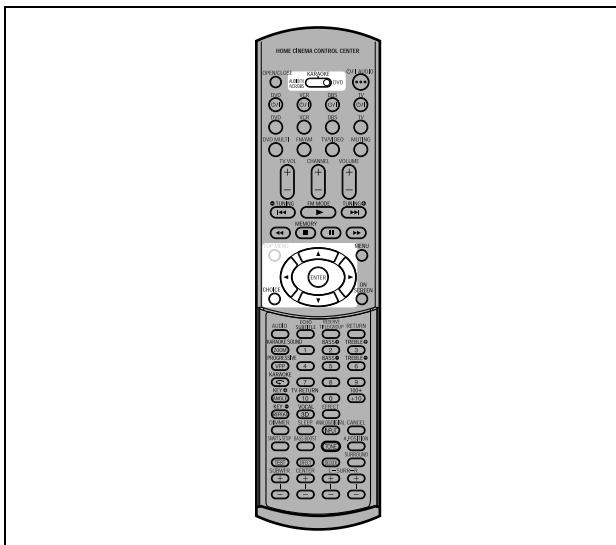

NOTES



- When operating the player, set the mode selector to "DVD."
- If the KARAOKE function is turned on, you cannot change the initial settings. Before changing the initial settings, be sure to turn off the KARAOKE function and set the mode selector to "DVD."

Selecting preferences

This section refers to the settings which are already made when you purchase the player. Read this section when you want to connect this player to a wide-vision TV set, or when you want to otherwise change the settings according to your preferences and viewing environment.

About the Preference display

The Preference display consists of the LANGUAGE, PICTURE, AUDIO and OTHERS setting displays, each having setting items.

LANGUAGE

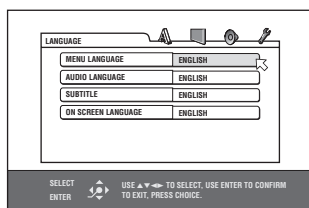

PICTURE

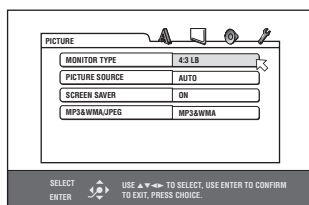

AUDIO

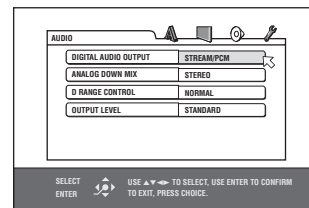

OTHERS

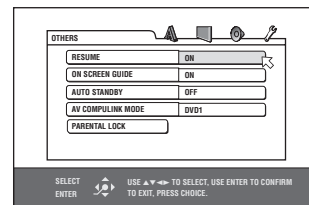

How to set preferences

1 Press CHOICE.

One of the preference on-screen displays appears on the TV screen.

You can see four icons at the top right of the on-screen display for the settings.

: LANGUAGE menu

: PICTURE menu

: AUDIO menu

: OTHERS menu

2 Press ◀▶ to select the appropriate icon.

The appropriate display appears on the TV screen.

3 Press ▲/▼ to move to select the item you want to edit.

The color of the selected item changes.

4 Press ENTER.

A pull-down menu appears over the selected item.

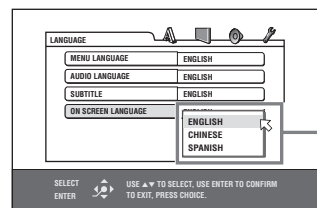

Selected item

5 Press ▲/▼ to select from the options then press ENTER.

The selected option is set.

- For details about each setting, see the following.

To dismiss a preference display

Press CHOICE.

NOTES

- While an MP3/WMA or JPEG disc is inserted, you cannot bring up any preference display.
- When a preference display is shown on a wide TV screen, the upper and lower parts of the preference display sometimes may be cut off. If this happens, adjust the picture size control of the TV.

Changing the initial settings

LANGUAGE menu

MENU LANGUAGE

You can select the default menu language to be displayed if it is contained on a DVD VIDEO disc.

Setting options

ENGLISH, SPANISH, FRENCH, CHINESE, GERMAN, ITALIAN, JAPANESE, language code from AA to ZU

- If the disc does not have a menu in the selected language, the disc's default language will be used.
- For details about language codes, see "Appendix B: Table of languages and their abbreviations" on page 63.
- You cannot change the setting during playback.

AUDIO LANGUAGE

You can select the default audio language to be played if it is contained on a DVD VIDEO disc.

Setting options

ENGLISH, SPANISH, FRENCH, CHINESE, GERMAN, ITALIAN, JAPANESE, language code from AA to ZU

- If the disc does not have the selected language, the disc's default language will be used.
- For details about language codes, see "Appendix B: Table of languages and their abbreviations" on page 63.
- You cannot change the setting during playback.

SUBTITLE

You can select the default subtitle language to be displayed if it is contained on a DVD VIDEO disc.

Setting options

OFF, ENGLISH, SPANISH, FRENCH, CHINESE, GERMAN, ITALIAN, JAPANESE, language code from AA to ZU

- If the disc does not have a subtitle in the selected language, the disc's default language will be used.
- For details about language codes, see "Appendix B: Table of languages and their abbreviations" on page 63.
- You cannot change the setting during playback.

ON SCREEN LANGUAGE

You can select the on-screen display language of the player.

Setting options

ENGLISH, CHINESE, SPANISH

- Some on-screen messages are shown in English regardless of the setting.
- You cannot change the on-screen language shown on the MP3 display.

PICTURE menu

MONITOR TYPE

You can select the monitor type to match your TV when you play back DVD VIDEO discs recorded for wide-screen televisions.

Setting options

16:9 NORMAL, 16:9 AUTO, 4:3 LB, 4:3 PS, 16:9 MULTI NORMAL, 16:9 MULTI AUTO, 4:3 MULTI LB, 4:3 MULTI PS

[16:9 NORMAL] (Wide television screen): select when you connect the player to a wide-screen (16:9) TV whose aspect ratio is fixed to 16:9 (the player automatically adjusts the screen width of the output signal correctly when playing back a 4:3 source).

If you play a 4:3 DVD VIDEO source using the [16:9 NORMAL] mode, the picture character changes slightly due to the process for converting the picture width.

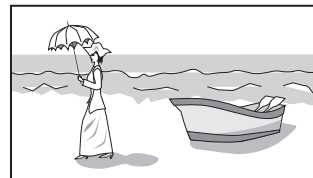

[16:9 AUTO] (Wide television screen): select when you connect the player to a wide-screen (16:9) TV.

[4:3 LB] (Letter Box conversion): select when you connect the player to a normal (4:3) TV.

When playing back a DVD VIDEO disc recorded in wide picture format, the picture is shown with black bars at the top and bottom.



[4:3 PS] (Pan Scan conversion): select when you connect the player to a normal (4:3) TV.

When playing back a DVD VIDEO disc recorded in wide picture format, the picture is zoomed to fill the screen vertically, and the left and right sides of the image are chopped off.

Note, however, that the picture will be shown in the 4:3 LB mode even if you select the 4:3 PS mode depending on the disc.

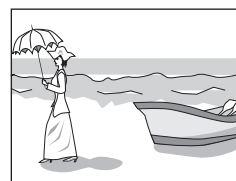

[16:9 MULTI NORMAL] [16:9 MULTI AUTO]

[4:3 MULTI LB] [4:3 MULTI PS]: These "MULTI" options should be selected when you connect the unit to a TV that supports both the PAL and NTSC systems. If you select one of these options, the unit outputs a PAL or NTSC video signal according to the disc, regardless of the PAL/NTSC selector setting.

PICTURE SOURCE

This mode selects whether the content on the disc is processed by field (video source) or by frame (film source). You can obtain optimal picture quality according to the source type to be played back by selecting an appropriate option. This setting is available for both the interlaced mode and progressive scanning mode.

Setting options

AUTO, FILM, VIDEO(NORMAL), VIDEO(ACTIVE)

[AUTO]: select when playing back a disc containing both video and film source materials.

The player recognizes the picture type (film or video source) of the current disc according to the disc information. Normally, select this option.

[FILM]: select when playing back a film source disc.

[VIDEO(NORMAL)]: select when playing back a video source disc with relatively a few movements.

[VIDEO(ACTIVE)]: select when playing back a video source disc with relatively a lot of movements.

SCREEN SAVER

You can set the screen saver function to ON or OFF. (See page 38.)

Setting options

ON, OFF

MP3&WMA/JPEG

The player can play MP3/WMA and JPEG files recorded on a CD-R/CD-RW disc. However, if a disc contains both MP3/WMA and JPEG files, you can only play files of the type selected in this menu item.

Setting options

MP3&WMA, JPEG

[MP3&WMA]: when selected, only MP3/WMA files can be played back.

[JPEG]: when selected, only JPEG files can be played back.

AUDIO menu

DIGITAL AUDIO OUTPUT

To connect the player's digital output to an external device equipped with a digital input, this item must be set correctly. See "Appendix C: Digital output signal chart" on page 63 for details about the relation between the setting and output signals.

Setting options

PCM ONLY, DOLBY DIGITAL/PCM, STREAM/PCM

[PCM ONLY]: select when you connect the DIGITAL OUT jack of the player to the linear PCM digital input of other audio equipment.

[DOLBY DIGITAL/PCM]: select when you connect the digital input of a Dolby Digital decoder or an amplifier with a built-in Dolby Digital decoder.

When this option is selected, playing back a disc recorded by the MPEG Multichannel format outputs a linear PCM digital signal.

[STREAM/PCM]: select when you connect the digital input of an amplifier with a built-in DTS, MPEG Multichannel or Dolby Digital decoder, or the stand-alone unit of such a decoder.

- With some DVD VIDEO discs that are not fully copy-protected, a 20 or 24 bit digital signal may be output.
- A signal recorded with the 96 kHz or higher sampling frequency is output from the DIGITAL OUT jack with the 48 kHz sampling frequency.
- When playing a DVD VIDEO or Audio CD disc with DTS, use a DTS decoder to get correct signals from your speakers.

ANALOG DOWN MIX

To correctly play the audio on a DVD VIDEO disc recorded with surround multichannel audio, you must set this item properly according to your audio system configuration. (This function does not work when the 3D PHONIC function is activated.)

Setting options

DOLBY SURROUND, STEREO

[DOLBY SURROUND]: select when listening to multichannel surround audio with the player's analog AUDIO OUT terminals connected to a surround decoder.

[STEREO]: select when listening to conventional two-channel stereo audio with the player's AUDIO OUT terminals connected to a stereo amplifier/receiver or television set, or in case you want to record the audio from a DVD VIDEO disc to MiniDisc, cassette, etc.

D. RANGE CONTROL

This setting provides optimal audio quality from the analog AUDIO OUT terminals for listening to DVD VIDEO discs recorded in Dolby Digital format, at low or middle volume.

Setting options

WIDE RANGE, NORMAL, TV MODE

[WIDE RANGE]: when selected, audio is played back with the widest dynamic range so that you can enjoy powerful playback sound.

[NORMAL]: normally, select this option.

[TV MODE]: select if DVD VIDEO disc sound level is lower than

TV program sound level. Thus you can hear sound at a lower volume clearly.

OUTPUT LEVEL

This setting allows you to attenuate the level of the signal output from the player's analog AUDIO OUT terminals.

Setting options

STANDARD, LOW

- If the sound output from the speaker is distorted, select [LOW].

OTHERS menu

RESUME

You can select the resume playback mode.

See pages 36 and 37 for details about the resume playback function.

Setting options

ON, OFF, DISC RESUME



[ON]: when selected, the player can resume playback of the disc from the position where playback was last interrupted, if the disc is still in the disc tray.

[OFF]: when selected, the resume function is deactivated.

[DISC RESUME]: when selected, the player can resume playback of the last 30 discs played. The player retains a memory of the interrupted positions of the last 30 discs played, even though they have been removed from the disc tray.

ON SCREEN GUIDE

The player can display "on-screen guide" icons or characters on the picture, which show what is happening to the disc or the player.

Example of "on-screen guide" icons:  ,  , 

Setting options

ON, OFF

[ON]: when selected, the on-screen guide is activated.

AUTO STANDBY

When the player is stopped for more than 30 minutes or 60 minutes, the player enters standby mode automatically.

Setting options

60, 30, OFF

AV COMPULINK MODE

You must set this item correctly to use the AV COMPU LINK system.

Setting options

DVD1, DVD2, DVD3

- See page 65 for details about the AV COMPU LINK function.

Changing the initial settings

PARENTAL LOCK

When this option is selected, pressing ENTER on the remote control unit brings up the PARENTAL LOCK display shown below. This allows you to restrict children from playing DVD VIDEO discs.

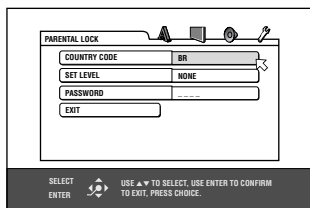

- See this page for details about the parental lock setting.

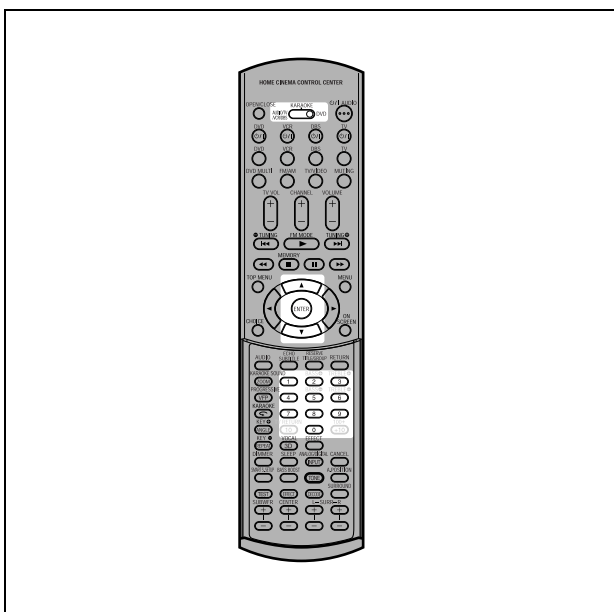

Limiting playback by children

This function restricts playback of DVD VIDEO discs which contain violent (and other) scenes according to the level set by the user. For example, if a movie which includes violent scenes supports the parental lock feature, such scenes which you do not want to let children view can be cut or replaced with other scenes.

To set Parental Lock for the first time



- 1 Bring up the OTHERS menu.
- 2 Press ▲/▼ to move  to select [PARENTAL LOCK] then press ENTER.

The Parental Lock on-screen display appears on the TV screen.

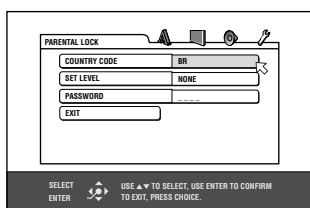

- 3 While  is pointing to [COUNTRY CODE], press ENTER to bring up the pull-down menu.

- 4 Press ▲/▼ to select the country code.

Select the code of the country whose standards were used to rate the DVD VIDEO disc content.

See "Appendix A: Country/Area code list for Parental Lock" on page 62.

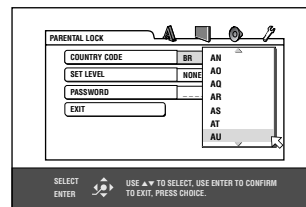

- 5 Press ENTER.

 moves to [SET LEVEL].

- 6 Press ENTER to bring up the pull-down menu.

In the pull-down menu, [NONE] and levels [8] to [1] are available.

[NONE] does not restrict playback. Level [1] is the strictest level. Discs rated higher than the selected level are restricted.

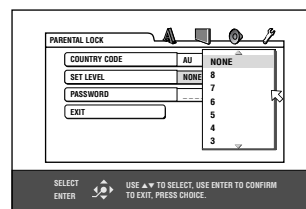

- 7 Press ▲/▼ to select a desired parental lock level, then press ENTER.

 moves to [PASSWORD].

- 8 Press the numeric buttons (0 to 9) to enter a 4-digit password.

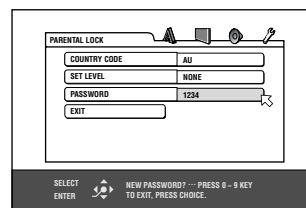

- 9 Press ENTER.

The parental lock feature is set.

 moves to [EXIT]. Pressing ENTER again returns to the [OTHERS] menu of the preference display.

Hint

If you want to change the password at step 8, do it before pressing ENTER.

To change the settings



You can change the parental lock settings later.

- 1 Bring up the OTHERS menu.
- 2 Press ▲/▼ to move to select [PARENTAL LOCK] and press ENTER.

The parental lock on-screen display appears on the TV screen.

- 3 While is pointing to [PASSWORD], press the numeric buttons to enter your current 4-digit password then press ENTER.

moves to [COUNTRY CODE] if you enter the correct password.

If you enter a wrong password, "WRONG! RETRY..." appears on the TV screen, and you cannot go to the next step.

If you forget your password, enter "8888." The current password is deleted and you can set a new password.

- 4 To change the [COUNTRY CODE] or [SET LEVEL], press ENTER to bring up the associated pull-down menu when is pointing to the desired item.

- 5 Press ▲/▼ to select the desired option then press ENTER.

If you change the country code, you must reselect the parental lock level.

- 6 While is pointing to [PASSWORD], press the numeric buttons to enter a 4-digit password.

The password entered in this step becomes the new password. If you want to keep the same password as before, enter the same password.

- 7 Press ENTER.

moves to [EXIT]. Pressing ENTER again returns to the [OTHERS] menu of the preference display.

NOTE

If you enter the wrong password more than 3 times in step 3 above, moves to [EXIT] automatically and ▲/▼ do not work.

To temporarily release the Parental Lock



If the parental level is set to a strict value, some discs may not play at all.

When you insert such a disc and try to play it, the following parental lock on-screen display appears on the TV screen, asking you whether you want the parental lock to be temporarily released or not.

- 1 Press ▲/▼ to move to [TEMPORARY RELEASE], then press ENTER.

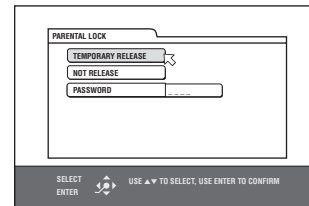

- 2 Press the numeric buttons (0 to 9) to enter your 4-digit password.

The Parental Lock is released, and the player starts playback.

If you enter a wrong password, "WRONG! RETRY..." appears on the TV screen. Enter the correct password.

NOTE

When you enter the wrong password 3 times at step 2 above, moves to [NOT RELEASE] automatically and ▲/▼ do not work.

XV-NK58SL

Additional information

Appendix A: Country/Area code list for Parental Lock

(for page 60)

AD	Andorra
AE	United Arab Emirates
AF	Afghanistan
AG	Antigua and Barbuda
AI	Anguilla
AL	Albania
AM	Armenia
AN	Netherlands Antilles
AO	Angola
AQ	Antarctica
AR	Argentina
AS	American Samoa
AT	Austria
AU	Australia
AW	Aruba
AZ	Azerbaijan
BA	Bosnia and Herzegovina
BB	Barbados
BD	Bangladesh
BE	Belgium
BF	Burkina Faso
BG	Bulgaria
BH	Bahrain
BI	Burundi
BJ	Benin
BM	Bermuda
BN	Brunei Darussalam
BO	Bolivia
BR	Brazil
BS	Bahamas
BT	Bhutan
BV	Bouvet Island
BW	Botswana
BY	Belarus
BZ	Belize
CA	Canada
CC	Cocos (Keeling) Islands
CF	Central African Republic
CG	Congo
CH	Switzerland
CI	Côte d'Ivoire
CK	Cook Islands
CL	Chile
CM	Cameroon
CN	China
CO	Colombia
CR	Costa Rica
CU	Cuba
CV	Cape Verde
CX	Christmas Island
CY	Cyprus
CZ	Czech Republic
DE	Germany
DJ	Djibouti
DK	Denmark
DM	Dominica
DO	Dominican Republic
DZ	Algeria
EC	Ecuador
EE	Estonia
EG	Egypt
EH	Western Sahara
ER	Eritrea

ES	Spain
ET	Ethiopia
FI	Finland
FJ	Fiji
FK	Falkland Islands
FM	Micronesia (Federated States of)
FO	Faroe Islands
FR	France
FX	France, Metropolitan
GA	Gabon
GB	United Kingdom
GD	Grenada
GE	Georgia
GF	French Guiana
GH	Ghana
GI	Gibraltar
GL	Greenland
GM	Gambia
GN	Guinea
GP	Guadeloupe
GQ	Equatorial Guinea
GR	Greece
GS	South Georgia and the South Sandwich
GT	Guatemala
GU	Guam
GW	Guinea-Bissau
GY	Guyana
HK	Hong Kong
HM	Heard Island and McDonald Islands
HN	Honduras
HR	Croatia
HT	Haiti
HU	Hungary
ID	Indonesia
IE	Ireland
IL	Israel
IN	India
IO	British Indian Ocean Territory
IQ	Iraq
IR	Iran (Islamic Republic of)
IS	Iceland
IT	Italy
JM	Jamaica
JO	Jordan
JP	Japan
KE	Kenya
KG	Kyrgyzstan
KH	Cambodia
KI	Kiribati
KM	Comoros
KN	Saint Kitts and Nevis
KP	Korea, Democratic People's Republic of
KR	Korea, Republic of
KW	Kuwait
KY	Cayman Islands
KZ	Kazakhstan
LA	Lao People's Democratic Republic
LB	Lebanon
LC	Saint Lucia

LI	Liechtenstein
LK	Sri Lanka
LR	Liberia
LS	Lesotho
LT	Lithuania
LU	Luxembourg
LV	Latvia
LY	Libyan Arab Jamahiriya
MA	Morocco
MC	Monaco
MD	Moldova, Republic of
MG	Madagascar
MH	Marshall Islands
ML	Mali
MM	Myanmar
MN	Mongolia
MO	Macau
MP	Northern Mariana Islands
MQ	Martinique
MR	Mauritania
MS	Montserrat
MT	Malta
MU	Mauritius
MV	Maldives
MW	Malawi
MX	Mexico
MY	Malaysia
MZ	Mozambique
NA	Namibia
NC	New Caledonia
NE	Niger
NF	Norfolk Island
NG	Nigeria
NI	Nicaragua
NL	Netherlands
NO	Norway
NP	Nepal
NR	Nauru
NU	Niue
NZ	New Zealand
OM	Oman
PA	Panama
PE	Peru
PF	French Polynesia
PG	Papua New Guinea
PH	Philippines
PK	Pakistan
PL	Poland
PM	Saint Pierre and Miquelon
PN	Pitcairn
PR	Puerto Rico
PT	Portugal
PW	Palau
PY	Paraguay
QA	Qatar
RE	Réunion
RO	Romania
RU	Russian Federation
RW	Rwanda
SA	Saudi Arabia
SB	Solomon Islands
SC	Seychelles
SD	Sudan

SE	Sweden
SG	Singapore
SH	Saint Helena
SI	Slovenia
SJ	Svalbard and Jan Mayen
SK	Slovakia
SL	Sierra Leone
SM	San Marino
SN	Senegal
SO	Somalia
SR	Suriname
ST	Sao Tome and Principe
SV	El Salvador
SY	Syrian Arab Republic
SZ	Swaziland
TC	Turks and Caicos Islands
TD	Chad
TF	French Southern Territories
TG	Togo
TH	Thailand
TJ	Tajikistan
TK	Tokelau
TM	Turkmenistan
TN	Tunisia
TO	Tonga
TP	East Timor
TR	Turkey
TT	Trinidad and Tobago
TV	Tuvalu
TW	Taiwan
TZ	Tanzania, United Republic of
UA	Ukraine
UG	Uganda
UM	United States Minor Outlying Islands
US	United States
UY	Uruguay
UZ	Uzbekistan
VA	Vatican City State (Holy See)
VC	Saint Vincent and the Grenadines
VE	Venezuela
VG	Virgin Islands (British)
VI	Virgin Islands (U.S.)
VN	Vietnam
VU	Vanuatu
WF	Wallis and Futuna Islands
WS	Samoa
YE	Yemen
YT	Mayotte
YU	Yugoslavia
ZA	South Africa
ZM	Zambia
ZR	Zaire
ZW	Zimbabwe

Appendix B: Table of languages and their abbreviations

(for pages 43 and 58)

AA	Afar	FA	Persian	KM	Cambodian	OM	(Afan) Oromo	SU	Sundanese
AB	Abkhazian	FI	Finnish	KN	Kannada	OR	Oriya	SV	Swedish
AF	Afrikaans	FJ	Fiji	KO	Korean (KOR)	PA	Panjabi	SW	Swahili
AM	Ameharic	FO	Faroese	KS	Kashmiri	PL	Polish	TA	Tamil
AR	Arabic	FY	Frisian	KU	Kurdish	PS	Pashto, Pushto	TE	Telugu
AS	Assamese	GA	Irish	KY	Kirghiz	PT	Portuguese	TG	Tajik
AY	Aymara	GD	Scots Gaelic	LA	Latin	QU	Quechua	TH	Thai
AZ	Azerbaijani	GL	Galician	LN	Lingala	RM	Rhaeto-Romance	TI	Tigrinya
BA	Bashkir	GN	Guarani	LO	Laothian	RN	Kirundi	TK	Turkmen
BE	Byelorussian	GU	Gujarati	LT	Lithuanian	RO	Rumanian	TL	Tagalog
BG	Bulgarian	HA	Hausa	LV	Latvian, Lettish	RU	Russian	TN	Setswana
BH	Bihari	HI	Hindi	MG	Malagasy	RW	Kinyarwanda	TO	Tongan
BI	Bislama	HR	Croatian	MI	Maori	SA	Sanskrit	TR	Turkish
BN	Bengali, Bangla	HU	Hungarian	MK	Macedonian	SD	Sindhi	TS	Tsonga
BO	Tibetan	HY	Armenian	ML	Malayalam	SG	Sangho	TT	Tatar
BR	Breton	IA	Interlingua	MN	Mongolian	SH	Serbo-Croatian	TW	Twi
CA	Catalan	IE	Interlingue	MO	Moldavian	SI	Singhalese	UK	Ukrainian
CO	Corsican	IK	Inupiak	MR	Marathi	SK	Slovak	UR	Urdu
CS	Czech	IN	Indonesian	MS	Malay (MAY)	SL	Slovenian	UZ	Uzbek
CY	Welsh	IS	Icelandic	MT	Maltese	SM	Samoan	VI	Vietnamese
DA	Danish	IW	Hebrew	MY	Burmese	SN	Shona	VO	Volapuk
DZ	Bhutani	JI	Yiddish	NA	Nauru	SO	Somali	WO	Wolof
EL	Greek	JW	Javanese	NE	Nepali	SQ	Albanian	XH	Xhosa
EO	Esperanto	KA	Georgian	NL	Dutch	SR	Serbian	YO	Yoruba
ET	Estonian	KK	Kazakh	NO	Norwegian	SS	Siswati	ZU	Zulu
EU	Basque	KL	Greenlandic	OC	Occitan	ST	Sesotho		

Appendix C: Digital output signal chart

(for page 59)

Disc type	Output		
	PCM ONLY	DOLBY DIGITAL/PCM	STREAM/PCM
DVD with 48 kHz, 16/20/24 bit linear PCM	48 kHz, 16 bit, stereo linear PCM		
DVD with 96 kHz, 16/22/24 bit linear PCM	48kHz, 16 bit, stereo linear PCM (Down sampling)		
DVD with DTS	48kHz, 16 bit, stereo linear PCM	DTS bitstream	
DVD with Dolby Digital	48 kHz, 16 bit, stereo linear PCM	Dolby Digital bitstream	
DVD with MPEG Multichannel	48 kHz, 16 bit, stereo linear PCM	MPEG bitstream	
SVCD/Video CD/Audio CD	44.1 kHz, 16 bit, stereo linear PCM		
Audio CD with DTS	48kHz, 16 bit, stereo linear PCM	DTS bitstream	
CD-R/RW with MP3/WMA	No output		
Any disc with KARAOKE mode	48/44.1 kHz, 16 bit, stereo linear PCM		

Appendix D: Glossary

525i/525p

Indicates the number of scanning lines and scanning format of an image signal. 525i indicates 525 scanning lines with interlace format, and 525p indicates 525 scanning lines with progressive format.

Aspect ratio

A ratio which defines the shape of the rectangular picture in a TV. It is the width of the picture relative to the height. A conventional TV picture is 4:3 in aspect ratio.

Bitstream

The digital form of multichannel audio data (e.g., 5.1-channel) before it is decoded into its various channels.

Chapter/title

Chapter is the smallest division and title is the largest division on DVD VIDEO. A chapter is a division of a title and similar to a track for Video CD or Audio CD.

Component video

Video signals with three channels of separate information that makes up the picture. There are some types of component video, such as R/G/B and Y/C_B(P_B)/C_R(P_R).

Composite video

A single video signal commonly used in most consumer video products that contains all luminance, color, and synchronization information.

Dolby Digital (AC3)

A six-channel system consisting of left, center, right, left rear, right rear and LFE (Low-Frequency Effect channel, for use with a sub-woofer) channels. All processing is done in the digital domain. Not all Dolby Digital discs contain six (5.1) channels of information.

Dolby Surround/Dolby Pro Logic

Dolby Surround records four channels of front and rear audio in two channels in a way that allows a decoder to recover the original four channels for playback. Because the audio is recorded in two channels, it can be played back naturally by a two-channel stereo system. Dolby Pro Logic introduces directional circuits in decoder-side processing (increasing the level of specific channels and lowering the level of silent channels) for greater spatial perspective, and adds a center speaker used primarily for dialog. The result is enhanced channel separation.

Down-mix

Internal stereo mix of multichannel surround audio by a DVD player. The down-mix signals are output from stereo output connectors.

DTS

A Digital Surround audio encoding format configured with six (5.1) channels, similar to Dolby Digital. It requires a decoder, either in the player or in an external receiver. DTS stands for Digital Theater Systems. Not all DTS discs contain six (5.1) channels of information.

Dynamic range

The difference between the loudest and softest sounds.

Interlaced scanning

In a conventional video system, a picture is shown on the display monitor in between lines of two halves. The Interlaced scanning system places lines of the second half of the picture in-between lines of the first half of the picture.

JPEG

A popular file format for still image compression and storage. JPEG stands for Joint Photographic Experts Group. There are three sub-types of the JPEG format as follows.

- baseline JPEG: used for digital cameras, the web, etc.
- progressive JPEG: used for the web
- lossless JPEG: an old type, rarely used now

Linear PCM audio

PCM stands for "pulse code modulation." Linear PCM is the usual method for digitally encoding audio without compression, and is used for the audio tracks on DVD VIDEO discs, Audio CDs, etc.

MP3

MP3 is an audio data compression format, which stands for MPEG-1 Audio Layer 3. Using MP3, you can achieve a data reduction of about 1:10.

MPEG

A family of Standards for compressing audio-visual information. "MPEG" standards include MPEG-1, MPEG-2 and MPEG-4. Video CD and MP3 are based on MPEG-1, while DVD is based on MPEG-2. MPEG stands for Moving Picture coding Experts Group.

MPEG Multichannel

This feature expands the 5.1 channel audio format recorded on the disc to a 7.1 channel format. The further expansion of the 5.1 channel audio makes it easy for you to reproduce the movie theater experience in your own home.

NTSC (National television system committee)

A black and white and color television system format used in the U.S.A., Canada, Mexico and Japan.

PAL (Phase Alternation by Line)

A color television system format used extensively in Western Europe.

PBC

PBC stands for "Playback control" and is a method of controlling disc play for Video CDs (VCD). You are able to interact with the disc through menus.

Progressive scanning

Progressive scanning displays all the horizontal lines of a picture at one time, as a single frame. A progressive scanning DVD player converts the interlaced (525i) video from DVD into progressive (525p) format for connection to a progressive display. It dramatically increases the vertical resolution.

S-video

A video signal which improves picture quality over standard composite connections. Used on Super VHS, DVD, high end TV monitors, etc.

Track

The smallest division on SVCD, Video CD and Audio CD discs.

WMA

WMA is an abbreviation of "Windows Media Audio," and is an audio data compression format developed by Microsoft Corporation. Sound quality of data compressed using WMA is the same as that of MP3, though the WMA file size is smaller than that of MP3.

AV COMPU LINK remote control system

The AV COMPU LINK remote control system allows you to operate JVC's video components (TV, DVD player and VCR) through this receiver.

This receiver is equipped with the AV COMPU LINK-III, which has added a function to operate JVC's video components through the video components terminals. To use this remote control system, you need to connect the video components you want to operate, following the diagrams below and the procedures on page 66.

- Refer also to the manuals supplied with your video components.

CONNECTIONS 1: AV COMPU LINK Connection

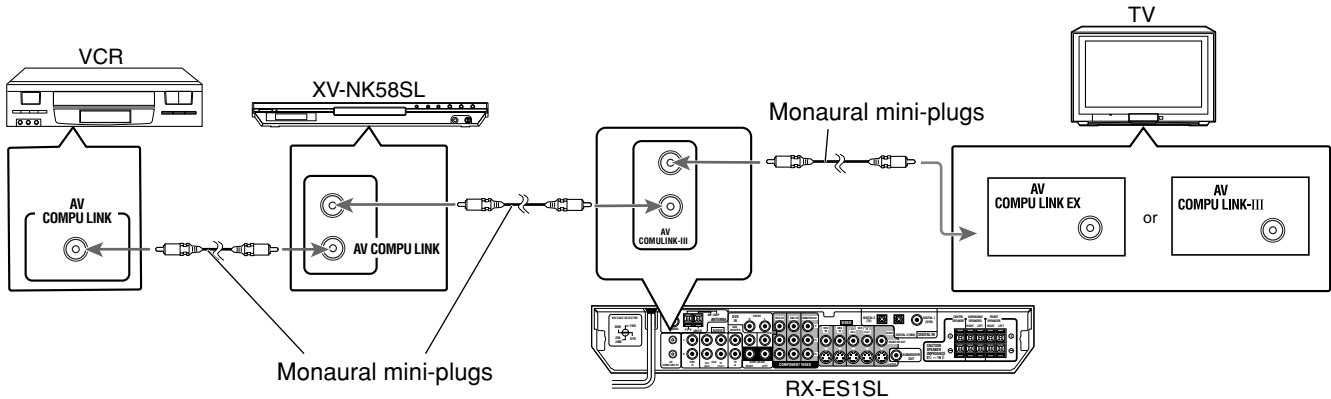

IMPORTANT:

The AV COMPU LINK remote control system cannot control the DBS tuner connected to the DBS terminals.

CAUTION:

When connecting the TV with the AV COMPU LINK remote control system, connect the receiver to the AV COMPU LINK EX or AV COMPU LINK-III terminal. DO NOT connect the receiver to the AV COMPU LINK RECEIVER/AMP terminal.

NOTES

- When connecting the receiver and a TV with the AV COMPU LINK EX terminal by using a component video cable, you cannot use Automatic selection of TV's input mode (see page 66).
- When connecting the XV-NK58SL or VCR and TV to this receiver, connect it directly to the receiver using cable with monaural mini-plugs.

CONNECTIONS 2: Video Cable Connection

This receiver is equipped with three types of the video terminals—composite video, S-video, and component video, and the signals coming into this receiver through one type of video terminals can output only through the terminal of the same type. So you need to connect the VCR and TV to this receiver using one of the following three ways.

- When using the AV COMPU LINK remote control system, set the component video input for the DVD player and the DBS tuner correctly (see "Setting the video component input mode—DVD VIDEO/DBS VIDEO" on page 21); otherwise, the correct input for this receiver will not be selected on the TV.

CASE 1: When connecting the source equipment to the receiver through the S-video terminals, connect this receiver to the TV's Video Input 1 terminal using S-video cords.

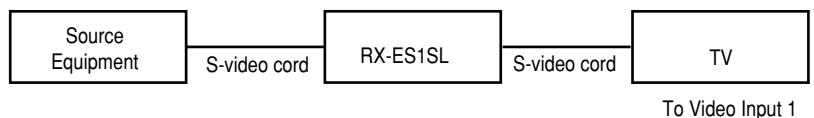

CASE 2: When connecting the source equipment to the receiver through the composite video terminals, connect this receiver to the TV's Video Input 2 terminal (composite video input) using composite video cords.

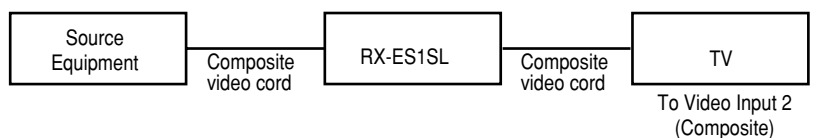

CASE 3: When connecting the source equipment to the receiver through the component video terminals, connect this receiver to the TV's Video Input 2 terminals (component video input) using component video cords.

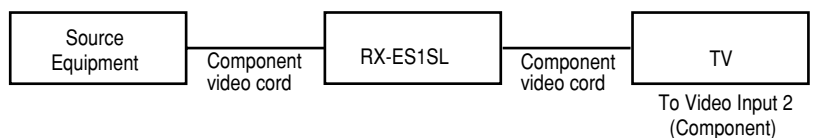

CONTINUED ON THE NEXT PAGE

- 1. If you have already plugged your VCR, DVD player, TV and this receiver into the AC outlets, unplug their AC power cords first.**
- 2. Connect your VCR, DVD player, TV and this receiver, using the cords with the monaural mini-plugs (not supplied).**
 - See "CONNECTIONS 1" on the previous page.
- 3. Connect the audio input/output terminals on VCR, DVD player, TV and this receiver using the audio cords with RCA pin plugs.**
 - See pages 8 to 11.
- 4. Connect the video input/output terminals on VCR, DVD player, TV and this receiver, using the cords with RCA pin plugs, S-video plug or component video plugs.**
 - See "CONNECTIONS 2" on the previous page.
- 5. Plug the AC power cords of the components and the receiver into the AC outlets.**
- 6. When turning on the TV for the first time after the AV COMPU LINK connection, turn the TV volume to the minimum using the TV volume control on the TV.**
- 7. Turn on the connected components first, then turn on this receiver.**
 - When turning on the VCR, use the remote control supplied with this receiver (press VCR).

The AV COMPU LINK remote control system allows you to use the five basic functions listed below.

Remote control of the TV, DVD player, and VCR using this remote control

See page 67 for details.

- Aim the remote control directly at **the remote sensor on each target component.**

One-touch video play

Simply by inserting a video cassette without its safety tab into the VCR, you can enjoy the video playback without setting other switches manually. The receiver automatically turns on and changes the source to "VCR."

The TV automatically turns on and changes the input mode to the appropriate position so that you can view the playback picture.

When you insert a video cassette with its safety tab, press the play (▶) button on the VCR or on the remote control. So, you can get the same result.

One-touch DVD play

Simply by starting playback on the DVD player, you can enjoy the DVD playback without setting other switches manually.

- When the DVD player is connected through the analog input jacks on this receiver (and analog input is selected), the receiver automatically turns on and changes the source to "DVD" or "DVD MULTI."
- When the DVD player is connected through the digital input terminal on this receiver (and digital input is selected), the receiver automatically turns on and changes the source to "DVD."

The TV automatically turns on and changes the input mode to the appropriate position so that you can view the playback picture.

Automatic selection of TV's input mode

- When you select "TV" as the source to play on the receiver, the TV automatically changes the input mode to the TV tuner so that you can watch TV.
- When you select "DVD," "DVD MULTI," "VCR" or "DBS" as the source to play on the receiver, the TV automatically changes the input mode to the appropriate position (either Video Input 1 or Video Input 2) so that you can view the playback picture.

NOTE

This function does not work when you connect this receiver and the TV with the AV COMPU LINK using the TV's AV COMPU LINK EX terminal. In this case, reconnect the TV referring to case 1 or case 2 on page 65.

Automatic power On/Off

The TV, VCR, and DVD player turn on and off along with the receiver.

When you turn on the receiver;

- If the previously selected source is "VCR," the TV and VCR will turn on automatically.
- If the previously selected source is "DVD" or "DVD MULTI," the TV and DVD player will turn on automatically.
- If the previously selected source is "TV" or "DBS," only the TV will turn on automatically.

When you turn off the receiver, the TV, VCR and the DVD player will turn off.

NOTE

If you turn off the receiver while recording on the VCR, the VCR will not turn off, but continue recording.

Operating other JVC products

You can use the remote control to operate not only this receiver but also other JVC products.

- Refer also to the manuals supplied for the other products.
 - Some JVC VCRs can accept two types of the control signals—remote codes “A” and “B”. This remote control can operate a VCR whose remote control code is set to “A.”
- To operate other products, aim the remote control directly at the remote sensor on the target product.

Set the mode selector to **AUDIO/TV/VCR/DBS**.

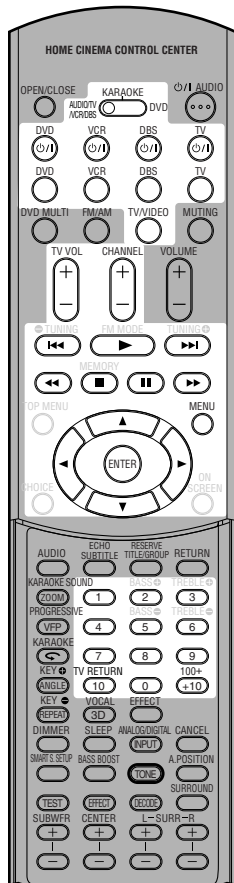

■ TV

You can always perform the following operations:

TV \odot/I:	Turn on or off the TV.
TV VOL +/-:	Adjust the volume on the TV.
TV/VIDEO:	Change the input mode (Video input and TV tuner) on the TV.

After pressing TV (source selecting button), you can perform the following operations on the TV.

CHANNEL +/-:	Change the channel numbers.
1 – 9, 0, +10 (100+):	Select the channel numbers.
10 (TV RETURN):	Function as the TV RETURN button.

■ VCR

You can always perform the following operations:

VCR \odot/I:	Turn on or off the VCR.
---	-------------------------

After pressing VCR (source selecting button), you can perform the following operations on the VCR.

CHANNEL +/-:	Change the channel numbers on the VCR.
1 – 9, 0:	Select the channel numbers on the VCR.
▶:	Start playback.
■:	Stop playback.
 :	Pause playback. To release it, press ▶.
▶▶:	Fast-wind a tape.
◀◀:	Rewind a tape.

■ DVD player

You can always perform the following operations:

DVD \odot/I:	Turn on or off the DVD player.
---	--------------------------------

After setting the mode selector to “DVD” then pressing DVD (source selecting button), you can perform the following operations on the DVD Player.

▶:	Start playback.
■:	Stop playback.
 :	Pause playback. To release it, press ▶.
▶▶:	Skip to the beginning of the next chapter.
◀◀:	Return to the beginning of the current (or previous) chapter.
MENU:	Display or erase the menu screen.
▲/▼/▶/◀:	Select an item on the menu screen.
ENTER:	Enter a selected item.

You can also use ▶▶, ◀◀, OPEN/CLOSE, AUDIO, SUBTITLE, TITLE/GROUP, RETURN, ZOOM, VFP, ↶, ANGLE, REPEAT, DIMMER, 3D, PROGRESSIVE, KARAOKE operation buttons and numeric buttons for operating JVC DVD player.

Operating other manufacturers' equipment

By changing the transmittable signals, you can use the remote control supplied for this unit to operate other manufacturers' equipment.

- Refer also to the manuals supplied with the other products.
- To operate those components with the remote control, first you need to set the manufacturers' codes each for the DBS tuner, VCR, and TV.
- After replacing batteries of the remote control, set the manufacturers' codes again.

Set the mode selector to **AUDIO/TV/VCR/DBS**.

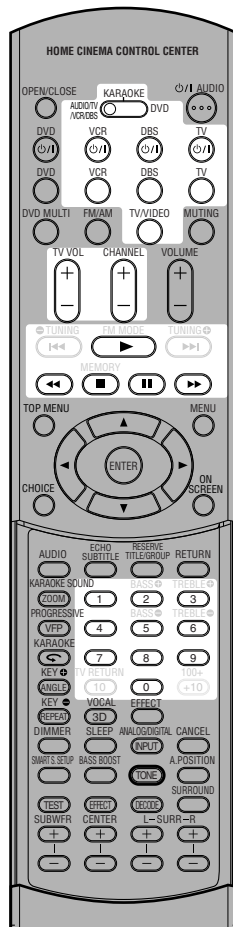

□ Changing the transmittable signals for operating a DBS tuner

- 1 Press and hold DBS \odot/I .
- 2 Press DBS.
- 3 Enter the manufacturer's code using buttons 1 – 9, and 0.
- 4 Release DBS \odot/I .

Now, you can perform the following operations on the DBS tuner.

DBS \odot/I : Turn on or off the DBS tuner.

After pressing DBS (source selecting button), you can perform the following operations on the DBS tuner.

CHANNEL +/-: Change the channel numbers on the DBS tuner.

1 – 9, 0: Select the channel numbers on the DBS tuner.

5 Try to operate your DBS tuner by pressing DBS \odot/I .

When your DBS tuner turns on or off, you have entered the correct code.

If more than one codes are listed for your brand of the DBS tuner, try each one until the correct one is entered.

Manufacturers' codes for DBS tuner

Manufacturer	Codes
G.I.	01*
GEMINI	02
HAMLIN	03 – 06
JERROLD	07 – 15
MACOM	16 – 18
MAGNAVOX	19
OAK	20 – 22
PANASONIC	23, 24
PHILIPS	25 – 30
PIONEER	31, 32
S. ATLANTA	33 – 35
SAMSUNG	36
TOCOM	37
ZENITH	38, 39
ECHOSTAR	40
G.I.	41
HITACHI	42
HUGHES	43
PANASONIC	44
PRIMESTAR	45
RCA	46
SONY	47
TOSHIBA	48

* Initial setting

❑ **Changing the transmittable signals for operating a VCR**

- 1 Press and hold VCR \odot /I.
- 2 Press VCR.
- 3 Enter the manufacturer's code using buttons 1 – 9, and 0.
- 4 Release VCR \odot /I.

Now, you can perform the following operations on the VCR.

VCR \odot /I:	Turn on or off the VCR.
-----------------	-------------------------

After pressing VCR (source selecting button), you can perform the following operations on the VCR.

CHANNEL +/-:	Change the channel numbers on the VCR.
1 – 9, 0:	Select the channel numbers on the VCR.
▶:	Start playback.
■:	Stop playback.
⏸:	Pause playback. To release it, press ▶.
▶▶:	Fast-wind a tape.
◀◀:	Rewind a tape.

5 **Try to operate your VCR by pressing VCR \odot /I.**

When your VCR turns on or off, you have entered the correct code.

If more than one codes are listed for your brand of VCR, try each one until the correct one is entered.

Manufacturers' codes for VCR

Manufacturer	Codes
JVC	01* – 04
AIWA	05
AKAI	06 – 08
BELL+HOWELL	09
DAEWOO	10
EMERSON	11 – 15
FISHER	16 – 19
G.E.	20, 21
GO VIDEO	22
GOLD STAR	23
GO-VIDEO A	24
GO-VIDEO B	25
HITACHI	20, 26
MAGNAVOX	27 – 29
MITSUBISHI	30 – 33
NEC	34, 35
PANASONIC	36, 37
PHILIPS	27
RCA	38
SAMSUNG	39 – 41
SANYO	16 – 19
SCOTT	42
SHARP	43, 44
SHINTOM	45
SONY	46 – 51
SYMPHO	52
TEKNICA	53, 54
TOSHIBA	55
ZENITH	56

* Initial setting

❑ **Changing the transmittable signals for operating a TV**

- 1 Press and hold TV \odot /I.
- 2 Press TV.
- 3 Enter the manufacturer's code using buttons 1 – 9, and 0.
- 4 Release TV \odot /I.

Now, you can perform the following operations on the TV.

TV \odot /I:	Turn on or off the TV.
----------------	------------------------

TV VOL +/-:	Adjust the volume.
-------------	--------------------

TV/VIDEO:	Change the input mode (either TV or VIDEO).
-----------	---

After pressing TV (source selecting button), you can perform the following operations on the TV.

CHANNEL +/-:	Change the channel numbers.
--------------	-----------------------------

1 – 9, 0:	Select the channel numbers.
-----------	-----------------------------

5 **Try to operate your TV by pressing TV \odot /I.**

When your TV turns on or off, you have entered the correct code.

If more than one codes are listed for your brand of TV, try each one until the correct one is entered.

Manufacturers' codes for TV

Manufacturer	Codes
JVC	01*
AKAI	02
BELL+HOWELL	03
CENTURION	04
CORONAD	05
DAEWOO	06 – 08
EMERSON	09 – 13
FISHER	14
GE•PANA	15, 16
GE•RCA	17
GOLD STAR	18, 19
HITACHI	20, 21
KTV	22, 23
MAGNAVOX	24
MARANTZ	25
MITSUBISHI	25
PANASONIC	26, 27
PHILIPS	24
PIONEER	28
PROSCAN	29
QUASAR	30
RADIOSHACK	31
RCA	02, 17, 32 – 35
SAMSUNG	36, 37
SANYO	14
SEARS	38
SHARP	39
SONY	40
SYMPHONIC	41, 42
TOSHIBA	38
ZENITH	43, 44

* Initial setting

Manufacturers' codes are subject to change without notice. If they are changed, this remote control cannot operate the equipment.

Troubleshooting

Use this chart to help you solve daily operational problems. If there are any problems you cannot solve, contact your JVC's service center.

RX-ES1SL

	PROBLEM	POSSIBLE CAUSE	SOLUTION
General	The power does not come on.	The power cord is not plugged in.	Plug the power cord into an AC outlet.
	No sound from speakers.	Speaker signal cables are not connected.	Check speaker wiring and reconnect if necessary.
		An incorrect source is selected.	Select the correct source.
		Muting is activated.	Press MUTING to cancel the mute.
		An incorrect input mode (analog or digital) is selected.	Select the correct input mode (analog or digital).
		Connections are incorrect.	Check connections.
	Sound from one speaker only.	The balance is set to one extreme.	Adjust the balance properly (see page 23).
	The unit turns off and becomes standby mode.	Speakers are overloaded because of high volume.	1. Stop the playback source. 2. Turn on the unit again, and adjust the volume.
		Speakers are overloaded because of a short circuit at the speaker terminals.	Check the speaker wiring. If speaker wiring is not short-circuited, contact your dealer.
		The unit is overloaded because of a high voltage.	Consult your dealer after unplugging the power cord.
	Remote control does not operate as you intend.	The remote control is not ready for your intended operation.	Press a source selecting button or TONE first, then press the buttons you want to use. (See pages 22 and 67 – 69.)
	Remote control does not work.	There is an obstruction hiding the remote sensor on the unit.	Remove the obstruction.
Batteries are weak.		Replace batteries.	
The mode selector is set to the incorrect position.		Set the mode selector to the proper position.	
Bass sound is reinforced too much when listening in stereo.	Appropriate bass level is not selected.	Adjust audio position level (see page 23).	

PROBLEM	POSSIBLE CAUSE	SOLUTION	
Surround mode cannot be selected.	Surround mode is not available on the software being played back, or only the front speakers are set for use.	Play not multi-channel software or check the speaker setting.	Surround/DSP
DSP mode cannot be selected.	DSP mode is not available on the software being played back, or only the front speakers are set for use.	Play back Linear PCM or analog software or check the speaker setting.	
Continuous hiss or buzzing during FM reception.	Incoming signal is too weak.	Connect an outdoor FM antenna or contact your dealer.	FM/AM
	The station is too far away.	Select a new station.	
	An incorrect antenna is used.	Check with your dealer to be sure you have the correct antenna.	
	Antennas are not connected properly.	Check connections.	
Occasional cracking noise during FM reception.	Ignition noise from automobiles.	Move the antenna farther from automobile traffic.	

NOTE

When you use the digital coaxial connection, the sounds may be intermittently distorted by the outside noise such as a lightning discharge but they will restore automatically. This is not a malfunction.

XV-NK58SL

	PROBLEM	POSSIBLE CAUSE	SOLUTION
Power	The power does not come on.	Power plug is not inserted securely.	Plug in securely.
	"REGION CODE ERROR!" is shown on the TV screen.	Region code of the inserted disc does not match the player.	Check the region code of the disc printed on the disc jacket.
Operation	Operation is not possible.	Microcomputer malfunction due to lightning or static electricity.	Turn off the power and unplug the power cord, then connect the power cord again.
		Moisture condensation caused by a sudden change of temperature or humidity.	Turn off the power, then turn it on a few hours later.
		The disc does not allow the operation, or an unplayable disc is inserted.	Check and replace the disc (see page 33).
	[LOCK] is displayed on the display window and the disc tray does not open.	When you press ▲ while pressing down ■ on the player in standby mode, the tray lock function is activated.	The disc tray cannot be opened or closed in this status. To release this status, press ▲ while pressing down ■ on the player in standby mode.
Picture	Picture is noisy.	The player is connected to a VCR directly and the copyguard function is activated.	Connect the player so that the picture signal flows directly to the TV.
		With some discs, the picture may be blurred when [PICTURE SOURCE] is set to [FILM] or [AUTO].	Set [PICTURE SOURCE] to [VIDEO (NORMAL)] or [VIDEO (ACTIVE)].
	Picture is distorted when using COMPONENT VIDEO OUT or S-VIDEO output jack(s).	Both the component connection and S-video connection are made.	Disconnect the unused one.
	No picture is displayed on the TV screen or the screen is blurred or divided into two parts.	The player is in the progressive scanning mode though it is connected to a TV via the VIDEO or S-VIDEO jack.	Set the 525i/525p/REMOTE selector on the rear panel to "525i," or set it to "REMOTE" and make the progressive scanning mode inactive by using the PROGRESSIVE button (see page 10).
Audio	DVD VIDEO disc playback sound level is lower than TV broadcast sound level.	[D.RANGE CONTROL] preference is set to other than [TV MODE].	Set the [D.RANGE CONTROL] preference to [TV MODE] (see page 59).
	Analog audio output is distorted.	[OUTPUT LEVEL] preference is set to [STANDARD]	Set the [OUTPUT LEVEL] preference to [LOW] (see page 59).
MP3/WMA	No sound comes out.	MP3/WMA disc is recorded with the "packet writing—Universal Disk Format (UDF) file."	It cannot be played.
	Files (tracks) are not played in the recorded order.		This player plays the files in the alphabetic order. So, the playback order can vary.
	WMA files cannot be played back.	The file is copy protected. The file is recorded with a bit rate under 48 kbps.	The player cannot play copy protected files. The player does not support such WMA files.
JPEG	No picture is played back, or the screen turns black.	Format of the files is not the baseline JPEG.	The unit supports only the baseline JPEG format.
	The preference display cannot be turned on.		You cannot turn on the preference display when a JPEG disc is inserted.
KARAOKE	The KARAOKE function cannot be turned on.	An MP3/WMA disc is played back.	You cannot turn on the KARAOKE function while playing back an MP3/WMA disc.
	The musical key cannot be shifted.		You cannot shift the musical key when playing back an Audio CD with DTS, or a DVD with DTS, MPEG Multichannel or 96 kHz linear PCM.
	The multichannel playback cannot be made.	The KARAOKE function is turned on.	Turn off the KARAOKE function.

RX-ES1SL

Amplifier

Output Power

At stereo operation:

Front channels: 100 W per channel*, min. RMS, driven into 8 Ω at 1 kHz with no more than 0.8% total harmonic distortion. (IEC268-3)

At surround operation:

Front channels: 100 W per channel*, min. RMS, driven into 8 Ω at 1 kHz with no more than 0.8% total harmonic distortion.

Center channel: 100 W*, min. RMS, driven into 8 Ω at 1 kHz, with no more than 0.8% total harmonic distortion.

Surround channels: 100 W per channel*, min. RMS, driven into 8 Ω at 1 kHz, with no more than 0.8% total harmonic distortion.

*Measured on AC 110V, 127 V, 220 V and 240 V.

Audio

Audio Input Sensitivity/Impedance (1 kHz):

DVD, DVD MULTI, DBS, VCR, TV:
260 mV/47 k Ω

Audio Input (DIGITAL IN)* :

Coaxial: DIGITAL 1 (DVD): 0.5 V(p-p)/75 Ω
Optical: DIGITAL 2/3 (DBS/TV):
-21 dBm to -15 dBm
(660 nm \pm 30 nm)

* Corresponding to Linear PCM, Dolby Digital, and DTS Digital Surround (with sampling frequency—32 kHz, 44.1 kHz, 48 kHz).

Audio Output Level: VCR: 250 mV

Signal-to-Noise Ratio (*66 IHF/DIN):
DVD MULTI: 87 dB/62 dB

Frequency Response (8 Ω):
DVD, DBS, VCR, TV: 20 Hz to 20 kHz (\pm 1 dB)

Tone Control:

Bass (100 Hz): \pm 10 dB \pm 2 dB

Treble (10 kHz): \pm 10 dB \pm 2 dB

Bass Boost: +4 dB \pm 1 dB at 100 Hz

Video

Video Input Sensitivity/Impedance (1 kHz):

Composite video: DVD, DBS, VCR:
1 V(p-p)/75 Ω

S-Video: DVD, DBS, VCR:
(Y:luminance): 1 V(p-p)/75 Ω
(C:chrominance): 0.286 V(p-p)/75 Ω

Component video: DVD, DBS:
(Y:luminance): 1 V(p-p)/75 Ω
(Pb/Pr): 0.7 V(p-p)/75 Ω

Video Output Level/Impedance (1 kHz):

Composite video: VCR, MONITOR OUT:
1 V(p-p)/75 Ω

S-Video: VCR, MONITOR OUT:
(Y:luminance): 1 V(p-p)/75 Ω
(C:chrominance): 0.286 V(p-p)/75 Ω

Component video: MONITOR OUT:
(Y:luminance): 1 V(p-p)/75 Ω
(Pb/Pr): 0.7 V(p-p)/75 Ω

Synchronize: Negative

FM tuner (IHF)

Tuning Range: 87.50 MHz to 108.00 MHz

Usable Sensitivity:
Monaural: 12.8 dBf (1.2 μ V/75 Ω)

50 dB Quieting Sensitivity:
Monaural: 16.0 dBf (1.7 μ V/75 Ω)
Stereo: 37.5 dBf (20.5 μ V/75 Ω)

Stereo Separation at REC OUT: 35 dB at 1 kHz

AM tuner

Tuning Range: 522 kHz to 1 629 kHz

General

Power Requirements: AC 110 V/127 V/220 V/230 V – 240 V, adjustable with the voltage selector, 50 Hz/60 Hz

Power Consumption: 100 W (at operation)
5 W (in standby mode)

Dimensions (W x H x D): 435 mm x 69.5 mm x 330.5 mm

Mass: 6.5 kg

Specifications

XV-NK58SL

General

Readable discs:	DVD VIDEO, DVD-R (Video format), DVD-RW (Video format), SVCD, Video CD, Audio CD (CD-DA), MP3/WMA format, JPEG, CD-R/RW (CD-DA, SVCD, Video CD, MP3/WMA format, JPEG)
Video format:	NTSC 525i (Interlaced scan)/525p (Progressive scan) selectable PAL Interlaced scan

Other

Power requirements:	AC 240 V \sim , 50 Hz
Power consumption:	13 W (POWER ON) 1.1 W (STANDBY mode)
Dimensions (W X H X D) :	435 mm X 45 mm X 270.5 mm
Mass:	2.1 kg

Video outputs

COMPONENT (pin jacks):	Y Output: 1.0 V(p-p)/75 Ω Pb/Pb Output: 0.7 V(p-p)/75 Ω
VIDEO OUT (pin jacks):	1.0 V(p-p)/75 Ω
S-VIDEO OUT (S jack):	Y Output: 1.0 V(p-p)/75 Ω C Output: 286 mV(p-p)/75 Ω
Horizontal resolution:	500 lines or more

Audio input

MIC:	4 mVrms (8.2 k Ω)
------	---------------------------

Audio outputs

ANALOG OUT (pin jack):	2.0 Vrms (10 k Ω)
DIGITAL OUT (COAXIAL):	0.5 V(p-p) (75 Ω termination)
DIGITAL OUT (OPTICAL):	-21 dBm to -15 dBm (peak)

Audio characteristics

Frequency response	CD (sampling frequency 44.1 kHz): 2 Hz to 20 kHz DVD (sampling frequency 48 kHz): 2 Hz to 22 kHz (4 Hz to 20 kHz for DTS and Dolby Digital bitstream signals) DVD (sampling frequency 96 kHz): 2 Hz to 44 kHz
Dynamic range:	16 bit: More than 98 dB 20/24 bit: More than 100 dB
Wow and flutter:	Unmeasurable (less than $\pm 0.002\%$)
Total harmonic distortion:	less than 0.006%

- Manufactured under license from Dolby Laboratories. "Dolby" and the double-D symbol are trademarks of Dolby Laboratories.
- "DTS" and "DTS Digital Out" are registered trademarks of Digital Theater Systems, Inc.

Mains (AC) Line Instruction (not applicable for Europe, U.S.A., Canada, Australia and U.K.)

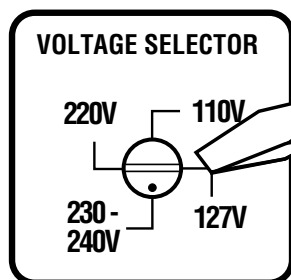
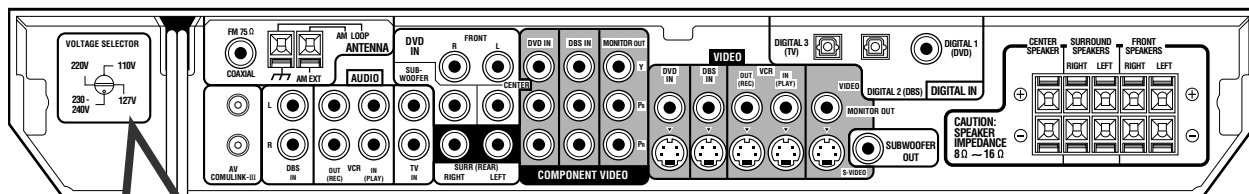

CAUTION for mains (AC) line
BEFORE PLUGGING IN, do check that your mains (AC) line voltage corresponds with the position of the voltage selector switch provided on the outside of this equipment and, if different, reset the voltage selector switch, to prevent from a damage or risk of fire/electric shock.

JVC

VICTOR COMPANY OF JAPAN, LIMITED