

**Portable RSE**  
**OPERATOR AND MAINTENANCE MANUAL**

QMS EDITION - ISO9001:2008

**DOCUMENT: UM 360453-700**

**REVISION: C**

**DATE: August 19, 2016**

**Editor: Scott Garlick**

**REVIEWERS: Stuart Lewis SYSTEMS ENGINEERING**

**Ed Rolo PROJECT MANAGEMENT**

**Tim Oaks TECHNICAL SERVICES**

**APPROVAL: Ed Rolo VP R&D**

**Japjeev Kohli VP SYSTEMS ENGINEERING**

This page intentionally left blank.

**PORTABLE RSE**  
**OPERATOR AND MAINTENANCE MANUAL**

QMS EDITION - ISO9001:2008

**DOCUMENT: UM 360453-700**

**REVISION: C**

**DATE: August 19, 2016**

**Kapsch TrafficCom Canada Inc.**

6020 AMBLER DRIVE  
MISSISSAUGA, ON L4W 2P1  
TEL: (905) 624-3020  
FAX: (905) 625-6197

**Kapsch TrafficCom AG**

AM EUROPLATZ 2  
1120 VIENNA, AUSTRIA  
TEL: +43 50 811 0  
FAX: +43 50 811 2109

**FCC License Notice:**

This equipment emits RF signals. In order to operate this equipment the customer must obtain a separate FCC Part 90 Site license for each location. In addition, the FCC ID component identification "JQU802041" must appear on the unit.

**NOTE:** This device complies with Part 15 of the FCC Rules. Operation is subject to the following two conditions: (1) this device may not cause harmful interference and (2) this device must accept any interference received, including interference that may cause undesired operation.

**NOTE:** IEC 60950-1 and/or EN60950-1, First Edition, Information Technology Equipment – Safety – Part 1:

**NOTE:** This equipment has been tested and found to comply with the limits for a Class A digital device, pursuant to Part 15 of the FCC Rules. These limits are designed to provide reasonable protection against harmful interference when the equipment is operated in a commercial environment. This equipment generates, uses, and can radiate radio frequency energy and, if not installed and used in accordance with the instruction manual, may cause harmful interference to radio communications. Operation of this equipment in a residential area is likely to cause harmful interference in which case the user will be required to correct the interference at their expense.

**Changes or modifications not expressly approved by Kapsch TrafficCom Canada Inc. could void FCC compliance and the authority to operate the equipment.**

**SOFTWARE/FIRMWARE NOTE**

The current software set is identified in the Software Release document.

**FACTORY SUPPORT SERVICE**

For Return Material Authorization (RMA) numbers please telephone: 905 624-3020.  
For service information and other requests please FAX: 905 625-6197.

**NOTICE**

The information presented in this document is current although it is subject to change. As such, **Kapsch TrafficCom Canada Inc.** assumes no liability on behalf of the USER with respect to interpretation based on the use of this information

© Kapsch TrafficCom Canada Inc. 2016

**COPYRIGHT STATEMENT**

These drawings and specifications contain confidential and proprietary information and are the property of  
**KAPSCH TRAFFICCOM CANADA INC.**  
and are issued in strict confidence and will be kept confidential and used solely for the purpose intended and for no other purpose and shall not be transmitted, reproduced, copied, and/or used as the basis for manufacture or sale of apparatus unless otherwise agreed to in writing by Kapsch TrafficCom Canada Inc.

**IMPORTANT!****NOTICE OF PATENTS:****Kapsch TrafficCom Canada Inc.**

has patented or has patents pending on critical design features of the item or items described herein. Contact the V.P. of Engineering at the address and phone number stated on the front page for all queries on patents.

---

## Document Revision Control

Applicability: Operator and Maintenance Manual

Revision: C

Version Date	Revision	Changes	Editor
19 August 16	C	ECN 16069	E. Rolo
08 March 13	B	Final	M. Kleiza

# Table of Contents

Document Revision Control.....	4
<b>1. About This Manual.....</b>	<b>8</b>
Warnings and Cautions.....	8
Warnings .....	8
Cautions .....	8
<b>OPERATING INSTRUCTIONS.....</b>	<b>9</b>
<b>2. Overview .....</b>	<b>10</b>
Introduction.....	10
Portable RSE components .....	10
Antennas .....	11
Stylus.....	12
Portable RSE buttons and LEDs.....	14
Portable RSE power jack and communication ports.....	15
Charging the Portable RSE battery .....	16
The Portable RSE software interface .....	16
The Main menu .....	16
RF Configuration Indication.....	17
Tx/Rx indicator .....	18
Low battery level indication and effects on Portable RSE .....	18
OBU data fields .....	19
Power Button menu.....	21
How the Portable RSE works .....	22
Data Storage.....	22
Synchronization.....	22
RSE Communication block diagram .....	22
<b>3. Operating Procedures .....</b>	<b>23</b>
Starting up the Portable RSE.....	23
Suspending the Portable RSE.....	23
Waking the Portable RSE .....	23
Powering off the Portable RSE.....	24
Resetting (Rebooting) the Portable RSE .....	24
Checking battery power remaining .....	25
Unlocking the Portable RSE .....	26
Returning to the Portable RSE program .....	28
Restart the Portable RSE software .....	28
Reading OBUs .....	29
Scanning Zones .....	31
Front-Mounted OBUs on Trucks .....	31
Roof-Mounted OBUs on Trucks .....	32
Windshield-Mounted OBUs on Passenger Vehicles.....	32

Unmounted OBUs .....	33
Reviewing saved OBU data .....	36
Viewing Agency and Scratch pad data .....	36
Transferring Data to the LC.....	37
Erasing OBU data .....	38
Command and Controls .....	39
<b>MAINTENANCE INSTRUCTIONS.....</b>	<b>45</b>
<b>4. Theory of Operations .....</b>	<b>46</b>
RF Power Level settings .....	47
<b>5. Installation and Configuration.....</b>	<b>48</b>
Installing an antenna .....	48
Configuring automatic suspending.....	49
Configuring automatic backlight and screen dimming .....	49
Setting the time and date .....	50
<b>6. Troubleshooting.....</b>	<b>51</b>
Troubleshooting Methodology .....	51
Returning the Portable RSE for service.....	51
Performing a Health Check on the Diagnostics screen .....	51
Troubleshooting tree: Difficulty reading OBUs consistently .....	53
Troubleshooting tree: Battery does not fully charge to 100% (0 mAh consumed).....	54
Troubleshooting tree: Touchscreen responds inaccurately to inputs .....	55
LC Transfer Error messages .....	56
OBU Transaction Buffer Full.....	56
Insufficient Power (to transfer data to LC).....	56
<b>7. Maintenance Procedures .....</b>	<b>57</b>
Cleaning the Portable RSE touch screen.....	57
Protecting the touchscreen .....	58
Calibrating the touchscreen .....	58
Replacing the battery pack .....	59
Determining the software and firmware versions.....	59
<b>8. Appendix.....</b>	<b>60</b>
Technical Specifications and Pin outs .....	60
Tech specs: .....	60
Serial port pin out .....	60
Reference Documents .....	61
Other commercial Documents: .....	61
Acronyms and Synonyms.....	62



**List of Figures:**

Figure 2-1: Short-Range Antenna ..... 11

Figure 2-2: Optional remote Antenna ..... 11

Figure 2-3: Portable RSE Stylus ..... 13

Figure 2-4: Portable RSE buttons and LEDs ..... 14

Figure 2-5: Portable RSE – bottom view ..... 15

Figure 2-6: Main Menu screen..... 16

Figure 2-7: RF Configuration Display ..... 17

Figure 2-8: Power Button menu ..... 21

Figure 2-9: RSE communication block diagram ..... 22

Figure 3-1: General battery power level indication ..... 25

Figure 3-2: Detailed battery power level indication ..... 26

Figure 3-3: Windows Mobile 5.0 locked Today screen ..... 27

Figure 3-4: Successful OBU scan ..... 29

Figure 3-5: Scanning position of OBUs with orientation arrows (G4 transponder shown) ..... 34

Figure 3-6: Scanning position of motorcycle FME ..... 35

Figure 3-7: Saved OBU data ..... 36

Figure 3-8: Data transfer in progress ..... 37

Figure 3-9: LC Transfer complete confirmation ..... 38

Figure 3-10: Zero OBU records ..... 38

Figure 4-1: Functional Block Diagram ..... 46

Figure 5-1: Portable RSE antenna terminals (top view)..... 48

Figure 5-2: OK button for committing configuration changes..... 49

Figure 6-1: The Diagnostics Screen..... 52

Figure 6-2: OBU Transaction Buffer Full message ..... 56

Figure 6-3: Insufficient Power message..... 56

**List of Tables:**

Table 2-1: RF Configuration Abbreviations..... 17

Table 2-2: Tx/Rx indicator states ..... 18

Table 2-3: Low battery level indicators..... 19

**Table 2-4 OBU data fields and locations** ..... 20

Table 2-5: Available functions on Power Button menu ..... 21

Table 3-1: Possible OBU Read result statuses and solutions ..... 30

Table 4-1: RF power level settings ..... 47

Table 6-1: Health Check Status Results..... 51

# 1. ABOUT THIS MANUAL

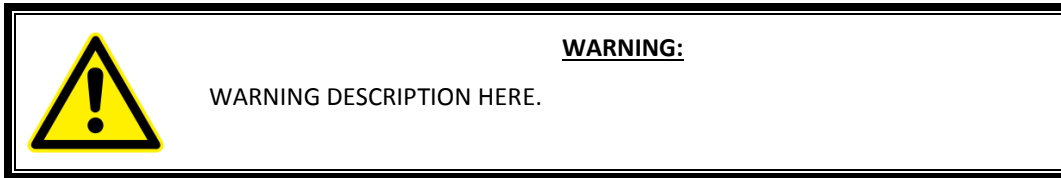
This manual is divided into two parts; Operating Instructions and Maintenance Instructions. See the Table of Contents for more details.

This manual is the main reference document used during training given by Kapsch TrafficCom to Operator, Installation, Maintenance, and Service personnel. It is also used as a reference by Kapsch TrafficCom certified technical service personnel in the field once training has been completed.

## Warnings and Cautions

### Warnings

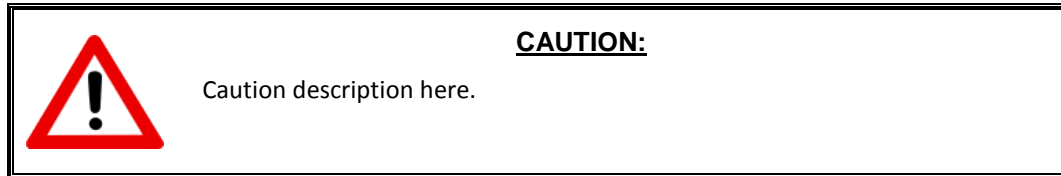
Warnings indicate a risk of bodily harm and include a symbol indicating the type of injury that is at risk.



No warnings currently appear in this manual.

### Cautions

Cautions indicate a risk of damage to equipment or loss of data.



The following cautions appear in the manual:

Do not use sharp objects on the Portable RSE touch screen. Tapping the touch screen with sharp objects can damage the touch screen.

Use only the external power supply intended for the Portable RSE. Using any other external power source may damage the Portable RSE.

Do not clean the touch screen using tissues, paper towels, or harsh cleaning agents as these can damage the device. Long exposure to the following solutions may damage the device.

- pine oil
- oil-based paint
- automotive brake cleaner
- isopropyl alcohol
- carburetor cleaner

# OPERATING INSTRUCTIONS

## 2. OVERVIEW

### Introduction

The Portable RSE is a hand-held device that can read all IAG-compatible On Board Units (OBUs). The OBU data is stored in the Portable RSE where it can be viewed and later downloaded to a Lane Controller (LC). The Portable RSE supplements existing Electronic Toll Collection (ETC) systems and can be used for applications such as valet parking, transponder screening, and enforcement.

### Portable RSE components

The Portable RSE consists of a Reader module joined to an Ultra-Rugged Field PC and has of the following components:

- **battery:** This device comes with a lithium ion rechargeable battery pack.
- **external power supply:** The external power supply connects to AC power and supplies 12V DC to the Portable RSE. This external power supply charges the battery while it powers the device.
- **short-range antenna:** range of approx. 5 ft.
- **optional remote antenna:** reach of approx. 8 ft.
- **50  $\Omega$  terminating resistor:** this resistor is connected to terminate one of the antenna terminals when that terminal is not connected to an antenna.
- **removable belt clip**
- **removable hand strap**
- **stylus** (see page 12 for more information)

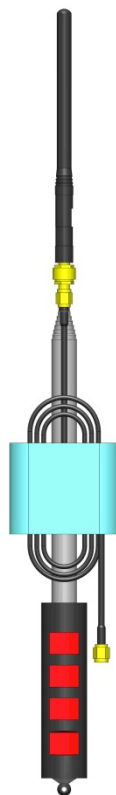
## Antennas

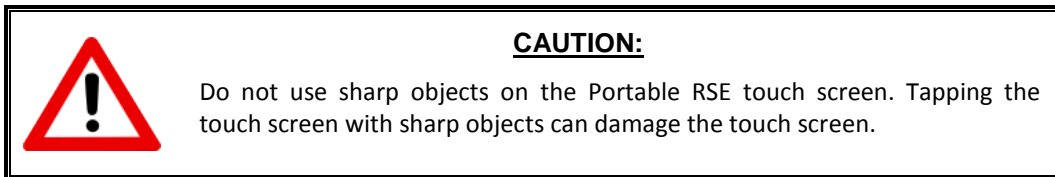
The Portable RSE is equipped with a standard locally attached antenna that allows the unit to read Transponders. It provides a connection for the same type of antenna to be remotely attached via a RF cable for increased distance from the PDA to the tag. A dedicated terminal is located on the top of the Portable RSE for each type of antenna. The unused antenna terminal must be terminated with a 50  $\Omega$  terminating resistor.

**Figure 2-1: Short-Range Antenna**

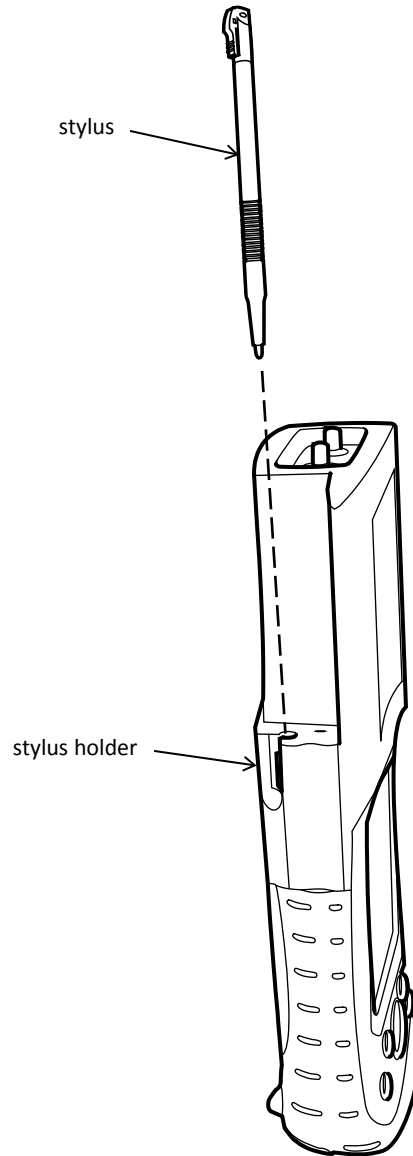


**Figure 2-2: Optional remote Antenna**



**Stylus**

The stylus in Figure 2-3 is stored in the **Stylus holder** on the back of the device. For best results, it is recommended that you use the stylus to tap the screen when using the Portable RSE.

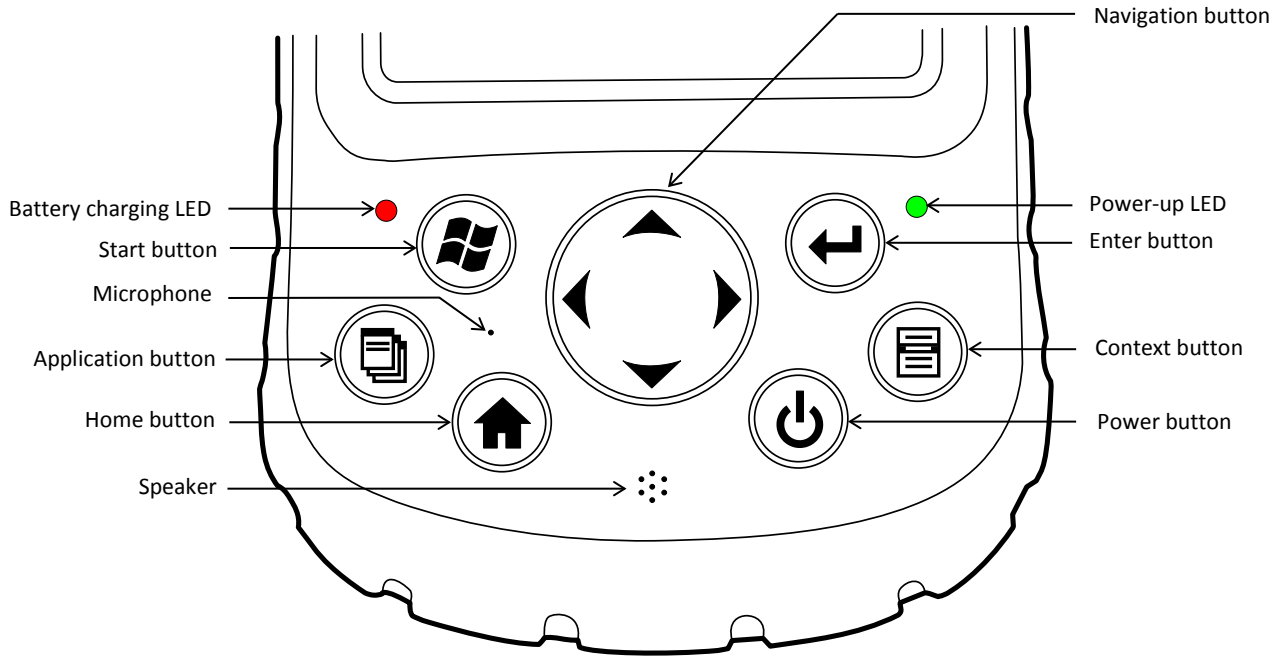


**Figure 2-3: Portable RSE Stylus**

## Portable RSE buttons and LEDs

The terms for the buttons and LEDs in Figure 2-4 are used throughout the manual.

Figure 2-4: Portable RSE buttons and LEDs

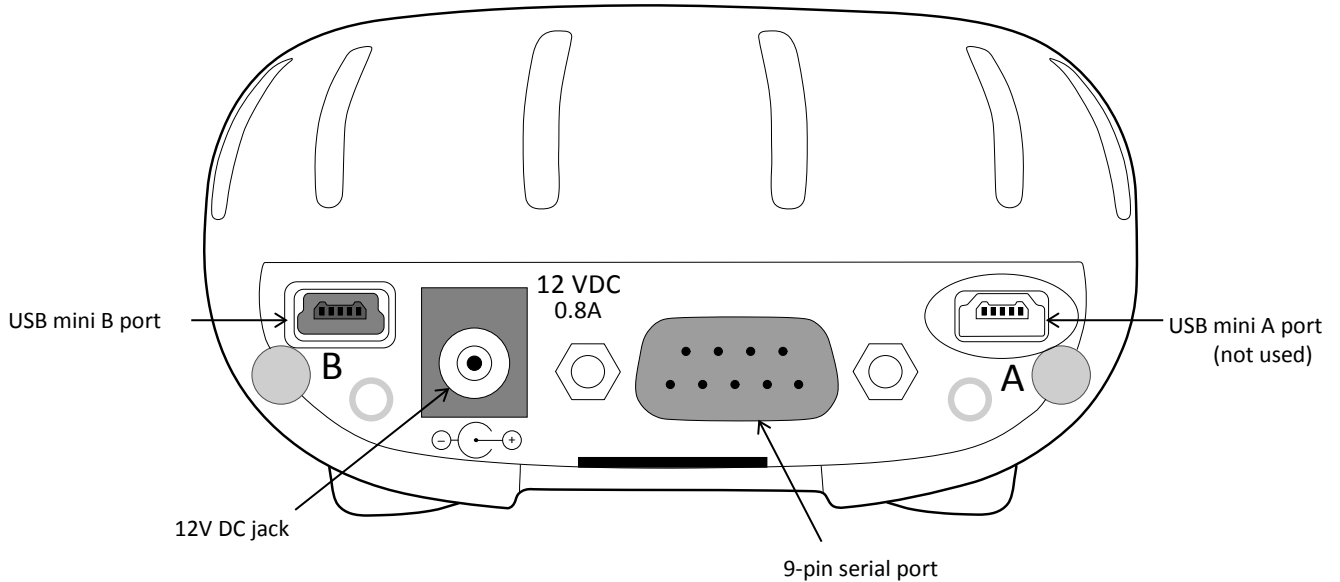




## Portable RSE power jack and communication ports

The 12V DC power jack and the communication ports are located on the bottom of the Portable RSE. To protect the device, ensure the protective cover is properly seated when the ports are not in use.

Figure 2-5: Portable RSE – bottom view



## Charging the Portable RSE battery

**CAUTION:**

Use only the external power supply intended for the Portable RSE. Using any other external power source may damage the Portable RSE.

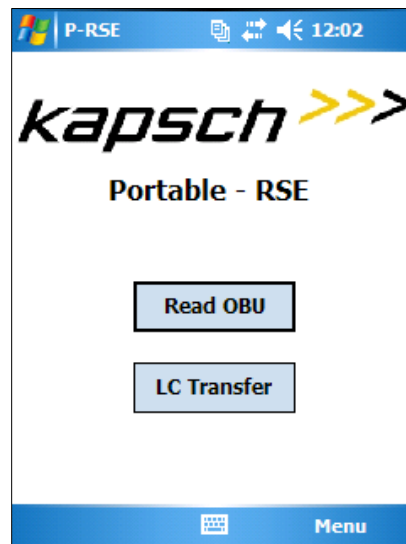
The Portable RSE battery charges via an external power supply connected to the 12VDC jack on the bottom of the Portable RSE. The Portable RSE battery does not charge when connected to a computer via a USB port. The battery charging LED flashes red when the battery is charging and illuminates solid red when the battery is fully charged.

## The Portable RSE software interface

### The Main menu

When the Portable RSE software launches, the main menu screen appears. From here you can navigate to perform the Portable RSE's two main functions: reading OBUs and transferring OBU data to the LC.

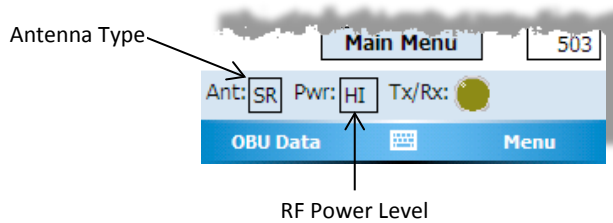
Figure 2-6: Main Menu screen



**RF Configuration Indication**

The RF configuration settings are displayed at the bottom of the **OBU Acquisition** screen. The abbreviations in Table 2-1 list all possible configuration settings.

**Figure 2-7: RF Configuration Display**







**Table 2-1: RF Configuration Abbreviations**

State	Indicator	Meaning
Ant	SR	short-range antenna selected
	LR	long-range antenna port selected
Pwr	LO	low RF power level selected
	MD	medium RF power level selected
	HI	high RF power level selected
	AU	automatic RF power level selected

### Tx/Rx indicator

The Tx/Rx indicator on the bottom of the LC Transfer screen and the OBU Acquisition screen provides the following feedback:


**Table 2-2: Tx/Rx indicator states**

State	Meaning	Screen
 <b>(Dk Green)</b>	Portable RSE connection to LC is idle.	LC Transfer
 <b>(Lt.Green)</b>	Portable RSE is transferring data to the LC.	LC Transfer
 <b>(clear)</b>	Portable RSE communication with OBU is idle.	OBU Acquisition
	Health Check is idle.	Diagnostics
 <b>(Yellow)</b>	Portable RSE is attempting to communicate with OBU.	OBU Acquisition
	The Portable RSE is performing a Health Check.	Diagnostics

### Low battery level indication and effects on Portable RSE

A low battery level can affect the performance of the Portable RSE as the device attempts to reduce power consumption and avoid data loss. Table 2-3 outlines the behavior you can expect as the remaining battery power is reduced.

**Table 2-3: Low battery level indicators**

approximate battery level	effect on RSE (if not connected to AC power)
20%	<ul style="list-style-type: none"> <li>• battery level indicator bars replaced by exclamation mark: </li> </ul>
15%	<ul style="list-style-type: none"> <li>• The RSE suspends into Hibernate mode after 1 min.</li> <li>• Main Battery Low warning message appears:                             <div data-bbox="615 646 987 779" style="border: 1px solid black; padding: 5px; margin: 5px 0;"> <p><b>Main Battery Low</b></p> <p>To prevent possible data loss, replace or recharge your battery according to the owner's manual.</p> </div> </li> </ul>
10%	<ul style="list-style-type: none"> <li>• The RSE suspends into sleep mode after 10 sec.</li> <li>• Cannot transfer OBU data to the LC.</li> <li>• Main Battery Very Low warning message appears.                             <div data-bbox="615 936 987 1068" style="border: 1px solid red; padding: 5px; margin: 5px 0;"> <p><b>Main Battery Very Low</b></p> <p>To prevent possible data loss, replace or recharge your battery according to the owner's manual.</p> </div> </li> </ul>

**OBU data fields**

OBU data is displayed on the OBU Acquisition screen, the Agency screen, and the Scratchpad screen:

Table 2-4 OBU data fields and locations

Data Field	Screen where data appear
Date/Time	OBU Acquisition
Status	OBU Acquisition
Agency ID	OBU Acquisition
OBU Serial #	OBU Acquisition
OBU Type	OBU Acquisition
Revenue Type	Agency
(De-)Commission	Agency
Mounting Loc	Agency
Veh. Type	Agency
Veh. Axles	Agency
Veh. Weight	Agency
Veh. Rear Tires	Agency
Reader ID	Scratchpad
TM Date/Time	Scratchpad
Plaza ID	Scratchpad
Lane ID	Scratchpad
TC Date/Time	Scratchpad
Txn Num	Scratchpad
Checksum	Scratchpad
Agency ID	Scratchpad

## Power Button menu


Pressing and holding the Power button  will open the **Power Button** menu. From this menu, there are several shutdown options available, as outlined in Table 2-5.

Figure 2-8: Power Button menu

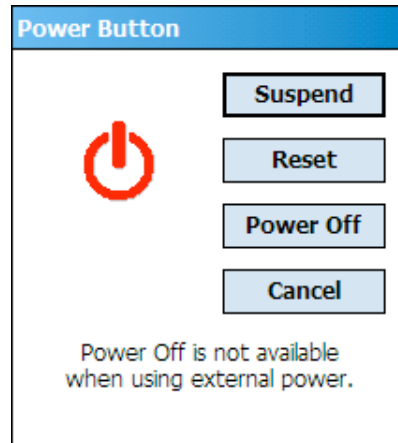


Table 2-5: Available functions on Power Button menu

Button	Function
Suspend	puts the unit in Hibernate mode.
Reset	reboots the Portable RSE.
Power Off	shuts down the Portable RSE.
Cancel	closes the Power Button menu.

## How the Portable RSE works

When an OBU read is initiated, the Portable RSE scans for any IAG-protocol OBUs within range. OBUs within range respond by transmitting their data to the Portable RSE. This data is then decoded and displayed on the LCD. The Portable RSE includes a standard whip antenna that allows the unit to read OBUs at a distance of approximately 5 feet. An optional remote antenna is available that can extend the reach of the device to approximately 9 feet. The Portable RSE does not write to the OBU.

### Data Storage

The data read by the Portable RSE is stored internally in the Portable RSE where it can be either be viewed or downloaded to the LC. The Portable RSE can store data from a maximum of 1000 OBU reads. Once 1000 OBUs have been read, the data must be downloaded to an LC or erased before more OBUs can be read. OBU data is automatically erased from the Portable RSE once it has been downloaded to the LC. See Erasing OBU data on page 38 for more information.

### Synchronization

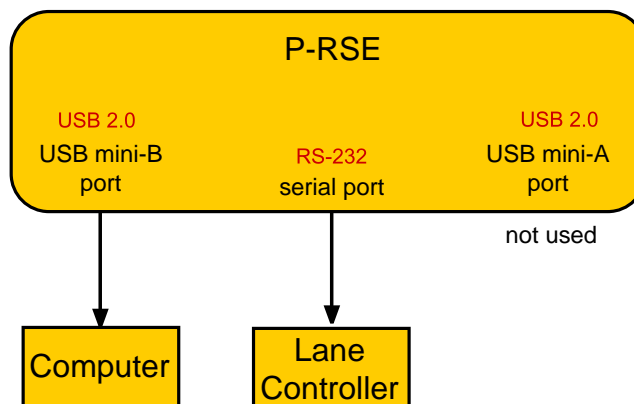
When performing a read, the Portable RSE checks for incoming RF signals from toll plaza Readers. If trigger pulses from toll plaza Readers are detected, the Portable RSE determines the length of time between trigger pulses (i.e. the length of the superframe) and sends its own trigger pulse when it is unlikely to conflict with the toll plaza Reader. This ensures data is not corrupted in either the Portable RSE or toll plaza Readers.

**Note:** To avoid potential performance impacts on toll plaza Readers, the Portable RSE must be positioned in accordance with the requirements of this section.

### RSE Communication block diagram

Figure 2-9 illustrates the possible external communication interfaces of the Portable RSE.

Figure 2-9: RSE communication block diagram






## **3. OPERATING PROCEDURES**

### **Starting up the Portable RSE**

This procedure outlines how to power up the Portable RSE.

Prerequisites: None.


**NOTE:** The Portable RSE will automatically start up when connected to external AC power.

1. Press the Power button . The green power-up LED lights for approximately 10 seconds while the Portable RSE begins booting up.
2. The Ultra-Rugged Field PC and Windows Mobile boot splash screens appear. After Windows Mobile has started, the Portable RSE software automatically launches.
3. A Health Check is automatically performed and messages are displayed if any errors are found. Total boot-up time is approximately one (1) minute.

### **Suspending the Portable RSE**

Suspending the device does not shut down the Portable RSE or end any programs, but puts the Portable RSE into Hibernate mode. In Hibernate mode, the LCD screen goes completely blank. Hibernate mode reduces, but does not eliminate, battery power consumption. This procedure outlines how to manually suspend the Portable RSE; however, you can also configure the Portable RSE to automatically suspend after a predetermined time (see Configuring automatic suspending, page 49).


Prerequisites: None.

1. Press the Power button . The green power-up LED lights momentarily and the screen powers off.

### **Waking the Portable RSE**

This procedure outlines how to activate a suspended Portable RSE from Hibernate mode.


Prerequisites: None.

1. Press the Power button . The green power-up LED lights momentarily and the Portable RSE displays the screen showing at the time the Portable RSE was suspended.


## Powering off the Portable RSE

Powering off the Portable RSE ends all programs and removes power from all Portable RSE components except for the internal real-time clock. The Portable RSE should be powered off if it will not be used for an extended period of time. No OBU data or configuration settings are lost when the Portable RSE is powered off.

Prerequisites: The Portable RSE must be disconnected from AC power.

1. Press and hold the Power button  until the Power Button menu appears.
2. From the Power Button menu, press the **Power Off** button. The **Power Off** button will not be available if the RSE is charging.
3. A warning message appears, stating that unsaved data will be lost. Select **OK**. No OBU data is lost when the RSE is powered off.

## Resetting (Rebooting) the Portable RSE

Reboot the Portable RSE by tapping **Reset** from the Power Button menu, or by holding down the Power button  for approx. 6 sec. No OBU data or configuration settings are lost when the Portable RSE is rebooted.

Prerequisites: None.

1. Press and hold the Power button until the Power Button menu appears.
2. From the Power Button menu, press the **Reset** button; or continue to hold the Power button for approx. 6 sec. until the Portable RSE reboots.


## Checking battery power remaining

Two types of battery power remaining indications are available: general and detailed. You should be aware of how much battery power is remaining, as low battery power levels can affect the behavior of the Portable RSE (see Low battery level indication and effects on Portable RSE, page 18).

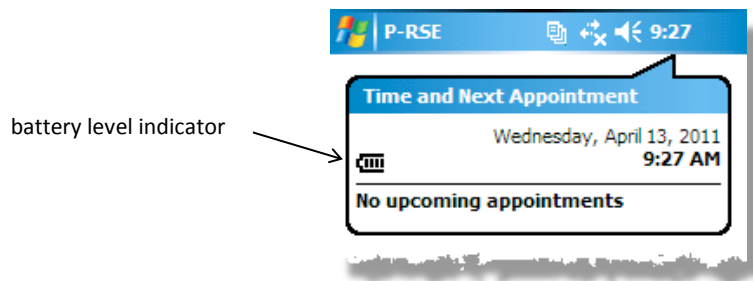
**Note:** For low battery indications see Table 2-3: Low battery level indicators on page 19.

Prerequisites: None.

### Viewing the general battery level

1. Tap the time displayed in the upper-right corner of any screen.
2. If the Portable RSE is running on battery power, the battery level is shown between 1 to 4 bars, with an exclamation mark indicating a low battery level. If the Portable RSE is running on AC power, a power cord connection icon  is displayed. To view the battery power level remaining while connected to AC power, perform step 3.

**Figure 3-1: General battery power level indication**



### Viewing the detailed battery level




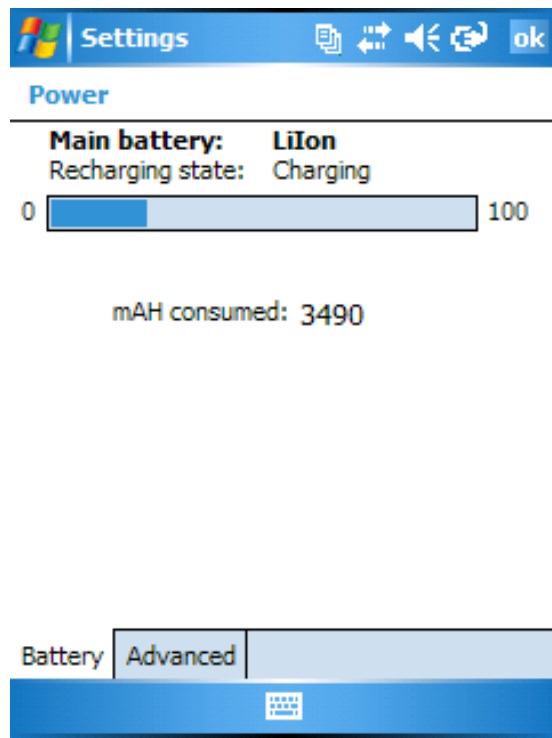
- For a more detailed battery level indication, Tap  → **Settings** → **System** tab → **Power**  → **Battery** tab. The battery power level is shown in a bar graph, and the total mAH consumed. 0 mAH consumed indicates the battery is 100% charged while 3900 mAH consumed indicates the battery is completely depleted. Tap **ok** to exit the Power screen, then  to return to the Portable RSE software.

Figure 3-2: Detailed battery power level indication



## Unlocking the Portable RSE


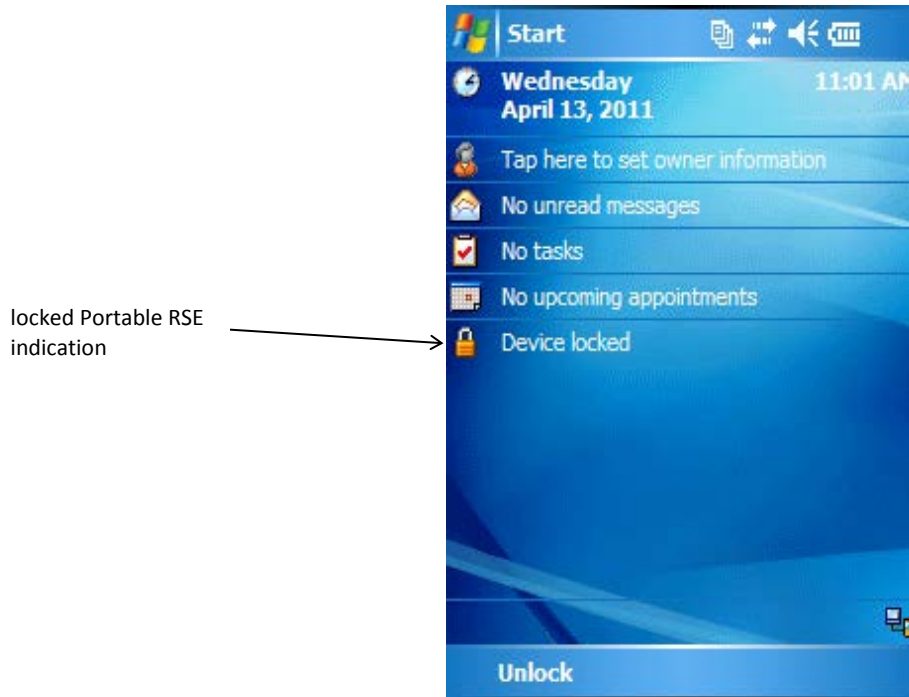
If you inadvertently lock  the Portable RSE from the Windows Mobile Today screen, the RSE will not accept any inputs and you will not be able to navigate from the Today screen.


Figure 3-3: Windows Mobile 5.0 locked Today screen



1. Unlock the RSE.
  - a) Tap **Unlock** at the bottom-right of the screen. The Unlock screen appears




- b) Tap **Unlock** from the Unlock screen.

2. The device is now unlocked . To return to the Portable RSE software, see Returning to the Portable RSE program, page 28.

## Returning to the Portable RSE program

Although the Portable RSE runs on the Windows Mobile 5.0 operating system, the Portable RSE is not meant as a personal computing device. You should keep the Portable RSE software active at all times. However, if you inadvertently close the Portable RSE software screen, you can easily return to it:

1. Press the Power button  to suspend the RSE.
2. Press the Power button again to wake the RSE. The RSE will automatically return to the RSE software.
3. If the RSE does not return to the RSE software, you must restart the RSE software (see Restart the Portable RSE software, page 28).

## Restart the Portable RSE software

If you inadvertently shutdown the RSE software, reboot the Portable RSE (see Resetting (Rebooting) the Portable RSE, page 24) to restart the RSE software. No OBU data is lost when the RSE is rebooted.

## Reading OBUs

OBUs are read from the OBU Acquisition screen.

- Prerequisites:
- The Portable RSE must have less than 1000 stored OBU records.
  - The Portable RSE antenna is properly installed and configured (see Installing an antenna, page48).
  - The Portable RSE must be positioned within the scanning zone (see Scanning Zones, page 30).
  - Only one OBU must be within range of the Portable RSE.

1. From the Portable RSE main menu, tap **Read OBU**. The **OBU Acquisition** screen appears.
2. With the Portable RSE orientated as outlined in Scanning Zones, page 30, from the **OBU Acquisition** screen, tap **Read OBU**.

**NOTE:** A blue highlighted OBU Read Success message indicates saved OBU data is being displayed. A green highlighted OBU Read Success message indicates data from the latest OBU read is being displayed.

3. After approx. 1 or 2 seconds, the Read result status is displayed. If **OBU Read Success** is displayed, the OBU data has been successfully read. Any other message indicates a Read error. See Table 3-1, page 30.

Figure 3-4: Successful OBU scan

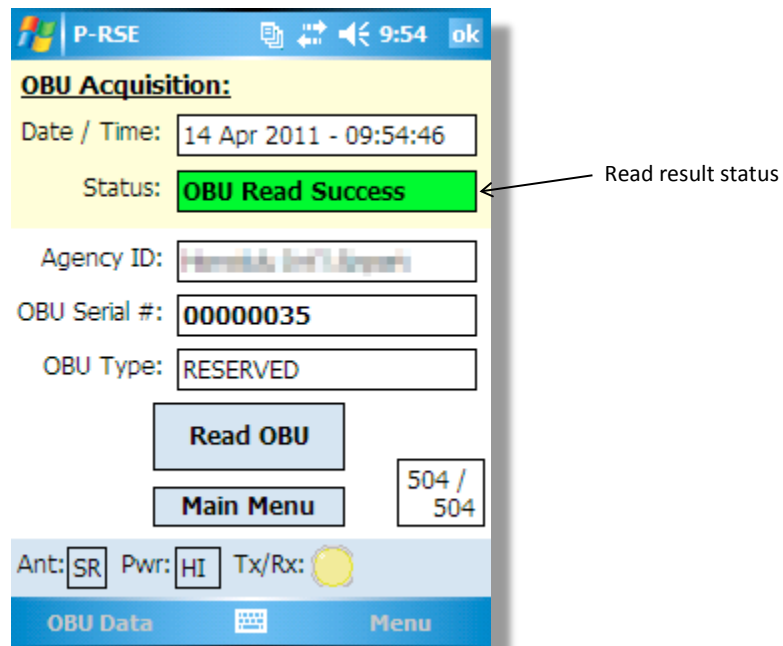


Table 3-1: Possible OBU Read result statuses and solutions

Read Status	Description	Solution
OBU Read Success	The OBU was read successfully.	N/A
OBU Data Not Read	The Portable RSE did not receive any OBU data and was unable to communicate with the OBU.	Ensure the prerequisites for Reading OBUs on page 29 have been met.
CRC error	Invalid CRC.	Ensure the prerequisites for Reading OBUs on page 29 have been met.
Non-IAG OBU	The OBU has a non-IAG Group ID.	The data are read and stored as in a <b>Read Success</b> unless it is also detected that the OBU is not supported.
OBU not supported	The Portable RSE is not permitted to accept data from OBUs of this particular Group ID.	The list of unaccepted Group Ids is factory configured. Contact Kapsch TrafficCom if this Group ID has been excluded in error.
Comms Error	The Portable RSE could not read all the OBU data in the allotted time.	Ensure the prerequisites for Reading OBUs on page 29 have been met. Also, see Table 6-1: Health Check Status Results.



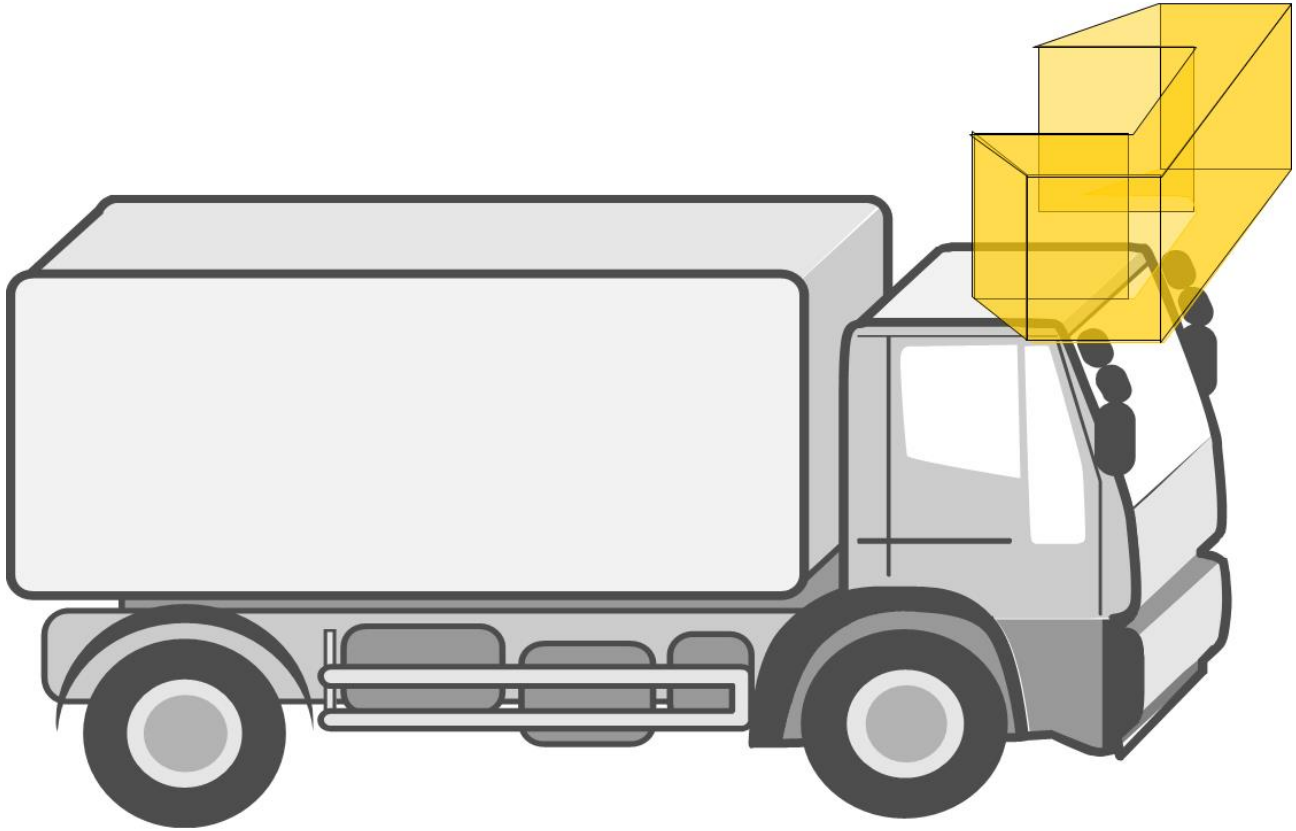
## Scanning Zones

When scanning mounted OBUs, position yourself facing the OBU with the Portable RSE held in front of you. The distance between the Portable RSE and the OBU is controlled by the configuration. The short-range antenna has a maximum range of 5 feet. The ideal position for a successful read is to position the Portable RSE in the shaded areas in the two diagrams below.

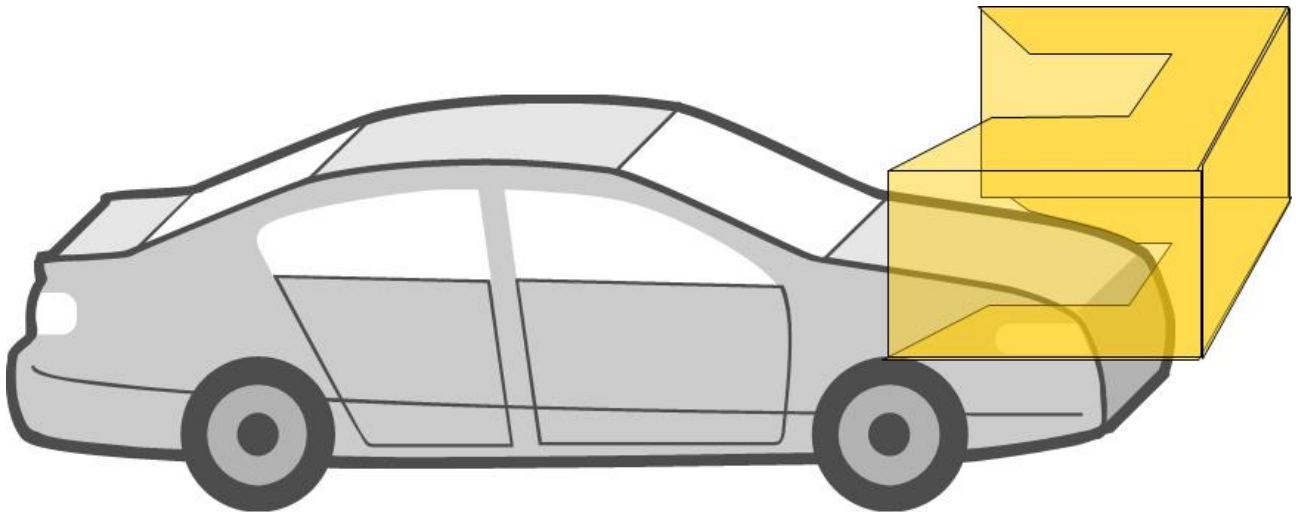
### Front-Mounted OBUs on Trucks



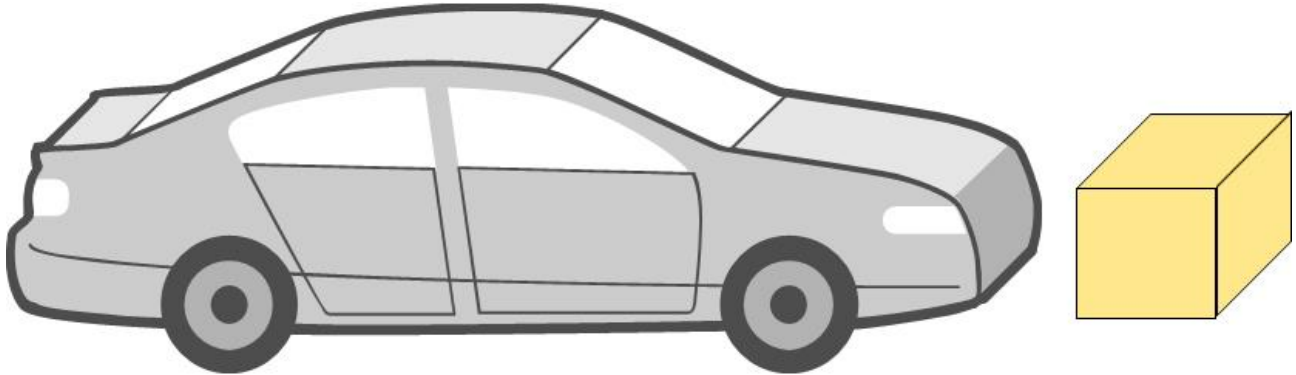
**Roof-Mounted OBUs on Trucks**



**Windshield-Mounted OBUs on Passenger Vehicles**



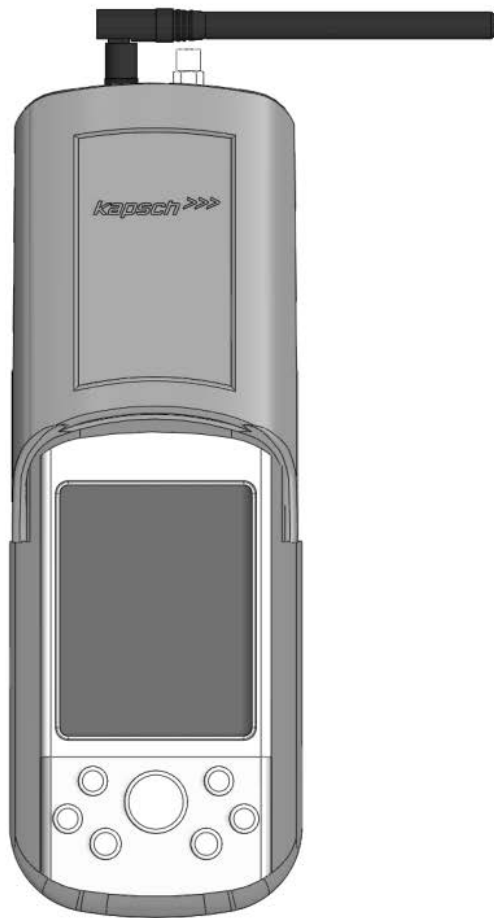
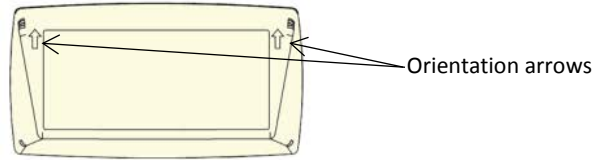
## Front-Mounted OBUs on Passenger Vehicles

**Unmounted OBUs**

For OBUs that are not installed in a vehicle, scan the OBUs in the orientation and approximate distance outlined below.

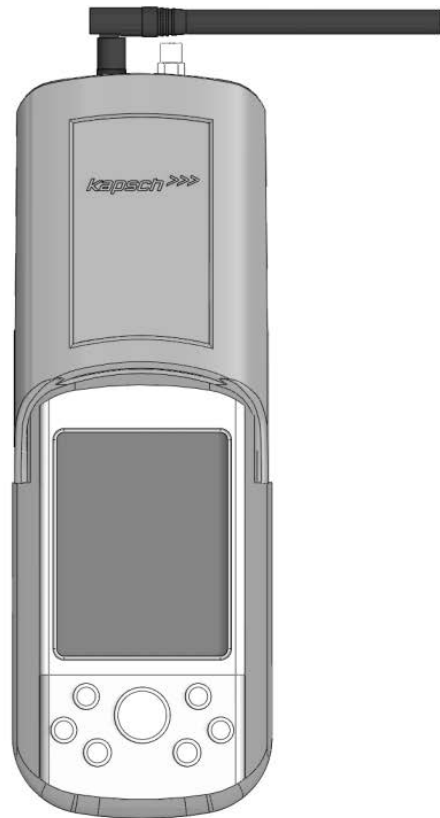
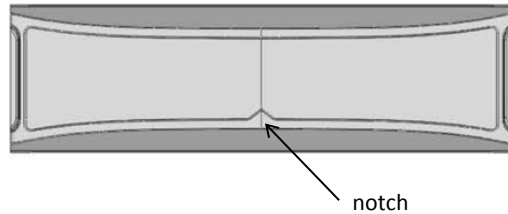
For unmounted FME, FPT, and G4 OBUs, orient the OBU with the arrows pointing away from the Portable RSE.

Figure 3-5: Scanning position of OBUs with orientation arrows (G4 transponder shown)



**Note:** For motorcycle FME OBUs, mounted and unmounted, orient the OBU with the notch on the OBU pointing away from the Portable RSE as in Figure 3-6.

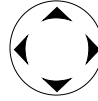
**Figure 3-6: Scanning position of motorcycle FME**



## Reviewing saved OBU data

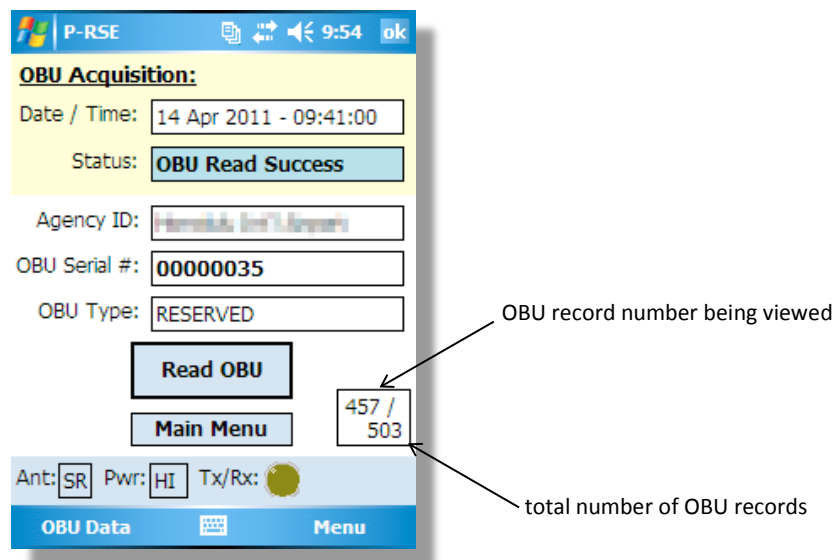
After the OBU data is read, it is saved in the Portable RSE until the data is erased or downloaded to the Lane Controller. The status message **OBU Read Success** highlights blue to indicate the data being viewed is saved data and not data from the most recent scan.

1. From the Portable RSE main menu, tap **Read OBU**. The **OBU Acquisition** screen appears.



2. From the **OBU Acquisition** page, press the navigation button left or right to scroll through the OBU records. The record number being viewed increase or decrease as you scroll through the OBU records.

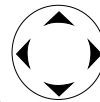
Figure 3-7: Saved OBU data



## Viewing Agency and Scratch pad data

The **OBU Acquisition** screen does not display all the OBU data. This procedure outlines how to view the OBU Agency and Scratchpad data.

Prerequisites: The OBU Acquisition screen must be displaying either current or stored OBU data.



1. From the **OBU Acquisition** screen, press the navigation button, as required, to display the OBU record whose Agency and/or Scratchpad data you wish to view.
2. Tap **OBU Data** at the bottom-left of the **OBU Acquisition** screen.

3. Select **Agency** or **Scratchpad**, as applicable. The selected data fields are displayed.
4. To view Agency or Scratchpad data from another OBU record, tap **Previous** to return to the **OBU Acquisition** screen and repeat steps 1 through 3.

## Transferring Data to the LC

Each OBU read is stored in the Portable RSE, which can store a maximum of 1000 OBU reads. To save the OBU data long-term, it must be transferred to the LC. Once OBU data has been transferred from the Portable RSE to the LC, it is erased from the Portable RSE.

Prerequisites:

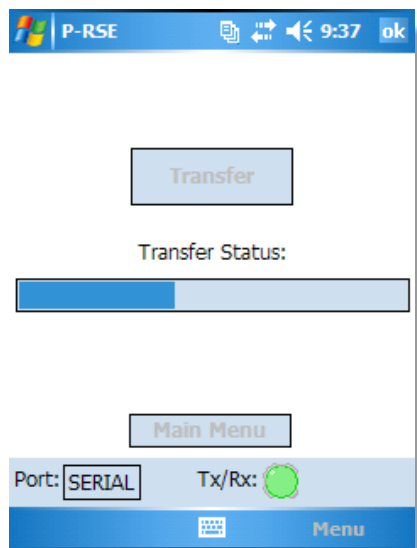
- You must have at least 10% battery life remaining or be connected to AC power.
- The Portable RSE serial port must be connected to the LC using a null modem serial cable.
- There must be OBU data stored in the Portable RSE.
- An LC that conforms to ICD 360453-702

1. From the main menu, tap **LC transfer**. The Transfer screen appears.

**NOTE:** The OBU records are automatically deleted after they have been successfully transferred to the LC.

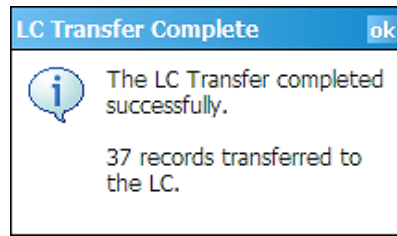
2. From the Transfer screen, tap **Transfer** to immediately begin transferring the stored OBU records to the LC. A blue Transfer Status bar indicates the progress of the transfer.

**Figure 3-8: Data transfer in progress**



3. After the records have been successful transfer, a confirmation message appears:

Figure 3-9: LC Transfer complete confirmation

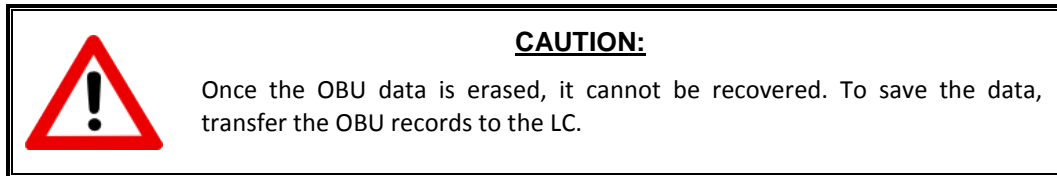


4. If any error messages appear, resolve the errors as outlined in LC Transfer Error messages, page 56.

## Erasing OBU data

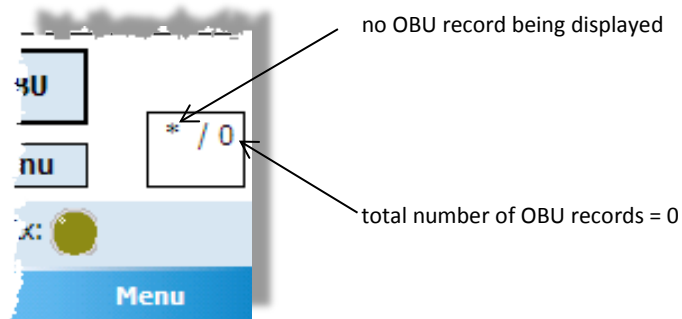
OBU data is automatically erased from the Portable RSE after it has been transferred to the LC. However, you can delete OBU data without transferring it to the LC. The only option available is to delete all OBU data; you cannot select specific records to delete.

Prerequisites: None.







1. From the Main menu, OBU Acquisition screen, Agency Screen, or Scratchpad Screen: Tap **Menu** in the bottom-right of the screen → tap **Config.** → tap the **OBU Data** tab.
2. Read the warning message. Tap **Erase OBU Data** → tap **OK** in the Erase OBU Data pop-up window to confirm → tap **Yes** in the second Erase OBU Data pop-up window to delete all OBU data.
3. When you return to the OBU Acquisition screen, the total number of OBU records will now be zero.

Figure 3-10: Zero OBU records



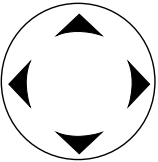




## Command and Controls

Command	How is this command executed?	What does this command do?	What is the purpose of this command?
 <p><b>Applications Manager</b></p>	Press the Applications Manager button.	displays the Applications Manager screen, which displays a list of the programs that are currently running on the device.	not used within the Portable RSE software
 <p><b>Context</b></p>	Press the Context button.	displays context information (ex. Help screens) depending on the current screen being displayed.	not used within the Portable RSE software.
 <p><b>Enter</b></p>	Press the Enter button.	functions as a normal Enter key.	not used within the Portable RSE software
 <p><b>Home</b></p>	Press the Home button.	displays the Windows Mobile 5.0 Today screen.	not used within the Portable RSE software

Portable RSE

Command	How is this command executed?	What does this command do?	What is the purpose of this command?
 <b>Power</b>	Press the Power button.	if pressed momentarily, suspends Portable RSE into Hibernate mode.  if pressed and held for approx. 1 second, displays Power Button menu.  If pressed and held for approx. 6 seconds, reboots the Portable RSE.	allows the user to Suspend, Reboot (Reset), or Power Off the Portable RSE.
 <b>Start</b>	Press the Start button.	displays the Start menu	to access the Settings necessary to set the time and calibrate the touchscreen
 <b>Navigation</b>	Press the Navigation button up, down, left, or right.	moves the cursors and scrolls through OBU records.	to scroll through the stored OBU records from the OBU Acquisition screen by pressing left or right.
<b>About</b>	From any screen (except the Config or Diagnostics screen),  tap <b>Menu</b> , then,  tap <b>About</b> .	displays the Portable RSE firmware and software versions.	to confirm the firmware and software of the Portable RSE are up to date.

## Portable RSE

Command	How is this command executed?	What does this command do?	What is the purpose of this command?
<b>Agency</b>	From the OBU Acquisition screen, tap <b>OBU Data</b> in the bottom-left corner, then, tap <b>Agency</b> .	displays the OBU Agency data.	to view the Agency data of the OBU data currently being viewed.
<b>Antenna</b>	Navigate to the Configuration screen: tap <b>Menu</b> in the bottom-right corner, then, tap <b>Config</b> .  From the Configuration screen, tap the <b>Config</b> tab, if necessary, then  select the appropriate <b>Antenna</b> from the drop-down box, then,  tap <b>OK</b> .	identifies which antenna is connected to the Portable RSE (either short range or long range).	to configure the antenna.
<b>Battery Power</b> (hibernate)	Navigate to the Configuration screen: tap <b>Menu</b> in the bottom-right corner, then, tap <b>Config</b> .  From the Configuration screen, tap the <b>Hibernate</b> tab, if necessary, then  select the <b>On Battery Power</b> check box and select a duration from the drop-down box, then,  tap <b>OK</b> .	enables automatic hibernation when the Portable RSE is running on battery power.	to enable the device to automatically enter Hibernate mode when running on battery power.  to select the duration of inactivity before the Portable RSE enters sleep mode.

## Portable RSE

Command	How is this command executed?	What does this command do?	What is the purpose of this command?
<b>Erase OBU Data</b>	<p>Navigate to the Configuration screen: tap <b>Menu</b> in the bottom-right corner, then, tap <b>Config</b>.</p> <p>From the Configuration screen, tap the <b>OBU Data</b> tab, if necessary, then, tap the Erase OBU Data button, then, tap <b>OK</b>, then tap <b>Yes</b> to confirm.</p>	deletes all OBU data stored on the Portable RSE.	to clear the OBU data without downloading it to the LC.
<b>External Power</b> (hibernate)	<p>Navigate to the Configuration screen: tap <b>Menu</b> in the bottom-right corner, then, tap <b>Config</b>.</p> <p>From the Configuration screen, tap the <b>Hibernate</b> tab, if necessary, then, select the <b>On External Power</b> check box and select a duration from the drop-down box, then, tap <b>OK</b>.</p>	enables automatic hibernation when the Portable RSE is running on AC power.	<p>to enable the device to automatically enter Hibernate mode when running on AC power.</p> <p>to select the duration of inactivity before the Portable RSE enters sleep mode.</p>
<b>LC Transfer</b>	<p>From the Main Menu screen: tap <b>LC Transfer</b>.</p>	displays the LC transfer screen.	to navigate to the LC transfer screen, where OBU data can be transferred to an LC.

## Portable RSE

Command	How is this command executed?	What does this command do?	What is the purpose of this command?
<b>Menu</b>	From any screen (except the Configuration, Diagnostic or About screen), tap <b>Menu</b> in the bottom-right corner.	displays a menu to select <b>Config</b> , <b>Diagnostics</b> , or <b>About</b> .	to allow the user to select the <b>Config</b> , <b>Diagnostics</b> , or <b>About</b> navigation buttons.
<b>Perform Health Check</b>	Navigate to the Diagnostics screen: tap <b>Menu</b> in the bottom-right corner, then, tap <b>Diagnostics</b> .  From the Diagnostics screen, tap <b>Perform Health Check</b> .	performs a diagnostic check of the Portable RSE.	to confirm that the Reader module is functioning properly and is communicating with the Field PC.
<b>Previous</b>	From the Agency or Scratchpad screen, tap <b>Previous</b>	displays the OBU Acquisition screen.	to return to the OBU Acquisition screen after viewing Agency or Scratchpad data.
<b>Read OBU</b> (navigation)	From the Main Menu screen: tap <b>Read OBU</b> .	displays the OBU Acquisition screen.	to navigate to the OBU Acquisition screen, where OBU data can be viewed and OBUs can be read.
<b>Read OBU</b> (read)	From the OBU Acquisition screen, tap <b>Read OBU</b> .	initiates an OBU Read attempt.	to read OBU data.
<b>Reporting Port</b>	this parameter is permanently set to <b>Serial</b> .	identifies which port is used for downloading data to the LC.	to configure communications to the LC.

## Portable RSE

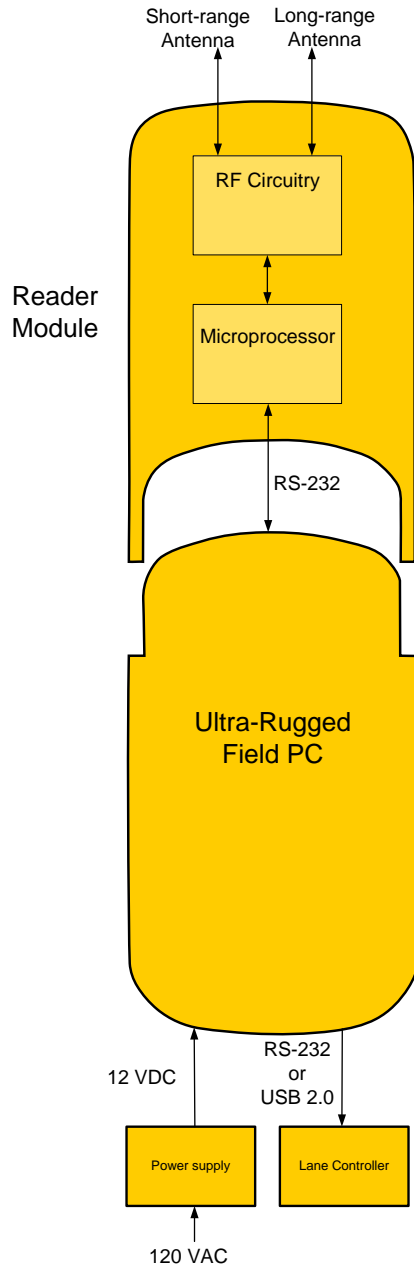
Command	How is this command executed?	What does this command do?	What is the purpose of this command?
<b>RF Power Level</b>	<p>Navigate to the Configuration screen: tap <b>Menu</b> in the bottom-right corner, then, tap <b>Config</b>.</p> <p>From the Configuration screen, tap the <b>Config</b> tab, if necessary, then, select the appropriate <b>RF Power Level</b> from the drop-down box, then, tap <b>OK</b>.</p>	sets the RF level used for communicating with the OBU when using the short range antenna.	to allow the user to configure an optimal power level used for communicating with the OBU with the short-range antenna.
<b>Scratchpad</b>	<p>From the OBU Acquisition screen, tap <b>OBU Data</b> in the bottom-left corner, then, tap <b>Scratchpad</b>.</p>	displays the OBU Scratchpad data.	to view the Scratchpad data of the OBU currently being viewed.
<b>Transfer</b>	<p>From the LC Transfer screen, tap <b>Transfer</b></p>	Initiates a download of OBU data to the LC.	to download the OBU data stored on the Portable RSE to the LC.

# MAINTENANCE INSTRUCTIONS

## 4. THEORY OF OPERATIONS

This section offers a more detailed overview of the RSE components than the introductory overview provided in Overview, Section 2, page 10. A functional block diagram of the Portable RSE is shown in Figure 4-1.

**Figure 4-1: Functional Block Diagram**





## RF Power Level settings

The RF signal level can be adjusted when the Portable RSE is configured to use the short-range antenna port. The RF Power level is fixed at **High** when the Portable RSE is configured to use the long range antenna port since the purpose of the long-range antenna port is to use the remote antenna with the Portable RSE. The RF Power Level settings available are outlined in Table 4-1. The Medium and Low power settings are recommended for use in confined spaces or when other OBUs are nearby.

**Table 4-1: RF power level settings**

RF Power Level	Function
Low	lowest RF signal level used to read OBUs
Medium	medium RF signal level used to read OBUs
High	highest RF signal level used to read OBUs
Auto	attempts to read an OBU at the lowest RF signal level, then increases the RF signal level until an OBU is successfully Read, or the Portable RSE has reached the maximum RF signal level.

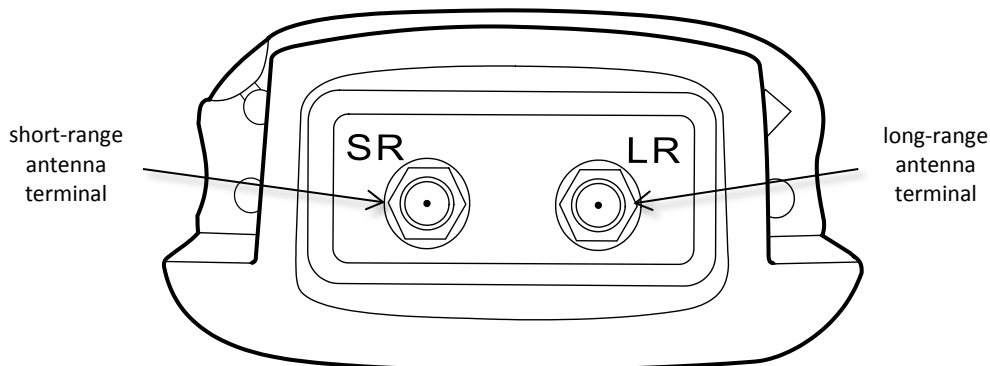
## 5. INSTALLATION AND CONFIGURATION

### Installing an antenna

There are two types of antennas available; a short-range antenna that can read OBUs from approx. 5 ft., or an optional remote antenna that can read OBUs from approx. 9 ft. After the antenna is installed, the Portable RSE must be configured to identify which antenna is being used.

1. Connect the antenna to the Portable RSE.
  - If installing the short-range antenna, connect the antenna to the **SR** terminal at the top of the Portable RSE.
  - If installing the remote antenna, connect the antenna to the **LR** terminal at the top of the Portable RSE.

Figure 5-1: Portable RSE antenna terminals (top view)



2. Connect the 50  $\Omega$  RF terminator to the unused antenna terminal.
3. Configure the Portable RSE antenna settings:
  - a) Navigate to the Configuration screen by tapping **Menu** in the bottom-right corner, tapping **Config.**, then tapping the **Config** tab.
  - b) From the **Antenna** drop-down box, select SHORT\_RANGE or LONG\_RANGE, depending on which type of antenna was installed in step 1.

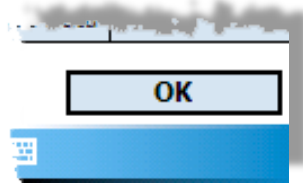
**NOTE:** When the Portable RSE antenna is configured for LONG\_RANGE, the RF Power is automatically set to HIGH and cannot be changed to ensure the maximum communication distance.

- c) From the **RF Power Level** drop down box, select the appropriate RF Power level.

**NOTE:** Tapping **ok** in the upper-right corner will exit the Config screen without making changes.

- d) Tap **OK** in the bottom-right corner to make changes and exit the Config screen.

Figure 5-2: OK button for committing configuration changes



## Configuring automatic suspending

You can configure the Portable RSE to suspend into Hibernate mode after a configurable duration. Configure Hibernate mode through the Portable RSE software as outlined in this procedure.





Prerequisites: None.

1. Navigate to the Configuration screen by tapping **Menu** in the bottom-right corner, tapping **Config**, then tapping the **Hibernate** tab.
2. To configure automatic Hibernate when the RSE is running on battery power, select the **On Battery Power** check box, then select a duration (between 1 and 5 min.) from the drop-down menu. The duration selected is the time the RSE is inactive while operating on battery power before going into Hibernate mode.
3. To configure automatic Hibernate when the RSE is running on AC power, select the **On External Power** check box then select a duration (between 1 and 30 min.) from the drop-down menu. The duration selected is the time the RSE is inactive while operating on external power before going into Hibernate mode.

## Configuring automatic backlight and screen dimming

Windows Mobile can be configured to dim the screen to reduce battery consumption without entering Hibernate mode.




Prerequisites: None.

1. Tap  → **Settings** → **System** tab → **Backlight** . The Backlight settings are displayed.
2. The backlight settings for running on battery power and external power are configured separately. Tap the applicable along the bottom of the Backlight screen to configure the appropriate settings.
3. Select **Turn off backlight if device is not used for** to enable backlight and screen dimming. Select a duration, from 10 sec. to 5 min., from the drop-down menu.
4. Select **Turn on backlight when a button is pressed or the screen is tapped**. If this option is not selected, the only way to return the screen to normal brightness is to suspend and then wake the Portable RSE.
5. Tap  to exit the Backlight screen, then tap  to return to the Portable RSE software.

## Setting the time and date

When the Portable RSE reads an OBU, the system time and date is used to record the read time. This procedure outlines how to set the system time and date.

Prerequisites: None.

1. Tap  → **Settings** → **System tab** → **Clock and Alarms**  → **Time tab**.
2. Change the **Home** time as required. Tap to highlight the hour, minute, seconds, day, month or year then tap on the arrow buttons to make changes.
3. Tap  in the upper-right corner of the screen. Click **Yes** to save changes.

## 6. TROUBLESHOOTING

### Troubleshooting Methodology

When troubleshooting Portable RSE issues, first connect the Portable RSE to external power to ensure the Portable RSE problems are not being caused by a defective battery. Then perform a Health Check (see Performing a Health Check on the Diagnostics screen, page 51). Troubleshooting trees are provided for the most common Portable RSE errors.

### Returning the Portable RSE for service

If the Portable RSE requires service please contact Kapsch TrafficCom for an RMA number. Do not attempt to service the device yourself.

### Performing a Health Check on the Diagnostics screen

Performing a Health Check examines the main internal components of the Portable RSE: the Application-Specific Integrated Circuit (ASIC), the Microprocessor Unit (MCU), and the communications between the Ultra-Rugged Field PC and the Reader module. Performing the Health Check produces one of the following results:

**Table 6-1: Health Check Status Results**

Health Check Status	Definition
OKAY	The Portable RSE successfully passed all tests.
ASIC ERROR	The ASIC is not functioning properly. Return the device for repairs.
MCU ERROR	The MCU is not functioning properly. Return the device for repairs.
HW ERROR	not currently used
COMMS ERROR	The communications interface between the Ultra-Rugged Field PC and the Reader Module is not functioning properly. Return the device for repairs.

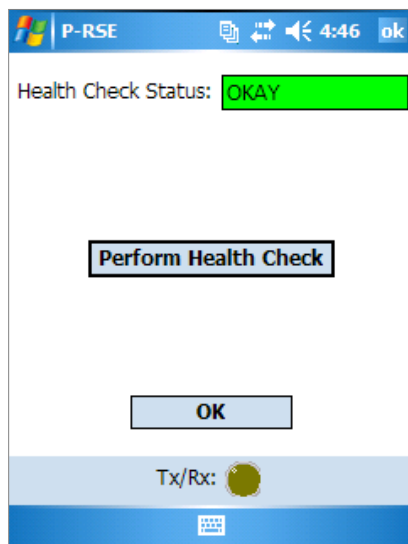
#### **To perform a Health Check:**

1. From any screen (except the Config or About screen), tap **Menu** in the bottom-right corner, then, tap **Diagnostics**. The Diagnostics screen appears.

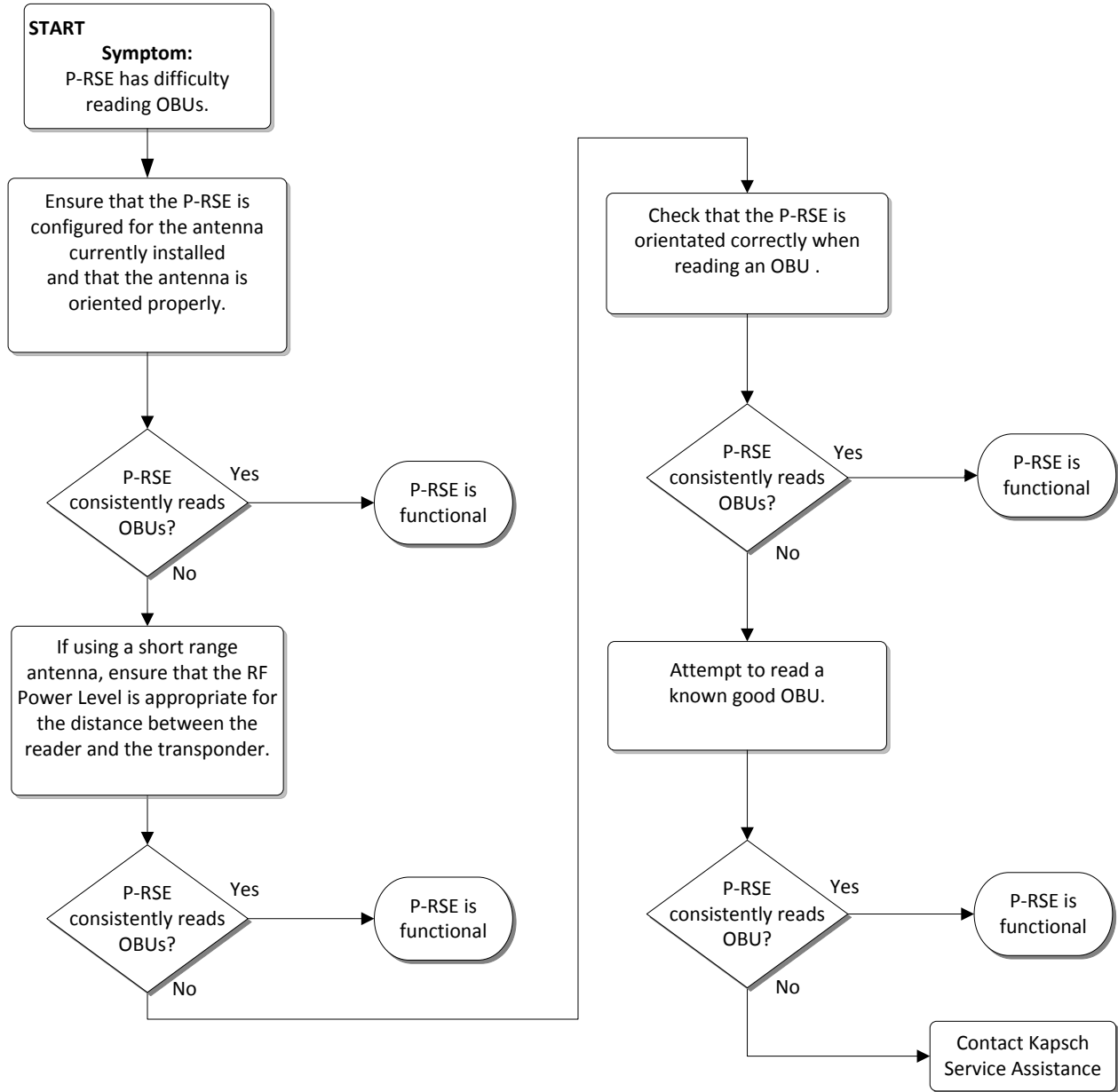
**NOTE:** The Health Check Status shown when the Diagnostics screen appears is the result from the previous Health Check.

2. To perform a new Health Check, tap **Perform Health Check**.
3. After a short delay while the tests are being performed, the Health Check Status is displayed (see Table 6-1: Health Check Status Results). If any errors appear, return the Portable RSE for repairs.
4. Tap **Ok** to exit the Diagnostics screen.

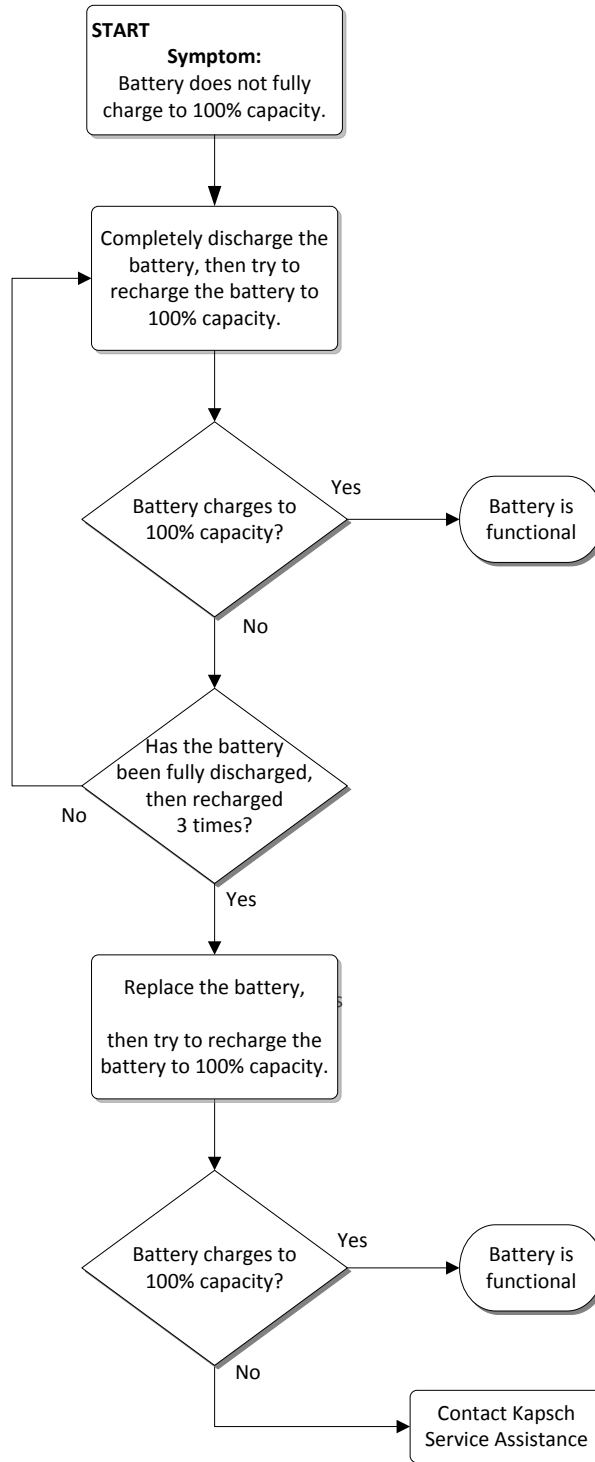
**Figure 6-1: The Diagnostics Screen**



### Troubleshooting tree: Difficulty reading OBUs consistently

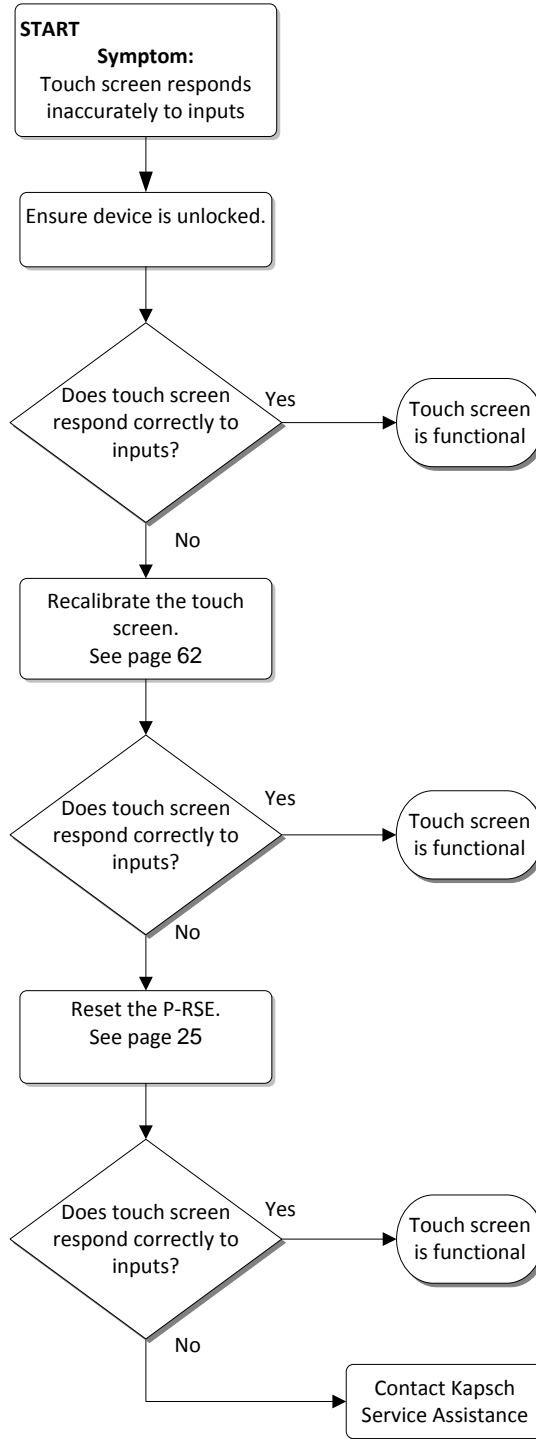


**Troubleshooting tree: Battery does not fully charge to 100% (0 mAH consumed)**





### Troubleshooting tree: Touchscreen responds inaccurately to inputs

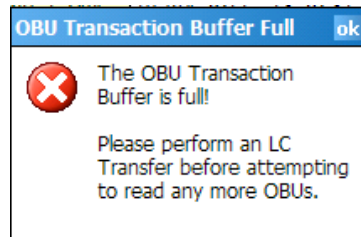


## LC Transfer Error messages

### OBU Transaction Buffer Full.

The Portable RSE can store a maximum of 1000 OBU records in its transaction buffer. Once the transaction buffer limit is reached, the message shown in Figure 6-2 appears. OBUs cannot be read until the transaction buffer is cleared.

Figure 6-2: OBU Transaction Buffer Full message

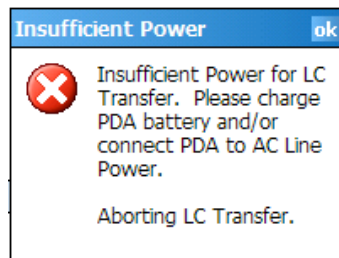


**Solution:** Download the OBU records to the lane controller (see Transferring Data to the LC, page 37), or, if absolutely necessary, permanently erase all OBU records (see Erasing OBU data, page 38). 24

### Insufficient Power (to transfer data to LC)

If battery power is low (approx. 10% or less), the error message in Figure 6-3 appears and OBU records cannot be downloaded to the LC to prevent the data transfer from being interrupted.

Figure 6-3: Insufficient Power message



**Solution:** Connect the Portable RSE to the external power supply.

## 7. MAINTENANCE PROCEDURES

### Cleaning the Portable RSE touch screen

Keep the touch screen clean to ensure the touch screen responds accurately to touch inputs.

**CAUTION:**

Do not clean the touch screen using tissues, paper towels or harsh cleaning agents as these can damage the device.

**CAUTION:**

Long exposure to the following solutions may damage the device:

- pine oil
- oil-based paint
- automotive brake cleaner
- isopropyl alcohol
- carburetor cleaner



1. Suspend the Portable RSE (see Suspending the Portable RSE, page 23).
2. Remove the screen protector, if applicable.
3. Apply water or a mild cleaning solution to a microfiber cloth and gently wipe off the touchscreen.
4. Wake the Portable RSE (see Waking the Portable RSE, page 23).

## Protecting the touchscreen

Protect the touchscreen from impact, pressure or abrasive substances that could damage it. To further protect the touchscreen, apply one of the adhesive screen protectors that come with your device.

## Calibrating the touchscreen

Calibrate the touchscreen to ensure that touch inputs are interpreted accurately.

1. Tap  → **Settings** → **System** tab → **Screen** .
2. From the **General** tab, tap **Align Screen**. The **Align Screen** window appears.
3. In the center of the **Align Screen** are crosshairs. Firmly and accurately tap the center of the crosshairs with a stylus. The crosshairs move to the upper-left corner of the **Align Screen**.
4. Continue firmly and accurately tapping the crosshairs as they move to the four corners of the **Align Screen**.
5. If calibration is successful, the **General** tab of the **Screen** settings appears after the upper-right crosshair is tapped and calibration is complete.
6. If calibration fails, the crosshairs reappear in the center of **Align Screen** and the calibration procedure repeats. Ensure you tap the center of the crosshairs firmly and accurately.
7. If calibration continues to fail:
  - Ensure an object is not lodged under the touch screen bezel.
  - Clean the touch screen with a microfiber cloth.
  - Inspect the touch screen for wear or damage. Contact Kapsch Service Assistance if the Portable RSE is damaged.

## Replacing the battery pack

Do not store or leave the device or battery pack near a heat source, or otherwise expose it to temperatures in excess of 140°F (60°C).

Use only Battery Packs approved for this device.

Do not try to open the battery pack

Do not short the external contacts on the battery pack

Do not install the battery pack backwards so that polarity is reversed.

Do not solder directly onto the battery pack.

Do not place the battery pack in direct sunlight.

In the rare event that the battery pack leaks and fluid get into the eye, do not rub the eye, rinse well with water and immediately seek medical care.

## Determining the software and firmware versions

To determine the Portable RSE software version and RSE main unit firmware version currently running on the Portable RSE:

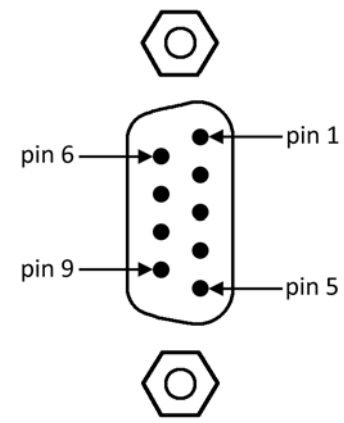
1. From any screen (except the Config or Diagnostics screen), tap **Menu** in the bottom-right corner, then, tap **About**.
2. The About screen appears, displaying the current software and firmware versions.

## 8. APPENDIX

### Technical Specifications and Pin outs

**Tech specs:**

The portable RSE is designed to operate over the temperature range of -22°F (-30°C) to 122°F (50°C). At temperatures below 14°F (-10°C) the Liquid Crystal Display (LCD) may respond more slowly or the display backlight may become dim to reduce the load on the battery power. To store the device in extreme temperatures (lower then -22°F or higher then 140°F, the battery pack must be removed from the unit).

Serial port pin out			
Connector Type			
9-pin serial port, male			
Pin Number	Signal	Description	Diagram
1	DCD	Data Carrier Detect input	
2	RCD	Receive Data input	
3	TXD	Transmit Data output	
4	DTR	Data Terminal Ready output	
5	GND	Ground	
6	DSR	Data Set Ready input	
7	RTS	Request to Send output	
8	CTS	Clear To Send input	
9	RI	Ring Indicator input	

## Reference Documents

ICD 360430-101	Interface Control Document for the Next Generation RSE External Hardware Interface.
ICD 360453-702	Portable RSE Reporting Interface Control Document
FSP-001	IAG Lane Tuning Procedure
322704-TAB	Calibration Procedures
322710-078	Gold Transponder and Production Tester Calibration and Maintenance Procedure

## Other commercial Documents:

14928-05	Field PC User Guide
----------	---------------------

## Acronyms and Synonyms

Term	Meaning	Reference, example, or explanation
Ant	Antenna	Antenna type displayed on OBU Acquisition screen
ASIC	Application-Specific Integrated Circuit	a circuit designed for a specific use
AU	Auto	Auto RF signal level enabled indication on OBU Acquisition screen
CF	Compact Flash	Compact flash card that converts the Compact Flash slot to an RS-232 port.
CRC	Cyclical Redundancy Check	
GUI	Graphical User Interface	The human-machine interface that presents information to the user and allows the user to control the software by using windows, icons and menus which can be manipulated by interacting with the touch screen.
HI	high	High RF signal level enabled indication on OBU Acquisition screen
HW	hardware	
IAG	Inter-Agency Group	A group of toll highway agencies regulating common tag content and use.
ICD	Interface Control Document	Specification of the protocol between two components.
LC	Lane Controller	Controls readers and receives data and alerts from RSEs.
LCD	Liquid Crystal Display	Thin flat display device, using multi-colored pixels in front of a light source
LED	Light Emitting Diode	Used as status indicators on Janus RSE
LO	low	Low RF signal level enabled indication on OBU Acquisition screen
LR	long-range	Long-range antenna port enabled indication on OBU Acquisition screen
MCU	Microcontroller Unit	
MD	medium	Medium RF signal level enabled indication on OBU Acquisition screen



## Portable RSE

Term	Meaning	Reference, example, or explanation
OBU	On Board Unit	Also referred to as a transponder or tag
Portable RSE	Portable Roadside Equipment	A hand-held device used to read On Board Units.
Pwr	Power	RF power level displayed on OBU Acquisition screen
RSE	Roadside Equipment	A device used to read On Board Units.
RF	Radio Frequency	Broadcast band transmission frequencies
SR	short-range	Short-range antenna enabled indication on OBU Acquisition screen