

IMPORTANT
Read carefully
before use!



Kathrein RFID UHF Readers



Copyright © 2017 Kathrein Solutions GmbH

All rights reserved. No part of this document may be reproduced, distributed, stored in a retrieval system, translated into any language or computer language or transmitted in any form or by any means, electronic, mechanical, photocopying, recording or otherwise, without the prior written permission of Kathrein Solutions GmbH.

Kathrein Solutions GmbH accepts no liability for omissions or inaccuracies in this document or in relation to the provision or use of the information contained in this document. Kathrein Solutions GmbH reserves the right to change the products described in this document at any time without notice and does not accept any liability in relation to the application or usage of the products described in this manual. The latest version of this manual is available at our website www.kathrein-solutions.com.

Information provided in this manual is intended to be accurate and reliable. However, Kathrein Solutions GmbH assumes no responsibility for its use; nor for any infringements of rights of third parties which may result from its use.

This document and the information contained in it are proprietary information of Kathrein Solutions GmbH and must be treated as confidential. Kathrein Solutions GmbH provides this document to its customers in connection with contacts of sale for the products described therein. If the person in possession of this document, being a legal or natural person, is not a contractual sales partner of Kathrein Solutions GmbH, or Kathrein Solutions GmbH has not intended him by other means as the recipient of the document and the information contained therein, the person in possession is hereby informed that the use of this document is unlawful and a violation of the rights of Kathrein Solutions GmbH.

Contents

1	Preface	6
2	About This Guide	6
3	Explanation of Symbols and Signal Words	7
3.1	Symbols	7
3.2	Signal Words	7
3.3	Other Symbols	7
4	Professional Installation Guidelines for the U.S.	8
4.1	Installation Personnel	8
4.2	External Antenna	8
4.3	Final Output Power	8
5	Safety Instructions	9
5.1	General Safety Instructions	9
5.2	CE Marking for the Kathrein RFID Readers with the Type Designation ETSI	10
5.3	FCC and ISED Canada Regulatory Information	10
5.3.1	Radiation Exposure Statements	11
5.3.2	Safety Instructions	12
5.3.3	Recommended Antenna Types	12
6	Warranty Information	13
7	Introduction to the RIFD System	14
7.1	RFID System	14
7.2	Kathrein RFID Antenna Interface ©KRAI	15
7.2.1	WIRA 70 ©KRAI Polarisation Switch Antenna (PLS)	15
7.2.2	©KRAI SMSH (Smart Shelf) Antenna	17
7.3	Further Reference Material	18
8	The Reader	19
8.1	Functional Specification	19
8.2	Features	19
8.3	Scope of Delivery	19
8.4	Accessories	20
8.4.1	Antennas	20
8.4.2	Antenna Cables	20
8.4.3	Antenna Adapters	20
8.4.4	Antenna Mounting Accessories	20
8.4.5	Antenna Protective Cover	21
8.4.6	Reader Connecting Cables	21
8.4.7	Reader AC/DC Adapters	21
8.4.8	PoE+ Power Supply Unit	21
8.4.9	Reader and Antenna Wall/Pole Mounting Kit	21
8.4.10	Reader Protective Covers	21
9	Connections and Displays	22
9.1	Front View	22
9.2	Rear View	23
9.2.1	GPIO	24
9.2.2	Power Supply	24
9.2.3	Ethernet	25
9.2.4	Buzzer	25
10	Installing the Reader	26
10.1	Selecting the Installation Site	26
10.2	Installing the Reader	27
10.2.1	Wall Mounting	28
10.2.2	Wall/Pole Mounting	28

11	Transmission Methods	29
11.1	UART transmission (RS232, RS422, RS485 or similar)	29
11.1.1	Physical Layer	29
11.1.2	Data Link Layer	29
11.2	LLRP Protocol	30
11.3	Ethernet Transmission	31
11.3.1	Ethernet Transmission Generation 2 Readers	31
11.3.2	Ethernet Transmission Generation 3 Readers	31
12	Connecting the Reader	33
12.1	Connecting Digital Inputs and Outputs	33
12.2	Connecting the Antenna	36
12.3	Turning the Reader On and Off	36
12.4	Reading the PWR LED Indications	36
13	Operating <i>ReaderStart</i> Software	37
13.1	System Requirements	37
13.2	Installing the Software	37
13.3	Connecting the Reader in the <i>ReaderStart</i> Software	40
13.3.1	Requirements	40
13.4	Navigating in the <i>ReaderStart</i> User Interface	43
13.4.1	Menu Bar	43
13.4.2	Status Field	57
14	Operating the Reader Using the <i>ReaderStart</i> Software	58
14.1	Communication	58
14.1.1	Ethernet Section	58
14.1.2	Communication Configuration Linux Module	61
14.2	Application	69
14.2.1	Available Applications	71
14.3	Basic Reading	72
14.3.1	Mode	73
14.3.2	Starting and Stopping the Reading	73
14.3.3	Statistics	74
14.3.4	Options	75
14.3.5	Grouping	76
14.3.6	Expert settings	76
14.3.7	ARU-CSB-ELC Antenna Reader Unit	77
14.4	LED	78
14.4.1	Selecting Functions	79
14.5	RSSI LED Bar (received signal strength indicator)	80
14.6	GPIO Functions	81
14.6.1	IO Configuration	81
14.6.2	Test Input and Output	82
14.6.3	Action List and Assign Input to Action List	83
14.7	Expert Settings 1	85
14.7.1	Port Power	87
14.8	Expert Settings 2	88
14.8.1	Default Parameter Set	88
14.8.2	Copy Parameter Set	88
14.8.3	Change Reader Parameter	89
14.8.4	Select Filter Settings	89
14.8.5	Applying a Select Filter (Example)	90
14.9	Test Gen 2 Functions	91
14.9.1	Get All Tags	91
14.9.2	Password for Operation	92
14.9.3	Write EPC	92
14.9.4	Read Data	93
14.9.5	Write Data	94

14.9.6	Change Password	95
14.9.7	Lock	96
14.9.8	Kill	97
14.10	@KRAI	98
14.10.1	Polarisation	99
14.10.2	LED	99
14.10.3	Jumper Cable Attenuation	100
14.10.4	Direction	100
14.11	AppManager	101
14.11.1	Currently Available Apps	101
14.11.2	Installing an App	102
14.12	TagScan	103
14.13	Spectral Scan	105
14.14	Authentication	106
14.14.1	Key	106
14.14.2	Functions	107
15	Contact Information	110
16	Waste Disposal	111

1 Preface

Dear customer,

Please follow all the information given in this GUIDE. KATHREIN Solutions GmbH has made every effort to ensure the information and descriptions are correct and complete.

We reserve the right to make changes to this guide without prior notice. In particular, this applies to changes made due to technical advancements.

2 About This Guide

This document describes installation, configuration and operation of the reader. Furthermore, it provides detailed technical data in order to better familiarise the user with the features of the reader.

The target group of this guide is specialist personal who install, configure and put the reader into operation.

This document is valid for all Generation 3 Kathrein RFID readers.





Tip This document applies to all Generation 3 Kathrein RFID readers. Even if it's referred to in the text as RRU 4xxx, it is possible to control all other readers of the RRU 4xxx and ARU 3xxx series using the same commands.

Tip Keep these instructions for further reference, and if the device passes to another owner, pass them on to the new owner.

- ▶ For more information, visit our website www.kathrein-solutions.com.
 - ⇒ The manuals are available for download at the internet product page.

3 Explanation of Symbols and Signal Words

3.1 Symbols

	General warning sign
	Fire hazard
	Radiation hazard
	Risk of material damage or malfunction in safety instructions or call for attention

3.2 Signal Words

Warning	This signal word indicates a hazard with a medium level of risk which can lead to death or severe injuries.
Caution	This signal word indicates a hazard with a low level of risk which can lead to minor or moderate injuries.
Notice	This signal word indicates a hazard which can lead to damage to property or malfunction.
Tip	This signal word indicates useful tips and recommendations.

3.3 Other Symbols

Symbol	Meaning
▶	Operating instruction
1, 2, 3...n	Operating instructions in a fixed order
⇒	Result of an operating instruction
✓	Condition for the execution of an operating instruction
•	List/list entry
<i>Program</i>	connections on the reader; push buttons in the user interface of the <i>ReaderStart</i>
dbfdbfdb	commands and file names
<i>Putty</i>	cross references within the text, proper names or titles of other documents
www.putty.org	hyperlinks
<i>Browse</i>	homepage/Windows elements

4 Professional Installation Guidelines for the U.S.

4.1 Installation Personnel



UHF RFID readers require professional installation!

- ▶ You must be a professional installer with RF and related rule knowledge.
- ▶ The installation requires special trained professionals to access and setup the system.
- ▶ The system is not to be installed by the general public, general user shall not attempt to install the device or change the settings.

4.2 External Antenna



- ▶ You must follow Part 15 of the FCC rules, and specifically Part 15.203 pertaining antenna requirements of an intentional radiator.
- ▶ Make sure to use a 13 dBi or less patch antenna.
- ▶ Only use antennas which have been approved by the applicant. The use of none-approved antenna(s) may produce unwanted spurious emissions or excessive RF transmitting power which may lead to the violation of the FCC/ISED limit and is prohibited.

4.3 Final Output Power



WARNING

- ▶ Carefully select the installation position.
- ▶ Make sure that the final output power does not exceed the limit set in relevant rules. The violation of the rule could lead to serious federal penalty!



If you are not a professional installer, **STOP**.

- ▶ Do not proceed any further with the installation.
- ▶ Do not install the unit or change the settings.

5 Safety Instructions

5.1 General Safety Instructions



WARNING

Danger to life from electric shock! Fire hazard!

Improper interventions in the device may jeopardise its electrical safety. Unauthorized changes to the unit and the use of spare parts and peripheral devices which are not sold or recommended by the manufacturer can result in fire, electric shock and injuries.

The manufacturer accepts no liability for accidents caused by the user opening or changing the device. Opening the device and attempting to repair it yourself voids all warranty and guarantee claims. The applicable version of the manufacturer's guarantee is that which was valid at the time of purchase. We accept no liability for unsuitable manual or automatic adjustments made to the unit's parameters and inappropriate use of the unit.

- ▶ Make sure that all the connection, installation and maintenance work as well as all other work on the unit is carried out by properly qualified and trained staff.
- ▶ Make sure that the installation team is properly qualified, familiar with and comply with the safety regulations applicable in the respective country.
- ▶ Do not open, change or damage the device and its components.
- ▶ Make sure that any repairs on the device are carried out by personnel authorised to perform them.
- ▶ Keep and operate the device out of reach of children.
- ▶ Do not modify, remove or disfigure the notices and markings applied by the manufacturer.
- ▶ Only use the unit for the purpose intended by the manufacturer.
- ▶ Before each use, make sure that the device is not damaged.
- ▶ Only use the power supply unit supplied.
- ▶ Make sure that the power supply cable is not damaged.
- ▶ Make sure that a unit with a damaged power supply cable is repaired by an electrical specialist before being used again.



WARNING

Danger to life from electric shock or fire hazard due to incorrect voltage, insufficient ventilation, moisture, direct sunlight, heat or naked flames!

If the supply voltage is too high, there is a risk of fire.

- ▶ Make sure the unit is operated only at the stated supply voltage; see the rear of the device or the external power supply unit.
 - ▶ When installing the unit in cabinets or shelves, make sure there is sufficient ventilation.
 - ▶ Do not cover the ventilation slots on the unit.
 - ▶ Protect the unit from moisture, dripping and splash water.
 - ▶ Do not operate the unit in damp areas.
 - ▶ Only use the unit in a moderate climate, not in tropical conditions.
 - ▶ Do not place any liquid-filled items on top of the unit.
 - ▶ Do not expose the unit to inadmissible heat, direct sunlight or fire.
 - ▶ Do not install the device close to the sources of heat, e.g. heating.
 - ▶ Do not place anything with a naked flame on the device.
-



5.2 CE Marking for the Kathrein RFID Readers with the Type Designation ETSI



WARNING

Danger to life due to radiation electromagnetic field!

This reader is designed ETSI for operation according to EN 302208. In some circumstances, heart pacemakers may suffer interference if wearers are close to the antenna when the unit is in operation (reader and antenna).

- ▶ When the unit is operated with antennas connected, comply with the human exposure regulations in accordance with EN 50364.
- ▶ Ensure a minimum clearance of 35 cm between the antenna and the human body.
- ▶ Comply with the operating instructions for RFID antennas.
- ▶ In case of doubt, make sure people with pacemakers contact the manufacturer of their pacemaker or their doctor.

5.3 FCC and ISED Canada Regulatory Information



The operator and the specialist company which carries out the installation are responsible for ensuring that only certified systems are used in the United States. Use of this system in any other combination (e.g. several antennas which transmit the same information in the same location) is expressly prohibited. Changes or modifications not expressly approved by the party responsible for compliance could void the user's authority to operate the equipment.

To meet the certification regulations according to Part 15 of the FCC regulations in the United States:

- ▶ Make sure the operation is subject to the following two conditions: (1) this device may not cause harmful interference, and (2) this device must accept any interference received, including interference that may cause undesired operation.
- ▶ Make sure the unit is properly installed, see *FCC RF Radiation Exposure Statement, p. 11* and *ISED RF Radiation Exposure Statement, p. 11*.

The readers with the identifier FCC are designed to operate under FCC Part 15 and can be found at the FCC homepage under grantee code WJ9. This device complies with Part 15 of the FCC Rules and with ISED license-exempt RSS standard(s).

Operation is subject to the following two conditions: (1) This device may not cause harmful interference, and, (2) This device must accept any interference received including interference that may cause undesired operation.

ISDE

Le présent appareil est conforme aux CNR d'ISDE applicables aux appareils radio exempts de licence. L'exploitation est autorisée aux deux conditions suivantes : (1) l'appareil ne doit pas produire de brouillage, et (2) l'utilisateur de l'appareil doit accepter tout brouillage radioélectrique subi, même si le brouillage est susceptible d'en compromettre le fonctionnement.

Under ISED regulations, this radio transmitter may only operate using an antenna of a type and maximum (or lesser) gain approved for the transmitter by ISED.

- ▶ To reduce potential radio interference to other users, choose the antenna type and its gain such that the equivalent isotropically radiated power (EIRP) is not more than that necessary for successful communication.

En vertu des réglementations d'ISDE, cet émetteur radio ne peut être utilisé qu'avec une antenne de type et un gain maximum (ou inférieur) approuvé pour l'émetteur par ISDE.

- ▶ Pour réduire les interférences radio potentielles avec d'autres utilisateurs, choisissez le type d'antenne et le gain de sorte que la puissance isotrope rayonnée équivalente (PIRE) ne soit pas supérieure à celle nécessaire pour une communication réussie.

This radio transmitter has been approved by ISED to operate with the antenna types listed in *Recommended Antenna Types, p. 12* with the maximum permissible gain and required antenna impedance for each antenna type indicated.

Cet émetteur radio a été approuvé par ISDE pour être utilisé avec les types d'antennes énumérés dans *Recommended Antenna Types*, p. 12 avec le gain maximum admissible et l'impédance d'antenne requise pour chaque type d'antenne indiqué.

Modifications or conversions which are carried out on this unit without the express permission of Kathrein may invalidate the FCC permit for the operation of this unit.

5.3.1 Radiation Exposure Statements



WARNING

Danger to life due to radiation electromagnetic field!

- ▶ As a result of the RF exposure information given in the *FCC RF Radiation Exposure Statement*, p. 11 and *ISED RF Radiation Exposure Statement*, p. 11. Ensure a minimum clearance of 35 cm between the antenna and the human body.
 - ▶ Comply with the operating instructions for RFID antennas.
 - ▶ In case of doubt, make sure people with pacemakers contact the manufacturer of their pacemaker or their doctor.
-

FCC RF Radiation Exposure Statement

This transmitter must not be co-location or operating in conjunction with any other antenna or transmitter.

This equipment complies with FCC RF radiation exposure limits set forth for an uncontrolled environment.

- ▶ Make sure this equipment is installed and operated with a minimum distance of 23 centimetres between the radiator and your body.

ISED RF Radiation Exposure Statement

This equipment complies with ISED RSS-102 radiation exposure limits set forth for an uncontrolled environment.

- ▶ Make sure this equipment is installed and operated with a minimum distance of 34 centimetres between the radiator and your body.

ISDE Déclaration d'exposition aux radiofréquences

Le présent appareil est conforme aux limites d'exposition aux radiofréquences d'ISDE CNR-102 définies pour un environnement non contrôlé.

- ▶ Assurez-vous que cet équipement est installé et utilisé avec une distance minimale de 34 centimètres entre le radiateur et votre corps.

5.3.2 Safety Instructions



NOTICE

Risk of harmful radio communication interference!

Following corresponding tests, it has been ascertained that this unit adheres to the limit values for class B digital units in accordance with Part 15 of the FCC regulations. These limit values are intended to provide private user's systems with appropriate protection against harmful radio interference. This unit generates and uses energy in the radio frequency range and is also able to radiate this; if it is not installed and used in accordance with the regulations, the unit may cause harmful radio communication interference. However, there is no guarantee that interference will not occur in a specific system. If this unit causes harmful radio or television reception interference, which can be ascertained by switching the unit on and off, we recommend that the user attempts to rectify this interference via one or more of the following measures.

- ▶ Turn the unit on and off to make sure the radio or television reception interference is caused by the unit.
- ▶ Realign the receive antenna or change its position.
- ▶ Increase the distance between the unit and the receiver.
- ▶ Plug the unit into a socket in a current circuit other than that to which the receiver is connected.
- ▶ Seek advice from the retailer or an experienced radio/television technician.

5.3.3 Recommended Antenna Types

Antenna types not included in this list or having a gain greater than the maximum gain indicated for that type are strictly prohibited for use with this device.

Les types d'antennes non inclus dans cette liste ou avec un gain supérieur au gain maximum indiqué pour ce type sont strictement interdits pour l'utilisation avec cet appareil.

Order number	Type	Shortened designation	Gain	
			circular	linear
52010087	WIRA-30-circular-FCC	wide-range 30° antenna FCC, 902–928 MHz, 30° circular	11 dBiC	8 dBi
52010228	WIRA-30-CSB-KRAI-FCC	wide-range 30° CSB KRAI antenna FCC, 902–928 MHz, 30° circular	6 dBiC	3 dBi
52010249	WIRA-30-linear-FCC	wide-range 30° antenna FCC, 902–928 MHz, 30° linear	n.a.	11 dBi
52010252	WIRA-40-linear-FCC	wide-range 40° antenna FCC, 902–928 MHz, 40° linear	n.a.	13 dBi
52010079	WIRA-70-circular-FCC	wide-range 70° antenna FCC, 902–928 MHz, 70° circular	8.3 dBiC	5.3 dBi
52010194	WIRA-70-KRAI-FCC	wide-range 70° KRAI antenna FCC, 902–928 MHz, 70° circular	7/7/n.a./n.a.	4.5/4.5/ 7.5/7.5
52010083	MIRA-100-circular-FCC	mid-range antenna FCC, 902–928 MHz, 100° circular	2.5 dBiC	–0.5 dBi
52010172	S-MIRA-100-circular-ETSI-FCC	short Mid-range antenna ETSI/FCC, 865–928 MHz, 100° circular	–10 dBiC	–13 dBi
52010085	LORA-FCC	low-range antenna FCC, 902–928 MHz	–12 dBiC	–15 dBi

52010092	U-LORA-ETSI-FCC	ultra Low-range antenna FCC, 865–928 MHz	-27 dBiC	-30 dBi
52010219	SMSH-30-30-ETSI-FCC antenna modul	SMSH antenna/-module, 865–928 MHz, circular	-7 dBiC	-10 dBi
52010258	SMSH-30-30-KRAI-ETSI-FCC antenna	SMSH KRAI antenna/-module, 865–928 MHz, circular	-7 dBiC	-10 dBi
52010318	SMSH-HighGain-30-30- KRAI-FCC	SMSH antenna/-module, 902–928 MHz, circular	5 dBiC	2 dBi
52010319	SMSH-HighGain-30-30-FCC	SMSH antenna/-module, 902–928 MHz, circular	5 dBiC	2 dBi
52010334	WRA 7070 Antenna Unit	wide-range antenna, 902–928 MHz, circular	8.5 dBiC	5.5 dBi
52010336	WRA 7070 KRAI Antenna Unit	wide-range antenna, 902–928 MHz, circular/linear	7/7/n.a./n.a.	4.5/4.5/ 7.5/7.5

6 Warranty Information



Switching on the AC or DC power supply prior to connecting the LAN cable is considered incorrect installation. Any functional defect arising as a result is excluded from the warranty/guarantee. Kathrein accepts no liability if the customer fails to implement the precautions listed here. In such cases, any claims under the warranty/guarantee are void.

- ▶ Before installing or servicing the reader, make sure that the person concerned has read the manual and understood its contents.

7 Introduction to the RFID System

7.1 RFID System

An RFID system is comprised of the control computer of the reader, antennas, antenna connection cables and the tags. The figure below shows the schematic structure of the system:

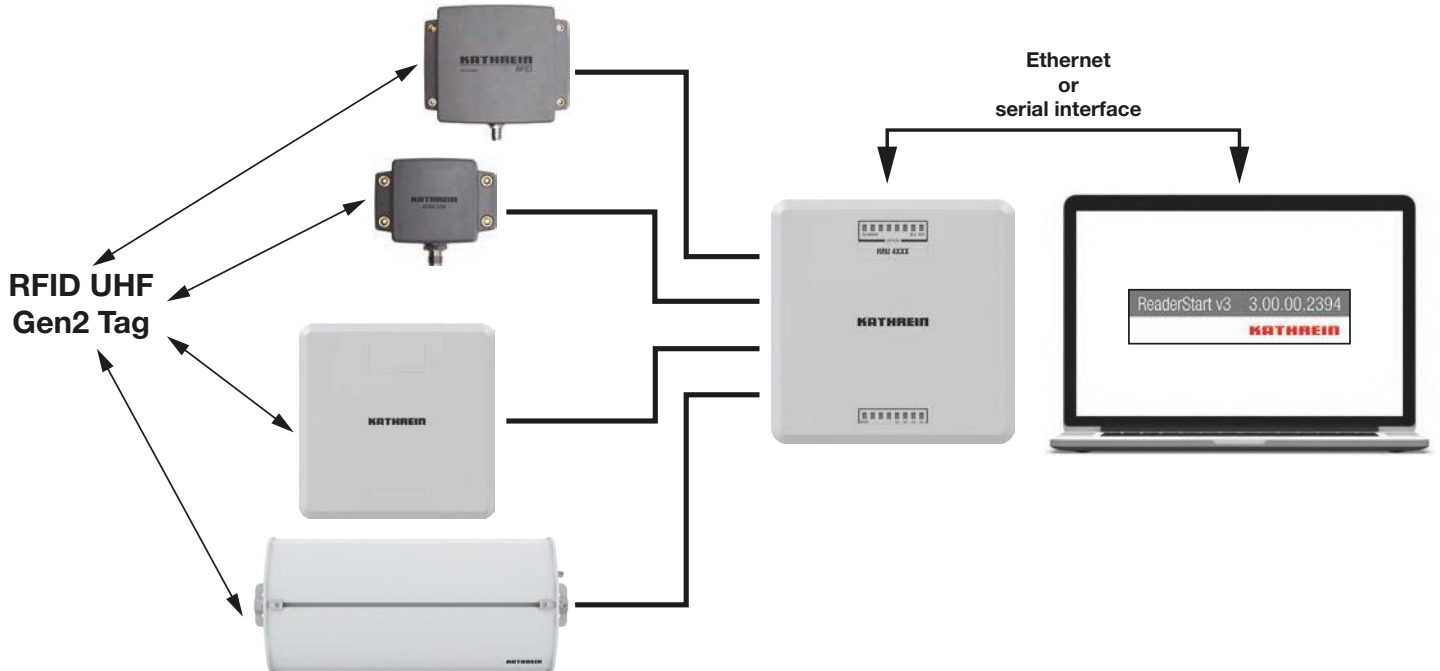

Fig. 1: RFID system (example)

The tags consist of an antenna and a small chip. The chip is the true carrier of the information, the EPC (*Electronic Product Code*) number. This number can identify products or product groups. Alternatively, the EPC can be overwritten with new information.

To read the tag information, the reader switches on an RF carrier by means of a selected antenna, thus supplying the tags in the RF field with energy.

To read the information from a tag, it is necessary to inventory the tags and then select a tag from the population of tags. Upon successful completion of the inventory, the EPC number of each tag can be read and sent to the PC. It is possible to attach additional information to the EPC, for example, the antenna which read it or the time at which it was read.



NOTICE

The reader operates using the frequency hopping process to avoid faults and interference between readers. Within the FCC area, this procedure is mandatory. The reader changes its transmission frequency randomly, with equal distribution across the 52 available channels. Each channel is used for max. 400 ms in an interval of 20 s.

The *ReaderStart v3* software can be used for testing and parametrising.

The communication between the *ReaderStart v3* and the reader is based on the DLL (*Dynamic Link Library*), which includes the communication protocol, see *Communication Protocol Kathrein RFID UHF Readers*. For specific applications, the user can build its own control software based on the reader DLL. The DLL includes all the relevant commands and functions required to control the reader.

It is necessary for the user to create his own control software. The user-specific control software can run directly on the reader. Therefore, a stand-alone operation without permanent network connection is possible.



To be able to use the complete range of the reader performance in customer applications, we recommend using the readers ARU 3500 or RRU 4500. It is not possible to run any customer applications on the basic ARU 3400 and RRU 4400 readers.

7.2 Kathrein RFID Antenna Interface ©KRAI

With the ©KRAI product series, Kathrein has introduced a revolutionary system. By using Kathrein ©KRAI antennas, it is possible to increase the flexibility due to having several antenna properties at one installation point (in case of PLS and CSB antennas) and functionality (when cascading SMSH antennas).

©KRAI consists of a digital control bus which enables connection between the RFID reader and the RFID antennas to allow control and regulation tasks in remote antennas

7.2.1 WIRA 70 ©KRAI Polarisation Switch Antenna (PLS)

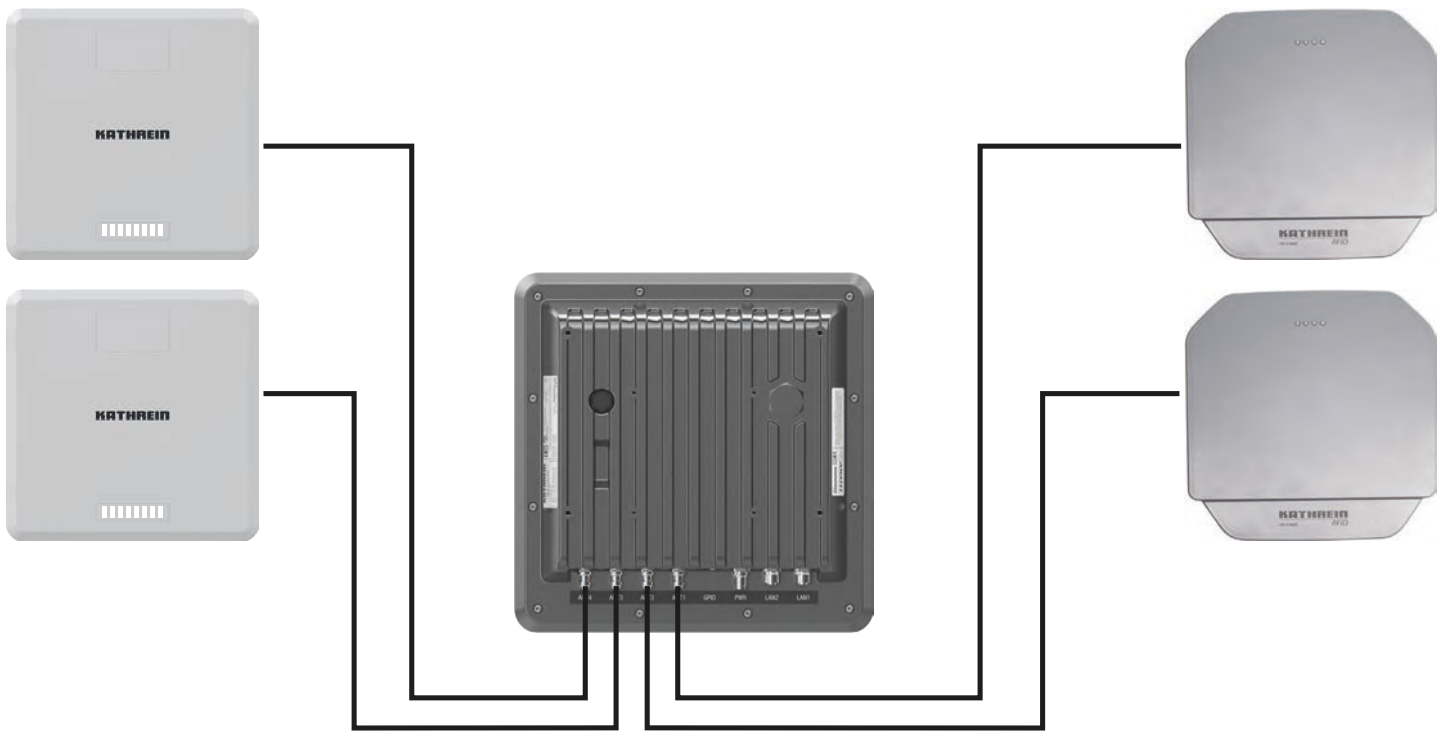

Fig. 2: PLS antennas connected to the reader

With the ©KRAI PLS antenna, built as a WiRa 70° antenna, the polarisation can be switched statically or dynamically. The following settings are possible in any combination:

- circular LHCP
- circular RHCP
- linear horizontal
- linear vertical.

It is possible to select the best polarisation for wide-range application and to carry out a flexible adjustment of the antenna on site.

Furthermore, it is possible to increase the read rate via the switching circular LHCP/RHCP by up to 33%.

Type	Order number	Far-field half-power beam width	Polarisation	Frequency range
WIRA 70 ©KRAI ETSI	52010193	70°/70°	circular	865–868 MHz
WIRA 70 ©KRAI FCC	52010194	70°/70°	circular	902–928 MHz
WRA 7070 ©KRAI ETSI	52010335	70°/70°	circular	865–868 MHz
WRA 7070 ©KRAI FCC	52010336	70°/70°	circular	902–928 MHz

Tip PLS antennas have 4 LEDs to visualise customer applications. The LEDs will be supplied and controlled by the RRU 4xxx reader via the existing antenna cable.

Tip Note that for the internal antenna, the ARU 3560 reader has all four polarisations already built in. The ARU 3560 reader cannot switch polarisation for external antennas.

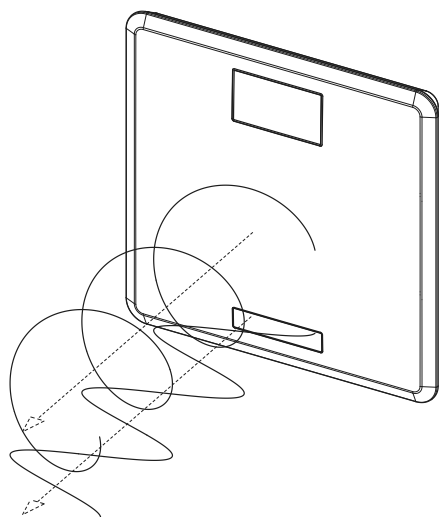

Fig. 3: Circular and linear polarisation

7.2.2 ©KRAI SMSH (Smart Shelf) Antenna

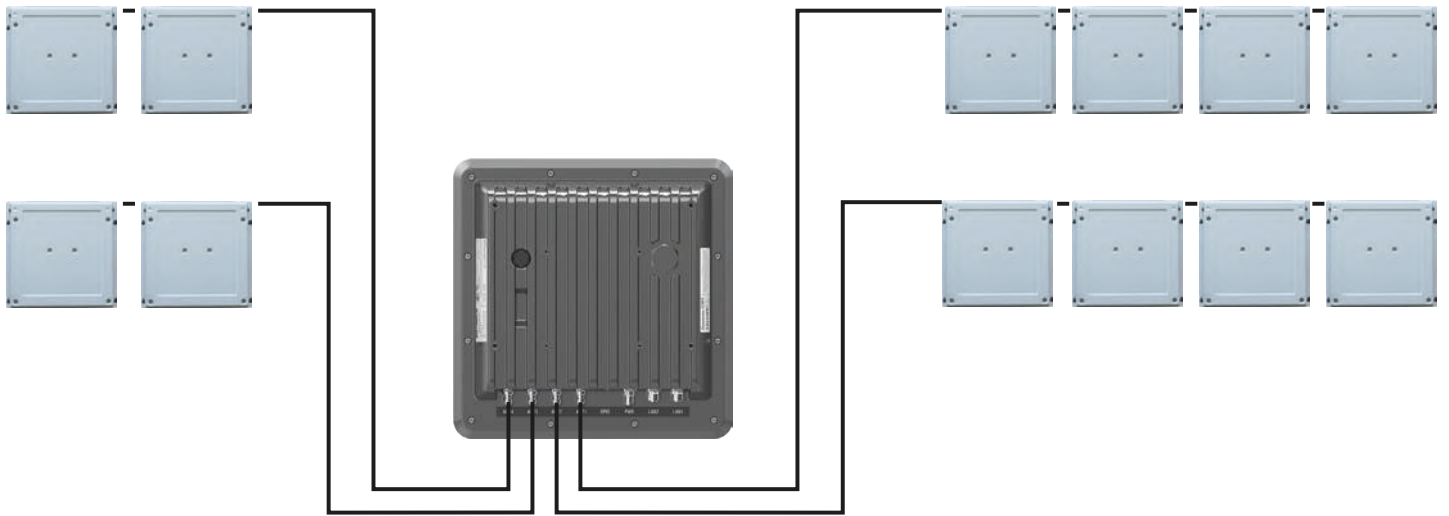

Fig. 4: ©KRAI smart shelf antennas connected to the reader (cascaded)

Up to 8 ©KRAI smart shelf (SMSH) antennas can be cascaded per reader port; 8 antennas x 4 ports = 32 SMSH antennas in total.

The SMSH 3030 ©KRAI slave antenna was developed for applications in the field of point of sale, smart shelf applications and Kanban solutions. The antenna is characterised by an extremely homogeneous read zone, which is emitted by the high front-to-back ratio. Therefore, it is suitable for static detection of multiple transponders. Due to the extremely thin design, the antenna module can be integrated into different applications.

The antenna is equipped with an intelligent bypass circuit that allows for cascading up to 8 SMSH antennas per reader port. The control is done by a RRU 4xxx Kathrein RFID reader. The ©KRAI control signals are transmitted via the standard antenna cable.

Type	Order number	Far-field half-power beam width	Polarisation	Frequency range
SMSH 3030 ©KRAI ETSI FCC antenna	52010258	60°/60°	circular	865–928 MHz
SMSH high-gain 3030 ©KRAI ETSI antenna	52010259	60°/60°	circular	865–868 MHz
SMSH high-gain 3030 ©KRAI FCC antenna	52010318	60°/60°	circular	902–928 MHz

Tip Note that the ©KRAI SMSH high-gain antennas have a read range of up to 3 m. The ©KRAI SMSH standard antennas read transponders at a distance of up to 1 m.

Tip Note that the SMSH high-gain antennas (order no. 52010260) and SMSH standard antennas (order no. 52010219) do not have ©KRAI and cannot be cascaded.

7.3 Further Reference Material

In order to configure the reader correctly and adapt it to the respective application, it is necessary to have detailed knowledge of the EPCglobal standards of GS. This standard describes the principle of operation of the interface between the tag and the reader.

The parameters available for the configuration of the reader are described in the *Configuration Manual for Kathrein RFID UHF Readers*.

The reader is controlled via the Kathrein reader protocol (KBRP), the current version of which is described in detail in the *Communication Protocol Kathrein RFID UHF Readers*.

Document	Application
<i>Communication Protocol Kathrein RFID UHF Readers</i>	software development
<i>Configuration Manual for Kathrein RFID UHF Readers</i>	commissioning
<i>Installation Manual for Kathrein Antennas</i>	setup and installation
<i>EPCglobal Gen2 Specification¹⁾</i>	software development
<i>Putty – SSH Client (http://www.putty.org)</i>	software development



Make sure the version of the document matches the software version of the reader, see <https://www.kathrein-solutions.com/get-started>.

¹⁾ EPC™ Radio-Frequency Identity Protocols Class-1 Generation-2 UHF RFID Version 2.0.1 at <https://www.gs1.org/epcrfid/epc-rfid-uhf-air-interface-protocol/2-0-1>.

8 The Reader

8.1 Functional Specification

The Kathrein RFID (Radio Frequency Identification) reader of the RRU 4xxx and ARU 3xxx series is a multi-protocol-capable device for reading active and passive RFID tags in the frequency range from 865 to 868 MHz for Europe and 902 to 928 MHz for the American market. Based on the latest RFID standards, such as *EPC Gen2v2/ISO 18000-63*, the Kathrein RRU 4xxx series support all market leading transponder chip features for security, authentication and encoding. As supplied, the unit can read and write tags in accordance with the *EPC Gen2v2* standard.

It is possible to load additional protocols using software updates.

The device has a maximum of four external antenna ports for connection of the transmission/reception antennas for communication with RFID tags.

For integration into a variety of infrastructures, the device has different communication interfaces, depending on the variant. The power supply is provided either by a 4-pin M12 panel connector in A coding or by PoE+ according to 802.3at (10–57)¹⁾.

The Kathrein UHF RFID reader system RRU 4xxx is characterised by great flexibility in regard to RFID applications. One reason for it is the wide variety of reading devices compatible to each other, which allows to select a reader from the Kathrein product portfolio ideally suited for the respective application. Another reason for this flexibility is the wide range of parameters for configuring the reader firmware.

8.2 Features

- basic computing module
- dual-core embedded PC
- 2 Ethernet ports, 1 Ethernet port (RRU 4400 and ARU 3400)
- GPIO
- ©KRAI (RRU 4xxx)
- PoE+
- LED visualisation
- Wi-Fi (RRU 4560 and ARU 3560)
- Bluetooth (RRU 4560 and ARU 3560)
- 2G/3G (RRU 4570 and ARU 3570)

8.3 Scope of Delivery

- RRU 4xxx reader

¹⁾ Internal supply of GPIO VCC pin is not possible with PoE+

8.4 Accessories

This chapter gives an overview of the accessories available for the reader. For more information, visit our website at <https://www.kathrein-solutions.com/products/hardware/accessories> or contact our sales office at + 49 8036 90831 20.

8.4.1 Antennas

For use with UHF RFID antennas we recommend the Kathrein antenna types ULoRa, LoRa, MiRa, WiRa. These antenna types are available for all frequency ranges and are water proof according to at least IP 65 standard.

8.4.2 Antenna Cables

Order number	Type	Description
52010174	R-AC 3 TNC-TNCR	LL240 flex, 3 m, IP 67 ruggedised
52010175	R-AC 6 TNC-TNCR	LL240 flex, 6 m, IP 67 ruggedised
52010176	R-AC 10 TNC-TNCR	LL240 flex,10 m, IP 67 ruggedised
52010177	R-AC 15 TNC-TNCR	LL240 flex,15 m, IP 67 ruggedised
52010250	R-AA N-TNC	LL440 flex,15 m, IP 67 ruggedised
52010090	R-AC 3 SMA-TNCR	RG 58, 3 m
52010208	R-AC 05 SMA-SMA	RG 58, 5 m

8.4.3 Antenna Adapters

Order number	Type	Description
52010178	R-AA TNC-N(f-m)	adapter TNC-N (f-m)
52010243	R-AA TNC-SMA (f-m)	adapter TNC-SMA (f-m)

8.4.4 Antenna Mounting Accessories

Pole Mounting

Order number	Type	Description
52010005	MK-AMB-100 Outdoor	wall mount/mast mount kit for WIRA 30° antennas

Wall Mounting

Order number	Type	Description
52010261	MK-WM-100-100 Indoor	wall mount kit for WIRA 70° antennas

Wall/Pole Mounting

Order number	Type	Description
52010128	MK-WPM-100-100 Outdoor	wall/pole mount kit for WIRA 70° antennas
52010262	MK-WPGM-100-100 Outdoor	wall/pole mount kit for WIRA 40° antennas

8.4.5 Antenna Protective Cover

Order number	Type	Description
52010224	SMSH-30-30PC	protective cover for SMSH
52010356	SMSH-BP-ALU	aluminium backplate for SMSH

8.4.6 Reader Connecting Cables

Order number	Type	Description
52010358	R-CC3-10 DC	RRU/ARU DC power cable, 10 m
52010359	R-CC3-03 DC	RRU/ARU DC power cable, 3 m
52010360	R-CC3-10 ETH	RRU/ARU Ethernet cable M12/RJ45, 10 m
52020361	R-CC3-03 ETH	RRU/ARU Ethernet cable M12/RJ45, 3 m
52010362	R-CC3-10 GPIO	RRU/ARU GPIO cable M12, 10 m
52010363	R-CC3-03 GPIO	RRU/ARU GPIO cable M12, 3 m
52010373	R-BC3-10 ETH	RRU/ARU Ethernet bridge cable

8.4.7 Reader AC/DC Adapters

Order number	Type	Description
52010364	R-RPA3 24 VDC – 90 W	RRU/ARU AC/DC adapter 24 V/90 W
52010365	R-RPA 24 VDC – 72 W	RRU/ARU AC/DC adapter 24 V/72 W
52010366	R-RPA 24 VDC – 90 W	RRU/ARU AC/DC adapter 24 V/90 W

8.4.8 PoE+ Power Supply Unit

Order number	Type	Description
52020369	R-ETH-SW-100	PoE+ Ethernet switch, 4-port
52010370	R-POE-ONJ-30	PoE+ injector, 30 W, 100Mbit für RRU, ARU and M-ARU

8.4.9 Reader and Antenna Wall/Pole Mounting Kit

Order number	Type	Description
52010351	MK-WPM3-OSS Outdoor	wall/pole mount kit for RRU 4xxx, ARU 3xxx, WRA 7070 antenna
52010368	MK-PMA-OGV	pole mount adapter for 52010351

8.4.10 Reader Protective Covers

Order number	Type	Description
52010376	PCS-G3-IP67	protective cap for RRU 4xx and ARU 3xxx, IP 67
52010367	R-RVP3-VPP-SS	vandalism protective cover for RRU 4xxx and ARU 3xxx

9 Connections and Displays

Depending of the device variant, the reader has various connection options. The illustrations below shows an RRU 4000 standard reader with all its connection options. The following chapters provide details of the connections and the pin assignments of plugs and sockets.

9.1 Front View



Fig. 5: RRU 4000 – Displays

No.	Name	Function
①	PWR	indicates whether the reader is on; see also <i>12.4 Reading the PWR LED Indications, p. 36</i>
②	basic LEDs (A1-A4)	indicate if an RF signal is on for antennas 1–4 (default setting) ► For other functions of the basic LEDs, see <i>Selecting Functions, p. 79</i>
③	high-end LEDs ¹⁾	see <i>LED, p. 78</i>

Related topics

12.4 Reading the PWR LED Indications, p. 36

14.4 LED, p. 78

¹⁾ Available for RRU 45xx and ARU 35xx

9.2 Rear View



Fig. 6: RRU 4000

No.	Name	Function
①	ANT 4 ¹⁾	R-TNC, 50 Ohm, to connect an antenna
②	ANT 3	R-TNC, 50 Ohm, to connect an antenna
③	ANT 2	R-TNC, 50 Ohm, to connect an antenna
④	ANT 1	R-TNC, 50 Ohm, to connect an antenna
⑤	GPIO	to detect external sensors and to control external actors; see also <i>GPIO Functions</i> , p. 81
⑥	PWR	to connect to a DC power supply, 10–30 V
⑦	LAN ²⁾	second Ethernet port <ul style="list-style-type: none"> • to connect to a sub network • to connect external Ethernet devices
⑧	LAN/PoE	main Ethernet port with PoE+-connectivity <ul style="list-style-type: none"> • to control the reader • to provide power supply over Ethernet

¹⁾ In the ARU 3xxx readers, there are only 3 antenna ports

²⁾ Available for RRU 45xx and ARU 35xx

9.2.1 GPIO

M12, A-coded, 12-pin, female

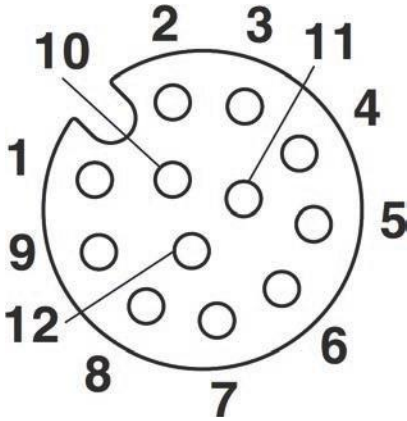

Pin	Allocation
1	OUT_CMN
2	OUTPUT_1
3	INPUT_3
4	INPUT_CMN
5	INPUT_1
6	GND
7	UB
8	OUTPUT_4
9	OUTPUT_3
10	OUTPUT_2
11	INPUT_2
12	INPUT_4

Related topics

14.6 GPIO Functions, p. 81

9.2.2 Power Supply

The power supply is arranged as a four-pin round-pin plug with an M12 connection thread in A-coding.

M12, A-coded, 4-pin, male

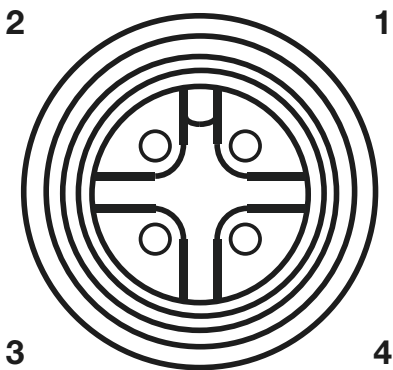

Pin	Allocation
1	+24 V DC
2	GND
3	GND
4	+24 V DC



Bear in mind that only power supply units with LPS (*Limited Power Source*) or NEC Class 2 power supply units are approved for operation with the device. This means that the secondary side of the power supply unit is limited to a power of maximum 100 W.

9.2.3 Ethernet



NOTICE

Risk of malfunction!

If other cables than specified are used, the communication with the reader is either interrupted or there is a malfunction.

- Only use shielded cables.

M12, X-coded, 8-pin, female

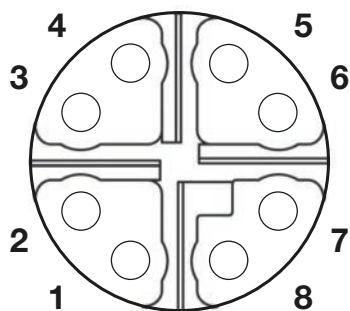

Pin	Allocation
1	TX+ / PoE+1
2	TX- / PoE+1
3	RX+ / PoE+2
4	RX- / PoE+2
5	PoE+1
6	PoE+2
7	PoE+3
8	PoE+4

9.2.4 Buzzer

Furthermore, the reader is fitted with a buzzer which, in addition to the LED, indicates successful booting (1 x short) or an error (2 x long).

10 Installing the Reader

When the connections are plugged in, the device satisfies the protection class IP65 (RRU and ARU).

10.1 Selecting the Installation Site



WARNING

Danger to life from electric shock or fire hazard due to incorrect voltage, insufficient ventilation, moisture, direct sunlight, heat or naked flames!



- ▶ When installing the unit in cabinets or shelves, make sure there is sufficient ventilation.
 - ▶ When selecting the installation location, make sure there is sufficient space around the unit for appropriate dissipation of the heat generated by the unit.
 - ▶ Do not expose the unit to inadmissible heat or fire.
 - ▶ Do not install the device close to the sources of heat, e.g. heating.
 - ▶ Do not place anything with a naked flame on the device.
 - ▶ Make sure that the maximum operating temperature from -20 to $+55^{\circ}\text{C}$ is not exceeded.
 - ▶ Make sure that the support surface has a sufficient load-bearing capacity/strength.
-



NOTICE

Risk of material damage due to the screws screwed into the reader housing too deep!

If the screws are screwed into the reader housing deeper than 10 mm, the housing is no longer water proof.

- ▶ When mounting the reader, make sure that the screws are screwed into the unit housing no deeper than 10 mm.
-

10.2 Installing the Reader

At the rear panel, the reader has threaded holes.

- ▶ See the drawing below for the dimensions of the holes.

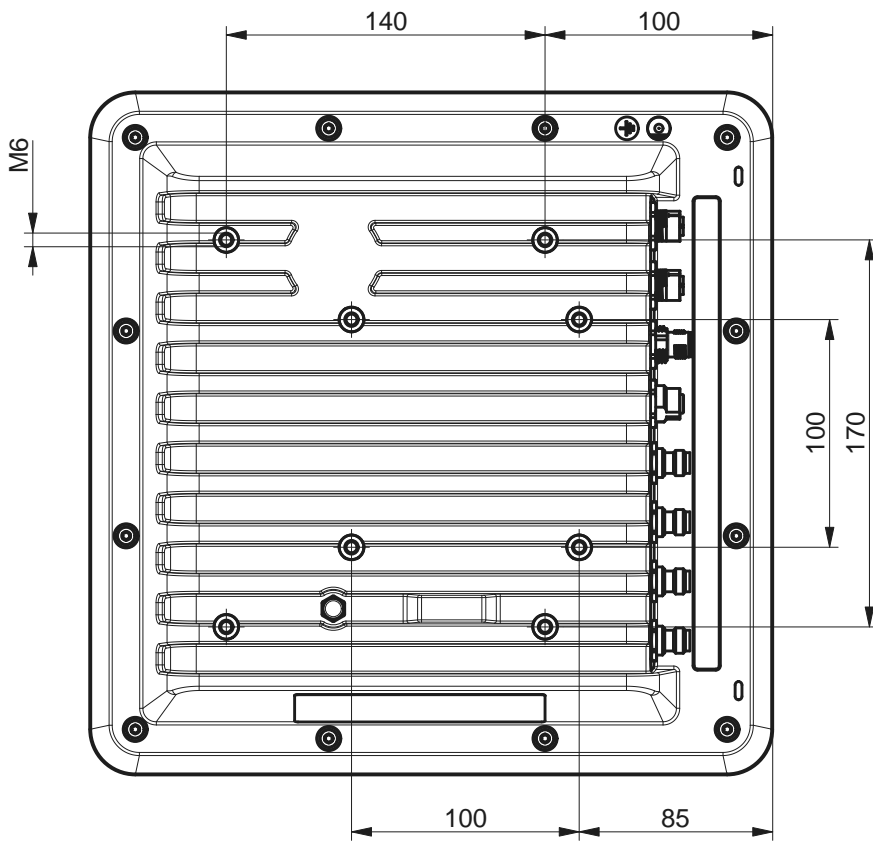

Fig. 7: Dimensions, rear view

10.2.1 Wall Mounting

Recommended for RRU 4xxx, since no alignment is necessary.

10.2.2 Wall/Pole Mounting

Recommended for ARU 3xxx readers, because the alignment of the reader antenna unit is necessary.

For ease of installation, a bracket is available as an accessory to mount the reader on a wall (52010351) or a mast (52010351 and 52010368).

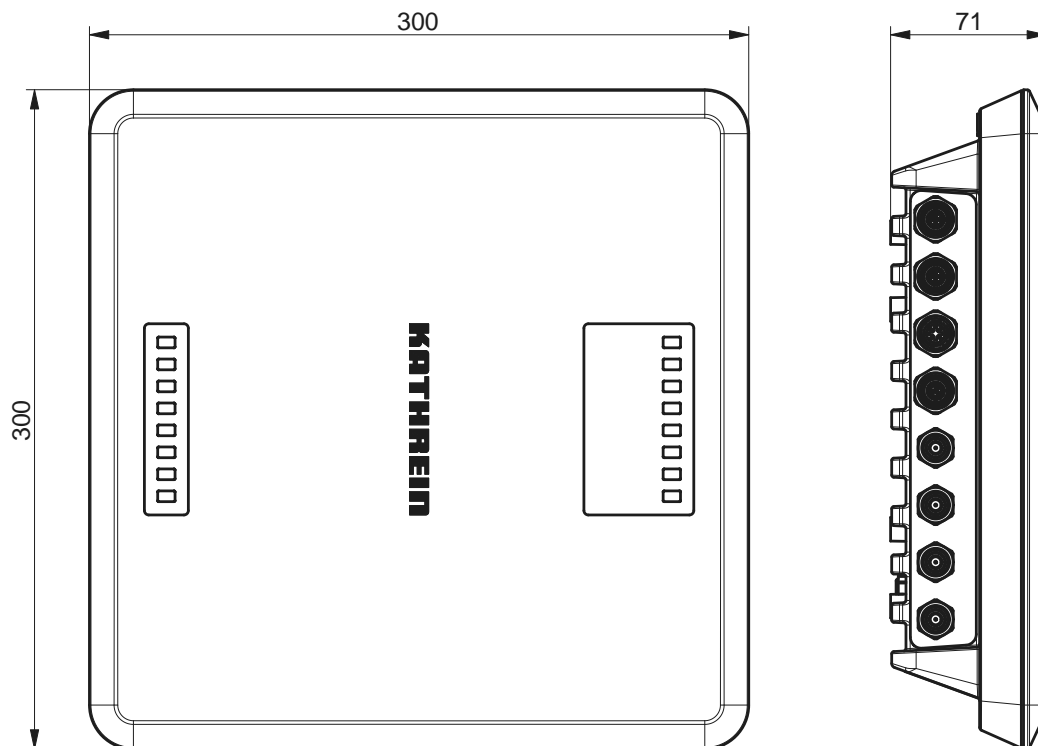

Fig. 8: Dimensions, front and side view

11 Transmission Methods

11.1 UART transmission (RS232, RS422, RS485 or similar)

11.1.1 Physical Layer

A full or half-duplex connection such as RS232, RS422 or RS485 is used for the physical layer.

11.1.2 Data Link Layer

Transmission takes place in frames and blocks. A block comprises a maximum of 256 frames. A frame comprises a maximum of 256 bytes, of which a maximum of 250 bytes can be user data. The result is a maximum block size of 64000 bytes of user data.

The data link layer is used to safeguard the data between the sender and recipient. The sender receives a response from the recipient for each correct frame received. If the sender does not receive a response from the recipient within a time window of 350 milliseconds after sending a frame, the frame sent is repeated until the error counter signals the cancellation of the transmission.

Frame Structure

5A LL SS FF DD ... DD P1 P2

5A	start code for synchronisation
LL	number of bytes in the frame, not including the start code
SS	status byte
FF	frame number
DD	user data
P1	16-bit checksum, low-byte
P2	16-bit checksum, high-byte

Start Code and Synchronisation

The start code is used to synchronise the recipient to the sender. Furthermore, the recipient synchronises to the start of a frame when no data have been received for 100 milliseconds.

Status Byte

The status byte has the following meaning:

50	data packet
A0	response <i>OK</i>
LL	response <i>Memory error</i> (the recipient was unable to allocate any memory for the received data block)

A response is only 3 bytes long and is not CRC-checked.

<i>OK</i>	5A 02 A0
<i>Memory error</i>	5A 02 A1

Frame Number

The frame number shows how many more frames belong to this data block. Only the first frame in a data block can be shorter than 256 bytes. Each additional frame must have a length of 256 bytes (length byte LL is FF).

Therefore, it is possible to calculate the block size from the first frame number, see the example below.

A block with 700 bytes of user data is to be transmitted. For this purpose, the block is divided into three frames:

1st frame: *5A CD 50 02* — 200 bytes of user data follow — P1 P2

2nd frame: *5A FF 50 01* — 250 bytes of user data follow — P1 P2

3rd frame: *5A FF 50 00* — 250 bytes of user data follow — P1 P2

The receiver can use the frame number of the first frame (here *02*) and its length byte to calculate the block size (block size = frame number * 250 bytes + length byte -5) (here in the example: 2 * 250 bytes + 205 bytes - 5 bytes = 700 bytes), and reserve an appropriate amount of memory for the data.

User Data

User data are the bytes in a frame that flow into the block transmitted.

Checksum

The checksum is calculated using the polynomial $x^{16} + x^{12} + x^5 + 1$ with a pre-initialisation of 0x0000 from the start code to the last user data byte.

Network Layer

As the KBRP is a point-to-point protocol, there is no network layer.

Transport Layer, Session Layer, Presentation Layer,

Do not exist.

Application Layer

The application layer transmits data blocks from 1 to a maximum of 64000 bytes.

11.2 LLRP Protocol

Based on the TCP communication protocol, the Kathrein RFID reader with the Linux operating system can handle the so-called *Low Level Reader Protocol* (LLRP).

It is a communication interface between an RFID reader and a LLRP-enabled application software standardised by *EPCglobal* (<http://www.epcglobalinc.org/standards/llrp>). The default port for LLRP is 5084.

The LLRP protocol is roughly divided into the following parts:

- Automatic query of the reader functions via the application software
- Configuration of the reader functions via the application software
- Triggering of read and write operations on the air interface via the application software
- Transfer of the found tag data to the application software

To start the LLRP application, use the **AppManager** of the *ReaderStart*. In the menu, it is possible to load the LLRP protocol engine by means of **Install App** and start it using **Start App**.

To test the Kathrein reader with the LLRP protocol, it is possible to use the open-source programming tool *Eclipse (IDE)*. By means of the so-called *LLRP Commander* it is possible to control and operate the reader.



Eclipse (IDE) and *LLRP Commander* are not part of the Kathrein RFID software.

11.3 Ethernet Transmission

A data transmission layer has been used for communication to our reader over Ethernet, just like in serial communication.

The data transmission layer over Ethernet is a much more simple solution here since the TCP/IP protocol already has a data security layer. As TCP/IP is a stream protocol, only the packet beginning and packet end are necessary.

There are 3 frame types in the protocol used in the Generation 3 readers.

If no data have been received for 100 milliseconds within a frame, the received part frame is dismissed. The payload (D1 to Dn) is identical to the Generation 2 payload.

11.3.1 Ethernet Transmission Generation 2 Readers

Frame Set-up

A frame looks as follows:

Start + data block + end

The start is made up of *0xAA 0xBB 0x01 0x01*, whereby the first 1 is the Datetransmit byte and the second 1 is a Stuffbyte. The end is made up of *0xAA 0xCC*. If the byte *0xAA* appears in the KBRP frame, it must be doubled (*0xAA 0xAA 0xAA*).

Port

The TCP communication port is the port 4007.

Example

The frame *ASyncGetEPCs* is shown here as an example. The ID for this command is *0x0111*, which makes the frame look as follows:

0xAA 0xBB 0x01 0x01 0x11 0x01 0xAA 0xCC

Extended Block Structure

If a data block to be transmitted exceeds 16 kB, it is necessary to subdivide into several 16-kB blocks. These blocks receive a block number, and the first block contains the total data length. It is necessary to confirm the reception of each block by means of an answer.

First block:

Start + block number always 0 + 4-byte total data length + data block + end

All other blocks:

Start + block number + data block + end

Answer to confirm the reception:

Start + block number + end

The start consists of *0xAA 0xBB 0x0E 0x01*. The end consists of *0xAA 0xCC*. If the *0xAA* occurs in the KBRP frame, it is necessary to double it: *0xAA → 0xAA 0xAA*.

11.3.2 Ethernet Transmission Generation 3 Readers

Frame Set-up

Data Frame

5A 50 L1 L2 L3 L4 D1 ... Dn A5

5A	start code
50	code for a data frame

L1 – L4	number of data bytes (D1 to Dn) in the data frame (32 bit; LSB first)
D1 – D4	data bytes to be transmitted (payload)
A5	end code

Ping

5A 5F A5

5A	start code
5F	ping code
A5	end code

Response to Ping

5A 5F A5

5A	start code
5F	ping response code
A5	end code

Port

The communication takes place via the TCP port 4007 as in case of Generation 2 readers.

Example

The frame *ASyncGetEPCs* is shown here as an example. The ID for this command is *0x0111*, which makes the frame look as follows:

0x5A 0x50 0x02 0x00 0x00 0x00 0x11 0x01 0xA5

Extended Block Structure

If a data block to be transmitted exceeds 16 kB, it is necessary to subdivide into several 16-kB blocks. These blocks receive a block number, and the first block contains the total data length. It is necessary to confirm the reception of each block by means of an answer.

First block:

Start + block number always 0 + 4-byte total data length + data block + end

All other blocks:

Start + block number + data block + end

Answer to confirm the reception:

Start + block number + end

The start consists of *0xAA 0xBB 0x0E 0x01*. The end consists of *0xAA 0xCC*. If the *0xAA* occurs in the KBRP frame, it is necessary to double it: *0xAA → 0xAA 0xAA*.

12 Connecting the Reader

12.1 Connecting Digital Inputs and Outputs

The activation and evaluation of the inputs and outputs is carried out using the *ReaderStart V3* software, with the DLL supplied or by access to the reader protocol.

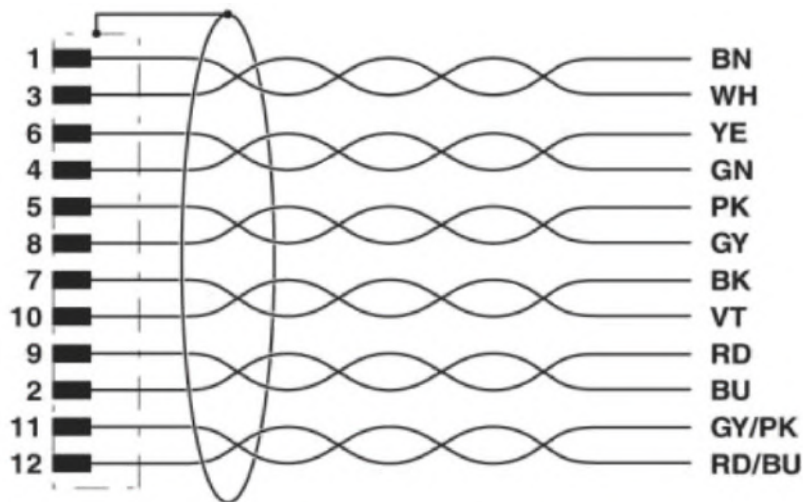

Fig. 9: Allocation of the GPIO interface cable

The digital inputs and outputs are provided via a 12-pin sockets in A-coding with M12 connection threads. The inputs are electrically isolated from the power supply of the reader and can be operated irrespective of the polarity of the input signal. For this reason, there is a common pin for the inputs (INP_CMN). The connection variants for the inputs are shown below.

If the electrical isolation is not required, the power to the input can also be supplied by the reader via pin 6 and 7 (see *GPIO*, p. 24).

The outputs are also DC-isolated from the power supply of the reader and have a common pin (OUT_CMN). If the electrical isolation is not required, the power supply can also be taken directly from the reader.



NOTICE

Risk of malfunction!

- ▶ Note that the load per channel is limited to a maximum of 0.5 A, and the total load across all the channels must not exceed 1.5 A. If the auxiliary voltage of the GPIO port of the reader is used, the load can be 1.1 A as a maximum. The inputs and outputs are designed for 30 V DC max.
- ▶ For further information, see the reader data sheet.
- ▶ Bear in mind that LPS or NEC Class 2 classified power supplied units can be used for the operation of the outputs.

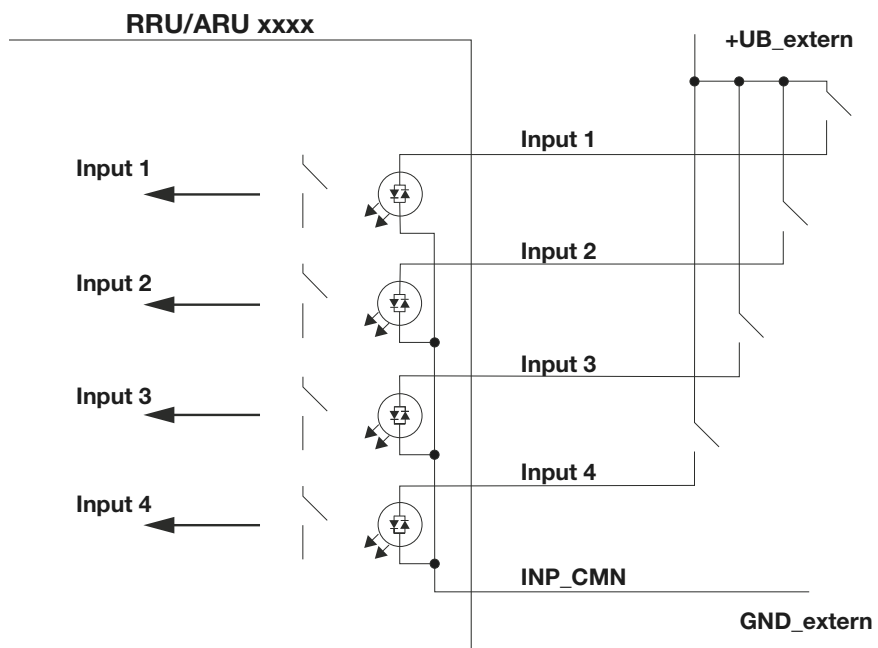

Fig. 10: DC-isolated inputs

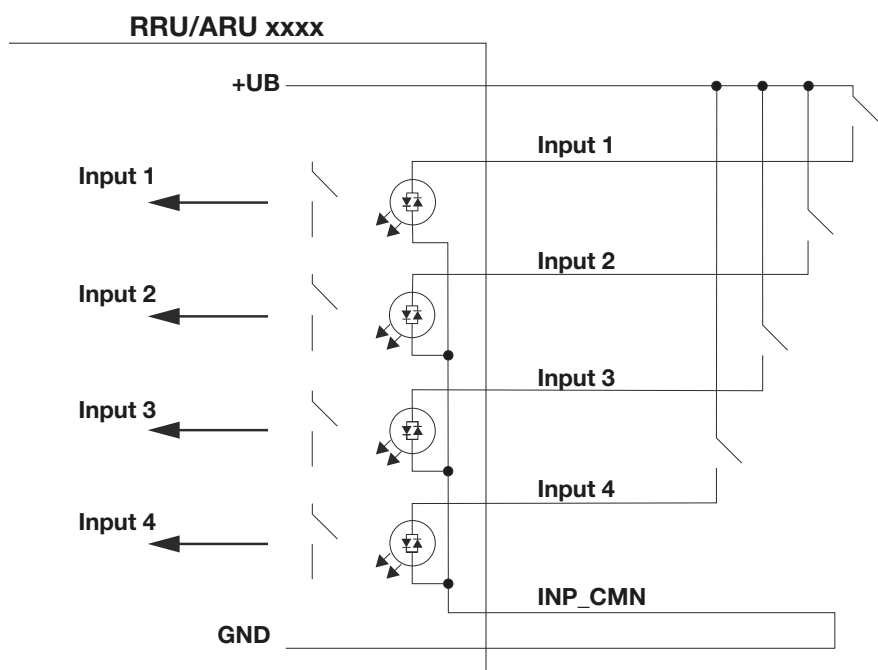

Fig. 11: Inputs, not DC-isolated

The connection examples for the outputs are shown in the next illustrations:

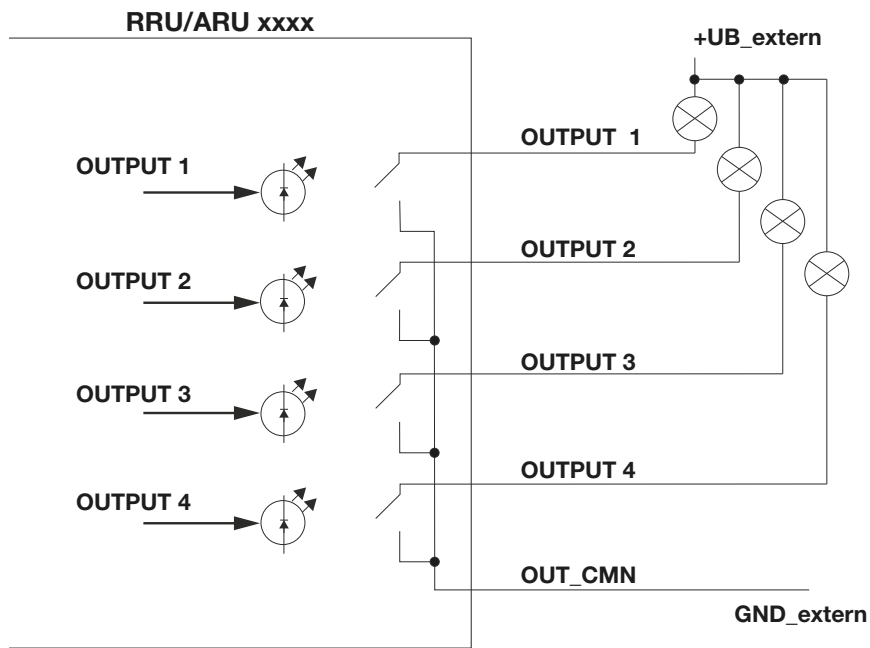

Fig. 12: DC-isolated inputs

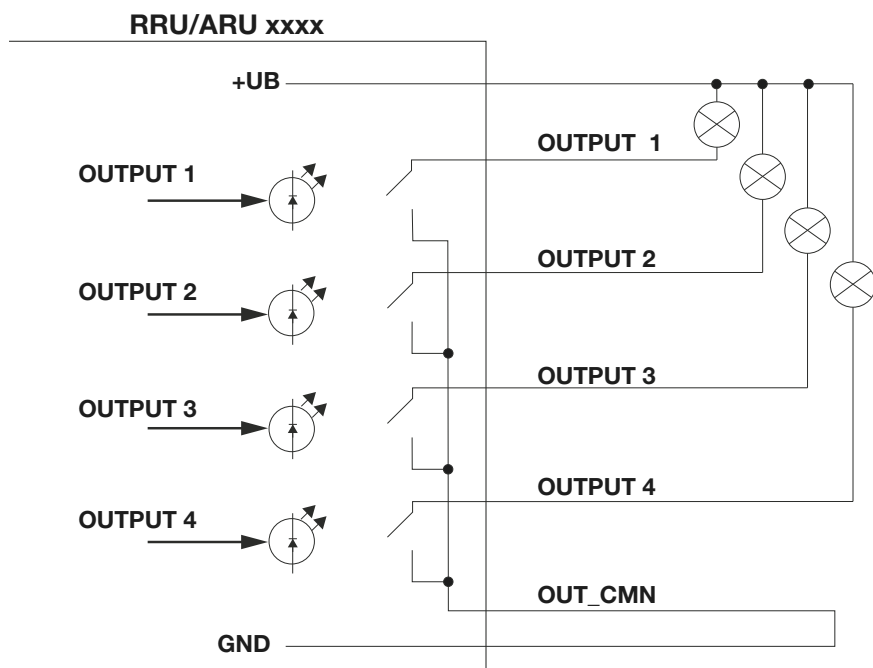

Fig. 13: Outputs, not DC-isolated

12.2 Connecting the Antenna



NOTICE

Risk of malfunction!

When using a cable not suitable for the impedance of 50 Ohm, the performance of the reader will be severely limited by the mismatch. If the mismatch is large, the reader may indicate a fault.

- ▶ Only use cable suitable for the impedance (50 Ohm).

For the connection to the RFID antennas, the reader has four antenna connections that are of the reverse TNC design.

- ▶ Only use the cable from the accessories or equivalent cable for this connection.

12.3 Turning the Reader On and Off

- ▶ Connect the reader to the power supply via a *PWR* or to a PoE source according to the 802.3at standard via *LAN /POE* input.

⇒ The reader is on.

12.4 Reading the PWR LED Indications

The reader has a 2-colour LED for the indication of the operating state. The table below shows the colours used and the related operating state:

LED	Action	Meaning
yellow	on	the unit is booting
green yellow	on flashing approx. every 8 seconds	unit is on, normal operation with heartbeat
yellow green	on flashing approx. every 8 seconds	error during booting

Tip

The ARU 3xxx readers have additional 4 LEDs (green/red/red/green) in the antenna cover which can be controlled by means of the software.

13 Operating *ReaderStart* Software

The reader can be operated using the *ReaderStart* software. The software provides all the necessary functionality of the reader for a test in a real environment. As an aid to configuration, various basic settings for application scenarios are available.

► For the current version of the *ReaderStart*, go to our support portal at <https://support.kathrein-solutions.com/>.

13.1 System Requirements

To ensure correct operation using the software on your PC/laptop, your PC/laptop should meet the following minimum requirements:

Processor	X86-compatible
Memory	512 MB RAM
Operating system	Windows XP (SP3), Vista (SP1), Windows 7 or higher
Free hard disk memory for:	
32-bit operating system	850 MB (including Microsoft .Net Framework 4)
64-bit operating system	2 GB (including Microsoft .Net Framework 4)

13.2 Installing the Software

Tip

The setup and the *ReaderStart* software might look different, depending on the operating system and the software version. The following images show the installation of the *ReaderStart V3*.

During the installation, it is checked whether the necessary requirements for the installation are met, i.e. whether all the dependencies, such as the necessary Windows Service Packs, the .NET Framework in the respective version together with the C++ redistributables are installed. If this is the case, the software and the DLL for controlling the reader are installed.

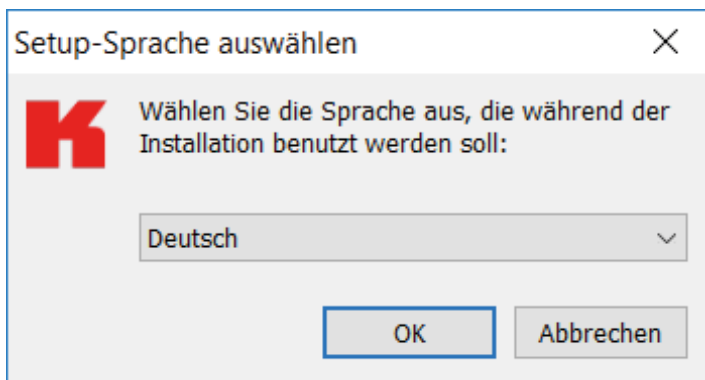

1. Download the *ReaderStart* software at <https://support.kathrein-solutions.com>.
2. Extract the downloaded zip file.
3. Double-click on the *ReaderStart_v3_Setup.exe* file.
⇒ The following screen with the option to select the language used during the installation appears.
4. Select a language between *German* and *English*.



5. Click **OK** to confirm the selection.
⇒ The screen on the left appears. It shows additional information on the exact version of the *ReaderStart* software.

Tip After the *ReaderStart* software has been installed, it is possible to access this information in the *Info* drop-down menu in the task bar.

6. Click on **Next** to continue or **Cancel** to exit the setup.

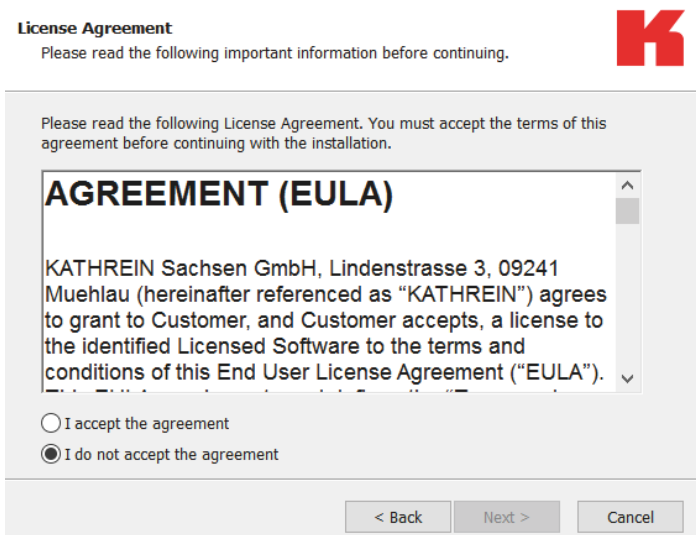

⇒ The screen on the left with the licence agreement appears.

7. Select **I accept the agreement** to continue

or

I do not accept the agreement to exit the setup.

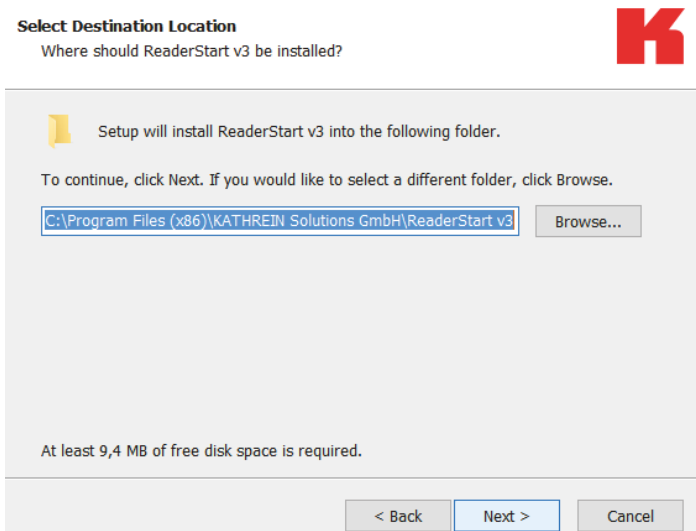

⇒ If you have accepted the license agreement in Step 7, the window on the left appears.

8. Select the destination file for the software to be installed.

Select Start Menu Folder

Where should Setup place the program's shortcuts?



Setup will create the program's shortcuts in the following Start Menu folder.

To continue, click Next. If you would like to select a different folder, click Browse.

< Back

9. Click *Next*.

⇒ The screen on the left appears. The standard settings are displayed. It is possible to customise the folder in the Windows start menu.

Select Additional Tasks

Which additional tasks should be performed?



Select the additional tasks you would like Setup to perform while installing ReaderStart v3, then click Next.

Additional shortcuts:

Create a desktop shortcut

< Back

10. Click *Next*.

⇒ The screen on the left appears.

11. Tick the box *Create a desktop icon* if you would like to include the icon in the Windows Quick Launch/on the desktop. The default setting is to create no icons.

Ready to Install

Setup is now ready to begin installing ReaderStart v3 on your computer.



Click Install to continue with the installation, or click Back if you want to review or change any settings.

Destination location:
C:\Program Files (x86)\KATHREIN Solutions GmbH\ReaderStart v3

Start Menu folder:
KATHREIN Solutions GmbH\ReaderStart v3

Additional tasks:
Additional shortcuts:
Create a desktop shortcut

< Back Cancel

12. Click *Next*.

⇒ The summary of all the installation tasks appears.

13. Click *Install* to start the installation.

14. If during the installation the software requests to restart the computer, do so.

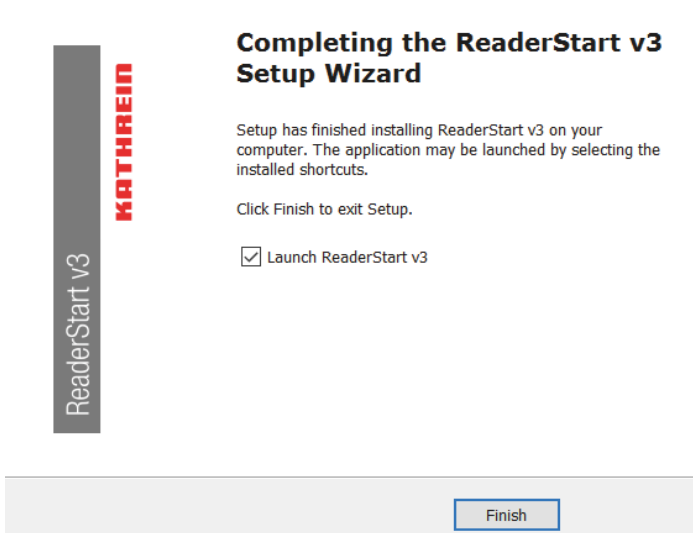

⇒ If the *ReaderStart* has been installed, the screen on the left appears.

15. If you do not want to start the programme immediately, uncheck the **Launch ReaderStart v3** box. Otherwise, the programme will automatically start once clicking on **Finish**.

13.3 Connecting the Reader in the *ReaderStart* Software

13.3.1 Requirements

From reader firmware version 2.04, the reader in the ex-works condition has the IP address *192.168.0.1* and the network mask *255.255.255.0*. Earlier reader firmware versions are configured for DHCP.

- ▶ To integrate the reader into a corporate network, contact your administrator so that he can allocate you a spare IP address and assign the correct network mask.

Alternatively, it is possible to configure the reader to obtain an IP address automatically. For this service, referred to as DHCP, it is necessary to have an appropriate DHCP server operating in the network.

- ▶ For more information, contact your network administrator.
- ▶ Make sure that the IP addresses of the control computer and the reader are in the same IP range but are not the same. Ensure that the network mask is identical.

Establishing the Connection to the Reader

There are two ways to establish the connection to the reader:

- by entering the IP address to communicate directly with the reader; see *Establishing the Connection via an IP Address* or
- by using the reader's host name; see *Establishing the Connection Using a Host Name*, p. 41.



- ▶ Start the programme.
 - ⇒ The splash screen is shown until all the necessary DLLs have been loaded in the background (see figure on the left).

⇒ After that, the user interface appears. It consists of the menu bar, the tabs and the status field:



Fig. 14: Establishing connection to the reader

Establishing the Connection via an IP Address

1. Click the *IP address* field (① in Fig. 14).
2. Enter the IP address.

Establishing the Connection Using a Host Name

1. Click the *Name* field (② in Fig. 14).
2. Enter the host name of the reader.

If you do not know the name of the reader, click *Search for Readers*.

⇒ The readers found in the network are shown with their names, see ⑤ in Fig. 15.

Tip

- To allow only secure SSH connection with an encrypted transmission to the reader, check the box next to the lock symbol (④ in Fig. 14); see also *Establishing a Secure Connection*, p. 59.

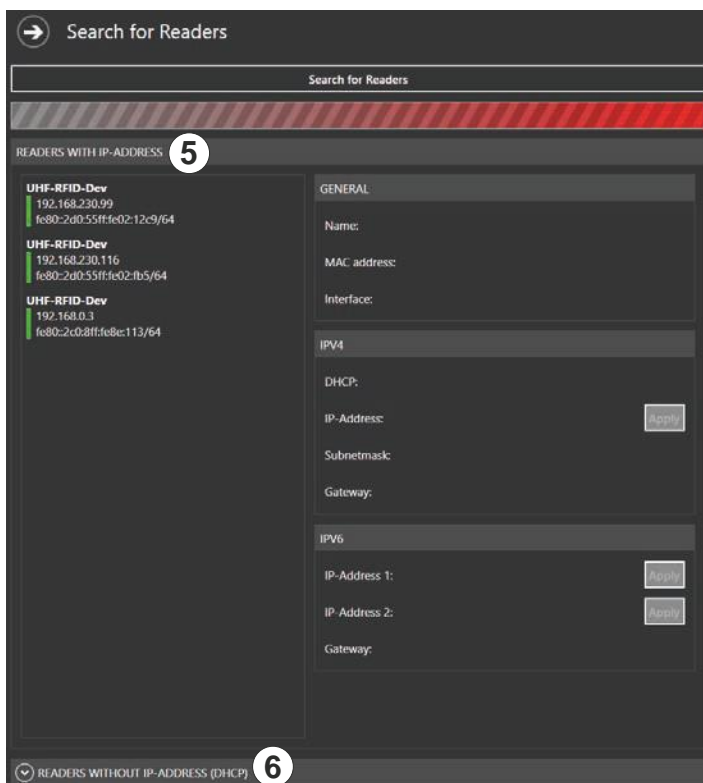
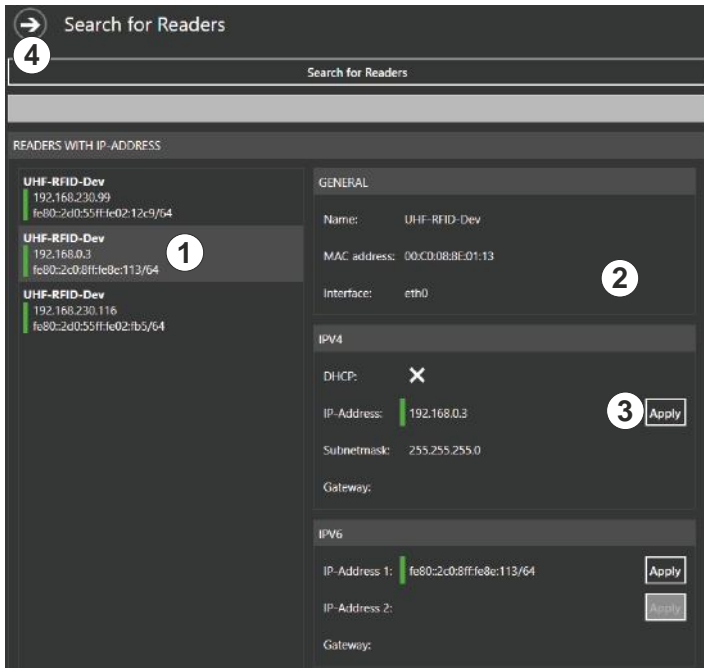

Fig. 15: Establishing connection to the reader: search for readers



The following steps describe establishing the connection for readers with an IP address.

3. In the *Ethernet* block, click *Search for Readers* (③ in Fig. 14).
⇒ The screen on the left appears.
4. Select a reader under *Readers with IP Address* (⑤ in the figure on the left).
5. If there have been 2 or more DHCP requests sent by the reader, the *Readers without IP Address (DHCP)* field (⑥) is expanded. Then it is possible to assign the IP address to the reader.



⇒ The view on the screen changes. The selected reader has a grey background (① in the figure on the left) and on the right (②), the properties of the reader are shown.

- To close this pop-up screen, click **Apply** (③) or on the arrow (④).

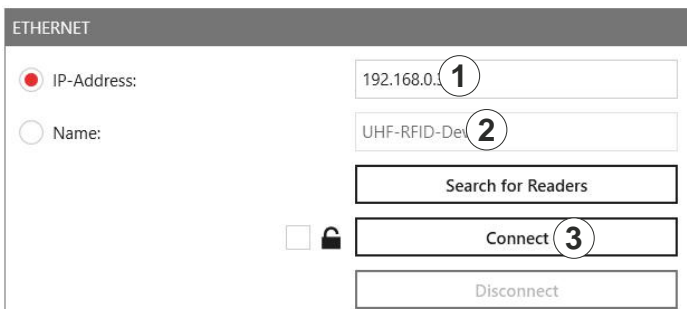

⇒ The user interface returns to the main view. In the **Ethernet** block, the IP address (① in the figure on the left) and the reader type (②) are shown.

- Click **Connect** to connect the reader.
 - ⇒ In the **Ethernet** block, the **Search for Readers** and **Connect** buttons are greyed out. It is possible to disconnect the reader by clicking **Disconnect** (① in the figure below). The **Communication Configuration Linux Module** (②) and status messages from the reader/programme are shown in the status field (③).

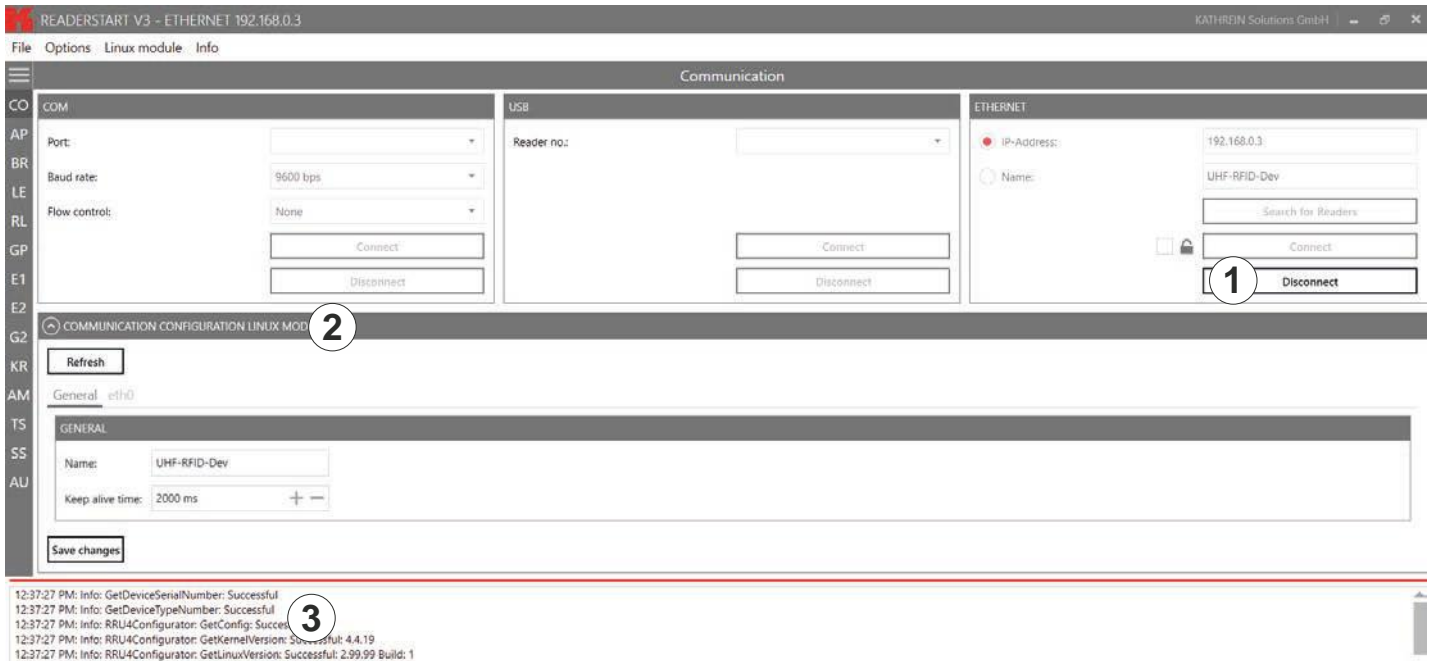

13.4 Navigating in the *ReaderStart* User Interface

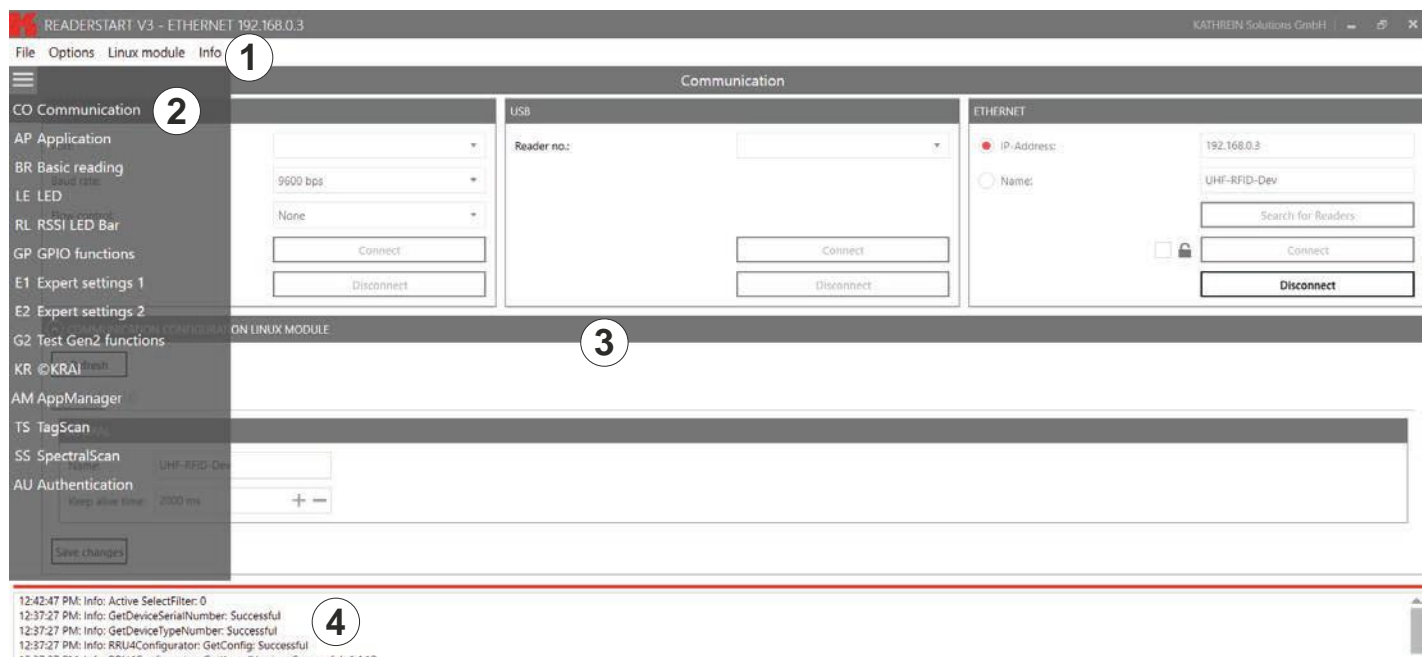

Fig. 16: *ReaderStart* user interface

The user interface of the *ReaderStart* consists of the following sections:

- menu bar (1); see *Menu Bar*, p. 43;
- settings and controls for the reader, divided into individual functional groups and situated under different tabs (2) and the contents of the tab (3), displayed in the central part of the screen; see *Operating the Reader Using the ReaderStart Software*, p. 58,
- status field containing messages from the reader and the program (4); see *Status Field*, p. 57

Tip The contents of the tabs are considerably large and are, therefore, described in a separate chapter; see *Operating the Reader Using the ReaderStart Software*, p. 58.

13.4.1 Menu Bar

By means of the menu bar, it is possible to customise the programme to the user's requirements.

File

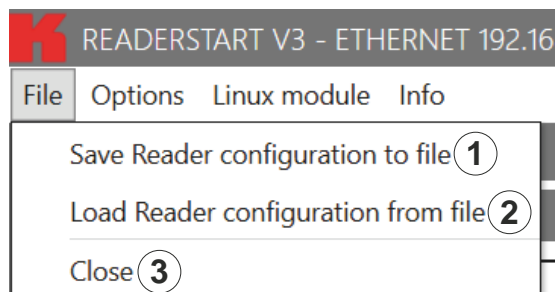

Fig. 17: Menu bar: file

①	<i>Save reader configuration to file</i>	saves reader configuration in an XML file
②	<i>Load reader configuration from file</i>	loads reader configuration from a previously saved XML file
③	<i>Close</i>	closes <i>File</i>

Saving Reader Configuration to File

There is a wide variety of parameters available for configuring the RF front end. It is possible to save the complete setting as a parameter set in an XML file under *File* ► *Save reader configuration to file* and to load it later.

► Under *File*, click *Save reader configuration to file*.

⇒ The following window appears:



Save Reader configuration to file

Which parameter set should be saved?

Parameter set 1	Comment
<input checked="" type="checkbox"/> Parameter set 0	Test
<input type="checkbox"/> Parameter set 1	
<input type="checkbox"/> Parameter set 2	
<input type="checkbox"/> Parameter set 3	
<input checked="" type="checkbox"/> Parameter set 4	Vehicle Identification
<input type="checkbox"/> Parameter set 5	
<input type="checkbox"/> Parameter set 6	
<input type="checkbox"/> Parameter set 7	

2 All **3** None

Progress: **4**

Status: **5** **6**

Fig. 18: File: save reader configuration to file

1	Parameter set	all available parameter sets from 0–7 ► Click the check box to select or unselect the parameter set. ⇒ The selected parameter set is marked with a tick. If the parameter is not selected, the check box is empty.
2	All	selects all parameter sets from 0–7
3	None	unselects all parameter sets from 0–7
4	Progress	shows the progress of the save operation by means of the progress bar; see also <i>Save</i> , p. 45

<p>⑤ Save</p>	<p>opens a pop-up window to select the directory in which the configuration file in the XML format will be saved and the file name for it</p> <p>To save reader configuration to file:</p> <p>✓ The parameter sets have been selected/unselected and described.</p> <ol style="list-style-type: none"> 1. Click Save. ⇒ A dialogue appears. 2. Select the file name and the directory in which the configuration file will be saved. 3. Click OK. ⇒ The progress bar (④) shows the progress of the save operation: Save Reader configuration to file  <p>⇒ After the file has been saved, a pop-up message Save reader configuration to file Saving done appears.</p> 4. Click OK to close the pop-up message. ⇒ The software returns to the view shown in Fig. 18, p. 44. 5. Click the X at the top right-hand corner or press Escape on your PC keyboard to leave the dialogue.
<p>⑥ Cancel</p>	<p>cancels the saving process</p>

Loading Reader Configuration from File

► Under *File*, click *Load reader configuration from file*.

⇒ The following window appears:

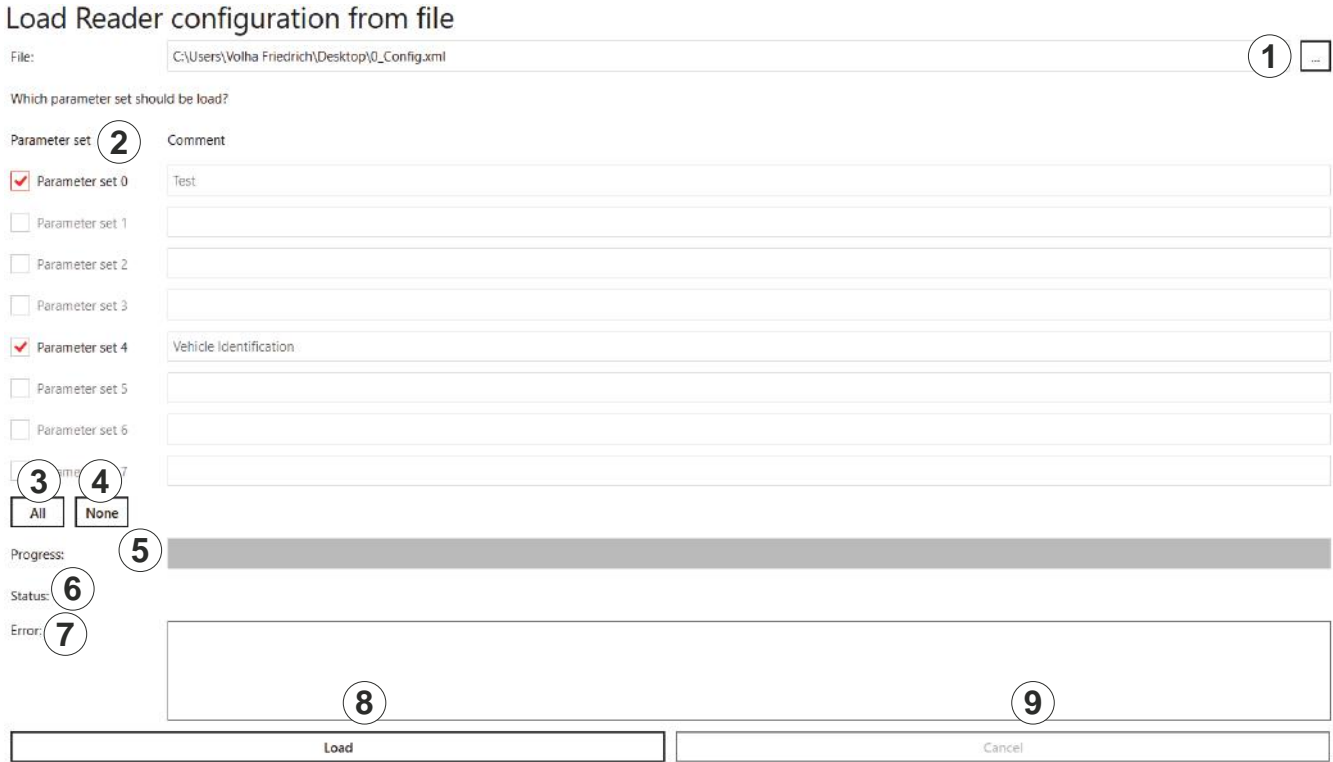
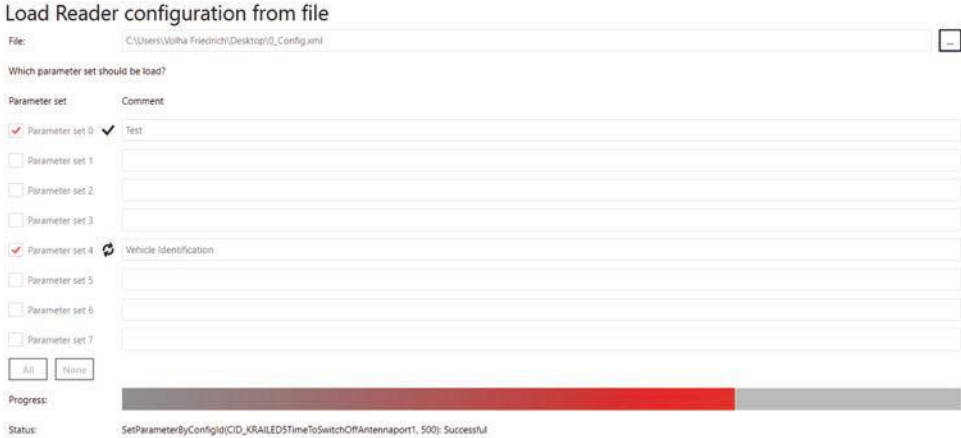

Fig. 19: File: load reader configuration from file

①	File	<p>opens a dialogue to select the configuration file</p> <p>To load reader configuration to file:</p> <ol style="list-style-type: none"> 1. Click File (④ in Fig. 19). ⇒ A dialogue appears. 2. Select the directory and the configuration file from which the parameter sets will be loaded. 3. Click Open. ⇒ The parameter sets saved in the configuration file are loaded and are marked with a red tick. ⇒ The progress bar (⑤) shows the progress of the save operation.
②	Parameter set	see <i>Parameter set</i> , p. 44
③	All	see <i>All</i> , p. 44
④	None	see <i>None</i> , p. 44
⑤	Progress	shows the progress of the load operation by means of the progress bar
⑥	Status	shows the status of the <code>SetParameterByConfigID</code> parameter
⑦	Error	shows errors in the <code>SetParameterByConfigID</code> parameter

<p>⑧ Load</p>	<p>loads the selected parameter sets to the reader</p> <p>✓ The parameter sets to be loaded have been selected/unselected.</p> <ol style="list-style-type: none"> 1. Click Load. <ul style="list-style-type: none"> ⇒ The progress bar (④) shows the progress of the save operation:  <p>⇒ After the configuration has been loaded, a pop-up message Load reader configuration from file Loading done appears.</p> <ol style="list-style-type: none"> 2. Click OK to close the pop-up message. <ul style="list-style-type: none"> ⇒ The software returns to the view shown in <i>Fig. 19, p. 46</i>. 3. Click the X at the top right-hand corner or press Escape on your PC keyboard to leave the dialogue.
<p>⑨ Cancel</p>	<p>cancels the loading process</p>

Close

- ▶ Click **Close** to close the *ReaderStart*.

Options

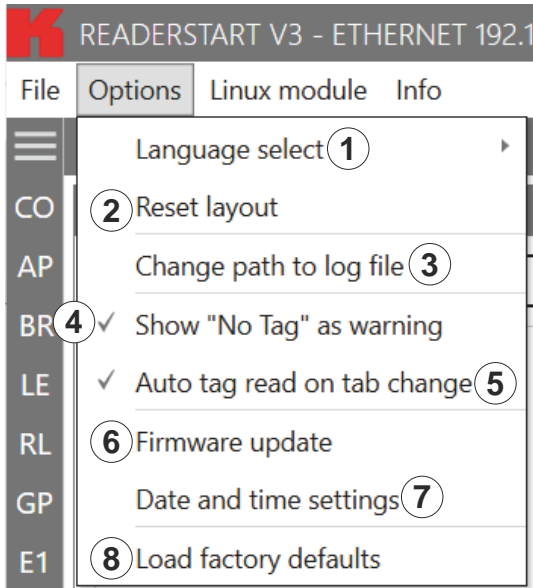

Fig. 20: Options

①	<i>Language select</i>	<p>selects the user interface language between <i>English/German/Spanish/French</i></p> <ol style="list-style-type: none"> 1. Click <i>Language select</i> (① in Fig. 20). ⇒ The four languages are shown. The language applied in the user interface is marked with a tick. 2. Click on the desired language. ⇒ A pop-up message appears: <i>Question. Please restart the programme to apply changes. Restart now?</i> 3. Click <i>Yes</i> to restart the programme and change the language or Click <i>No</i> to cancel the changes. ⇒ If you have pressed <i>Yes</i>, the programme restarts and the language of the user interface has been changed.
②	<i>Reset layout</i>	resets the sequence of the tabs to default settings and reduces the size of the programme to the window size
③	<i>Change path to log file</i>	opens a dialogue to create a new folder/select a new directory to save logs
④	<i>Show "No Tag" as warning</i>	<p>activates or deactivates the warning (yellow) in the status field if no tag has been detected in the antenna field; see <i>Status Field, p. 57</i></p> <p>If this parameter is not checked, the absence of the tag is shown as error (red) in the status field; see <i>Status Field, p. 57</i></p>
⑤	<i>Auto tag read on tab change</i>	activates or deactivates reading tags after the tab change
⑥	<i>Firmware update</i>	updates the reader firmware; see <i>Updating Firmware, p. 49</i>
⑦	<i>Date and time settings</i>	sets date, time and time zone on the reader; see <i>Changing Date and Time Settings, p. 50</i>
⑧	<i>Load factory defaults</i>	loads factory default settings onto the reader; see <i>Loading Factory Default Settings, p. 51</i>

Updating Firmware

1. Click **Firmware update**.
⇒ A dialogue appears. ① shows the current firmware version.

Firmware update

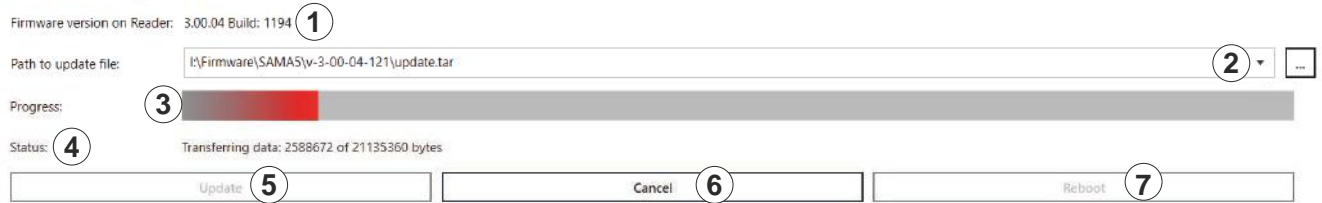

2. Click on the box at **Path to update file** (②).
⇒ A dialogue opens to select the file with the current firmware.
3. Having selected the update file, click **Update** (⑤).
⇒ The reader firmware is being updated. The update progress is shown by means of the progress bar (③). The status (④) shows what the software is currently performing, e.g. **Preparing, Transferring data: 2588672 of 21135360 bytes, Flashing**.
Click **Cancel** (⑥) to stop the update process.
4. After the update has been completed, click **Reboot** (⑦) to restart the reader.

Changing Date and Time Settings

The reader has an integral clock which can deliver the time stamp for a tag operation. It is possible to set the clock using *Date and time settings* under *Options* in the menu bar. When this menu item is opened, it automatically reads the current date and time from the reader and compares this with the date and time from the host computer. The date and time of the host computer can now be loaded to the reader by pressing the *Set system date and time on Reader* button.

1. Click *Date and time settings*.

⇒ A dialogue appears. It automatically reads the current date and time from the reader (③ and ④) and compares them with the date and time from the host computer (①).

Date and time settings

Status: RRU4Configurator: GetTimeZone: Successful

①	Date and time of the <i>ReaderStart</i> software	shows the date and time of the <i>ReaderStart</i> software; cannot be changed
②	<i>Set system date and time on reader</i>	loads the system date and time shown in ① onto the reader
③	Current date of the reader	shows the current date of the reader 1. To change the reader's date, either type the new date into the line or click on the calendar symbol in the line and select the date. 2. Click <i>Set adjusted date and time on reader</i> .
④	Current time of the reader	shows the current date of the reader 1. To change the reader's time, either type the new time into the line or click on the clock symbol in the line and select the time. 2. Click <i>Set adjusted date and time on reader</i> .
⑤	<i>Get reader date and time</i>	reads the current date and time from the reader and displays them in ③ and ④
⑥	<i>Set adjusted date and time on reader</i>	sets the adjusted date and time on reader; see ③ and ④
⑦	Time zone selection	selects the time zone 1. Click on the drop-down menu symbol (⑦). 2. Select the continent and the city. ⇒ The time zone is displayed at (⑧).
⑧	<i>Get time zone</i>	reads the time zone currently set in the system
⑨	<i>Set time zone</i>	sets the time zone selected at ⑦

Loading Factory Default Settings

1. Click *Load factory defaults*.
⇒ A pop-up message appears: *Are you sure to load factory defaults?*
2. Click *Yes* to load factory default settings or
Click *No* to cancel the operation.

Linux Module

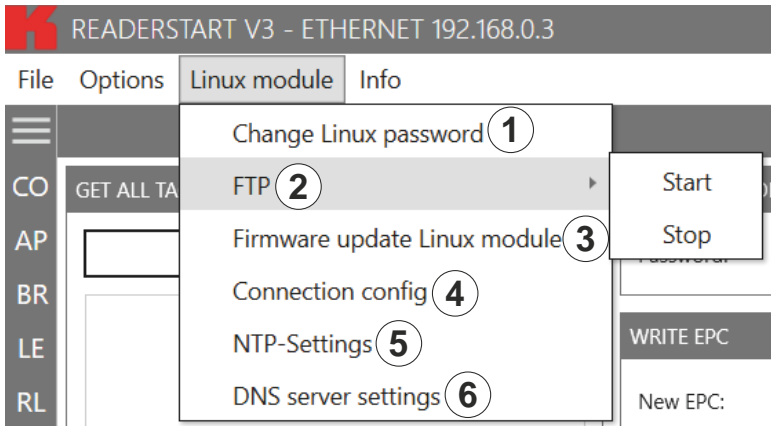

<p>① Change Linux password</p>		<p>changes the Linux password</p> <ol style="list-style-type: none"> 1. To change the password, click <i>Change Linux password</i>. ⇒ The following pop-up window appears: <div data-bbox="542 1041 1530 1198" data-label="Image"> </div> 2. Type in the old password. 3. Type in the new password. 4. Confirm the new password. 5. Click <i>OK</i> to change the password or Click <i>Cancel</i> to stop the process.
<p>② FTP</p>		<p><i>Start</i> starts FTP server <i>Stop</i> stops FTP server</p>
<p>③ Firmware update Linux module</p>		<p>updates Linux module firmware</p> <p>► Proceed as described in <i>Updating Firmware, p. 49</i>. Make sure to select the file to update the Linux module firmware at <i>Path to update file</i> (②).</p> <div data-bbox="502 1630 1530 1877" data-label="Image"> </div>

<p>④ Connection config</p>	<p>configures the secure connection and the backward compatibility</p> <p>Connection config</p> <p>Allow only secure connection: <input type="checkbox"/> ① ⚠ Only settable with secure connection.</p> <p>Backward compatibility: <input type="checkbox"/> ② ⚠ Available from firmware version 3.00.04 onwards</p> <p style="text-align: center;">Get configuration ③ Set configuration ④</p> <hr/> <p>① ► Check Allow only secure connection so that all connections are secure.</p> <hr/> <p>② activates or deactivates compatibility to Generation 2 KBRP</p> <hr/> <p>③ reads the current secure connection and backward compatibility configuration</p> <hr/> <p>④ sets the secure connection and backward compatibility configuration</p>
<p>⑤ NTP settings</p>	<p>enters a preferred NTP¹⁾ server; see <i>Changing NTP Settings, p. 52</i></p>
<p>⑥ DNS server settings</p>	<p>changes DNS server settings; see <i>Changing DNS Server Settings, p. 53</i></p>

Changing NTP Settings

To simplify the time setting, it is possible to enter a preferred NTP server. This way, in a defined interval, the reader retrieves the information from the NTP server and gets the time from the network, thus setting the internal time settings of the reader.

► Click **NTP settings** (②).

⇒ The following dialogue opens.

NTP-Settings

NTP server: ①

Interval: 0 s ② + -

Time: 1/1/2012 4:25:30 AM ③

Status: RRU4Configurator: GetNTPInterval: Invalid data ④

⑤ ⑥
 ⑦ ⑧
 ⑨ ⑩

①	NTP server	enters an NTP server address, e.g. 0.pool.ntp.org
②	Interval	sets the interval in the range 0–4204967295 s to synchronise the time with the NTP server
③	Time	shows the current date and time of the reader
④	Status	shows the status of the last performed operation in the NTP settings dialogue
⑤	Get NTP server	reads the NTP server settings currently set in the system
⑥	Set NTP server	sets the NTP server selected at ①
⑦	Get interval	reads the interval currently set in the system
⑧	Set interval	sets the interval selected at ②
⑨	Get time	gets the current time of the reader
⑩	Set time via NTP	manually synchronises the time with the NTP server

¹⁾ Network Time Protocol

Changing DNS Server Settings

► Click *DNS server settings* (②).

⇒ The following dialogue opens.

DNS server settings



DNS server 1: ①

DNS server 2: ②

DNS server 3: ③

Search: ④

Status: ⑤

Get DNS server ⑥ Set DNS server ⑦

①	<i>DNS server 1</i>	enters the DNS server address
②	<i>DNS server 2</i>	enters the DNS server address
③	<i>DNS server 3</i>	enters the DNS server address
④	<i>Search</i>	contains the local domain name
⑤	<i>Status</i>	shows the status of the last performed operation in the <i>DNS server settings</i> dialogue
⑥	<i>Get DNS server</i>	reads the DNS server settings currently set in the system
⑦	<i>Set DNS server</i>	sets the DNS server

Info

This menu item provides information about the *ReaderStart* software and the reader.

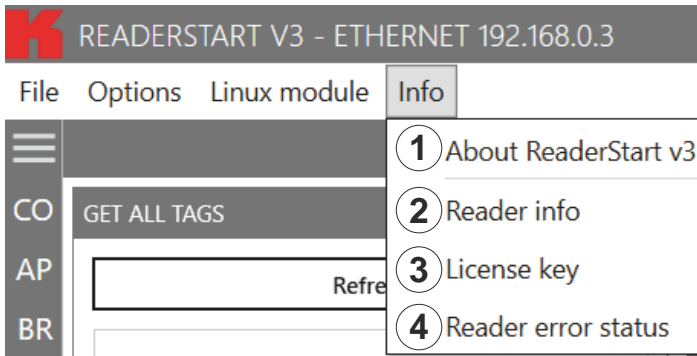

Fig. 21: Info

<p>①</p>	<p>About Reader-Start v3</p>	<p>shows the version number of the software and links to the licenses</p> <p>ReaderStart v3</p> <p>Version: 3.00.00.2394</p> <p>RRU4DotNet.dll: 3.00.00.1095</p> <p>© KATHREIN Solutions GmbH</p> <p>LICENSES</p> <ul style="list-style-type: none"> MahApps.Metro MahApps.Metro.IconPacks Caliburn.Micro
<p>②</p>	<p>Reader info</p>	<p>shows information about the reader; see <i>Showing Reader Information</i>, p. 55</p>
<p>③</p>	<p>License key</p>	<p>automatically reader the license key and show various factory-set reader parameters; see <i>Showing License Key Information</i>, p. 56</p>
<p>④</p>	<p>Reader error status</p>	<p>reads the error status of the reader and shows all errors that are outstanding in the status field</p>

Showing Reader Information

Reader info

Firmware version: **1** 2.99.99 Build: 869

Linux module firmware version: 2.99.99 Build: 1 (Kernel: 4.4.19) **2**

Serial number: **3** 0

Type number: **4** 52010292

CPU module: **5** 136B452-S02

SHOW LESS

Reader uptime: 00:02:11:23 **6**

Linux uptime: 00:02:11:23 **7**

Details: **8**

```
<LinuxStatus>
<dmesg> [ 0.000000] Booting Linux on physical CPU 0x0
[ 0.000000] Linux version 4.4.19-rt27 (kuhnertj@debian) (gcc version 4.9.2 (GCC) ) #1 SMP PREEMPT RT Thu Nov 17 08:23:35 CET 2016
[ 0.000000] CPU: ARMv7 Processor [412fc09a] revision 10 (ARMv7), cr=10c5387d
[ 0.000000] CPU: PIPT / VIPT nonaliasing data cache, VIPT aliasing instruction cache
[ 0.000000] Machine model: Kathrein RFID Linux Platform
[ 0.000000] Memory policy: Data cache writealloc
[ 0.000000] On node 0 totalpages: 262144
[ 0.000000] free_area_init_node: node 0, pgdat 80555c80, node_mem_map bf7f8000
[ 0.000000] Normal zone: 2048 pages used for memmap
[ 0.000000] Normal zone: 0 pages reserved
[ 0.000000] Normal zone: 262144 pages, LIFO batch:31
[ 0.000000] PERCPU: Embedded 11 pages/cpu @bf7c1000 s15808 r8192 d21056 u45056
[ 0.000000] pcpu-alloc: s15808 r8192 d21056 u45056 alloc=11*4096
[ 0.000000] pcpu-alloc: [0] 0 [0] 1
```

Refresh **9** **Save** **10**

Fig. 22: Info: reader info

1	Firmware version	shows reader firmware version
2	Linux module firmware version	shows Linux module firmware version
3	Serial number	shows the reader's serial number
4	Type number	shows the reader's type number
5	CPU module	shows the CPU module number
6	Reader uptime	shows time during which the reader has been running
7	Linux uptime	shows time during which the Linux module has been running
8	Details	shows details about the reader
9	Refresh	updates the reader and Linux uptime
10	Save	saves the reader info in an XML file

Showing License Key Information



Fig. 23: Info: license key

①	Save license to file	saves the license key in a license file
②	Load license from file	loads a license key from a license file
③	Get license	shows the current license key details
④	Features	shows factory-set parameters of the reader
⑤	Show less/Show more	shows/hides the information shown in the right part of the screen under <i>Get license</i>



In certain cases, it is necessary to send the license key to KATHREIN Solutions GmbH.

1. To do so, click **Save license to file** (① in Fig. 23).
2. Select the file name and the destination directory.
3. Send the file to KATHREIN Solutions GmbH.

To send the file to KATHREIN Solutions GmbH:

1. Go to the support portal of the KATHREIN Solutions GmbH at <https://support.kathrein-solutions.com/>.
2. If you do not have an account yet, create an account.
3. After the successful registration, click **Ticket Tracking**.
4. Click **Add Ticket**.
⇒ A new mask appears in which you can describe your question and attach files.
5. Attach the file with the license key by clicking **Browse**.
6. Click **Save** to send the file to the KATHREIN Solutions GmbH support team.

13.4.2 Status Field

3 message types are defined, see the example below:

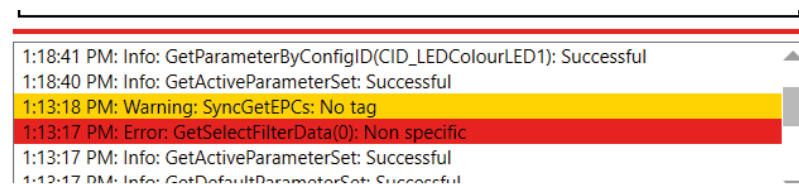

Fig. 24: Status field

①	Info	shows which action has been recently performed
②	Warning	indicates possible problems in the structure and configuration
③	Error	indicates that the required action could not be executed

Every status message has a time stamp next to it. The status messages are arranged such that the most current one is always at the top of the list.

- Tip**
- ▶ To expand the status field section and see more status messages, click on the boundary line between the sections (red line in Fig. 24) and drag it upwards.
 - ▶ To minimise the status field section, drag the line downwards.

The status field has a context menu which allows to deactivate warnings, information and errors in the status field. It is also possible to delete status messages.

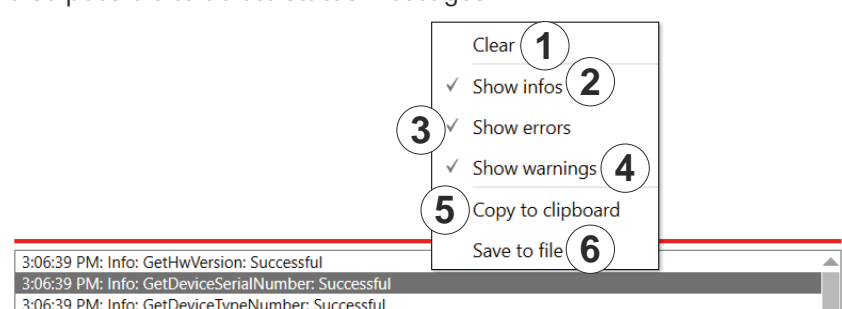

Fig. 25: Status field context menu

①	Clear	deletes all status messages
②	Show infos	shows/hides infos
③	Show errors	shows/hides errors
④	Show warnings	shows/hides warnings
⑤	Copy to clipboard	copies the status field entries to the Windows clipboard

⑥	Save to file	<p>saves status messages in the txt. format</p> <ol style="list-style-type: none"> 1. Click <i>Save to file</i>. ⇒ A pop-up windows appears requiring to select the location of the file. 2. Select the directory/folder. 3. Click <i>Save</i>. ⇒ A pop-up message <i>Saving done</i> appears. 4. Click <i>OK</i> to close the pop-up message.
---	---------------------	--

14 Operating the Reader Using the *ReaderStart* Software

14.1 Communication

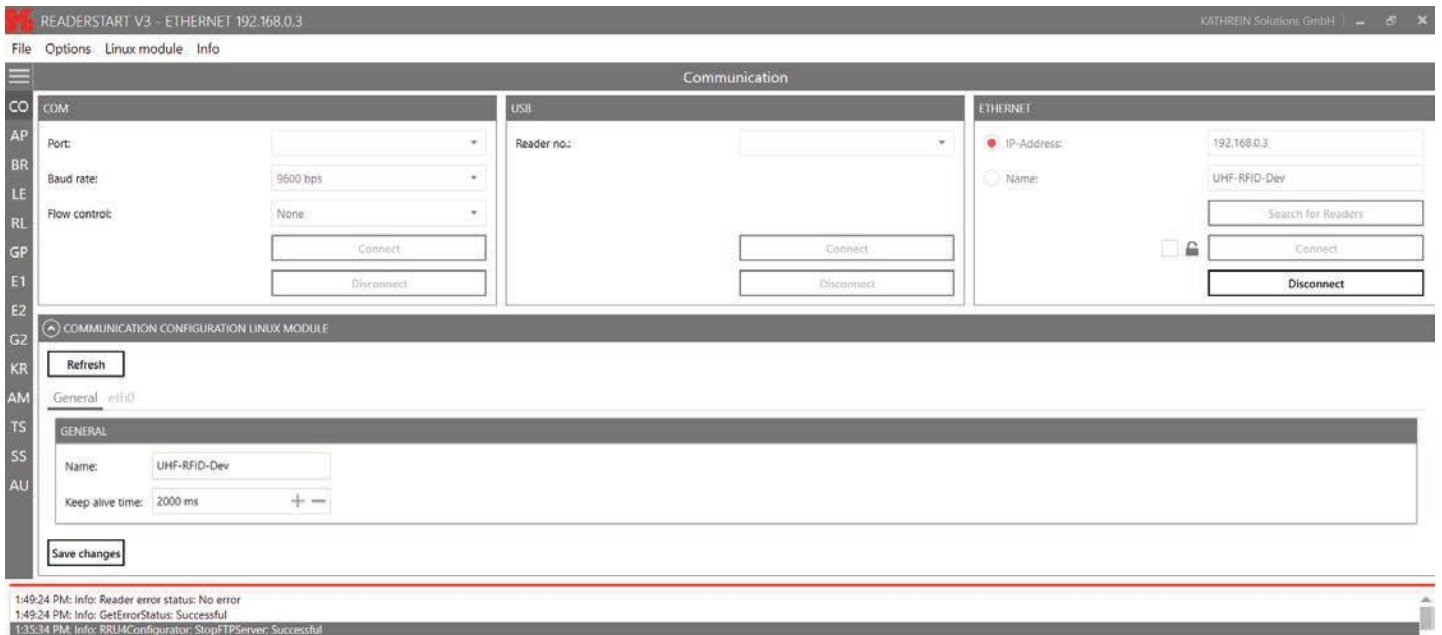

Fig. 26: Communication Tab

The communication tab groups together all the functions for establishing connections and configuring the Linux module. The various communication connections are grouped in 3 sections:

- **COM** for serial connections via the COM port (RS232/485/422); only available in the M-ARU-ETH-E6 reader (order number 52010198);
- **USB** for connections up to version USB 2.0; only available in the ERU-ETG-E4 (order number 52010190) and ERU-ETG-U4 reader (order number 52010191);
- **Ethernet** for connections via TCP/IP;
- **Communication Configuration Linux Module** section to change the Ethernet setting; see *Communication Configuration Linux Module*, p. 61

When the connection has been established, the program retrieves the information about the installed Linux module. It is possible to view and change the configuration information via the **Communication Configuration Linux Module**.

14.1.1 Ethernet Section

The Ethernet connection is established by linking the reader into an existing network or by directly connecting the reader and the control computer. To directly connect the reader to the PC, a cross-link cable is required, unless the LAN interface on the PC supports *auto-mdi-x*. Alternatively, it is possible to use two standard patch cables and a switch.

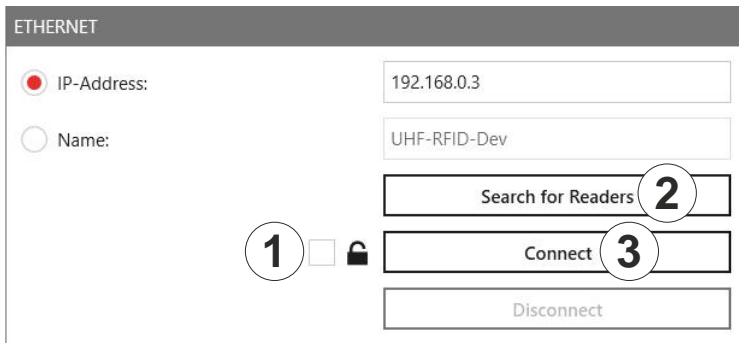

Fig. 27: Ethernet section

Establishing a Secure Connection

✓ The connection to the reader has not yet been established.

1. In the Ethernet section, click the box next to the lock symbol (① in Fig. 27).
2. Click **Search for Readers** (②) or **Connect** (③).

⇒ The following pop-up window appears:



3. Type in the user name at **User** (①). The default user name is *root*.
4. Enter the default password *UHF-RFID-Dev* at **Password** (②).

Tip You can change the password under *Linux module ▶ Connection config*; see *Linux Module*, p. 51.

5. If you want to use the key file instead, click the box at **Key file** (③).

⇒ A pop-up window to select the key file opens.
6. Select the key file.
7. Click **OK** to establish the secure connection.

⇒ It is possible to configure the secure connection under *Linux module ▶ Connection config*; see also *Linux Module*, p. 51.

Loading Factory Default Settings

When resetting the reader to factory default, the *ReaderStart* sends out a UDP broadcast cmd. It is only possible 30 seconds after power rebooting.



Note that this command also resets the Linux module settings, such as Linux password, network name, IP address, deactivates the auto start of the apps etc.

1. In the Ethernet section, click **Search for Readers**.
2. Select the reader onto which you would like to load the factory default settings.

3. Right-click on the reader.
⇒ The following pop-up message appears:

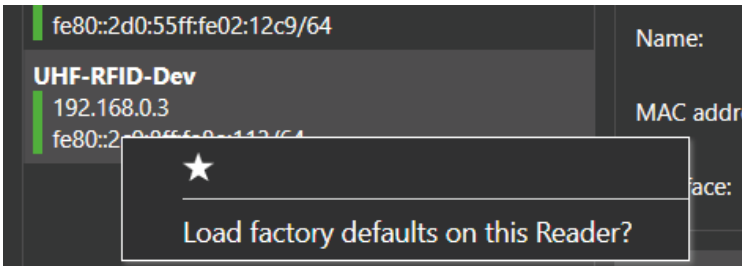

4. Click *Load factory defaults on this Reader*.
⇒ The pop-up message *Are you sure to load factory defaults on this reader* appears.
5. Click *Yes* to set the reader to the factory default settings.
Click *No* to cancel.
⇒ If you have clicked *Yes*, another pop-up window appears:



6. Click *Start*.
⇒ A pop-up message *Are you really sure to load factory defaults on this reader* appears.
7. Click *Yes* to set the reader to the factory default settings.
⇒ The status messages informing about the progress of the reset process are shown in the *Status* field of the pop-up window, see examples in the figure above.
8. After the factory default settings have been loaded onto the reader, click *Close*.

Selecting a Favourite Reader

If there are many readers in the system and the user establishes connection to one reader more frequently than to the others, it is possible to select the preferred reader as a favourite reader, placing it at the top of the reader list.

1. In the Ethernet section, click *Search for Readers*.
2. Select the preferred reader.
3. Right-click on the reader.
⇒ The following pop-up message appears:

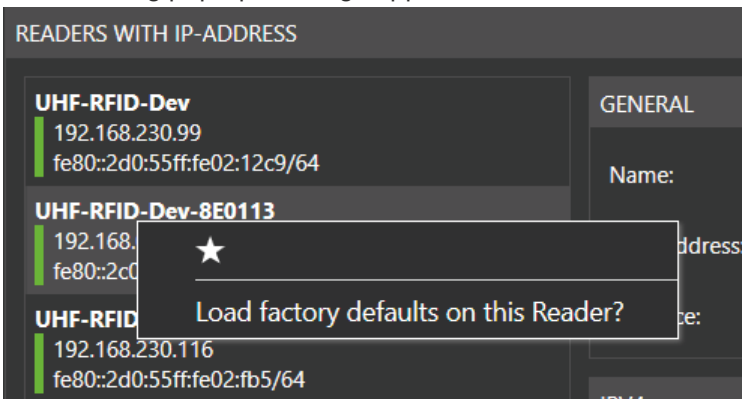

4. Click on the star.

⇒ The preferred reader is now placed at the top of the list, making it easier for the user to select it:



14.1.2 Communication Configuration Linux Module



Communication Configuration Linux Module has different options, depending on the reader type.

General

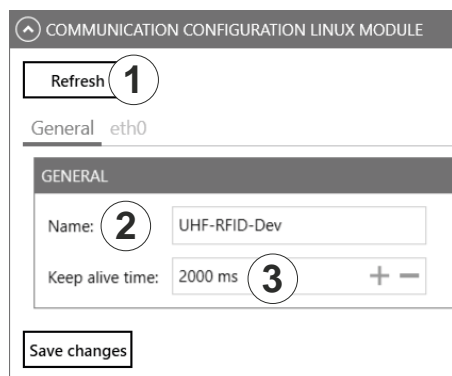



Fig. 28: Communication configuration Linux model: general

①	Refresh	reads the current settings of the communication configuration Linux module
②	Name	shows the host name of the reader which is logged onto the DNS server It is possible to address the reader using this name as an alternative to the IP address.

③	<i>Keep alive time</i>	<p>specifies the intervals of time at which the reader sends a data packet to check whether the receiver is still available</p> <p>If the connection to the reader is broken, the reader shuts down the connection. If this parameter is deactivated (0 ms), the socket is shut down only when the reader is restarted.</p> <div data-bbox="336 353 1517 566" style="border: 1px solid black; padding: 10px;"><p> If no keep-alive time is set, it may happen that the reader cannot take up any further connections because the existing connections have not been properly shut down, e.g. following a breakage in the wire. In this case, it is necessary to restart the reader. It is recommended to use the keep-alive time to check the connection between the reader and PC.</p></div>
---	-------------------------------	--

Ethernet

COMMUNICATION CONFIGURATION LINUX MODULE

Refresh **1**

General eth0

IPV4	IPV6 6	STATUS
IP-Address: 2 <input type="text" value="192.168.0.3"/> Subnetmask: 3 <input type="text" value="255.255.255.0"/> Gateway: 4 <input type="text" value="0.0.0.0"/> DHCP: 5 <input type="checkbox"/>	IP-Address: <input type="text" value="fe80::2c0:8ff:fe8e:113"/> Subnet-Prefix-Length: <input type="text" value="0"/> + - Gateway: <input type="text" value="::"/>	IP-Address: <input type="text"/> 7 Get status

Save changes **8**

Fig. 29: Communication configuration Linux model: Ethernet

1	Refresh	reads the current settings of the communication configuration Linux module
2	IP address	manually issues the address <div style="border: 1px solid gray; padding: 5px; margin-top: 5px;"> Tip It is only possible to use this parameter if the DHCP (5) is deactivated. </div>
3	Subnet mask	manually issues a network mask <div style="border: 1px solid gray; padding: 5px; margin-top: 5px;"> Tip It is only possible to use this parameter if the DHCP (5) is deactivated. </div>
4	Gateway	enters the gateway
5	DHCP	activates/disactivates the automatic issuing of an IP address by a DHCP server; if the network has a configured DNS server, it is also possible to use the host name of the reader.
6	IPv6	enters the second IPv6 address (the first IPv6 address is the link local address)
7	Status	shows the current reader IP address (eth0)
8	Save changes	saves changes



If the data relevant to the current connection (e.g. IP address) are changed, it may cause an error and the connection is lost.



If the interface has been configured incorrectly, it is not possible to establish a connection to the reader.
 ► Note the following default configuration settings:

Name	UHF-RFID-Dev
IP address	192.168.0.1
Subnet mask	255.255.255.0
Keep-alive time	2000 ms
DHCP	deactivated

Wi-Fi

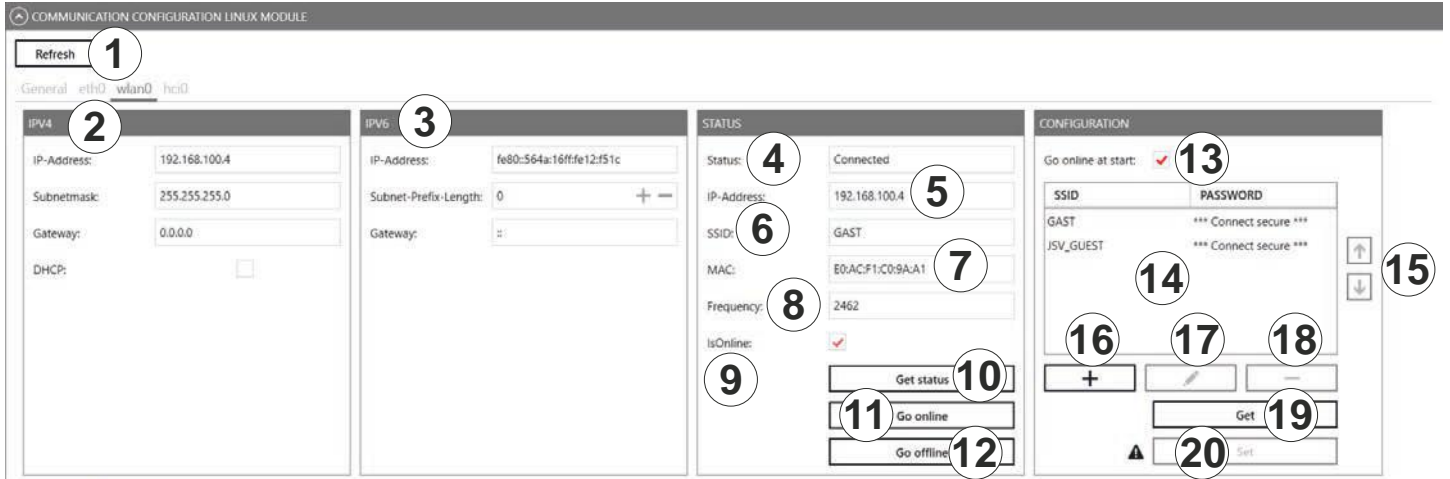

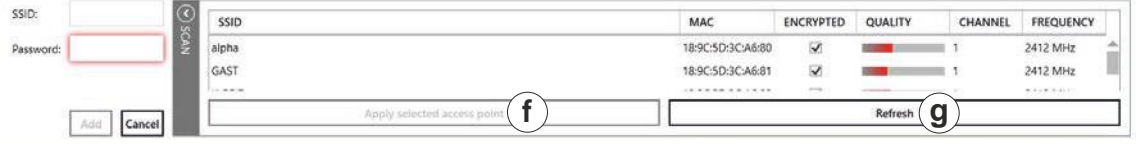
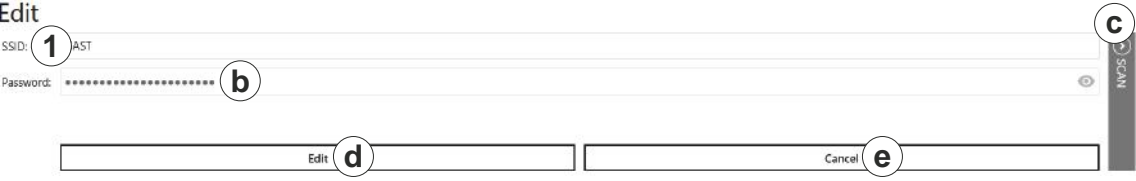

Fig. 30: Communication configuration Linux model: Wi-Fi

①	Refresh	reads the current settings of the communication configuration Linux module
②	IP4	see Fig. 29, p. 63
③	IP6	enters the second IPv6 address (the first IPv6 address is the link local address)
④	Status	shows the status of the Wi-Fi connection
⑤	IP address	shows the current IP address
⑥	SSID	shows the name of the access point
⑦	MAC	shows the MAC address of the access point
⑧	Frequency	shows the frequency of the Wi-Fi connection
⑨	IsOnline	shows whether the Wi-Fi module is online
⑩	Get status	reads the current status of the Wi-Fi module
⑪	Go online	establishes the Wi-Fi connection
⑫	Go offline	interrupts the Wi-Fi connection
⑬	Go online at start	activates or deactivates the Wi-Fi connection as soon as the reader starts
⑭		shows the list of the configured access points with SSID and password; the access points are shown in the priority order
⑮		changes the priority of the selected access point

	<p>adds an access point</p>  <p> (a) enters the SSID of the access point (b) enters the password for the access point (c) opens the list with available access points (d) adds an access point (e) cancels the operation </p> <p>► Click <i>Scan</i> to open the list with available access points:</p>  <p> (f) adds the SSID of the selected access point to (a) (g) updates the list of available access points </p>
<p>(16) +</p>	<p>edits the selected access point</p>  <p> (a) changes the SSID of the access point (b) changes the password of the access point; only active when securely connected (c) opens the list with available access points (d) edits the access point (e) cancels the operation </p>
<p>(17)</p>	<p>deletes the selected access point</p>
<p>(18) -</p>	<p>deletes the selected access point</p>
<p>(19) <i>Get</i></p>	<p>reads the configured access points</p>
<p>(20) <i>Set</i></p>	<p>sets the access points; only active when securely connected</p>

Bluetooth

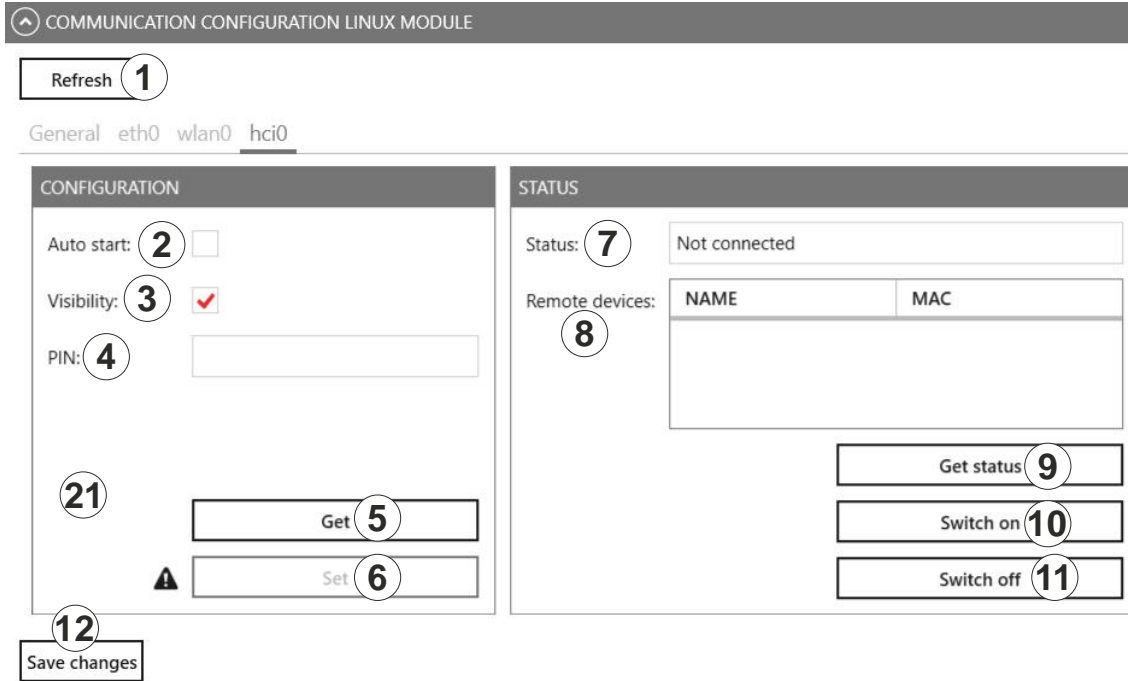

Fig. 31: Communication configuration Linux model: Bluetooth

①	<i>Refresh</i>	reads the current settings of the communication configuration Linux module
②	<i>Auto start</i>	activates or deactivates Bluetooth as soon as the reader starts
③	<i>Visibility</i>	activates or deactivates the Bluetooth visibility of the reader for other devices
④	<i>PIN</i>	sets the PIN for the Bluetooth connection; the default PIN is 4007
⑤	<i>Get</i>	reads the current Bluetooth configuration
⑥	<i>Set</i>	sets the configuration of the Bluetooth connection; only active when securely connected
⑦	<i>Status</i>	shows the status of the Bluetooth connection
⑧	<i>Remote devices</i>	shows the remote devices connected to the reader
⑨	<i>Get status</i>	shows the status of the Bluetooth connection
⑩	<i>Switch on</i>	activates the Bluetooth module
⑪	<i>Switch off</i>	deactivates the Bluetooth module
⑫	<i>Save changes</i>	saves changes

Mobile Communication Interface (2G/3G)

General eth0 gsm0

CONFIGURATION	STATUS
Go online at start: <input checked="" type="checkbox"/> ①	Status: ⑧ Registered
PIN: ② <input type="password"/> ●●●● <input type="checkbox"/>	Type: ⑨ 3G
APN: ③ <input type="text" value="umts.xs4all.nl"/>	Quality: ⑩ <div style="width: 100%; height: 10px; background-color: red;"></div>
Username: ④ <input type="text" value="xs4all"/>	Firmware version: ⑪ 03.001
Password: ⑤ <input type="password"/> ●●●● <input type="checkbox"/>	IMEI: ⑫ <input type="text" value="358625052920107"/>
	Operator: ⑬ <input type="text" value="NL KPN"/>
	Phone number: ⑭ <input type="text"/>
	Module temperature: <input type="text" value="39,00 °C"/> ⑮
	IsOnline: ⑯ <input checked="" type="checkbox"/>
<input type="button" value="Get"/> ⑥	<input type="button" value="Get status"/> ⑰
<input type="button" value="Set"/> ⑦	<input type="button" value="Go online"/> ⑱
	<input type="button" value="Go offline"/> ⑲

Fig. 32: Communication configuration Linux model: mobile communication interface (2G/3G)

①	<i>Go online at start</i>	activates or deactivates the GSM connection as soon as the reader starts
②	<i>PIN</i>	enters the PIN code for the SIM card
③	<i>APN</i>	enters the access point name from the provider
④	<i>User name</i>	enters the access point name from the provider
⑤	<i>Password</i>	enters the access point name from the provider
⑥	<i>Get</i>	reads the current configuration of the GSM module
⑦	<i>Set</i>	sets the configuration of the GSM module; only active when securely connected
⑧	<i>Status</i>	shows the status of the GSM connection
⑨	<i>Type</i>	shows the GSM connection type
⑩	<i>Quality</i>	shows the quality of the GSM connection
⑪	<i>Firmware version</i>	shows the firmware version of the GSM module
⑫	<i>IMEI</i>	shows the serial number of the GSM module
⑬	<i>Operator</i>	shows the operator of the GSM connection
⑭	<i>Phone number</i>	shows the phone number of the SIM card

⑮	<i>Module temperature</i>	shows the temperature of the GSM module
⑯	<i>IsOnline</i>	shows whether the GSM module is online
⑰	<i>Get status</i>	reads the current status of the GSM module
⑱	<i>Go online</i>	establishes the GSM connection
㉑	<i>Go offline</i>	interrupts the GSM connection

14.2 Application

The Application tab enables quick and easy configuration of the Kathrein RFID Reader for a selected application.

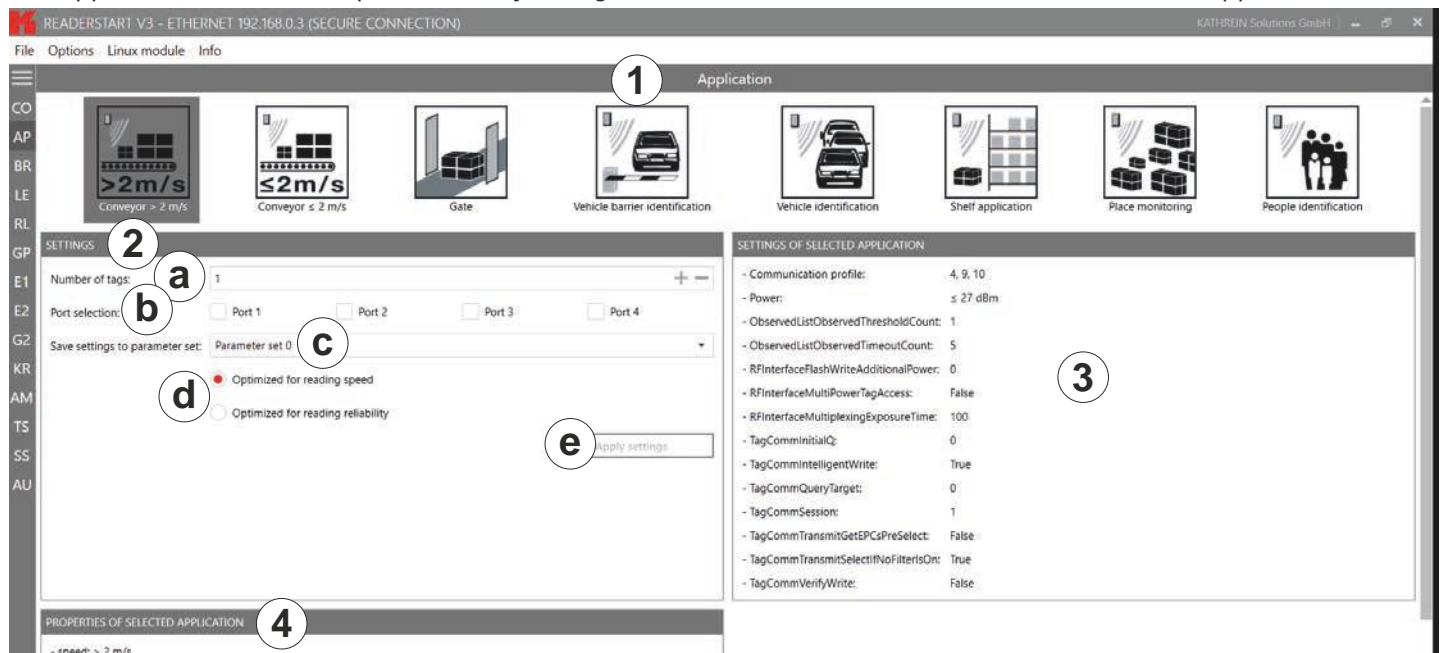

Fig. 33: Application Tab

①	Application	<p>selects between the available applications represented visually by means of labelled pictograms</p> <ul style="list-style-type: none"> ▶ Click on a pictogram to select the application. <ul style="list-style-type: none"> ⇒ The selected pictogram is marked in a darker colour, in Fig. 33 it is <i>Conveyor > 2 m/s</i>.
---	--------------------	---

		<p>changes setting of the selected application</p> <hr/> <p>Ⓐ number of the expected tags</p> <hr/> <p>selects the antenna to be used</p> <p>Ⓑ ▶ Check Ports 1-4 to select the antenna port. It is possible to select one, several or all ports.</p> <hr/> <p>Ⓒ selects the parameter set in which the configuration is saved</p> <hr/> <p>sets the values for max. reading speed or max. reading reliability</p> <p>▶ Click <i>Optimised for reading speed</i> or <i>Optimised for reading reliability</i>. ⇒ The values in <i>Settings of selected application</i> (Ⓒ in Fig. 33) change.</p> <p>When the max. read frequency is set (<i>Optimised for reading speed</i> is activated), the number of readings is maximised. In this case, the same tag can be read several times, because all tags will be reset in the inventory so that they will respond again. Because of reading the same tag multiple times, in a scenario of moving tags it could happen that not all the tags crossing the antenna field are read. The frequency of detection of the same tag is increased. In some cases, the time allowed for detecting the tags may be insufficient, so that some transponders are not detected.</p> <p>When the max. read reliability is set (<i>Optimised for reading reliability</i> is activated), tags that have already been read are not read again in the next inventory, provided they are still being supplied with power. This means that only the tags which have not yet been registered are detected. This way, the probability that all tags are read is increased.</p> <hr/> <p>saves the settings that have been made as the settings for the selected application in the selected parameter set. The programme resets the settings to the factory settings first, thus overwriting the previous configuration.</p> <p>If the settings have been reset, the <i>Apply settings</i> button briefly glows green and a success message is displayed in the <i>Status</i> field of the programme interface.</p> <p>Ⓔ If case of a fault, the <i>Apply settings</i> button briefly glows orange to indicate a warning or red to indicate an error. If the fault has been caused by a missing entry, the field lacking the entry also glows red. A warning/error description is displayed in the <i>Status</i> field.</p> <p>After the settings have been loaded, it is possible to go to the <i>Basic reading</i> tab and to start the read process.</p>
Ⓒ	<i>Settings of selected application</i>	shows the settings that have been made for the selected application in the selected parameter set
Ⓓ	<i>Properties of selected application</i>	shows the properties of the selected application

Tip The read rate is influenced by many parameters. In addition to the selected broadcasting profile with the respective data rates, there are also application-specific data, e.g. how many tags the reader should expect in the field. You can optimise these parameters using the *Expert settings 1* and *2*.

▶ If you are unsure whether the settings you have chosen are best suited for your application, contact KATHREIN Solutions support at <https://www.kathrein-solutions.com/support/overview>.

14.2.1 Available Applications

When the application is selected, the properties and the settings of the selected application are displayed in the respective fields.

The applications available for selection in version 3.00 of the *ReaderStart v3* are shortly described in the following chapters.

Conveyor belt > 2 m/s

- for detecting individual tags in the antenna field on a conveyor belt moving at more than 2 m/s
- the distance between the tags and the antenna must be only a few centimetres

Conveyor belt ≤ 2 m/s

- for detecting and describing individual tags in the antenna field on a conveyor belt moving at a speed less than or equal to 2 m/s
- the distance between the tags and the antenna must be only a few centimetres

Gate

- for detecting multiple tags in the antenna field as they pass through a gate

Vehicle Barrier Identification

- for detecting and describing individual tags in the antenna field which are not moving
- the distance between the tags and the antenna must be less than a few metres

Vehicle Identification

- for detecting and describing multiple tags in the antenna field which are moving at a speed of more than 14 m/s
- the distance between the tags and the antenna must be less than a few metres

Shelf Application

- for detecting and describing individual tags in the antenna field which are not moving
- the distance between the tags and the antenna must be less than 1 m

Place Monitoring

- for detecting and describing multiple tags in the antenna field which are not moving
- the distance between the tags and the antenna must be less than 1 m

Personal Identification

- for detecting multiple tags in the antenna field which are moving at a speed of not more than 3 m/s
- the distance between the tags and the antenna must be less than 1 m

14.3 Basic Reading

This tab is divided into two parts, the left part contains a table with information about the read tags (Ⓐ in the figure below), the right part (Ⓑ) shows the statistics as well as options to control the reading process, described in the chapters to follow.

The appearance and disappearance of a tag is shown in colour for better visual effect. When a tag appears in the field, the row is represented by the green tag information, when it disappears, the row is red.

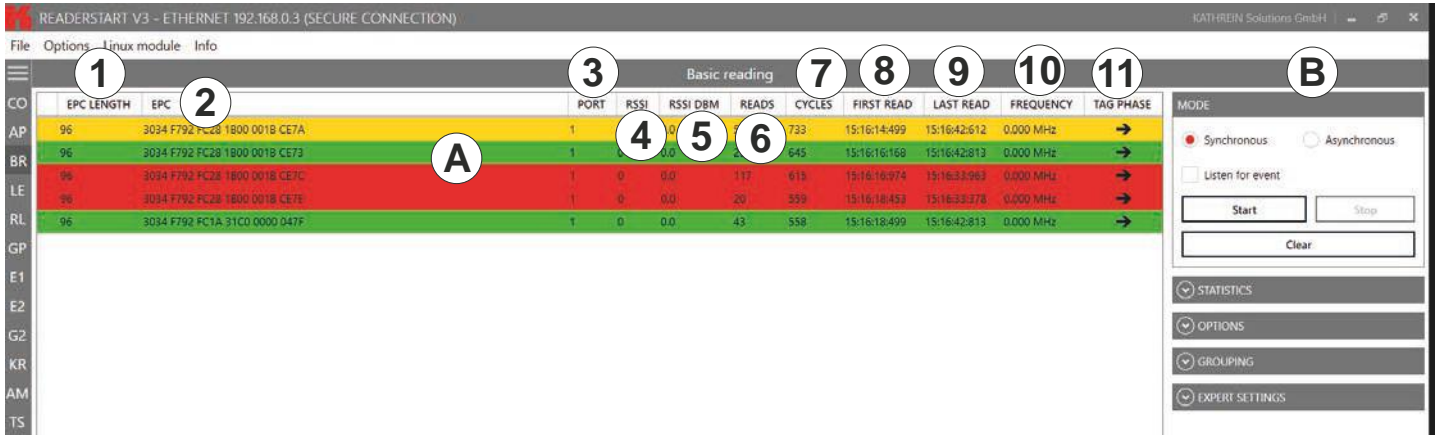

Fig. 34: Basic reading

Ⓚ	EPC length	indicates the length in bits of the EPC; valid lengths 0–496
Ⓛ	EPC	EPC of the tag in the hexadecimal representation
Ⓜ	Port	antenna port at which the tag is read; valid values 1–4
Ⓨ	RSSI	unitless (shown as having no units) signal strength of the tag response
Ⓩ	RSSI DBM	shows the RSSI value in dBm
ⓐ	Reads	shows how many times this tag has been read successfully
ⓑ	Cycles	indicates how often an inventory has been started
ⓓ	First read	timestamp of the first tag reading
ⓔ	Last read	timestamp of the last tag reading
ⓖ	Frequency	shows the used transmission frequency
ⓗ	Tag phase	<p>shows the tag phase in form of a rotating pointer</p> <p>This parameter is used to distinguish between stationary and moving transponders. If the transponder is moving away from the antenna, the pointer rotates counterclockwise, and clockwise, if the transponder is moving towards the antenna. The movement speed is directly proportional to the rotational speed of the pointer. In a full rotation of 360°, the transponder travels a distance of 17 cm.</p> <div style="border: 1px solid black; padding: 10px; margin-top: 10px;"> <p>! Note that the reader has to change the transmission frequency every 4 seconds, causing a phase jump.</p> </div> <p>The tag phase is also shown in the TagScan monitor; see <i>TagScan</i>, p. 103</p>

14.3.1 Mode

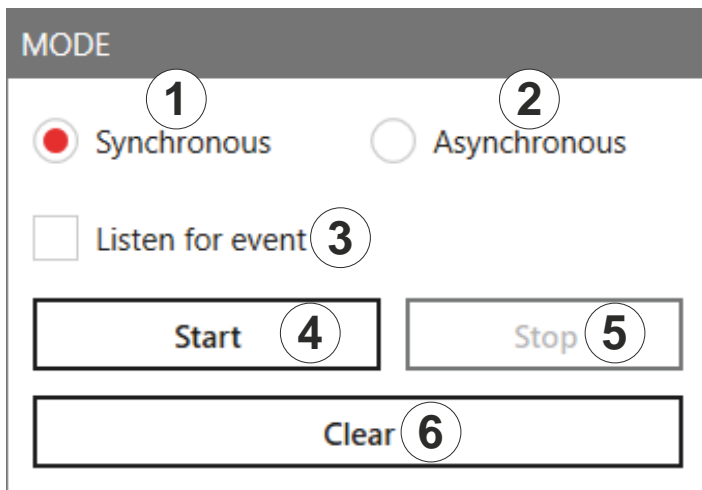

Fig. 35: Basic reading: mode

①	Synchronous	allows the facility to switch the carrier off during the idle times, saving power This mode is intended for applications in which the requirements for timing are not very demanding. The inventory of the tags is performed across all the antennas that are configured. Once all the tags in the field have been read on the last antenna, data are sent to the PC. The PC automatically retriggers the inventory of the tags.
②	Asynchronous	is intended for applications for which maximum performance is required The reader starts the inventory as quickly as possible, and at the end of an inventory it does not deliver every tag that was read to the PC, but only those that have recently appeared in the field or left it. This way, the time required for communication between the reader and the client is minimised. The timing of when a tag was reliably read in the field and when the tag no longer appears in the field can be defined more precisely using parameters. ► For more details of the <code>ObservedThresholdCnt</code> and <code>ObservedTimeoutCnt</code> parameters, refer to the <i>Configurational manual reader</i> .
③	Listen for event	deactivates or activates waiting for the result of the command executed by an external trigger and shows the result in Ⓐ in Fig. 30 When deactivated, there is no waiting process and it is possible to start the reading process at any time.
④	Start	starts the reading
⑤	Stop	stops the reading
⑥	Clear	deletes the reading results from the table on the left (Ⓐ in Fig. 34, p. 72)

14.3.2 Starting and Stopping the Reading

- ✓ All the settings have been applied and the mode selected.
- Click **Start** (④ in Fig. 35) to start the reading.
- Click **Stop** (⑤) to stop the reading.
- Click **Clear** (⑥) to remove all tag entries from the table (Ⓐ in Fig. 34, p. 72).

14.3.3 Statistics

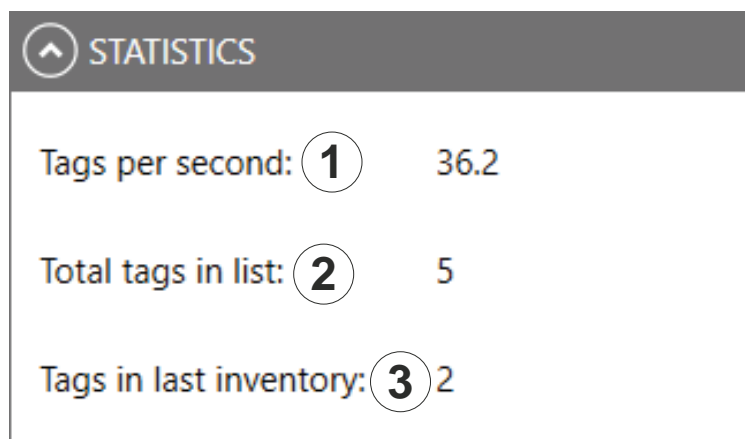

Fig. 36: Basic reading: statistics

①	<i>Tags per second</i>	displays the current reading performance
②	<i>Total tags in list</i>	shows the total number of tags in the list
③	<i>Tags in last inventory</i>	shows number of tags detected in the last inventory

14.3.4 Options

Fig. 37: Basic reading: options

①	Memory bank	<p>selects between <i>RFU</i>, <i>EPC</i>, <i>TID</i> and <i>User</i> memory banks</p> <ul style="list-style-type: none"> ▶ Click on the arrow to open a drop-down list to select a memory bank. ▶ Click Save to file (④) to store the values <i>RFU</i>, <i>EPC</i>, <i>TID</i> and <i>User</i> in a CSV file.
②	Break after reading	<p>specifies the duration of the break between two inventories in milliseconds</p> <p>During the break, the carrier can be deactivated.</p> <ul style="list-style-type: none"> ▶ For more information about switching off the carrier, refer to <i>Configuration Manual for Kathrein RFID UHF Readers</i>.
③	Bulk reading	<p>sets the time in milliseconds after which the result lists of an inventory is sent to the PC</p> <p>To keep the time between inventories as short as possible in the synchronous mode, data transmission between the inventories can be dispensed with. That means that the reader saves all the tags that it finds in the field in its internal RAM and sends them to the PC after the time set in Bulk reading.</p>
④	Save to file	<p>saves the data displayed at (Ⓐ in Fig. 34, p. 72)</p> <ul style="list-style-type: none"> ▶ Click Change path to log file to select or change the location where the information is saved. ▶ Right-click on Save to file to open or delete the file.
⑤	Selected tag as background	<p>changes the basic reading interface background to the colour of the selected tag row</p>
⑥	ARU-CSB-ELC	<p>activates the additional presentation for an ARU-CSB-ELC antenna</p>
⑦	Show data as UTF8	<p>shows tag data in the UTF8 format</p>

14.3.5 Grouping

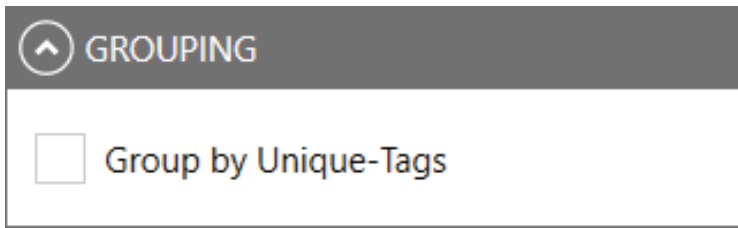

Fig. 38: Basic reading: grouping

It is possible to sort the read result by means of unique tags. This is useful in multi-antenna applications.

If, for example, in a gate application with 4 antennas, a palette of 100 tags is read, the maximum number of the read results is 400. However, not all tags are read by all antennas, therefore, the read result will be about 250.

► Check *Group by unique tags* to find out how many different tags have been read.

14.3.6 Expert settings

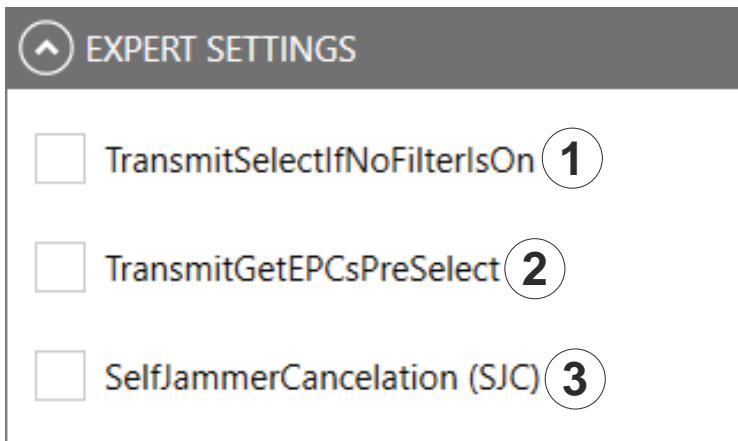

Fig. 39: Basic reading: expert settings

①	<p>TransmitSelectIfNoFilterIsOn</p>	<p>resets all the tags that are defined in the field at a given time</p> <p>When the tag count is very high (> 200), it is possible to speed up the detection of the tags by commanding the reader to change to new Select command; see <i>EPCglobal Gen2 Specification</i>. It is possible to test it in the menu <i>Expert Settings</i>.</p> <p>► Check TransmitSelectIfNoFilterIsOn.</p> <p>⇒ A "select" is sent in each inventory, i.e. all the tags that are defined at this time in the field are reset.</p> <p>However, it can happen that the tags that have been read already are reset and re-recorded again. To capture only new tags, it is necessary to prevent a renewed "select".</p> <p>► Uncheck TransmitSelectIfNoFilterIsOn.</p> <p>⇒ The tags are read once. This way, no time is lost due to a reread.</p> <div style="border: 1px solid black; padding: 10px; margin-top: 10px;"> <p>! Note that it is not possible to retrieve tags in which the read operation had been interrupted. This way, it may happen that not all the tags are read. Keep that in mind when unchecking this parameter in order to achieve top results.</p> </div>
---	--	--

②	Transmit-GetEPCsPreSelect	see Chapter <code>TransmitGetEPCsPreSelect</code> in <i>Configuration Manual for Kathrein RFID UHF Readers</i>
③	SelfJammerCancellation (SJC)	activates/deactivates the optimal receiver sensitivity of the reader This process might be necessary in an industrial environment with increased reflection, e.g. due to metallic structures. However, this process is very time-consuming and slows down the tag detection.
④	SJC Scan interval	sets the interval after which the <i>SelfJammerCancellation</i> process is executed

14.3.7 ARU-CSB-ELC Antenna Reader Unit

The ARU-CSB-ELC antenna reader unit with the integrated 30° wide-range antenna is controlled by the @KRAI reader. The antenna can be switched to three different beam positions.

Each individual position can be selected fix or all selected positions are exchanged dynamically. The user will get a read result with an indication of the position for the run of a tag (left, centre, right).

Using the time sequence of the reading results of these positions, it is possible to determine the direction of a transponder. Tags which do not change their position are captured as well.

The ARU-CSB-ELC antenna is used, e.g. in gate applications. In addition to the "simple" detection that a tag has passed the gate, the direction of the movement is displayed as well. This can be used, for example, to book a delivery of goods as an input or output immediately.

Having selected the *ARU-CSB-ELC* (Ⓢ in Fig. 37, p. 75) under *Options*, the lower part of the screen shows the spatial allocation of a transponder:

CO	EPC LENGTH	EPC	PORT	RSSI	RSSI DBM	READS	CYCLES	FIRST READ	LAST READ	FREQUENCY	TAG PHASE
AP	96	3034 F792 FC1A 31CD 0000 047F	2	108	-65.3			17:36:35:586	17:36:42:117	866.900 MHz	←
BR	96	3034 F792 FC28 1800 001B CE7A	2	100	-67.2			17:36:35:657	17:53:22:867	867.500 MHz	↖
LE	96	3034 F792 FC28 1800 001B CE73	2	107	-62.0			17:36:35:661	17:53:22:805	867.500 MHz	↘
RL	96	3034 F792 FC1A 31CD 0000 047F	1	94	-73.2			17:53:22:368	17:53:22:368	866.300 MHz	↑
GP	96	3034 F792 FC28 1800 001B CE7A	1	73	-89.1			17:53:23:306	17:53:23:306	866.900 MHz	↖

Options Panel:
 MODE: Synchronous Asynchronous
 Listen for event
 Start Stop
 Clear
 ARU-CSB-ELC
 Show data as UTF8
 GROUPING EXPERT SETTINGS
KATHREIN
 Active parameter set: 0

Fig. 40: Basic reading: ARU-CSB-ELC

Tip The WIRA-30-CSB-KRAI antenna is presented in a similar way and is shown under *Options* when connected.

14.4 LED



Not all readers support the functionality with 12 LEDs; all readers have at least 4 LEDs. Please check the reader data sheet for information.

In this tab, it is possible to assign various functions to the 12 LED channels. It is possible to activate other parameters, depending on the selected function.

Tip

As supplied to customer, the first 4 LEDs are allocated to antennas 1–4, LED 5 is allocated to GSM, LED 6 to KRAI, LED 11 and LED 12 to Bluetooth and Wi-Fi, respectively. It is possible to customise this allocation.

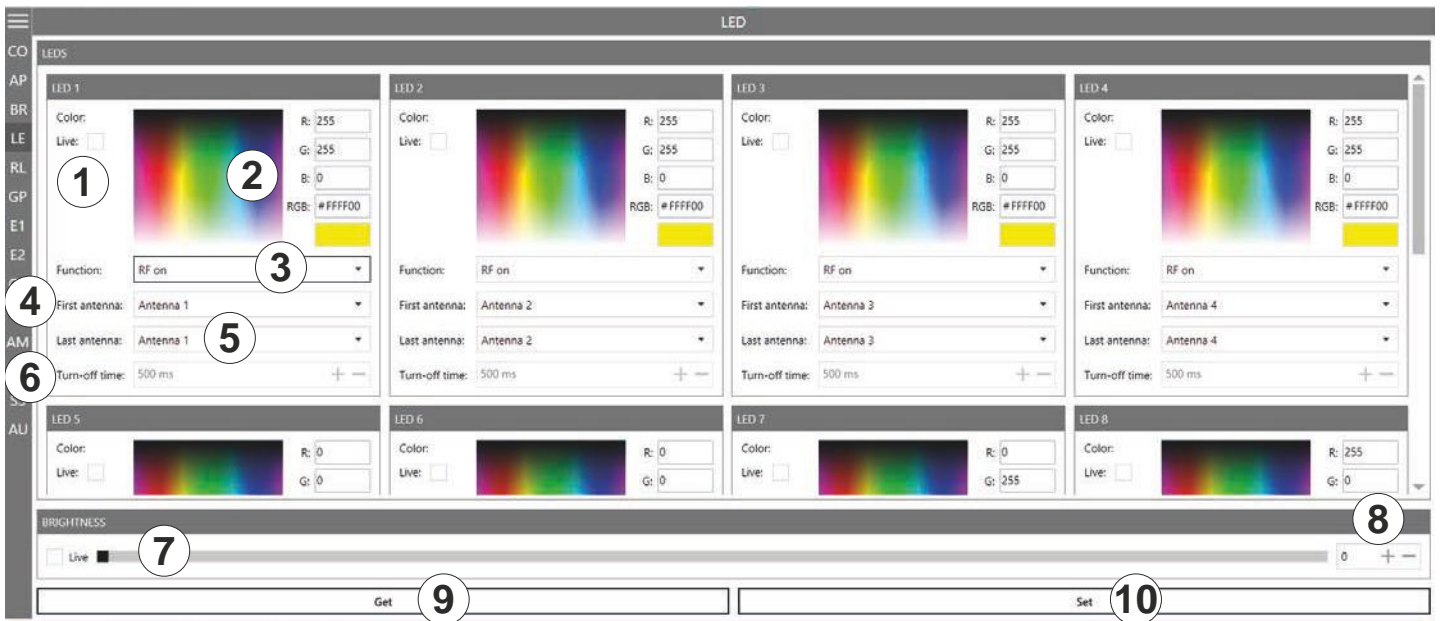

Fig. 41: LED

①	Live	shows the changed LED colour in real time
②		shows RGB values
③	Function	selects between the functions described in <i>Selecting Functions</i> , p. 79
④	First antenna	the first antenna for the selected function
⑤	Last antenna	the last antenna for the selected function
⑥	Turn-off time	sets the time for how long LED is on for the selected function
⑦	Brightness (live)	changes the LED brightness for all active LEDs (between 0 (auto brightness determined by the integrated light sensor) and 100) ▶ Move the brightness position along the bar to change the brightness of the LED. ⇒ The number at ⑧ changes.
⑧		changes the LED brightness (between 0 and 100) ▶ Click + or – to change the brightness of the LED.
⑨	Get	shows the current settings for all LEDs
⑩	Set	sets the new settings for all LEDs for which the settings have been altered

14.4.1 Selecting Functions

► Click on the arrow (③ in Fig. 41, p. 78) to select between the following functions:

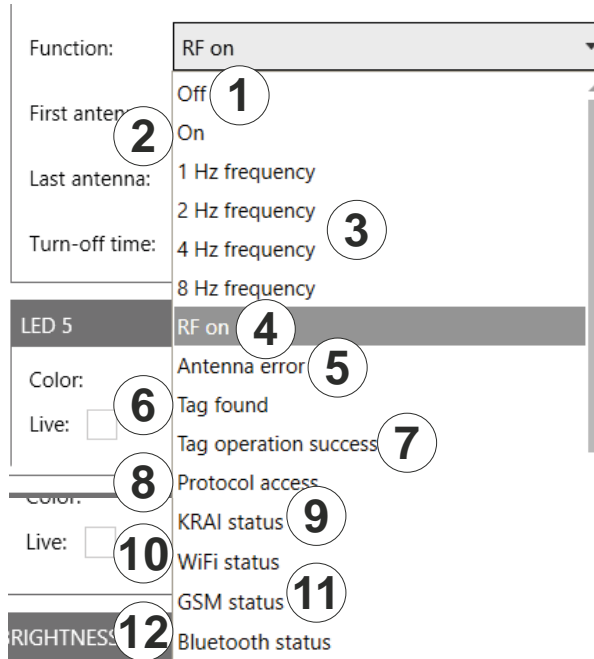

Fig. 42: LED: functions

①	<i>Off</i>	deactivates the LED
②	<i>On</i>	activates the LED (always on)
③	<i>1 Hz – 8 Hz frequency</i>	LED flashes at a frequency of 1/2/4/8 Hz
④	<i>RF on</i>	LED lights up for <i>Turn-off time</i> milliseconds if a radio frequency is present at the antenna <i>First antenna</i> to <i>Last antenna</i> has been successful
⑤	<i>Antenna error</i>	LED lights up for <i>Turn-off time</i> milliseconds if a error occurs at the antenna <i>First antenna</i> to <i>Last antenna</i>
⑥	<i>Tag found</i>	LED lights up for <i>Turn-off time</i> milliseconds as soon as a tag has been found at the antenna <i>First antenna</i> to <i>Last antenna</i>
⑦	<i>Tag operation success</i>	LED lights up for <i>Turn-off time</i> milliseconds if a tag operation at the antenna <i>First antenna</i> to <i>Last antenna</i> has been successful
⑧	<i>Protocol access</i>	enables the protocol to switch the LED on and off
⑨	<i>KRAI status</i>	shows whether a @KRAI antenna is connected to the reader
⑩	<i>Wi-Fi status</i>	shows the Wi-Fi status
		flashing trying to connect
		permanently lit connected off Wi-Fi disabled
⑪	<i>GSM status</i>	shows the GSM status
		flashing trying to connect
		permanently lit connected off Wi-Fi disabled
⑫	<i>Bluetooth status</i>	shows the Bluetooth status
		flashing trying to connect
		permanently lit connected off Wi-Fi disabled

14.5 RSSI LED Bar (received signal strength indicator)

This menu is used to determine the strength of the received signal.

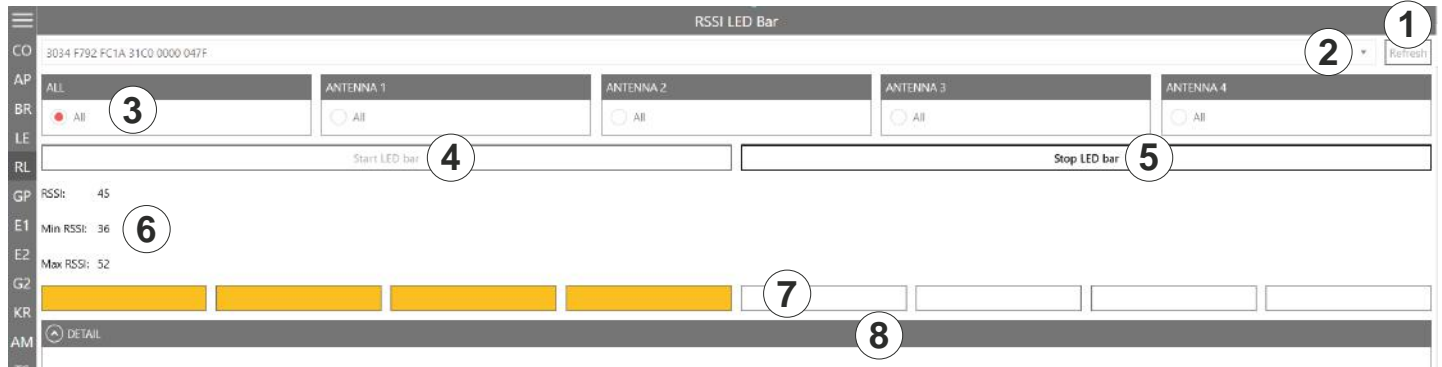

Fig. 43: RSSI LED Bar

①	Refresh	updates the number of detected tags
②		selects a tag from the number of the detected tags by means of the drop-down menu
③	All/Antenna 1-4	selects whether the tag has to be read on all antennas or only one antenna
④	Start LED bar	measures the signal strength
⑤	Stop LED bar	stops the measurement
⑥	RSSI, Min. RSSI, Max. RSSI	shows the current RSSI value as well as the minimum and the maximum RSSI values
⑦		shows the read range by means of the coloured bars
	green	signal strength is high (high RSSI value)
	yellow	signal strength is medium (medium RSSI value)
	red	signal strength is low (low RSSI value)
⑧	Details	shows detail information about RSSI for each antenna and property

14.6 GPIO Functions

Readers with GPIO functionality¹⁾ offer the possibility to set up small controls which trigger the reader, for instance by means of a light barrier, or which trigger an action at the outputs of the reader by reading specific tags. Such an action can switch an output to control the flow of goods.

The GPIO tab allows the reader to interact with its environment. The GPIO function tab allows the user to manually read or switch inputs and outputs of the respective application. For more complex procedures, it is possible to create action lists which execute a sequence of commands on the reader. This list can then be linked to various inputs.



Fig. 44: GPIO

The GPIO tab is divided into 3 sections, *IO Configuration*, consisting of *Input* and *Output*, *Test Input* and *Test Output*, *Action List* and *Assign Input to Action List* which are described in the following chapters.

14.6.1 IO Configuration

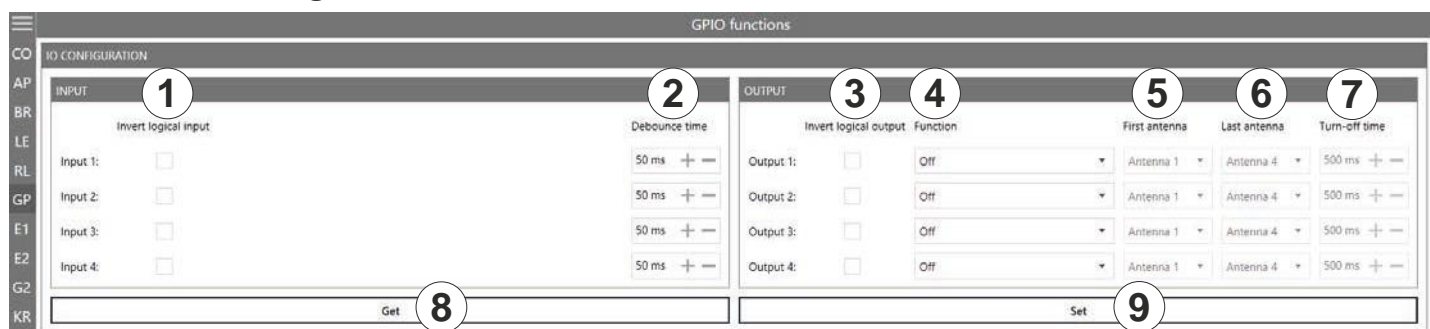

Fig. 45: GPIO: IO Configuration

①	<i>Invert logical input</i>	negates the electrical input signal and uses this state for processing in the reader; if the parameter is not checked, the signal is used
②	<i>Debounce time</i>	assigns a debounce time in milliseconds to each channel depending on the sensor being used (mechanical or electrical switch)
③	<i>Invert logical output</i>	negates the electrical output signal
④	<i>Function</i>	selects between the functions described in <i>Selecting Functions</i> , p. 79
⑤	<i>First antenna</i>	the first antenna for the selected function

¹⁾ All Generation 3 readers have GPIO.

⑥	Last antenna	the last antenna for the selected function
⑦	Turn-off time	sets the time for how long the output is on for the <i>Tag found</i> and <i>Tag operation successful</i> function
⑧	Get	reads the current IO configuration settings
⑨	Set	sets the output settings

14.6.2 Test Input and Output

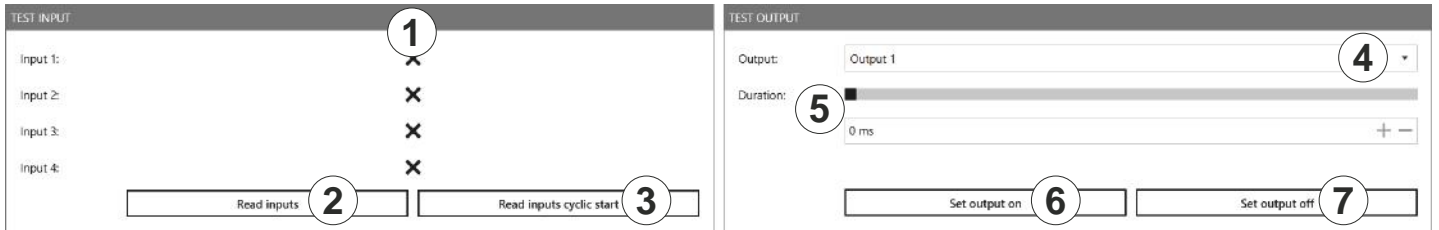

Fig. 46: GPIO: Test Input and Test Output

Test Input

Each input channel has two configuration parameters available:

①	Input 1-4	shows logical input 1-4; will only be shown if <i>Invert logical input</i> for the respective input has been checked at <i>IO Configuration</i> (① in Fig. 45, p. 81)
②	Read inputs	reads the inputs once
③	Read inputs cyclic start/stop	reads the inputs in a loop/stops the reading

Test Output

④	Output	selects output 1-4 by means of the drop-down menu ► In order to use this function, select the <i>Protocol access</i> function for the respective output (see <i>IO Configuration</i> , p. 81 and <i>Selecting Functions</i> , p. 79).
⑤	Duration	sets time in ms after which the output automatically returns to its idle mode either by moving the bar or by entering the value If the duration is set to its maximum value (65535), the output is permanently on.
⑥	Set output on	switches on the output
⑦	Set output off	switches off the output

14.6.3 Action List and Assign Input to Action List

To automate the processes, it is possible to store command sequences on the reader in the form of action lists. These are triggered by a change of edge at the selected input.

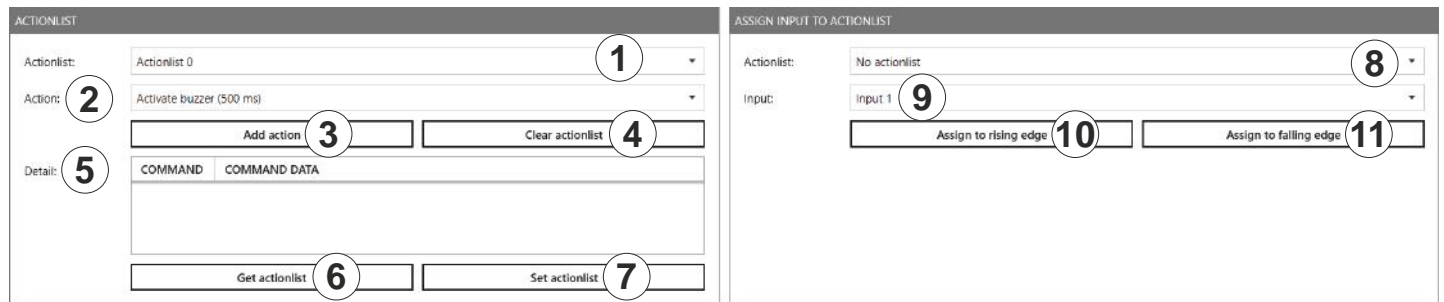

Fig. 47: GPIO: Action List and Assign Input to Action List

Action List

Each input channel has two configuration parameters available:

①	Action list	selects an action list (0–127) from the drop-down menu to save the action in
②	Action	selects an action from the drop-down menu, e.g. <i>Activate buzzer (500 ms)</i> , <i>SyncGetEPCs</i> , <i>ASyncGetEPCs</i> , <i>ASyncStopCommand</i> ; see also <i>Adding Actions to the Programme</i> , p. 84 ▶ To see the commands contained in the current action list, type in %userprofile%\Documents\KATHREIN Solutions GmbH\ReaderStart v3 into the Windows search field.
③	Add action	adds action; the action is shown under <i>Details</i> (⑤)
④	Clear action list	deletes actions; no actions are seen under <i>Details</i> (⑤) <div style="border: 1px solid black; padding: 10px; margin-top: 10px;"> <p>Tip To remove only one action from the list:</p> <ol style="list-style-type: none"> 1. Select an action from the list shown under <i>Details</i>. 1. Right-click on the selected action. <ul style="list-style-type: none"> ⇒ The pop-up message <i>Remove entry</i> appears. 2. Click on <i>Remove entry</i> to delete the action. <ul style="list-style-type: none"> ⇒ The action is deleted from the list. </div>
⑤	Details	shows added actions in the chronological order as they have been selected
⑥	Get action list	shows the current action list
⑦	Set action list	saves the set action list (flashes blue after having added an action to the <i>Details</i> (⑤))

Assign Input to Action List

⑧	Action list	selects an action list (0–127) from the drop-down menu to assign to the input in (⑨)
⑨	Input	assigns the action list to input 1–4 from the drop-down menu
⑩	Assign to rising edge	assigns the action list to the rising edge
⑪	Assign to falling edge	assigns the action list to the falling edge

Tip

► If you would like to assign the action list to both the rising and the falling edge, click *Assign to rising edge* and then *Assign to falling edge*.

To cancel the assignment:

► Restart/reset the reader or select *No action list* under *Action list* (Ⓢ).

Adding Actions to the Programme

The action lists consist of a sequence of individual actions which can be loaded in the form of an XML file in the *Action* context menu:

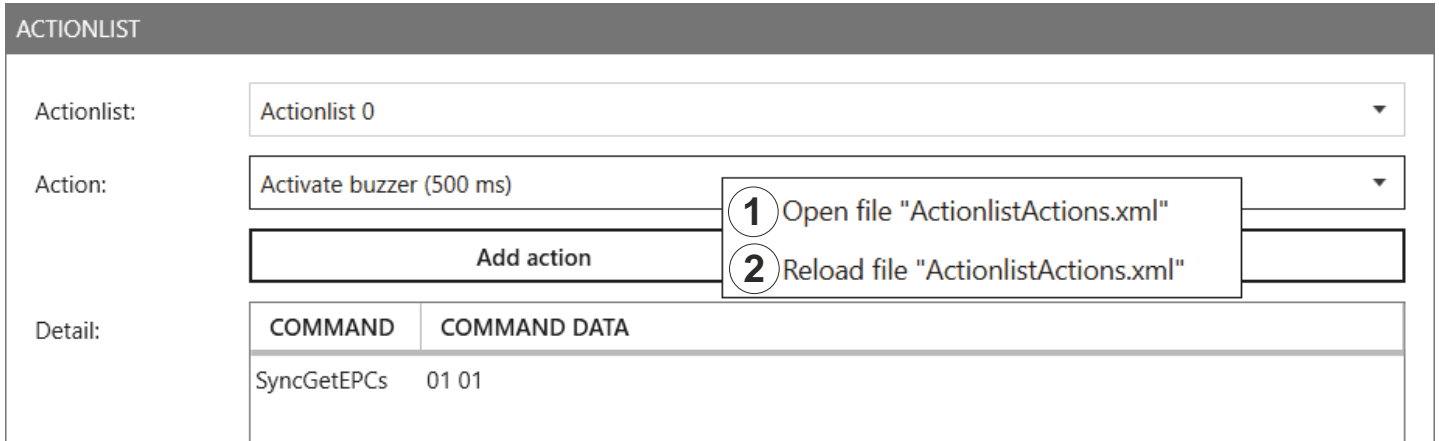

Fig. 48: GPIO: action list, action context menu

①	Open file "ActionlistActions.xml"	opens the actions list in the XML format in a text editor
②	Reload file "ActionlistActions.xml"	reloads the action list; it is necessary to reload the action list after a new action has been added to the XML file containing the actions or some changes have been made in it

The ReaderStart creates a directory in which the system variables are stored in the folder %userprofile%\Documents\KATHREIN Solutions GmbH\ReaderStart v3. It is possible to edit the ActionlistActions.xml file manually using a text editor.

► To see the individual actions, refer to the *Configuration Protocol*.

The approximately 150 reader commands with corresponding variance of the parameters do not allow for a uniform list. A selection of all options is extensive. Therefore, it is recommended to only list commands required in the application.

The following example demonstrates the syntax of the actions:

```
<ActionlistActions>
  <!--Activate buzzer for 500 ms, CommandID: 0x0045, Parameter: 0x01F4-->
  <Action>
    <Description>Activate buzzer (500 ms)</Description>
    <CommandID>0045</CommandID>
    <!--LSB first-->
    <Parameter>F4</Parameter>
    <Parameter>01</Parameter>
  </Action>
```

```

<!--Get EPCs, CommandID: 0x0101-->
<Action>
    <Description>Get EPCs</Description>
    <CommandID>0101</CommandID>
    <!--LSB first-->
</Action>
</ActionlistActions>

```

The example above shows the *Activate buzzer 500 ms* and *Get EPCs* actions.

14.7 Expert Settings 1

The ReaderStart software is a powerful tool for the reader configuration. It allows the reader to be customised to any application. The *Expert settings 1* and *2* allow the reader's RF interface and communications profile to be optimised to the tag so that the reader is optimally customised to the application.

There are eight parameter sets available for saving the reader configuration. It is possible to save all settings for the transmission power, the antenna multiplex configuration, the RF settings and the air interface parameters.

Other parameters can be changed in *Expert settings 2*.

► For more information about the individual parameters, refer to *Reader Configuration Manual for Kathrein RFID UHF Readers*.

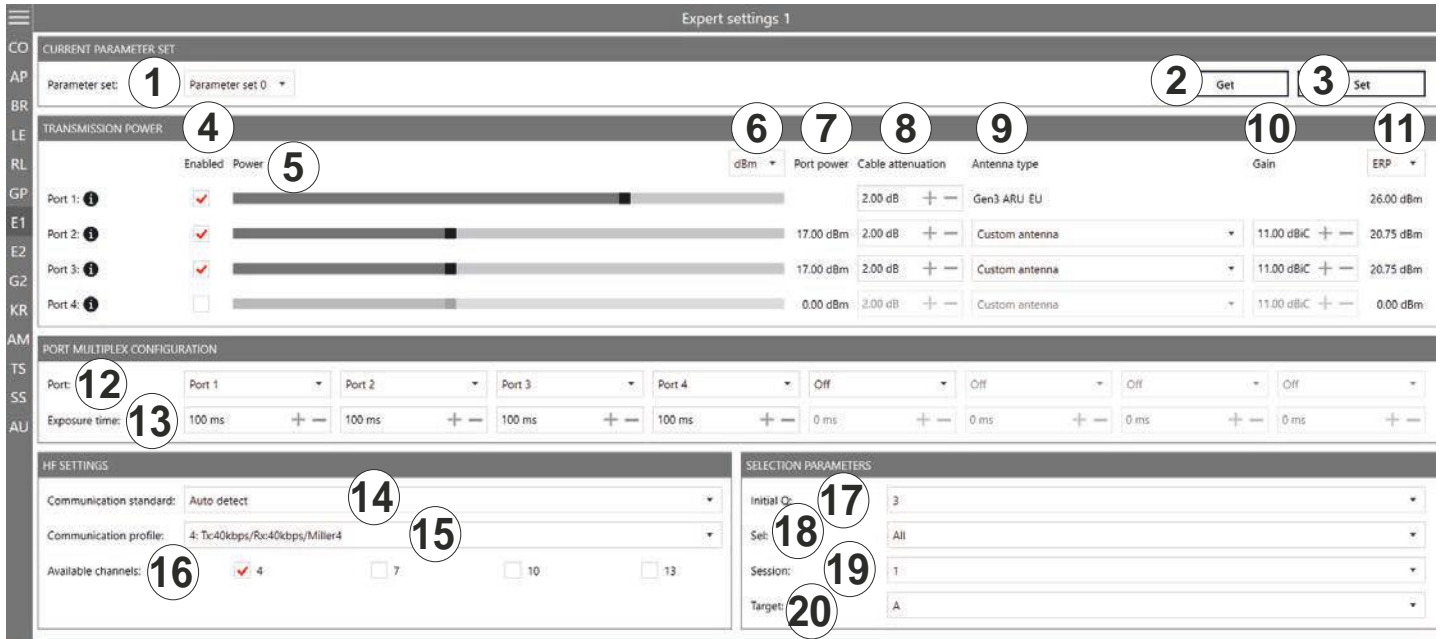

Fig. 49: Expert settings 1

①	Parameter Set	selects a parameter set
②	Get	reads the current settings of the selected parameter set in the system
③	Set	sets the parameters
④	Enabled	activates/deactivates the possibility to make changes in the port
⑤	Power	changes the power on the port (ERP)
⑥	dBm/W	switches between <i>dBm</i> and <i>W</i>
⑦	Port power	shows the selected power on the port
⑧	Cable attenuation	selects cable attenuation in the range between 0 and 63.75 dB

⑨	Antenna type	selects the antenna type between pre-defined and custom antennas If the pre-defined antenna is selected, the programme sets the antenna gain to the maximum value permitted for this antenna. If <i>Custom antenna</i> is selected, it is possible to freely set the gain and power.
⑩	Gain	selects the antenna gain between -32.00 dBiC and 31.75 dBiC
⑪	ERP/EIRP	switches between <i>ERP</i> and <i>EIRP</i>
⑫	Port	selects the antenna port or deactivates it If the antenna is not activated, the system proceeds to the next antenna in the <i>Port Multiplex Configuration</i> . ► For more details, refer to the Chapter <i>MultiplexingAntennaport1...8</i> in the <i>Reader Configuration Manual</i> .
⑬	Exposure time	specifies the exposure time on the antenna; only used for asynchronous operation ► For more details, refer to the Chapter <i>MultiplexingExposureTime1...8</i> in the <i>Reader Configuration Manual</i> .
⑭	Communication Standard	selects a country-specific communication standard; the device version determines which communication standard is permitted
⑮	Communication Profile	selects the profile for the data rate and read reliability This option allows the technician to directly influence the performance of the reader and the spectrum of the signal. The profile names contain basic orientation on the transmission and reception data rates.
⑯	Available channels (only available for ETSI-readers)	selects the channel for the reader to use Depending on the region, the reader transmits in the frequency range 865–868 MHz for Europe or 902–928 MHz for USA/Canada. In Europe, the number of channels to be used can be limited. For this reason, it is necessary to check the related check box for each channel the reader is to use. This way, it is possible to avoid using specific channels on which there is interference.
⑰	Initial Q	reflects the number of tags expected in the field; see also Chapter <i>InitialQ</i> in <i>Reader Configuration Manual</i>
⑱	Sel	specifies whether other parameters are of interest for an inventory of the tag population or not; see also Chapter <i>QuerySel</i> in <i>Configuration Manual for Kathrein RFID UHF Readers</i>
⑲	Session	sets which session the reader is to work with; see also Chapter <i>Sessions</i> in <i>Reader Configuration Manual</i>
⑳	Target	specifies which tags in the population should take part in the inventory; see also Chapter <i>QueryTarget</i> in <i>Configuration Manual for Kathrein RFID UHF Readers</i>



To operate the reader in accordance with the related national standards, it is necessary to take into account the antenna gain and the cable attenuation in the transmission power setting.

- Do not exceed the permitted transmission power. Failure to observe this instruction can result in non-compliant operation of the reader leading the termination of the type approval.

14.7.1 Port Power

In Europe, the radiated power is limited in accordance with ETSI 302208 to 2 W ERP. In the FCC/IC region, max. 1 W connected RF power applies with an antenna gain of 6 dBi. If the antenna gain is greater than 6 dBi, it is necessary to reduce the RF power accordingly. While the European standard refers to a half-wave dipole, FCC part 15/RSS 210 refers to an isotropic radiator.

To set the port power, it is necessary to include the length-dependent cable attenuation and the antenna gain into the calculation of the port power. An example for the calculation of the port power for Europe and FCC/IC is given below.

The following applies to the European approval region:

$$P_{\text{port}} = P_{\text{ERP}} + D_{\text{cable}} - G_{\text{HW}}$$

where P_{port} is the port power of the reader in dBm; P_{ERP} is the port power based on a half-wave dipole in dBm; D_{cable} is the cable attenuation in dB; G_{HW} is the antenna gain based on a half-wave dipole.

The cable attenuation is the length-dependent attenuation of the cable at the related frequency:

$$D_{\text{cable}} = l \cdot D_{\text{dB/m}}$$

where D_{cable} is the cable attenuation in dB; l is the length in m; $D_{\text{dB/m}}$ is the attenuation in dB/m at frequency.

The antenna gain is stated in various different units. These units include dBi and dBic. The units dBi and dBic refer to an isotropic (spherical) radiator, where dBic refers to a circularly polarised isotropic radiator and dBi to a linearly polarised isotropic radiator.

In the European approval area, the radiated power must not exceed 2 W ERP. This figure refers to a half-wave dipole. The relationship shown below exists between an isotropic radiator (dBi) and a half-wave dipole.

$$G_{\text{HW}} = G_{\text{isot}} - 2.14 \text{ dB},$$

where G_{HW} is gain-based on a half-wave dipole and G_{isot} is gain-based on an isotropic radiator in dBi

If the gain of the antenna is referred to the polarisation of a circular isotropic antenna (dBic), the linear gain of the antenna is 3 dB lower. As a result, the port power can be increased by 3 dB.

$$G_{\text{HW}} = G_{\text{isot}} - 2.14 \text{ dB} - 3 \text{ dB},$$

where G_{HW} is gain-based on a half-wave dipole and G_{isot} is gain-based on an isotropic radiator in dBi

In the FCC/IC approval region, the RF power connected at the antenna input must not exceed 1 W. If the gain of the antenna is higher than 6 dBi, it is necessary to reduce the RF power correspondingly. The reader's port power is then:

$$P_{\text{port}} = P_{\text{cond}} + D_{\text{Kabel}} \text{ with } P_{\text{cond}} \leq 1 \text{ W and } G_{\text{isot}} \leq 6 \text{ dB},$$

where P_{port} is the port power of the reader in dBm; P_{cond} is the power on antenna output in dBm; D_{cable} is the cable attenuation in dBm; G_{HW} is the antenna gain in dBi.

If the antenna gain is stated in dBic, the reader's transmission power can be increased by 3 dB.

The port power for the European variant can be set in 0.25-dB steps from 6 dBm to 33 dBm.

14.8 Expert Settings 2

The Expert settings 2 tab is divided into four sections for further configuration of the reader. In this tab, it is possible, for example, to change the default parameter set, copy one parameter set into another, read reader parameters to determine their ID and configure *Select Filter Settings*.

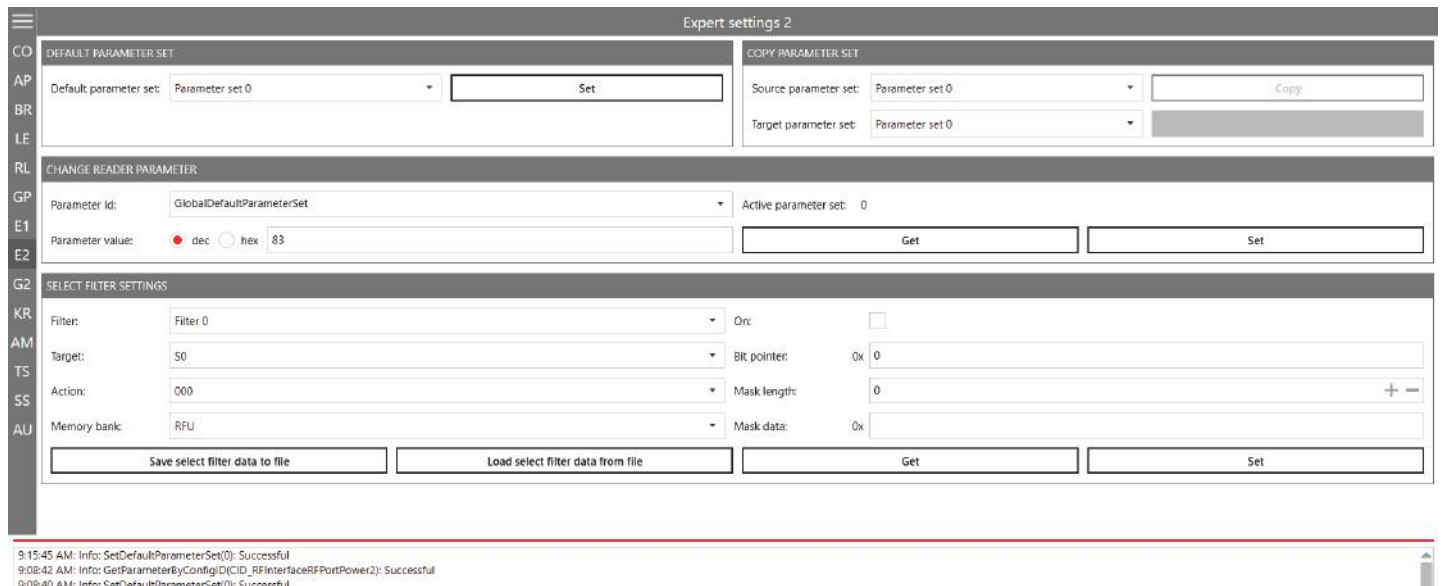

Fig. 50: Expert settings 2

14.8.1 Default Parameter Set

The *Default parameter set* allows configuration of the parameter set that is loaded from the Flash into the RAM when the reader is started.

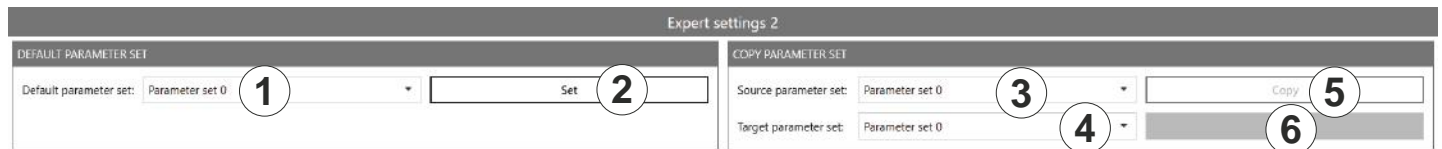

Fig. 51: Expert settings 2: default parameter set and copy parameter set

①	Default Parameter Set	selects a default parameter set
②	Set	sets the selected default parameter set in the reader

14.8.2 Copy Parameter Set

The *Copy parameter set* allows one parameter set to be copied into another.

③	Source parameter set	selects the parameter set to be copied
④	Target parameter set	selects the parameter set into which the source parameter set is to be copied
⑤	Copy	copies the parameter set ► Click <i>Copy</i> . ⇒ On successful completion of the copy operation, the <i>Copy</i> button briefly glows green and a corresponding message is displayed in the status field. ⇒ If there is an error, the <i>Copy</i> button glows red, an error pop-up message appears and a warning is shown in the status field.
⑥		shows the progress of the copying process

14.8.3 Change Reader Parameter

Change reader parameter allows to change all reader settings using their respective configuration IDs.

Fig. 52: Expert settings 2: change reader parameter

①	Parameter ID	selects the parameter ID
②	Parameter value	shows or sets the parameter value The value is either decimal or hexadecimal, it is possible to switch between <i>dec</i> and <i>hex</i> .
③	Active parameter set	shows the current active parameter set
④	Get	reads the value of the current parameter set of the reader and shows it at ②
⑤	Set	writes the parameter value (②) into the selected parameter ID (①)

14.8.4 Select Filter Settings

By means of these settings, it is possible to filter certain tags, e.g. to only read tags with the defined data in the respective memory banks. It is possible to set up to 32 filters.

Fig. 53: Expert settings 2: select filter settings

①	Filter	selects a filter
②	Target	selects the tag target session ► Make sure the target matches the session set in ⑱ Fig. 50, p. 88.
③	Action	selects the action; see also <i>EPCglobal Gen 2 Specification</i> (p. 73) <div style="border: 1px solid gray; padding: 5px;"> <p>Tip ► To see the description of an action, hover over the Action field. ⇒ The description of the action appears in the tooltip:</p> <div style="border: 1px solid gray; padding: 5px; margin: 5px 0;"> <p>Action: 100 Memory bank: EPC Matching: deassert SL or inventoried -> B Non-Matching: assert SL or inventoried -> A</p> </div> </div>
④	Memory bank	selects the memory bank (<i>RFU/EPC/TID/User</i>)
⑤	Save select filter data to file	saves the select filter data to file
⑥	Load select filter data to file	loads the select filter data from file
⑦	On	activates or deactivates the select filter
⑧	Bit pointer	sets from which memory address the filter compares the mask data
⑨	Mask length	sets the mask length (0–255)

⑩	Mask data	sets the data to be filtered
⑪	Get	reads the data of the filter selected at ⑩
⑫	Set	sets the select filter

Tip In Generation 3 readers, select filter data are permanently stored in the reader, e.g. if the select filter has been activated, it is active after a reader restart.

14.8.5 Applying a Select Filter (Example)

You have the following results of the basic reading but you would like only the tags with the *FC28* in the memory address to take part in the inventory:

Fig. 54: Basic reading: select filter required

To do so, it is necessary to create a select filter. The advantage of this process is that the filtering takes place already at the air interface level.

To create the select filter as shown in the figure below:

1. Select the filter you would like to save the filtering settings to under **Filter** (①).
2. Select the target (②). Make sure the target matches the session set in ⑩ Fig. 50, p. 88.
3. Select an action (③). In the example, the action is set to **100**; see also *EPCglobal Gen 2 Specification*.
4. Select the **EPC** memory bank (④).
5. Activate the select filter (⑤).
6. Refer to the *EPCglobal Gen 2 Specification* to check from which bit pointer the filter will search for the value according to which you would like to filter the tags (*FC28* in the example); see pp. 44–46 in the *EPCglobal Gen 2 Specification V 2.0.1*. In the example, *FC28* is the third word in the EPC memory bank (bit pointer 0x00 is the CRC, bit pointer 0x10 is the PC, bit pointer 0x20 is the first EPC word). Therefore, *FC28* corresponds to the bit pointer 0x40.
7. Enter **40** at **Bit pointer** (⑥).
8. Enter the mask length at ⑦. In the example, *FC28* is one word, therefore, the value is **16**.
9. Enter the value (*FC28*) at ⑧.
10. Click **Set** (⑨).
11. Go to *Expert settings 1*.
12. In Selection Parameters, set the value at target to **B**; see also *EPCglobal Gen 2 Specification*.
13. Start the reading in the *Basic reading* tab:

Basic reading												
	EPC LENGTH	EPC	PORT	RSSI	RSSI DBM	READS	CYCLES	FIRST READ	LAST READ	FREQUENCY	TAG PHASE	MODE
CO	96	3034 F792 FC28 1800 001B CE7C	2	104	-64.7	309	3421	09:27:16:257	14:27:56:386	865.700 MHz	←	<input checked="" type="radio"/> Synchronous <input type="radio"/> Asynchronous <input type="checkbox"/> Listen for event <input type="button" value="Start"/> <input type="button" value="Stop"/>
AP	96	3034 F792 FC28 1800 001B CE7A	2	95	-71.3	311	3421	09:27:16:258	14:27:56:386	865.700 MHz	↙	
BR	96	3034 F792 FC28 1800 001B CE7E	2	87	-77.3	311	3421	09:27:16:258	14:27:56:386	865.700 MHz	→	
LE	96	3034 F792 FC1A 31C0 0000 047F	2	105	-63.7	117	3421	09:27:16:258	10:27:20:292	866.900 MHz	←	
RL	96	3034 F792 FC28 1800 001B CE73	2	87	-77.3	311	3421	09:27:16:258	14:27:56:386	865.700 MHz	↙	

⇒ The reader only reads the tags with the filtered value (marked green). The tag without the filtered value is not read (marked red).

14.9 Test Gen 2 Functions

This tab makes it possible to access individual tag functions. In addition to the functionality in accordance with the EPC Gen2 standard, it is possible, for example, to read and write tags as well as set and change tag passwords.

The user interface consists of the fields *Get all Tags*, *Password for Operation*, *Write EPC*, *Read data*, *Write data*, *Change Password*, *Lock* and *Kill* that are described in the following chapters.

Fig. 55: Test Gen2 functions

14.9.1 Get All Tags

Fig. 56: Test Gen2 functions: Get all EPCs

①	Refresh	updates the tags read in the field ► For EPC-specific operations, click on a tag to select it from the list.
---	----------------	---

<p>② Info</p>	<p>shows the information about the tag manufacturer and the chip type</p> <p>► Click on the information symbol.</p> <p>⇒ The information about the tag is shown:</p> <pre> 3034 F792 FC1A 31C0 0000 047F Manufacturer: Impinj Type: Monza R6 3034 F792 FC28 1B00 001B CE7A Manufacturer: NXP Type: UCODE 7 SL3S1204 3034 F792 FC28 1B00 001B CE7C </pre>
---------------	--

14.9.2 Password for Operation

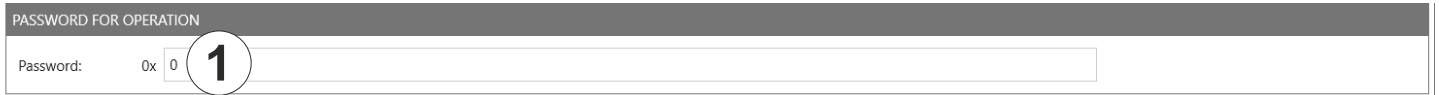

Fig. 57: TestGen2: password for operation

<p>① <i>Password</i></p>	<p>sets the password for the tag operation in the hexadecimal format</p>
--------------------------	--

14.9.3 Write EPC

In this tab, it is possible to change the EPC of the tag.

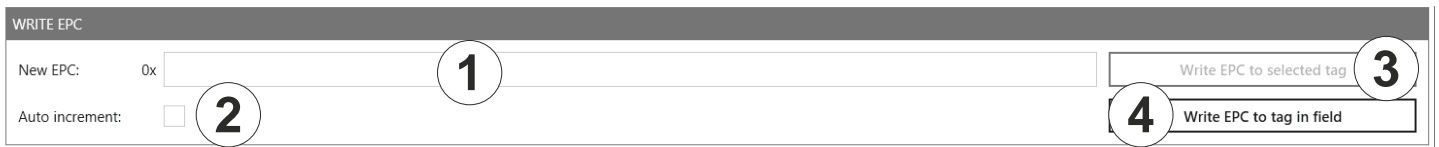



Fig. 58: TestGen2: write EPC

<p>① <i>New EPC</i></p>	<p>enters an EPC in the hexadecimal format</p> <div style="border: 1px solid gray; padding: 10px; background-color: #f0f0f0;"> <p>! Make sure to comply with the maximum EPC length supported by the tag. If the maximum length is exceeded, the tag will return an error.</p> </div>
<p>② <i>Auto increment</i></p>	<p>activates or deactivates increasing the EPC by one with each successful writing process</p>
<p>③ <i>Write EPC to selected tag</i></p>	<p>writes the EPC on the selected tag</p>
<p>④ <i>Write EPC to tag in field</i></p>	<p>writes the EPC entered in 1 to a single tag</p> <p>► When using this command, make sure there is only one tag in the field. Otherwise, an error message is displayed in the status field.</p>

14.9.4 Read Data

This group supplies detailed access to all the data areas of the tag. Access is obtained by entering the selected memory bank, the address within the memory bank and the number of words.

Fig. 59: TestGen2: read data

①	Memory bank	enters the selected memory bank
②	Memory address	enters the address within the memory bank
③	Word count	enters the number of words to read
④	Data (UTF8)	shows the data in the UTF8 format
⑤	Data (ISO 17367)	shows the data in the ISO 17367 format
⑥	Read data of selected tag	reads data from the selected tag
⑦	Read complete memory bank of selected tag	reads the complete memory bank of the selected tag; up to 255 words
⑧	Read data of all tags	reads data from all tags in the field <div style="border: 1px solid black; padding: 10px; margin-top: 10px;">  <p>If the tags in the field have different passwords and are configured differently, it is necessary to read the data from each tag individually.</p> </div>
⑨	Read complete memory bank of all tags	reads the complete memory bank of all tags in the field; up to 255 words

14.9.5 Write Data

Fig. 60: TestGen2: write data

①	Memory bank	enters the selected memory bank
②	Memory address	enters the address within the memory bank
③	Data	enters data to write in the hexadecimal format
④	Data (UTF8)	enters data to write in the UTF8 format
⑤	Data mask	enters the data mask The data mask allows only individual bits on the tag to be changed.
⑥	Write data to selected tag	writes data to the selected tag in the field
⑦	Write masked data to selected tag	writes the masked data to the selected tag
⑧	Write data to all tags	write data to all tags in the field <div style="border: 1px solid gray; padding: 5px; margin-top: 10px;"> ► If the data are written to all tags in the field, make sure all the tags have the same configuration (lock and password).</div>
⑨	Write masked data to all tags	writes the masked data to the all tags in the field

14.9.6 Change Password

To change the password, enter the current password at ① in Fig. 57, p. 92. If no password has yet been set, the default value is 0.

Fig. 61: TestGen2: change password

①	<i>New password</i>	sets the new password in the hexadecimal format for the selected tag
②	<i>New kill password</i>	sets the new password to deactivate the selected tag
③	<i>Set password on selected tag</i>	replaces the old password by the new password for the selected tag
④	<i>Set kill password on selected tag</i>	replaces the old deactivation password by the new deactivation password for the selected tag

14.9.7 Lock

The *EPC Gen2* standard provides security mechanisms for the tag data areas. This allows individual memory areas and functionalities of the tags to be provided with a password to protect it against access and/or changes.

Under *Lock*, it is possible to lock the memory banks.

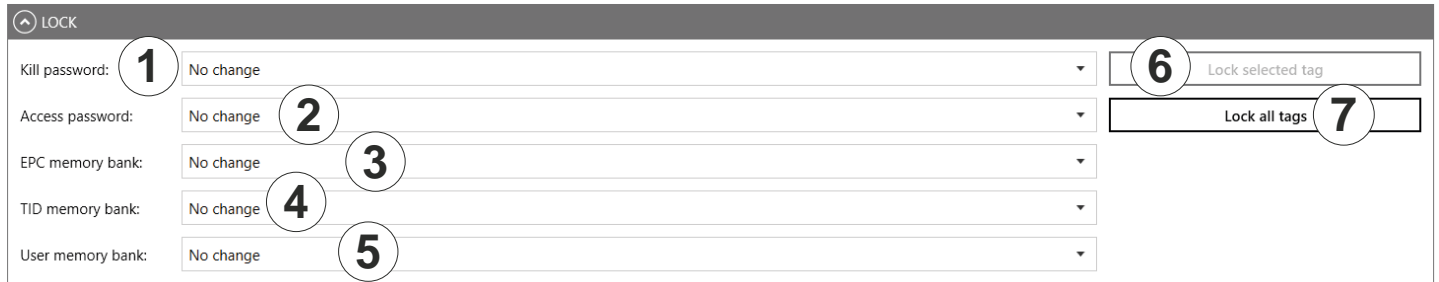



Fig. 62: TestGen2: Lock

①	Kill password	<p>specifies how the kill password is accessible</p> <ul style="list-style-type: none"> ▶ Select one of the following options from the drop-down menu: <table border="1" data-bbox="327 801 1527 1146"> <tr> <td><i>No change</i></td> <td>the current setting for the kill password remains unchanged</td> </tr> <tr> <td><i>Accessible</i></td> <td>the kill password is readable and writeable from either the open or secured state</td> </tr> <tr> <td><i>Accessible with permalock</i></td> <td>the kill password is permanently readable and writeable from either the open or secured states and may never be locked</td> </tr> <tr> <td><i>Accessible with password</i></td> <td>the kill password is readable and writeable from the secured state but not from the open state</td> </tr> <tr> <td><i>Not accessible with permalock</i></td> <td>the kill password is not readable or writeable from any state</td> </tr> </table> <ul style="list-style-type: none"> ▶ For more details, see <i>EPCGlobal Gen2 Specification</i>. 	<i>No change</i>	the current setting for the kill password remains unchanged	<i>Accessible</i>	the kill password is readable and writeable from either the open or secured state	<i>Accessible with permalock</i>	the kill password is permanently readable and writeable from either the open or secured states and may never be locked	<i>Accessible with password</i>	the kill password is readable and writeable from the secured state but not from the open state	<i>Not accessible with permalock</i>	the kill password is not readable or writeable from any state
<i>No change</i>	the current setting for the kill password remains unchanged											
<i>Accessible</i>	the kill password is readable and writeable from either the open or secured state											
<i>Accessible with permalock</i>	the kill password is permanently readable and writeable from either the open or secured states and may never be locked											
<i>Accessible with password</i>	the kill password is readable and writeable from the secured state but not from the open state											
<i>Not accessible with permalock</i>	the kill password is not readable or writeable from any state											
②	Access password	<p>specifies how the access password is accessible</p> <ul style="list-style-type: none"> ▶ Select an option from the drop-down menu; see the options at ①. ▶ For more details, see <i>EPCGlobal Gen2 Specification</i>. 										
③	EPC memory bank	<p>specifies how the EPC memory bank is accessible</p> <ul style="list-style-type: none"> ▶ Select one of the following options from the drop-down menu: <table border="1" data-bbox="327 1440 1527 1742"> <tr> <td><i>No change</i></td> <td>the EPC memory remains unchanged</td> </tr> <tr> <td><i>Writeable</i></td> <td>the EPC memory bank is writeable from either the open or secured states</td> </tr> <tr> <td><i>Writeable with permalock</i></td> <td>the EPC memory bank is writeable from either the open or secured states and may never be locked</td> </tr> <tr> <td><i>Writeable with password</i></td> <td>the EPC memory bank is writeable from the secured state but not from the open state</td> </tr> <tr> <td><i>Not writable with permalock</i></td> <td>the EPC memory bank is not writeable from any state</td> </tr> </table>	<i>No change</i>	the EPC memory remains unchanged	<i>Writeable</i>	the EPC memory bank is writeable from either the open or secured states	<i>Writeable with permalock</i>	the EPC memory bank is writeable from either the open or secured states and may never be locked	<i>Writeable with password</i>	the EPC memory bank is writeable from the secured state but not from the open state	<i>Not writable with permalock</i>	the EPC memory bank is not writeable from any state
<i>No change</i>	the EPC memory remains unchanged											
<i>Writeable</i>	the EPC memory bank is writeable from either the open or secured states											
<i>Writeable with permalock</i>	the EPC memory bank is writeable from either the open or secured states and may never be locked											
<i>Writeable with password</i>	the EPC memory bank is writeable from the secured state but not from the open state											
<i>Not writable with permalock</i>	the EPC memory bank is not writeable from any state											
④	TID memory bank	<p>specifies how the TID memory bank is accessible</p> <ul style="list-style-type: none"> ▶ Select an option from the drop-down menu; see the options at ③. 										
⑤	User memory bank	<p>specifies how the User memory bank is accessible</p> <ul style="list-style-type: none"> ▶ Select an option from the drop-down menu; see the options at ③. 										
⑥	Lock selected tag	locks the selected tag with the settings from ①–⑤										

⑦	Lock all tags	locks all the tags with the settings from ①–⑤ <div style="border: 1px solid black; padding: 10px; background-color: #f0f0f0;">  ► To lock all the tags, make sure that all the tags have the same password. </div>
---	----------------------	--

14.9.8 Kill

 ► To deactivate a tag, set a deactivation password that is not 0; see ② in *Fig. 61, p. 95*.
 After a kill command, the tag will be unusable!



Fig. 63: TestGen2: kill

①	Kill selected tag	executes a kill command on the selected tag
②	Kill all tags	executes a kill command on all tags in the field

14.10 @KRAI

This tab allows changing KRAI-specific settings. The *@KRAI* tab is divided into several sections. *Port* and *Port Info* are always available, other sections depend on the antenna connected to the reader, e.g. *Polarisation*, *Direction* etc.

The Reader recognises the connected antennas at boot up, but it is also possible to manually recognise a single port or all ports under *Port*. *Port Info* displays the information about the antenna.

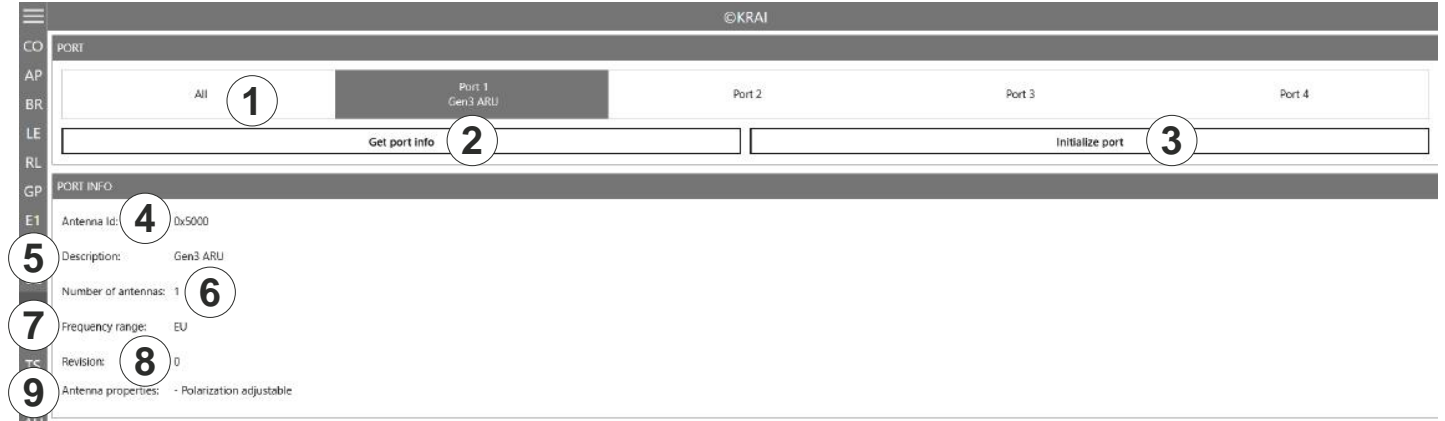

Fig. 64: @KRAI: polarisation

①	All/Port 1-4	selects either one or all antennas for Initialize port (③)
②	Get port info	retrieves port information for a selected @KRAI antenna
③	Initialize port	runs a query of the antennas on this port/these ports
④	Antenna Id	shows the antenna ID
⑤	Description	shows the description of the antenna
⑥	Number of antennas	shows the number of the antennas connected to the port
⑦	Frequency range	shows the frequency range the antenna operates in (<i>Global/EU/FCC</i>)
⑧	Revision	shows the hardware version of the antenna
⑨	Antenna properties	shows antenna properties, e.g. <i>polarisation adjustable</i> , <i>LEDs available</i>

Different configuration options are displayed, depending on the types of the connected antennas. The category *Polarisation* is shown for antennas with polarisation switching, the *Jumper Cable Attenuation* is available for smart shelf antennas, e.g. SMSH-30-30KRAI, *LED* is shown for @KRAI WIRA 70 and *Direction* for CSB KRAI antennas, e.g. WiRa 30°.

14.10.1 Polarisation

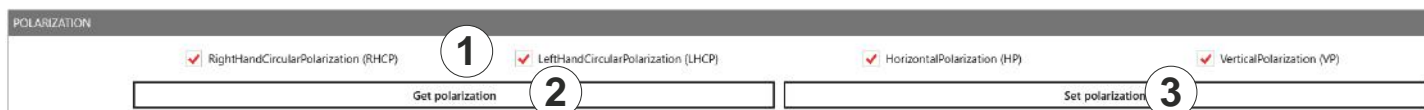

Fig. 65: @KRAI: polarisation

①		sets the polarisation of the antenna If there are several types of polarisation selected at the same time, the antenna configuration changes after every inventory.
②	<i>Get polarization</i>	reads the current polarisation information of the antenna
③	<i>Set polarization</i>	sets the polarisation on the antenna

14.10.2 LED

Depending on the features that are integrated in the antennas, it is possible to control/configure the LEDs.

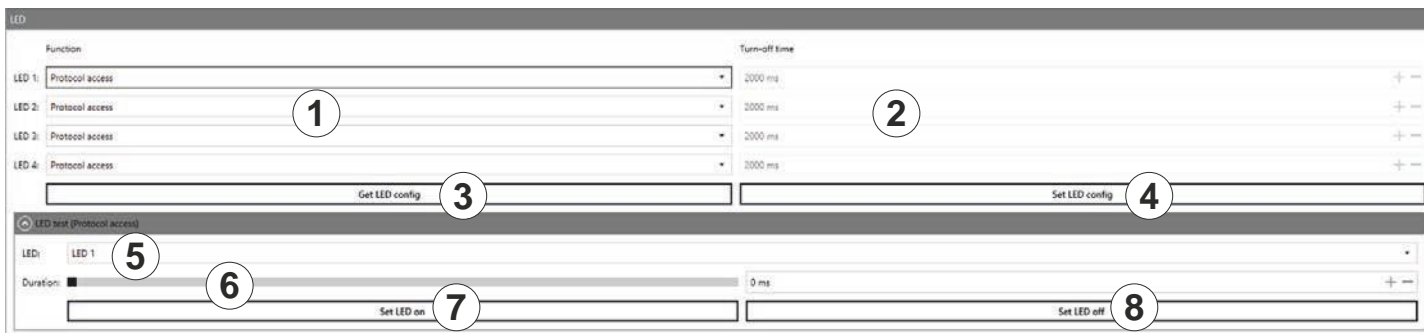

Fig. 66: @KRAI: LED

①	<i>LED 1-4</i>	selects the function of the LED 1-4 ► For functions, see Chapter <i>Selecting Functions</i> , p. 79
②	<i>Turn-off time</i>	sets the turn-off time for LED
③	<i>Get LED config</i>	shows the current LED configuration
④	<i>Set LED config</i>	sets the new LED configuration
⑤	<i>LED</i>	selects between LED 1-4
⑥	<i>Duration</i>	sets the duration of how long the LED is on; only if protocol access is selected in ①
⑦	<i>Set LED on</i>	switches the LED on for the duration in milliseconds selected in ⑥; if the duration is set to 65535 ms, the LED is permanently on
⑧	<i>Set LED off</i>	switches off the selected LED

14.10.3 Jumper Cable Attenuation



Fig. 67: @KRAI: jumper cable attenuation

①	Get jumper cable attenuation	reads the current jumper cable attenuation
②	Set jumper cable attenuation	sets the jumper cable attenuation

! For cascading smart shelf antennas, it is necessary to use cables with the same attenuation (cable length). Otherwise, the TX power of the antennas that is derived from the jumper cable attenuation is not calculated correctly.

14.10.4 Direction



Fig. 68: @KRAI: direction

①	Left/Centre/Right	sets the direction of the antenna If there are several types of direction selected at the same time, the antenna configuration changes after every inventory.
②	Get direction	reads the antenna direction(s) currently set in the antenna
③	Set direction	sets the selected direction(s) in the antenna

14.11 AppManager



This chapter gives a short overview of the apps, the requirements to operate them and the installation instructions.

► For more information on how to operate an app, refer to the user guide for the corresponding app.

14.11.1 Currently Available Apps

AccessManager

Automated vehicle identification (AVI) is one of the key markets that Kathrein Solutions is focusing on. AVI includes free flow identification, plaza and parking applications. For parking applications, Kathrein provides a specially configured software for access control called *AccessManager*.

The RRU 4xxx and ARU 3xxx series readers have a built-in industrial controller with Linux operating system. The entire application can be installed and configured directly on the reader. The system can be operated as an isolated solution without a network connection or alternatively via remote access over the network for configuration purposes or for database adaptations.

The *AccessManager* application software allows user-guided input and configuration of the transponder data that is to be captured. No programming knowledge is required in this case.

Flexible and efficient detection (e.g. of vehicles) is assured on the basis of the four digital inputs provided in Kathrein RFID systems which can be used for activation. A start point can be defined for the application in this way, whereby a light barrier or inductive ground contact is queried in order to activate the reading process.

Skidata

The Skidata app is a software-based solution that provides simple and easy interface integration of Kathrein RFID readers with Ethernet in the latest generation of Skidata barrier systems. With the Skidata app, the reader will become an officially certified SKIDATA compatible product.

Low Level Reader Protocol

Kathrein RFID readers are available with an optional LLRP (Low Level Reader Protocol) stack installable as an LLRP app. All readers with an integrated embedded Linux OS can be controlled via LLRP 1.0.1 port 5084 for easier integration. To specify air interface commands between readers and clients, LLRP is a ratified standard protocol from EPCglobal.

Profinet IO

The Profinet IO app allows the integration of a reader into a Profinet IO environment; the reader acts as an IO device. To run the app, a valid licence key is needed. Licence keys (either a full licence or a time limited demo licence) are bound to the specific reader the app is running on. For obtaining a licence key, the hardware key provided by the app is needed.

TagBlower

The TagBlower app can read tags asynchronously and generate messages, when a tag is coming or going. The app provides a server on a configurable port, where TCP clients can connect to receive those messages. The message format can be specified by the user by setting a coming and/or going datagram. A datagram consists of normal text and keywords.

14.11.2 Installing an App



This chapter describes installing an app shown on the example of *AccessManager*. You can install all other apps following the instructions described below.

- ✓ The *ReaderStart* software is installed.
- ✓ The reader is connected to a PC.

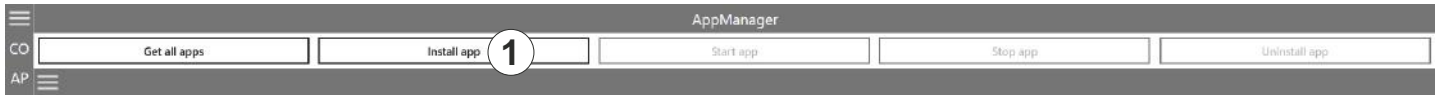
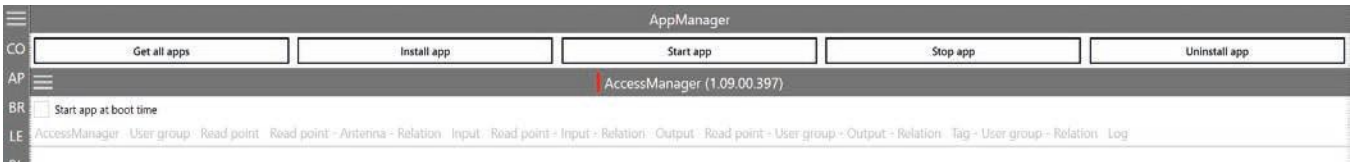

Fig. 69: AppManager: installing an app

1. Go to <https://www.kathrein-solutions.com/products/software/interface-software/accessmanager>.
 2. Download the app.
 3. If the downloaded app is in the zip format, extract a .tar file. Make sure not to extract the .tar file!
 4. Start the *ReaderStart* software.
 5. Go to the **AppManager** tab.
 6. Click on **Install app** (①).
 - ⇒ A pop-up window to select the file with the app opens.
 7. Select the file with the app. Make sure it is the .tar file.
 8. Click Open.
 - ⇒ A pop-up message with the progress bar for the installation process appears for the duration of the installation .
- After the app has been successfully installed, the corresponding message is displayed in the status field and the app interface is shown in the **AppManager** tab:



Tip

- To see all the installed apps, click the menu symbol at (①).
 - ⇒ The installed apps are displayed:



14.12 TagScan

To represent the relationship between the tag phase and the RSSI value, it is possible to plot both values by means of the TagScan.

✓ There is only one tag in the field or a tag has been selected.

► Click **Start** to activate the TagScan.

⇒ The phase shifts are seen in the frequency switching. The RSSI value does not change because the transponder (tag) is not moved.

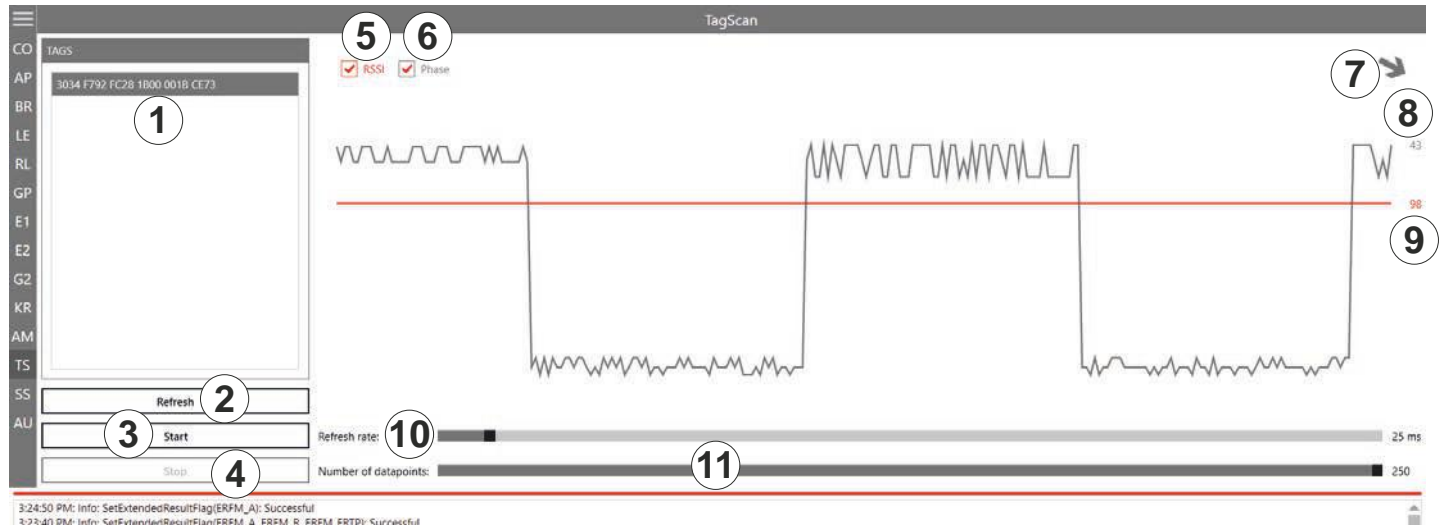

Fig. 70: TagScan: phase shift (due to the channel change), transponder is not moved

①	Tags	shows the number of the tags present in the antenna field
②	Refresh	scans tags in the antenna field anew
③	Start	starts TagScan
④	Stop	stops TagScan
⑤	RSSI	activates/deactivates the presentation of the RSSI value in the graph
⑥	Phase	activates/deactivates the presentation of the phase in the graph
⑦		shows the phase in form of the rotating arrow
⑧		shows the current value of the phase
⑨		shows the current RSSI value
⑩	Refresh rate	sets the interval between the commands
⑪	Number of data points	sets the number of data points in the graph

Tip

► To eliminate the phase shifts, select only one transmission frequency under **Expert settings 1**; see *Expert Settings 1*, p. 85.

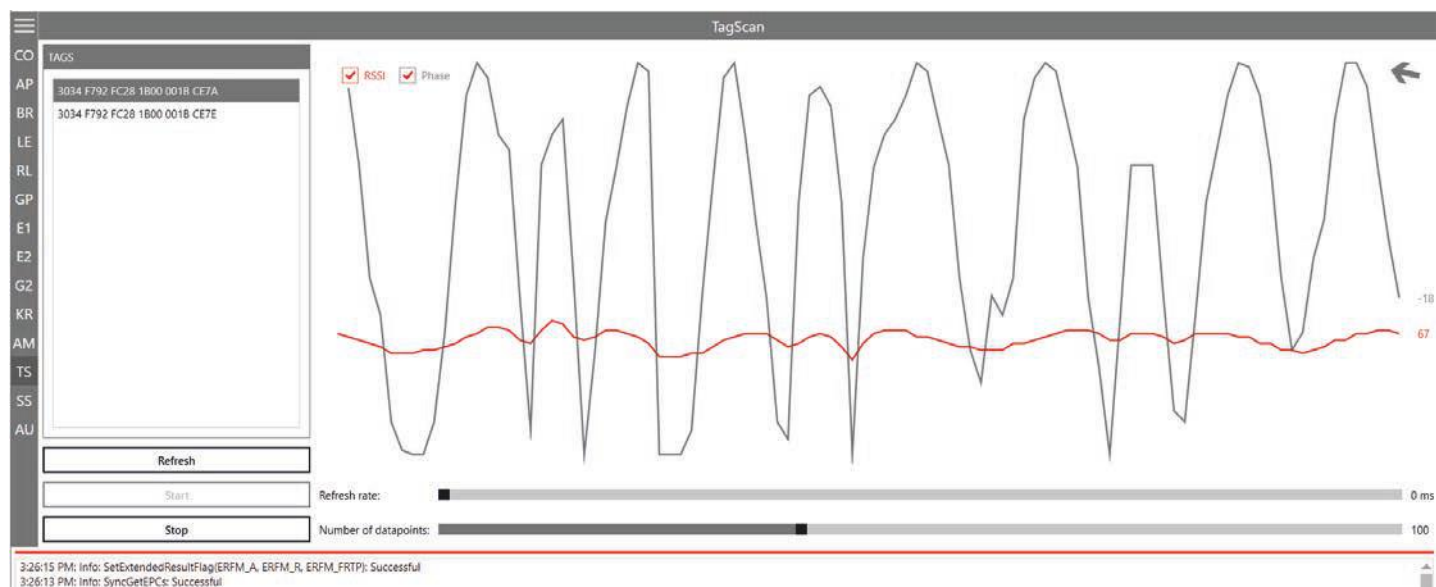

Fig. 71: TagScan: phase shift, transponder is moved

Transponder movement is indicated by the amplitude of the phase. The RSSI value changes in small steps. The direction of the movement is indicated by means of the rotating pointer.

14.13 Spectral Scan

It may happen that the RFID transmission to or from the transponder is disturbed by frequency interfering. *SpectralScan* shows a qualitative frequency spectrum. Due to the fact that it is received by means of the connected RFID antenna, the frequency assignment on location is made visible.

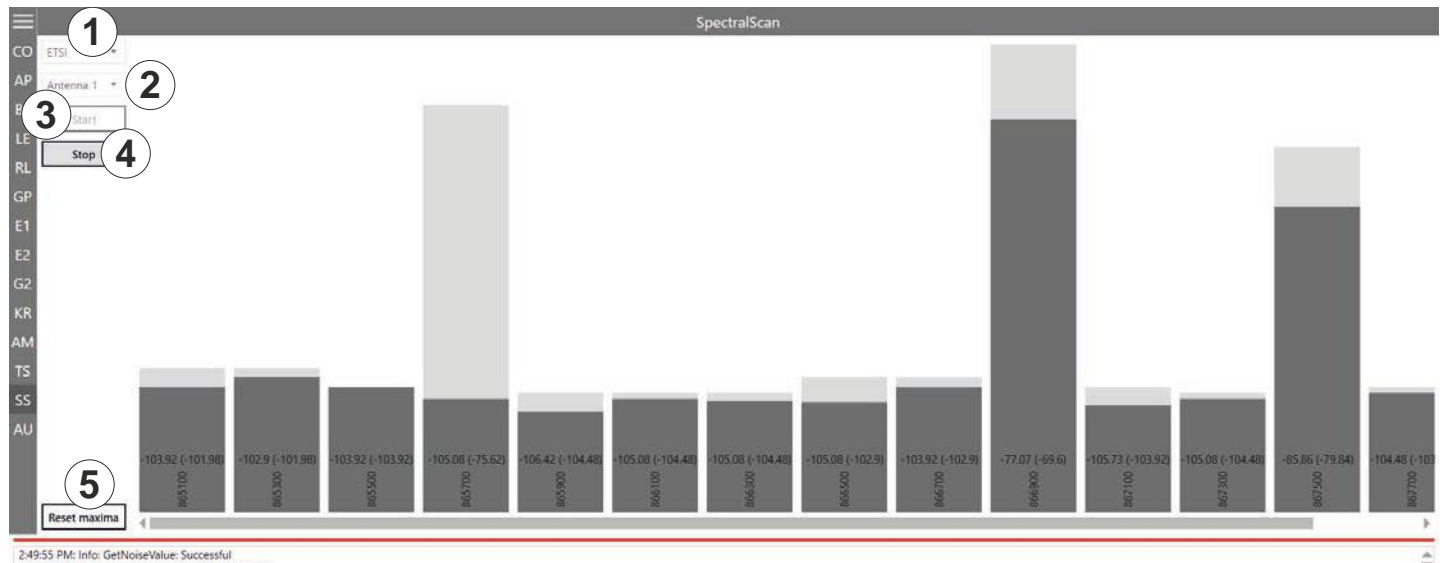

Fig. 72: SpectralScan

①	<i>ETSI</i>	selects the frequency area
②	<i>Antenna 1-n</i>	selects an antenna from the drop-down menu
③	<i>Start</i>	starts SpectralScan
④	<i>Stop</i>	stops SpectralScan
⑤	<i>Reset maxima</i>	resets maxima

If there is more than one reader, spectral scan shows which channels might be occupied by other readers. In Fig. 71, p. 104, the channels 4, 10 and 13 are occupied by other readers. If the user is not satisfied with the reading results and the interferences keep occurring, it is possible to deactivate channels on which the interference occurs (4, 10 and 13) and only activate the channel that is free (7) to achieve better reading results, see ⑩ in Fig. 49, p. 85.

14.14 Authentication

Using this function, it is possible to authenticate a tag.

The Authentication tab consists of 4 areas, *Get All Tags*, *Tags*, *Key* and functions that are described below.

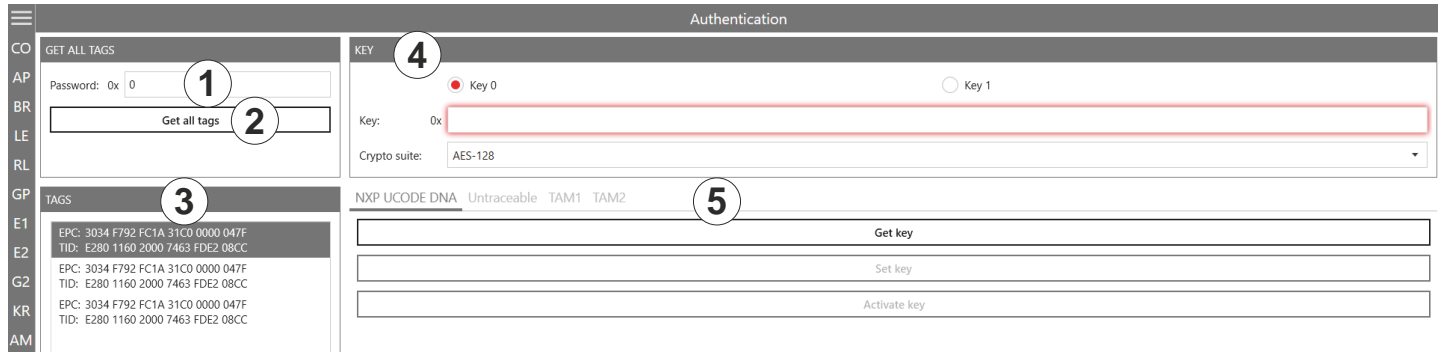

Fig. 73: Authentication

①	Password	enters the access password; see <i>Password for Operation</i> , p. 92
②	Get all tags	reads all the tags in the antenna field
③	Tags	shows all the detected tags
④	Key	see <i>Key</i> , p. 106; necessary for <i>TAM1</i> and <i>TAM2</i>
⑤	Functions	see <i>Functions</i> , p. 107

14.14.1 Key

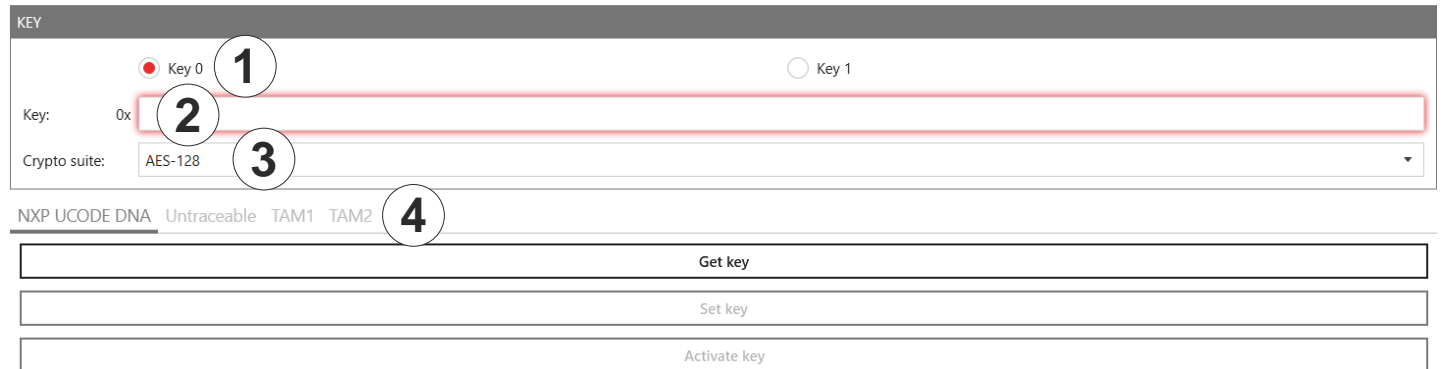

Fig. 74: Authentication: Key

①	Key 0/Key 1	selects a key for the authentication (<i>Key 0</i> is only used for <i>TAM1</i> , <i>Key 1</i> is used for both <i>TAM1</i> and <i>TAM2</i>)
②	Key	enters the key selected in ①
③	Crypto suite	selects the crypto suite
④		see <i>Functions</i> , p. 107

14.14.2 Functions

NXP UCODE DNA

KEY

Key 0
 Key 1

Key: 0x

Crypto suite: AES-128

NXP UCODE DNA
Untraceable TAM1 TAM2

Get key **1**

2 Set key

Activate key **3**

Fig. 75: Authentication: NXP UCODE DNA

1	Get key	reads key 0 or key 1 currently set in the selected tag; only if the key has not been activated
2	Set key	sets key 0 or key 1 on the selected tag
3	Activate key	activates key 0 or key 1 on the selected tag

Untraceable

NXP UCODE DNA
Untraceable TAM1 TAM2

U: **1** Deassert "U" in XPC_W1

EPC: **2** Show memory above EPC

New EPC length: 0 Word **3** + -

TID: **4** Show

User: **5** Show

Range: Normal **6**

Set Untraceable on selected tag **7**

Fig. 76: Authentication: untraceable

1	U:	asserts or deasserts U in XPC_W1; see <i>EPCglobal Gen2 Specification, p. 106</i>
2	EPC	shows or hides memory above the visible EPC
3	New EPC length	sets new EPC length in words
4	TID	<i>Show</i> shows the complete TID
		<i>Truncated</i> shows the first two words in case of E2 and only one word in case of E1
		<i>Hide</i> hides the complete TID
5	User	shows or hides the user memory bank

⑥	Range	selects a range
		<i>Normal</i> the tag operates in the normal range
		<i>Toggle temporarily</i> The tag temporarily toggles between normal and reduced operating range but reverts to its prior persisting operating range when the tag loses power
		<i>Reduced</i> the tag operates in the reduced operating range
⑦	Set Untraceable on selected tag	sets settings 1–6 on the selected tag

TAM1

TAM1 is used to check whether the selected tag is authentic.

✓ The tag has at least one activated key, *Key 0* or *Key 1*.

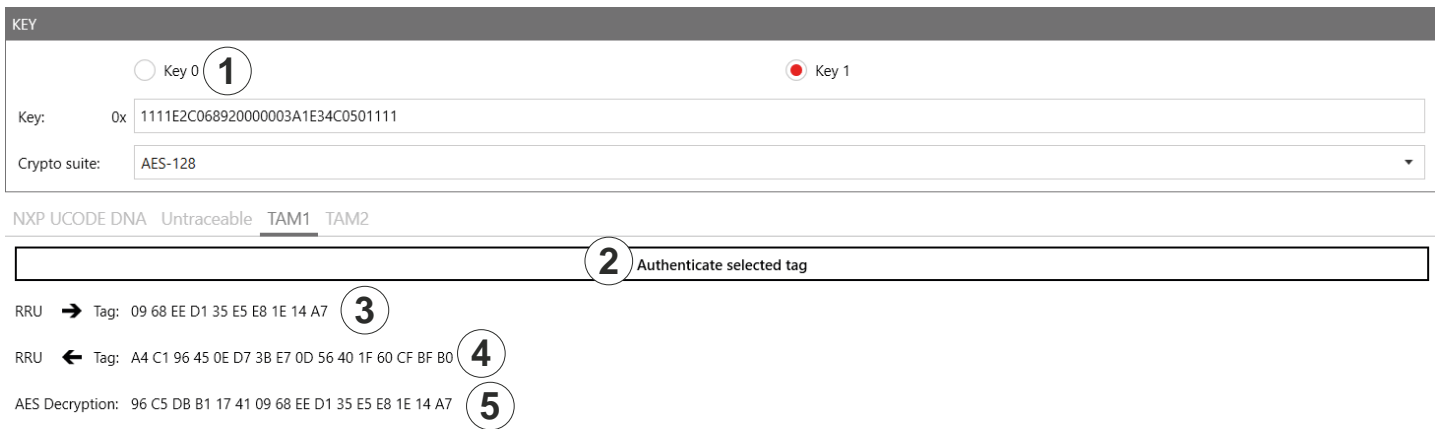

Fig. 77: Authentication: key (TAM1)

	Key	see <i>Key</i> , p. 106
①	Authenticate selected tag	the reader sends the authenticate command to the selected tag; a pop-up message appears whether the authentication was successful or failed.
②	RRU → Tag	shows the random number sent to the tag by the reader
③	RRU ← Tag	shows the encrypted random number sent to the reader from the tag
④	AES Decryption	shows the data decrypted from ③ by means of the key entered at ② in <i>Authentication: Key</i> , p. 106; in the example above, this data contains the random number shown in ②

TAM2

TAM2 is used to read the data of the selected tag.

✓ *Key 1* has been activated.

KEY

Key 0 Key 1

Key: 0x 1111E2C068920000003A1E34C0501111

Crypto suite: AES-128

NXP UCODE DNA Untraceable TAM1 TAM2

Profile: ① EPC

Offset: ② 0 Bit + -

Fig. 78: Authentication: key (TAM2)

①	Profile	selects a profile the data of which is shown
②	Offset	sets the offset for ⑤
③	Block count	sets how many bits rare to be read
④	Protection mode	selects the protection mode for the TAM2 authentication operation
⑤	Read data of selected tag	reads the data of the selected tag provided the correct key 1 has been entered at <i>Key</i>
⑥	Data	shows data read in ⑤

15 Contact Information

Kathrein Solutions GmbH

Kronstaudener Weg 1

83071 Stephanskirchen

Phone [+49 \(0\) 8036 / 90 831 20](tel:+49(0)80369083120)

Fax [+49 \(0\) 8036 / 90 831 69](tel:+49(0)80369083169)

Email: iot-info@kathrein-solutions.com

16 Waste Disposal



Electronic equipment is not domestic waste – in accordance with directive 2002/96/EC OF THE EUROPEAN PARLIAMENT AND THE COUNCIL dated 27th January 2003 concerning used electrical and electronic appliances, it must be disposed of properly. At the end of its service life, take this unit for disposal at a designated public collection point.



Electronic equipment is not domestic waste – in accordance with directive 2002/96/EC OF THE EUROPEAN PARLIAMENT AND THE COUNCIL dated 27th January 2003 concerning used electrical and electronic appliances, it must be disposed of properly. At the end of its service life, take this unit for disposal at a designated public collection point.