

# SEARS

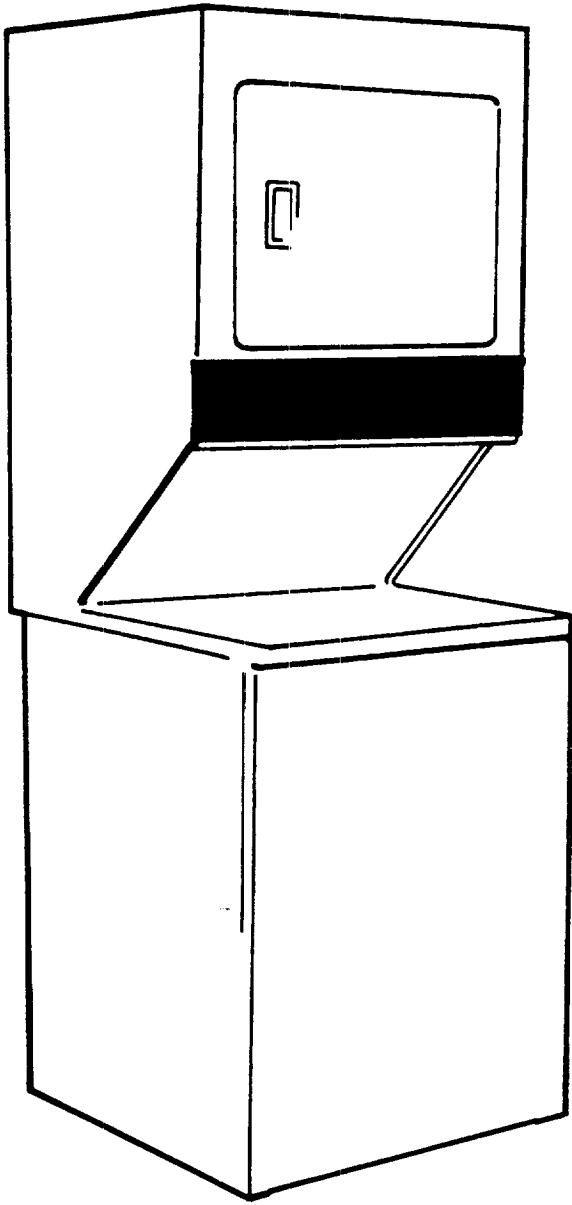

## Installation instructions

**Laundry  
Center**

**washer/dryer gas**

**Kenmore**

**SAVE THESE INSTRUCTIONS**

P/N 131531800 (9511)

## Before you begin . . .

Please read these instructions all the way through.

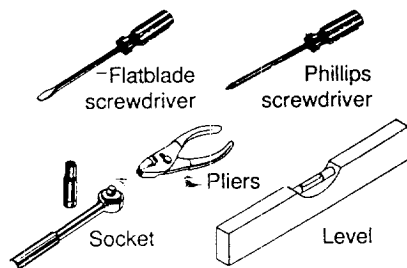

**A.** You need these tools to install your Kenmore Laundry Center. Get them together in one place to keep track of them.

**B.** Check the spot where you are going to install the Laundry Center. Proper installation is your responsibility. Make sure you have everything necessary for proper installation.

You will need to meet **State code/law requirements:** Some Codes keep from or limit installation of clothes dryers in residential garages, closets, mobile homes and sleeping quarters. (Check with your local building inspector and ANSI Z 223.1—1988 National Fuel Gas Code.) For mobile homes, installation must conform to the Manufactured Home Construction and Safety Standard, Title 24 CFR, Part 32-80 (formerly the Federal Standard for Mobile Home Construction and Safety, Title 24, HUD [Part 280], 1975).

**Important: Observe all governing codes and ordinances.**

**ATTENTION SERVICERS:** Wiring diagram is located behind the dryer access panel.

## Recommended location

**Size:** Must be large enough to fully open dryer door. For recessed or closet installations see Page 6 for spacing; for product dimensions see the last page of these instructions.

**Support:** The floor must be able to support the appliance loaded weight of 500 pounds.

**Level Floor:** Maximum floor slope under Laundry Center is 1 inch.

**Protection from the weather:** Do not install or store appliance where weather or dripping water will come in contact with the appliance. Proper operation of dryer cycles requires temperatures above 45°F. As some water remains in the washer, do not store or operate the washer below 32°F. For storage below 32°F. see Use and Care Guide for "Winterizing."

**Mobile Home Use:** The gas appliance must be securely fastened to the floor. Sears Kit No. 346764 is available at your local Sears store or Sears Service Center.

**⚠ WARNING** For your safety, the information in this manual must be followed to minimize the risk of fire or explosion or to prevent property damage, personal injury or loss of life.

- Do not store or use gasoline or other flammable vapors and liquids in the vicinity of this or any other appliance.

### • WHAT TO DO IF YOU SMELL GAS

- Do not try to light any appliance.
  - Do not touch any electrical switch; do not use any phone in your building.
  - Clear the room, building or area of all occupants.
  - Immediately call your gas supplier from a neighbor's phone. Follow the gas supplier's instructions.
  - If you cannot reach your gas supplier, call the fire department.
- Installation and service must be performed by a qualified installer, service agency or the gas supplier.

- **Never** install the Laundry Center up against draperies or curtains and be sure to keep any and all items from falling or collecting behind the Laundry Center.
- Replace all access or service panels before operating Laundry Center.

## Electrical requirements

**Electrical ground is required on this appliance.**

### Recommended grounding instructions

This appliance must be grounded. In the event of malfunction or breakdown, grounding will reduce the risk of electric shock by providing a path of least resistance for electric current. This appliance is equipped with a cord having an equipment-grounding conductor and a grounding plug. The plug must be plugged into an appropriate outlet that is properly installed and grounded in accordance with all local codes and ordinances.

**⚠ WARNING** Improper connection of the equipment-grounding conductor can result in a risk of electric shock. Check with a qualified electrician or serviceman if you are in doubt as to whether the appliance is properly grounded.

Do not modify the plug provided with the appliance—if it will not fit the outlet, have a proper outlet installed by a qualified electrician.

NOTE: Do not under any circumstances remove grounding prong from plug.

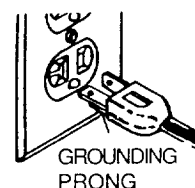

Figure 1

### NOTE TO INSTALLER

**⚠ WARNING**

The home electrical service entrance, the distribution center and circuit breakers, the branch circuit to the wall receptacle and receptacle must be capable of supplying 20 amps to your new Laundry Center and meet both national and local electrical codes.

The enclosed 20 amp receptacle, if needed, must be installed by a qualified electrician who will understand your needs and code requirements for a proper 20 amp branch circuit.

1. A 120 volt, 60 Hz, AC only electrical supply is required on a separate 20 ampere circuit fused by a time delay fuse or circuit breaker.
2. A 3-prong grounded wall receptacle (grounded in accordance with the National Electrical Code, ANSI/NFPA 70-1987, and local codes and ordinances) is required.

For added personal safety, connect a separate ground wire (No. 12 minimum) from the green ground screw on the rear of the dryer to a grounded cold water pipe as shown in Figure 2. Do not attach to a gas pipe or hot water pipe. Grounded cold water pipe must have metal continuity to electrical ground and not be interrupted by plastic, rubber or other electrical insulating connectors (such as hoses, fittings, washers or gaskets, including water meter or pump). Any electrical insulating connector should be jumped as shown in Figure 3 with a length of No. 4 wire securely clamped to bare metal at both ends.

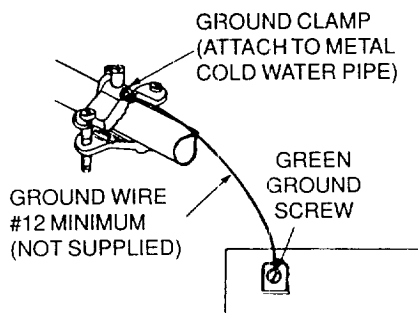

Figure 2

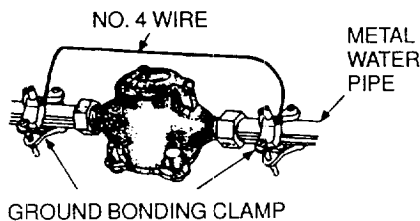

Figure 3

## Gas requirements

1. Installation must meet American National Standard, National Fuel Gas Code ANSI Z 223.1—1988 and local codes and ordinances.
2. The gas supply line should be 1/2 inch pipe. A 1/2" to 3/8" reducer must be used to connect the dryer to the supply line.
3. The gas supply line MUST have a shut-off valve preferably within six feet of the dryer (Figure 4).
4. A 1/8 inch NPT plugged tapping, accessible for test gauge connection, must be installed immediately upstream of the gas supply connection. The dryer and its individual shut-off valve must be disconnected from the gas supply piping system during any pressure testing (Figure 4) of that system at test pressures in excess 1/2 psig (3.45 kPa). The dryer must be isolated from the gas supply piping system by closing its individual manual shutoff valve during any pressure testing of the gas supply piping system at test pressures equal to or less than 1/2 psig (3.45 kPa).

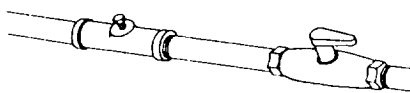

Figure 4

**⚠ DANGER** Do not attempt to alter gas orifice or adjust burner air shutter. Natural gas input may vary in some areas from 700 to 1200 B.T.U. per cubic foot. If gas orifice or burner air shutter are incorrectly adjusted, serious personal injury and/or fire hazard can occur. Your local gas company will know the qualities of the gas in your area. **Contact your local servicing dealer if burner adjustment or orifice changes are necessary.**

**⚠ DANGER** Do not use an open flame for leak testing. Serious personal injury and/or a fire hazard can result if an open flame is used to test for gas leaks. Use a soap and water solution to test all gas line fittings.

**⚠ DANGER** Do not install dryer to an L.P. gas supply without installing conversion kit. All dryers shipped out of the factory are equipped with a pressure regulator and natural gas orifice. Using a natural gas orifice with

an L.P. gas supply can result in personal injury, clothes damage, and/or a fire hazard. **Have a qualified gas technician install a conversion kit in dryer before use.**

## Exhaust requirements

**Four Inch Metal Exhaust Duct** is required. (Do not use 3-inch exhaust duct.) **Metal flexible duct** may be used. **DO NOT USE PLASTIC FLEXIBLE DUCT.**

### For Safety:

- Do not exhaust dryer into a chimney, furnace cold air duct, attic or crawl space, or any other duct used for venting. Accumulated lint could become a fire hazard or moisture could cause damage.
- The exhaust system should be cleared periodically, at least every 18 months.
- Flexible duct should never be installed concealed in walls, ceiling or floor.

Use Duct Tape to seal all joints.

**⚠ WARNING** Do not use screws or bolts which can catch lint and cause blockage in duct.

Exhausting the dryer outside is recommended.

A dryer installed in a bedroom, a bathroom, or a closet **MUST** be exhausted to the outside.

No other fuel-burning appliance shall be installed in the same closet as the dryer.

**For Mobile Home Exhaust Requirements** see Page 7, Alternate Exhaust Methods, for detailed instructions.

The **Exhaust Duct** should end with an exhaust hood to prevent exhausted air returning into dryer. The outlet of the hood must be at least 12 inches from the ground or anything else that may be in the path of the exhaust.

A **2-1/2 inch outlet Exhaust Hood** should be used with short systems only. This outlet creates greater backward pressure than other hood types.

**Exhaust Hoods** with screens or magnetic latches should not be used.

The **Maximum Length** of the exhaust system depends upon the type of duct used, number of elbows and type of exhaust hood. The maximum length for both rigid and flexible duct is shown in chart.

EXHAUST DUCT LENGTHS (FEET)			
Number of 90° Turns	EXHAUST HOOD TYPE		
	4"	LOUVERED	2 1/2"
<b>MAXIMUM LENGTH OF 4-INCH DIAMETER RIGID METAL DUCT</b>			
0	56'	56'	42'
1	46'	46'	36'
2	34'	34'	28'
3	32'	32'	18'
<b>MAXIMUM LENGTH OF 4-INCH DIAMETER FLEXIBLE METAL DUCT</b>			
0	30'	30'	22'
1	22'	22'	14'
2	16'	16'	10'
3	10'	10'	5'

Exhaust Systems longer than specified will:

- Shorten the life of the dryer.
- Reduce the performance, such as cause longer drying times and increases the use of energy.
- Accumulate lint.

The Laundry Center may be exhausted four (4) ways with rear flush installation:

1. **Straight back.**
2. **Down** (8" length of 4" rigid duct and 1 elbow down).
3. **Left** (8" length of 4" rigid duct, 1 elbow down and 1 elbow left).
4. **Right** (8" length of 4" rigid duct, 1 elbow down and 1 elbow right).

To exhaust up, add an 11" length of standard 4" diameter duct and a 90° elbow. The unit will be positioned about 4-1/2" away from the wall (flush to wall exhausting may be done by going below the dryer then sideways).

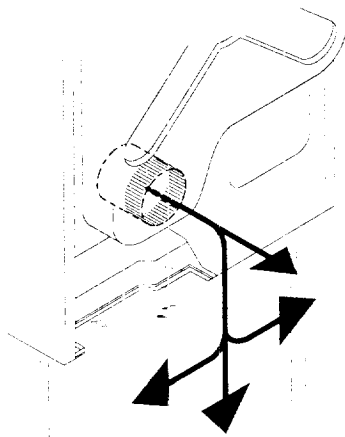

## Water supply and drain requirements

**Hot and Cold** water faucets within 4 feet of back of the Laundry Center and enough pressure (5-100 PSI) are required.

**Water Heater** should be set to deliver 130°F. or above water to the washer for best results.

To drain the Laundry Center washer, you need either a 20-gallon laundry tub or 1-1/4 inch diameter standpipe having a minimum carry-away capacity of 16 gallons per minute. The minimum tub or standpipe height is 33 inches from the bottom of the washer. The maximum tub or standpipe height is 96 inches from the bottom of the washer. For installations requiring a longer drain hose, have a qualified technician install a longer hose according to your model number. For drain systems in the floor, install a siphon break kit, P/N 5377678100. Both components are available from Sears Parts Department.

## PLEASE BEGIN . . .

1. Remove:
  - (a) foam tub blocking pad;
  - (b) foam shipping blocks from rear of unit;
  - (c) tape from dryer door;
  - (d) foam dryer support pads;
  - (e) inlet hoses (some models have inlet hoses already attached to the water valve).
  - (f) From the back of the washer, remove the wire shipping clips securing the drain hose and power cord. On some models, plastic clamps secure the drain hose to the right side of the washer backsheet. These clamps form a standpipe to prevent water siphoning. **DO NOT REMOVE THESE CLAMPS.**

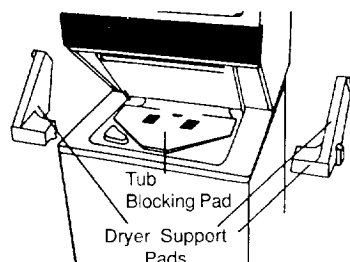

## 2.

Using the four shipping carton corner posts (two on each side), carefully lay the Laundry Center on its left side and remove the foam shipping base.

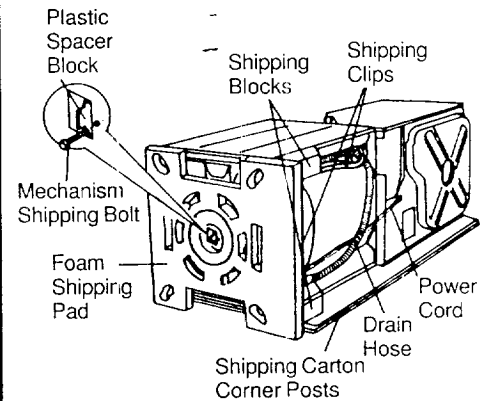

## 3.

Using the ratchet with 3/8 inch socket, remove mechanism shipping bolt. Remove plastic spacer block from center of base using adjustable pliers.

NOTE: If the Laundry Center is to be transported at a later date, the tub blocking pad, shipping bolt and plastic spacer block should be retained.

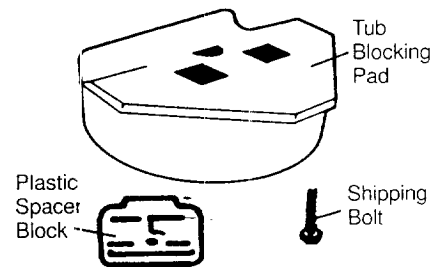

## 4.

Return Laundry Center to upright position.

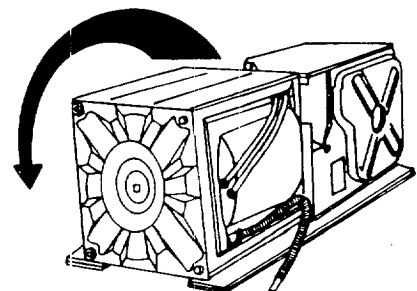

# 5.

Connect gas supply to dryer. If codes allow, use new flexible metal tubing (design certified by the American Gas Association). Be sure there are no kinks. For gas connections, you **MUST** use pipe joint compound resistant to the action of LP gas.

# 6.

Remove two (2) screws securing front access panel to dryer cabinet. Lower panel until bottom tabs can be disengaged from cabinet, remove panel, and set aside.

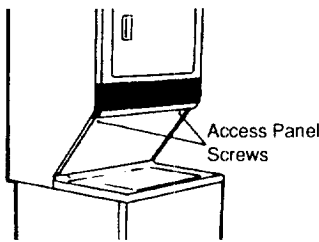

# 7.

Remove screws securing safety cover to dryer and remove safety cover.

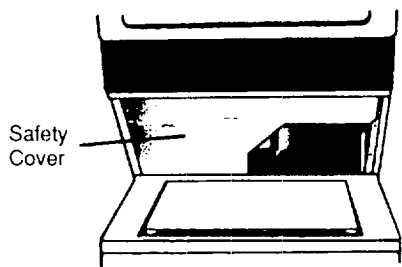

# 8.

Ensure the shutoff valve handle in the dryer is open.

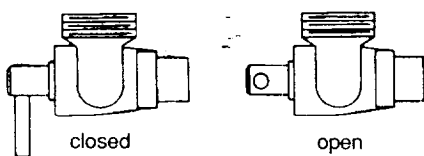

# 9.

Open the shutoff valve in the gas supply line.

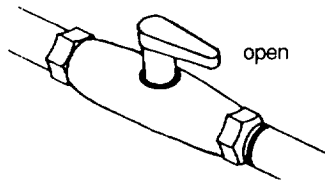

# 10.

Test all connections by brushing on a soapy water solution. (Liquid detergent also works well.) Bubbles will show a leak. Correct any leak found. **NEVER TEST FOR GAS LEAKS WITH A FLAME.**

# 11.

Run some water from the hot and cold faucets to flush the water lines and remove particles that might clog up the water valve screens. Check inlet hoses to ensure the rubber washers are installed in each end. (If your Laundry Center has the hoses attached to the water valve, proceed to step 12.) Carefully connect the inlet hoses to the water valve (on the left side of the washer cabinet), tighten by hand, then tighten another 2/3 turn with pliers.

**CAUTION DO NOT CROSS THREAD OR OVERTIGHTEN THESE CONNECTIONS.**

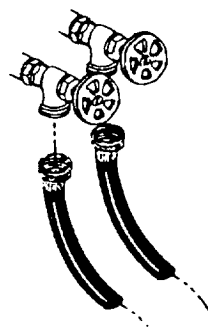

# 12.

Determine which water faucet is the **HOT** water faucet and carefully connect the bottom inlet hose to the **HOT** water faucet, tighten by hand, then tighten another 2/3 turn with pliers. Carefully connect the top inlet hose to the **COLD** water faucet, tighten by hand, then tighten another 2/3 turn with pliers.

**CAUTION DO NOT CROSS THREAD OR OVERTIGHTEN THESE CONNECTIONS.**

Turn the water on and check for leaks at both connections.

# 13.

Form a "U" shape on the end of the drain hose with the hose pointed toward the drain. On some models, a wire retainer needs to be assembled on the hose in that position. Place the formed end in a laundry tub or a standpipe and secure with a cable tie provided in the enclosure package.

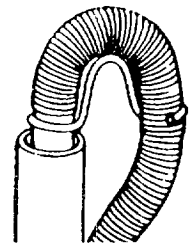

# 14.

Carefully move the Laundry Center to its final location. Plug the power cord into a grounded outlet.

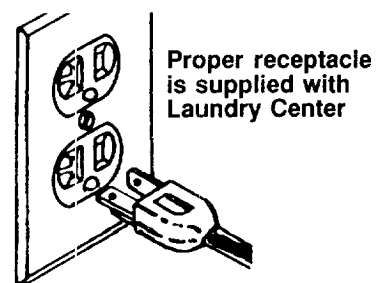

# 15.

To make sure the Laundry Center is solid and level, tilt the machine forward so the rear legs are off the ground. Gently set the machine back down to allow the rear legs to self adjust. Place a level on top of the washer. Check it side to side, then front to back. Screw the front leveling legs up or down to make sure the unit is solid on all four legs (no rocking of the appliance should exist).

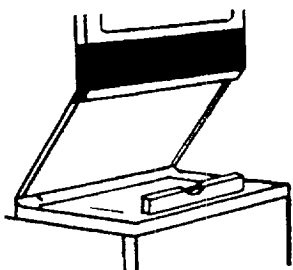

# 16.

Connect exhaust duct to outside ductwork. Use duct tape to seal all joints.

## ⚠ WARNING

- Do not use screws or bolts which can catch lint and cause blockage in duct.
- Do not use plastic flexible duct.

Do not exceed the length of duct pipe or number of elbows allowed in the Maximum Length Chart, Page 4. Install the exhaust duct as described in Exhaust Requirements, Page 3, and refer to the drawings below. To exhaust inside, refer to Alternate Exhaust Methods, Page 7.

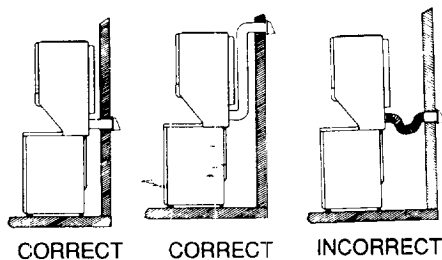

# 17.

Read and save the Operating Instructions and the Use and Care Guide that came with the Laundry Center.

# 18.

Clean the dryer drum and washer with a damp cloth.

# 19.

Turn on electricity at power source.

# 20.

Start washer and dryer, RUN THROUGH ONE COMPLETE CYCLE and check for possible leaks, exhaust connections and tub drainage. Ensure the burner has lit by opening dryer door after two minutes of running time and noting heat inside dryer.

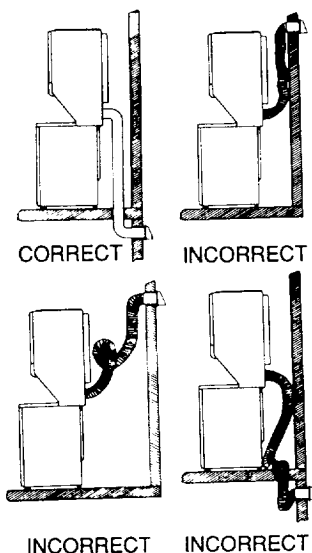

NOTE: Before burner will light, it is necessary for the gas line to be bled of air. If the burner does not light within 45 seconds the first time the dryer is turned on, the safety switch will shut off the burner. If this happens, turn the timer to "OFF" and wait 5 minutes before making another attempt to light.

# 21.

Reinstall access panel.

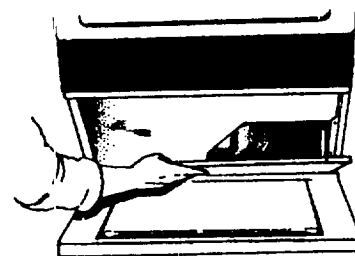

## Alternate installations: recessed or closet area locations.

The following are minimum installation spacings and openings (in inches) that you should allow. For easier installation and service, consider additional spacing.

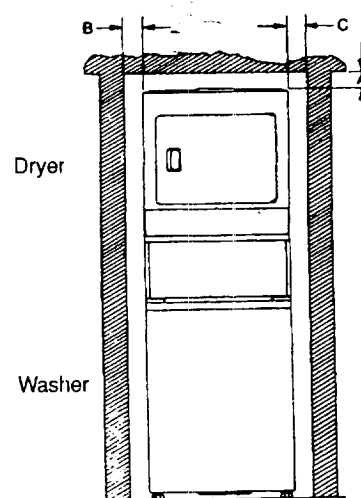

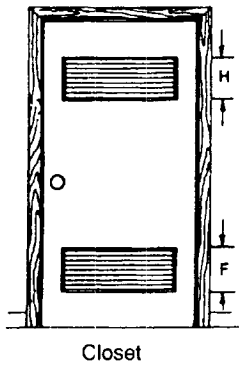
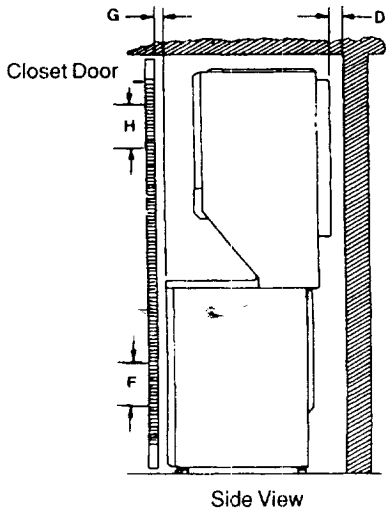

### Minimum Installation Spacing

RECESS INSTALLATION	A	B	C	D	F	G	H
INSIDE EXHAUST	4	0	4	1			
OUTSIDE EXHAUST	1	0	0	1			

CLOSET INSTALLATION	A	B	C	D	F	G	H
OUTSIDE EXHAUST ONLY	1	0	0	1	60 SQ. IN.	1	60 SQ. IN.

When the Laundry Center is installed in other than the recessed and closet type of installation shown, minimum dimensions indicated must be observed.

To prevent large amounts of lint and moisture from accumulating and to maintain drying efficiency, this appliance must be exhausted outdoors.

Non-exhausted installation-only rear exhaust position permitted.

### Alternate methods of securing drain hose

**A.** Put the bent end of the drain hose in the tub or standpipe.

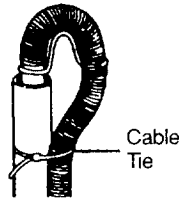

Figure 3

**B.** The drain hose must be held securely with the cable tie so it does not come out of the standpipe during use.

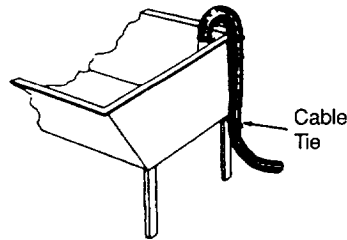

Figure 4

**C.** Secure the hose as shown in Figures 3 Standpipe, 4 Tub, 5 In wall standpipe.

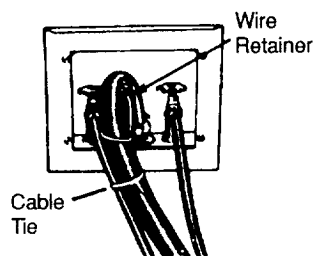

Figure 5

**BE SURE THE HOSE IS NOT TWISTED OR KINKED AND IS SECURELY IN PLACE.**

### Alternate exhaust methods.

**A.** There are exhaust kits available that allow you to direct filtered exhaust air inside to conserve energy during winter months. You may use these devices with the Laundry Center dryer providing their use does not violate national or local codes, and the device does not restrict exhaust air flow. If you use one of these kits, be aware that excessive moisture in the home can cause many problems and that you may see an increase in the time required to dry a load. Also, you must maintain the kit installation properly to avoid excessive lint buildup, which can affect the dryer's performance.

**B.** For mobile home installation, the dryer **must** be exhausted to the outside using metal ducting that will not support combustion. The termination must be securely fastened to the mobile home structure. Follow all other exhaust requirements referred to on Page 3. Under no conditions may the dryer exhaust duct terminate beneath the mobile home. See Figure 7.

### Mobile home installation

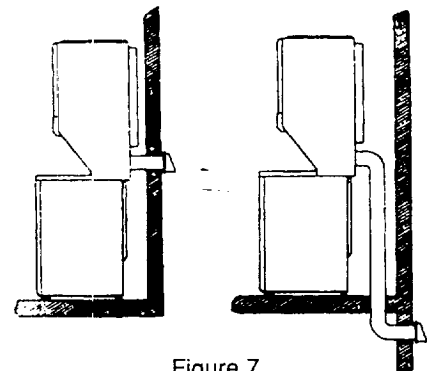
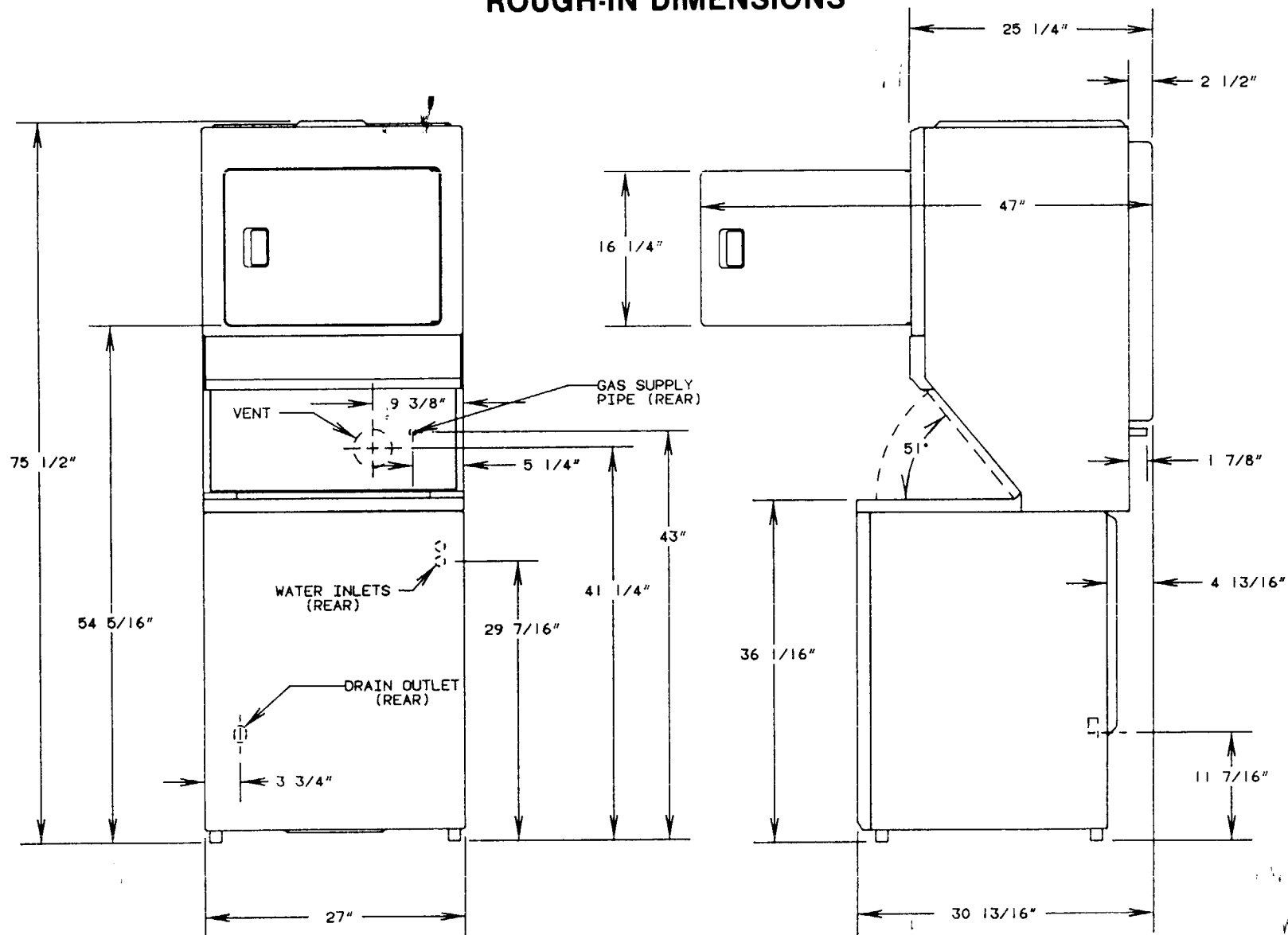

Figure 7

## ROUGH-IN DIMENSIONS



Sears, Roebuck and Co.  
Hoffman Estates, IL 60179 U.S.A.



## DIMENSIONES PARA LA INSTALACION

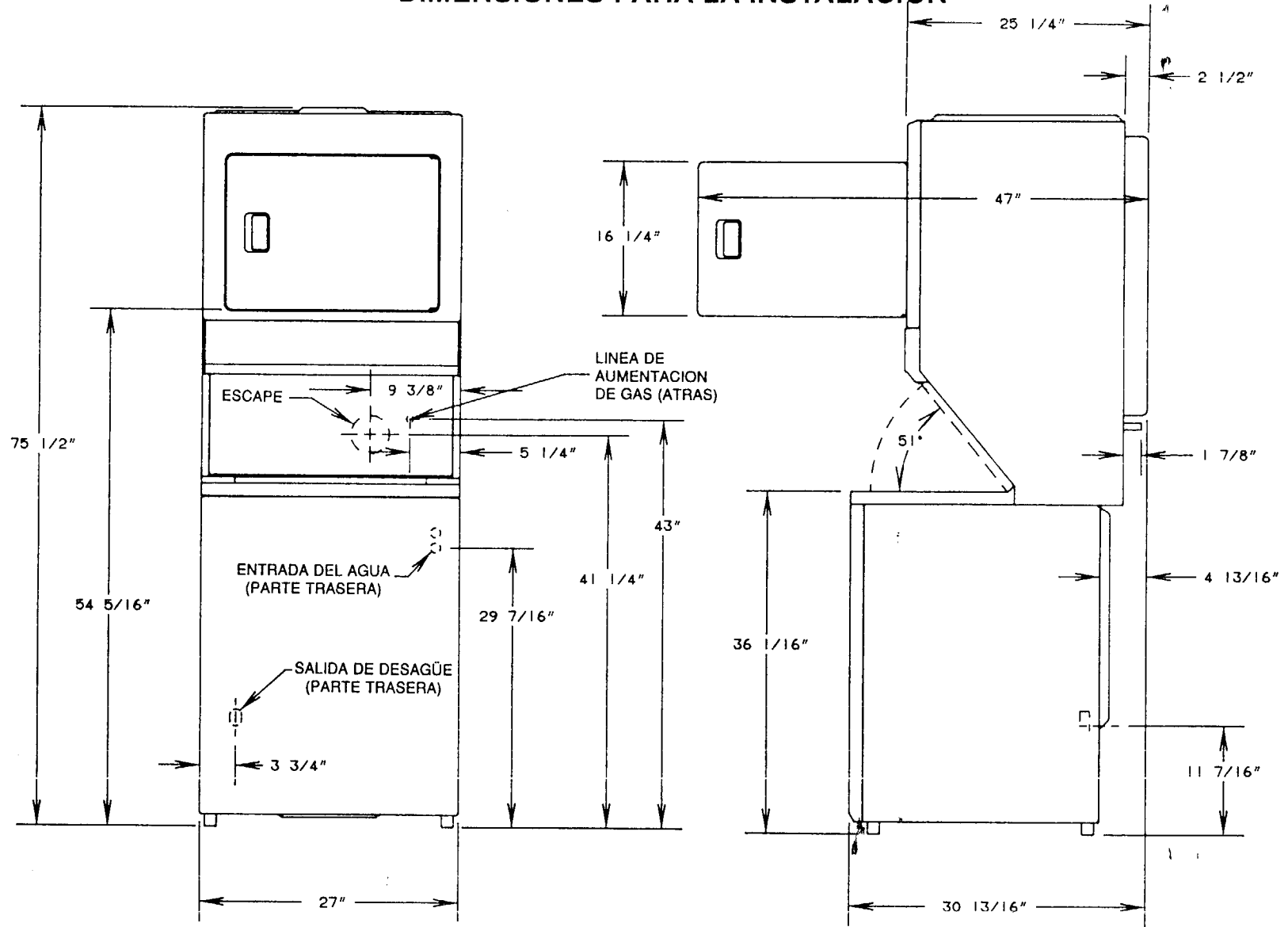

Sears, Roebuck and Co.  
Hoffman Estates, IL 60179 U.S.A.