

TOPMAZTM Racing

INSTRUCTION MANUAL

1:12
SCALE



FULL
FUNCTION



DUCATI

DESOMOSIEDICI



6+
ages



Contents

- RC Vehicle (Vehicle) x 1
- RC Transmitter (Transmitter) x 1
- USB Cable Adaptor x 1
- Instruction Manual x 1

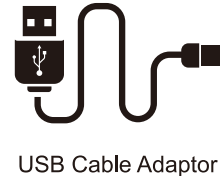

BATTERY REQUIREMENTS:

- 2 x AAA For Transmitter (Included)
- 3.7V Lithium 150mAh For Vehicle (Included)

Battery Precaution

1. The 3.7V rechargeable battery pack must be charged before use by utilizing the USB Cable Adaptor which included.
2. Do not overcharge the battery pack. Do not charge for more than 4 hours.
3. Do not charge the battery pack if it shows leakage, corrosion, or has loose or exposed wires or other damage.
4. Do not cover the battery pack with any sort of materials while charging.
5. Do not touch the battery pack when it is hot. Wait until the battery pack cools before installing it in the Vehicle and before recharging.
6. Do not dispose of the battery in fire.
7. Do not dismantle the battery or charger, and do not cut the battery or charger cables.
8. The battery pack will be warm after charging, and hot after use in a vehicle.
9. The supply terminals are not to be short-circuited.
10. Rechargeable batteries are only to be charged by adults.
11. Battery replacement must be only made by adults.
12. The USB Cable Adaptor is not a toy.
13. Charge only type (150mAh Max.) rechargeable battery packs. Other types of batteries may burst causing injury to persons and damage. This power unit is intended to be correctly orientated in a vertical or floor mount position. This USB Cable Adaptor is intended to be used for charging 3.7V rechargeable battery pack with capacity 150mAh Max. It cannot be used for charging non-rechargeable batteries. Regular examination of USB Cable Adaptor for any damage to their cord, plug, enclosure and other parts, and that, in the event of such damage, it must not be used with the charger or battery pack charge until such damage has been repaired. Note that the AAA battery is non-rechargeable and is not to be recharged. Only batteries of the same or equivalent type as recommended are to be used. It will need replacement when transmission is poor.
14. Exhausted batteries are to be removed from the product.
15. Non-rechargeable batteries are not to be recharged.
16. Different types of batteries or new and used batteries are not to be mixed.
17. Rechargeable batteries are to be removed from the toy before being charged.
18. Batteries are to be inserted with the correct polarity.
19. The packaging has to be kept since it contains important information.

Battery Installation

For Transmitter (Fig. 1 and Fig. 2)

1. Unscrew the screw on the battery cover
2. Open the battery cover
3. Install 2 new 1.5V "AAA" batteries with correct polarities (+/-) as shown inside the battery compartment
4. Close the battery cover
5. Tighten the screw on the battery cover

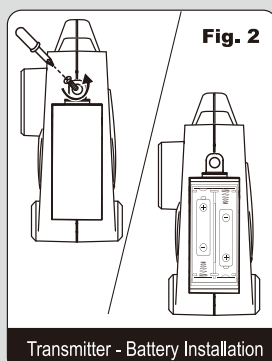
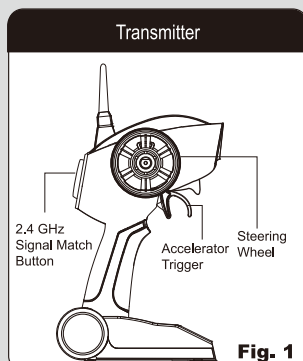

Charging the Rechargeable Battery Pack for the Vehicle (Fig. 3)

1. Connect the 3.7V rechargeable battery pack to the USB Cable Adaptor.
2. Recommend use Computer connect USB cable adaptor to charge the battery. If use adaptor connect USB Cable Adaptor to charger battery, the output limit cannot exceed 3.7V.
3. The charging time for a full charge is about 1 hour. Full charge battery usage Max. 30 mins.
4. When charging is completed, unplug the USB Cable Adaptor.
5. Disconnect the rechargeable battery pack from the USB Cable Adaptor.

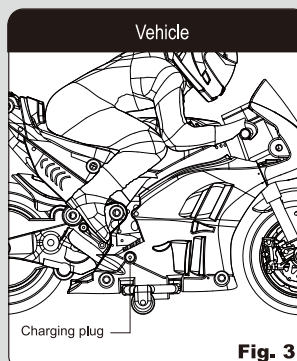

CAUTION

- Be Sure To Charge Battery Pack Before Using.
- If Battery Pack Is Hot After Use, Allow To Cool Before Recharging.
- Do Not Dispose Of Battery Pack In Fire.
- Do Not Recharge Battery Pack That Shows Leakage Or Corrosion, Or Attempt To Open Battery Pack.

1. Turn on the Vehicle.
2. Hold the Signal Match Button for around 4 second then the Transmitter signal light will flash for 6-7 second.
3. After the wheels of the Vehicle turn left and right and the LED light of the Transmitter stops flashing, the binding process completed for playing.
4. If it cannot complete within 8 seconds, please turn off the Vehicle and re-start the binding process.
5. When the binding process is done, whenever switching the Vehicle on and off, it searches for the code that it memorized, and will only lock on to the Transmitter signal containing that code.
6. Please turn off the Vehicle and re-start all binding process if changing to another 2.4GHz Transmitter for playing.

How To Play

1. Switch ON the Vehicle

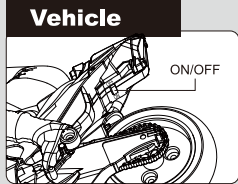

2. Use the Steering Wheel to control the Vehicle turning left or right

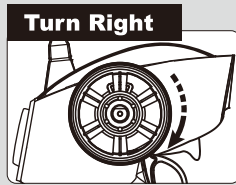
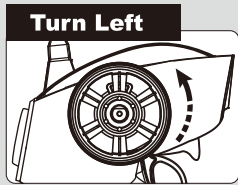

3. Use the Accelerator Trigger to drive the Vehicle Forward, Stop and Backward

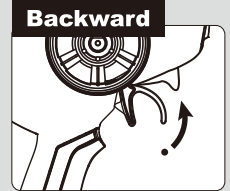
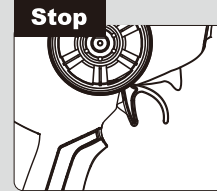
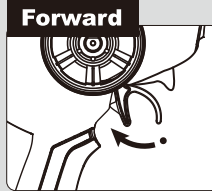

4. Play on smooth surface to have the optimum performance
5. Remember to switch OFF the power of the Vehicle after playing
6. The optimum control range is up to 15m outdoor

Performance Tips

1. Do not drive on grass, dirt, sand, dusts, carpet or go through water.
2. Do not drive in windy or rainy weather.
3. Avoid direct impact the Vehicle with obstacles.
4. Switch OFF the power when not in use to prevent damage of Vehicle and Transmitter due to leakage of electrolyte from batteries.
5. Remove all batteries from the Vehicle and Transmitter when not in use for long period.
6. Keep fingers, hair and loose clothing away from wheels.
7. The operating range can be affected by a variety of factors
 - a) Low Voltage of batteries in Transmitter or Vehicle
 - b) Interference from other items that emit radio frequency signals.
8. Outdoor usage is recommended in order to get optimum control range.
9. Recommend to play the vehicle on a clean and smooth surface.
10. Clean the battery compartment to make sure it is free from dust to prevent poor contact of batteries

Cautions

1. Do not attempt to disassemble the Vehicle or Transmitter
2. Make sure the batteries are installed with correct polarities (+/-) as shown inside the battery compartment
3. Remove the package and take out all accessories before giving the Vehicle and Transmitter to child to play

The packaging and instruction manual contain important information. Please keep them for future reference.

Warning! Choking Hazard. Not suitable for children under the age of 3 years due to small parts.

We reserve the right to improve/amend specifications and colors without notice.

FCC label compliance statement:

This device complies with part 15 of the FCC rules. Operation is subject to the following two conditions:

1. This device may not cause harmful interference, and
2. This device must accept any interference received, including interference that may cause undesired operation. Note: This equipment has been tested and found to comply with the limits for a Class B digital device, pursuant to Part 15 of the FCC Rules. These limits are designed to provide reasonable protection against harmful interference in a residential installation. This equipment generates, uses and can radiate radio frequency energy and, if not installed and used in accordance with the instructions, may cause harmful interference to radio communications. However, there is no guarantee that interference will not occur in a particular installation. If this equipment does cause harmful interference to radio or television reception, which can be determined by turning the equipment off and on, the user is encouraged to try to correct the interference by one or more of the following measures:
 - Reorient or relocate the receiving antenna
 - Increase the separation between the equipment and receiver
 - Connect the equipment into an outlet on a circuit different from that to which the receiver is connected
 - Consult the dealer or an experienced radio/TV technician for help

Warning: Changes or modifications to this unit not expressly approved by the party responsible for compliance could void the user's authority to operate the equipment.

RSS-210 Compliance Statement:

This device complies with Industry Canada Licence-exempt RSS-210. Operation is subject to the following two conditions: (1) this device may not cause interference, and (2) this device must accept any interference, including interference that may cause undesired operation of the device.

Under Industry Canada regulations, this radio transmitter may only operate using an antenna of a type and maximum (or lesser) gain approved for the transmitter by Industry Canada. To reduce potential radio interference to other users, the antenna type and its gain should be so chosen that the equivalent isotropically radiated power (e.i.r.p.) is not more than that necessary for successful communication.

Declaration of Conformity

The product is in conformity with the requirement of EU Directive 2014/53/EU.

Environmental notes:

The whole product also does not belong to household waste at the end of the product life.

You can return it at collection points for the recycling of electronic and electrical instruments

The symbol on the item, instruction manual, hangtag or packing is showing this clearly.

Materials should be recycled according to their respective markings.

Recycling of old devices or other re-use of materials contained therein represents an important contribution to environmental protection.

Please ask at your local community for the correct collection point.



Disposal of batteries

Batteries should not be disposed of in the household waste. As the consumer you are legally obliged to return batteries containing harmful substances and all other used batteries. You can hand in your old batteries at public collection points in your area or wherever batteries are sold.

You will find these chemical abbreviations along with a crossed-out refuse bin on batteries containing harmful substances:

- Pb=Battery contains lead
- Cd=Battery contains cadmium
- Hg=Battery contains mercury



Le présent appareil est conforme aux CNR d'Industrie Canada applicables aux appareils radio exempts de licence.

L'exploitation est autorisée aux deux conditions suivantes :

- 1) l'appareil ne doit pas produire de brouillage;
- 2) l'appareil doit accepter tout brouillage radioélectrique subi, même si le brouillage est susce

Frequency band: 2410-2475 MHz
Maximum radio frequency power transmitted: <0dBm



Conforms to the safety requirements of ASTM F963



www.kidztech.net



KIDZTECH TOYS MANUFACTURING LTD.
Room 1201, 12/F, Inter-Continental Plaza,
94 Granville Road, TST East, Hong Kong.
Tel: (852) 27218868 info@kidztech.net
Made in China http://www.kidztech.net

KT-20180709(EN)