



APPENDIX G
: USER'S MANUAL

|HCT|

32" LCD TV USER'S GUIDE

HLD-320TB

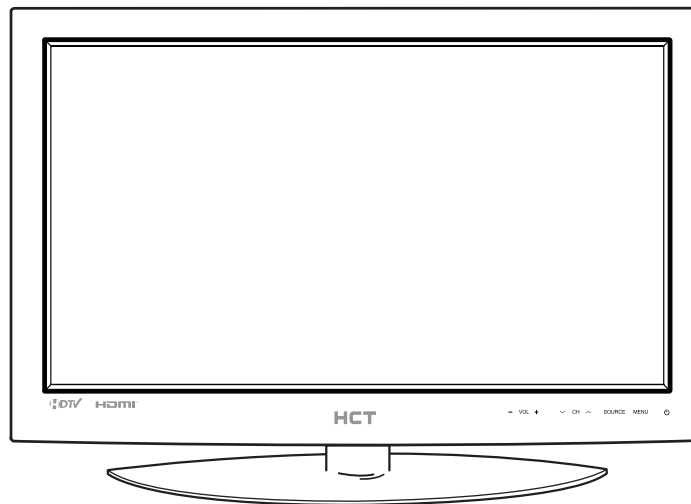





PLEASE READ CAREFULLY BEFORE USE

Before Connecting, operating or adjusting this product, please read the instructions completely.
Please keep this manual for future reference.
For future reference, record the serial number of your LCD TV.

SERIAL NO. _____
The serial number is located on the rear of LCD TV.

WARNING / CAUTION

 WARNING/CAUTION RISK OF ELECTRIC SHOCK DO NOT OPEN 	 <p>The lightning flash with arrowhead symbol, within an equilateral triangle, is intended to alert the user to the presence of uninsulated "dangerous voltage" within the product's enclosure that may be of sufficient magnitude to constitute a risk of electric shock to persons.</p>  <p>The exclamation point within an equilateral triangle is intended to alert the user to the presence of important operating and maintenance (servicing) instructions in the literature accompanying the appliance.</p>
<p>TO REDUCE THE RISK OF ELECTRIC SHOCK DO NOT REMOVE COVER (OR BACK). NO USER SERVICEABLE PARTS INSIDE. REFER TO QUALIFIED SERVICE PERSONNEL.</p>	

WARNING/CAUTION

TO REDUCE THE RISK OF FIRE AND ELECTRIC SHOCK, DO NOT EXPOSE THIS PRODUCT TO RAIN OR MOISTURE.

NOTE TO CABLE/TV INSTALLER

This reminder is provided to call the CATV system installer's attention to Article 820-40 of the National Electric Code (U.S.A.). The code provides guidelines for proper grounding and, in particular, specifies that the cable ground shall be connected to the grounding system of the building, as close to the point of the cable entry as practical.

CAUTION

Do not attempt to modify this product in any way without written authorization from the dealer. Unauthorized modification could void the user's authority to operate this product.

WARNING / CAUTION

To prevent fire or shock hazards, do not expose this product to rain or moisture.

FCC NOTICE

Class B digital device

This equipment has been tested and found to comply with the limits for a Class B digital device, pursuant to Part 15 of the FCC Rules.

These limits are designed to provide reasonable protection against harmful interference in a residential installation. This equipment generates, uses and can radiate radio frequency energy and, if not installed and used in accordance with the instructions, may cause harmful interference to radio communications.

However, there is no guarantee that interference will not occur in a particular installation.

If this equipment does cause harmful interference to radio or television reception, which can be determined by turning the equipment off and on, the user is encouraged to try to correct the interference by one or more of the following measures:

- Reorient or relocate the receiving antenna.
- Increase the separation between the equipment and receiver.
- Connect the equipment to an outlet on a circuit different from that to which the receiver is connected.
- Consult the dealer or an experienced radio/TV technician for help.

Caution

Changes or modification not expressly approved by the party responsible for compliance could void the user's authority to operate the equipment.

On Disposal

- a. The fluorescent lamp used in this product contains a small amount of mercury.
- b. Do not dispose of this product with general household waste.
- c. Disposal of this product must be carried out in accordance to the regulations of your local authority.

Digital Television Transition Notice

The nationwide transition to digital television broadcasting by full-power TV stations will be completed by June 12, 2009, but your local television stations may switch sooner. After the switch, analog-only television sets that receive TV programming through an antenna will need a converter box to continue to receive over-the-air TV. Watch your local stations to find out when they will turn off their analog signal and switch to digital-only broadcasting. Analog-only TVs should continue to work as before to receive low-power, Class A or translator television stations and with cable and satellite TV services, gaming consoles, VCRs, DVD players, and similar products.

Information about the DTV transition is available from your local television stations, www.DTV.gov, or 1-888-CALL-FCC (TTY 1-888-TELL-FCC). Information about government coupons for eligible digital-to-analog converter boxes is available from www.dtv2009.gov or 1-888-DTV-2009 (TTY 1-877-530-2634).

Important Safety Instructions

1. Read these instructions.
2. Keep these instructions.
3. Heed all warnings.
4. Follow all instructions.
5. Do not use this apparatus near water.
6. Clean only with dry cloth.
7. Do not block any ventilation openings.
Install in accordance with the manufacturer's instructions.
8. Do not install near any heat sources such as radiators, heat registers, stoves, or other apparatus (including amplifiers) that produce heat.
9. Do not defeat the safety purpose of the polarized or grounding-type plug. A polarized plug has two blades with one wider than the other. A grounding type plug has two blades and a third grounding prong. The wide blade or the third prong are provided for your safety. If the provided plug does not fit into your outlet, consult an electrician for replacement of the obsolete outlet.
10. Protect the power cord from being walked on or pinched particularly at plugs, convenience receptacles, and the point where they exit from the apparatus.
11. Only use attachments/accessories specified by the manufacturer.
12. Use only with the cart, stand, tripod, bracket, or table specified by the manufacturer, or sold with the apparatus. When a cart is used, use caution when moving the cart/apparatus combination to avoid injury from tip-over.



13. Unplug this apparatus during lightning storms or when unused for long periods of time.
14. Refer all servicing to qualified service personnel. Servicing is required when the apparatus has been damaged in any way, such as power-supply cord or plug is damaged, liquid has been spilled or objects have fallen into the apparatus, the apparatus has been exposed to rain or moisture, does not operate normally, or has been dropped.
15. Do not expose this apparatus to dripping or splashing and ensure that no objects filled with liquids, such as vases, are placed on the apparatus.
16. To completely disconnect this apparatus from the AC Mains, disconnect the mains plug from the AC receptacle.
17. The mains plug of the power supply cord shall remain readily operable.
18. This apparatus shall be connected to a Mains socket outlet with a protective earthing connection.

Important Safety Instructions

NOTE

Prolonged use of headphones at a high volume may cause health damage on your ears.

.....



The lightning flash with arrowhead symbol within an equilateral triangle, is intended to alert the user to the presence of uninsulated "dangerous voltage" within the product's enclosure that may be of sufficient magnitude to constitute a risk of electric shock to persons.



The exclamation point within an equilateral triangle is intended to alert the user to the presence of important operating and maintenance (servicing) instructions in the literature accompanying the product.

WARNING: To reduce the risk of fire or electric shock, do not expose this apparatus to rain or moisture.

Contents

WARNING CAUTION	3	WARNING / CAUTION
	5	Important Safety Instructions
Controls And Connectors	10	Front Panel
	10	Swivel Stand
	11	Rear Panel
	12	Remote Control
Installation	14	Wall mount Installation
	14	Desktop Pedestal Installation
Connection	15	Antenna Connection
	16	VCR Connection
	18	DVD Connection
	20	HDSTB Connection
	22	External A/V Source
	22	Digital Audio Out
	23	PC Connection
	24	Resolution
Basic Operation On Screen Menus	25	Turning On or Off
	25	Channel Selection
	25	Volume Adjustment
	25	Sound Mute
	25	Quick View
	26	Input Selection
	26	Language Selection
	27	On Screen Menus
Setting up TV Channel	28	Auto Scan
	29	Add/Delete Channel
	30	EPG(Electronic Program Guide)
Picture Controls	31	Adjusting The Picture Controls
	32	Manual Picture Controls
	33	Reset Picture Mode
Advanced Video	34	Dynamic Noise Reduction
	35	Black Level Extender
	35	White Peak Limiter
	36	CTI (Color Transient Intensity)
	36	Flesh Tone

Advanced Video	37	Adaptive Luma Control
	37	Gamma
	38	Color Temperature
Sound Controls	39	Adjusting The Sound Controls
	40	Manual Sound Controls
	41	Digital Output
	42	Auto Volume Control
	42	Stereo/SAP Broadcast Setup
Time Setting	43	Time Zone Setting
	44	Auto Time Setting
	45	Manual Time Setting
	46	Auto On/Off Time Setting
	47	Sleep Timer
Captions	48	Closed Caption-Analog
	49	Closed Caption-Digital
	50	Closed Caption Options
Reset	51	Reset Default
Parental Control	52	Enter your password
	52	Set Password
	53	Rating Enable/Disable
	54	TV Ratings for USA
	56	Movie Ratings
	57	TV Rating English for Canada
	58	TV Rating French for Canada
	59	Downloadable Rating
	60	Clean All
Setting the PC Mode	61	Auto Picture Controls
	62	Manual Picture Controls
	63	Color Temperature
	64	Automatic Screen Adjustment
	65	Manual Screen Adjustment
Special Functions	66	Picture Format
	67	Specification
	68	Troubleshooting
	69	CHILD SAFETY
	70	Warranty

Accessories

Supplied Accessories

Ensure that the following accessories are included with your product.

If an accessory is missing, please contact the dealer where you purchased the product.

User must use shielded signal interface cables with ferrite cores to maintain standard compliance for the product.

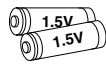

Batteries



Power cord



Owner's Manual



Remote



Front Cover



220V Adaptor Plug

Installing Batteries

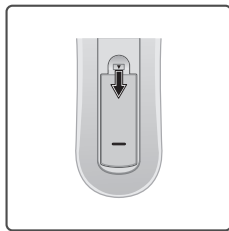

1

Open the battery cover on the back side.



2

Insert two batteries in correct polarity, match (+ with +), and match (- with -). Don't mix old batteries with new batteries.



3

Close the battery cover.

Controls And Connectors

Front Panel

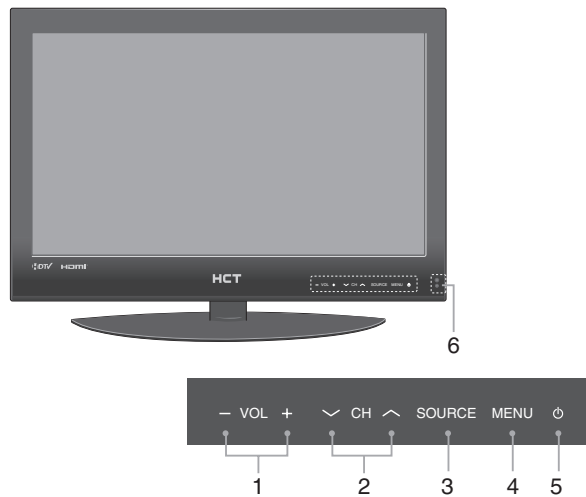

- 1. VOL + / VOL -**
Adjusts menu setting.
Adjusts sound level.
- 2. CH \downarrow / CH \uparrow**
Select a channel.
- 3. SOURCE**
Selects the **TV**, **AV**, **S-Video**, **YPbPr1**, **YPbPr2**, **VGA**, **HDMI1** and **HDMI2** mode.
- 4. MENU**
Display on screen menus.
- 5. POWER**
Switches the set on or off.
- 6. Power Indicator**
Illuminates in bright blue when the TV is in standby mode.
Illuminates in dark blue when the TV is switched on.
Remote control sensor
Accepts the IR signal of remote controller.

NOTE

Here shown may be somewhat different from your set.

Swivel Stand

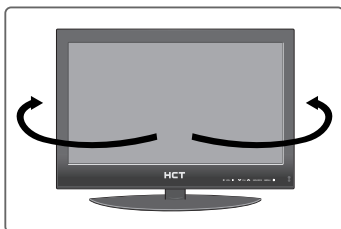

- After installing the TV, you can adjust the TV manually to the left or right direction by 20 degrees to suit your viewing position.

Rear Panel

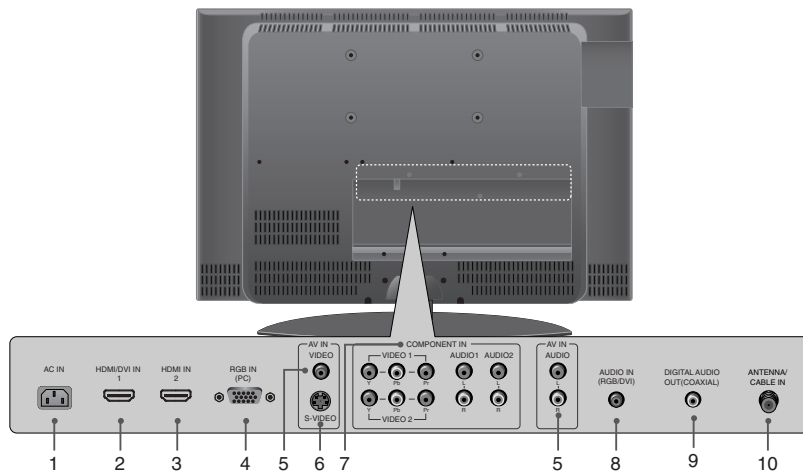

1. **AC IN**
Connects to a three prong, grounded AC outlet.
2. **HDMI/DVI IN - Quality Level: 5**
Connects to High Definition devices using an HDMI Cable. Both Audio and Video is transferred through this cable.
(This input can also be used as a DVI connection with an HDMI to DVI adaptor. A separate audio connection must be used as DVI does not transmit audio.)
3. **HDMI2 IN - Quality Level: 5**
Connects to High Definition devices using an HDMI Cable. Both Audio and Video is transferred through this cable.
4. **RGB IN (PC)**
Connects to the video output jack on your computer using a RGB / DB15 cable.
5. **AV IN - Quality Level: 1-2**
Connects to your Audio/Video devices using a composite (Yellow/Red/White) cable.
6. **S-VIDEO IN - Quality Level: 3**
Connects to your video devices using an S-Video Cable.
7. **COMPONENT IN (YPbPr1/YPbPr2) - Quality Level: 4**
Connects to your Video devices to achieve higher quality video than S-Video and Composite using a Component (Red/Green/Blue) Cable.
8. **AUDIO IN (RGB/DVI)**
Connects to the audio output jack on your computer using a 3.5mm headphone jack.
9. **DIGITAL AUDIO OUT(COAXIAL)**
Connects to your digital audio devices to transmit a digital rather than an analog audio signal.
10. **ANTENNA/CABLE IN**
Connects to your antenna or Cable/Satellite set top box using a coaxial cable.

NOTE

Here shown may be somewhat different from your set.

Remote Control

- All the functions can be controlled with the remote control handset.
- Some functions can also be adjusted with the buttons on the front panel of the set.
- Before using remote control handset, please install the batteries.

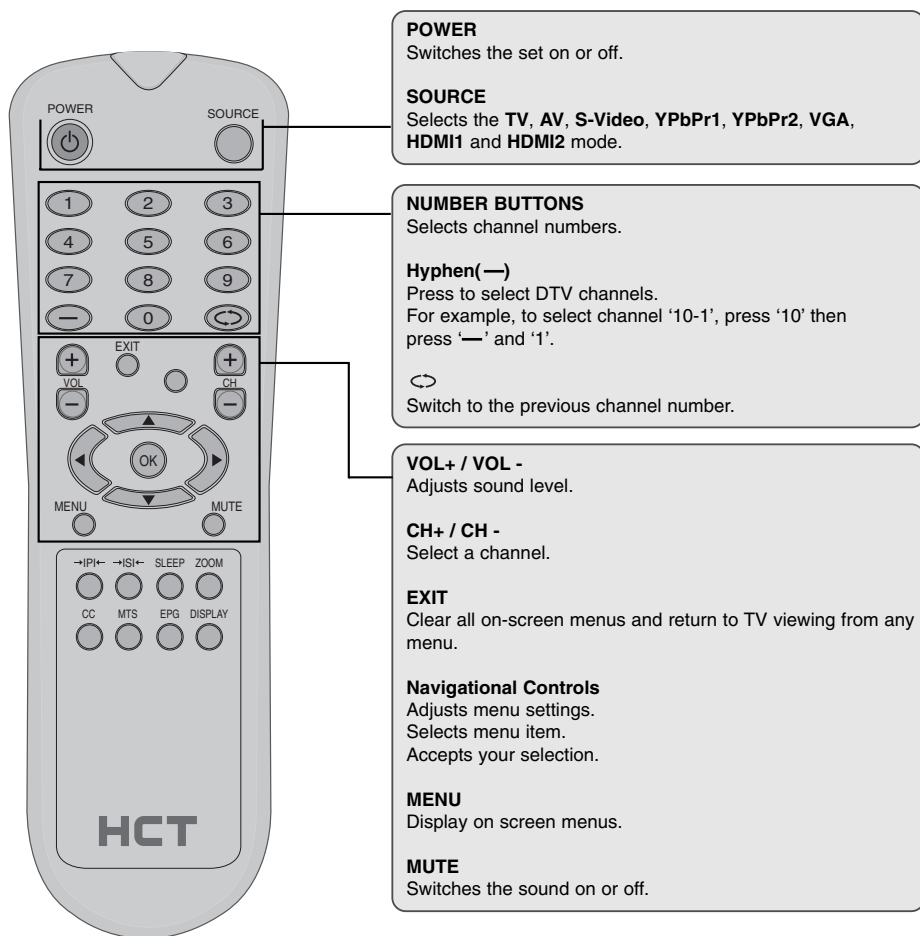

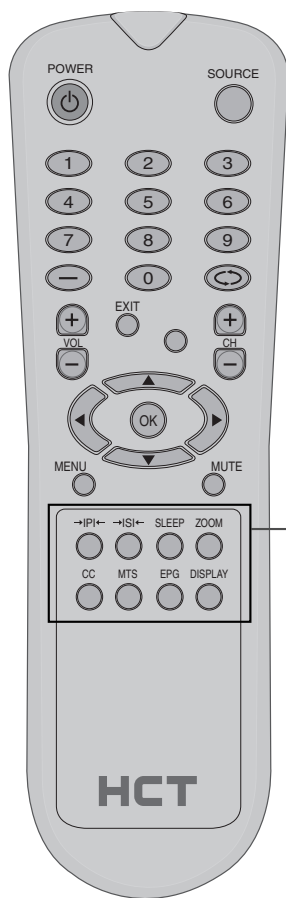

- |P|-**
Recalls your preferred picture setting.
- |S|-**
Recalls your preferred sound setting.
- SLEEP**
Sets the sleep timer.
- ZOOM**
Selects your desired picture format.
- CC**
Select the Caption menu directly.
- MTS**
Select MTS sound : Mono, Stereo and SAP in Analog Channel.
Change the audio language in DTV Channel.
- EPG**
Displays the program guide.
- DISPLAY**
Shows the present screen information.

Installation

Wall mount Installation

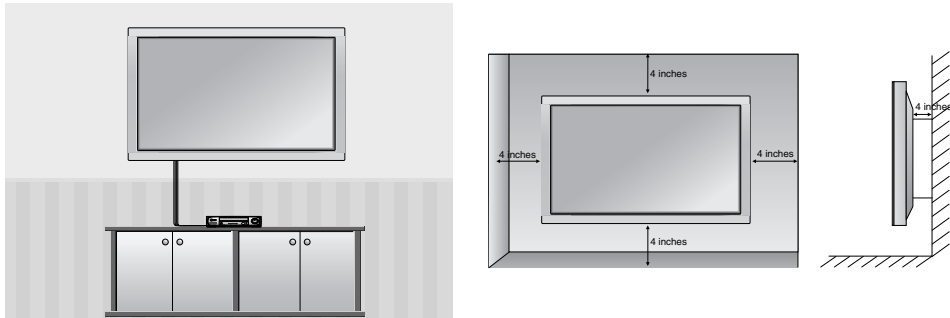

The set can be installed on a wall as shown above.
For proper ventilation, allow a clearance of 4 inches on all four sides from the wall.
Detailed instructions are available from your dealer, refer to the optional Wall Mounting Bracket Installation and Setup Guide. (Wall Mount Sold Separately)

NOTE -----

- Do not install the Wall-Mount except the Qualified Service Personnel.
-

Desktop Pedestal Installation

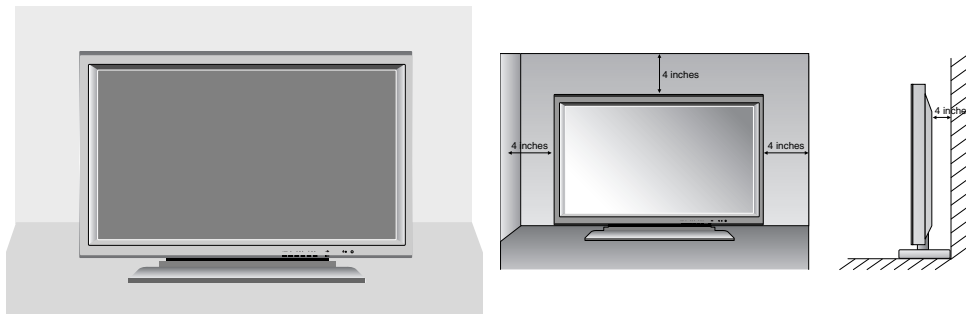

The set can be mounted on a desk as shown above.
For proper ventilation, allow a clearance of 4 inches on each side from the wall.
Detailed instructions are available from your dealer, refer to the optional Desktop Stand Installation and Setup Guide.

Connections

Antenna Connection

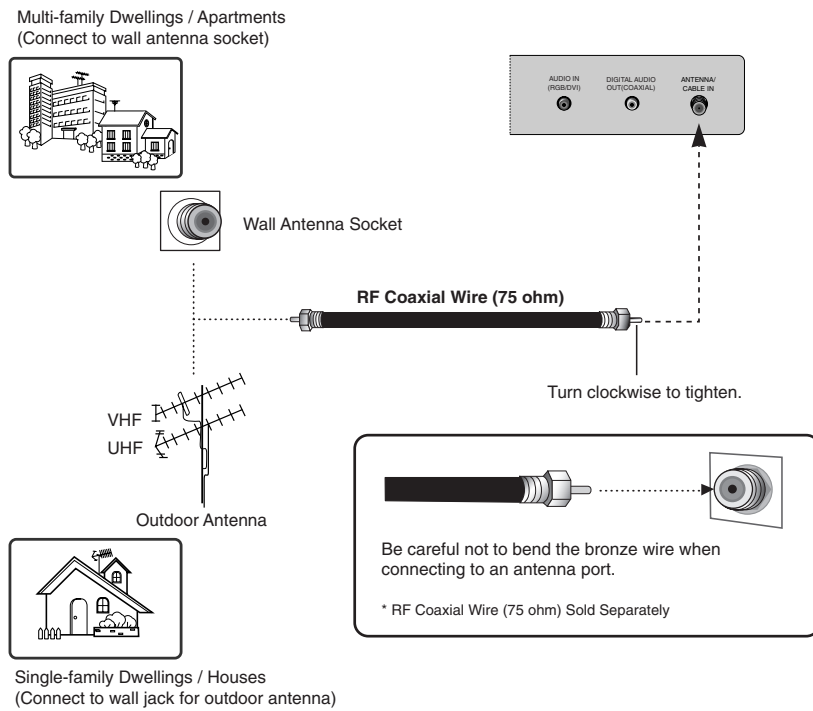

NOTE

- To improve the picture quality in a poor signal area, please purchase a signal amplifier and install properly.
- If the antenna is not installed properly, contact your dealer for assistance.

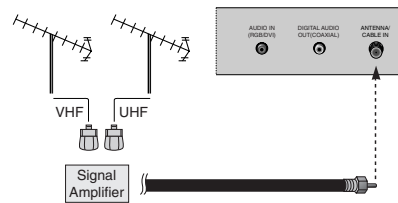

VCR Connection

- To avoid picture noise (interface), leaves an adequate distance between the TV and the VCR.

■ When connecting with an antenna

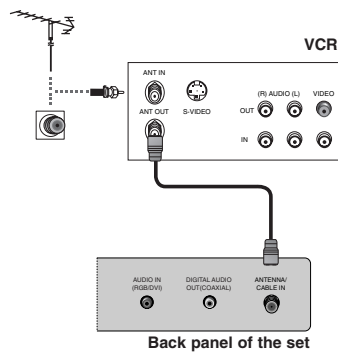

1. Connect the Antenna Out socket on the VCR to the Antenna Input socket on the TV.
2. Press the POWER button on the VCR and select the appropriate input selection on the TV using the remote control or the side buttons on the TV.

■ When connecting with a RCA cable

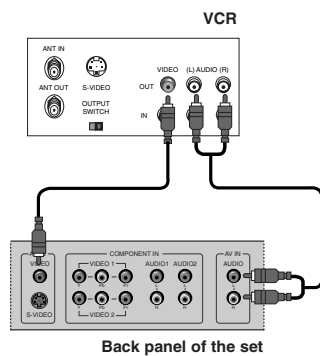

1. Connect the composite jacks between AV Input on the TV and AV Output on the VCR. Make sure the jack colors match with the connector colors on both ends. (Video = yellow, Left Audio = white, and Right Audio = red)
2. Insert a video tape into the VCR and press PLAY.
3. Select the AV input source on the TV using either the SOURCE buttons on the remote control.
4. Refer to the VCR manual for operating instructions.

■ When connecting with a S-Video cable

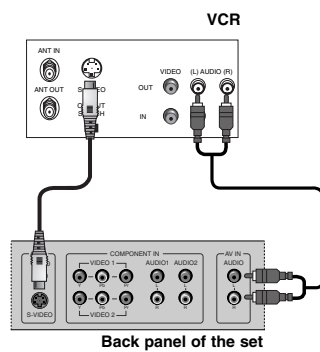

1. Connect the S-VIDEO Output on the VCR to the S-VIDEO Input on the TV.
2. Connect the audio outputs of the VCR to the AUDIO L / R input jacks under AV IN on the TV.
3. Insert a video tape into the VCR and press PLAY.
4. Select the S-Video input source on the TV using either the SOURCE buttons on the remote control.
5. Refer to the VCR manual for operating instructions.

DVD Connection

■ When connecting with a S-Video cable

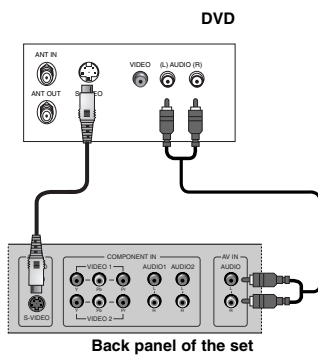

1. Connect the S-VIDEO Output of the DVD player to the S-VIDEO Input on the TV.
2. Connect the Audio Outputs on the DVD player to the AUDIO L / R Input jacks under AV IN on the TV.
3. Turn on the DVD player and insert a DVD.
4. Select the S-Video input source on the TV using either the SOURCE buttons on the remote control.
5. Refer to the DVD player's manual for operating instructions.

■ When connecting with a Component Cable

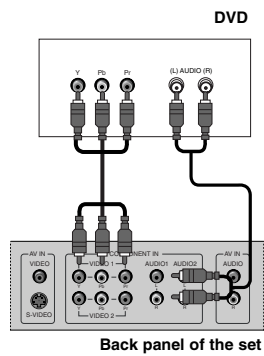

1. Connect the Video Outputs (Y, PB, PR) on the DVD player to the COMPONENT1 or COMPONENT2 Video Inputs on the TV.
2. Connect the Audio Outputs on the DVD player to the COMPONENT1 or COMPONENT2 Audio Inputs on the set.
3. Turn on the DVD player and insert a DVD.
4. Select the YPbPr1 or YPbPr2 source on your TV by pressing either the SOURCE buttons on the remote control.
5. Refer to the DVD player's manual for operating instructions.

■ When connecting with a HDMI cable

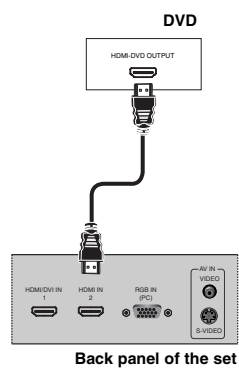

1. Connect the HDMI Output on the DVD player to the HDMI/DVI IN1 or HDMI IN2 Input on the TV.
2. Select the HDMI1 or HDMI2 input source on your TV by pressing either the SOURCE buttons on the remote control.
3. Refer to the DVD player's manual for operating instructions.

HDSTB Connection

- This TV can receive Digital Over-the-air/Cable signals without an external digital set-top box. However, if you do receive Digital signals from a digital set-top box or other digital external device, refer to the figure as shown below.

■ When connecting with a D-Sub 15 pin cable

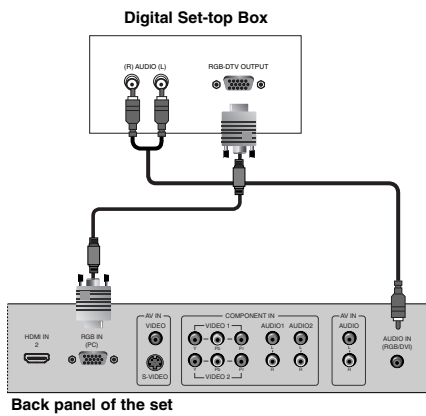

1. Connect the RGB Output on the digital set-top box to the RGB Input (PC) jack on the TV.
2. Connect the Audio Output on the set-top box to the AUDIO Input (RGB/DVI) jack on the TV.
3. Turn on the digital set-top box.
4. Select the VGA input source on your TV by pressing either the SOURCE buttons on the remote control.
5. Refer to the digital set-top box manual for operating instructions.

■ When connecting with a HDMI cable

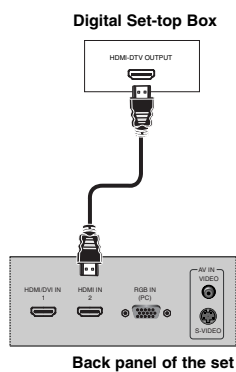

1. Connect the HDMI Output on the digital set-top box to the HDMI/DVI IN1 or HDMI IN2 Input on the TV.
2. Turn on the digital set-top box.
3. Select the HDMI1 or HDMI2 input source on your TV by pressing either the SOURCE buttons on the remote control.
4. Refer to the digital set-top box manual for operating instructions.

■ When connecting with a Component cable

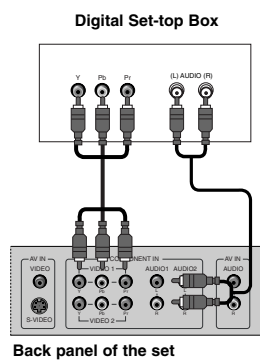

1. Connect the Video Outputs (Y, PB, PR) on the digital set-top box to the COMPONENT1 or COMPONENT2 Video Inputs on the TV.
2. Connect the Audio Outputs on the digital set-top box to the COMPONENT1 or COMPONENT2 Audio Inputs on the set.
3. Turn on the digital set-top box.
4. Select the YPbPr1 or YPbPr2 input source on your TV by pressing either the SOURCE buttons on the remote control.
5. Refer to the digital set-top box manual for operating instructions.

■ When connecting with a HDMI to DVI cable

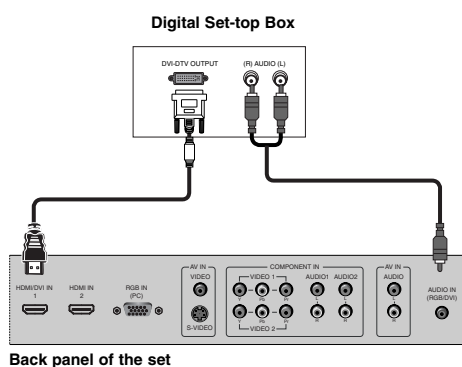

1. Connect the DVI Output on the digital set-top box to the HDMI / DVI IN1 Input jack on the TV.
2. Connect the Audio Output on the set-top box to the AUDIO IN (RGB/DVI) jack on the set.
3. Turn on the digital set-top box.
4. Select the HDMI1 input source on your TV by pressing either the SOURCE buttons on the remote control.
5. Refer to the digital set-top box manual for operating instructions.

External A/V Source

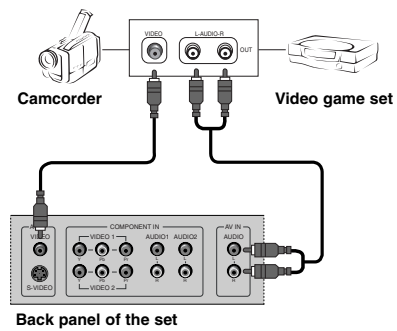

1. Connect the composite jacks between AV Input on the TV and AV Output on the External Device. Make sure the jack colors match with the connector colors on both ends. (Video = yellow, Left Audio = white, and Right Audio = red)
2. Select the AV input source on the TV using either the SOURCE buttons on the remote control.
3. Turn on the External Device.
4. Refer to the External Device's manual for operating instructions.

Digital Audio Out

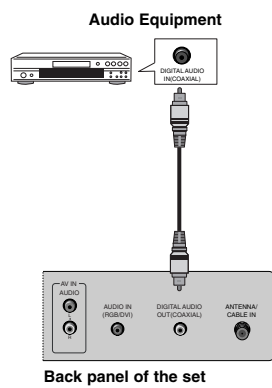

1. Connect the Digital Audio Output on the TV to the Digital Audio Input on the Digital Audio Device using a Digital Coax Cable.
2. Refer to the audio equipment's manual for operating instructions.

PC Connection

■ When connecting with a D-Sub 15 pin cable

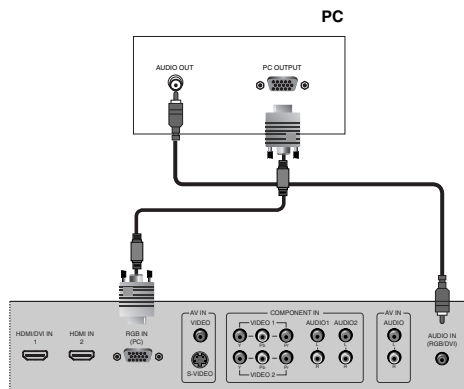

Back panel of the set

1. Connect the RGB output of the PC to the RGB IN (PC) jack on the set.
2. Connect the PC Audio Output to the AUDIO IN (RGB/DVI) jack on the TV using a male-to-male 3.5mm mini jack.
3. Turn on both the PC and TV.
4. Select the VGA input source on your TV by pressing either the SOURCE buttons on the remote control.

■ When connecting with a HDMI to DVI cable

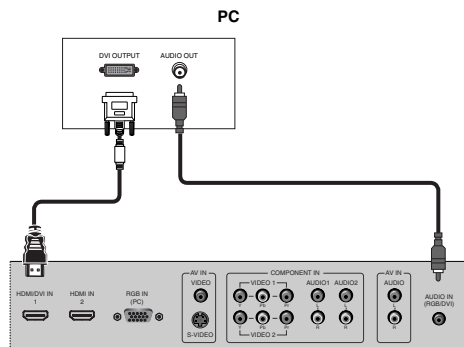

Back panel of the set

1. Connect the DVI Output on the PC to the HDMI / DVI IN1 Input jack on the TV.
2. Connect the PC Audio Output to the AUDIO IN (RGB/DVI) jack on the TV using a male-to-male 3.5mm mini jack.
3. Turn on both the PC and TV.
4. Select the HDMI1 input source on your TV by pressing either the SOURCE buttons on the remote control.

Resolution

Resolution	Horizontal Frequency (kHz)	Vertical Frequency (Hz)
640 x 480	31.47	59.94
800 x 600	35.16	56.25
	37.88	60.32
1024 x 768	48.36	60.00

NOTE

- a. The synchronization input form is separate.
- b. If the resolution is not supported, 'Not Support!' message will be displayed.

Basic Operation

Turning On or Off

Standby Setup: The AC power cord must be connected to have the TV in standby mode and ready to be turned on. Press the **ON/OFF** button on the front panel of the TV to go into standby mode.

1. If the TV is in standby mode, press the **POWER** button on the remote or the TV itself to turn the TV on.
2. Press the **POWER** button again on the remote controller or the TV itself to turn the TV off.

Channel Selection

You can select a channel number with the **CH+** / **CH-** button or NUMBER buttons.

Volume Adjustment

Press the **VOL+** / **VOL-** button to adjust the sound level.

Sound Mute

Press the **MUTE** button. The sound is switched off and the mute display appears.
To cancel mute mode, press the **MUTE** or **VOL+** / **VOL-** button again.

Quick View

Press the **<>** button to view the last channel you were watching.

Input Selection

1. Press the **SOURCE** button to change the input mode.
2. Press the **Down** or **Up** button to select your desired mode.
3. Press the **OK** button to change your selected mode.

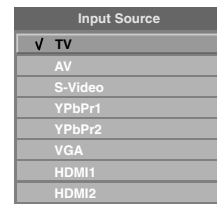

Language Selection

1. Press the **MENU** button and then press the **Down** or **Up** button to select the **Setup**.
2. Press the **OK** button and then press the **Down** or **Up** button to select **OSD Language**.
3. Press the **Left** or **Right** button to select your desired language. (Select between English, French, Spanish, German)
4. The on screen menu will then appear in the selected language.

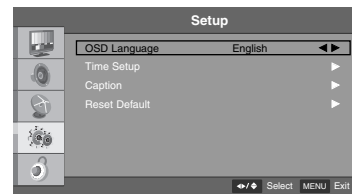

On Screen Menus

Your TV's OSD (On Screen Display) may differ slightly from what is shown in this manual.

1. Press the MENU button on enter the on-screen menu and then use either the Down or Up button to select each sub-menu.
2. Press the OK button and then use Down, Up, Left and Right buttons to navigate to the available menus.

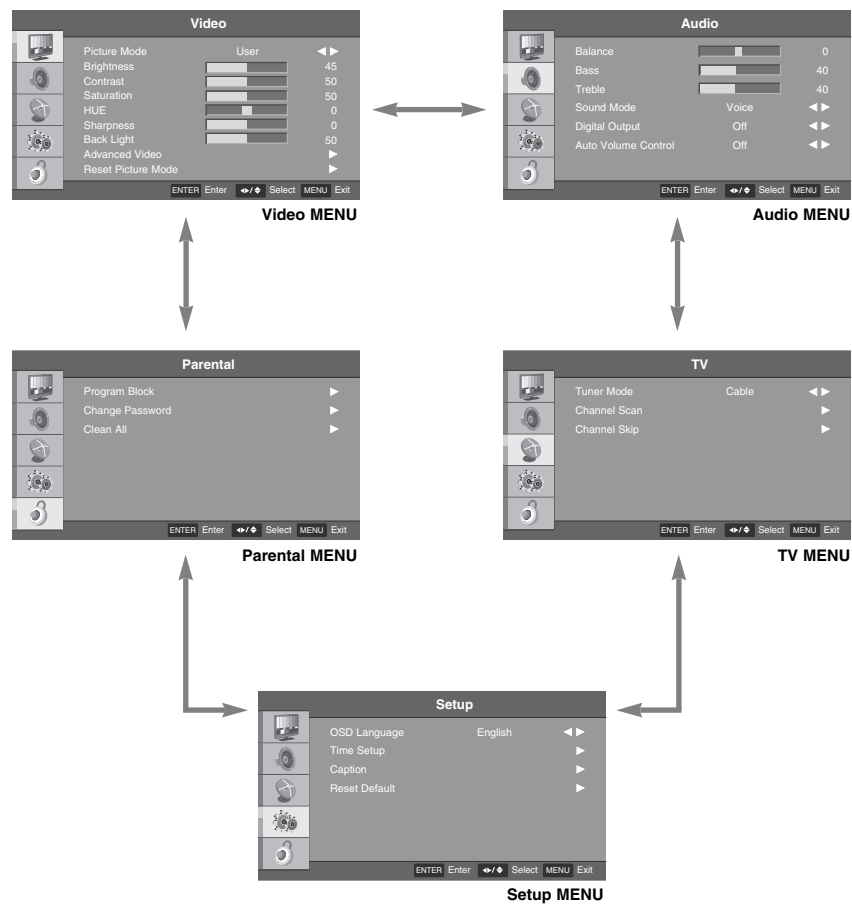

Setting up the TV Channels

Auto Scan

This function automatically finds all channels available through the Antenna or Cable and stores them in memory on the channel list.

1. Press the MENU button to enter the on-screen menu and then press either the Down or Up button to select the TV sub-menu.
2. Press the OK button to enter the sub-menu and then press either the Down or Up button to select Tuner Mode.
3. Press the Left or Right button to select either Antenna or Cable.
4. Press the Down or Up button to select Channel Scan.
5. Press the OK button to start the auto search.
The TV will begin memorizing all of the available channels.
6. Press the MENU button at any time to exit the channel scan process.
7. Once the channel scan is complete the channels found and recognized by the TV will be available for viewing.



Add / Delete a Channel

You can manually store or remove channels in whatever order you desire.

1. Press the MENU button to enter the on-screen menu and then press either the Down or Up button to select the TV sub-menu.
2. Press the OK button to enter the sub-menu and then press either the Down or Up button to select Channel Skip.
3. Press the OK button and then press the Down or Up button to select channel you want to add or delete. If you want to skip the selected channel, press the OK button to uncheck your selection.
4. All channels that have a check will be added to your viewing selection.
5. Press the MENU button to return to the previous menu.

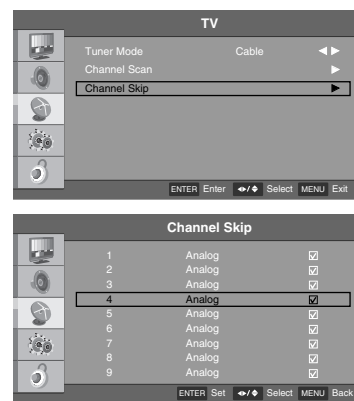

EPG (Electronic Program Guide)

Displays the broadcasting guide of the current digital channel.

1. Press the EPG button on the remote control to display the Electronic Program Guide.
2. Press the Left or Right button to change channel and display the broadcasting guide at the bottom of the screen.



Picture Controls

Adjusting The Picture Controls

The various Picture Modes allow you to adjust the display to your viewing preference.

1. Press the MENU button to enter the on-screen menu and then press either the Down or Up button to select the Video sub-menu.
2. Press the OK button to enter the sub-menu and then press either the Down or Up button to select Picture Mode.
3. Press the Left or Right button to select between Soft, Standard, Vivid or User Picture Modes.
4. Press the MENU button to return to the previous menu.

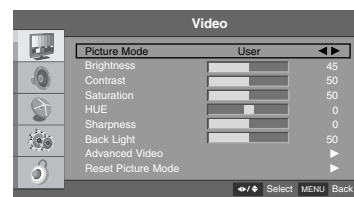

Soft

This mode will give you a soft feeling image.

Standard

This mode is the standard for viewing and falls between soft and vivid.

Vivid

This mode will display a more colorful, vibrant image.

User

This mode allows you to finely tune the display to your viewing preference.

NOTE

- If you want to select Picture Mode directly, press the PICTURE button.
- Every time you press the button, it will switch between Soft, Standard, Vivid or User.
- When you adjust the Brightness, Contrast, Saturation, HUE, Sharpness, or Back Light, it will be saved.
If you want to recall the default pressetting, run Reset Picture Mode.

Manual Picture Controls

This mode will allow you to fine-tune the display settings to your viewing preference.

1. Press the MENU button to enter the on-screen menu and then press either the Down or Up button to select the Video sub-menu.
2. Press the OK button to enter the sub-menu and use the Left or Right button to change the picture mode to User. Then, press either the Down or Up button to scroll to the desired picture option. (Brightness, Contrast, Saturation, HUE, Sharpness, Back Light)
3. Press the OK button and then use the Left or Right button to adjust the selection to your preference.
4. Press the MENU button to return to the previous menu.



Brightness

Increases or decreases amount of white in the your picture.

Contrast

Adjusts the amount of difference between the light and dark levels in the picture.

Saturation

Adjusts intensity of all colors.

HUE

Adjusts the balance between red and green levels.

Sharpness

Adjusts the level of sharpness in the edges between the light and dark areas of the picture.
The lower the level, the softer the image.

Back Light

Adjusts the brightness level of the back light.
Increasing the Back Light level will result in a brighter picture and is recommended for use brightly lit rooms, however, it will also decrease your black levels and result in a higher power consumption.

Reset Picture Mode

When changing your settings, you can select the Reset Picture Mode option to restore the previous settings.

1. Press the MENU button to enter the on-screen menu and then press either the Down or Up button to select the Video sub-menu.
2. Press the OK button to enter the sub-menu and use the up or down buttons to select Reset Picture mode.
3. Once the confirmation window appears, press OK to restore the previous settings.

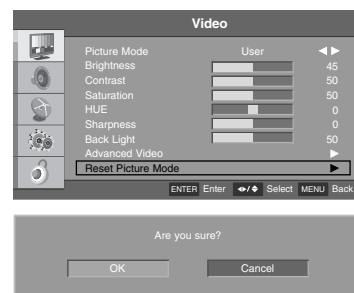

Advanced Video

Dynamic Noise Reduction

Use this feature to reduce the amount of noise, or film grain, that may be present in the picture.

1. Press the MENU button to enter the on-screen menu and then press either the Down or Up button to select the Video sub-menu.
2. Press the OK button to enter the sub-menu and then press either the Down or Up button to select Advanced Video.
3. Press the OK button to enter the submenu and then press the Down or Up button to select DNR.
4. Press the Left or Right button to select between Off, Low, Medium, Strong or Auto.
5. Press the MENU button to return to the previous menu.

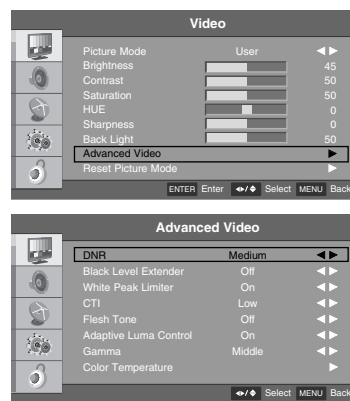

Off
Turns the screen noise reduction function off.

Low
Reduces screen noise at a low level.

Medium
Reduces screen noise at a medium level.

Strong
Reduces screen noise at a high level.

Auto
Automatically adjusts the noise reduction level according to received signal.

Black Level Extender

This feature increases the image reproduction performance in the dark areas of the picture.

1. Press the MENU button to enter the on-screen menu and then press either the Down or Up button to select the Video sub-menu.
2. Press the OK button to enter the sub-menu and then press either the Down or Up button to select Advanced Video.
3. Press the OK button and then press the Down or Up button to select Black Level Extender.
4. Press the Left or Right button to select On or Off.
5. Press the MENU button to return to the previous menu.

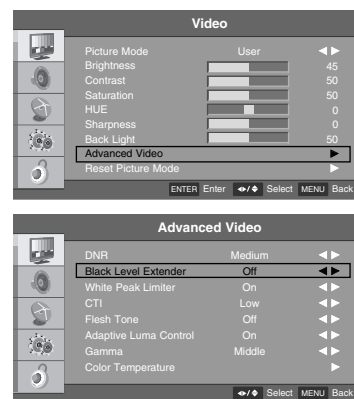

White Peak Limiter

This feature limits excessive amounts of white in bright areas of the picture. Excessive amounts of white is caused by a lower sync level from a channel being received from the antenna or cable.

1. Press the MENU button to enter the on-screen menu and then press either the Down or Up button to select the Video sub-menu.
2. Press the OK button to enter the sub-menu and then press either the Down or Up button to select Advanced Video.
3. Press the OK button and then press the Down or Up button to select White Peak Limiter.
4. Press the Left or Right button to select On or Off.
5. Press the MENU button to return to the previous menu.

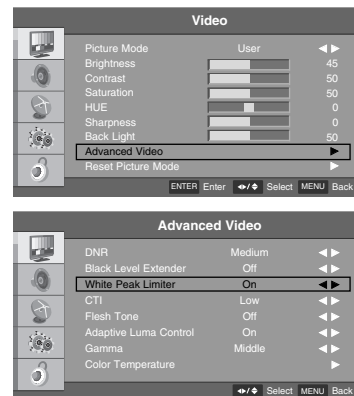

CTI (Color Transient Intensity)

This feature is used to reduce the time the display takes to transition from one color to another. The effect of CTI will be seen as sharpening the border between colors.

1. Press the MENU button to enter the on-screen menu and then press either the Down or Up button to select the Video sub-menu.
2. Press the OK button to enter the sub-menu and then press either the Down or Up button to select Advanced Video.
3. Press the OK button and then press the Down or Up button to select CTI.
4. Press the Left or Right button to select between Off, Low, Medium or Strong.
5. Press the MENU button to return to the previous menu.

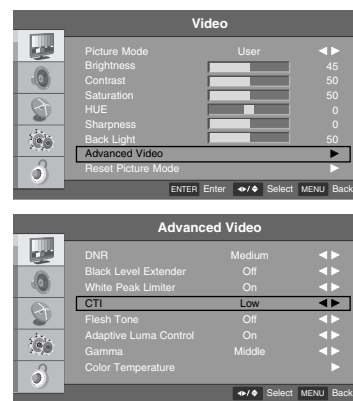

Flesh Tone

In some cases, activation of this feature can result in a more pleasing display of sky and flesh colors.

1. Press the MENU button to enter the on-screen menu and then press either the Down or Up button to select the Video sub-menu.
2. Press the OK button to enter the sub-menu and then press either the Down or Up button to select Advanced Video.
3. Press the OK button and then press the Down or Up button to select Flesh Tone.
4. Press the Left or Right button to select On or Off.
5. Press the MENU button to return to the previous menu.

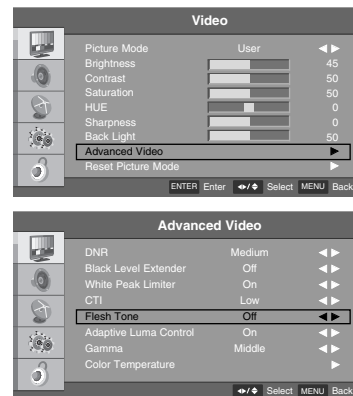

Adaptive Luma Control

Large amounts of dark areas present in a picture will result in a lower Average Picture Level (APL) and the overall picture will look too dark; activation of this feature will raise the APL to counteract this effect.

1. Press the MENU button to enter the on-screen menu and then press either the Down or Up button to select the Video sub-menu.
2. Press the OK button to enter the sub-menu and then press either the Down or Up button to select Advanced Video.
3. Press the OK button and then press the Down or Up button to select Adaptive Luma Control.
4. Press the Left or Right button to select On or Off.
5. Press the MENU button to return to the previous menu.

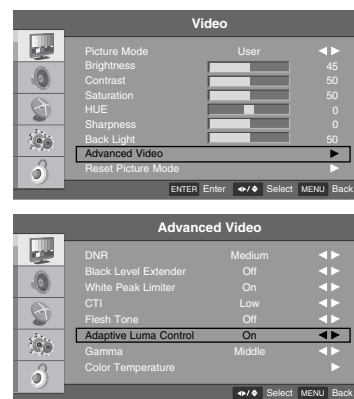

Gamma

This feature will allow you to adjust the brightness curve for the display.

1. Press the MENU button to enter the on-screen menu and then press either the Down or Up button to select the Video sub-menu.
2. Press the OK button to enter the sub-menu and then press either the Down or Up button to select Advanced Video.
3. Press the OK button and then press the Down or Up button to select Gamma.
4. Press the Left or Right button to select between Low, Middle or High.
5. Press the MENU button to return to the previous menu.

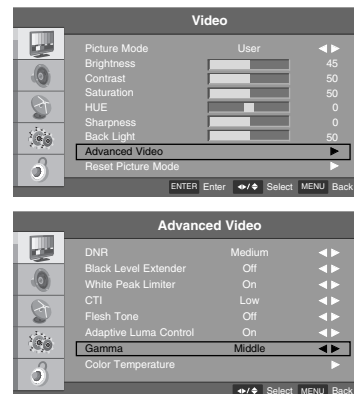

Color Temperature

The Color Temperature settings will allow you to adjust the lighting in the display to compliment your viewing preference.

The Cool setting will add more Blues and Greens into the image to give it a “cooler” feeling.

The Warm setting will add more Reds and Yellows into the image to give it a “warmer” feeling.

The Standard setting will be a more natural feeling and will fall between the Cool and Warm settings.

1. Press the MENU button to enter the on-screen menu and then press either the Down or Up button to select the Video sub-menu.
2. Press the OK button to enter the sub-menu and then press either the Down or Up button to select and enter into the Advanced Video submenu.
3. Navigate to and select Color Temperature.
Press the OK button and then press the Left or Right button to select between Cool, Standard, Warm or User settings.
4. If you selected the User setting, press the Down or Up button to select desired color option you wish to adjust.
5. Press the OK button and then use the Left or Right button to make appropriate adjustments.
6. Press the MENU button to return to the previous menu.

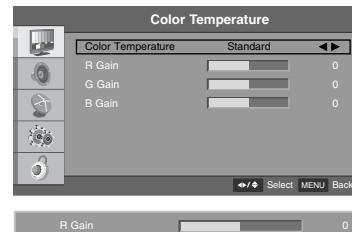
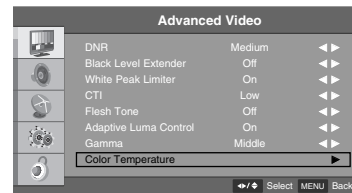

NOTE

- To adjust manually Color Temperature on your display, change the Color Temperature Mode to User.

Sound Controls

Adjusting The Sound Controls

The Sound Mode preset selection will allow you to adjust the sound to your listening preference.

1. Press the MENU button to enter the on-screen menu and then press either the Down or Up button to select the Audio sub-menu.
2. Press the OK button to enter the sub-menu and then press either the Down or Up button to select Sound Mode.
3. Press the Left or Right button to select between Voice, Concert, Jazz or User Modes.
4. Press the MENU button to return to the previous menu.

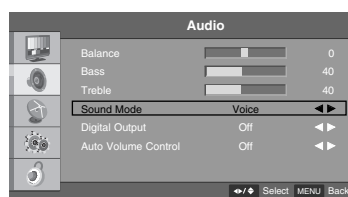

Voice

Select this option while watching a show that is mostly dialog.

Concert

Select this option to when listening to music to enjoy the original intended sound.

Jazz

This option highlights bass and also emphasizes instruments such as piano and guitar.

User

Select this option to manually adjust the audio settings to your preference.

NOTE

- To scroll through the different sound modes without entering the on-screen menus, press the SOUND button on the remote control.
- When you adjust manually the Bass or Treble, the Sound Mode will change to User Mode.

Manual Sound Controls

This function allows you to manually adjust the individual audio settings to your preferred levels.

1. Press the MENU button to enter the on-screen menu and then press either the Down or Up button to select the Audio sub-menu.
2. Press the OK button to enter the sub-menu and then press either the Down or Up button to select the desired sound option.(Bass, Treble, Balance)
3. Press the OK button to select the sound option that you wish to change and then press either the Left or Right button to make appropriate adjustments.
4. Press the MENU button to return to the previous menu.



Bass

This adjusts the presence of the lower frequency audio.

Treble

This adjusts the presence of the higher frequency audio.

Balance

Adjusts the left to right sound balance between the built-in speakers.

Digital Output

This option activates the Digital Audio Output. This is recommended for use with other devices capable of receiving digital audio signals. (This mode is set to Off by default)

1. Press the MENU button to enter the on-screen menu and then press either the Down or Up button to select the Audio sub-menu.
2. Press the OK button to enter the sub-menu and then press either the Down or Up button to select Digital Output.
3. Press the Left or Right button to select between Off, Dolby Digital or PCM.
4. Press the MENU button to return to the previous menu.



Off

Television will only output an Analog audio signal.
(This mode is set to Off by default)

Dolby Digital

Television will output a digital audio signal.

PCM (Pulse-code modulation)

This mode creates a digital representation of an analog signal and is only used with an audio CD signal.



Manufactured under license from
Dolby Laboratories.
"Dolby" and the double-D symbol
are trademarks of Dolby
Laboratories.

Auto Volume Control

This function automatically stabilizes the volume level while changing to channels with different audio levels.

1. Press the MENU button to enter the on-screen menu and then press either the Down or Up button to select the Audio sub-menu.
2. Press the OK button to enter the sub-menu and then press either the Down or Up button to select Auto Volume Control.
3. Press the Left or Right button to select On or Off.
4. Press the MENU button to return to the previous menu.



Stereo/SAP Broadcast Setup

This TV can receive MTS stereo programs and any SAP (Secondary Audio Program) that the station may transmit.

The television will automatically switch to Mono sound if the broadcasted channel is transmitted in Mono.

Also, you can manually select Mono if you want to listen to a stereo or SAP broadcasted channel in Mono by pressing the MTS button on the remote control.

1. Press the MTS button on the remote control to scroll through the Mono, Stereo and SAP sound modes.
If other languages are available on a digital signal, they can also be selected using the MTS button.
2. Press the EXIT button to save your settings and return to TV viewing.

Time Setting

Time Zone Settings

This mode allows you to set the Time Zone for your local area.

1. Press the MENU button to enter the on-screen menu and then press either the Down or Up button in order to select the Setup sub-menu.
2. Press the OK button to enter the submenu and then press either the Down or Up button in order to select Time Setup.
3. Press the OK button and then press the Down or Up button to select Time Zone.
4. Use the Left or Right button to select your viewing area's time zone. (Select between: Eastern Time, Indiana, Central Time, Mountain Time, Arizona, Pacific Time, Alaska, Hawaii)
5. Press the MENU button to return to the previous menu.

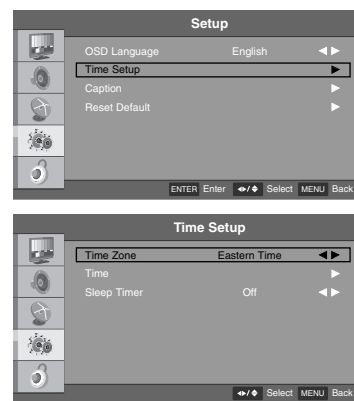

Auto Time Settings

The Auto Time Setting receives the current time from an available digital channel. The digital channel signal includes information for the current time provided by the broadcasting station.

1. Press the MENU button to enter the on-screen menu and then press either the Down or Up button in order to select the Setup sub-menu.
2. Press the OK button to enter the submenu and then press either the Down or Up button in order to select Time Setup.
3. Press the OK button and then press the Down or Up button to select Time.
4. Press the OK button and then press the Down or Up button to select Auto Synchronization.
5. Press the Left or Right button to switch between On or Off.
6. Press the MENU button to return to the previous menu.



NOTE

- If Auto Synchronization is On, the Date and Time menus cannot be adjusted.
- Set the time manually if the current time is incorrect using the Auto Synchronization function.

Manual Time Settings

If the current time setting is wrong when using the Auto Synchronization function, this setting allows you to set the clock manually.

1. Press the MENU button to enter the on-screen menu and then press either the Down or Up button in order to select the Setup sub-menu.
2. Press the OK button to enter the submenu and then press either the Down or Up button in order to select Time Setup.
3. Press the OK button and then press the Down or Up button to select Time.
4. Press the OK button and then press the Down or Up button to select Auto Synchronization.
5. Press the Left or Right button to turn Auto Synchronization Off.
6. Press the Down or Up button to select Date or Time.
7. Use the Left or Right button to select the variable that you want to change and use number buttons to enter the date or time.
8. Press the MENU button to return to the previous menu.

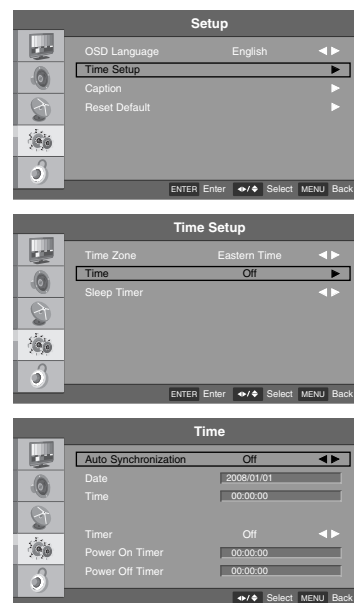

Auto On /Off Time Settings

The timer function will only operate when the current time has been set.
This function automatically turns the TV On and Off at the specific time you designate.

1. Press the MENU button to enter the on-screen menu and then press either the Down or Up button in order to select the Setup sub-menu.
2. Press the OK button to enter the submenu and then press either the Down or Up button in order to select Time Setup.
3. Press the OK button and then press the Down or Up button to select Time.
4. Press the OK button and then press the Down or Up button to select Timer.
5. Press the Left or Right button to select On.
If Timer is selected to Off, Power On Timer and Power Off Timer menu are cannot be adjusted.
6. Press the Down or Up button to select Power On Timer or Power Off Timer.
7. Press the Left or Right button to move to the desired variable and use number buttons to set time.
8. Press the MENU button to return to the previous menu.

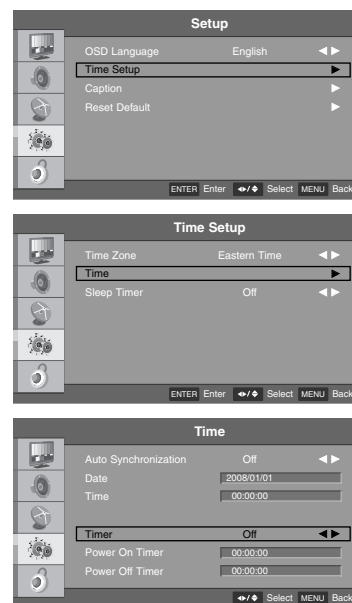

Sleep Timer

The sleep timer automatically switches the set to standby after the preset time elapses.

1. Press the MENU button to enter the on-screen menu and then press either the Down or Up button in order to select the Setup sub-menu.
2. Press the OK button to enter the submenu and then press either the Down or Up button in order to select Time Setup.
3. Press the OK button and then press the Down or Up button to select Sleep Timer.
4. Press the Left or Right button to select desired sleep time.
The timer begins to count down from the number of minutes selected and will switch the unit to standby when the time runs out.
5. Press the MENU button to return to the previous menu.

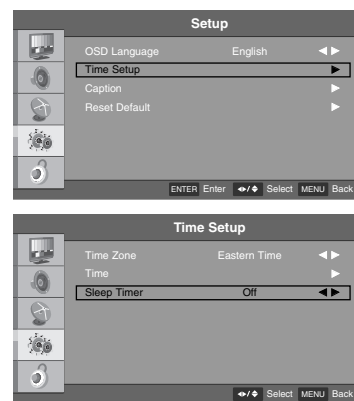

NOTE

- If you want to select directly select the sleep timer without entering the menus, press the SLEEP button on the remote control.
- Every time you press the button, it will switch between Off, 5, 10, 15, 30, 45, 60, 90, 120, 180 and 240.

Captions

Closed Caption - Analog

The Analog Caption function operates when watching a regular analog channel.

1. Press the MENU button to enter the on-screen menu and then press either the Down or Up button in order to select the Setup sub-menu.
2. Press the OK button to enter the submenu and then press either the Down or Up button in order to select Caption.
3. Press the OK button and then press the Down or Up button to select Analog Closed Caption.
4. Press the Left or Right button to select between Off, CC1, CC2, CC3, CC4, TEXT1, TEXT2, TEXT3 or TEXT4.
5. Press the MENU button to return to the previous menu.

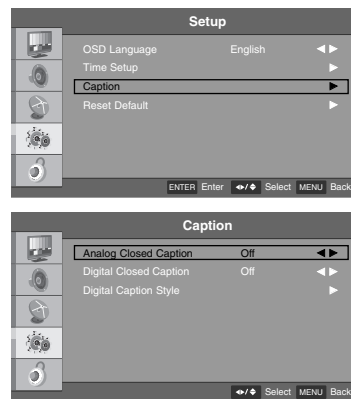

Caption

The term for the words that scroll across the bottom of the TV screen; usually the audio portion of the program provided for the hearing impaired.

TEXT

The term for the words that appear in a large black-frame and almost cover the entire screen; usually messages provided by the broadcaster.

NOTE

- If you want to select directly the Closed Captions, press the CC button on the remote control.

Closed Caption - Digital

The Digital Caption function only operates on digital channels.

1. Press the MENU button to enter the on-screen menu and then press either the Down or Up button in order to select the Setup sub-menu.
2. Press the OK button to enter the submenu and then press either the Down or Up button in order to select Caption.
3. Press the OK button and then press the Down or Up button to select Digital Closed Caption.
4. Press the Left or Right button to select between Off, SERVICE1, SERVICE2, SERVICE3, SERVICE4, SERVICE5 or SERVICE6.
5. Press the MENU button to return to the previous menu.

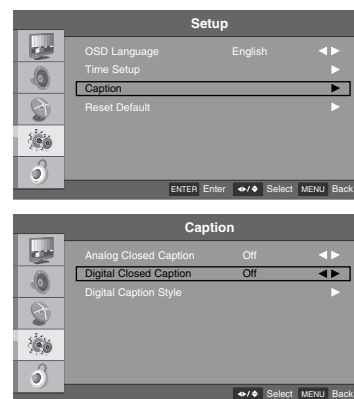

Digital Closed Caption Options

Customize the DTV captions that appear on your screen.

1. Press the MENU button to enter the on-screen menu and then press either the Down or Up button in order to select the Setup sub-menu.
2. Press the OK button to enter the submenu and then press either the Down or Up button in order to select Caption.
3. Press the OK button and then press the Down or Up button to select Digital Caption Style.
4. Press the OK button and then press the Down or Up button to select Caption Style.
5. Press the Left or Right button to select Custom.
6. Press the Down or Up button to select desired caption option you wish to change. (Select between: Font Size, Font Color, Font Opacity, Background Color, Background Opacity, Window Color, Window Opacity)
7. Press the Left or Right button to customize your selected preference.
8. Press the MENU button to return to the previous menu.



Font Size

Set the size in which the captions will appear in.

Font Color

Set the color in which the captions will appear in.

Font Opacity

Select the transparency for the captions.

Background Color

Select a background color for the captions.

Background Opacity

Select the transparency for the background.

Window Color

Select a color for the edges.

Window Opacity

Select the transparency for the edges.

NOTE

- If the Caption Style is selected to "As Broadcaster", the Caption Options cannot be adjusted.

Reset

Reset Default

This function returns all of the menu selections back to their original factory preset values. This function removes all TV channels from memory. Channels must be scanned for again after resetting to the unit to factory defaults.

1. Press the MENU button to enter the on-screen menu and then press either the Down or Up button in order to select the Setup sub-menu.
2. Press the OK button to enter the submenu and then press either the Down or Up button in order to select Reset Default.
3. Press the OK button and then press the Left or Right button to highlight the OK button.
4. Press the OK button on the remote control to reset all settings.
5. Press the MENU button to return to the previous menu.



Parental Control

Entering your password

Parental Control can be used to block specific channels, ratings and other viewing sources.

The default password of 0-0-0-0 is required to gain access to this menu.

1. Press the MENU button to enter the on-screen menu and then press either the Down or Up button in order to select the Parental sub-menu.
2. Press the OK button and then enter the default password as requested.
3. The TV is set up with the initial password of "0-0-0-0".

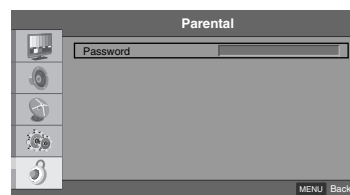

Set Password

This option will allow you to input a new password of your choice.

1. After entering the parental sub-menu, press the Down or Up button to select Change Password.
2. Press the OK button and then select any 4 digits for your new password and enter them in the New Password section.
3. As soon as the 4 digits are entered, re-enter the same 4 digits on the Confirm Password to finalize your selection.
4. Your new password has now been memorized.
5. Press the MENU button to return to the previous menu.



NOTE

- Write down your new password and keep it somewhere safe for the case of forgetting it in the future.

Ratings - Enable / Disable

Enables or disables a parental blocking scheme.

1. After entering the Parental sub-menu, press the Down or Up button to choose Program Block.
2. Press the OK button and then press the Down or Up button to select Rating Enable.
3. Press the Left or Right button to select On or Off. When you select On, the Program Block options are enabled.
4. Press the MENU button to return to the previous menu or scroll down to edit a Program Block option.



TV Ratings for USA

This rating system has been established to help you monitor and block the types of programs viewed on TV. Ratings with a lock next to them will be blocked from being viewed.

1. After entering the Parental sub-menu, press the Down or Up button to choose Program Block.
2. Press the OK button and then press either the Down or Up button to select U.S.TV Ratings.
3. Press the OK button to enter the sub-menu.
4. Use the Down, Up, Left or Right buttons to highlight the selection you wish to block and press the OK button to block that selection.
(Note:See rating descriptions on the next page.)
5. Press the MENU button to return to the previous menu.



TV (FCC) Age Categories

This rating system has been established to help you monitor and block the types of programs viewed on TV. Ratings with a lock next to them will be blocked from being viewed.

TV-MA

Mature audiences only.
This program may contain mature themes, profane language, graphic violence and explicit sexual content.

TV-14

Parents strongly cautioned.
This program may contain sophisticated themes, sexual content, strong language and more intense violence.

TV-PG

Parental guidance suggested.
The program may contain infrequent coarse language, limited violence, some suggestive sexual dialog and situations.

TV-G

General audience.
This contains little or no violence, no strong language, and little or no sexual dialog or situations.

TV-Y7

Directed for older children.
Themes and elements in this program may include mild physical or comedic violence, or may frighten children under the age of seven.

TV-Y

All children.
The themes and elements in this program are specifically designed for a very young audience, including children from ages two – six.

TV (FCC) Age Categories

- D:** Dialog...sexual innuendo.
- L:** Offensive language.
- S:** Sexual Situation
- V:** Violence.
- FV:** Fantasy or cartoon violence.

Movie Ratings

This rating system has been established to help you monitor and block the types of movies viewed. These ratings apply to movies broadcasted on TV and allows you to select which ratings you want blocked.

1. After entering the Parental sub-menu, press the Down or Up button to choose Program Block.
2. Press the OK button and then press either the Down or Up button to select U.S. Movie Ratings.
3. Press the OK button to enter the submenu.
4. Press the Down or Up buttons to choose the rating you wish to block and press the OK button to block that selection. (See rating descriptions below)
5. Press the MENU button to return to the previous menu.

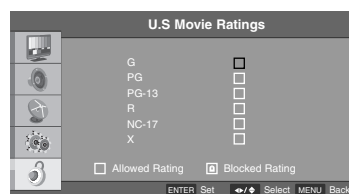
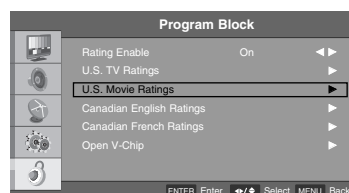
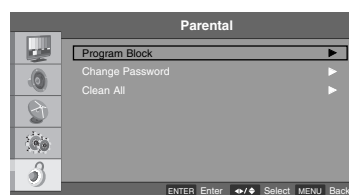

The MPAA Rating System (Movies)

G
General Audience.

PG
Parental guidance suggested.

PG-13
Parents strongly cautioned.

R
Restricted.

NC-17
No one 17 and under admitted.

X
Adults only.

NOTE

- If you block PG-13, G and PG movies will be available, PG-13, R, NC-17 and X will be blocked.

English TV Ratings for Canada

This rating system has been established to help you monitor and block the types of programs viewed on TV. Ratings with a lock next to them will be blocked from being viewed.

1. After entering the Parental sub-menu, press the Down or Up button to choose Program Block.
2. Press the OK button and then press the Down or Up button to select Canadian English Ratings.
3. Press the OK button to enter the sub-menu.
4. Press the Down or Up buttons to choose the selection you wish to block and press the OK button on the remote to block it. (See rating descriptions below)
5. Press the MENU button to return to the previous menu.

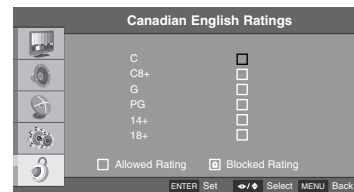
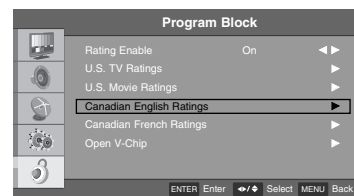
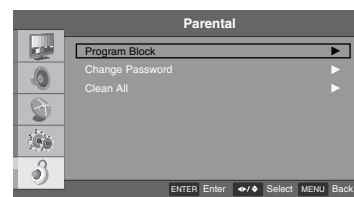

Canadian English Ratings

C

Children

CB+

Children eight years and older

G

General programming, suitable for all audiences

PG

Parental Guidance

14+

Viewers 14 years and older

18+

Adult programming

French TV Ratings for Canada

This rating system has been established to help you monitor and block the types of programs viewed on TV. Ratings with a lock next to them will be blocked from being viewed.

1. After entering the Parental sub-menu, press the Down or Up button to choose Program Block.
2. Press the OK button and then press the Down or Up button to select Canadian French Ratings.
3. Press the OK button to enter the sub-menu.
4. Press the Down or Up buttons to choose the selection you wish to block and press the OK button on the remote to block it. (See rating descriptions below)
5. Press the MENU button to return to the previous menu.

Canadian French Ratings

G
General

8 ans+
General-Not convenient for little children

13 ans+
Not convenient for children of 13 years and younger

16 ans+
Not convenient for children of 16 years and younger

18 ans+
This programs is only for adult

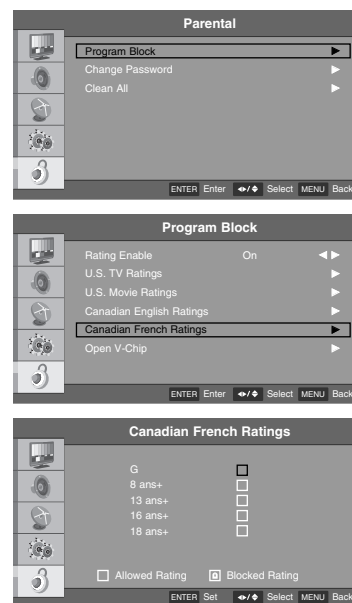

Downloadable Rating

Your TV's OSD (On Screen Display) may differ slightly from what is shown in this manual.

1. After entering the Parental sub-menu, press the Down or Up button to choose Program Block.
2. Press the OK button and then press the Down or Up button to select Open V-Chip.
3. Press the OK button twice.
4. Press the Down or Up buttons to choose the menu options for Open V-Chip.
5. Press the OK button to make your selection.
6. Press the MENU button to return to the previous menu.

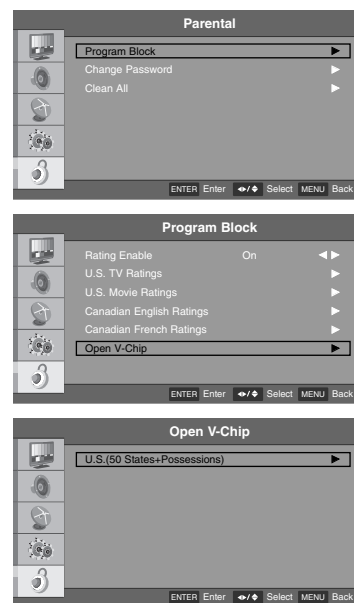

Clean All

This function cleans and resets all current parental block settings.

1. After entering the Parental sub-menu, press the Down or Up button to choose Clean All.
2. Press the OK button on the remote control to select Clean All and then press the Left or Right button to select OK button.
3. Press the OK button to clean and reset the Program Block menu options.
4. Press the MENU button to return to the previous menu.

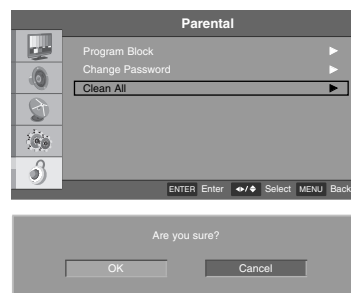

Setting the PC Mode

Adjusting The Picture Controls

The various Picture Modes allow you to adjust the display to your viewing preference.

1. Press the MENU button to enter the on-screen menu and then press either the Down or Up button to select the Video sub-menu.
2. Press the OK button to enter the sub-menu and then press either the Down or Up button to select Picture Mode.
3. Press the Left or Right button to select between Soft, Standard, Vivid or User Picture Modes.
4. Press the MENU button to return to the previous menu.

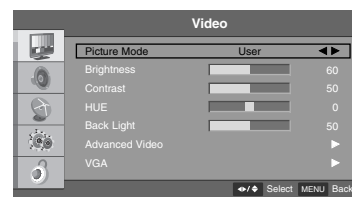

Soft

This mode will give you a soft feeling image.

Standard

This mode is the standard for viewing and falls between soft and vivid.

Vivid

This mode will display a more colorful, vibrant image.

User

This mode allows you to finely tune the display to your viewing preference.

NOTE

- Select the VGA mode by pressing either the SOURCE button.
- If you want to scroll through the various picture modes without entering the on-screen menus, press the PICTURE button on the remote control.
- When you adjust Brightness, Contrast, HUE, or Back Light, it will be saved. If you want to recall the default preset, go to setup menu and run reset default.

Manual Picture Controls

This mode will allow you to fine-tune the display settings to your viewing preference.

1. Press the MENU button to enter the on-screen menu and then press either the Down or Up button to select the Video sub-menu.
2. Press the OK button to enter the sub-menu and use the Left or Right button to change the picture mode to User. Then, press either the Down or Up button to scroll to the desired picture option. (Brightness, Contrast, HUE and Back Light)
3. Press the OK button and then use the Left or Right button to adjust the selection to your preference.
4. Press the MENU button to return to the previous menu.

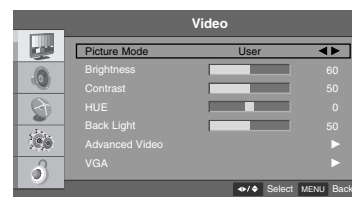

Brightness

Increases or decreases amount of white in the your picture.

Contrast

Adjusts the amount of difference between the light and dark levels in the picture.

HUE

Adjusts the balance between red and green levels.

Back Light

Adjusts the brightness level of the back light. Increasing the Back Light level will result in a brighter picture and is recommended for use brightly lit rooms, however, it will also decrease your black levels and result in a higher power consumption.

NOTE

- Select the VGA mode by pressing either the SOURCE button.
-

Color Temperature

The Color Temperature settings will allow you to adjust the lighting in the display to compliment your viewing preference.

The Cool setting will add more Blues and Greens into the image to give it a “cooler ” feeling.

The Warm setting will add more Reds and Yellows into the image to give it a “warmer ” feeling.

The Standard setting will be a more natural feeling and will fall between the Cool and Warm settings.

1. Press the MENU button to enter the on-screen menu and then press either the Down or Up button to select the Video sub-menu.
2. Press the OK button to enter the sub-menu and then use the Down or Up button to select the Advanced Video Submenu.
3. Press the OK button to enter the sub-menu and then press either the Down or Up button to select Color Temperature.
4. Press the OK button and then press the Left or Right button to select between Cool, Standard, Warm or User settings.
5. If you selected the User setting,press the Down or Up button to select desired color option you wish to adjust.
6. Press the OK button and then use the Left or Right button to make appropriate adjustments.
7. Press the MENU button to return to the previous menu.



NOTE

- To adjust Color Temperature on your display, change the Color Temperature to User.

Automatic Screen Adjustment

This function automatically adjusts the screen position, clock, phase and scale in pc mode.

The displayed image will disappear for a few seconds while the auto configuration is in progress. If the result of the automatic adjustment is not correct, you can manually adjust the settings to fit your viewing preference.

1. Press the MENU button to enter the on-screen menu and then press either the Down or Up button to select the Video sub-menu.
2. Press the OK button to enter the sub-menu and then press either the Down or Up button to select VGA.
3. Press the OK button and then use the Down or Up button to select Auto Adjust.
4. Press the OK button to start the auto adjustment.
5. If the result of the automatic adjustment is not correct, you can manually adjust the settings to fit your viewing preference. (See the next page for manual adjustment settings.)

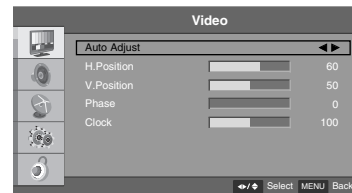

Manual Screen Adjustment

If the result of the automatic adjustment is not correct, you can manually adjust the settings to fit your viewing preference.

1. Press the MENU button to enter the on-screen menu and then press either the Down or Up button to select the Video sub-menu.
2. Press the OK button to enter the sub-menu and then press either the Down or Up button to select VGA.
3. Press the OK button and then press the Down or Up button to select video option you wish to change.
4. Press the OK button and then press the Left or Right button to make appropriate adjustments.
5. Press the MENU button to return to the previous menu.



H.Position

This function is used to adjust the horizontal position of the display.

V.Position

This function is used to adjust the vertical position of the display.

Phase

This function allows you to remove any horizontal noise or lines in the image and also help sharpen text.

Clock

This function minimizes any vertical bars or stripes visible on the screen. This setting will also adjust the horizontal screen size.

Special Functions

Picture Format

You can watch the screen in various picture formats; 4:3, ZOOM, Auto, Normal.
To scroll through the various picture formats, press the ZOOM button on the remote control.

Below are descriptions of the available picture formats.

- **4:3**
This selection will display the image in a 4:3 size ratio. This mode will place black or greybars on the left and right sides of the image. This mode is recommended for viewing content displayed in the 4:3 size ratio to prevent stretching or distortion of the image.
- **ZOOM**
This selection is used to fill the entire screen with the image so no black bars appear; however, some trimming of the image may occur.
- **Auto**
This mode is designed to match the picture format on the TV with the picture format of the received content.
- **Normal**
This selection will display the image in a 16:9 size ratio. This mode is recommended for viewing content that is displayed in 16:9, or widescreen, format. Content that is originally delivered in 4:3 content and is viewed in 16:9 mode will be stretched to fit to the left and right sides of the display.
- **Just Scan**
This mode will apply dot-by-dot mode when using an HDMI connection.

NOTE -----

- You can only select 4:3, Zoom, Auto and Normal in 480p and below.
 - You can only select 4:3 and Normal in 720p and above.
 - You can only select 4:3 and Normal in VGA mode.
 - You can only select 4:3, Normal and Just Scan in HDMI 720p, 1080i and 1080p.
-

Specification

Model		HLD-320TB
Dimension (Width x Hight x Depth)	Without Stand	794.5mm (31.28") x 512.0mm (20.16") x 99.5mm (3.92")
	With Stand	794.5mm (31.28") x 573.0mm (22.56") x 228mm (8.98")
Weight (kg / lbs)	Without Stand	11.8 kg (26.01 lbs)
	With Stand	13.3 kg (29.32 lbs)
Broadcast Signal System		ATSC / NTSC
Receiving Channel		Air : 2 ~ 69, Cable : 1 ~ 135
Contrast Ratio		1,000:1
Brightness		500 cd/m ²
Panel Resolution		1366 (H) x 768 (V)
Power Rating		AC100-240V ~50/60Hz
Consumption		130W
Audio Output		10W + 10W
Operating Temperature		0°C ~ 40°C
Accessories		<ul style="list-style-type: none"> • Batteries • Power Cord • 220V Adaptor Plug • Owner's Manual • Remote • Front Cover
External Port		<ul style="list-style-type: none"> • 2 x HDMI • RGB IN(PC) • 2 x COMPONENT IN • S-VIDEO IN • AV IN • AUDIO IN (RGB / DVI) • ANTENNA / CABLE IN • DIGITAL AUDIO OUT (COAXIAL) • AC IN

• The Specification shown above may be changed without prior notice for quality important.

Troubleshooting

Problem	Solution
No picture on screen.	<ul style="list-style-type: none">• Check whether the set is turned on.• Make sure the power cord is plugged into the wall.• Test if there is power coming from the wall outlet by plugging in another product into the same wall outlet where the set's power cord was plugged in.
The remote control doesn't work.	<ul style="list-style-type: none">• Check to see if there is any object between the set and the remote control causing obstruction.• Check to see if the batteries are installed with the correct polarities.• Install new batteries.
Picture appears slowly, after switching on.	<ul style="list-style-type: none">• This is normal as the image is muted during the start up process of the set. Please contact your service center, if the picture has not appeared after five minutes.
No or Poor color	<ul style="list-style-type: none">• Select color in the Picture menu and press the Left or Right button.
Horizontal/Vertical bars or picture shaking	<ul style="list-style-type: none">• Check for local interference such as a nearby electrical appliance or power tool.
Unusual sound from inside the set.	<ul style="list-style-type: none">• A change in ambient humidity or temperature may result in an unusual noise at the time of switching off or on of the set and does not indicate a fault with the set.

CHILD SAFETY:

It Makes A Difference How and Where
You Use Your Flat Panel Display

Congratulations on your purchase! As you enjoy your new product, please keep these safety tips in mind:



THE ISSUE

- The home theater entertainment experience is a growing trend and larger flat panel displays are popular purchases. However, flat panel displays are not always supported on the proper stands or installed according to the manufacturer's recommendations.
- Flat panel displays that are inappropriately situated on dressers, bookcases, shelves, desks, speakers, chests or carts may fall over and cause injury.

THIS MANUFACTURER CARES!

- The consumer electronics industry is committed to making home entertainment enjoyable and safe.

TUNE INTO SAFETY

- One size does NOT fit all. Follow the manufacturer's recommendations for the safe installation and use of your flat panel display.
- Carefully read and understand all enclosed instructions for proper use of this product.
- Don't allow children to climb on or play with furniture and television sets.
- Don't place flat panel displays on furniture that can easily be used as steps, such as a chest of drawers.
- Remember that children can become excited while watching a program, especially on a "larger than life" flat panel display. Care should be taken to place or install the display where it cannot be pushed, pulled over, or knocked down.
- Care should be taken to route all cords and cables connected to the flat panel display so that they cannot be pulled or grabbed by curious children.

WALL MOUNTING: IF YOU DECIDE TO WALL MOUNT YOUR FLAT PANEL DISPLAY, ALWAYS:

- Use a mount that has been recommended by the display manufacturer and/or listed by an independent laboratory (such as UL, CSA, ETL).
- Follow all instructions supplied by the display and wall mount manufacturers.
- If you have any doubts about your ability to safely install your flat panel display, contact your retailer about professional installation.
- Make sure that the wall where you are mounting the display is appropriate. Some wall mounts are not designed to be mounted to walls with steel studs or old cinder block construction. If you are unsure, contact a professional installer.
- A minimum of two people are required for installation. Flat panel displays can be heavy.



 **CEA**
Consumer Electronics Association
www.CE.org/safety

|HCT|
LIMITED WARRANTY

HCT will repair or at its option, replace without charge, your product which proves to be defective in material or workmanship under normal use, during the warranty period listed below from the date of original purchase.

MODEL No.

Warranty Period

1 Year

No other expressed warranty is applicable to this product.

THE DURATION OF ANY IMPLIED WARRANTIES, INCLUDING THE IMPLIED WARRANTY OF MERCHANTABILITY, IS LIMITED TO THE DURATION OF THE EXPRESSED WARRANTY HEREIN. HCT SHALL NOT BE LIABLE FOR THE LOSS OF THE USE OF THE PRODUCT, INCONVENIENCE, LOSS OR ANY OTHER DAMAGE DIRECT OR CONSEQUENTIAL ARISING OUT OF THE USE OF OR INABILITY TO USE, THIS PRODUCT OR FOR ANY BREACH OF ANY EXPRESSED OR IMPLIED WARRANTY, INCLUDING THE IMPLIED WARRANTY OF MERCHANTABILITY APPLICABLE TO THIS PRODUCT.

Some states do not allow the exclusion or limitation of incidental consequential damage or limitations on how long an implied warranty lasts; so these limitations or exclusions may not apply to you.

This warranty gives you specific legal right and you may also have other rights which vary from state to state.

THE ABOVE WARRANTY DOES NOT APPLY:

- Products which have been subject to abuse, accident, alteration, modification, tampering, negligence, misuse, faulty installation, lack of reasonable care, or if repaired or serviced by anyone other than a service facility authorized by HCT to render such service, or if affixed to any attachment not provided with the products, or if the model or serial number has been altered, tampered with, defaced or removed.
- Damages that occurs in shipment, due to act of God, and cosmetic damage.
- Signal reception problems and failures due to line power surge.
- Products used for commercial purposes (including but not limited to rental).
- Accessories
- To service calls, which do not involve defective workmanship or material such as, head cleaning and explaining the operation of the unit.

Therefore, these costs should be paid by the customer.

AFTER THE WARRANTY

Please contact HCT's Customer Support to obtain the cost of out of warranty repair or replacement.

For customer use:

Enter below the Model No. which is located either on the rear, bottom or side of the cabinet.

Retain this information for future reference.

Model No.: _____ Serial No.: _____

Purchase date: _____ Name of shop: _____

CUSTOMER ASSISTANCE NUMBERS:

To prove warranty coverage:
 Retain your sales receipt to prove the date of purchase.
 Copy of your sales receipt must be submitted at the time warranty service is provided.

HCT Customer Support :

<i>Korea</i>	Mr. K. H. Shin / KAS 82-11-724-0012	<u>kashin@hanmail.net</u>
<i>Japan</i>	Mr. John Mckibben / Watt Spohn Universal	<u>mckibbenj@wattspohn.com</u>
<i>Okinawa</i>	Mr. John Mckibben / Watt Spohn Universal	<u>mckibbenj@wattspohn.com</u>
<i>Guam</i>	Mr. John Mckibben / Watt Spohn Universal	<u>mckibbenj@wattspohn.com</u>
<i>Europe</i>	Mr. Mikko Sogabe / HCT Europe 49-6192-9655-10	<u>info@dfmmail.de</u>
<i>U.S.A</i>	John Mckibben / Watt Spohn Universal 1-888-500-3020(U.S. only) or Ms. Sunny Yoo / Amkotron 1-562-921-3330 ext.103	<u>mckibbenj@wattspohn.com</u> <u>sunny.yoo@amkotron.com</u>
<i>HCT Customer Service</i>		<u>hctkorea@hctkorea.co.kr</u> <u>hcthongkong@hcthk.com</u>

*For USA Customers : For Technical & Customer support, please contact HCT's Toll Free number.

|HCT|

P/NO : 3350GDKM0079A
GPN09MA001J