



1818 E. Orangethrope Ave  
Fullerton, CA 92831  
Tel. +1.714.515.1100  
[www.kmwcomm.com](http://www.kmwcomm.com)

# USER MANUAL FOR POD SYSTEM

(Version 0.7)

Document No.: MUN0630-2015

Date: February 24, 2016



## Revision History

Version	Author	Descriptions	Date
0.1	KMW	Initial Release	5/14/2015
0.2	KMW	Update FCC Regulation Statement	12/23/2015
0.3	KMW	Update RF specification on 2.2 and 5	1/12/2016
0.4	KMW	Update FCC RF Exposure information	1/15/2016
0.5	KMW	Make typo correct	1/18/2016
0.6	KMW	Change the RF Radiation Exposure	2/4/2016
0.7	KMW	Update RF Exposure statement and HAAT information	2/24/2016

## Change List

Version	Change list	Contents

## List for Acronyms

---

<b>AGC</b>	<b>Automatic Gain Control</b>
<b>ALC</b>	<b>Automatic Level Control</b>
<b>BDA</b>	<b>Bi-Directional Amplifier</b>
<b>BOM</b>	<b>Bill of Material</b>
<b>BTS</b>	<b>Base Transceiver Station</b>
<b>DAS</b>	<b>Distributed Antenna System</b>
<b>DL</b>	<b>Downlink</b>
<b>Downlink</b>	<b>Path covered from the Base Transceiver Station (BTS) to the subscribers' service area via the repeater</b>
<b>HEU</b>	<b>Head-end Unit</b>
<b>IF</b>	<b>Intermediate Frequency</b>
<b>LNA</b>	<b>Low Noise Amplifier</b>
<b>LTE</b>	<b>Long Term Evolution</b>
<b>MS</b>	<b>Mobile Station</b>
<b>NMS</b>	<b>Network Management System</b>
<b>PA</b>	<b>Power Amplifier</b>
<b>PSU</b>	<b>Power Supply Unit</b>
<b>RF</b>	<b>Radio Frequency</b>
<b>RU</b>	<b>Remote Unit</b>
<b>UL</b>	<b>Uplink</b>
<b>Uplink</b>	<b>Path covered from the subscribers' service area to the Base Transceiver Station (BTS) via the repeater</b>
<b>Uptime</b>	<b>Time during which a Unit or Module is in operation</b>
<b>VSWR</b>	<b>Voltage Standing Wave Ratio</b>

## Table of Contents

1.	POD System Overview .....	14
1.1	Features of POD System .....	14
1.2	POD System Architecture .....	15
1.3	POD System Configuration .....	17
1.3.1	SISO Configuration.....	17
1.3.2	MIMO Configuration .....	18
1.4	POD System Scalability & Limitation.....	19
2.	POD system Components .....	21
2.1	Head-end Unit.....	21
2.1.1	POD-H-DMCU (DAS Main Control Unit).....	23
2.1.1.1	Functions and features .....	23
2.1.1.2	Specifications .....	23
2.1.1.3	LED, LCD & Key PAD, Reset .....	23
2.1.1.4	Ethernet Ports.....	24
2.1.1.5	DC power input port & power switch .....	24
2.1.1.6	External Alarm Port .....	24
2.1.1.7	Ground port .....	25
2.1.1.8	Alarms .....	25
2.1.2	POD-H-SRU .....	26
2.1.2.1	Functions and features .....	26
2.1.2.2	Specifications .....	26
2.1.2.3	DC input port & Fuse .....	26
2.1.2.4	FAN port.....	27
2.1.2.5	Ground port .....	27
2.1.3	POD-H-SCM .....	28
2.1.3.1	Functions and features .....	28
2.1.3.2	Specifications .....	28
2.1.3.3	LED, LCD & Key PAD, Reset .....	28
2.1.3.4	Ethernet Port .....	29
2.1.3.5	Communication port.....	29
2.1.3.6	Alarms .....	29
2.1.4	POD-H-MCM .....	30
2.1.4.1	Functions and features .....	30
2.1.4.2	Specifications .....	30
2.1.4.3	LED, LCD & Key PAD, Reset .....	30
2.1.4.4	Ethernet Ports.....	31



- 2.1.4.5 External Alarm Ports .....32
- 2.1.4.6 Communication port.....32
- 2.1.4.7 Alarms .....32
- 2.1.5 POD-H-FEM-L-x .....33
  - 2.1.5.1 Functions and features .....34
  - 2.1.5.2 Specifications .....34
  - 2.1.5.3 RF Port and LED .....35
  - 2.1.5.4 Communication port.....36
  - 2.1.5.5 Alarms .....36
- 2.1.6 POD-H-FEM-H-x .....37
  - 2.1.6.1 Functions and features .....38
  - 2.1.6.2 Specifications .....38
  - 2.1.6.3 RF port and LED .....39
  - 2.1.6.4 Communication port.....40
  - 2.1.6.5 Alarms .....40
- 2.1.7 POD-H-COM-8 .....41
  - 2.1.7.1 Functions and features .....41
  - 2.1.7.2 Specifications .....41
  - 2.1.7.3 RF port and LED .....41
  - 2.1.7.4 Communication port.....42
  - 2.1.7.5 Alarms .....42
- 2.1.8 POD-H-DTM-8x8 .....43
  - 2.1.8.1 Functions and features .....43
  - 2.1.8.2 Specifications .....43
  - 2.1.8.3 RF port and LED .....43
  - 2.1.8.4 Communication port.....44
  - 2.1.8.5 Alarms .....44
- 2.1.9 POD-H-HOM-L .....45
  - 2.1.9.1 Functions and features .....45
  - 2.1.9.2 Specifications .....45
  - 2.1.9.3 RF port and LED .....45
  - 2.1.9.4 Optic port.....46
  - 2.1.9.5 Communication port.....46
  - 2.1.9.6 Alarms .....46
- 2.1.10 POD-H-HOM-H.....48
  - 2.1.10.1 Functions and features.....48
  - 2.1.10.2 Specifications .....48



- 2.1.10.3 RF port and LED.....48
- 2.1.10.4 Optic port .....49
- 2.1.10.5 Communication port .....49
- 2.1.10.6 Alarms .....49
- 2.1.11 POD-H-STM-8x4.....51
  - 2.1.11.1 Functions and features.....51
  - 2.1.11.2 Specifications .....51
  - 2.1.11.3 RF port and LED.....52
  - 2.1.11.4 Communication port .....53
  - 2.1.11.5 Alarms .....53
- 2.1.12 POD-H-PSU-x .....54
  - 2.1.12.1 Functions and features.....54
  - 2.1.12.2 Specifications .....54
  - 2.1.12.3 LED .....54
  - 2.1.12.4 Ethernet Port.....54
  - 2.1.12.5 AC input on/off Switch & DC output on/off switch.....54
  - 2.1.12.6 AC input port & DC output port .....55
  - 2.1.12.7 Rack ID.....55
  - 2.1.12.8 Ground port .....56
  - 2.1.12.9 Alarms .....56
- 2.1.13 POD-H-CDU.....57
  - 2.1.13.1 Functions and features.....57
- 2.1.14 POD-H-FAU .....57
  - 2.1.14.1 Functions and features.....57
  - 2.1.14.2 The rules for installing FAN unit.....57
  - 2.1.14.3 Port.....57
  - 2.1.14.4 Alarms .....58
- 2.2 Remote Unit.....59
  - 2.2.1 7/5/3 band RU for commercial band service (POD-R-7S8CPAWB-2730-AC/DC).....59
    - 2.2.1.1 Functions and features .....59
    - 2.2.1.2 Specifications.....59
    - 2.2.1.3 RF ports and LED.....62
    - 2.2.1.4 Debug Window .....63
    - 2.2.1.5 Alarms.....65
    - 2.2.1.6 Grounding.....65
  - 2.2.2 PS700/800 RU for public safety 700/800 frequency band service (POD-R-P78-27-AC/DC) .....66
    - 2.2.2.1 Functions and features .....66



- 2.2.2.2 Specifications .....66
- 2.2.2.3 RF ports and LED.....67
- 2.2.2.4 Debug Window .....68
- 2.2.2.5 Battery Backup Port.....69
- 2.2.2.6 Alarms .....70
- 2.2.2.7 Grounding.....71
- 3. Equipment Installation.....72
  - 3.1 Inspection before equipment installation .....72
    - 3.1.1 The Part list for each unit .....72
      - 3.1.1.1 Head-end Unit .....72
      - 3.1.1.2 Remote Unit.....73
    - 3.2 Head-end Unit Equipment Installation .....74
      - 3.2.1 Installation Head-end Unit in a 19" rack .....74
        - 3.2.1.1 The sequence for mounting head-end unit .....75
      - 3.2.2 Grounding.....76
      - 3.2.3 Optic port Cleaning.....76
    - 3.3 Remote Unit.....77
      - 3.3.1 Wall Mount for 3/5/7 band RU and PS700/800 RU.....77
      - 3.3.2 Grounding.....78
        - 3.3.2.1 3/5/7 band RU, PS700/800 RU .....78
- 4. Cable Connection .....79
  - 4.1 Head-end Unit Cable Connection .....79
    - 4.1.1 Cable.....79
    - 4.1.2 Cable Connection Example for frequency bands with FDD type.....80
    - 4.1.3 Cable Connection for TDD 2.6G frequency band.....82
    - 4.1.4 Cable Connection Example for Public Safety 700/800 band .....84
    - 4.1.5 Cable Connection Example for MIMO configuration .....85
    - 4.1.6 Cable connection between multiple Racks .....87
  - 4.2 Remote Unit Cable Connection .....88
    - 4.2.1 7/5/3 band & PS700/800 RU .....88
      - 4.2.1.1 Cable .....88
      - 4.2.1.2 Optic cable connection .....89
      - 4.2.1.3 AC or DC power cable connection .....90
      - 4.2.1.4 Ethernet cable connection for connecting with Expansion RU .....91
- 5. Specification.....92
  - 5.1 Electrical Specifications (Low power HFM – Low power RU) .....92
  - 5.2 Additional Model Names .....94

## Figures

Figure 1-1	DAS Overall Block Diagram .....	15
Figure 1-2	How it works .....	16
Figure 1-3	SISO Configuration .....	17
Figure 1-4	MIMO Configuration .....	18
Figure 1-5	POD System Scalability .....	19
Figure 2-1	Head-end Unit Front View .....	21
Figure 2-2	Head-end Unit Rear View .....	21
Figure 2-3	POD-H-DMCU .....	23
Figure 2-4	LED, LCD & Key PAD, Reset .....	23
Figure 2-5	Ethernet Ports .....	24
Figure 2-6	DC power input port & power switch .....	24
Figure 2-7	External Alarm Ports .....	25
Figure 2-8	POD-H-SRU Front View .....	26
Figure 2-9	POD-H-SRU Rear View .....	26
Figure 2-10	DC input port & Fuse .....	27
Figure 2-11	FAN port .....	27
Figure 2-12	POD-H-SCM .....	28
Figure 2-13	LED, LCD & Key PAD .....	28
Figure 2-14	Ethernet Port .....	29
Figure 2-15	Communication Port .....	29
Figure 2-16	POD-H-MCM .....	30
Figure 2-17	LED, LCD & Key PAD, Reset .....	31
Figure 2-18	Ethernet ports .....	31
Figure 2-19	External Alarm Ports .....	32
Figure 2-20	Communication Port .....	32
Figure 2-21	POD-H-FEM-L-x Front & Rear View .....	33
Figure 2-22	POD-H-FEM-L-x RF port and LED .....	35
Figure 2-23	Communication Port .....	36
Figure 2-24	POD-H-FEM-H-x Front & Rear View .....	37
Figure 2-25	POD-H-FEM-H-x RF port and LED .....	39
Figure 2-26	Communication Port .....	40
Figure 2-27	POD-H-COM-8 .....	41
Figure 2-28	POD-H-COM-8 RF port and LED .....	41
Figure 2-29	Communication Port .....	42
Figure 2-30	POD-H-COM-8 .....	43
Figure 2-31	POD-H-DTM-8x8 RF port and LED .....	43
Figure 2-32	Communication Port .....	44
Figure 2-33	POD-H-HOM-L .....	45
Figure 2-34	POD-H-HOM-L RF port and LED .....	45
Figure 2-35	optic port .....	46
Figure 2-36	Communication Port .....	46
Figure 2-37	POD-H-HOM-H .....	48
Figure 2-38	POD-H-HOM-H RF port and LED .....	48
Figure 2-39	optic port .....	49
Figure 2-40	Communication Port .....	49
Figure 2-41	POD-H-STM-8x4-DL .....	51
Figure 2-42	POD-H-STM-8x4-UL .....	51





Figure 2-43 POD-H-STM-8x4-DL RF port and LED ..... 52

Figure 2-44 POD-H-STM-8x4-UL RF port and LED ..... 52

Figure 2-45 Communication Port..... 53

Figure 2-46 POD-H-PSU-x..... 54

Figure 2-47 POD-H-PSU-x LED..... 54

Figure 2-48 Ethernet Port ..... 54

Figure 2-49 AC input on/off Switch & DC output on/off switch ..... 55

Figure 2-50 AC input port & DC output port..... 55

Figure 2-51 Rack ID ..... 55

Figure 2-52 POD-H-CDU ..... 57

Figure 2-53 POD-H-FAU ..... 57

Figure 2-54 Remote Unit – 7/5/3 band..... 59

Figure 2-55 Remote Unit External Interfaces ..... 62

Figure 2-56 Debug Window ..... 63

Figure 2-57 Port name for each RU type ..... 64

Figure 2-58 Remote Unit – PS700/800 ..... 66

Figure 2-59 Remote Unit - PS700/800 External Interfaces ..... 67

Figure 2-60 Debug Window ..... 68

Figure 2-61 Port name for each RU type ..... 69

Figure 2-62 Battery backup port..... 70

Figure 3-1 Head-end Unit Rack Mount (Front & Rear view)..... 74

Figure 3-2 Head-end Unit - Rack Mount Sequence ..... 75

Figure 3-3 Optic Connector Cleaning (left) and Optic Port Cleaning (right) ..... 76

Figure 3-4 LC/APC Optic Connector Dust Cap..... 76

Figure 3-5 3/5/7 band RU, PS700/800 RU – wall mount bracket ..... 77

Figure 3-6 3/5/7 band RU, PS700/800 RU – Install RU into wall mount bracket..... 77

Figure 3-7 3/5/7 band RU, PS700/800 RU – RU installed on the wall ..... 78

Figure 3-8 3/5/7 band RU grounding..... 78

Figure 4-1 Head-end - cables ..... 79

Figure 4-2 Cable Connection Example for frequency bands with FDD type ..... 80

Figure 4-3 Cable Connection Example #1 for TDD 2.6G frequency band ..... 82

Figure 4-4 Cable Connection Example for Public Safety 700/800 band ..... 84

Figure 4-5 Cable Connection for FDD frequency band (MIMO) support ..... 85

Figure 4-6 Connection Diagram for Rack Inter Connection ..... 87

## Tables

Table 1-1	POD System Scalability & Limitations .....	20
Table 2-1	Size, weight, and power consumption (Head-end Unit).....	22
Table 2-2	POD-H-DMCU LED Operation .....	23
Table 2-3	Pin map - External Alarm Port .....	25
Table 2-4	POD-H-DMCU - Alarms .....	25
Table 2-5	POD-H-SCM LED Operation .....	28
Table 2-6	POD-H-SCM - Alarms .....	29
Table 2-7	POD-H-MCM LED Operation.....	31
Table 2-8	POD-H-MCM - Alarms.....	32
Table 2-9	POD-H-FEM-L-x frequency range.....	34
Table 2-10	POD-H-FEM-L-x Size, weight, and power consumption.....	34
Table 2-11	POD-H-FEM-L-x LED Operation.....	36
Table 2-12	POD-H-FEM-L-x - Alarms.....	36
Table 2-13	POD-H-FEM-H-x frequency range.....	38
Table 2-14	POD-H-FEM-H-x Size, weight, and power consumption.....	38
Table 2-15	POD-H-FEM-H-x LED Operation.....	40
Table 2-16	POD-H-FEM-H-x - Alarms.....	40
Table 2-17	POD-H-COM-8 LED Operation .....	42
Table 2-18	POD-H-COM-8 - Alarms .....	42
Table 2-19	POD-H-DTM-8x8 LED Operation.....	44
Table 2-20	POD-H-DTM-8x8 - Alarms .....	44
Table 2-21	POD-H-HOM-L LED Operation .....	45
Table 2-22	POD-H-HOM-L - Alarms .....	46
Table 2-23	POD-H-HOM-L LED Operation .....	49
Table 2-24	POD-H-HOM-H - Alarms.....	49
Table 2-25	POD-H-STM-8x4 LED Operation.....	53
Table 2-26	POD-H-STM-8x8 - Alarms.....	53
Table 2-27	POD-H-PSU-x LED Operation .....	54
Table 2-28	Rack ID .....	56
Table 2-29	POD-H-PSU - Alarms .....	56
Table 2-30	POD-H-FAU - Alarms .....	58
Table 2-31	3/5/7 band RU - 700M, SMR800 + 850M Specifications .....	60
Table 2-32	3/5/7 band RU – PCS, AWS Specifications.....	60
Table 2-33	3/5/7 band RU – WCS, 2.6G Specifications .....	61
Table 2-34	7/5/3 band RU LED Operation .....	62
Table 2-35	3/5/7 band RU – Alarms .....	65
Table 2-36	PS700/800 RU - Specifications.....	67
Table 2-37	7/5/3 band RU LED Operation .....	68
Table 2-38	Pin map - Battery Backup Port.....	70
Table 2-39	PS700/800 band RU – Alarms.....	70
Table 5-1	POD DAS 2-Band RU Electrical Specifications (POD-R-P78-27-AC/DC).....	92
Table 5-2	POD DAS 7-Band RU Electrical Specifications (POD-R-7S8CPAWB-2730-AC/DC).....	93
Table 5-3	Basic Model and Additional Models on 2-Band Remote Unit .....	94
Table 5-4	Basic Model and Additional Models on 7-Band Remote Unit .....	94



**SAFETY AND REGULATION WARNING NOTICE**

***Only qualified personnel should handle the POD equipment. Any person involved in installation or operation of the POD should understand and follow these safety guidelines.***

<b>REGULATION</b>
Obey all general and regional installation and safety regulations to prevent any kinds of safety accidents such as potential electric shock, or RF exposure while installation, maintenance, or operation.

<p><b>FCC REGULATION</b> Use of unauthorized antennas, cables, and/or coupling devices not conforming with ERP/EIRP and/or indoor-only restrictions is prohibited.</p> <p>Use of unauthorized antennas, cables, and/or coupling devices not conforming with ERP/EIRP and/or indoor-only restrictions is prohibited.</p> <ul style="list-style-type: none"><li>• Use of unauthorized antennas, cables, and/or coupling devices not conforming with ERP/EIRP and/or indoor-only restrictions is prohibited.</li><li>• FCC Part 15.19 Statements<ul style="list-style-type: none"><li>- This device complies with Part 15 of the FCC Rules. Operation is subject to the following two conditions: (1) this device may not cause harmful interference, and (2) this device must accept any interference received, including interference that may cause undesired operation.</li></ul></li><li>• FCC Part 15.105 statement<ul style="list-style-type: none"><li>- This equipment has been tested and found to comply with the limits for a Class A digital device, pursuant to part 15 of the FCC Rules. These limits are designed to provide reasonable protection against harmful interference when the equipment is operated in a commercial environment. This equipment generates, uses, and can radiate radio frequency energy and, if not installed and used in accordance with the instruction manual, may cause harmful interference to radio communications. Operation of this equipment in a residential area is likely to cause harmful interference in which case the user will be required to correct the interference at his own expense.</li></ul></li><li>• FCC Part 15.21 statement<ul style="list-style-type: none"><li>- Any changes or modifications not expressly approved by the party responsible for compliance could void the user's authority to operate this equipment.</li></ul></li><li>• RF Exposure Statement<ul style="list-style-type: none"><li>- The antenna(s) must be installed such that a minimum separation distance of at least 60 cm with 3dBi antenna gain or 300 cm with 11dBi antenna gain or is maintained between the radiator (antenna) and all persons at all times. This device must not be co-located or operating in conjunction with any other antenna or transmitter.</li></ul></li><li>• FCC part 20 Industrial Booster statement (<i>FCC ID: ZUQR7S8CPAWB-2730 &amp; ZUQR-P78-27</i>)<ul style="list-style-type: none"><li>- <b>WARNING.</b> This is <b>NOT</b> a <b>CONSUMER</b> device. It is designed for installation by <b>FCC LICENSEES</b> and <b>QUALIFIED INSTALLERS</b>. You <b>MUST</b> have an <b>FCC LICENSE</b> or express consent of FCC Licensee to operate this device. Unauthorized use may result in significant forfeiture penalties, including penalties in excess of \$100,000 for each continuing violation.</li></ul></li></ul>
---

- FCC part 90 Industrial Booster statement - THIS IS A 90.219 CLASS B DEVICE (FCC ID: ZUQR-P78-27)
  - **WARNING.** This is **NOT** a **CONSUMER** device. It is designed for installation by **FCC LICENSEES** and **QUALIFIED INSTALLERS**. You **MUST** have an **FCC LICENSE** or express consent of FCC Licensee to operate this device. You **MUST** register Class B signal boosters (as defined in 47 CFR 90.219) online at [www.fcc.gov/signal-boosters/registration](http://www.fcc.gov/signal-boosters/registration). Unauthorized use may result in significant forfeiture penalties, including penalties in excess of \$100,000 for each continuing violation.
- FCC part 27.5 / SRSP 518 (FCC ID: ZUQR7S8CPAWB-2730)
  - Antennas must be installed in accordance with FCC 27.50 and SRSP 518. With 11dBi gain antennas the height of the antenna above average terrain (HAAT) must not exceed 4777m for IC. For different gain antennas refer to the relevant rules.
- FCC part 90.635 requirement (FCC ID: ZUQR-P78-27)
  - Antennas must be installed in accordance with FCC 90.635. With 11dBi gain antennas the height of the antenna above average terrain (HAAT) is permitted over 1372m. For different gain antennas refer to the relevant rules.

#### IC REGULATION

- RSS-131 Section 5.3 – (The input and output impedances)
  - The Manufacturer's rated output power of this equipment is for single carrier operation. For situations when multiple carrier signals are present, the rating would have to be reduced by 3.5 dB, especially where the output signal is re-radiated and can cause interference to adjacent band users. This power reduction is to be by means of input power or gain reduction and not by an attenuator at the output of the device.
- RSS-GEN, Sec. 7.1.2 – (transmitters)
  - Under Industry Canada regulations, this radio transmitter may only operate using an antenna of a type and maximum (or lesser) gain approved for the transmitter by Industry Canada. To reduce potential radio interference to other users, the antenna type and its gain should be so chosen that the equivalent isotropically radiated power (e.i.r.p.) is not more than that necessary for successful communication.
  - Conformément à la réglementation d'Industrie Canada, le présent émetteur radio peut fonctionner avec une antenne d'un type et d'un gain maximal (ou inférieur) approuvé pour l'émetteur par Industrie Canada. Dans le but de réduire les risques de brouillage radioélectrique à l'intention des autres utilisateurs, il faut choisir le type d'antenne et son gain de sorte que la puissance isotroperayonnée équivalente (p.i.r.e.) ne dépasse pas l'intensité nécessaire à l'établissement d'une communication satisfaisante.
- RSS-GEN, Sec. 7.1.2 – (detachable antennas)
  - This radio transmitter (identify the device by certification number, or model number if Category II) has been approved by Industry Canada to operate with the antenna types listed below with the maximum permissible gain and required antenna impedance for each antenna type indicated. Antenna types not included in this list, having a gain greater than the maximum gain indicated for that type, are strictly prohibited for use with this device.
  - Le présent émetteur radio (identifier le dispositif par son numéro de certification ou son numéro de modèle s'il fait partie du matériel de catégorie I) a été approuvé par Industrie Canada pour fonctionner avec les types d'antenne énumérés ci-dessous et ayant un gain admissible maximal et l'impédance requise pour chaque type d'antenne. Les types d'antenne non inclus dans cette liste, ou dont le gain est supérieur au gain maximal indiqué, sont strictement interdits pour l'exploitation de l'émetteur.

- RF Radiation Exposure
  - This equipment complies with RF radiation exposure limits set forth for an uncontrolled environment. This equipment should be installed and operated with a minimum distance of 60 cm with 3dBi antenna gain or 300 cm with 11dBi antenna gain between the radiator and your body. This transmitter must not be co-located or operating in conjunction with any other antenna or transmitter. RF exposure will be addressed at time of installation and the use of higher gain antennas require larger separation distances.
  - L'antenne (ou les antennes) doit être installée de façon à maintenir à tout instant une distance minimum de au moins 60 cm avec le gain d'antenne 3dBi ou 300 cm avec 11dBi gain d'antenne entre la source de radiation (l'antenne) et toute personne physique. Cet appareil ne doit pas être installé ou utilisé en conjonction avec une autre antenne ou émetteur.

**ELECTRIC SHOCK**

The POD System uses the AC or DC power with high voltage level which could result in electric shock and may cause severe injury.

**LASER SAFETY**

To avoid eye injury, do not look directly into the optical ports, patch cords or optical cables. Always assume that optical output is on.

To avoid the potential of radiation exposure, do not leave optic connectors uncovered when not connected.

To check fiber cable connection, use an optical power meter and this should be performed by only technicians familiar with fiber optic safety practices and procedures.

This equipment uses a Class 1 LASER according to FDA/CDRH Rules. This product conforms to all applicable standards of 21 CFR Chapter 1, Subchapter J, Part 1040

**SAFETY**

The POD system should not be modified or used for any other purposes without authority's permission in any cases. This could cause fires, electric shock or other injuries.

Be careful not to touch the heat sink part to prevent any degree of burns from high temperature of the heat sink.

Do not place the DAS equipments close to flammable materials which could reach high temperatures due to heat dissipation of the DAS equipments.

While working with outdoor DAS equipment with door, make sure to securely fasten the door to prevent any kinds of damages from slamming shut due to abrupt wind.

**UL REGULATION**

This equipment complies with UL Standard for safety.

## 1. POD SYSTEM OVERVIEW

POD System is a compact and flexible platform which is designed to provide effective service coverage for various indoor and outdoor applications.

POD system supports multiple wireless standards currently being used such as CDMA/EVDO, WCDMA and LTE, as well as high traffic capacity and flexible distribution by sectorization and various flexibilities for future expansions.

POD system supports effectively DAS Network Management system by using Ethernet communications connected to between Head-end Unit and Remote Unit.

### 1.1 Features of POD System

- A unified platform
  - A single head-end unit supports low & high power RU, indoor & outdoor RU.
  - A single head-end supports all commercial frequencies bands from 700M to 2.6G and public safety frequencies bands including UHF/VHF, PS700 and PS800.
- ALL IP structure
  - All modules and units have its unique IP address which is assigned automatically when installed.
- Supported capacity per a DMCU
  - A DMCU supports up to 4 racks. (a rack can support up to 7 H-SRUs)
  - A DMCU supports up to 4 H-OIMs and 6 H-OEMs.
- The User-friendly Web based GUI
  - Web based GUI interface at head-end unit and Remote Unit.
  - Firmware download for all connected active modules at remote site and right at the head-end
  - Sectorization/commissioning at remote site and right at the head-end
- Easy installation, commissioning and optimization
  - Auto system commissioning
  - DAS tree/Inter-connection diagram/rack diagram
  - System configuration backup/restore
- Monitoring functions for DAS system
  - Downlink spectrum monitoring which is built in H-FEM
  - SNMP/Remote monitoring & control
  - Uptime
  - Save log @H-DMCU, save alarm history @each module
- Monitoring interface for other equipments connected to DAS
  - Ethernet port forward function
  - Input/output ports for external alarm monitoring
- Hot Swap
  - All modules installed in H-SRU support hot swap function, so all the modules can be replaced without powering down H-SRU.
- Documentation
  - Auto BOM Generation
  - System Information Generation
  - Provide external memory for saving documents such as closeout package, user manual
- SMB-L connector (SMB with lock)
  - SMB-L connector makes RF cable connections between RF ports easier, comparing to SMA connector.

- The cable with SMB-L connector provides more stable tight connection because SMB-L connector has lock function, comparing to SMB connector. The cable with SMB connector might be untied or loosened easily by vibration or unintentional cable pulling.
- The RF cable with SMB connector can be used instead of the RF cable with SMB-L connector because SMB-L connector has compatibility with SMB connector.

## 1.2 POD System Architecture

Figure 1-1 represents the overall DAS block diagram of KMW DAS system, POD.

POD consists of HEU (head-end Unit), and RU (Remote unit). HEU provides the interface between plurality of BTS and plurality of RUs, and RUs are deployed over multiple shadow regions to provide wireless service coverage to mobile users in shadow regions.

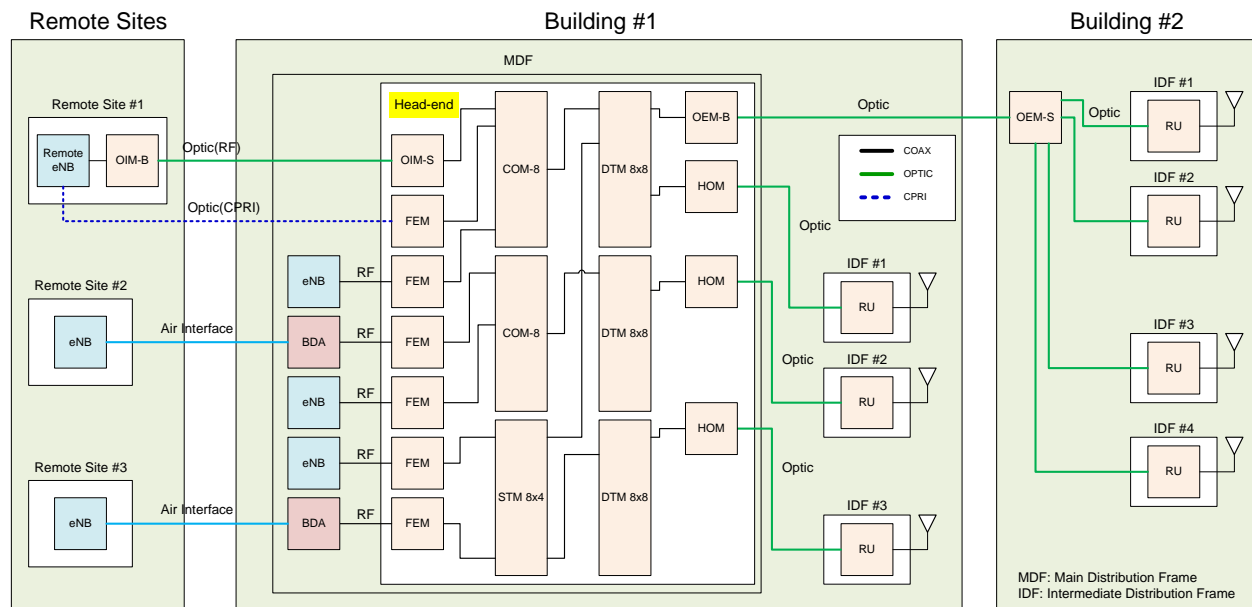
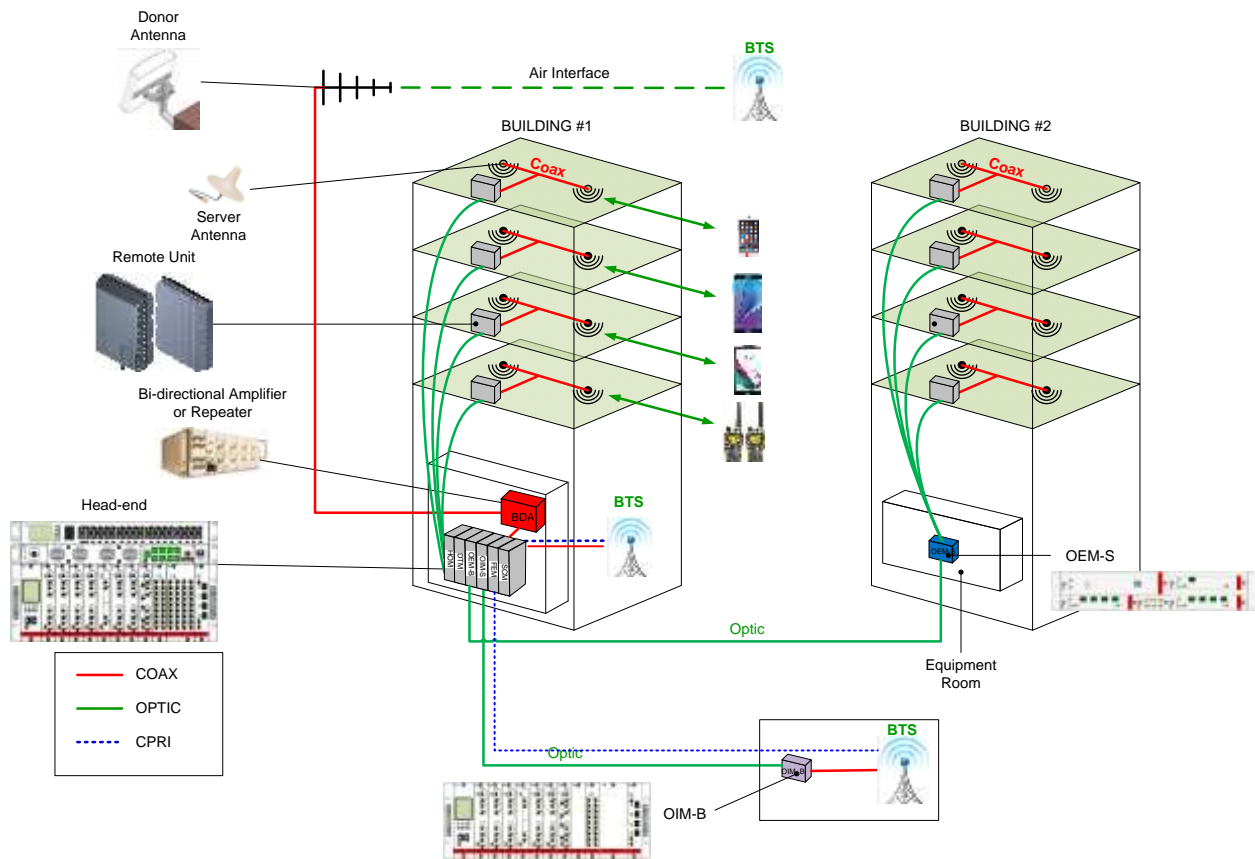

**Figure 1-1 DAS Overall Block Diagram**

Figure 1-1 shows general signal flow and module composition of POD DAS system.

POD DAS System supports various methods to connect with BTS such as direct connection to BTS through RF coaxial cable, connection to BTS via antenna through BDA, and connection to BTS by CPRI digital interface over optic. If user wants air interface with BTS, it is necessary for user to select proper BDA product separately because POD DAS system does not include any kinds of BDA.

H-FEM provides the interface between various base station having different frequency band/technology and POD DAS system, and H-COM combines downlink signal received from H-FEM and distributes uplink signals received from DTM to FEM. H-DTM combines downlink signals from H-COM and then distributes to H-HOM, also combines uplink signals from several H-HOM and then distributes to H-COM. H-HOM converts downlink RF signal received from H-DTM to optic signal and then transfers to RU, also converts uplink optic signal received from RU to RF signal and then transfers to H-DTM. RU provides wireless service coverage to users by transmitting downlink signal received from H-HOM through the antenna. Also, it transfers to HOM after converting uplink signal received from mobile stations through the antenna to optic signal.



**Figure 1-2 How it works**

Figure 1-2 is a practical example of POD DAS system. It shows how to distribute various BTS signals from Head-end Unit to multiple Remote Units.

Especially, in case of buildings away from Head-end location which needs multiple remote units, it is composed by the structure which distributes to multiple remote units after transmitting signal to other building through only one optic line using H-OEM, not transmits the signal by individual optic line according to required the number of remote units.

Also, it supports the connection between Head-end and base station through optic line using H-OIM when base station is away from head-end location.



### 1.3 POD System Configuration

#### 1.3.1 SISO Configuration

- Assumption
  - Supported frequency Band: 700M, SMR800, 850M, PCS, AWS, WCS, 2.6G
  - # of RU: 2
- System Configuration

Module or Unit	Q'ty	Comments
H-DMCU or H-MCM	1	Main Controller
H-PSU or H-PSM	1	Power Supply Unit
H-FEM-L-7	1	700M
H-FEM-L-S8	1	SMR800
H-FEM-L-C	1	850M
H-FEM-L-P	1	PCS
H-FEM-L-A	1	AWS
H-FEM-L-W	1	WCS
H-FEM-L-B	1	2.6G
H-COM-8	1	
H-HOM-L	1	
7 band RU	2	

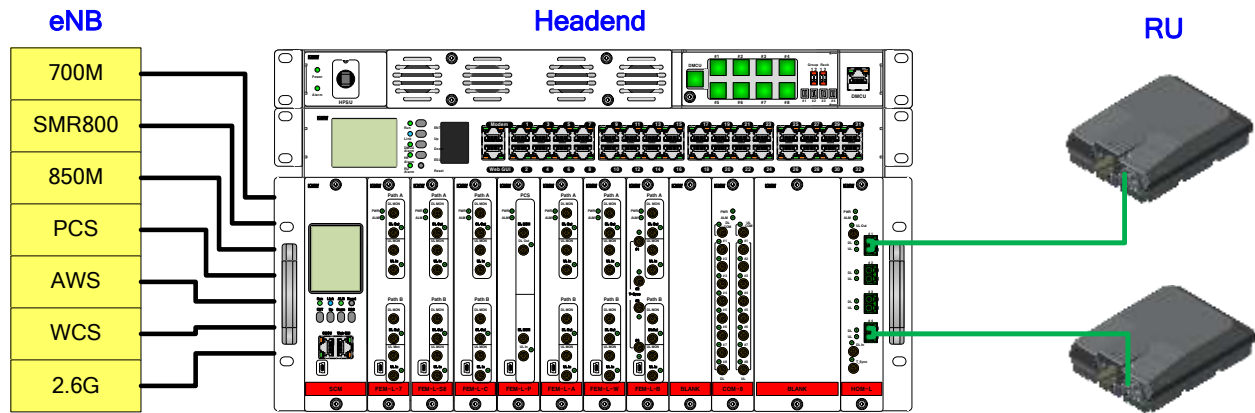

Figure 1-3 SISO Configuration

### 1.3.2 MIMO Configuration

- Assumption
  - Supported frequency Band
    - > SISO: 700M, SMR800, 850M, PCS, AWS, WCS, 2.6G
    - > MIMO: 700M, PCS, AWS, 2.6G
  - # of RU: 2
- System Configuration

Module or Unit	Q'ty	Comments
H-DMCU or H-MCM	1	Main Controller
H-PSU or H-PSM	1	Power Supply Unit
H-FEM-L-7	1	700M
H-FEM-L-S8	1	SMR800
H-FEM-L-C	1	850M
H-FEM-L-P	2	PCS
H-FEM-L-A	1	AWS
H-FEM-L-W	1	WCS
H-FEM-L-B	1	2.6G
H-COM-8	2	
H-HOM-L	2	
7 band RU	4	

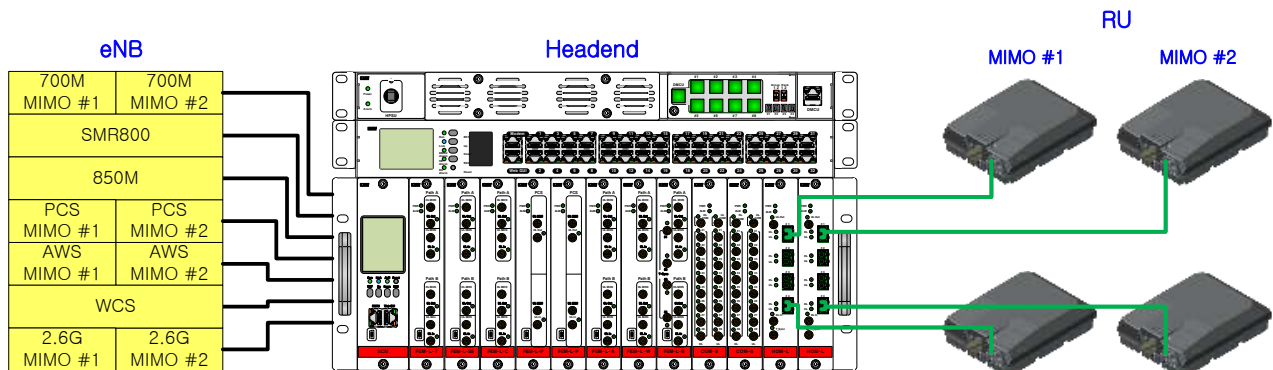

Figure 1-4 MIMO Configuration

### 1.4 POD System Scalability & Limitation

Figure 1-5 shows maximum capacity of POD system composed by one DMCU



Figure 1-5 POD System Scalability

**Table 1-1 POD System Scalability & Limitations**

		Supported maximum number			# of path/Module
		POD System <sup>1)</sup>	/Rack	/H-SRU	
H-DMCU		1			
RACK		4			
H-PSU		4	1 <sup>2)</sup>		
H-SRU		26	7		
H-FEM	H-FEM-L	208	84 <sup>3)</sup>	12 <sup>4)</sup>	2 <sup>9)</sup>
	H-FEM-H				1
H-COM-8		26	26	12 <sup>4)</sup>	
H-DTM 8x8		26	26	6 <sup>4)</sup>	
HOM		32	28	4 <sup>5)</sup>	
RU		256 <sup>6)</sup>	224 <sup>7)</sup>	32 <sup>8)</sup>	
H-OIM-B		4	4	4	
H-OEM-S		6	6	6	

- 1) Table 1-1 shows hardware capacity of one POD system.
- 2) One H-PSU supports one rack with 7 H-SRU which is fully filled with modules.
- 3) The number of supported H-FEM/rack = 7 H-SRU x 12 H-FEM/H-SRU = 84
- 4) One H-SRU consists of 12 slots. So, it supports up to 12 modules with 1 slot size (H-FEM & H-COM-8) and 6 modules with 2 slot size (H-DTM 8x8).
- 5) The number of supported HOM/H-SRU is limited up to four (4).
- 6) The number of supported RU in POD system is limited up to 256.
- 7) The number of supported RU/rack = 7 SRU/rack x the number of supported RU/SRU = 224
- 8) The number of supported RU/H-SRU = 4 HOM/SRU x 4 path/HOM x 2 RU/path = 32
- 9) H-FEM-L-P (PCS) supports only one path.

## 2. POD SYSTEM COMPONENTS

### 2.1 Head-end Unit

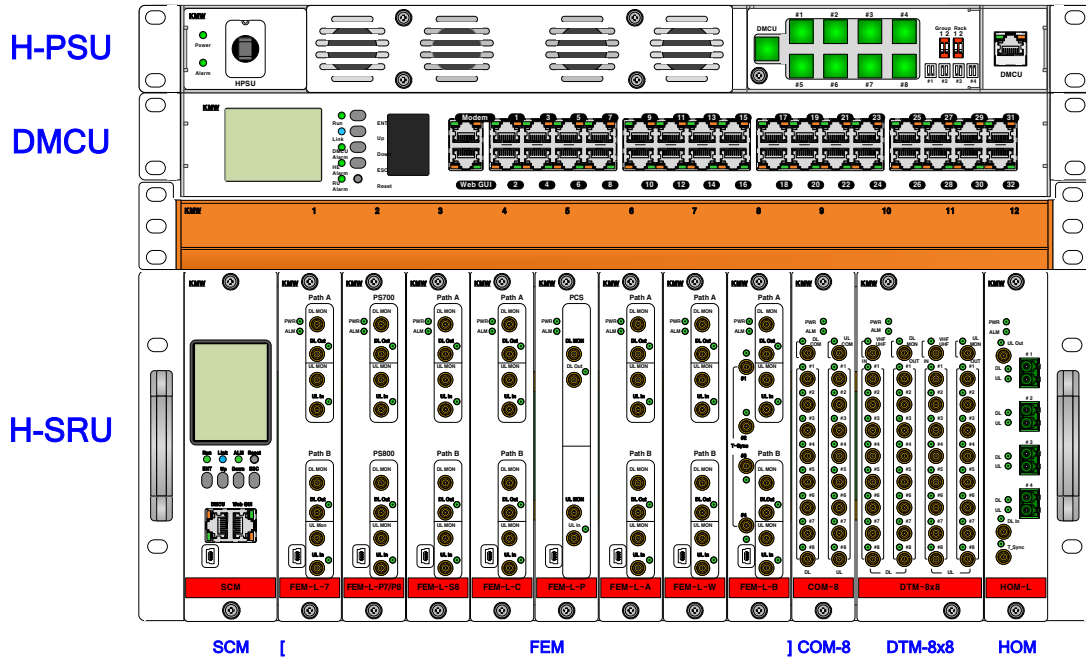

Figure 2-1 Head-end Unit Front View

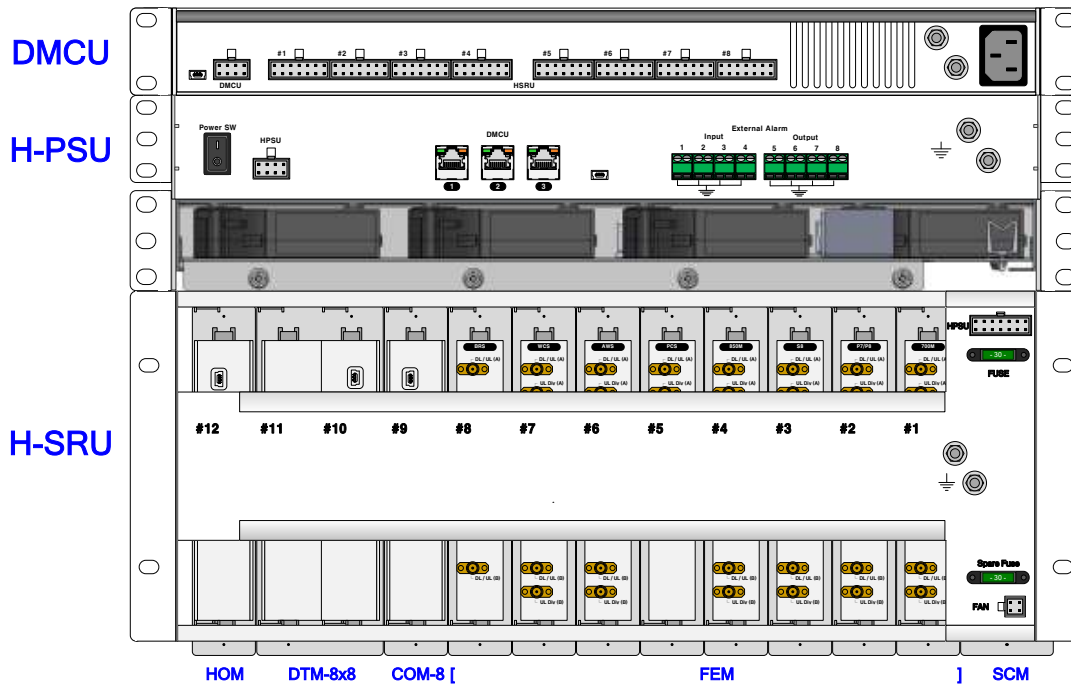

Figure 2-2 Head-end Unit Rear View

- Head-end Unit consists of
  - H-DMCU (Head-end DAS Main Control Unit)
  - H-PSU(Head-end Power Supply Unit)
  - H-SRU(Head-end Subrack Unit)
  - H-SCM(Head-end Subrack Control Module)
  - H-FEM(Head-end Front End Module)
  - H-COM(Head-end Combing Module)
  - H-DTM(Head-end Distribution Module)
  - HOM(Head-end Optic Module)
  - H-STM(Head-end Sectorization Module)
  - H-OEM(Head-end Optic Expansion Module)
  - H-OIM(Head-end Optic Interface Module)
- Specification
  - Size, weight, and power consumption

**Table 2-1 Size, weight, and power consumption (Head-end Unit)**

	Size(H x W x D)		Weight		Power consumption (W)
	inch	mm	lb	Kg	
POD-H-DMCU	2.1 x 19.0 x 19.7	52.4 x 482.6 x 499.5	6.6	3.0	28.5
POD-H-SRU	7.0 x 19.0 x 19.7	177 x 482.6 x 499.5	16.3	7.4	
POD-H-SCM	7.0 x 1.8 x 17.8	177 x 46.5 x 452.5	2.9	1.3	16.2
POD-H-MCM	7.0 x 3.1 x 17.8	177 x 79 x 452.5			24.0
POD-H-FEM-L	Refer to Table 2-10				
POD-H-FEM-H	Refer to Table 2-14				
POD-H-COM-8	7.0 x 1.3 x 17.8	177 x 31.8 x 452.5	5.5	2.5	4.8
POD-H-DTM-8x8	7.0 x 2.5 x 17.8	177 x 64.1 x 452.5	11.5	5.2	12
POD-H-HOM-L	7.0 x 1.3 x 17.8	177 x 31.8 x 452.5	5.5	2.5	30
POD-H-HOM-H	7.0 x 1.3 x 17.8	177 x 31.8 x 452.5	9	4.1	30
POD-H-STM-DL-8x4	7.0 x 2.5 x 17.8	177 x 64.1 x 452.5	11	5	
POD-H-STM-UL-8x4	7.0 x 2.5 x 17.8	177 x 64.1 x 452.5	11	5	
POD-H-OEM-B	7.0 x 1.3 x 17.8	177 x 31.8 x 452.5	5.3	2.4	30
POD-H-OEM-S	7.0 x 1.3 x 17.8	177 x 31.8 x 452.5	5.5	2.5	30
POD-H-OIM-B	7.0 x 1.3 x 17.8	177 x 31.8 x 452.5	5.3	2.4	30
POD-H-OIM-S	7.0 x 1.3 x 17.8	177 x 31.8 x 452.5	5.5	2.5	30
POD-H-PSU	1.7 x 19.0 x 19.7	44 x 482.6 x 499.5	13.9	6.3	85 @no load
POD-H-PSM	7.0 x 2.5 x 17.8	177 x 64.1 x 452.5			
POD-H-CDU	1.4 x 19.0 x 12.0	35.2 x 482.6 x 304.2	2.4	1.1	
POD-H-FAU	1.4 x 17.3 x 10.6	36 x 440 x 270	3.5	1.6	12

- Operating temperature: 14 ~ 122°F (-10 ~ 50°C)
- Power input
  - > H-FEM,H-COM, H-STM, H-DTM, H-HOM, H-OIM, H-FAU: DC 24V
  - > POD-H-PSU-AC/POD-H-PSM-AC: AC 100~240V (47~63Hz)
  - > POD-H-PSU-DC/POD-H-PSM-DC: DC -48V

### 2.1.1.1 POD-H-DMCU (DAS Main Control Unit)

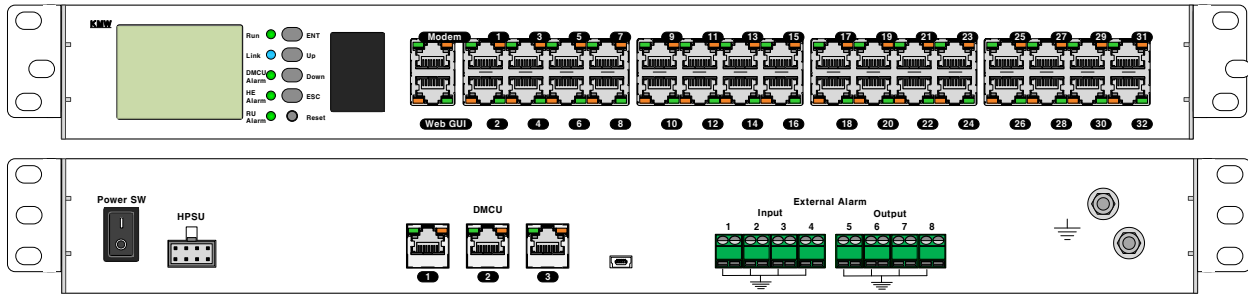

Figure 2-3 POD-H-DMCU

#### 2.1.1.1.1 Functions and features

- Controls, monitors, and generates alarms for all connected modules and units in a POD DAS system
- Supports up to 4 racks.
- Supports up to 4 H-OIMs and up to 6 H-OEMs.
- Provides web-based GUI interface to user
- Provides the user interface to control and monitor using LCD window and key pad.
- Send alarms to O&M system by SNMP.
- Ethernet port forward function
- Provides external input/output ports for external alarm monitoring

#### 2.1.1.1.2 Specifications

- Size, weight, and power consumption: refer to Table 2-1

#### 2.1.1.1.3 LED, LCD & Key PAD, Reset

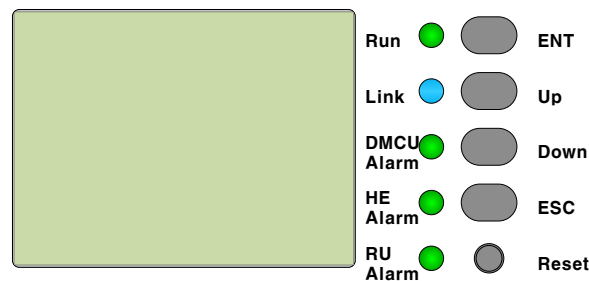

Figure 2-4 LED, LCD & Key PAD, Reset

- LCD window and key pad
  - H-DMCU provides the user interface to control and monitor using LCD window and key pad.
- Reset
  - Used for H-DMCU reset.
- LED

Table 2-2 POD-H-DMCU LED Operation

		Specifications
Run	Solid Green	When power is on.
	OFF	When power is off.
Link	Solid Yellow	When H-DMCU cannot communicate with at least one module among modules which are directly connected to H-DMCU such as H-SCM or H-PSU.

	OFF	When H-DMCU communicates with all modules which are directly connected with H-DMCU such as H-SCM or H-PSU.
DMCU Alarm	Solid Yellow	When H-DMCU has minor alarm.
	OFF	When H-DMCU has no alarm.
HE Alarm	Solid Yellow	When at least one module or unit in the head-end has minor alarm.
	Solid Red	When at least one module or unit in the head-end has major alarm.
	OFF	When all modules and units in the head-end have no alarm.
RU Alarm	Solid Yellow	When at least one RU has minor alarm.
	Solid Red	When at least one RU has major alarm.
	OFF	When all RUs have no alarm.

**2.1.1.4 Ethernet Ports**

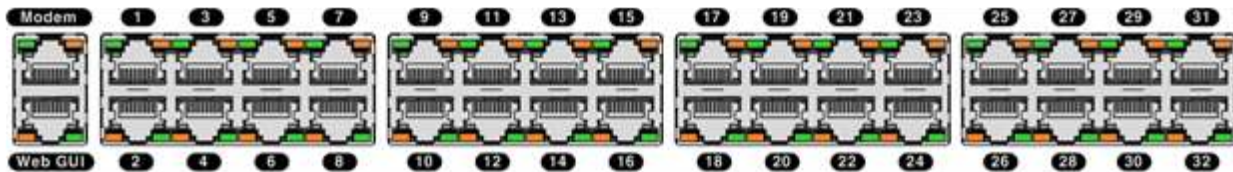
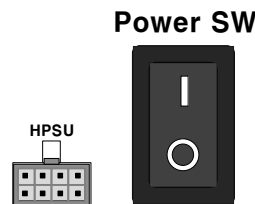

**Figure 2-5 Ethernet Ports**

- Modem port
  - Connected to wireless modem which provides connection with O&M center.
- Web GUI port
  - Used to access to web-based GUI using notebook or desktop PC.
- 1~32 Ethernet Port
  - Connected to H-SRU or H-PSU so that H-DMCU can monitor and control the connected H-PSUs and all modules installed in H-SRU.
  - Connected to external device to provide port forwarding function.

**2.1.1.5 DC power input port & power switch**

24V DC power for DMCU is fed from POD-H-PSU and can be turned on or off by power switch.



**Figure 2-6 DC power input port & power switch**

**2.1.1.6 External Alarm Port**

H-DMCU provides 4 alarm inputs to get the alarm statuses of the connected any external devices. Then, the input conditions are reported to the O&M system.

H-DMCU also provides 4 alarm outputs to control the external devices or to signal any alarm condition or status information to the external devices.



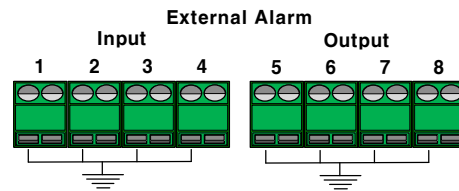

**Figure 2-7 External Alarm Ports**

**Table 2-3 Pin map - External Alarm Port**

Pin Assign		Specifications
1	External Input #1	External Alarm input #1 pin
2	External Input #2	External Alarm input #2 pin
3	External Input #3	External Alarm input #3 pin
4	External Input #4	External Alarm input #4 pin
5	External Output #1	External Alarm output #1 pin
6	External Output #2	External Alarm output #2 pin
7	External Output #3	External Alarm output #3 pin
8	External Output #4	External Alarm output #4 pin

**2.1.1.7 Ground port**

- Refer to section 3.2.2

**2.1.1.8 Alarms**

**Table 2-4 POD-H-DMCU - Alarms**

Alarm Name	Description	Remedy	Alarm Severity	LED color
High Temperature	Temperature high	Check environment	Minor	Yellow
Low Temperature	Temperature too low		Minor	Yellow
Head-end Composite	Head-end composite alarms	Check Head-end unit	Major/Minor	Red/ Yellow
RU Composite	RU composite alarms	Check RU	Major/Minor	Red/ Yellow
External Input (1~4)	External input signal	Check connected external unit	Minor	Yellow
AC Fail	H-PSU AC Fail	Check H-PSU	Major	Red
DC Fail	H-PSU DC Fail	Check H-PSU	Major	Red
PSU Comm. Fail	H-PSU Communication Fail	Check UDP cable connection	Minor	Yellow
SCM Comm. Fail	H-SCM Communication Fail	Check UDP cable connection	Minor	Yellow

### 2.1.2 POD-H-SRU

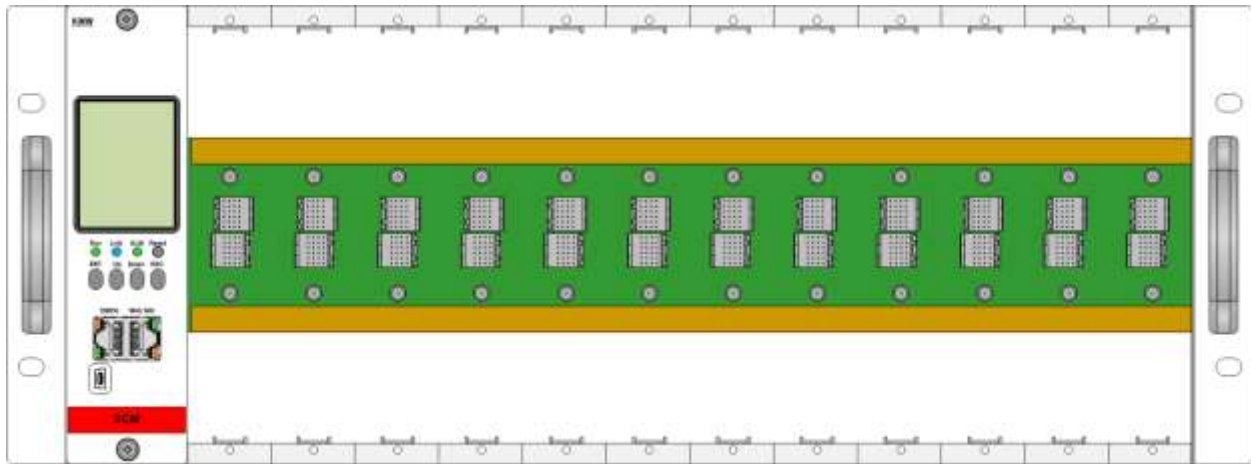

Figure 2-8 POD-H-SRU Front View

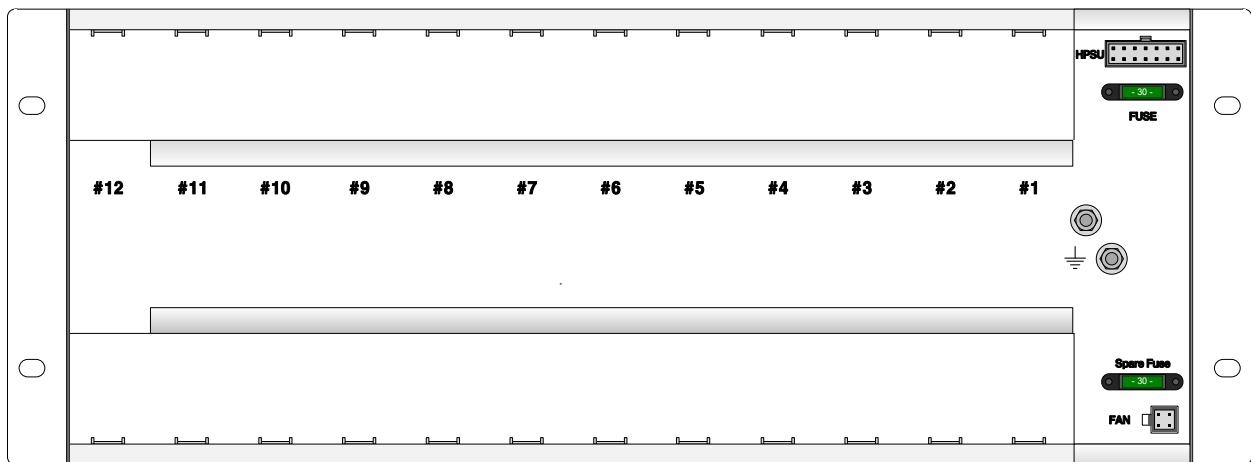

Figure 2-9 POD-H-SRU Rear View

#### 2.1.2.1 Functions and features

- One H-SRU supports 12 slot including one SCM and other modules such as H-FEM, H-COM, H-DTM, HOM.
- Supplies 24V DC power received from H-PSU to each individual module through the backboard.
- Supplies 24V DC power to H-FAU (Fan Unit) for dissipating heat comes from the modules installed in POD-H-SRU.
- Provides communication path between installed modules and SCM through backboard.

#### 2.1.2.2 Specifications

- Size, weight, and power consumption : refer to Table 2-1

#### 2.1.2.3 DC input port & Fuse

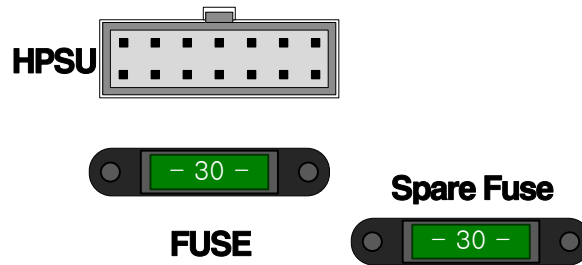

**Figure 2-10 DC input port & Fuse**

- DC Input port
  - The 24V DC power is supplied from H-PSU through this port, and this port includes H-SRU ID, rack ID which is set by 'Rack ID' dip switch in H-PSU.
- FUSE
  - Current capacity: 15A
  - The fuse protects the damages of all modules installed in H-SRU due to high current.
  - H-SRU provides spare fuse for just in case fuse is broken.

#### 2.1.2.4 FAN port



**Figure 2-11 FAN port**

- DC Power is supplied into the FAN Unit through this port.
- FAN fail alarm is transferred to H-SCM through this port.

#### 2.1.2.5 Ground port

- Refer to section 3.2.2

**2.1.3 POD-H-SCM**

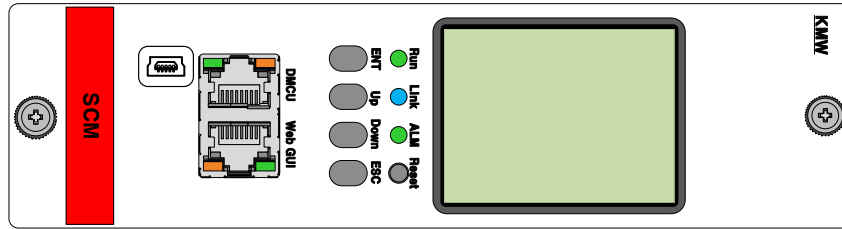

**Figure 2-12 POD-H-SCM**

**2.1.3.1 Functions and features**

- One H-SCM can be installed in one H-SRU.
- Provides web-based GUI interface to user
- Provides the user interface to control and monitor using LCD window and key pad.
- Provides physical path between H-DMCU and all modules in H-SRU
- Controls FAN on/off and FAN speed and monitors FAN alarm.
- Periodically, gather the data from all modules in H-SRU and send it to H-DMCU through DMCU port.
- Periodically, gather the data from RUs connected to H-HOM in H-SRU and send it to H-DMCU through DMCU port.

**2.1.3.2 Specifications**

- Size, weight, and power consumption : refer to Table 2-1

**2.1.3.3 LED, LCD & Key PAD, Reset**



**Figure 2-13 LED, LCD & Key PAD**

- LCD window and key pad
  - H-SCM provides the user interface to control and monitor using LCD window and key pad.
- Reset
  - Used for H-SCM reset.

**Table 2-5 POD-H-SCM LED Operation**

		Specifications
RUN	Solid Green	When power is on.
	OFF	When power is off.
Link	Solid Yellow	When H-SCM cannot communicate with at least one module among modules installed in H-SRU.
	OFF	When H-SCM communicates with all modules installed in H-SRU.
Alarm	Solid Red	When H-SCM has major alarm.

	Solid Yellow	When H-SCM has minor alarm.
	OFF	When H-SCM has no alarm.

**2.1.3.4 Ethernet Port**

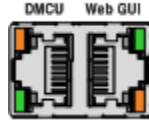

**Figure 2-14 Ethernet Port**

- DMCU port
  - Provides physical communication path between H-DMCU and all modules in H-SRU by connecting DMCU port of H-SCM to available one port among Ethernet port #1~#32 of H-DMCU.
- Web GUI port
  - Used to access to web-based GUI using notebook or desktop PC.

**2.1.3.5 Communication port**

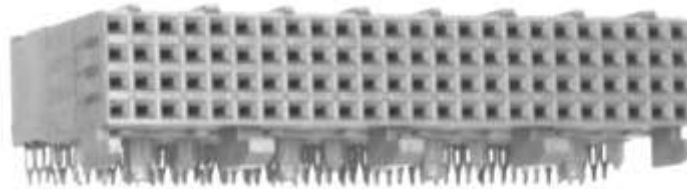

**Figure 2-15 Communication Port**

- This port provides communication path between H-FEM-H-x, H-COM, H-DTM, H-STM, HOM-x or H-SCM installed in H-SRU through backboard of H-SRU.
- +24V DC is provided through this communication port from backboard of H-SRU.
- H-SCM acquires ID information such as Rack ID, Sub rack ID and Slot ID through this communication port. The IP address of H-SCM is assigned automatically using the acquired ID information.

**2.1.3.6 Alarms**

**Table 2-6 POD-H-SCM - Alarms**

Alarm Name	Description	Remedy	Alarm Severity	LED color
High Temperature	Temperature high	Check environment	Minor	Yellow
Low Temperature	Temperature too low		Minor	Yellow
FAN	FAN Fail	Check FAN	Minor	Yellow
Module Comm. Fail	Module Communication Fail	Check Module connection	Minor	Yellow

## 2.1.4 POD-H-MCM

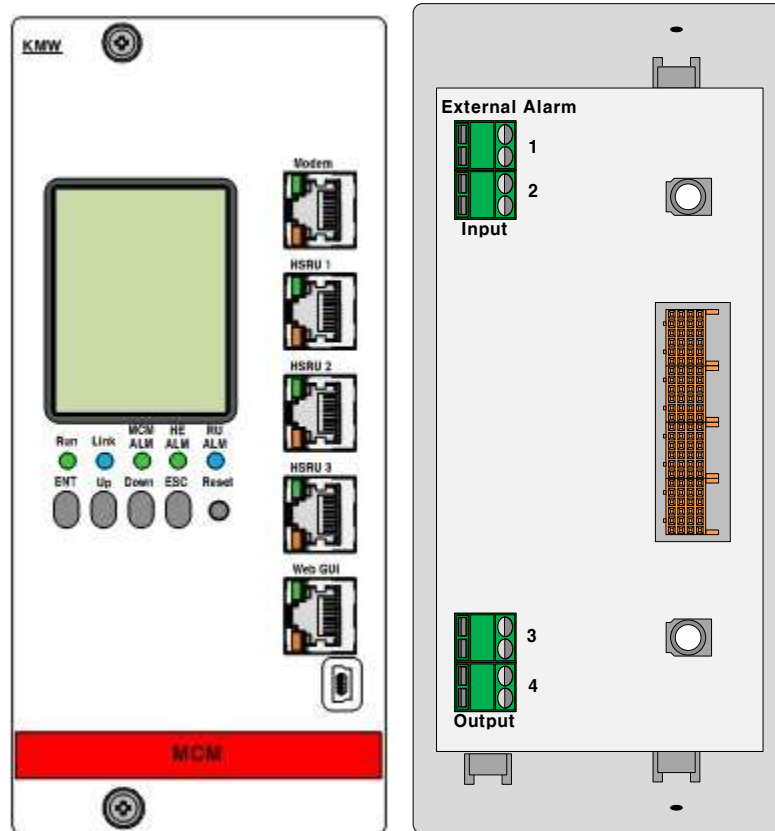

Figure 2-16 POD-H-MCM

### 2.1.4.1 Functions and features

- In case of small size DAS system, H-MCM can replace H-DMCU.
- Controls, monitors, and generates alarms for all modules and units connected to H-MCM via Ethernet cable, backboard of H-SCM, or optic cable.
- Provides web-based GUI interface to user
- Provides the user interface to control and monitor using LCD window and key pad.
- Send alarms to O&M system by SNMP.
- Input/output ports for external alarm monitoring

### 2.1.4.2 Specifications

- Size, weight, and power consumption : refer to Table 2-1

### 2.1.4.3 LED, LCD & Key PAD, Reset



**Figure 2-17 LED, LCD & Key PAD, Reset**

- LCD window and key pad
  - H-MCM provides the user interface to control and monitor using LCD window and key pad.
- Reset
  - Used for H-MCM reset.
- LED

**Table 2-7 POD-H-MCM LED Operation**

		Specifications
Run	Solid Green	When power is on.
	OFF	When power is off.
Link	Blink Green	When H-MCM cannot communicate with at least one module or units connected to H-MCM.
	OFF	When H-MCM communicates all modules and units connected to H-MCM.
MCM Alarm	Blink Green	When H- MCM itself has minor alarm.
	OFF	When H- MCM itself has no alarm.
HE Alarm	Blink Green	When at least one module or unit connected to H-MCM has minor alarm.
	Solid Red	When at least one module or unit connected to H-MCM has major alarm.
	OFF	When all modules and units connected to H-MCM have no alarm.
RU Alarm	Blink Green	When at least one RU connected to H-MCM has minor alarm.
	Solid Red	When at least one RU connected to H-MCM has major alarm.
	OFF	When all RUs connected to H-MCM have no alarm.

**2.1.4.4 Ethernet Ports**



**Figure 2-18 Ethernet ports**

- Modem port
  - Connected to wireless modem which provides connection with O&M center.
- Web GUI port
  - Used to access to web-based GUI using notebook or desktop PC.
- HSRU1~HSRU3 Ethernet Port
  - Connected to H-SRU so that H-MCM can monitor and control the connected all modules installed in H-SRU.

### 2.1.4.5 External Alarm Ports

POD-H-MCM provides 2 alarm inputs to get the alarm statuses of the connected any external devices. Then, the input conditions are reported to the O&M system.

POD-H-MCM also provides 2 alarm outputs to control the external devices or to signal any alarm condition or status information to the external devices.

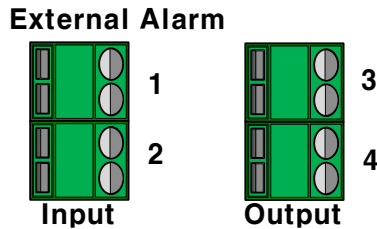

Figure 2-19 External Alarm Ports

### 2.1.4.6 Communication port

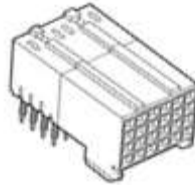

Figure 2-20 Communication Port

- This port provides communication path between H-FEM-H-x, H-COM, H-DTM, H-STM, HOM-x or H-SCM installed in H-SRU through backboard of H-SRU.
- +24V DC is provided through this communication port from backboard of H-SRU.
- H-MCM acquires ID information such as Rack ID, Sub rack ID and Slot ID through this communication port. The IP address of H-MCM is assigned automatically using the acquired ID information.

### 2.1.4.7 Alarms

Table 2-8 POD-H-MCM - Alarms

Alarm Name	Description	Remedy	Alarm Severity	LED color
High Temperature	Temperature high	Check environment	Minor	Yellow
Low Temperature	Temperature too low		Minor	Yellow
Head-end Composite	Head-end composite alarms	Check Head-end unit	Major/Minor	Red/ Yellow
RU Composite	RU composite alarms	Check RU	Major/Minor	Red/ Yellow
External Input (1~2)	External input signal	Check connected External unit	Minor	Yellow
AC Fail	H-PSU AC Fail	Check H-PSU	Major	Red
DC Fail	H-PSU DC Fail	Check H-PSU	Major	Red
SCM Comm. Fail	H-SCM Communication Fail	Check UDP cable connection	Minor	Yellow



2.1.5 POD-H-FEM-L-x

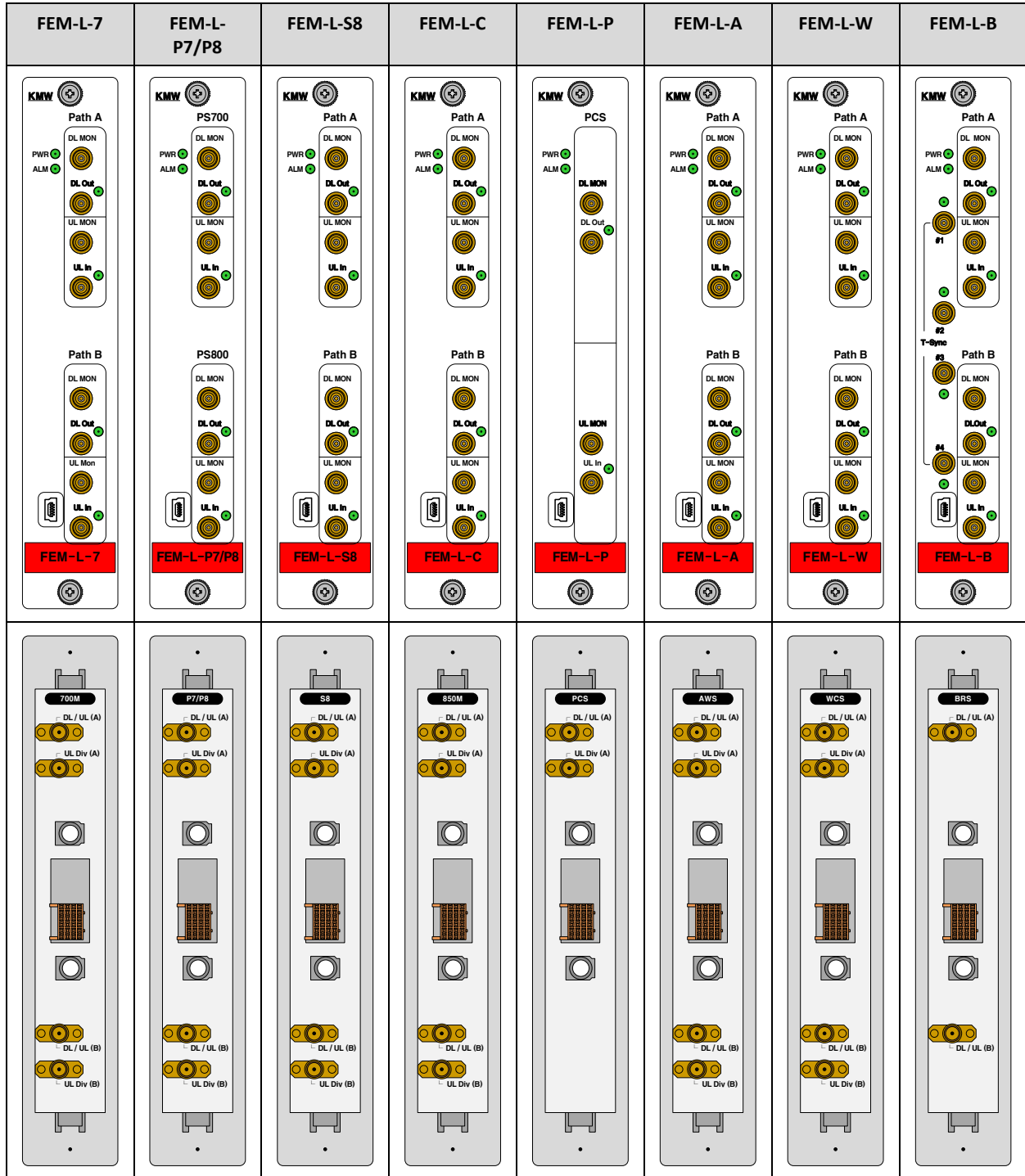

Figure 2-21 POD-H-FEM-L-x Front & Rear View

**2.1.5.1 Functions and features**

- Provides the interface between DAS and Base station
- Provides independent two RF path except H-FEM-L-P
- ALC function for DL/UL Path
- Spectrum monitoring function for DL Input
- TDD Switching for TD-LTE (POD-H-FEM-L-B only)
- Acquisition and transmission of synchronization signal (POD-H-FEM-L-B only)

**2.1.5.2 Specifications**

- Frequency range

**Table 2-9 POD-H-FEM-L-x frequency range**

	Downlink	Uplink	Comments
POD-H-FEM-L-7	728~756 MHz	698~716 MHz (Lower ABC) 777~787 MHz (Upper C)	
POD-H-FEM-L-P7P8	758~775 MHz (PS700) 851~869 MHz (PS800)	788~805 MHz (PS700) 806~824 MHz (PS800)	
POD-H-FEM-L-S8	851~869 MHz	806~824 MHz	
POD-H-FEM-L-C	869~894 MHz	824~849 MHz	
POD-H-FEM-L-P	1930~1995 MHz	1850~1915 MHz	
POD-H-FEM-L-A	2110~2180 MHz	1710~1780 MHz	
POD-H-FEM-L-W	2350~2360 MHz	2305~2315 MHz	
POD-H-FEM-L-B	2496~2690 MHz		TDD

- Input range
- > -15~20dBm

**Table 2-10 POD-H-FEM-L-x Size, weight, and power consumption**

	Size(H x W x D)		Weight		Power consumption (W)
	inch	mm	lb	Kg	
POD-H-FEM-L-7	7.0 x 1.3 x 17.8	177 x 31.8 x 452.5	4.9	2.2	22
POD-H-FEM-L-P7P8	7.0 x 1.3 x 17.8	177 x 31.8 x 452.5	4.9	2.2	16
POD-H-FEM-L-S8	7.0 x 1.3 x 17.8	177 x 31.8 x 452.5	4.9	2.2	16
POD-H-FEM-L-C	7.0 x 1.3 x 17.8	177 x 31.8 x 452.5	4.9	2.2	15
POD-H-FEM-L-P	7.0 x 1.3 x 17.8	177 x 31.8 x 452.5	4.9	2.2	9
POD-H-FEM-L-A	7.0 x 1.3 x 17.8	177 x 31.8 x 452.5	4.9	2.2	12
POD-H-FEM-L-W	7.0 x 1.3 x 17.8	177 x 31.8 x 452.5	4.9	2.2	12
POD-H-FEM-L-B	7.0 x 1.3 x 17.8	177 x 31.8 x 452.5	4.9	2.2	13

2.1.5.3 RF Port and LED

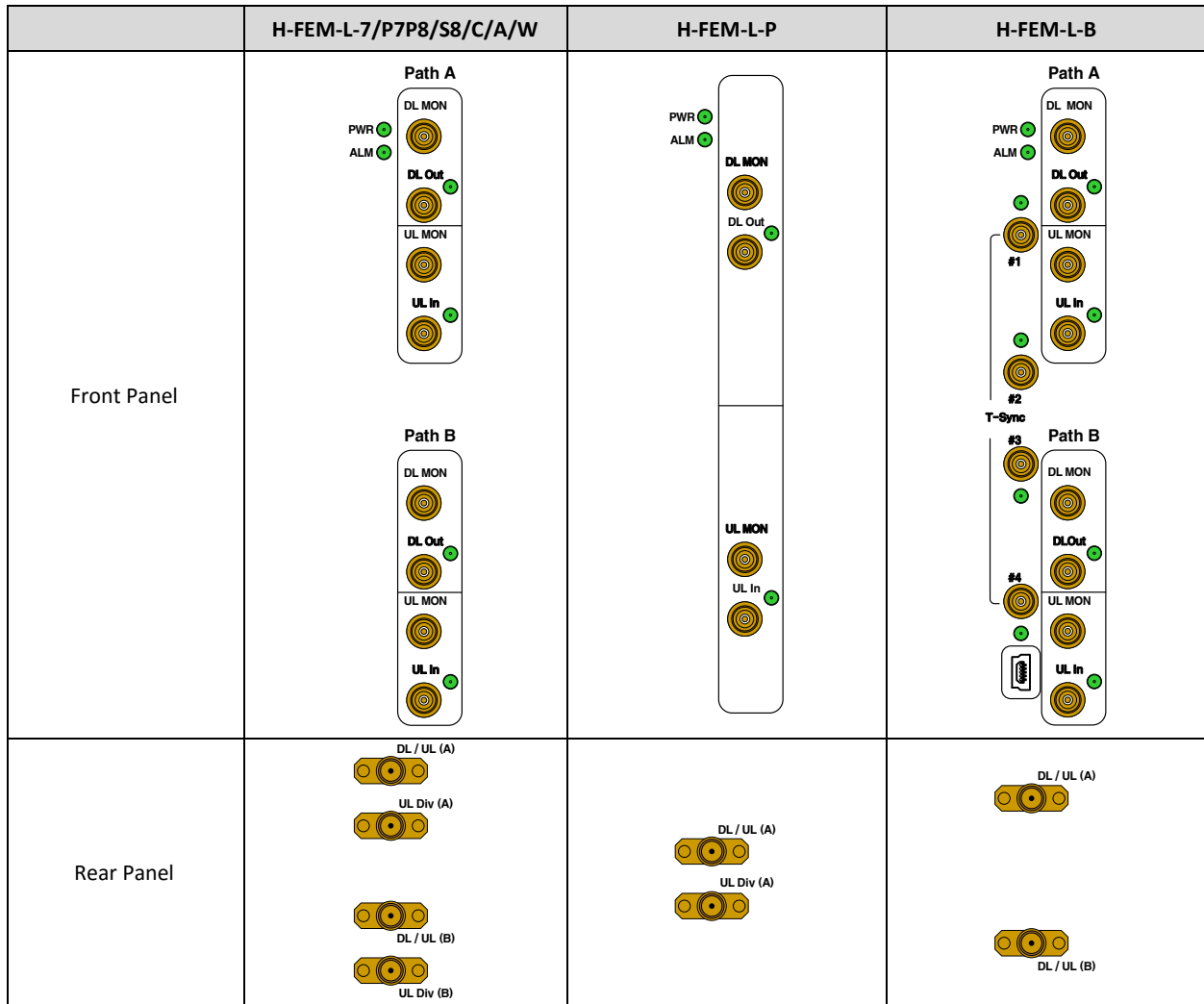

Figure 2-22 POD-H-FEM-L-x RF port and LED

- RF Ports
  - DL/UL-A(B), UL-Div A(B)
    - > Linked to BTS RF ports
    - > When the RF port linked to BTS is duplex port, connect to DL/UL-A(B)
    - > When the RF ports linked to BTS are TX/RX port, connect DL/UL-A(B) to TX port and UL Div A(B) to RX port.
    - > Connector Type: SMA Female
  - Connector Type: SMA DL MON-A(B), UL MON-A(B)
    - > Used to monitor DL input or UL output for path A or B
    - > Connector Type: SMB-L Female
  - DL OUT-A(B), UL IN-A(B)
    - > DL OUT- A(B): DL output port for path A or B, Linked to H-COM or H-DTM
    - > UL IN- A(B): UL input port for path A or B, Linked to H-COM or H-DTM
    - > Connector Type: SMB-L Female

- LED

**Table 2-11 POD-H-FEM-L-x LED Operation**

		Specifications
PWR	Solid Green	When power is on.
	Off	When power is off.
ALM	Off	When H-FEM-L-x has no alarms.
	Solid Yellow	When H-FEM-L-x has minor alarm.
	Solid Red	When H-FEM-L-x has major alarm.
DL Out	Blink Green	At the cable connection guide, green led blinks to indicate which RF ports should be connected to.
UL In	Blink Green	
T-sync #1~#4	Blink Green	

**2.1.5.4 Communication port**

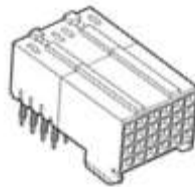

**Figure 2-23 Communication Port**

- This port provides communication path between H-FEM-L-x and H-SCM through backboard of H-SRU.
- +24V DC is provided through this communication port from backboard of H-SRU.
- H-FEM-L-x acquires ID information such as Rack ID, Sub rack ID and Slot ID through this communication port. The IP address of H-FEM-L-x is assigned automatically using the acquired ID information.

**2.1.5.5 Alarms**

**Table 2-12 POD-H-FEM-L-x - Alarms**

Alarm Name	Description	Remedy	Alarm Severity	LED color
High Temperature	Temperature too high	Check environment	Major	Red
	Temperature high		Minor	Yellow
Low Temperature	Temperature too low		Minor	Yellow
Downlink High Input power	RF signal too high	Check H-FEM downlink input level/ attenuator configuration/ALC status	Major	Red
	RF signal high		Major	Yellow
Uplink High Output Power	RF signal too high	Check H-FEM uplink input level/ attenuator configuration/ALC status	Major	Red
	RF signal high		Major	Yellow
Downlink Low Input Power	RF signal too low	Check H-FEM downlink input level/ attenuator configuration/RF cabling	Minor	Yellow
Link	Communication fail	Check pin of communication port/ assigned IP address	Major	Yellow
Freeze	The final stage of Shutdown process	Check if shutdown process is going again after reset	Major	Red
Downlink ALC Activation	ALC activation	Check H-FEM downlink input level/ attenuator configuration	Warning	Yellow
Sync fail (H-FEM-L-B only)	No TDD sync signal is acquired	Check H-FEM downlink signal input received from BTS	Major	Yellow

2.1.6 POD-H-FEM-H-x

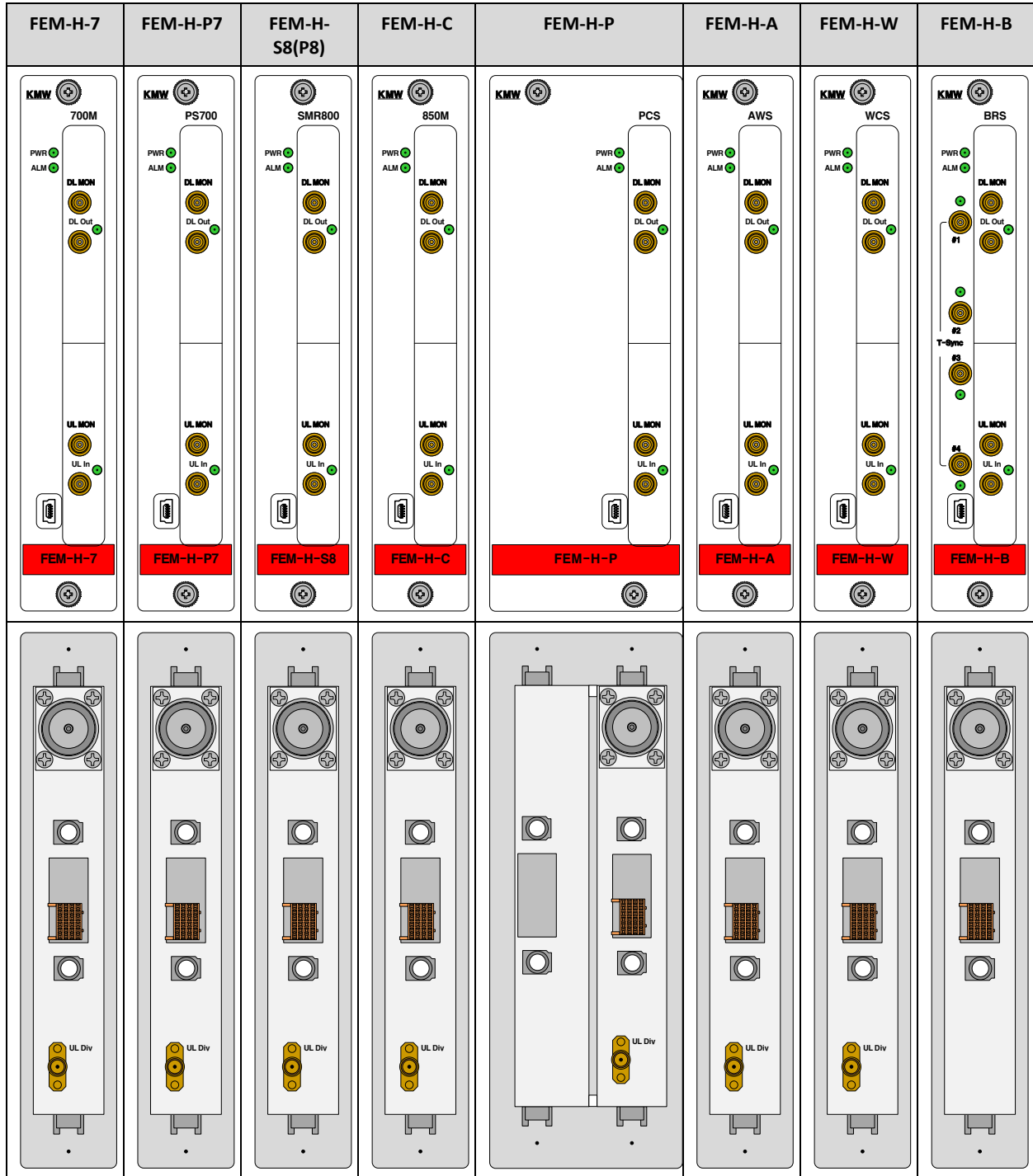

Figure 2-24 POD-H-FEM-H-x Front & Rear View

**2.1.6.1 Functions and features**

- Provides the interface between DAS and Base station
- ALC function for DL/UL Path
- Spectrum monitoring function for DL Input
- TDD Switching for TD-LTE (POD-H-FEM-H-B only)
- Acquisition and transmission of synchronization signal (POD-H-FEM-H-B only)

**2.1.6.2 Specifications**

- Frequency range

**Table 2-13 POD-H-FEM-H-x frequency range**

	Downlink	Uplink	Comments
POD-H-FEM-L-7	728~756 MHz	698~716 MHz (Lower ABC) 777~787 MHz (Upper C)	
POD-H-FEM-L-P7	758~775 MHz	788~805 MHz	
POD-H-FEM-L-P8	851~869 MHz	806~824 MHz	
POD-H-FEM-L-S8	851~869 MHz	806~824 MHz	
POD-H-FEM-L-C	869~894 MHz	824~849 MHz	
POD-H-FEM-L-P	1930~1995 MHz	1850~1915 MHz	
POD-H-FEM-L-A	2110~2180 MHz	1710~1780 MHz	
POD-H-FEM-L-W	2350~2360 MHz	2305~2315 MHz	
POD-H-FEM-L-B	2496~2690 MHz		TDD

- Input range
  - 15~46dBm

**Table 2-14 POD-H-FEM-H-x Size, weight, and power consumption**

	Size(H x W x D)		Weight		Power consumption (W)
	inch	mm	lb	Kg	
POD-H-FEM-H-7	7.0 x 1.3 x 17.8	177 x 31.8 x 452.5	5.7	2.6	11.5
POD-H-FEM-H-P7	7.0 x 1.3 x 17.8	177 x 31.8 x 452.5	5.7	2.6	8
POD-H-FEM-H-P8(S8)	7.0 x 1.3 x 17.8	177 x 31.8 x 452.5	5.7	2.6	8
POD-H-FEM-H-C	7.0 x 1.3 x 17.8	177 x 31.8 x 452.5	5.7	2.6	8
POD-H-FEM-H-P	7.0 x 2.5 x 17.8	177 x 63.8 x 452.5	5.7	2.6	9
POD-H-FEM-H-A	7.0 x 1.3 x 17.8	177 x 31.8 x 452.5	7.7	3.5	9.5
POD-H-FEM-H-W	7.0 x 1.3 x 17.8	177 x 31.8 x 452.5	5.7	2.6	6
POD-H-FEM-H-B	7.0 x 1.3 x 17.8	177 x 31.8 x 452.5	5.7	2.6	6
POD-H-FEM-L-B	7.0 x 1.3 x 17.8	177 x 31.8 x 452.5	5.7	2.6	7.5

2.1.6.3 RF port and LED

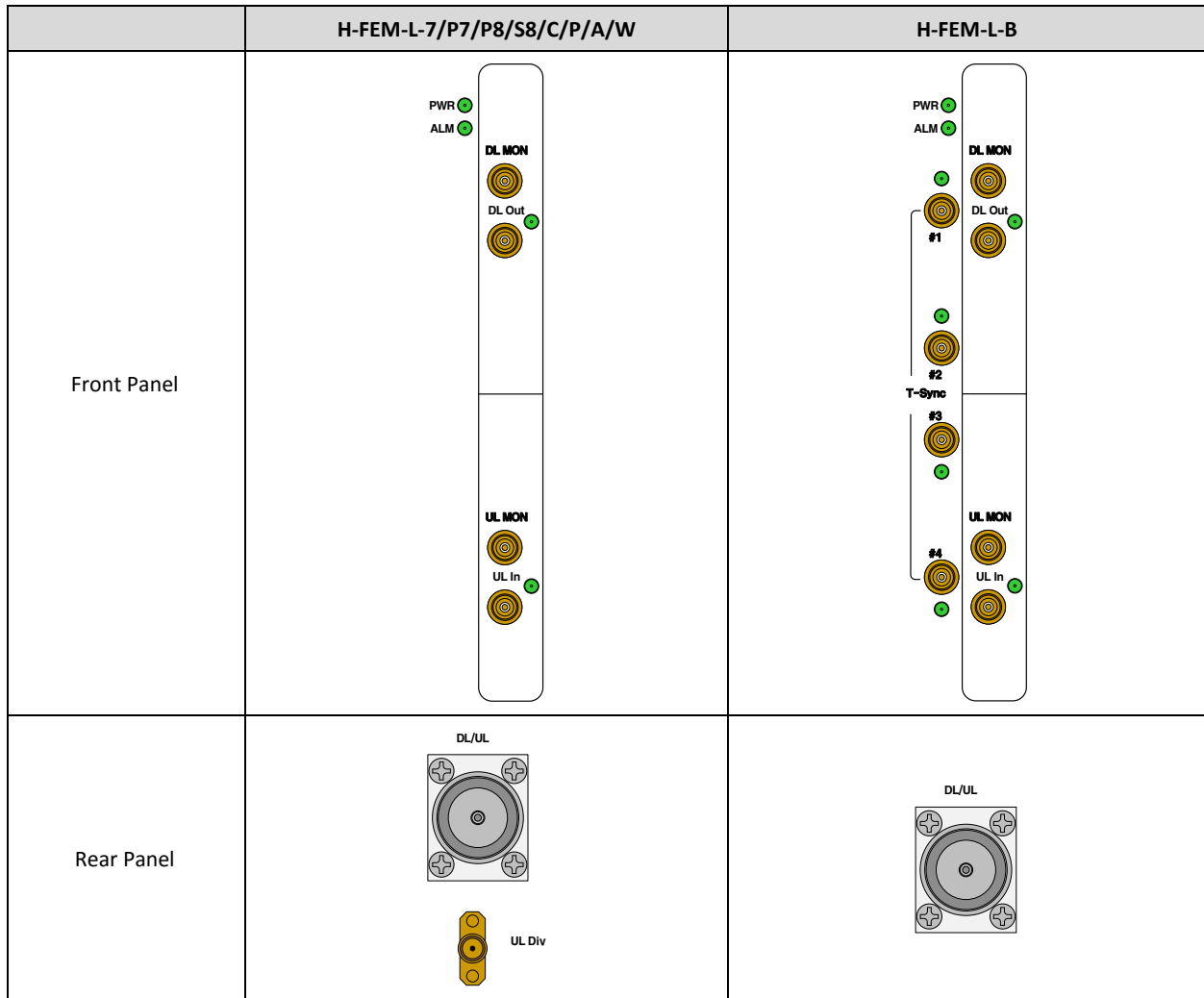

Figure 2-25 POD-H-FEM-H-x RF port and LED

- RF Ports
  - DL/UL, UL-Div
    - > Linked to BTS RF ports
    - > When the RF port linked to BTS is duplex port, connect to DL/UL
    - > When the RF ports linked to BTS are TX/RX port, connect DL/UL to TX port and UL Div to RX port.
    - > Connector Type
      - Mini DIN Female for DL/UL port
      - SMA Female for UL div port
  - Connector Type: SMA DL MON, UL MON
    - > Used to monitor DL input or UL output
    - > Connector Type: SMB-L Female
  - DL OUT, UL IN
    - > DL OUT: DL output port, Linked to H-COM or H-DTM
    - > UL IN: UL input port, Linked to H-COM or H-DTM
    - > Connector Type: SMB-L Female

- LED

**Table 2-15 POD-H-FEM-H-x LED Operation**

		Specifications
PWR	Solid Green	When power is on.
	Off	When power is off.
ALM	Off	When H-FEM-H-x has no alarms.
	Solid Yellow	When H-FEM-H-x has minor alarm.
	Solid Red	When H-FEM-H-x has major alarm.
DL Out	Blink Green	At the cable connection guide, green led blinks to indicate which RF ports should be connected to.
UL In	Blink Green	
T-sync #1~#4	Blink Green	

#### 2.1.6.4 Communication port

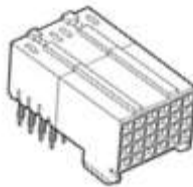

**Figure 2-26 Communication Port**

- This port provides communication path between H-FEM-H-x and H-SCM through backboard of H-SRU.
- +24V DC is provided through this communication port from backboard of H-SRU.
- H-FEM-H-x acquires ID information such as Rack ID, Sub rack ID and Slot ID through this communication port. The IP address of H-FEM-H-x is assigned automatically using the acquired ID information.

#### 2.1.6.5 Alarms

**Table 2-16 POD-H-FEM-H-x - Alarms**

Alarm Name	Description	Remedy	Alarm Severity	LED color
High Temperature	Temperature too high	Check environment	Major	Red
	Temperature high		Minor	Yellow
Low Temperature	Temperature too low		Minor	Yellow
Downlink High Input Power	RF signal too high	Check H-FEM downlink input level/ attenuator configuration/ALC status	Major	Red
	RF signal high		Major	Yellow
Uplink High Output Power	RF signal too high	Check H-FEM uplink input level/ attenuator configuration/ALC status	Major	Red
	RF signal high		Major	Yellow
Downlink Low Input Power	RF signal too low	Check H-FEM downlink input level/ attenuator configuration/RF cabling	Minor	Yellow
Link	Communication fail	Check pin of communication port/ assigned IP address	Major	Yellow
Freeze	The final stage of Shutdown process	Check if shutdown process is going again after reset	Major	Red
Downlink ALC Activation	ALC activation	Check H-FEM downlink input level/ attenuator configuration	Warning	Yellow
Sync fail (H-FEM-L-B only)	No TDD sync signal is acquired	Check H-FEM downlink signal input received from BTS	Major	Yellow



### 2.1.7 POD-H-COM-8

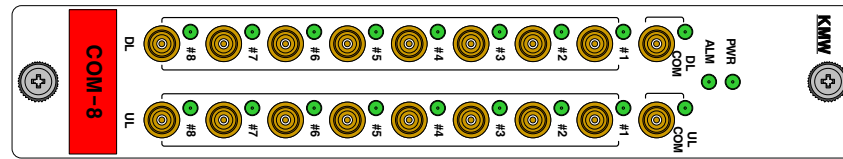

Figure 2-27 POD-H-COM-8

#### 2.1.7.1 Functions and features

- Combines DL output signals received from H-FEM and transfers to H-DTM, or H-HOM
- Receives UL signal from H-DTM, or H-HOM and distributes to H-FEM
- Control Power Ratio for multiple H-FEM with same frequency band to share DL output power at RU
- ALC function for DL/UL Path
- To minimize negative effects by unused input/output ports such as the degradation of VSWR or isolation between ports, the unused ports can be switched into 50 ohm termination by user.
- When any one sector or DAS system needs low power RU less than 4, H-COM can be connected to H-HOM-L directly without H-DTM.
  - > In this case, the attenuator in the common path of H-COM should add 15dB attenuation using web based GUI to compensate the loss of H-DTM..

#### 2.1.7.2 Specifications

- Frequency range: 600~2700MHz
- Maximum RF Power: -10dBm@DL, -25dBm@UL
- Size, weight, and power consumption : refer to Table 2-1

#### 2.1.7.3 RF port and LED

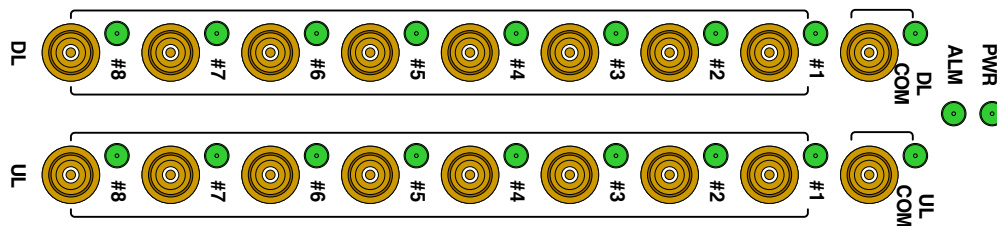

Figure 2-28 POD-H-COM-8 RF port and LED

- RF Port
  - DL #1 ~ #8
    - > Receives downlink signal from up to 8 H-FEM
    - > Connected to DL output port of H-FEM
    - > Connector Type: SMB-L Female
  - DL COM
    - > Combines inputted downlink signals from DL #1 to DL #8 and outputs to H-DTM or H-HOM
    - > Connected to DL input port of H-DTM, or H-HOM
    - > Connector Type: SMB-L Female
  - UL COM
    - > Receives uplink signal from H-DTM or H-HOM
    - > Connected to UL output port of H-DTM, or H-HOM
    - > Connector Type: SMB-L Female
  - UL #1 ~ #8
    - > Divides inputted uplink signals from UL COM port and outputs to H-FEM

- > Connected to UL input port of H-FEM
- > Connector Type: SMB-L Female
- LED

**Table 2-17 POD-H-COM-8 LED Operation**

		Specifications
PWR	Solid Green	When power is on.
	Off	When power is off.
ALM	Off	When POD-H-COM-8 has no alarms.
	Solid Yellow	When POD-H-COM-8 has minor alarm.
	Solid Red	When POD-H-COM-8 has major alarm.
DL #1 ~ #8	Blink Green	At the cable connection guide, green led blinks to indicate which RF ports should be connected to.
DL COM	Blink Green	
UL #1 ~ #8	Blink Green	
UL COM	Blink Green	

**2.1.7.4 Communication port**

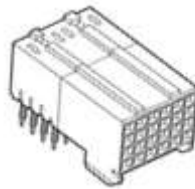

**Figure 2-29 Communication Port**

- This port provides communication path between H-COM-8 and H-SCM through backboard of H-SRU.
- +24V DC is provided through this communication port from backboard of H-SRU.
- H-COM-8 acquires ID information such as Rack ID, Sub rack ID and Slot ID through this communication port. The IP address of H-COM-8 is assigned automatically using the acquired ID information.

**2.1.7.5 Alarms**

**Table 2-18 POD-H-COM-8 - Alarms**

Alarm Name	Description	Remedy	Alarm Severity	LED color
High Temperature	Temperature too high	Check environment	Major	Red
	Temperature high		Minor	Yellow
Low Temperature	Temperature too low		Minor	Yellow
Link	Communication fail	Check pin of communication port/ assigned IP address	Major	Yellow
Downlink ALC Activation	ALC activation	Check H-COM-8 downlink input level/ attenuator configuration	Warning	Yellow

### 2.1.8 POD-H-DTM-8x8

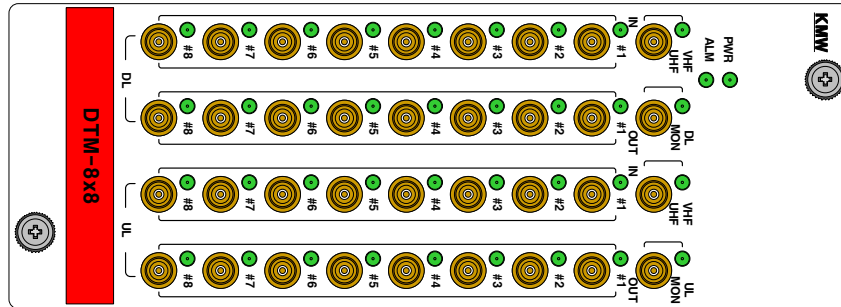

Figure 2-30 POD-H-COM-8

#### 2.1.8.1 Functions and features

- Receives downlink signals from up to 8 H-COM. After then, it combines and distributes them to up to 8 H-HOM.
- Receives uplink signals from up to 8 H-HOM. After then, it combines and distributes them to up to 8 H-COM.
- Combines or distributes VHF, UHF signals
- To minimize negative effects by unused input/output ports such as the degradation of VSWR or isolation between ports, the unused ports can be switched into 50 ohm termination by user
- Support Monitoring Port(DL path/UL Path)
- When any one sector or DAS system needs low power RU less than 4, H-COM can be connected to H-HOM-L directly without H-DTM.
  - > In this case, the attenuator in the common path of H-COM should add 15dB attenuation using web based GUI to compensate the loss of H-DTM.

#### 2.1.8.2 Specifications

- Frequency range: VHF, UHF, 600~2700MHz
- Maximum RF Power: -25dBm@DL, -15dBm@UL
- Size, weight, and power consumption : refer to Table 2-1

#### 2.1.8.3 RF port and LED

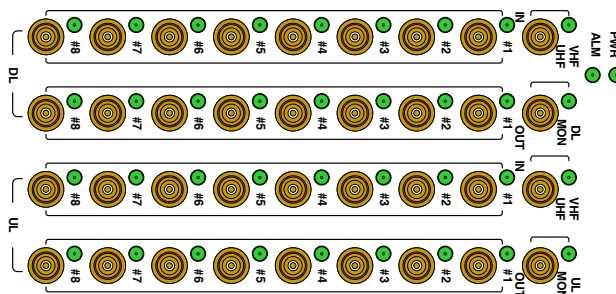

Figure 2-31 POD-H-DTM-8x8 RF port and LED

- RF Port
  - DL IN #1 ~ #8
    - > Receives downlink signal from H-COM, H-STM or H-OIM.
    - > Connected to DL output port of H-COM, H-STM or H-OIM
    - > Connector Type: SMB-L Female
  - DL OUT #1 ~ #8
    - > Combines inputted downlink signals from DL IN #1 to DL IN #8 and outputs to H-HOM

- > Connected to DL input port of H-HOM
- > Connector Type: SMB-L Female
- UL IN #1 ~ #8
  - > Receives uplink signal from up to 8 H-HOM
  - > Connected to UL output port of H-HOM
  - > Connector Type: SMB-L Female
- UL OUT #1 ~ #8
  - > Combines inputted uplink signals from UL IN #1 to UL IN #8 and outputs to H-COM, H-STM or H-OIM
  - > Connected to UL input port of H-COM, H-STM or H-OIM
  - > Connector Type: SMB-L Female
- LED

**Table 2-19 POD-H-DTM-8x8 LED Operation**

		Specifications
PWR	Solid Green	When power is on.
	Off	When power is off.
ALM	Off	When POD-H-DTM-8x8 has no alarms.
	Solid Yellow	When POD-H-DTM-8x8 has minor alarm.
	Solid Red	When POD-H-DTM-8x8 has major alarm.
DL IN #1 ~ #8	Blink Green	At the cable connection guide, green led blinks to indicate which RF ports should be connected to.
DL OUT #1 ~ #8	Blink Green	
UL IN #1 ~ #8	Blink Green	
UL OUT #1 ~ #8	Blink Green	

#### 2.1.8.4 Communication port

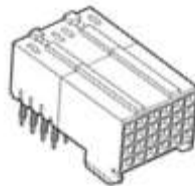

**Figure 2-32 Communication Port**

- This port provides communication path between H-DTM-8x8 and H-SCM through backboard of H-SRU.
- +24V DC is provided through this communication port from backboard of H-SRU.
- H-DTM-8x8 acquires ID information such as Rack ID, Sub rack ID and Slot ID through this communication port. The IP address of H-DTM-8x8 is assigned automatically using the acquired ID information.

#### 2.1.8.5 Alarms

**Table 2-20 POD-H-DTM-8x8 - Alarms**

Alarm Name	Description	Remedy	Alarm Severity	LED color
High Temperature	Temperature too high	Check environment	Major	Red
	Temperature high		Minor	Yellow
Low Temperature	Temperature too low		Minor	Yellow
Link	Communication fail	Check pin of communication port/ assigned IP address	Major	Yellow
Downlink ALC Activation	ALC activation	Check H-DTM downlink input level/ attenuator configuration	Warning	Yellow

### 2.1.9 POD-H-HOM-L

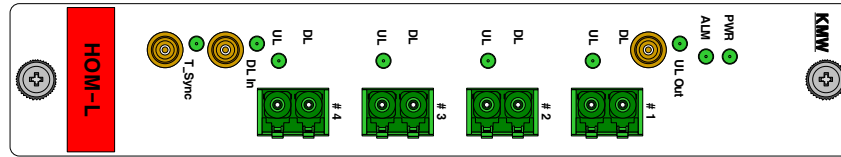

Figure 2-33 POD-H-HOM-L

#### 2.1.9.1 Functions and features

- Converts Downlink RF signal into optical signal and transfers to low power Remote Unit with less than 1W.
- Converts Uplink optic signal received from low power Remote Unit to RF signal and transfers to H-COM, H-STM, or H-DTM.
- Compensates optic loss between HOM-L and low power Remote unit.
- For 2.6G TDD operation, TDD synchronization signal received from H-FEM-B is transferred to low power Remote unit via H-HOM-L.
- Communicates with low power Remote unit by PLC modem.

#### 2.1.9.2 Specifications

- Frequency range: VHF, UHF, 600~2700MHz
- Maximum RF Power: -9dBm@DL, 0dBm@UL
- Size, weight, and power consumption : refer to Table 2-1

#### 2.1.9.3 RF port and LED

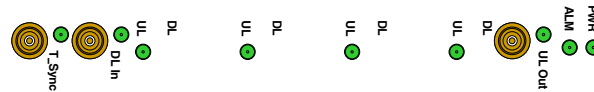

Figure 2-34 POD-H-HOM-L RF port and LED

- RF Port
  - DL IN
    - > Receives downlink signal from H-COM, H-STM or H-DTM.
    - > Connected to DL output port of H-COM, H-STM or H- DTM.
    - > Connector Type: SMB-L Female
  - UL OUT
    - > Outputs uplink signal to H-COM, H-STM or H-DTM
    - > Connected to UL input port of H-COM, H-STM or H-DTM
    - > Connector Type: SMB-L Female
  - T-SYNC IN
    - > Receives TDD synchronization signal from H-FEM-B.
    - > Connected to T-SYNC of H-FEM-B.
    - > Connector Type: SMB-L Female

- LED

Table 2-21 POD-H-HOM-L LED Operation

		Specifications
PWR	Solid Green	When power is on.
	Off	When power is off.
ALM	Off	When POD-H-HOM-L has no alarms.
	Solid Yellow	When POD-H-HOM-L has minor alarm.
	Solid Red	When POD-H-HOM-L has major alarm.

UL #1 ~ #4	Off	When PD fails.
	Solid Yellow	When PD is Normal.
DL IN	Blink Green	At the cable connection guide, green led blinks to indicate which RF ports should be connected to.
UL OUT	Blink Green	
T_Sync	Blink Green	

**2.1.9.4 Optic port**

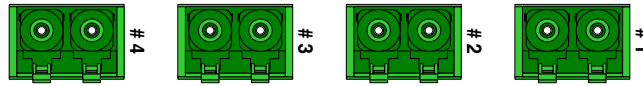

**Figure 2-35** optic port

- LD #1 ~ #4
  - Each optic port is connected to one low power Remote Unit.
  - Transfers downlink optic signal to low power Remote Unit.
  - Connector Type: LC APC Female
- PD #1 ~ #4
  - Each optic port is connected to low power Remote Unit.
  - Receives Uplink optic signal from low power Remote Unit.
  - Connector Type: LC APC Female

**2.1.9.5 Communication port**

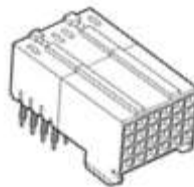

**Figure 2-36** Communication Port

- This port provides communication path between H-HOM-L and H-SCM through backboard of H-SRU.
- +24V DC is provided through this communication port from backboard of H-SRU.
- H-HOM-L acquires ID information such as Rack ID, Sub rack ID and Slot ID through this communication port. The IP address of H-HOM-L is assigned automatically using the acquired ID information.

**2.1.9.6 Alarms**

**Table 2-22** POD-H-HOM-L - Alarms

Alarm Name	Description	Remedy	Alarm Severity	LED color
High Temperature	Temperature too high	Check environment	Major	Red
	Temperature high		Minor	Yellow
Low Temperature	Temperature too low		Minor	Yellow
Link	Communication fail	Check pin of communication port/ assigned IP address	Major	Yellow
DL Optic Fail	Downlink LD fail	Check if optic LD fail alarm occurs again after reset.	Major	Yellow
UL Optic Fail	Uplink PD fail	Check optic cable connection with RU	Major	Yellow
UL Optic Loss	Exceed permitted optic loss	Check optic cable connection with RU / clean Optic connector and port	Minor	Yellow



<b>Alarm Name</b>	<b>Description</b>	<b>Remedy</b>	<b>Alarm Severity</b>	<b>LED color</b>
RU Comm. Fail	RU Communication Fail	Check optic cable connection	Minor	Yellow

### 2.1.10 POD-H-HOM-H

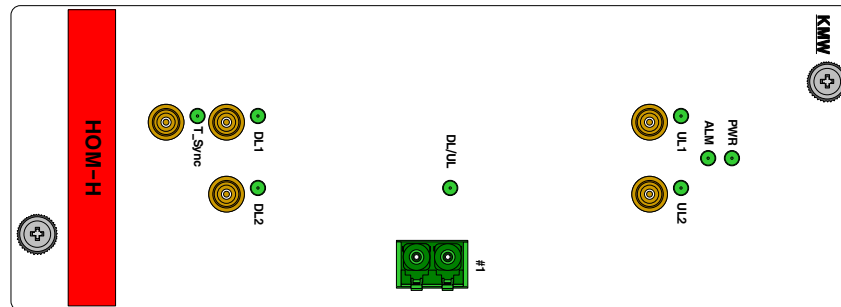

Figure 2-37 POD-H-HOM-H

#### 2.1.10.1 Functions and features

- Converts Downlink RF signal into optical signal and transfers to high power Remote Unit with more than 20W.
- Converts Uplink optic signal received from high power Remote Unit to RF signal and transfers to H-COM, H-STM, or H-DTM.
- Compensates optic loss between HOM-L and high power Remote unit.
- For 2.6G TDD operation, TDD synchronization signal received from H-FEM-B is transferred to high power Remote unit via H-HOM-L.
- Communicates with high power Remote unit by PLC modem.

#### 2.1.10.2 Specifications

- Frequency range: VHF, UHF, 600~2700MHz
- Maximum RF Power: -9dBm@DL, 0dBm@UL
- Size, weight, and power consumption : refer to Table 2-1

#### 2.1.10.3 RF port and LED

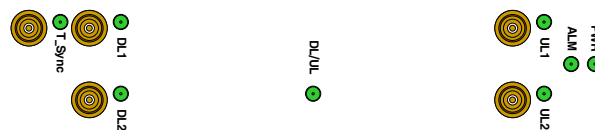

Figure 2-38 POD-H-HOM-H RF port and LED

- RF Port
  - DL 1/DL 2
    - > Receives downlink signal from H-COM, H-STM or H-DTM.
    - > Connected to DL output port of H-COM, H-STM or H- DTM.
    - > Connector Type: SMB-L Female
  - UL 1/UL 2
    - > Outputs uplink signal to H-COM, H-STM or H-DTM
    - > Connected to UL input port of H-COM, H-STM or H-DTM
    - > Connector Type: SMB-L Female
  - T-SYNC IN
    - > Receives TDD synchronization signal from H-FEM-B.
    - > Connected to T-SYNC of H-FEM-B.
    - > Connector Type: SMB-L Female
- LED



**Table 2-23 POD-H-HOM-L LED Operation**

		Specifications
PWR	Solid Green	When power is on.
	Off	When power is off.
ALM	Off	When POD-H-HOM-H has no alarms.
	Solid Yellow	When POD-H-HOM-H has minor alarm.
	Solid Red	When POD-H-HOM-H has major alarm.
DL/UL	Off	When PD fails.
	Solid Yellow	When PD is Normal.
DL 1/DL 2	Blink Green	At the cable connection guide, green led blinks to indicate which RF ports should be connected to.
UL 1/UL 2	Blink Green	
T_Sync	Blink Green	

**2.1.10.4 Optic port**

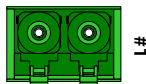

**Figure 2-39 optic port**

- LD
  - Connected to high power Remote Unit.
  - Transfers downlink optic signal to high power Remote Unit.
  - Connector Type: LC APC Female
- PD
  - Connected to high power Remote Unit.
  - Receives Uplink optic signal from high power Remote Unit.
  - Connector Type: LC APC Female

**2.1.10.5 Communication port**

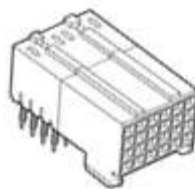

**Figure 2-40 Communication Port**

- This port provides communication path between H-HOM-H and H-SCM through backboard of H-SRU.
- +24V DC is provided through this communication port from backboard of H-SRU.
- H-HOM-H acquires ID information such as Rack ID, Sub rack ID and Slot ID through this communication port. The IP address of H-HOM-H is assigned automatically using the acquired ID information.

**2.1.10.6 Alarms**

**Table 2-24 POD-H-HOM-H - Alarms**

Alarm Name	Description	Remedy	Alarm Severity	LED color
High Temperature	Temperature too high	Check environment	Major	Red
	Temperature high		Minor	Yellow
Low Temperature	Temperature too low		Minor	Yellow



Link	Communication fail	Check pin of communication port/ assigned IP address	Major	Yellow
DL Optic Fail	Downlink LD fail	Check if optic LD fail alarm occurs again after reset.	Major	Yellow
UL Optic Fail	Uplink PD fail	Check optic cable connection with RU	Major	Yellow
UL Optic Loss	Exceed permitted optic loss	Check optic cable connection with RU / clean Optic connector and port	Minor	Yellow
RU Comm. Fail	RU Communication Fail	Check optic cable connection	Minor	Yellow

### 2.1.11 POD-H-STM-8x4

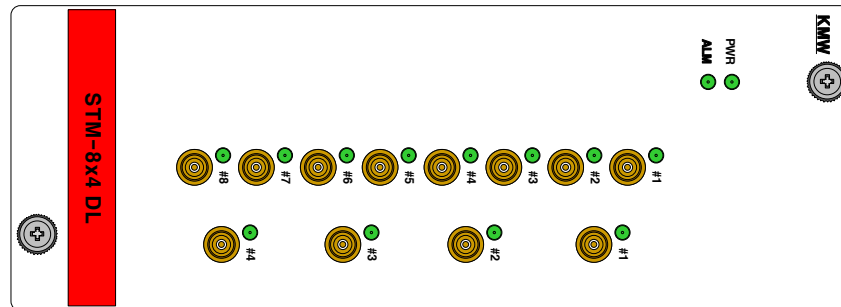

Figure 2-41 POD-H-STM-8x4-DL

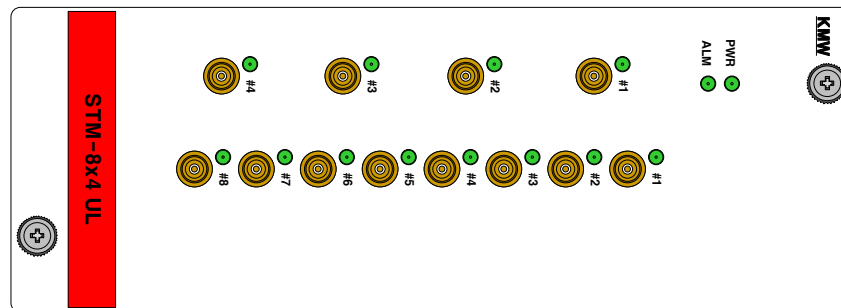

Figure 2-42 POD-H-STM-8x4-UL

#### 2.1.11.1 Functions and features

- Programmable sectorization can be supported by using H-STM-8x4.
- Based on programmed sector definition, DL output signals received from H-FEM are combined by each sector and transferred to H-DTM, or H-HOM.
- Based on programmed sector definition, received UL signals from H-DTM, or H-HOM are distributed and transferred to H-FEM.
- For each sector, controls Power Ratio for multiple H-FEM with same frequency band to share DL output power at Remote Unit
- ALC function for DL/UL Path
- To minimize negative effects by unused input/output ports such as the degradation of VSWR or isolation between ports, the unused ports can be switched into 50 ohm termination by user.
- When any one sector consists of remote unit less than 4, H-STM-8x4 can be connected to H-HOM-L directly without H-DTM.
  - > In this case, the attenuator in the common path of H-STM-8x8 should add 15dB attenuation using web based GUI to compensate the loss of H-DTM.

#### 2.1.11.2 Specifications

- Frequency range: 600~2700MHz
- Maximum RF Power: -10dBm@DL, 25dBm@UL
- Size, weight, and power consumption : refer to Table 2-1

### 2.1.11.3 RF port and LED

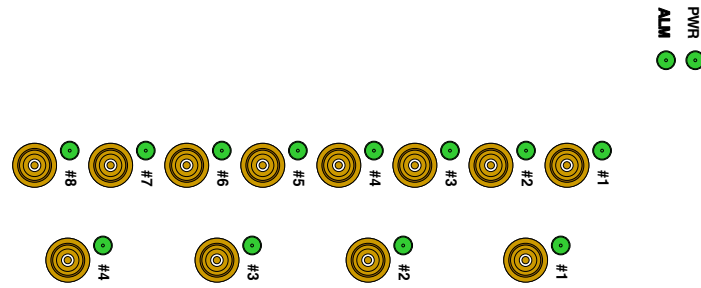

**Figure 2-43** POD-H-STM-8x4-DL RF port and LED

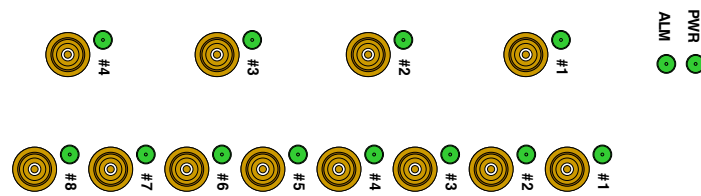

**Figure 2-44** POD-H-STM-8x4-UL RF port and LED

- RF port
  - POD-H-STM-8x4-DL
    - > DL IN #1 ~ #8
      - Receives downlink signal from up to 8 H-FEM
      - Connected to DL output port of H-FEM
      - Connector Type: SMB-L Female
    - > DL OUT #1 ~ #4
      - Combines inputted downlink signals and outputs to H-DTM or H-HOM by each sector
      - Connected to DL input port of H-DTM, or H-HOM for each sector
      - Connector Type: SMB-L Female
  - POD-H-STM-8x4-UL
    - > UL IN #1 ~ #8
      - Receives uplink signals from H-DTM, or H-HOM for each sector
      - Connected to UL output port of H-DTM, or H-HOM for each sector
      - Connector Type: SMB-L Female
    - > UL OUT #1 ~ #4
      - Distributes uplink signals inputted from UL IN #1~#8 port by each sector and outputs to H-FEM
      - Connected to UL input port of H-FEM
      - Connector Type: SMB-L Female

- LED

**Table 2-25 POD-H-STM-8x4 LED Operation**

		Specifications
PWR	Solid Green	When power is on.
	Off	When power is off.
ALM	Off	When POD-H-STM-8x4-DL (UL) has no alarms.
	Solid Yellow	When POD-H-STM-8x4-DL (UL) has minor alarm.
	Solid Red	When POD-H-STM-8x4-DL (UL) has major alarm.
DL IN #1 ~ #8	Blink Green	At the cable connection guide, green led blinks to indicate which RF ports should be connected to.
DL OUT #1 ~ #4	Blink Green	
UL IN #1 ~ #8	Blink Green	
UL OUT #1 ~ #4	Blink Green	

#### 2.1.11.4 Communication port

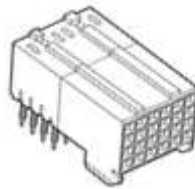

**Figure 2-45 Communication Port**

- This port provides communication path between H-STM and H-SCM through backboard of H-SRU.
- +24V DC is provided through this communication port from backboard of H-SRU.
- H-STM acquires ID information such as Rack ID, Sub rack ID and Slot ID through this communication port. The IP address of H-STM is assigned automatically using the acquired ID information.

#### 2.1.11.5 Alarms

**Table 2-26 POD-H-STM-8x8 - Alarms**

Alarm Name	Description	Remedy	Alarm Severity	LED color
High Temperature	Temperature too high	Check environment	Major	Red
	Temperature high		Minor	Yellow
Low Temperature	Temperature too low		Minor	Yellow
Link	Communication fail	Check pin of communication port/ assigned IP address	Major	Yellow
Downlink ALC Activation	ALC activation	Check H-STM downlink input level/ attenuator configuration	Warning	Yellow

**2.1.12 POD-H-PSU-x**

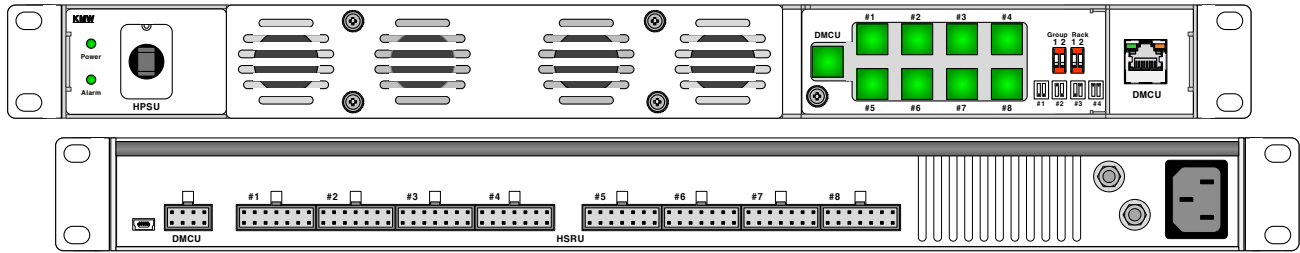

**Figure 2-46 POD-H-PSU-x**

**2.1.12.1 Functions and features**

- Distributes +24Vdc to DMCU and up to 8 H-SRUs
- Turn on or off each DC output individually in a local or remote site
- Set Rack ID

**2.1.12.2 Specifications**

- AC input Range: AC 100~240V (47~63Hz)
- Size, weight, and power consumption : refer to Table 2-1

**2.1.12.3 LED**



Power



Alarm

**Figure 2-47 POD-H-PSU-x LED**

**Table 2-27 POD-H-PSU-x LED Operation**

		Specifications
PWR	Solid Green	When power is on.
	Off	When power is off.
ALM	Off	When POD-H-PSU-x has no alarms.
	Solid Yellow	When POD-H-PSU-x has minor alarm.
	Solid Red	When POD-H-PSU-x has major alarm.

**2.1.12.4 Ethernet Port**



**DMCU**

**Figure 2-48 Ethernet Port**

- DMCU port
  - Connected to H-DMCU so that H-DMCU can monitor and control H-PSU

**2.1.12.5 AC input on/off Switch & DC output on/off switch**

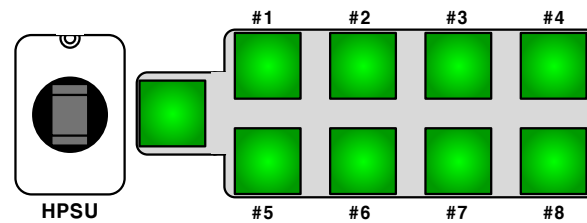

Figure 2-49 AC input on/off Switch & DC output on/off switch

- AC input on/off switch
  - Be able to turn AC input on (off) manually by using AC input on/off switch
- DC output on/off switch
  - Be able to turn each DC output on (off) separately
  - Toggle type
    - > When you press DC output on/off switch, the LED light of DC output on/off switch and 24V DC output turn on, and when you press it again, LED light and 24V DC output turn off.
  - DC output on/off switch can be turned on (off) in local and remote site

2.1.12.6 AC input port & DC output port

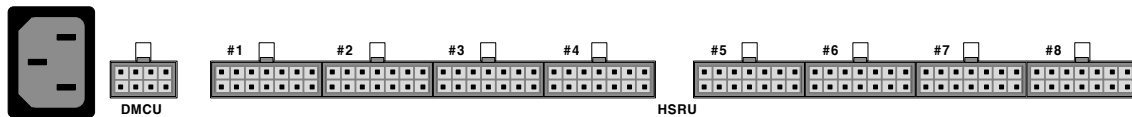

Figure 2-50 AC input port & DC output port

- AC input port
  - Use 3 wire AC code (Line, Neutral, GND)
- DC output port
  - One DC output port for H-DMCU
    - > DC output connector contains +24V DC, Rack ID, and insert pin.
  - Eight DC output port for H-SRU
    - > Each DC output connector contains +24V DC, Rack ID, and insert pin.

2.1.12.7 Rack ID

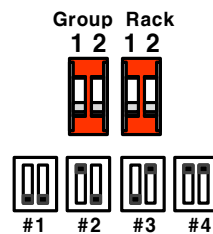

Figure 2-51 Rack ID

- Group is not used
- Rack ID
  - Rack ID can be set from 1 to 4.
  - One H-DMCU can support up to 4 racks, and one H-DMCU needs maximum 4 H-PSU because one H-PSU can supply 24V DC power to **only one rack** that can be composed of up to 8 H-SRUs and one DMCU.
  - H-DMCU and each H-SCM in H-SRU can identify its own rack ID through the cable connection with H-PSU.

- **CAUTION**) The rack ID connected to H-DMCU must be set as 1.

**Table 2-28 Rack ID**

DIP Switch Setting	Group 1	Group 2	Rack 1	Rack 2
Rack ID #1	X	X	OFF	OFF
Rack ID #2	X	X	ON	OFF
Rack ID #3	X	X	OFF	ON
Rack ID #4	X	X	ON	ON

**2.1.12.8 Ground port**

- Refer to section 3.2.2

**2.1.12.9 Alarms**

**Table 2-29 POD-H-PSU - Alarms**

Alarm Name	Description	Remedy	Alarm Severity	LED color
High Temperature	Temperature too high	Check environment	Major	Red
	Temperature high		Minor	Yellow
Low Temperature	Temperature too low		Minor	Yellow
Voltage	High Voltage	Check if High voltage alarm occurs again after reset.	Major	Red
Current	High Current	Check if current alarm occurs again after reset.	Major	Red
Low Voltage	Low Voltage	Check if low voltage alarm occurs again after reset.	Major	Yellow



### 2.1.13 POD-H-CDU

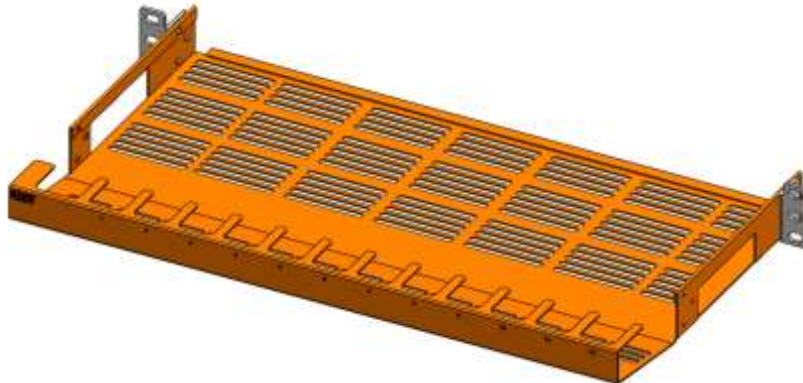
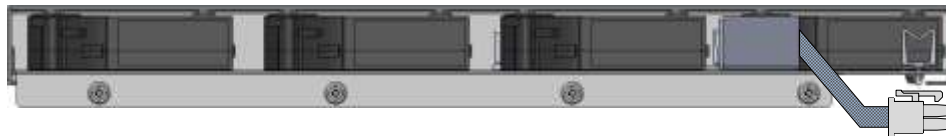

**Figure 2-52**      **POD-H-CDU**

#### 2.1.13.1 Functions and features

- Provides cable routing space when RF, optic, DC power, and Ethernet cables are connected between the modules or units in POD DAS system.
- Has good space efficiency since H-FAU can be installed behind H-CDU

### 2.1.14 POD-H-FAU



**Figure 2-53**      **POD-H-FAU**

#### 2.1.14.1 Functions and features

- Installed right above the H-SRU for dissipating heat comes from the modules installed in POD-H-SRU.
- Good space efficiency since H-FAU can be installed behind H-CDU
- DC Power is provided from FAN port located in the back side of H-SRU
- FAN speed control and FAN on/off is controlled automatically by H-SCM based on the temperature of modules installed in H-SRU.
- FAN fail alarm is monitored by H-SCM.

#### 2.1.14.2 The rules for installing FAN unit

- When the number of module installed in a POD-H-SRU is less than 5, it doesn't need the installation of H-FAU.
- When the number of module installed in a POD-H-SRU is more than 6, It needs the installation of POD-H-FAU.
  - > We strongly recommend that each module should be installed every other slot in a POD-H-SRU.
- When POD-H-SRUs more than 2 are stacked in one rack, one POD-H-FAU per 2 POD-H-SRU should be installed regardless of the number of module installed in one POD-H-SRU.
  - > We strongly recommend that each module should be installed with sufficient gap as far as possible when the modules in a POD-H-SRU are not fully installed.

#### 2.1.14.3 Port

- H-FAU must be connected with FAN port which is located in the back of H-SRU (refer to Figure 2-9) by provided signal cable.

- Control signal for FAN speed control, DC power and FAN alarm signal are transferred between H-FAU and H-SCM through this signal cable.

**2.1.14.4 Alarms**

**Table 2-30 POD-H-FAU - Alarms**

Alarm Name	Description	Remedy	Alarm Severity	LED color
FAN	FAN fail	Replace FAN	Minor	Yellow

## 2.2 Remote Unit

RU (Remote Unit) provides wireless service coverage to users by transmitting downlink signal through the service antenna.

- Remote units which is supported by KMW are as below.
  - 7/5/3 band RU for commercial band service (POD-R-7S8CPAWB-2730-AC/DC)
  - PS700/800 RU for public safety band service (POD-R-P78-27-AC/DC)
  - High power RU with 20/40W output power (POD-R-4346-AC/DC)

### 2.2.1 7/5/3 band RU for commercial band service (POD-R-7S8CPAWB-2730-AC/DC)

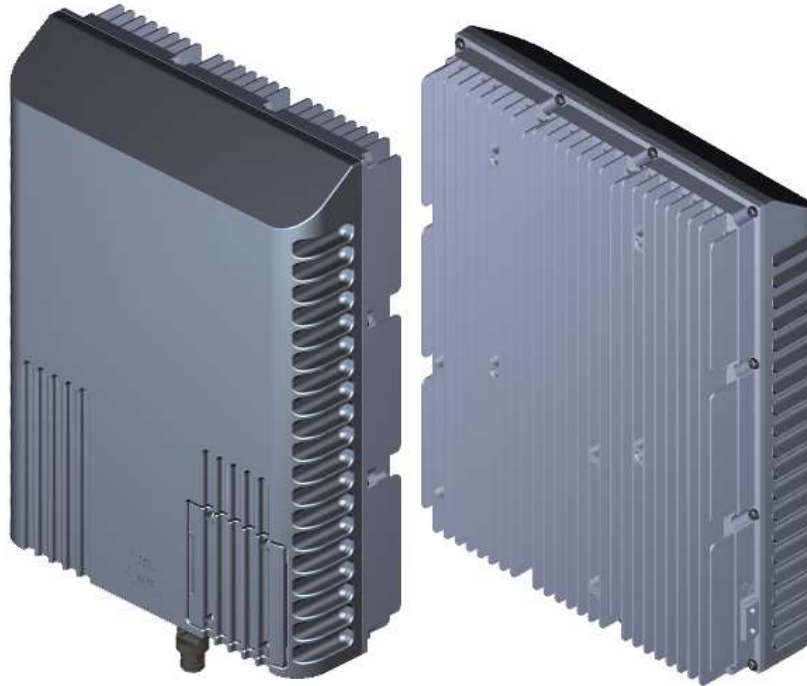

**Figure 2-54 Remote Unit – 7/5/3 band**

#### 2.2.1.1 Functions and features

- Supported frequency band
  - > 3\_band RU: SMR800, PCS, and 2.6G TDD
  - > 5\_band RU: 700M, 850M, PCS, AWS, and WCS
  - > 7\_band RU: 700M, SMR800+850M, PCS, AWS, WCS, and 2.6G TDD
- VSWR measurement function for checking VSWR of the connected service antenna
- Built-in Test tone generator in order to check uplink path verification
- Increase scalability by supporting expansion RU
  - > Expansion RU is connected with main RU through AUX DL/UL port by using RF cable
  - > Expansion RU can be added, when it needs additional frequency band other than frequency bands being used in main RU, or additional filter attenuation in the frequency band being used in main RU. In the latter case, the frequency band which needs additional filter attenuation must be off in main RU and replaced by the frequency band with strengthened filter attenuation in expansion RU.

#### 2.2.1.2 Specifications

- Common Specifications
  - Operating Temperature: -40~55°C

- Input Power
  - > AC type: 110V, 50-60 Hz
  - > DC Type: -48V
- IP rating: IP65
- Cooling method: convection cooling
- Dimension: (WxHxD) 13 x 17.3 x 4.7 in (330 x 440 x 120mm)
- Weight: 37.5 lbs (17kg)
- 
- 700M, SMR800 + 850M

**Table 2-31 3/5/7 band RU - 700M, SMR800 + 850M Specifications**

		700M		SMR800+850M
		Lower ABC	Upper C	
Frequency Band	Downlink	728.0M - 746.0M	746.0M - 756.0M	862.0M - 894.0M
	Uplink	698.0M - 716.0M	777.0M - 787.0M	817.0M - 849.0M
Bandwidth		18.0 MHz	10.0 MHz	32 MHz
Mean Gain	Downlink	36 ± 1.0 dB		36 ± 1.0 dB
	Uplink	37 ± 1.0 dB	37±1.0 dB	37 ± 1.0 dB
Maximum Gain	Downlink	42 dB		
	Uplink	37 dB		
Ripple(p-p)	Downlink	2.5 dB		2.0 dB
	Uplink	2.5 dB	4.0 dB @Full band 2.5dB@ 777~786M	2.0 dB
Maximum downlink output power		27 dBm		27 dBm
Uplink Noise Figure @center freq.		4.00 dB	4.00 dB	4.00 dB
VSWR		< 1:1.7		
Delay		< 5.00 us		
EVM		< 5.0 % @E-TM 3.1		
Operating band unwanted emissions		Meet FCC, 3GPP WCDMA/LTE Repeater Spec., 3GPP2 CDMA spec.		
Out of band emission		Meet FCC, 3GPP WCDMA/LTE Repeater Spec., 3GPP2 CDMA spec.		

- PCS, AWS

**Table 2-32 3/5/7 band RU – PCS, AWS Specifications**

		PCS	AWS
Frequency Band	Downlink	1930.0M - 1995.0M	2110.0M - 2180.0M
	Uplink	1850.0M-1915.0M	1710.0M-1780.0M
Bandwidth		65.0 MHz	70.0 MHz
Mean Gain	Downlink	39 ± 1.0 dB	39 ± 1.0 dB
	Uplink	40 ± 1.0 dB	40 ± 1.0 dB
Maximum Gain	Downlink	45 dB	
	Uplink	40 dB	
Ripple(p-p)	Downlink	3.5 dB@ Full band 2.5dB (excluding band edge)	2.0 dB
	Uplink	3.5 dB 2.5dB (excluding band edge)	2.0 dB
Maximum downlink output power		30 dBm	30 dBm
Uplink Noise Figure @center freq.		4.00 dB	4.00 dB

	PCS	AWS
VSWR	< 1:1.7	
Delay	< 5.00 us	
EVM	< 5.0 % @E-TM 3.1	
Operating band unwanted emissions	Meet FCC, 3GPP WCDMA/LTE Repeater Spec., 3GPP2 CDMA spec.	
Out of band emission	Meet FCC, 3GPP WCDMA/LTE Repeater Spec., 3GPP2 CDMA spec.	

- WCS, 2.65G

**Table 2-33 3/5/7 band RU – WCS, 2.6G Specifications**

		WCS	2.6G
Frequency Band	Downlink	2350.0M - 2360.0M	2496.0M - 2690.0M
	Uplink	2305.0M-2315.0M	2496.0M-2690.0M
Bandwidth		10.0 MHz	194.0 MHz
Mean Gain	Downlink	39 ± 1.0 dB	39 ± 1.0 dB
	Uplink	40 ± 1.0 dB	40 ± 1.0 dB
Maximum Gain	Downlink	45 dB	
	Uplink	40 dB	
Ripple(p-p)	Downlink	2.5 dB	3.5 dB
	Uplink	1.75 dB	3.5 dB
Maximum downlink output power		30 dBm	30 dBm
Uplink Noise Figure @center freq.		5.00 dB	4.00 dB
VSWR		< 1:1.7	
Delay		< 5.00 us	< 2.00 us
EVM		< 5.0 % @E-TM 3.1	
Operating band unwanted emissions		Meet FCC, 3GPP WCDMA/LTE Repeater Spec.	
Out of band emission		Meet FCC, 3GPP WCDMA/LTE Repeater Spec.	

2.2.1.3 RF ports and LED

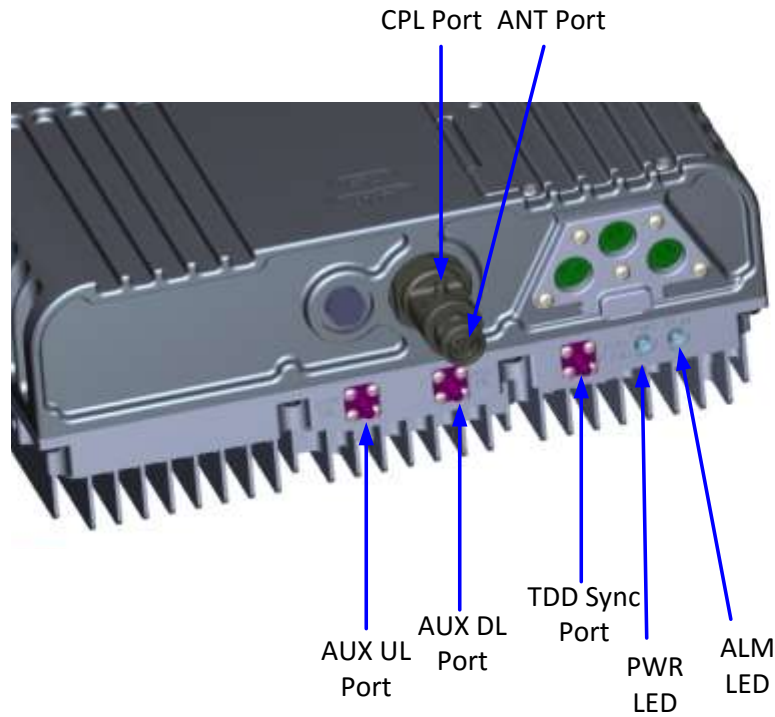

Figure 2-55 Remote Unit External Interfaces

- RF port
  - ANT port
    - > Connected to Service antenna
    - > Mini DIN, female type
  - CPL port
    - > Can be connected to spectrum analyzer to monitor downlink spectrum without interrupting wireless service
    - > SMA female type
  - AUX UL & DL
    - > Connected to expansion remote unit
    - > QMA female type
  - TDD sync port
    - > Provides TDD sync signal which can be used to synchronize with TDD signal measuring equipment such as spectrum analyzer.
    - > QMA female type
- LED

Table 2-34 7/5/3 band RU LED Operation

		Specifications
PWR	Solid Green	When power is on.
	Off	When power is off.
ALM	Off	When 7/5/3 band RU has no alarms.
	Solid Yellow	When 7/5/3 band RU has minor alarm.
	Solid Red	When 7/5/3 band RU has major alarm.

2.2.1.4 Debug Window

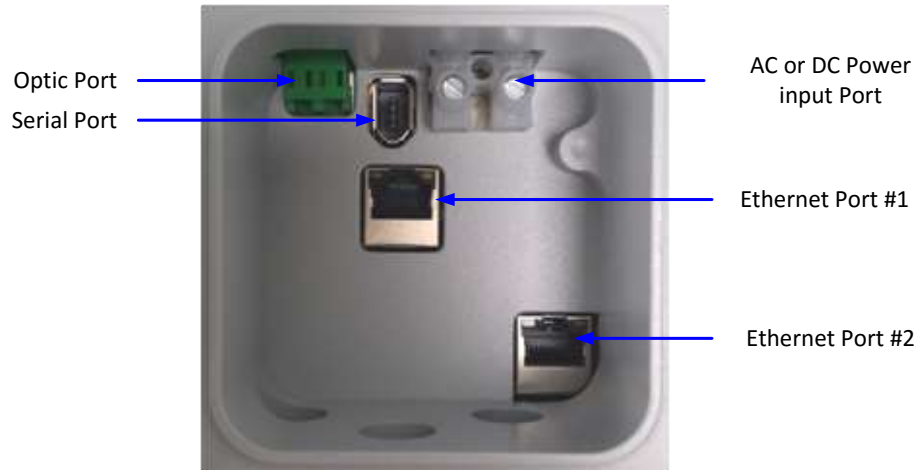
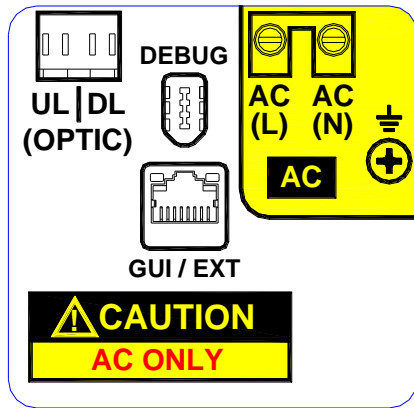
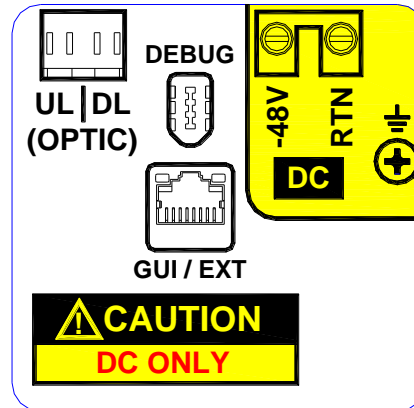

Figure 2-56 Debug Window

User can know the name for each port of RU by attached sticker on the cover of debug window when user opens debug window. User can verify whether RU is AC or DC type, and RU is main RU or expansion RU.



Main RU - AC type



Main RU - DC type

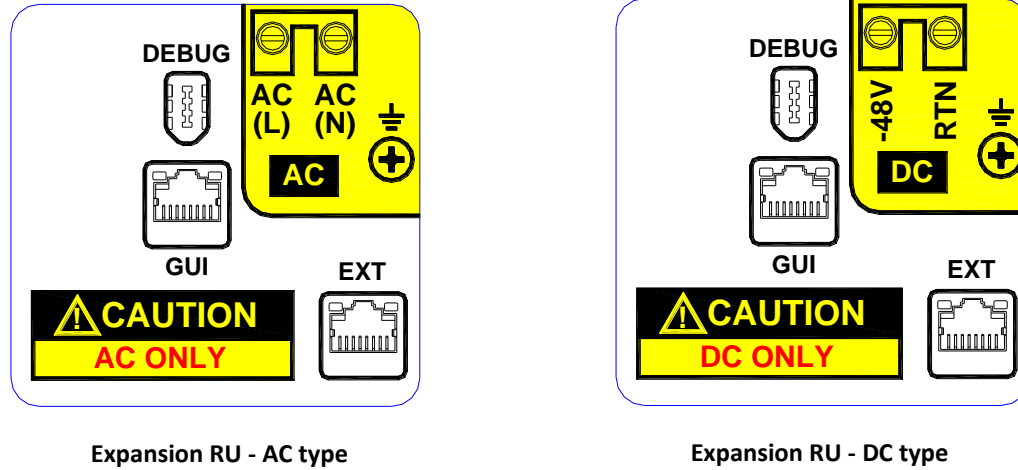

Figure 2-57 Port name for each RU type

- Optic port
  - Connected to Head-end
  - Expansion RU doesn't need optic port because it is connected to main RU through RF cable.
  - LC/APC Female type
  - Wavelength: 1310nm for downlink, 1550nm for uplink
- Serial port (DEBUG): Used for internal debug
- AC or DC power input port
  - AC or DC power source is provided into Remote unit through this port.
    - > 110V AC, 50~60Hz or DC -48V

**! CAUTION**

***Make sure whether remote unit is AC or DC type before connecting input power to AC or DC input port***  
 Because AC and DC input port uses same connector, user might be confused, so that the wrong connection of input power might cause severe damage of remote unit.  
 User can check easily whether remote unit is AC or DC type by checking the picture of sticker attached to the debug window cover when you open it. (refer to Figure 2-57)

- Ethernet Port
  - Ethernet Port #1
    - > Used as GUI Port to access web-based GUI when expansion RU is not connected
    - > Used for connecting to expansion RU when expansion RU is connected to main RU.
    - > Use GUI port in expansion RU to access web-based GUI when expansion RU is connected
  - Ethernet Port #2
    - > Used as GUI Port to access web-based GUI for only expansion RU



2.2.1.5 Alarms

Table 2-35 3/5/7 band RU – Alarms

Alarm Name	Description	Remedy	Alarm Severity	LED color
High Temperature	Temperature too high	Check environment	Major	Red
	Temperature high		Minor	Yellow
Low Temperature	Temperature too low		Minor	Yellow
Downlink High Output Power	RF signal too high	Check Head-end downlink input level/ attenuator configuration/ALC status	Major	Red
	RF signal high		Major	Yellow
Uplink High Input Power	RF signal too high	Check RU uplink input level/ attenuator configuration/ ALC status	Major	Red
	RF signal high		Major	Yellow
Downlink Low Output Power	RF signal too low	Check Head-end downlink input level/ attenuator configuration/ RF cabling	Minor	Yellow
Link	Communication fail	Check cable connection	Major	Yellow
Freeze	The final stage of Shutdown process	Check if shutdown process is going again after reset	Major	Red
Downlink ALC Activation	ALC activation	Check Head-end downlink input level/ attenuator configuration	Warning	Yellow
Uplink PLL Unlock	Uplink PLL unlock	Check if uplink PLL is still in unlocked status after resetting PLL frequency	Minor	Yellow
VSWR	Bad RF cable/mismatched service antenna	Check cable between RU and service antenna, VSWR of service antenna	Major	Yellow
Optic LD Fail	Uplink LD fail	Check if optic LD fail alarm occurs again after reset.	Major	Yellow
Optic PD Fail	Downlink PD fail	Check optic cable connection with H-HOM	Major	Yellow
Optic Loss	Excess permitted optic loss	Check optic cable connection with H-HOM / clean Optic connector and port	Minor	Yellow
High current	Power supply load too high	Check if current alarm occurs again after reset.	Major	Red
Sync fail	No TDD sync signal is acquired	Check optic cable connection with H-HOM and 2.6G downlink input signal	Major	Yellow

2.2.1.6 Grounding

- Refer to section 3.3.2

## 2.2.2 PS700/800 RU for public safety 700/800 frequency band service (POD-R-P78-27-AC/DC)



**Figure 2-58 Remote Unit – PS700/800**

### 2.2.2.1 Functions and features

- Supported frequency band: Public Safety 700M & 800M
- VSWR measurement function for checking VSWR of the connected service antenna
- Built-in Test tone generator in order to check uplink path verification
- Increase scalability by supporting expansion RU
  - > Connected between expansion RU and main RU through AUX DL/UL port by using RF cable
  - > Expansion RU can be added, when it needs additional frequency band other than frequency bands being used in main RU, or additional filter attenuation in the frequency band being used in main RU. In the latter case, the frequency band which needs additional filter attenuation must be off in main RU and replaced by the frequency band with strengthened filter attenuation in expansion RU.

### 2.2.2.2 Specifications

- Operating Temperature: -40~55°C
- Input Power
  - > AC type: 110V, 50-60 Hz
  - > DC Type: -48V
- Power Consumption: <55W
- IP rating: IP65
- Cooling method: convection cooling
- Dimension: (WxHxD) 13 x 12.2 x 3.9 in (330 x 310 x 100mm)
- Weight: 22.5 lbs (10.2kg)

**Table 2-36 PS700/800 RU - Specifications**

		PS700	PS800
Frequency Band	Downlink	758.0M - 775.0M	851M - 869M
	Uplink	788.0M - 805.0M	806.0M - 824.0M
Bandwidth		17.0 MHz	18.0 MHz
Mean Gain	Downlink	36 ± 1.0 dB	36 ± 1.0 dB
	Uplink	37 ± 1.0 dB	37 ± 1.0 dB
Maximum Gain	Downlink	67 dB	
	Uplink	37 dB	
Ripple(p-p)	Downlink	3.5 dB @Full band 2.0 dB @759~774M	3.5 dB @Full band 2.0 dB @852~869M
	Uplink	5.3 dB @Full band 2.0 dB @789~804M	5.3 dB @Full band 2.0 dB @807~824M
Maximum downlink output power		27 dBm	27 dBm
Uplink Noise Figure @center freq.		4.00 dB	4.00 dB
VSWR		< 1:1.7	
Delay		< 5.00 us	
EVM		< 5.0 % @E-TM 3.1	
Operating band unwanted emissions		Meet FCC, LTE Repeater Spec.	
Out of band emission		Meet FCC, LTE Repeater Spec.	

**2.2.2.3 RF ports and LED**

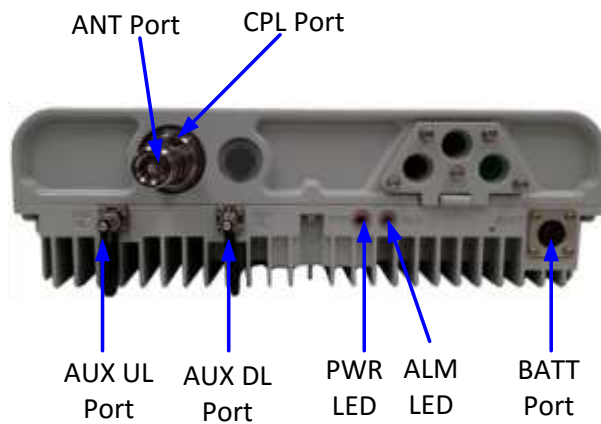

**Figure 2-59 Remote Unit - PS700/800 External Interfaces**

- RF port
  - ANT port
    - > Connected to Service antenna
    - > Mini DIN, female type
  - CPL port
    - > Can be connected to spectrum analyzer to monitor downlink spectrum without interrupting wireless service
    - > SMA female type
  - AUX UL & DL
    - > Connected to expansion remote unit
    - > QMA female type

- TDD sync port
  - > Provides TDD sync signal which can be used to synchronize with TDD signal measuring equipment such as spectrum analyzer.
  - > QMA female type
- LED

**Table 2-37 7/5/3 band RU LED Operation**

		Specifications
PWR	Solid Green	When power is on.
	Off	When power is off.
ALM	Off	When PS700/800 band RU has no alarms.
	Solid Yellow	When PS700/800 band RU has minor alarm.
	Solid Red	When PS700/800 band RU has major alarm.

**2.2.2.4 Debug Window**

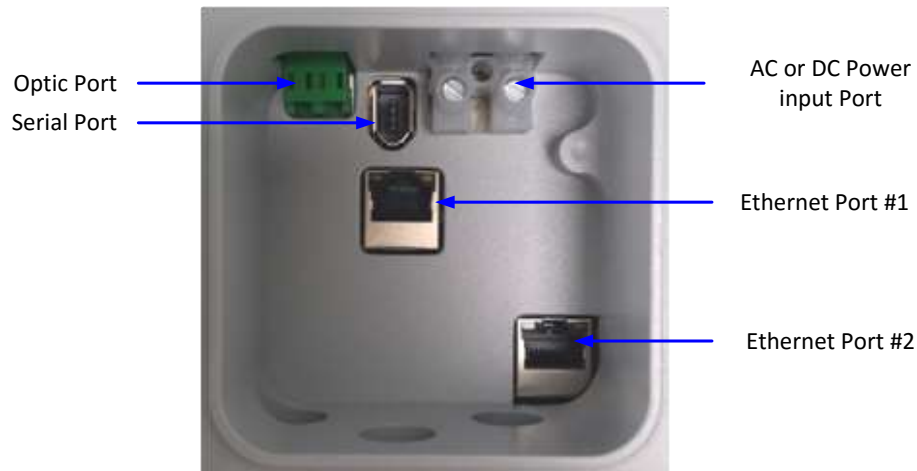

**Figure 2-60 Debug Window**

User can know the name for each port of RU by the sticker attached on the cover of debug window when user opens debug window. User can verify whether RU is AC or DC type, and RU is main RU or expansion RU.

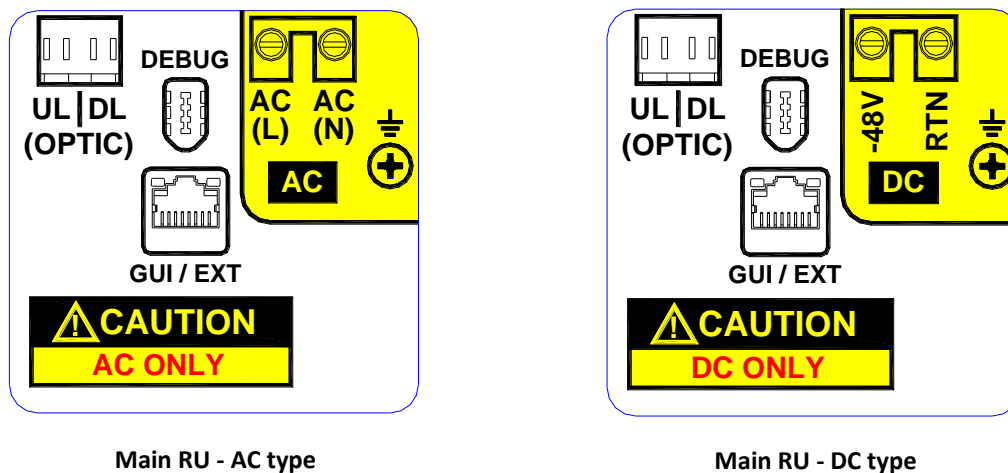

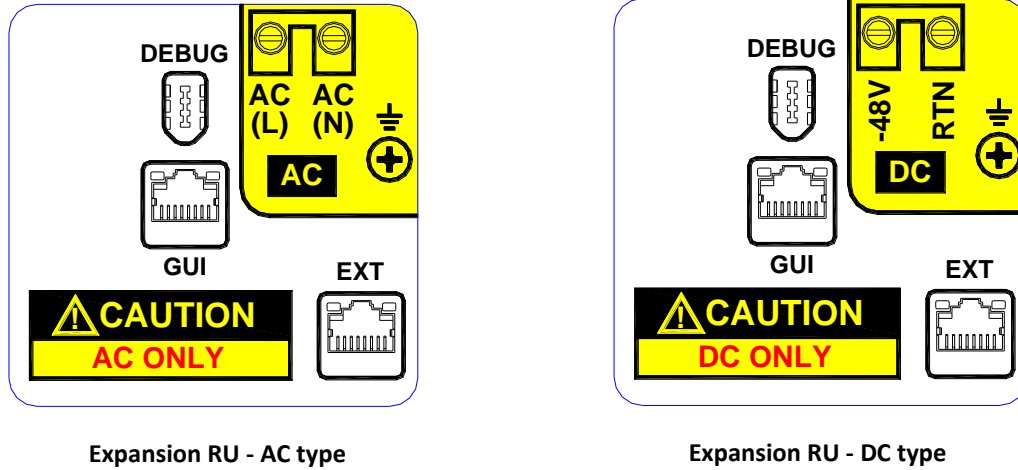

Figure 2-61 Port name for each RU type

- Optic port
  - Connected to Head-end
  - Expansion RU doesn't need optic port because it is connected to main RU through RF cable.
  - LC/APC Female type
  - Wavelength: 1310nm for downlink, 1550nm for uplink
- Serial port (DEBUG): Used for internal debug
- AC or DC power input port
  - AC or DC power source is provided into Remote unit through this port.
    - > 110V AC, 50~60Hz or DC -48V

**! CAUTION**

***Must verify whether remote unit is AC or DC type before connecting input power to AC or DC input port because AC and DC power input port has same form factor.***

It might cause severe damage of remote unit when user connects AC input to DC power input port of DC type RU or DC input to AC power input port of AC type RU in the wrong way.

User can verify easily whether remote unit is AC or DC type by checking the picture of sticker attached to the debug window cover when you open it. (refer to Figure 2-61)

- Ethernet Port
  - Ethernet Port #1
    - > Used as GUI Port to access web-based GUI when expansion RU is not connected
    - > Used for connecting to expansion RU when expansion RU is connected to main RU.
    - > Use GUI port in expansion RU to access web-based GUI when expansion RU is connected
  - Ethernet Port #2
    - > Used as GUI Port to access web-based GUI for only expansion RU

**2.2.2.5 Battery Backup Port**

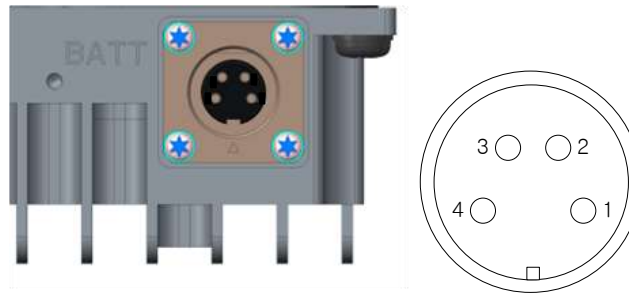

**Figure 2-62 Battery backup port**

- Connected to rechargeable battery

**Table 2-38 Pin map - Battery Backup Port**

Pin Assign		Specifications
1	DC	26V
2	DC	26V
3	GND	GND
4	GND	GND

### 2.2.2.6 Alarms

**Table 2-39 PS700/800 band RU – Alarms**

Alarm Name	Description	Remedy	Alarm Severity	LED color
High Temperature	Temperature too high	Check environment	Major	Red
	Temperature high		Minor	Yellow
Low Temperature	Temperature too low		Minor	Yellow
Downlink High Output Power	RF signal too high	Check Head-end downlink input level/ attenuator configuration/ ALC status	Major	Red
	RF signal high		Major	Yellow
Uplink High Input Power	RF signal too high	Check RU uplink input level/ attenuator configuration/ ALC status	Major	Red
	RF signal high		Major	Yellow
Downlink Low Output Power	RF signal too low	Check Head-end downlink input level/ attenuator configuration/ RF cabling	Minor	Yellow
Link	Communication fail	Check cable connection	Major	Yellow
Freeze	The final stage of Shutdown process	Check if shutdown process is going again after reset	Major	Red
Downlink ALC Activation	ALC activation	Check Head-end downlink input level/ attenuator configuration	Warning	Yellow
Uplink PLL Unlock	Uplink PLL unlock	Check if uplink PLL is still in unlocked status after resetting PLL frequency	Minor	Yellow
VSWR	Bad RF cable/mismatched service antenna	Check cable between RU and service antenna, VSWR of service antenna	Major	Yellow
Optic LD Fail	Uplink LD fail	Check if optic LD fail alarm occurs again after reset.	Major	Yellow

Optic PD Fail	Downlink PD fail	Check optic cable connection with H-HOM	Major	Yellow
Optic Loss	Excess permitted optic loss	Check optic cable connection with H-HOM / clean Optic connector and port	Minor	Yellow
High current	Power supply load too high	Check if current alarm occurs again after reset.	Critical	Red

**2.2.2.7 Grounding**

- Refer to section 3.3.2



### 3. EQUIPMENT INSTALLATION

#### 3.1 Inspection before equipment installation

Please follow these procedures before installing KMW POD equipments:

- Verify the number of packages received against the packing list.
- Check all packages for external damage; report any external damage to the shipping carrier.
- Open and check each package against the packing list. If any items are missing, contact KMW customer service.

#### 3.1.1 The Part list for each unit

##### 3.1.1.1 Head-end Unit

##### 3.1.1.1.1 POD-H-DMCU

	Q'ty	Length	Comments
H-DMCU	1		
H-CDU	1		Cable Duct Unit
Quick Installation Guide	1		
Rack mount bracket	1		
Power & signal cable between H-DMCU and H-PSU	1	30cm	Refer to section 4.1.1
Ethernet Cable for Web GUI or modem connection	1	2m	
GND Cable	1	1m	

##### 3.1.1.1.2 POD-H-PSU

	Q'ty	Length	Comments
H-PSU	1		
Quick Installation Guide	1		
Rack mount bracket	1		
Power & signal cable between H-DMCU and H-PSU	1	2m	Refer to section 4.1.1
Ethernet Cable between H-DMCU and H-PSU	1	2m	
GND Cable	1	1m	
AC Cable (H-SPU-AC only)	1	2m	

##### 3.1.1.1.3 POD-H-SRU

	Q'ty	Length	Comments
H-SRU	1		
H-FAU	1		FAN Unit
Quick Installation Guide	1		
Rack mount bracket	1		
Power & signal cable between H-PSU and H-SRU	1	2m	Refer to section 4.1.1
Power & signal cable between H-SRU and H-FAU	1	2m	
GND Cable	1	1m	

##### 3.1.1.1.4 POD-H-SCM

	Q'ty	Length	Comments
H-SCM	1		
Ethernet Cable between H-DMCU and H-SCM, or between H-MCM and H-SCM	1	2m	Refer to section 4.1.1

##### 3.1.1.1.5 POD-H-MCM

	Q'ty	Length	Comments
H-MCM	1		
Ethernet Cable between H-DMCU and H-MCM	1	2m	Refer to section 4.1.1





**3.1.1.2 Remote Unit**

**3.1.1.2.1 7/5/3 band RU, PS700/800 RU**

	Q'ty	Length	Comments
7/5/3 band RU or PS700/800 RU	1		
Quick Installation Guide	1		
wall mount bracket	1		
AC or DC input power cable	1	2m	Refer to section 4.2.1.1
Ethernet Cable for Web GUI or modem connection	1	2m	
GND Cable	1	2m	

### 3.2 Head-end Unit Equipment Installation

#### 3.2.1 Installation Head-end Unit in a 19" rack

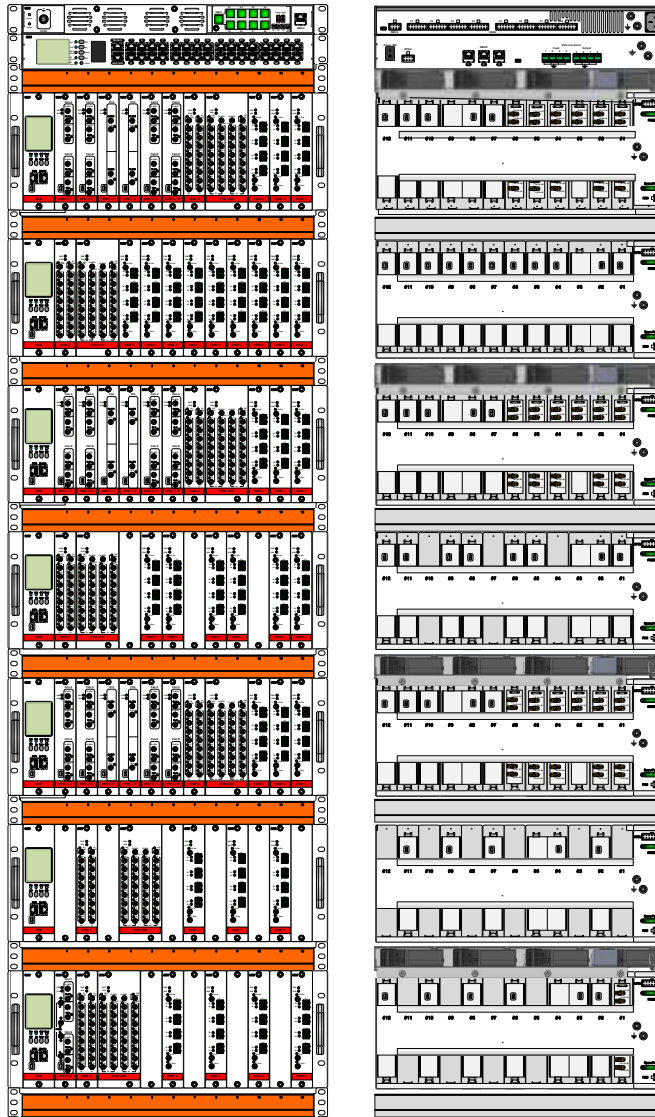

Figure 3-1 Head-end Unit Rack Mount (Front & Rear view)

• **CAUTIONS AND CONSIDERATIONS**

- POD Head-end system should be installed inside building only and mounts in a standard 19" rack.
- The rule for installing FAN unit: refer to section -
- Allowed minimum clearance
  - > Front and Rear: 10" (254mm)
  - > Both sides: 2" (51mm)
  - > Top and bottom: No clearance is required.

**3.2.1.1 The sequence for mounting head-end unit**

The sequence for mounting each head-end unit is as below.

- **(1)H-PSU → (2)H-DMCU → (3-1)H-CDU #1 → (4-1)H-SRU #1 ... (3-7)H-CDU #7 → (4-7)H-SRU #7 → (5)H-FAU**
  - > H-PSU must be installed at the top of the rack.
  - > H-DMCU must be installed right below H-PSU on the rack.
  - > H-SRU must be installed below H-DMCU with skip 1U gap
  - > H-CDU must be installed between H-DMCU and H-SRU.
  - > H-FAU (FAN Unit) will be installed in the empty space from rear side of H-CDU (Cable duck Unit).
- Regarding FAN installation, refer to section -.

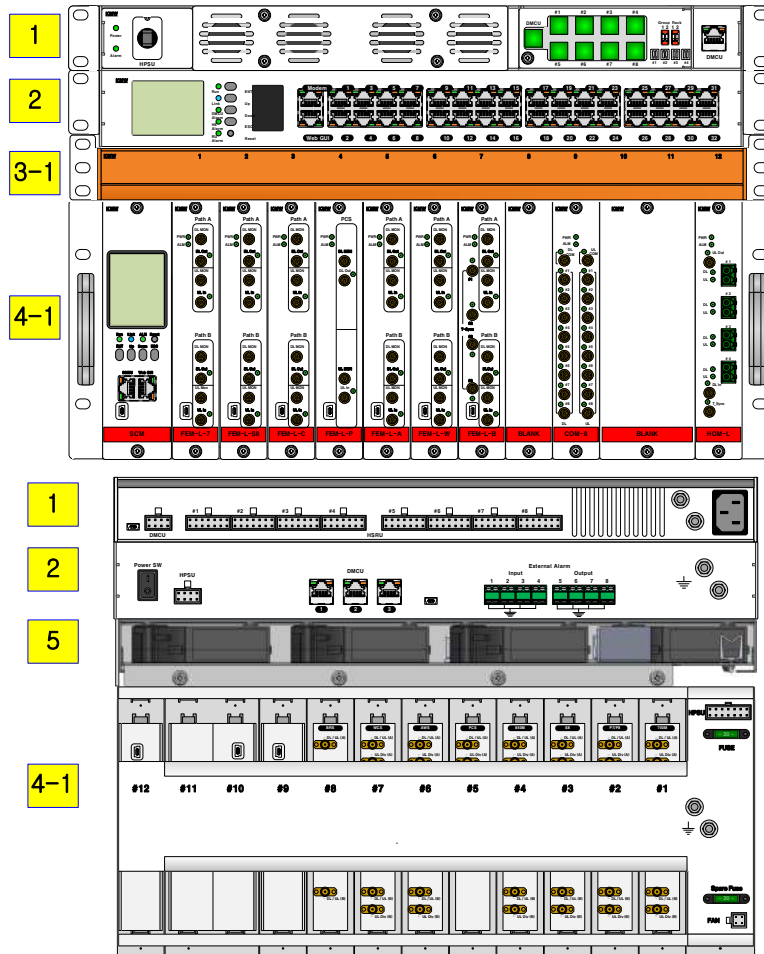

**Figure 3-2 Head-end Unit - Rack Mount Sequence**

### 3.2.2 Grounding

The grounding terminals are located at the rear of H-PSU, H-DMCU, and H-SRU. They must be grounded properly before powering on the equipment.

**Figure 3-10 Head-end units Grounding**

### 3.2.3 Optic port Cleaning

- We recommend that optic connector should be cleaned using a dry optical cleaning swab or tissue in a dry environment before connecting optic cable. Also, if the expected optic loss is 1.5dB higher than the loss reported in the Web-GUI, the optic loss should be minimized through cleaning optic connectors. (Figure 3-3)
- The unused optic ports are should be covered with a protective dust cap. (Figure 3-4)



**Figure 3-3 Optic Connector Cleaning (left) and Optic Port Cleaning (right)**

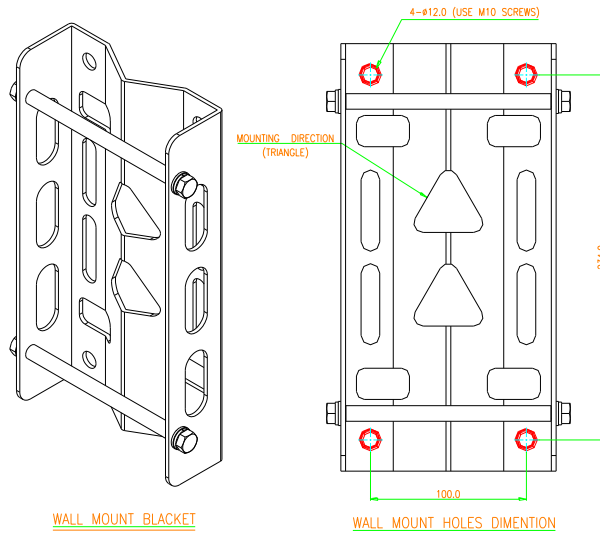

**Figure 3-4 LC/APC Optic Connector Dust Cap**

### 3.3 Remote Unit

#### 3.3.1 Wall Mount for 3/5/7 band RU and PS700/800 RU

- Wall mounting procedure
  - Check the suitability of the wall-mounting kit and the wall based on Figure 3-5



**Figure 3-5 3/5/7 band RU, PS700/800 RU – wall mount bracket**

- Install the wall-mounting bracket using 4 x M10 screw anchors (**not included\*\***) according to the drilling layout. Confirm that the bracket is securely fastened to the wall.
  - > \*\* The M10 screw anchors are not included as part of the RU delivery because the suitable type depends on the on-site conditions such as wall structure and materials. Therefore, use screw anchors that are appropriate for the mounting surface.
- Install the Remote Unit on the wall-mounting bracket by lifting the RU into place and lowering it down onto the bracket. **The M6 pins must align with the slots in the bracket to support the RU.**

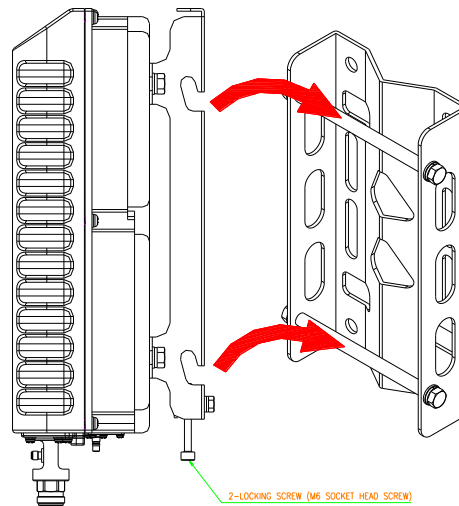

**Figure 3-6 3/5/7 band RU, PS700/800 RU – Install RU into wall mount bracket**

- Fasten the lower section of the Remote Unit to the bracket using a washer and 2 x M6 screws (on both sides). Slide a washer over each screw and then insert the screw and tighten it securely.

- Confirm that all screws have been fastened and the unit is securely mounted to the wall.



**Figure 3-7** 3/5/7 band RU, PS700/800 RU – RU installed on the wall

### 3.3.2 Grounding

#### 3.3.2.1 3/5/7 band RU, PS700/800 RU

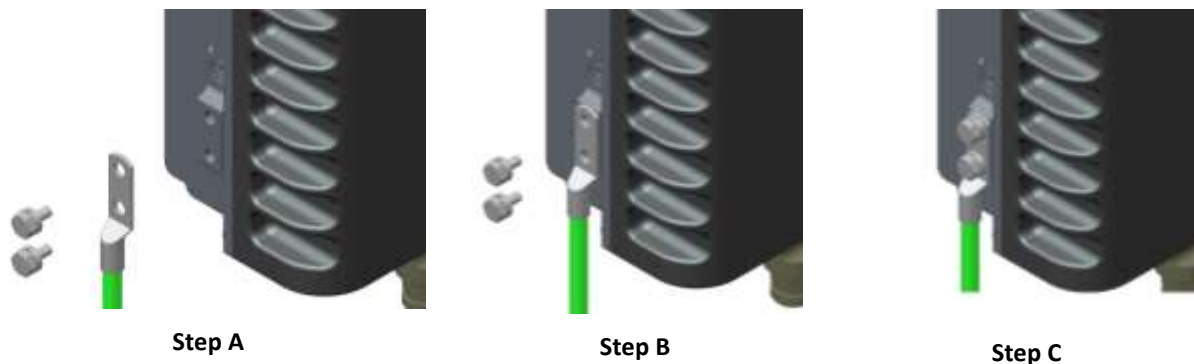

**Figure 3-8** 3/5/7 band RU grounding

- Connect an earth-bonding cable to the grounding bolt connection provided on the outside of the remote unit (Left-side) as shown in Figure 3-8. Do not use earth-bonding cable to connect other external devices.
  - > loosen the two hex bolts attached to remote unit as illustrated in Figure 3-8, Step A
  - > Connect the earth-bonding cable to remote unit as illustrated in Figure 3-8, Step B
  - > Then, fasten all parts again by tightening the hex bolts as illustrated in Figure 3-8, Step C
- Connect the other end of the ground wire to a suitable permanent ground following local electrical code practices.

#### 4. CABLE CONNECTION

##### 4.1 Head-end Unit Cable Connection

###### 4.1.1 Cable

- RF Cable
  - Between modules in H-SRU or between H-SRUs
    - > **Downlink**
      - Connector: SMB-L, female
      - Cable Color: **Blue Jacket**
    - > **Uplink**
      - Connector: SMB-L, female
      - Cable Color: **Yellow Jacket**
  - **CAUTION** RF cable with 35" length will be provided normally. 60" and 90" RF cable can be provided by user's special order.
- Ethernet cable
  - Between H-DMCU and H-SCM or H-PSU
    - Connector: RJ45, female
    - Length: 2m
- Power & Signal cable
  - Between H-DMCU and H-PSU
    - > Length: 30cm
  - Between H-SRU and H-PSU
    - > Length: 2m
  - Between H-SRU and H-FAU
    - > Length: 40cm
  - AC Power Cable
    - > Length: 2m
- GND Cable
  - H-DMCU, H-PSU, H-SRU
    - > Length: 1m

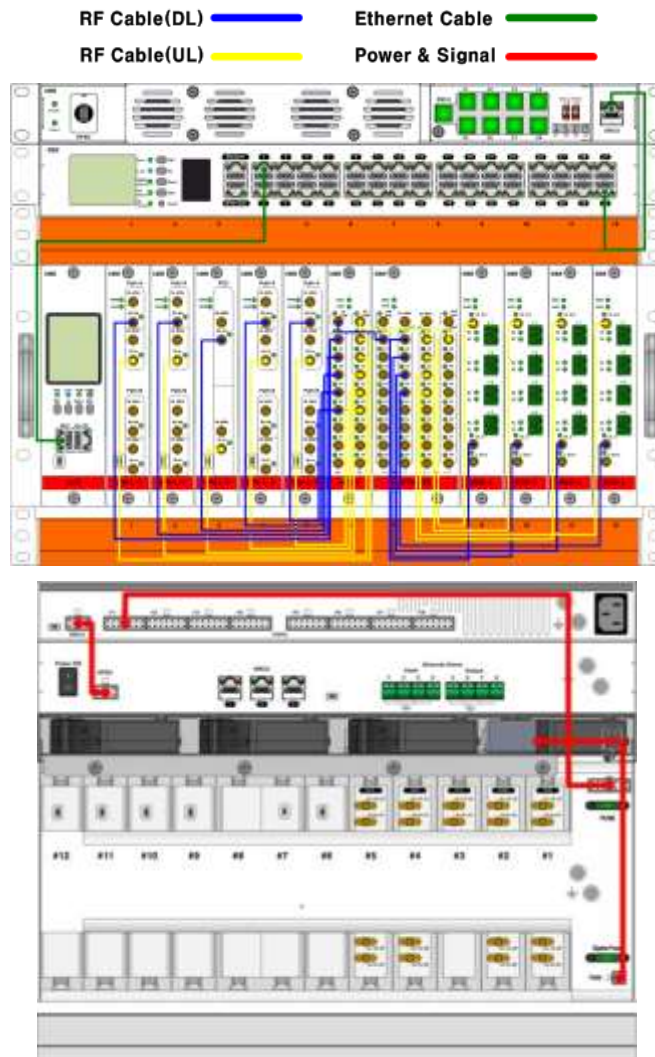

Figure 4-1 Head-end - cables

#### 4.1.2 Cable Connection Example for frequency bands with FDD type

- POD DAS System configuration
  - H-DMCU : 1ea
  - H-PSU: 1ea
  - H-SRU: 1ea (H-SCM, H-FAU, H-CDU)
  - H-FEM: 5ea (FEM-L-7, FEM-L-C, FEM-L-P, FEM-L-A, FEM-L-W)
  - H-COM: 1ea
  - H-DTM: 1ea
  - H-HOM-L: 4ea

Figure 4-2 shows cable connection example for frequency bands with FDD type.



**Figure 4-2** Cable Connection Example for frequency bands with FDD type



- RF cable connection
  - The RF ports for BTS connection are located in the back of H-SRU.
  - All RF ports for the connection between modules installed in H-SRU are located in the front of H-SRU.
- Optic cable connection
  - The optic ports for the connection with Remote units are located in the front panel of H-HOM-L.

- Ethernet cable connection

	From	To	Comments
Ethernet cable	H-DMCU	H-SCM	
	H-DMCU	H-PSU	

- Power & signal cable connection

	From	To	Comments
Power & Signal cable	H-PSU	H-DMCU	
	H-PSU	H-SRU	
	H-SRU	H-FAU	

### 4.1.3 Cable Connection for TDD 2.6G frequency band

- POD DAS System configuration
  - H-DMCU : 1ea
  - H-PSU: 1ea
  - H-SRU: 1ea (H-SCM, H-FAU, H-CDU)
  - H-FEM: 1ea (FEM-L-B)
  - H-COM: 1ea
  - H-DTM: 1ea
  - H-HOM-L: 4ea

Figure 4-3 shows cable connection example for TDD 2.6G frequency band.

In case of 2.6G supporting TDD system, TDD sync signal generated from H-FEM-L-B should be transferred to RU to synchronize TDD timing in overall POD DAS system. H-FEM-L-B has 4 TDD sync output port and each TDD sync port is connected to TS sync port of H-HOM-L to transfer TDD signal over optic cable.

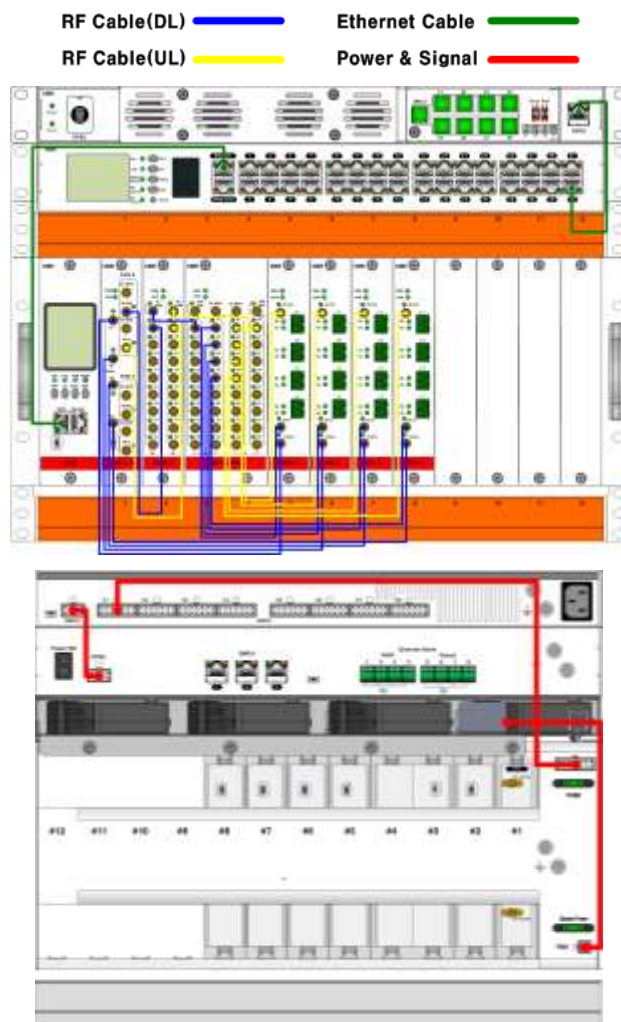

**Figure 4-3 Cable Connection Example #1 for TDD 2.6G frequency band**

- RF cable connection
  - The RF ports for BTS connection are located in the back of H-SRU.
  - All RF ports for the connection between modules installed in H-SRU are located in the front of H-SRU.
- RF cable connection for TDD sync signal transfer

	From		To	
	Module	port	Module	port
RF cable	H-FEM-L(H)-B	T-Sync #1~#4	H-HOM	T_Sync

- Optic cable connection
  - The optic ports for the connection with Remote units are located in the front panel of H-HOM-L.
- Ethernet cable connection

	From	To	Comments
Ethernet cable	H-DMCU	H-SCM	
	H-DMCU	H-PSU	

- Power & signal cable connection

	From	To	Comments
Power & Signal cable	H-PSU	H-DMCU	
	H-PSU	H-SRU	
	H-SRU	H-FAU	

#### 4.1.4 Cable Connection Example for Public Safety 700/800 band

- POD DAS System configuration
  - H-MCM : 1ea (or H-DMCU)
  - H-PSM-OI: 1ea (or H-PSU)
  - H-SRU: 1ea (H-SCM, H-FAU, H-CDU)
  - H-FEM: 1ea (FEM-L-P7/P8)
  - H-COM: 1ea
  - H-DTM: 1ea
  - H-HOM-L: 2ea

Figure 4-4 shows cable connection example for Public Safety 700/800 band.

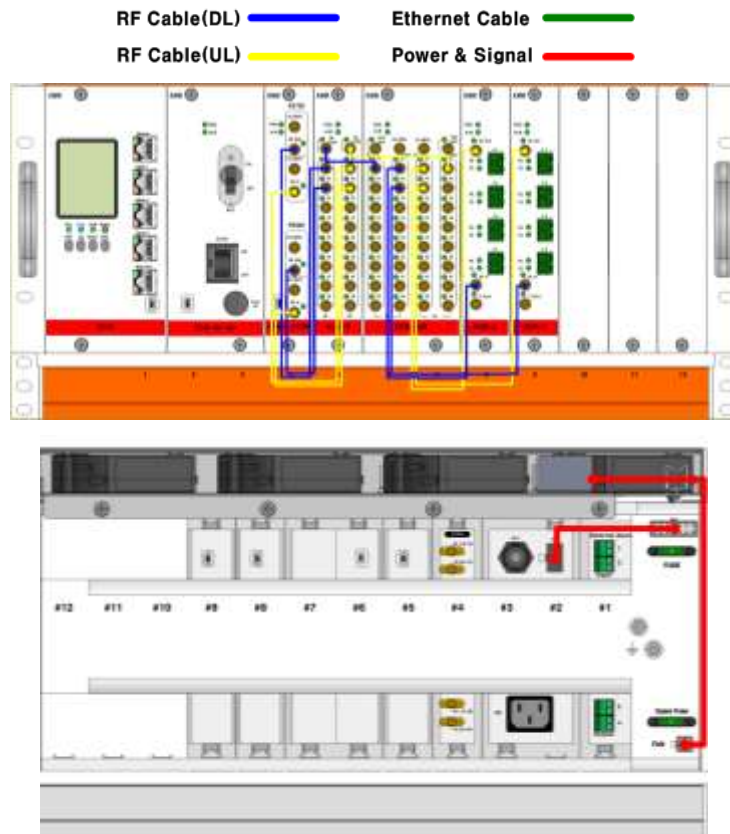

**Figure 4-4 Cable Connection Example for Public Safety 700/800 band**

- RF cable connection
  - The RF ports for BTS connection are located in the back of H-SRU.
  - All RF ports for the connection between modules installed in H-SRU are located in the front of H-SRU.
- Optic cable connection
  - The optic ports for the connection with Remote units are located in the front panel of H-HOM-L.
- Power & signal cable connection

	From	To	Comments
Power & Signal cable	H-PSM	H-SRU	
	H-SRU	H-FAU	

#### 4.1.5 Cable Connection Example for MIMO configuration

- POD DAS System configuration
  - H-DMCU : 1ea
  - H-PSU: 1ea
  - H-SRU: 2ea (H-SCM, H-FAU, H-CDU)
  - H-FEM: 6ea (H-FEM-L-7, H-FEM-L-C, H-FEM-L-P x2, H-FEM-L-A, H-FEM-L-W)
    - > H-FEM-L-7, H-FEM-L-C, H-FEM-L-A, and H-FEM-L-W can support MIMO configuration by using one H-FEM-L module because they have two paths in one module.
    - > H-FEM-L-P supports only one path in one module. 2 H-FEM-L-P are needed to support MIMO configuration for PCS frequency band.
  - H-COM: 1ea
  - H-DTM: 1ea
  - H-HOM-L: 3ea

Figure 4-5 shows cable connection example for MIMO configuration.

- MIMO #1
  - H-FEM-L-x in H-SRU #1
  - H-COM, H-DTM, and H-HOM-L in H-SRU #1
- MIMO #2
  - H-FEM-L-x in H-SRU #1
  - H-COM, H-DTM, and H-HOM-L in H-SRU #2

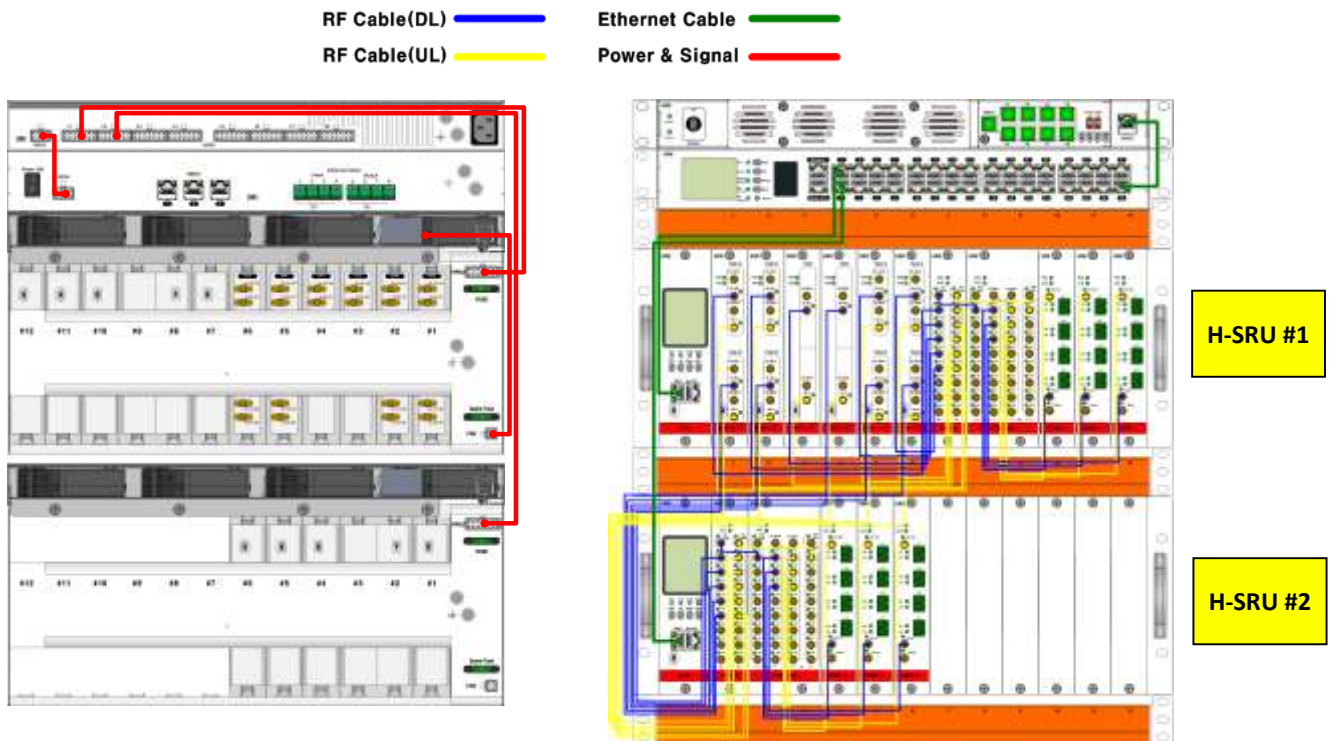

Figure 4-5 Cable Connection for FDD frequency band (MIMO) support

- RF cable connection
  - The RF ports for BTS connection are located in the back of H-SRU.
  - All RF ports for the connection between modules installed in H-SRU are located in the front of H-SRU.
  - RF cable connection For MIMO #1
    - > H-FEM-L-x in H-SRU #1 ↔ H-COM in H-SRU #1 ↔ H-DTM in H-SRU #1 ↔ H-HOM-L in H-SRU #1
  - RF cable connection For MIMO #2
    - > H-FEM-L-x in H-SRU #1 ↔ H-COM in H-SRU #2 ↔ H-DTM in H-SRU #2 ↔ H-HOM-L in H-SRU #2
- Optic cable connection
  - The optic ports for the connection with Remote units are located in the front panel of H-HOM-L.

- Ethernet cable connection

	From	To	Comments
Ethernet cable	H-DMCU	H-SCM in H-SRU #1	
	H-DMCU	H-SCM in H-SRU #2	
	H-DMCU	H-PSU	

- Power & signal cable connection

	From	To	Comments
Power & Signal cable	H-PSU	H-DMCU	
	H-PSU	H-SRU #1	
	H-PSU	H-SRU #2	
	H-SRU	H-FAU in H-SRU #1	

#### 4.1.6 Cable connection between multiple Racks

Figure 4-6 shows how to connect cable and set rack ID for IP setting.

- One H-DMCU is able to control and monitor maximum up to 4 racks and one rack can be composed of maximum 7 H-SRUs and one H-DMCU. All H-PSU, H-SCM, and H-MCM are connected to H-DMCU through 32 Ethernet ports located in front side of H-DMCU.
- Rack ID can be set by dip switch in H-PSU.
  - Refer to section 2.1.12.7 to figure out how to set Rack ID.
- It might need longer RF cable than RF cable with 35" length included in the packaged box for the connection between racks. In this case, user needs to buy extra cable with longer length in advance. For your information, RF cable with 60", and 90" length can be provided by user's special order.

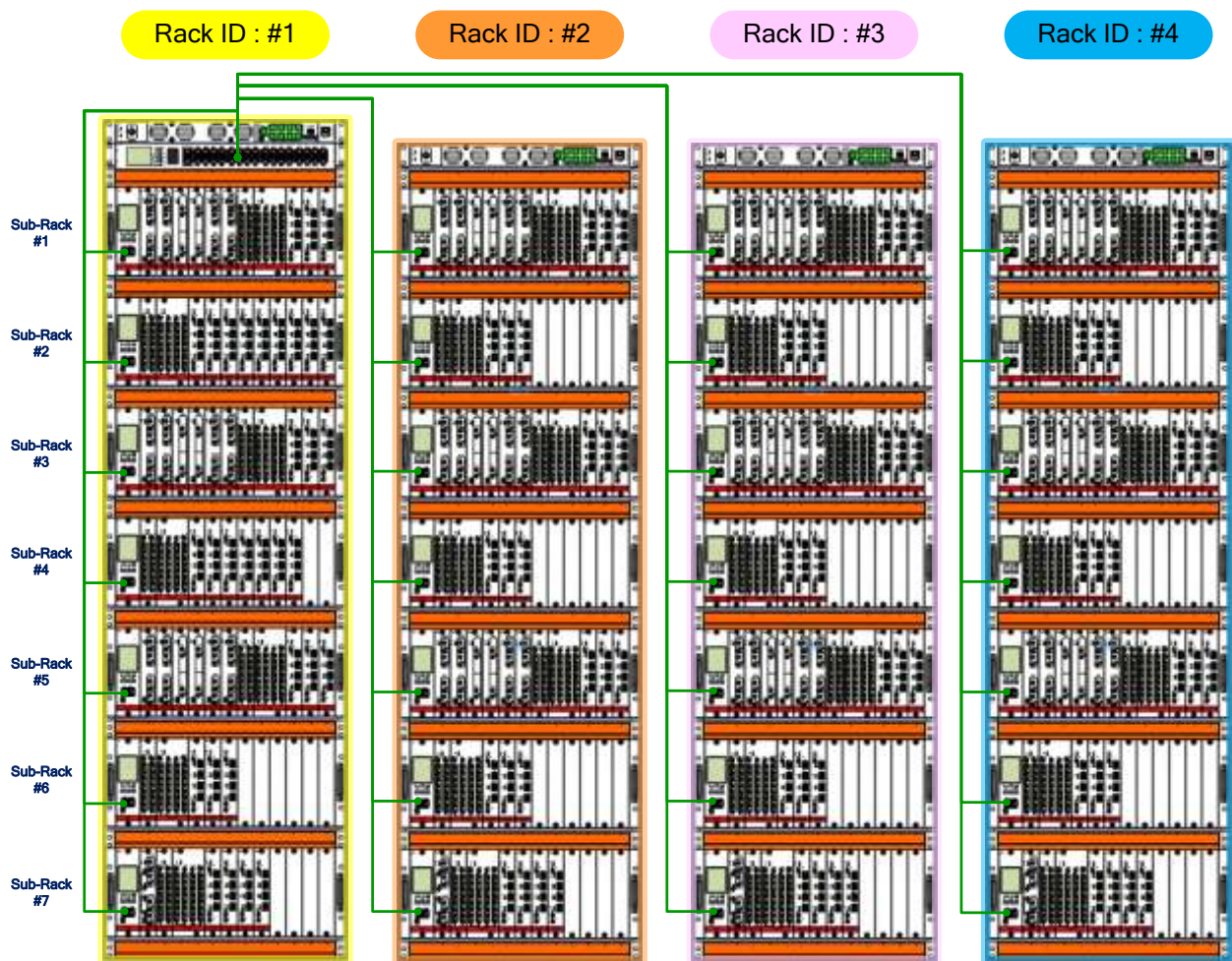

Figure 4-6 Connection Diagram for Rack Inter Connection

## 4.2 Remote Unit Cable Connection

### 4.2.1 7/5/3 band & PS700/800 RU

#### 4.2.1.1 Cable

- Ethernet cable
  - For web GUI connection or connection with expansion RU
    - Connector: RJ45, female
    - Length: 2m
- AC or DC Power cable
  - Length: 2m
- GND Cable
  - Length: 2m



#### 4.2.1.2 Optic cable connection

- After loosening 4x SECURITY SCREWS (M4), open the door for debug window.



- After loosening 5x SECURITY SCREWS (M4), open front door.



- After taking out of gasket from optic cable entrance located in left side, pass optic cable through this entrance.



- Connect optic cable to optic port located on the left top side in debug window.



- Replace gasket into optic cable entrance.



- Continue in section 4.2.1.3.

#### 4.2.1.3 AC or DC power cable connection

- After taking out of gasket from power cable entrance located in right side, pass power cable through this entrance.



- Connect power cable to AC (or DC) power terminal. In case of AC power cable, fasten ground cable by using GND SCREW to GND position located on the right top side in debug window.



- Replace gasket into power cable entrance.



- If there is no expansion RU connected main RU, close/fasten the door for debug window and front door by using SECURITY SCREWS (M4) and allowed Torque: 12.0 Kgf•cm.
- If there is an expansion RU connected main RU, continue in section 4.2.1.4.



#### 4.2.1.4 Ethernet cable connection for connecting with Expansion RU

If there is an expansion RU connected main RU, connect Ethernet cable with expansion RU before closing the door for debug window and front door.

- After taking out of gasket from Ethernet cable entrance located in the middle, pass Ethernet cable through this entrance.



- Connect Ethernet cable to EXT port (RJ 45).



- Replace gasket into Ethernet cable entrance.



- Close/fasten the door for debug window and front door by using SECURITY SCREWS (M4) and allowed Torque: 12.0 Kgf•cm.



- Connect the other side of Ethernet cable to EXT pot of expansion RU based on section 4.2.1.4.

**CAUTION** The location of EXT pot in expansion RU is different from the location of EXT port in main RU. Make sure where the location of EXT port in expansion RU is (refer to Figure 2-57) before connecting Ethernet cable to expansion RU.

5. SPECIFICATION

5.1 Electrical Specifications (Low power HFM – Low power RU)

Table 5-1 POD DAS 2-Band RU Electrical Specifications (POD-R-P78-27-AC/DC)

Parameter		Specifications		Remark
		PS 700	PS 800	
Frequency	DL	758 - 775M	851 - 869M	
	UL	788 - 805M	806 - 824M	
Input	DL	-40 ~ 20dBm		
	UL	-42dBm	-42dBm	
Maximum Output	DL	27dBm		@all temperature range
	UL	-5dBm		@all temperature range
Gain Range	DL	7dB to 67dB		
	UL	-8dB to 37dB		
Noise Figure @Max Gain		< 6 dB		@1 RU, optic loss: 0dB
Input/output Impedance		50 ohm		
VSWR		< 1:1.7		
System Delay		< 2us @2.6G, < 5us @other bands		
Permitted optic loss		HOM-L: ~7.5dBo, HOM-H/OEM/OIM: ~10.5dBo		
Frequency Error & EVM (LTE)		Frequency Error: <±0.01ppm, EVM: < 5%		
Frequency Error & Rho (CDMA)		Frequency Error: <±0.05ppm, Rho: >0.912		
Out of Band Emission		-13dBm/1KHz @9KHz – 150KHz		
		-13dBm/10KHz @150KHz – 30MHz		
		-13dBm/100KHz @30MHz – 1GHz		
		-13dBm/1MHz @1GHz – 12.75GHz		
Operating Band Unwanted Emissions	CDMA	-45dBc/30KHz @±885KHz, -45dBc/30KHz @±1.125MHz -50dBc/30KHz @±1.98MHz, <-13dBm/30KHz @±2.25MHz, <-13dBm/1MHz @±4.0MHz		
	WCDMA/LTE	Meet 3GPP WCDMA/LTE Repeater Spec.		
2 tone CW Test		Downlink: > 40dBc, Uplink: > 50dBc @two CW tone 1MHz separation		
Operating Temperature	Head-end	-10 ~ +50°C		
	RU	-40 ~ +55°C		
Operating Humidity		≤ 95%, non-condensing		
RU Enclosure		Meet IP65, NEMA4X		



**Table 5-2 POD DAS 7-Band RU Electrical Specifications (POD-R-7S8CPAWB-2730-AC/DC)**

Parameter		Specifications						Remark
		700M	SMR 800 + 850M	PCS	AWS	WCS	2.5G	
Frequency	DL	728-756M	862 - 894M	1930-1995M	2110-2180M	2350-2360M	2496-2690M	
	UL	698-716M 777-787M	817 - 849M	1850-1915M	1710-1780M	2305-2315M	2496-2690M	
Input	DL	-15 ~ 20dBm						
	UL	-42dBm			-45dBm			
Maximum Output	DL	27dBm			30dBm			@all temperature range
	UL	-5dBm						@all temperature range
Gain Range	DL	7dB to 42dB			10dB to 45dB			
	UL	-8dB to 37dB			-5dB to 40dB			
Noise Figure @Max Gain		< 6 dB						@1 RU, optic loss: 0dB
Input/output Impedance		50 ohm						
VSWR		< 1:1.7						
System Delay		< 2us @2.6G, < 5us @other bands						
Permitted optic loss		HOM-L: ~7.5dBo, HOM-H/OEM/OIM: ~10.5dBo						
Frequency Error & EVM (LTE)		Frequency Error: <±0.01ppm, EVM: < 5%						
Frequency Error & Rho (CDMA)		Frequency Error: <±0.05ppm, Rho: >0.912						
Out of Band Emission		-13dBm/1KHz @9KHz – 150KHz						
		-13dBm/10KHz @150KHz – 30MHz						
		-13dBm/100KHz @30MHz – 1GHz						
		-13dBm/1MHz @1GHz – 12.75GHz						
Operating Band Unwanted Emissions	CDMA	-45dBc/30KHz @±885KHz, -45dBc/30KHz @±1.125MHz, -50dBc/30KHz @±1.98MHz <-13dBm/30KHz @±2.25MHz, <-13dBm/1MHz @±4.0MHz						
	WCDMA/LTE	Meet 3GPP WCDMA/LTE Repeater Spec.						
2 tone CW Test		Downlink: > 40dBc, Uplink: > 50dBc @two CW tone 1MHz separation						
Operating Temperature	Head-end	-10 ~ +50°C						
	RU	-40 ~ +55°C						
Operating Humidity		≤ 95%, non-condensing						
RU Enclosure		Meet IP65, NEMA4X						



**5.2 Additional Model Names**

Each 2-Band and 7-Band RU has several additional models from the basic model. They are identical to basic model except only with blocked RF band(s) by Factory loaded software and without hardware changing. So Basic model supports up to specified number of bands and additional models supports less number of bands with several blocked RF band(s).

The table shown in below shows the basic model and additional models which are derived from the basic model.

**Table 5-3 Basic Model and Additional Models on 2-Band Remote Unit**

Basic Model	Additional Model	Activated RF Band	Blocked RF band
POD-R-P78-27-AC	-	PS 700M, PS 800M	N/A
	POD-R-P7-27-AC	PS 700M	PS 800M
	POD-R-P8-27-AC	PS 800M	PS 700M

**Table 5-4 Basic Model and Additional Models on 7-Band Remote Unit**

Basic Model	Additional Model	Activated RF Band	Blocked RF band
POD-R-7S8CPAWB-2730-AC	-	LTE 700M, SMR 800M, Cellular 850M, PCS 1.9G, AWS 2.1G, WCS 2.3G, BRS 2.5G	N/A
	POD-R-7S8CPAW-2730-AC	LTE 700M, SMR 800M, Cellular 850M, PCS 1.9G, AWS 2.1G, WCS 2.3G	BRS 2.5G
	POD-R-7CPAWB-2730-AC	LTE 700M, Cellular 850M, PCS 1.9G, AWS 2.1G, WCS 2.3G, BRS 2.5G	SMR 800M
	POD-R-7CPAW-2730-AC	LTE 700M, Cellular 850M, PCS 1.9G, AWS 2.1G, WCS 2.3G	SMR 800M, BRS 2.5G
	POD-R-7CPA-2730-AC	LTE 700M, Cellular 850M, PCS 1.9G, AWS 2.1G,	SMR 800M, WCS 2.3G, BRS 2.5G
	POD-R-7PA-2730-AC	LTE 700M, PCS 1.9G, AWS 2.1G	SMR 800M, Cellular 850M, WCS 2.3G, BRS 2.5G
	POD-R-CPA-2730-AC	Cellular 850M, PCS 1.9G, AWS 2.1G	LTE 700M, SMR 800M, WCS 2.3G, BRS 2.5G
	POD-R-7CP-2730-AC	LTE 700M, Cellular 850M, PCS 1.9G	SMR 800M, AWS 2.1G, WCS 2.3G, BRS 2.5G
	POD-R-S8PB-2730-AC	SMR 800M, PCS 1.9G, BRS 2.5G	LTE 700M, Cellular 850M, AWS 2.1G, WCS 2.3G,