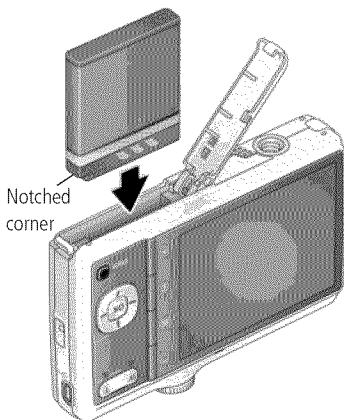

KODAK EASYSHARE M341

Digital Camera

User guide

IMPORTANT: Before connecting any cables, install the software that was included with your camera. Then return to this user guide.

1 Loading and charging the battery



- 1 Turn off the camera.
- 2 Connect KODAK USB Cable, Model U-8 and adapter.

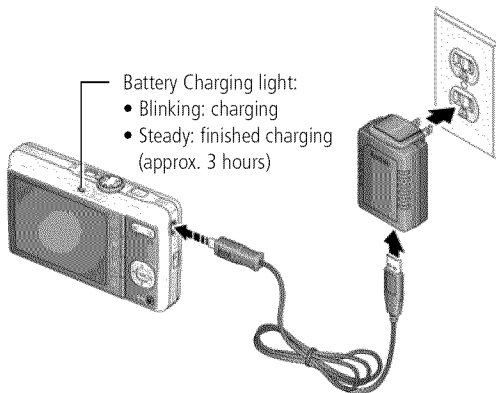

Charge Li-Ion batteries frequently, even if power remains.

More charging options in the Extended user guide www.kodak.com/go/m341support

Using an (accessory) SD or SDHC Card

Your camera has internal memory. You can purchase an SD or SDHC Card to store more pictures and videos. (Maximum supported card size is 32 GB.)



CAUTION:

A card can only be inserted one way; forcing it may cause damage. Inserting or removing a card when the camera is on may damage the pictures, the card, or the camera.

- 1 Turn off the camera.
- 2 Insert or remove the optional card.
- 3 Turn on the camera.

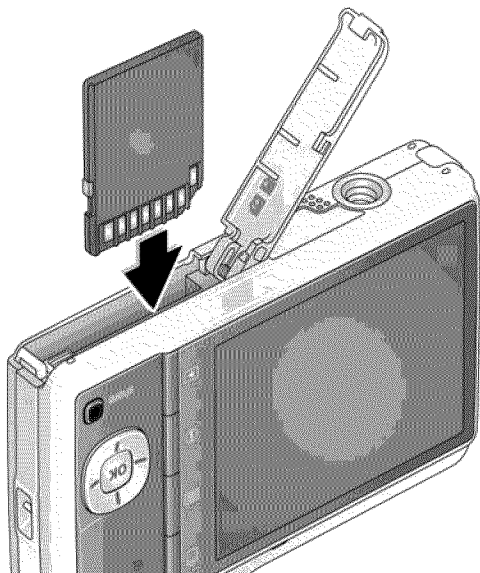

Purchase accessories www.kodak.com/go/m341accessories

2 Turning on the camera

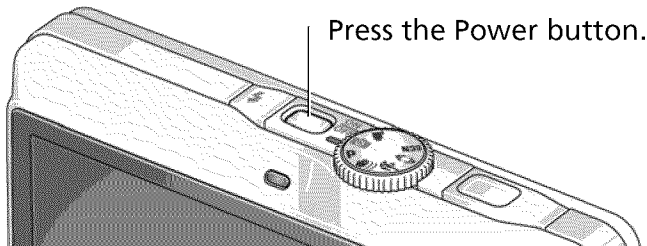

3 Setting the language and date/time

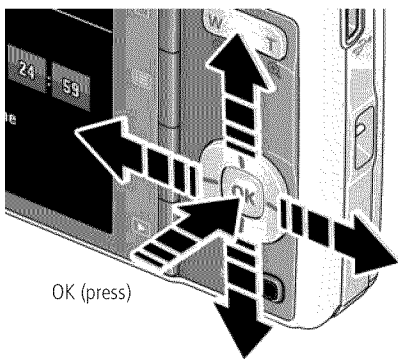

Language:
 ▲/▼ to change.
 OK to accept.

Date/Time:
 At the prompt, press OK.
 ▲/▼ to change current field.
 ◀/▶ for previous/next field.
 OK to accept.

See the Extended user guide www.kodak.com/go/m341support

4 Taking a picture

- 1 Turn the Mode dial to Smart Capture .
- 2 Press the Shutter button halfway to lock the focus. When the framing marks turn green, press the Shutter button completely down.

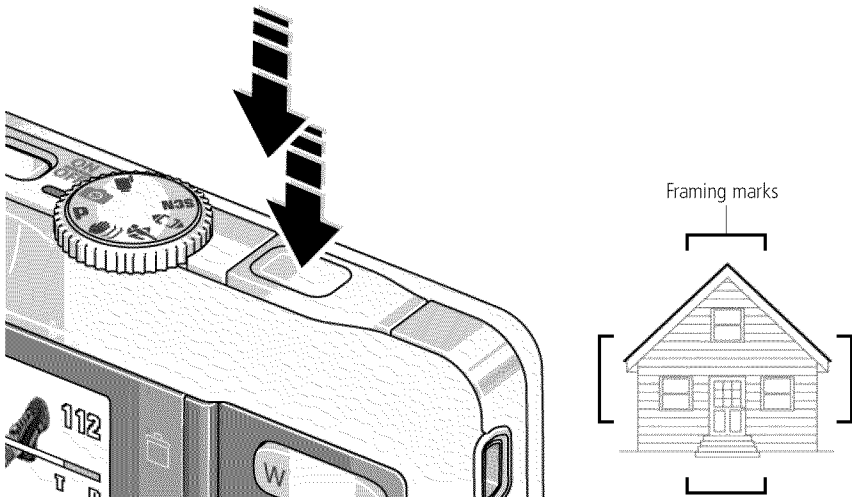

See the **Extended user guide**

www.kodak.com/go/m341support

Learn more about Smart Capture and other modes see page 11

5 Reviewing pictures/videos

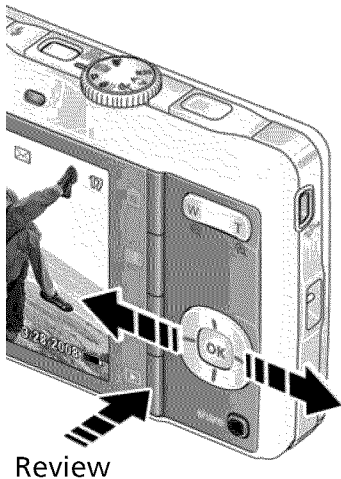

Press the Review  button to enter/exit Review.

-  View previous/next picture/video.
- OK Play a video.

See the **Extended user guide**  www.kodak.com/go/m341support

6 Transferring pictures/videos

- 1 Turn off the camera.
- 2 Connect a KODAK USB Cable, Model U-8.
- 3 Turn on the camera.

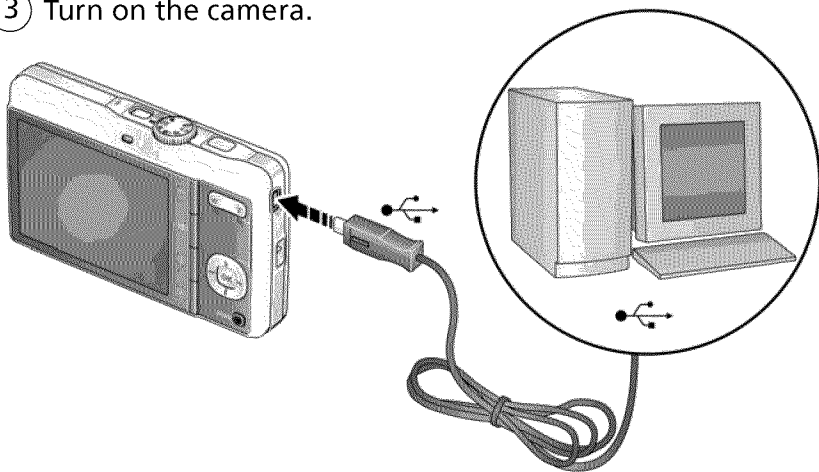

See the Extended user guide www.kodak.com/go/m341support

Purchase accessories www.kodak.com/go/m341accessories

7 Getting help from your camera

Your camera offers a built-in Help system. It describes every setting for every menu choice. If you learn nothing else about your camera, learn how to use on-camera Help. Because the more you know your camera, the more confident you become.

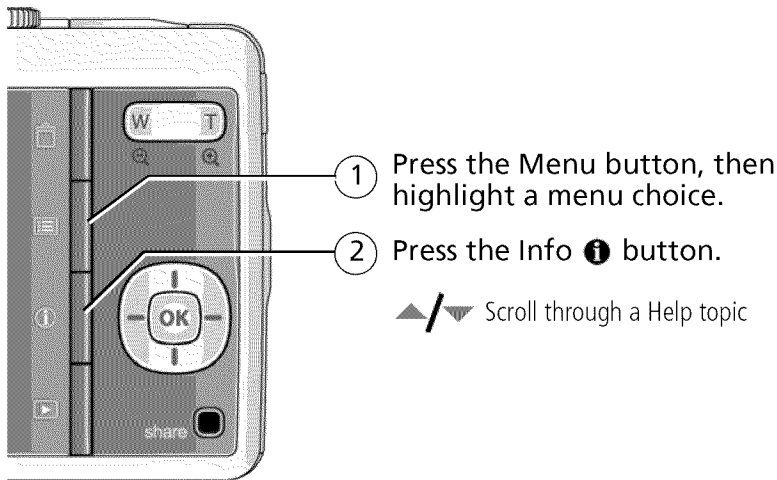

See the Extended user guide www.kodak.com/go/m341support

8 Keep learning about your camera!

Congratulations!

You have:

- set up your camera
- taken pictures
- transferred pictures to your computer

Keep learning!

Finish reading this book, so you can take and share your best pictures!

Visit www.kodak.com/go/m341support:

- the extended user guide
- interactive troubleshooting and repairs
- interactive tutorials
- FAQs
- downloads
- accessories
- printing information
- product registration

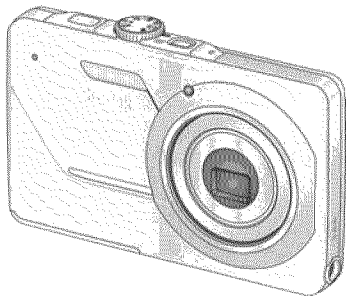

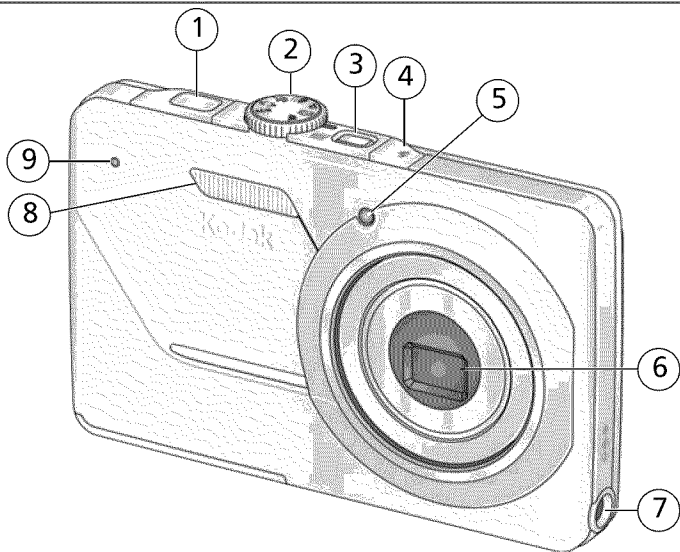

Front view

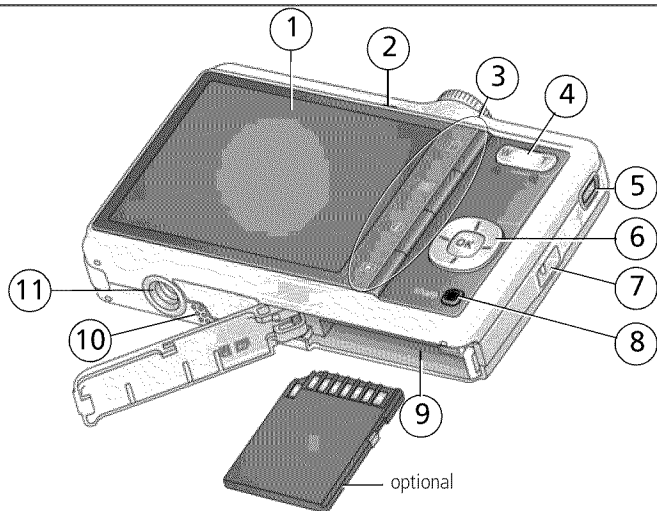

- | | | | |
|---|------------------|---|-----------------|
| 1 | Shutter button | 6 | Lens/Lens cover |
| 2 | Mode dial | 7 | DC-In (5V) |
| 3 | Power button | 8 | Flash |
| 4 | Flash button | 9 | Microphone |
| 5 | Self-timer light | | |

Back view



- | | | | |
|---|---|----|-----------------------------------|
| 1 | LCD | 7 | Strap post |
| 2 | Ready/Battery Charging light | 8 | Share button |
| 3 | Delete, Menu, Info, Review buttons | 9 | Battery, SD/SDHC Card compartment |
| 4 | Zoom (Telephoto/Wide Angle) button | 10 | Speaker |
| 5 | USB/AV Out | 11 | Tripod socket |
| 6 |  | | |
| | OK button | | |



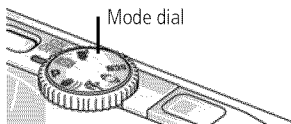

10

1

Doing more with your camera



Turn the Mode dial to the mode that best suits your subjects and surroundings.

Use this mode	For
 Smart Capture	General picture taking—it offers excellent image quality and ease of use.
P Program	Advanced picture taking—allows access to manual settings.
 Blur Reduction	Reducing blur caused by camera shake or subject motion.
 Sport	Action pictures.
 Panorama	“Stitching” up to 3 pictures into a panoramic scene.
SCN Scene	Point-and-shoot simplicity when taking pictures in practically any situation.
 Video	Capturing video with sound.

See the **Extended user guide** www.kodak.com/go/m341support

Using the flash

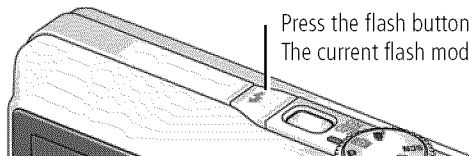

Press the flash button repeatedly to scroll through flash modes. The current flash mode is shown in the LCD status area.

Flash modes	Flash fires
Auto	When the lighting conditions require it.
Fill (Flash On)	Every time you take a picture, regardless of the lighting conditions. Use when the subject is in shadow or is “backlit” (when the light is behind the subject). NOTE: (Not available in Smart Capture mode.)
Preflash Red Eye	A preflash fires, shrinking the eye pupil, before the picture is taken.
Digital Correction Correction	A preflash does not fire; the camera corrects red eye.
Off	Never

See the **Extended user guide** www.kodak.com/go/m341support

Using the optical zoom

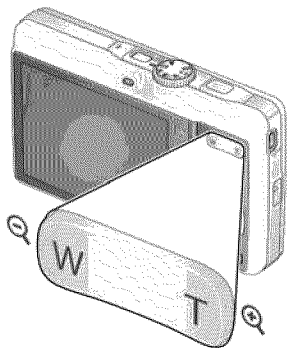

- 1 Use the LCD to frame your subject.
- 2 To zoom in, press Telephoto (T).
To zoom out, press Wide Angle (W).
- 3 Take the picture.

Using digital zoom

Use digital zoom to get up to 5X magnification beyond optical zoom. (Digital zoom is not available in Smart Capture mode.) Press Telephoto (T) until the slider is at the end of the optical zoom range. Release Telephoto (T), then press it again.



NOTE: You may notice decreased image quality when using digital zoom. The slider pauses and turns red when the picture quality reaches the limit for an acceptable 4 x 6 in. (10 x 15 cm) print.

See the Extended user guide  www.kodak.com/go/m341support

Using the menu button to change settings

You can change settings to get the best results from your camera.

NOTE: Some modes offer limited settings. Some settings remain until you change them; others, until you change modes or turn off the camera.

- 1 Press the Menu  button.
- 2 Press  to highlight the Capture/Video or Setup tab.
- 3 Press  to highlight a setting, then press OK.
- 4 Highlight an option, then press OK.

IMPORTANT: *Your camera offers a built-in Help system. To get the most from your camera, see page 7.*

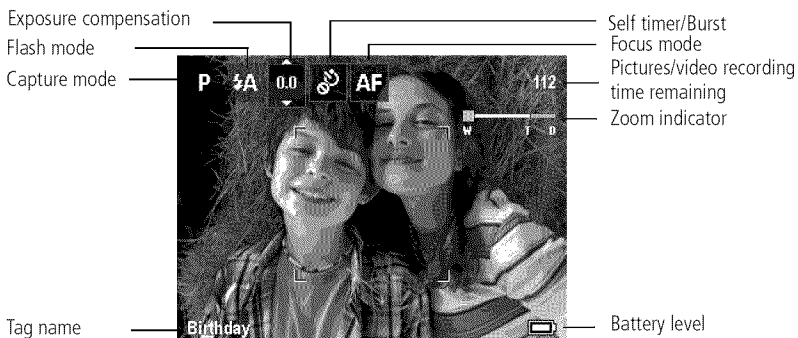

Understanding the picture-taking icons



2

Working with pictures/videos

Deleting pictures/videos

- 1 Press the Review  button.
- 2 Press  for previous/next picture/video.
- 3 Press the Delete button, then follow the prompts.

Understanding the review icons

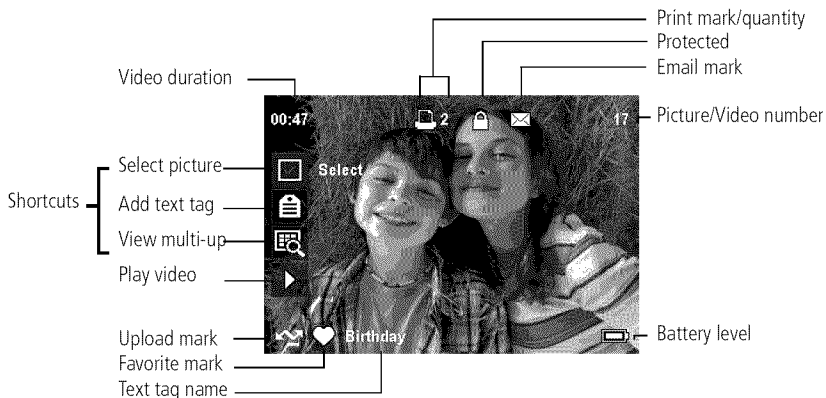

3

Share your stories!

A thousand ways to tell a story...
and each begins with a picture.

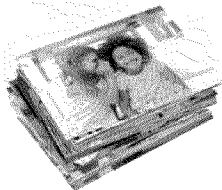

How do you tell yours?

Prints

- 4 x 6 pictures
- Enlargements, posters
- Collages
- Photo books

Photo gifts

- Cards
- Calendars
- Mugs
- Ties
- Shirts

Digitally

- EASYSHARE Digital Picture Frame
- HDTV devices
- Email

...and much more!

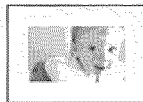
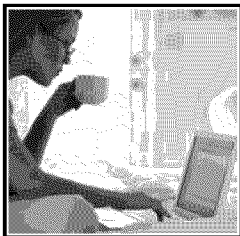

Pictures start here!

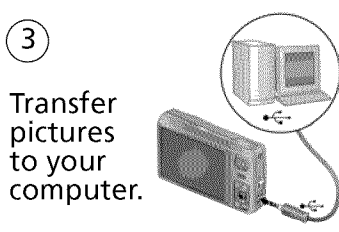
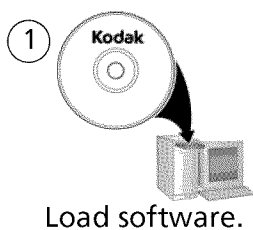

Pictures become stories here!

At home



Online



At a local photo retailer

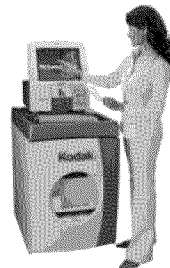

www.kodak.com/go/tips

4

Solving camera problems

Status	Solution
Camera does not turn on, off	<ul style="list-style-type: none">■ Make sure the battery is charged and installed correctly (see page 1).
Camera buttons and controls do not function	
In Review, a blue or black screen is displayed instead of a picture	<ul style="list-style-type: none">■ Transfer <i>all</i> pictures to the computer (see page 6).■ Take another picture.
Pictures remaining number does not decrease after taking a picture	<ul style="list-style-type: none">■ Continue taking pictures. The camera is operating normally. (The camera estimates the number of pictures remaining after each picture is taken, based on picture size and content.)
Flash does not fire	<ul style="list-style-type: none">■ Check the flash setting, and change as needed (see page 12). NOTE: The flash does not fire in all modes.
Memory card is almost or entirely full	<ul style="list-style-type: none">■ Transfer the pictures to the computer (see page 6).■ Delete pictures from the card (see page 15) or insert a new card.
Battery life is short	<ul style="list-style-type: none">■ Make sure the correct battery type is installed.■ Wipe the contacts with a clean, dry cloth before inserting a battery in the camera.■ Insert a new or charged battery (see page 1).

5

Appendix



CAUTION:

Do not disassemble this product; there are no user-serviceable parts inside. Refer servicing to qualified service personnel. KODAK AC Adapters and Battery Chargers are intended for indoor use only. The use of controls, adjustments, or procedures other than those specified herein may result in exposure to shock and/or electrical or mechanical hazards. If the LCD breaks, do not touch the glass or liquid. Contact Kodak customer support.

- The use of an accessory that is not recommended by Kodak may cause fire, electric shock, or injury. For approved accessories, visit www.kodak.com/go/accessories.
- Use only a USB-certified computer equipped with a current-limiting motherboard. Contact your computer manufacturer if you have questions.
- If using this product in an airplane, observe all instructions of the airline.
- When removing the battery, allow it to cool; it may be hot.
- Follow all warnings and instructions supplied by the battery manufacturer.
- Use only batteries approved for this product to avoid risk of explosion.
- Keep batteries out of the reach of children.
- Do not allow batteries to touch metal objects, including coins. Otherwise, a battery may short circuit, discharge energy, become hot, or leak.
- Do not disassemble, install backward, or expose batteries to liquid, moisture, fire, or extreme temperature.
- Remove the battery when the product is stored for an extended period of time. In the unlikely event that battery fluid leaks inside the product, contact Kodak customer support.
- In the unlikely event that battery fluid leaks onto your skin, wash immediately with water and contact your local health provider. For additional health-related information, contact your local Kodak customer support.
- Dispose of batteries according to local and national regulations. Visit www.kodak.com/go/kes.
- Do not charge non-rechargeable batteries. For more information, see www.kodak.com/go/batteries.

Limited warranty

Kodak warrants its digital cameras and accessories (excluding batteries) to be free from malfunctions and defects in both materials and workmanship for the warranty period specified on your Kodak Product packaging. Retain the original dated sales receipt. Proof of purchase date is required with any request for warranty repair.

Limited warranty coverage

Warranty service is only available from within the country where the Products were originally purchased. You may be required to ship Products, at your expense, to the authorized service facility for the country where the Products were purchased. Kodak will repair or replace Products if they fail to function properly during the warranty period, subject to any conditions and/or limitations stated herein. Warranty service will include all labor as well as any necessary adjustments and/or replacement parts. If Kodak is unable to repair or replace a Product, Kodak will, at its option, refund the purchase price paid for the Product provided the Product has been returned to Kodak along with proof of the purchase price paid. Repair, replacement, or refund of the purchase price are the sole remedies under the warranty. If replacement parts are used in making repairs, those parts may be remanufactured, or may contain remanufactured materials. If it is necessary to replace the entire Product, it may be replaced with a remanufactured Product. Remanufactured Products, parts and materials are warranted for the remaining warranty term of the original Product, or 90 days after the date of repair or replacement, whichever is longer.

Limitations

This warranty does not cover circumstances beyond Kodak's control. This warranty does not apply when failure is due to shipping damage, accident, alteration, modification, unauthorized service, misuse, abuse, use with incompatible accessories or attachments (such as third party ink or ink tanks), failure to follow Kodak's operation, maintenance or repacking instructions, failure to use items supplied by Kodak (such as adapters and cables), or claims made after the duration of this warranty. Kodak makes no other express or implied warranty for this product. In the event that the exclusion of any implied warranty is ineffective under the law, the duration of the implied warranty will be the length of the express warranty period specified on your Kodak product packaging. The option of repair, replacement, or refund is Kodak's only obligation. Kodak will not be responsible for any special, consequential or incidental damages resulting from the sale, purchase, or use of this product regardless of the cause. Liability for any special, consequential or incidental damages (including but not limited to loss of revenue or profit, downtime costs, loss of the use of the equipment, cost of substitute equipment, facilities or services, or claims of your customers for such damages resulting from the purchase, use, or failure of the Product), regardless of cause or for breach of any written or implied warranty is expressly disclaimed.

Your rights

Some states or jurisdictions do not allow exclusion or limitation of incidental or consequential damages, so the above limitation or exclusion may not apply to you. Some states or jurisdictions do not allow limitations on how long an implied warranty lasts, so the above limitation may not apply to you. This warranty gives you specific rights, and you may have other rights which vary from state to state or by jurisdiction.

Outside the United States and Canada

In countries other than the United States and Canada, the terms and conditions of this warranty may be different. Unless a specific Kodak warranty is communicated to the purchaser in writing by a Kodak company, no warranty or liability exists beyond any minimum requirements imposed by law, even though defect, damage, or loss may be by negligence or other act.

FCC compliance and advisory

This equipment has been tested and found to comply with the limits for a Class B digital device, pursuant to Part 15 of the FCC Rules. These limits are designed to provide reasonable protection against harmful interference in a residential installation. This equipment generates, uses, and can radiate radio frequency energy and, if not installed or used in accordance with the instructions, may cause harmful interference to radio communications. However, there is no guarantee that interference will not occur in a particular installation. If this equipment does cause harmful interference to radio or television reception, which can be determined by turning the equipment off and on, the user is encouraged to try to correct the interference by one or more of the following measures: 1) reorient or relocate the receiving antenna; 2) increase the separation between the equipment and the receiver; 3) connect the equipment to an outlet on a circuit different from that to which the receiver is connected; 4) consult the dealer or an experienced radio/TV technician for additional suggestions. Any changes or modifications not expressly approved by the party responsible for compliance could void the user's authority to operate the equipment. Where shielded interface cables have been provided with the product or specified additional components or accessories elsewhere defined to be used with the installation of the product, they must be used in order to ensure compliance with FCC regulation.

CE

Hereby, Eastman Kodak Company declares that this KODAK Product is in compliance with the essential requirements and other relevant provisions of Directive 1999/5/E.

Canadian DOC statement

DOC Class B Compliance—This Class B digital apparatus complies with Canadian ICES-003.

Observation des normes Classe B—Cet appareil numérique de la classe B est conforme à la norme NMB-003 du Canada.

Australian C-Tick



VCCI Class B ITE

この装置は、情報処理装置等電波障害自主規制協議会（VCCI）の基準に基づくクラスB情報技術装置です。この装置は、家庭環境で使用することを目的としていますが、この装置がラジオやテレビジョン受信機に近接して使用されると、受信障害を引き起こすことがあります。
取扱説明書に従って正しい取り扱いをして下さい。

Korean Class B ITE

B급 기기 (가정용 방송통신기기)	이 기기는 가정용(B급)으로 전자파적합등록을 한 기기로서 주로 가정에서 사용하는 것을 목적 으로 하며, 모든 지역에서 사용할 수 있습니다.
-----------------------	---

China RoHS

环保使用期限 (EUP)

在中国大陆, 该值表示产品中存在的任何危险物质不得释放, 以免危及人身健康、财产或环境的时间期限(以年计)。该值根据操作说明中所规定的产品正常使用而定。

有毒有害物质或元素名称及含量标识表

部件名称	有毒有害物质或元素					
	铅	汞	镉	六价铬	多溴联苯	多溴二苯醚
数码相机电路板元件	×	○	○	○	○	○
锂电池	×	○	○	○	○	○
交流变压器	×	○	○	○	○	○

○: 表示该有毒有害物质在该部件所有均质材料中的含量均在SJ/T 11363-2006规定的限量要求以下。

×: 表示该有毒有害物质至少在该部件的某一均质材料中的含量超出SJ/T 11363-2006规定的限量要求。



USB 数据线

Kodak

Eastman Kodak Company

Rochester, New York 14650

© Kodak, 2009

Kodak and EasyShare are trademarks of Eastman Kodak Company.

4H5437_en