



USER'S MANUAL

MANUEL DE L'UTILISATEUR
MANUAL DEL USUARIO

Model: WD32FL2120
LCD TV

TABLE OF CONTENTS

1	Important Safety Instructions	2
2	Safety Information	3
3	Preparation	What's Included 4
		Front View 5
		Rear View 6
		Installing the Stand 7
		Removing the Stand for Wall-Mounting 7
		Remote Control 8
4	Connecting External Devices	9
5	Customizing TV Settings	Initial Setup 10
		Navigating the Setup Settings 11
		APPS 12
		Media 13
		Viewing JPEG 13
		Viewing MJPEG 14
		Source 14
		Setup 15
		Settings 15
		Audio 16
		Picture 17
		Channel 18
Time 18		
Lock 19		
Network 20		
6	Parental Control	22
7	Troubleshooting	24
8	Maintaining	25
9	Specification	26
10	OTT APP Service	27

IMPORTANT SAFETY INSTRUCTIONS

- **Read these instructions** – All the safety and operating instructions should be read before this product is operated.
- **Keep these instructions** – The safety and operating instructions should be retained for future reference.
- **Heed all warnings** – All warnings on the appliance and in the operating instructions should be adhered to.
- **Follow all instructions** – All operating and use instructions should be followed.
- **Do not use this apparatus near water** – The appliance should not be used near water or moisture – for example, in a wet basement or near a swimming pool, and the like.
- Clean only with dry cloth.
- **Do not** block any ventilation openings. Install in accordance with the manufacturer's instructions.
- **Do not** install near any heat sources such as radiators, heat registers, stoves, or other apparatus (including amplifiers) that produce heat.
- **Do not** defeat the safety purpose of the polarized or grounding-type plug. A polarized plug has two blades with one wider than the other. A grounding-type plug has two blades and a third grounding prong. The wide blade or the third prong are provided for your safety. If the provided plug does not fit into your outlet, consult an electrician for replacement of the obsolete outlet.
- Protect the power cord from being walked on or pinched particularly at plugs, convenience receptacles, and the point where they exit from the apparatus.
- Only use attachments/accessories specified by the manufacturer.
- Use only with the cart, stand, tripod, bracket, or table specified by the manufacturer, or sold with the apparatus. When a cart is used, use caution when moving the cart/apparatus combination to avoid injury from tip-over.
- Unplug this apparatus during lightning storms or when unused for long periods of time.



- Unplug this apparatus during lightning storms or when unused for long periods of time.
- Refer all servicing to qualified service personnel. Servicing is required when the apparatus has been damaged in any way, such as the power-supply cord or plug is damaged, liquid has been spilled or objects have fallen into the apparatus, the apparatus has been exposed to rain or moisture, does not operate normally, or has been dropped.
- Please keep the unit in a well-ventilated environment.

WARNING: To reduce the risk of fire or electric shock, do not expose this apparatus to rain or moisture. The apparatus should not be exposed to dripping or splashing. Objects filled with liquids, such as vases should not be placed on apparatus.

WARNING: The batteries shall not be exposed to excessive heat such as sunshine, fire or the like.

WARNING: The mains plug is used as disconnect device, the disconnect device shall remain readily operable.

WARNING: To reduce the risk of electric shock, do not remove cover (or back) as there are no user-serviceable parts inside. Refer servicing to qualified personnel.



This lightning flash with arrowhead symbol within an equilateral triangle is intended to alert the user to the presence of non-insulated "dangerous voltage" within the product's enclosure that may be of sufficient magnitude to constitute a risk of electric shock.



The exclamation point within an equilateral triangle is intended to alert the user to the presence of important operating and maintenance instructions in the literature accompanying the appliance.



This equipment is a Class II or double insulated electrical appliance. It has been designed in such a way that it does not require a safety connection to electrical earth.



This product contains electrical or electronic materials. The presence of these materials may, if not disposed of properly, have potential adverse effects on the environment and human health. Presence of this label on the product means it should not be disposed of as unsorted waste and must be collected separately. As a consumer, you are responsible for ensuring that this product is disposed of properly.



This product meets ENERGY STAR® guidelines for energy efficiency. ENERGY STAR and the ENERGY STAR mark are registered U.S. marks. ENERGY STAR is a registered mark owned by the U.S. government.

Licensing and Patent Information

This WESTINGHOUSE product may be covered by one or more U.S. and foreign patents and patent applications.

SAFETY INFORMATION

To ensure reliable and safe operation of this equipment, please carefully read all the instructions in this user guide, especially the safety information below.

Electrical Safety

- The TV set should only be connected to a main power supply with voltage that matches the label at the rear of the product.
- To prevent overload, do not share the same power supply socket with too many other electronic components.
- Do not place any connecting wires where they may be stepped on or tripped over.
- Do not place heavy items on any connecting wire, which may damage the wire.
- Hold the main plug, not the wires, when removing from a socket.
- During a thunderstorm or when not in using the television for long periods, turn off the power switch on the back of the television.
- Do not allow water or moisture to enter the TV or power adapter. Do not use in wet, moist areas, such as bathrooms, steamy kitchens or near swimming pools.
- Pull the plug out immediately, and seek professional help if the main plug or cable is damaged, liquid is spilled onto the set, if the TV set accidentally exposed to water or moisture, if anything accidentally penetrates the ventilation slots or if the TV set does not work normally.
- Do not remove the safety covers. There are no user serviceable parts inside. Trying to service the unit yourself is dangerous and may invalidate the product's warranty. Qualified personnel must only service this apparatus.
- To avoid a battery leakage, remove batteries from the remote control, when the remote is not use for long period, or when the batteries are exhausted.
- Do not break open or throw exhausted batteries into a fire.

Physical Safety

- Do not block ventilation slots in the back cover. You may place the TV in a cabinet, but ensure at least 5cm (2") clearance all around.
- Do not tap or shake the TV screen, or you may damage the internal circuits. Take good care of the remote control.
- To clean the TV use a soft dry cloth. Do not use solvents or petroleum based fluids.
- Do not install near any heat sources such as radiators, heat registers, stoves or other apparatus (including amplifiers) that produce heat.
- Do not defeat the safety purpose of the polarized or grounding-type plug. A polarized plug has two blades with one wider than the other. A grounding plug has two blades and a third grounding prong, the wide blade, or the third prong is provided for your safety. If the provided plug does not fit into your outlet, consult an electrician for replacement of the obsolete outlet.
- Protect the power cord from being walked on or pinched particularly at plugs.
- Unplug the apparatus during lightning storms or when unused for long periods.
- Refer all servicing to a qualified service personnel. Servicing is required if the apparatus does not operate normally or if the apparatus, including the power supply cord or plug, has been damaged in any way.
- Servicing is also required if liquid has been spilled, or objects have fallen into the apparatus; when the apparatus has been exposed to rain or moisture; or if the apparatus has been dropped.
- Always connect your television to a power outlet with protective ground connection.

PREPARATION

What's Included

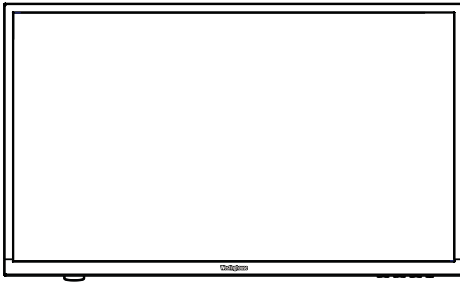

TV Set

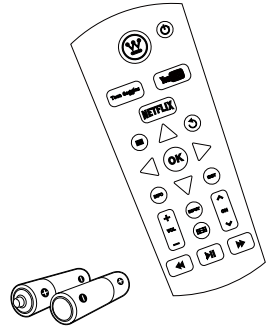

Remote Control with Batteries

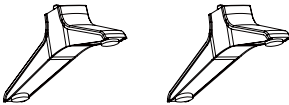

TV Stand

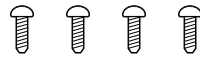

Four Screws

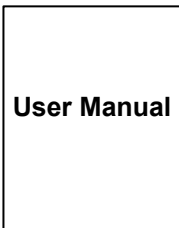

User Manual

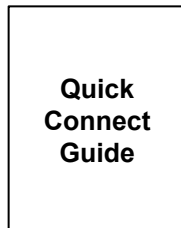

Quick Connect Guide

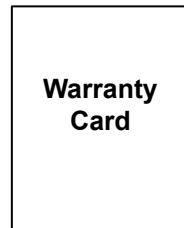

Warranty Card

Front View

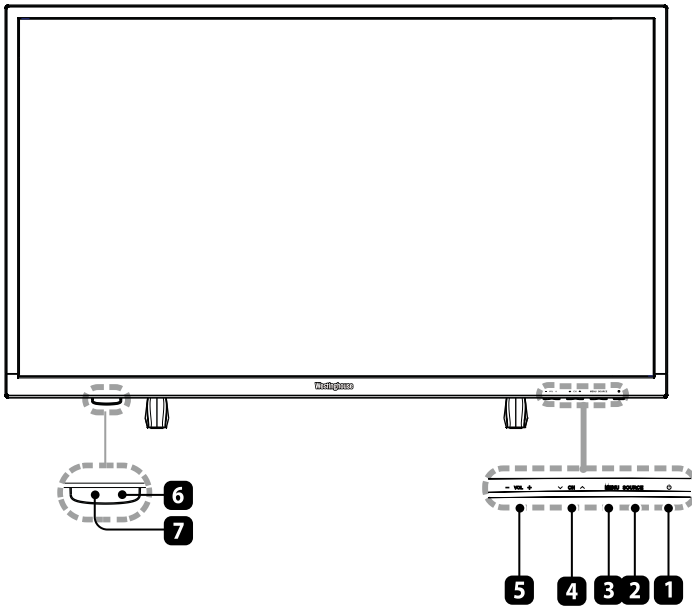

1. **POWER**
Switch the TV between On / Standby mode.
2. **SOURCE**
Press to select among different input signal sources.
3. **MENU**
Display the main menu.
4. **CH** ∇/\wedge
Press to select a channel.
5. **VOL** $-/+$
Press to adjust the volume.
6. **POWER Indicator**
Illuminate blue when the TV is turned on. Illuminate red when the TV is in standby mode.
7. **IR (Infrared Receiver)**
Receive IR signals from the remote control.

Rear View

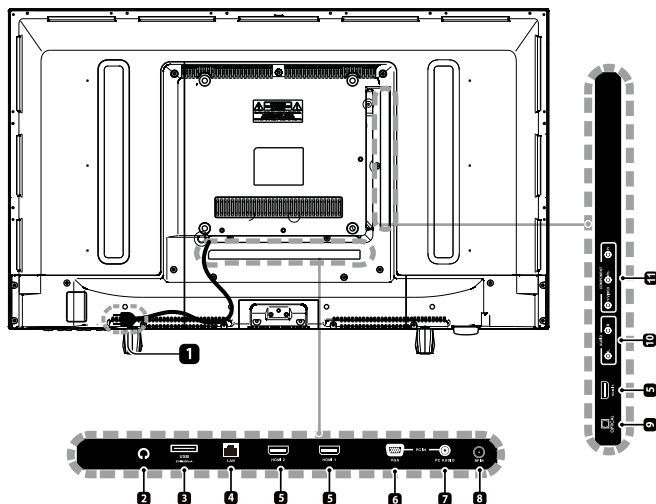

1. **Power Cord**
Connect to AC power outlet.
2. **Headphone Socket**
Connect to the Headphones.
3. **USB Port**
Connect to a USB storage device to play compatible movie and photo files.
4. **LAN**
Network connection port.
5. **HDMI Input**
Connect to a High-Definition (HD) signal input device.
6. **VGA Input**
Connect to a computer or other devices with a VGA interface.
7. **PC AUDIO Input**
Connect to a computer audio output.
8. **DTV/TV Input**
Connect to the antenna (75Ω VHF/UHF) socket with the RF coaxial cable.
9. **OPTICAL Output**
Connect a digital sound system to this jack.
10. **AUDIO Input**
Connect to the AUDIO (L/R) output sockets on external audio devices.
11. **COMPOSITE/COMPONENT IN**
Connect to AV devices with composite/component (Y/Pb/Pr) video and audio output sockets. COMPOSITE VIDEO and COMPONENT(Y/PB/PR) share with AUDIO IN (L/R).

Installing the Stand

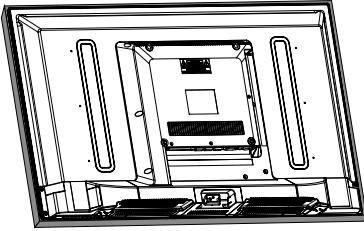

- 1. Lay the TV face down on a flat, cushioned surface to avoid damaging or scratching.
- 2. Fix the Left Base Stand to the main unit using 2 pcs provided screws.
- 3. Fix the Right Base Stand to the main unit using 2 pcs provided screws.

Removing the Stand for Wall-Mounting

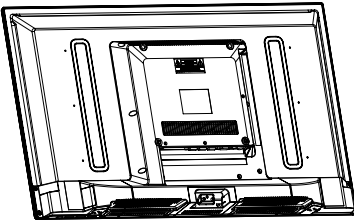

- 1. Lay the TV face down on a flat, cushioned surface to avoid damaging or scratching.
- 2. Untighten the 4 pcs screws holding the stand assembly and remove them.
- 3. Attach the wall-mount bracket to the TV using the mounting holes on the back of the TV. Mount this TV according to the instructions included in the wall-mount bracket.

WARNING: This apparatus is intended to be supported by UL Listed wall mount bracket.

Remote Control

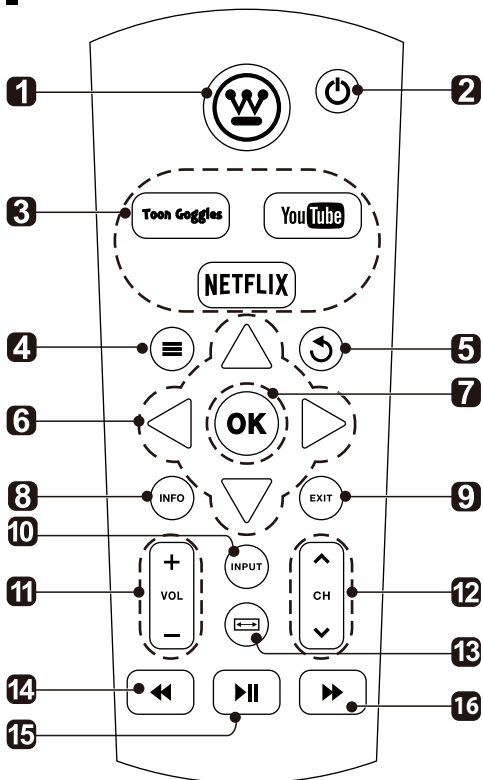

1. **HOME**: Display the Home menu.
2. **POWER**: Turn the LED TV on or off.
3. **APPS**: Press to select the desired APPS.
4. **≡**: Display the main TV menu.
5. **↶**: Return to previous menu button.
6. **◀▶∇▶**: Allows you to navigate the OSD menus and adjust the system settings to your preference.
7. **OK**: Confirm the selection in the OSD (on screen display).
8. **INFO**: Displays the current input source and the channel information.
9. **EXIT**: Exit the main TV menu.
10. **INPUT**: Select among the different input signal sources: TV/AV/YPBPR/HDMI1/HDMI2/HDMI3/VGA.
11. **VOL+/-**: Press to increase/decrease the sound level.
12. **CH^/∨**: Press to scan through channels.
13. **⏏**: Press to select Aspect Ratio.
14. **◀◀**: Reverse playback rapidly.
15. **▶▶**: Start playback or pause.
16. **▶▶**: Advance playback rapidly.

CONNECTING EXTERNAL DEVICES

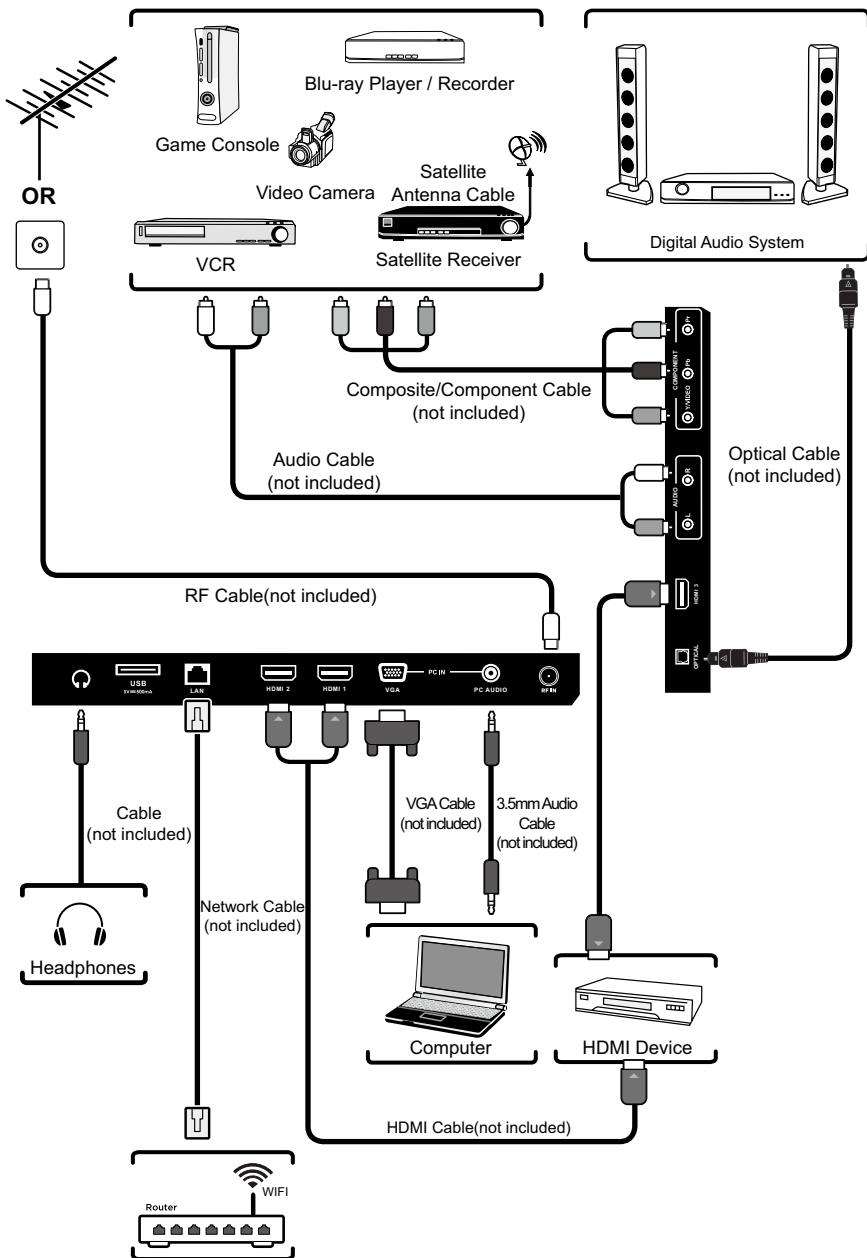

CUSTOMIZING TV SETTINGS

Initial Setup

- Connect the power cord to the power socket after you have completed all the physical connections. At this stage, the TV will enter Standby Mode and the red LED indicator will illuminate.
- In Standby Mode, press the **U** button on the main unit or on the remote control to turn the TV on. The red LED indicator will turn blue.
- The first time you turn the TV on, it will go into the Setup Wizard. Press **▲/▼** buttons to select your desired mode and press **OK** to confirm.

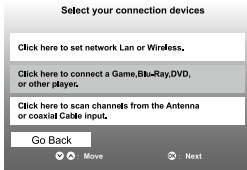
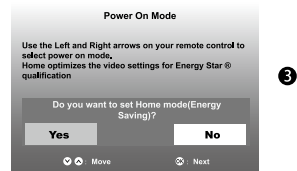
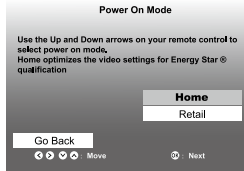
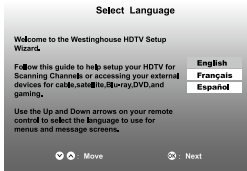

Home (Energy Star) is the default as-shipped television configuration and settings. And **Home (Energy Star)** is the setting in which the product qualifies for **ENERGY STAR®**. Any changes to default as-shipped television configuration and settings would change the energy consumption. And enabling certain optional features and functionalities may increase energy consumption beyond the limits required for **ENERGY STAR®** qualification, as applicable.

Retail Mode : Select Retail Mode if you would like your picture to be brighter. At times this mode may use more energy to operate the Volume/Sound Mode and the Picture Mode. In this setting, the power consumption may possibly exceed the limited requirement of the **ENERGY STAR®** qualification.

ENERGY STAR® is a set of power-saving guidelines issued by the U.S. Environmental Protection Agency(EPA).

ENERGY STAR® is a joint program of the U.S. Environmental Protection Agency and the U.S. Department of Energy helping us all save money and protect the environment through energy efficient products and practices.

- **The ON-MODE Power under Home Mode should be less than 28 W**
- **The SLEEP-MODE Power should be less than 0.5 W.**

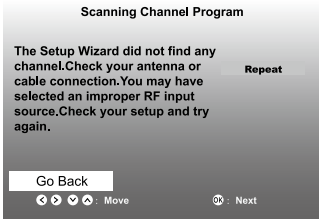
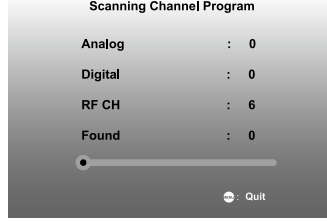
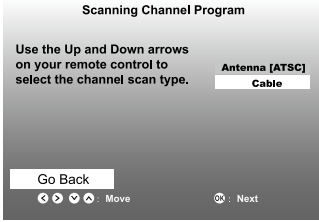

- If channels can not be found, this frame will be displayed automatically.

Navigating the Setup Settings

- Press the **MENU** button to display the main menu.
- Use **◀/▶** buttons to select **setup** menu and then press **OK** buttons to enter, then press **◀/▶** to navigate and select the available menu.

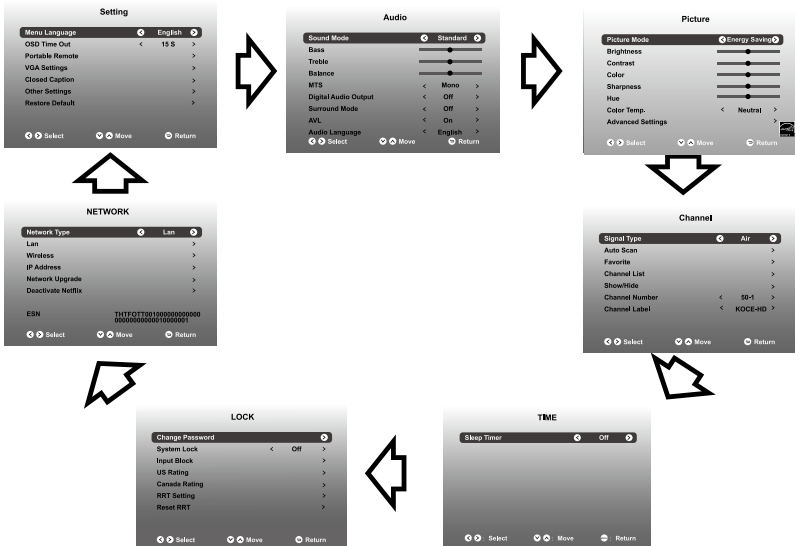

APPS



- Press the **MENU** button on the main unit or on the remote control to display the main menu. Then use ◀/▶ to select the **apps** and press **OK** button to enter. Use ◀/▶ to select the desired app. Or press the hotkey on the remote control to enter the APP directly.

Note: After the TV connects to network, the status Unconnected will alter to Connected.

NETFLIX	Enjoys TV shows & movies streamed instantly over the Internet.
YouTube	YouTube your way on the best screen in your house.
Toongoggles	A subscription video on-demand platform that offers animated, fun and educational cartoons, engaging games and songs from all over the world and in many different languages to children.
AccuWeather	Displays the current weather conditions and the temperature anywhere in the world in centigrade or Fahrenheit.

MEDIA



NOTE: Portable storage devices(USB disk or Hard disk) should be inserted.

- Press the **MENU** button on the main unit or on the remote control to display the main menu. Then use **◀/▶** to select the **media** and press **OK** button to enter. Use **◀/▶** to select the desired option.

■ Viewing JPEG

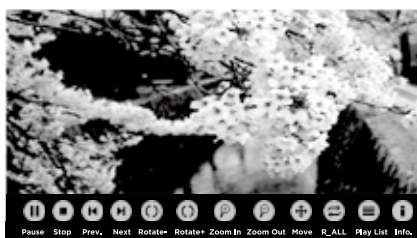
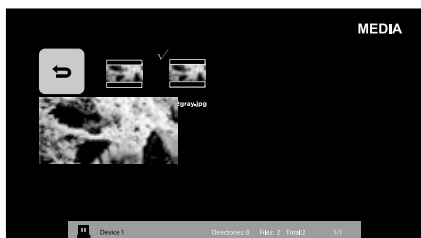
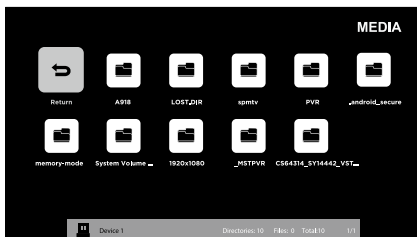
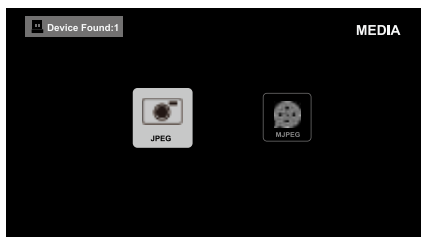

- After entering **MEDIA**, press **◀/▶** buttons to select **JPEG** and then select the disk type to enter. Then use **▲/▼/◀/▶** buttons to navigate in the picture folder and then select the desired picture and press **OK** button, when **✓** appears on the top-left, press **▶||** to play the picture, or press **menu** button to display the control bar, then use **◀/▶** to select **Play** to display the picture.

■ Viewing MJPEG

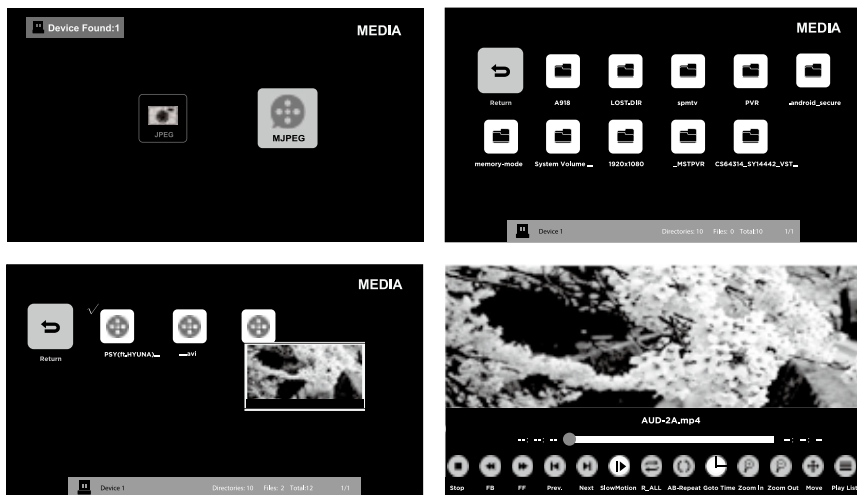

- After entering **MEDIA**, press ◀/▶ buttons to select **MJPEG** and then select the disk type to enter. Then use ▲/▼ / ◀/▶ buttons to navigate in the video folder and then select the desired video and press **OK** button, when ✓ appears on the top-left, press ▶▶ to play the video, or press **menu** button to display the control bar, then use ◀/▶ to select **Play** to display the video.

■ SOURCE



- Press the **menu** button on the main unit or on the remote control to display the main menu. Then use ◀/▶ to select the **source** and press **OK** button to enter. Use ◀/▶ to select the desired input sources among: **TV/ AV/ YPBPR/ HDMI1/ HDMI2/ HDMI3/ VGA** and press **OK** button to confirm.

SETUP

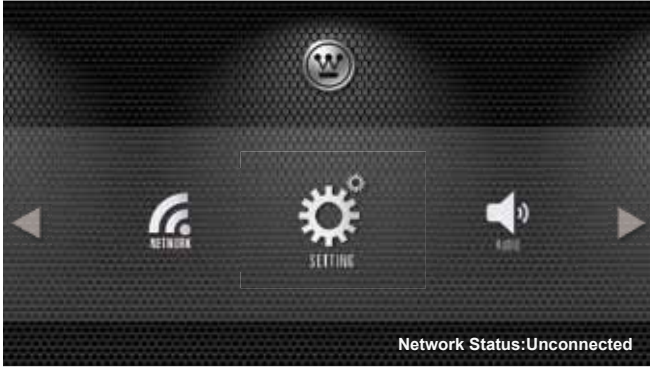

- Press the **menu** button on the main unit or on the remote control to display the main menu. Then use **◀/▶** to select the **setup** and press **OK** button to enter. Use **◀/▶** to select the desired option.

SETTING

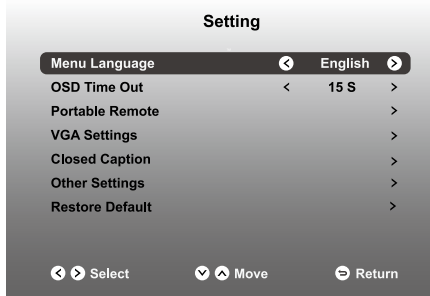

- Press **◀/▶** buttons to select **SETTING** menu and then press **OK** button to enter. Press **▲/▼** buttons to select the following setting options and then press **◀/▶** buttons to adjust each option's setting.

Menu Language	Select menu language : English, Français or Español. The default on-screen menu language is English.
OSD Time Out	Select OSD time among 15s/30s/45s/60s.
Portable Remote	Firstly, use your portable device to scan the QR code to download the APP(<i>Make sure the portable device and the TV in the same network</i>), or you may also type in "Westinghouse Remote" in Google Play or APP store to download the APP. Secondly, enter the 6 digits code after app installation. 6 digits code: N/A(<i>You can find the 6 digits code under the QR code</i>).
VGA Settings	To adjust the VGA settings:H-Pos, V-Pos, Clock, Phase, Auto.

Closed Caption	CC Mode	Select CC mode :CC On, CC Off or CC On Mute.
	Analog CC	Basic Selection: CC1, CC2, CC3, CC4, Text1, Text2, Text3, Text4.
	Digital CC	Advanced Selection: Service1, Service2, Service3, Service4, Service5, and Service6.
	Option	Mode, Font Style, Font Size, Font Edge Style, Font Edge Color, FG Color, BG Color, FG Opacity, BG Opacity.
Other Settings	Turn On or Off the Audio Only.	
Restore Default	Restore the TV to factory default settings.	

■ AUDIO

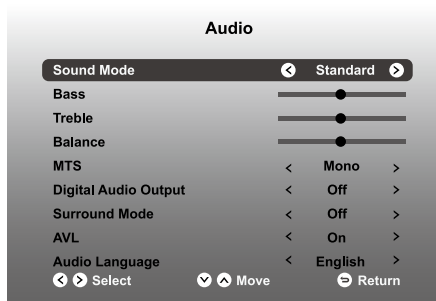

- Press ◀/▶ buttons to select **AUDIO** menu and then press **OK** button to enter. Press ▲/▼ buttons to select the following audio options and then press ◀/▶ buttons to adjust each option's setting.

Sound Mode	Allow the selection of an audio-enhancement technique: Standard/Music/Movie/Sports/User.
Bass	Control the relative intensity of lower-pitched sounds. <i>(For User mode)</i>
Treble	Control the relative intensity of higher-pitched sounds. <i>(For User mode)</i>
Balance	Adjust the relative volume of the speaker in a multiple speaker system.
MTS	Press button ▲/▼ to select MTS, then press button ◀/▶ to adjust.
Digital Audio Output	Select the digital audio output mode between RAW/PCM/Off.
Surround Mode	Turn On or Off the surround mode.
AVL	Volume levels are automatically controlled to On or Off.
Audio Language	Select audio language among: English, Français or Español.

■ PICTURE

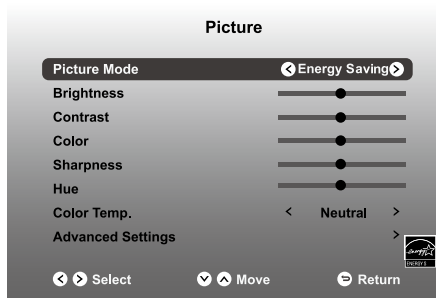

- Press ◀/▶ buttons to select **PICTURE** menu and then press **OK** button to enter. Press ▲/▼ buttons to select the following picture options and then press ◀/▶ buttons to adjust each option's setting.

Picture Mode	Cycle among picture mode: Energy Saving/User/Retail/Movie.
Brightness	Increase or decrease the amount of white in the picture. <i>(For User mode)</i>
Contrast	Adjust the difference between light and dark levels in the pictures. <i>(For User mode)</i>
Color	Control the color intensity. <i>(For User mode)</i>
Sharpness	Adjust the level of crispness in the edges between light and dark areas of the picture. <i>(For User mode)</i>
Hue	Adjust the hue intensity.
Color Temp.	Cycle among color temperatures: Neutral/Warm/User/Cool.
Advanced Settings	Select and adjust the following settings. 1) Aspect Ratio: Choose to view the TV picture in various formats among: Standard/Fill. 2) Noise Reduction: Reduces the noise level of the connected device: Off/Weak/Medium/Strong. 3) Dynamic Contrast: Set dynamic contrast to On/Off. 4) White Balance: To adjust the white balance.

■ CHANNEL

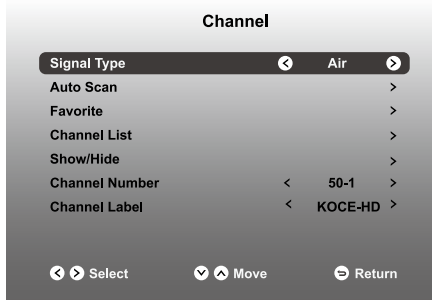

- Press ◀/▶ buttons to select **CHANNEL** menu and then press **OK** button to enter. Press ▲/▼ buttons to select the following channel options and then press ◀/▶ buttons to adjust each option's setting.

Signal Type	Select antenna between Air and Cable.
Auto Scan	Cable: Select your cable system from: Auto/STD/IRC/HRC. Auto Scan: Select the Auto Scan feature to scan your available cable channels.
Favorite	Set the selected channel as favorite channels.
Channel List	Display the current channel list.
Show/Hide	Show/Hide the selected channel.
Channel Number	Display the current channel number.
Channel Label	Display the current channel label.

■ TIME

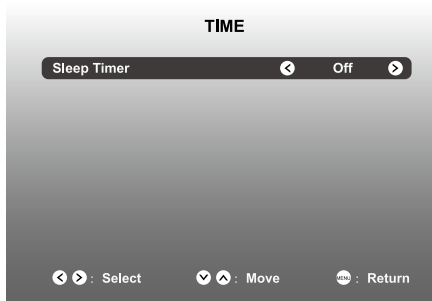

- Press ◀/▶ buttons to select **TIME** menu and then press **OK** button to enter. Press ▲/▼ buttons to select the following time options and then press ◀/▶ buttons to adjust each option's setting.

Sleep Timer	Select a period of time after which the TV automatically switches to standby mode: Off/5/10/.../180/240 min.
--------------------	--

■ **LOCK**

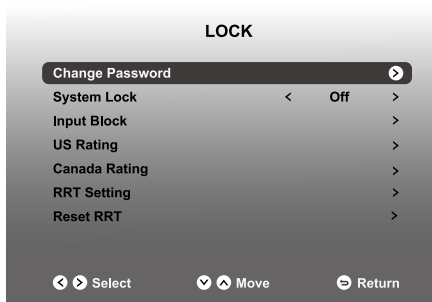

- Press ◀/▶ buttons to select **LOCK** menu and then press **OK** button to enter. Use the 0-9 buttons to input 4-digit password to enter the **LOCK** menu.
- Press ▲/▼ buttons to select the following lock options and then press ◀/▶ buttons to adjust each option's setting.

Note: the default password is "0000".

Change Password	Use 0-9 buttons to input the new 4-digit password and re-enter to confirm the new password.	
System Lock	Select to turn On/Off system lock. The following options (US, Canada, Reset RRT) will only be accessible when you turn the system lock on.	
Input Block	To block or unblock the different input sources.	
US Rating	TV	TV RATING: Press OK button to lock or unlock TV rating.
	MPAA	Select MPAA rating : N/A,G, PG, PG-13, R, NC-17, or X.
Canada Rating	Canada English	Select MPAA rating for English-speaking Canada : E, C, C8+, G, PG, 14+, 18+.
	Canada French	Select MPAA rating for Quebec Canada : E, G, 8 ans+, 13 ans+, 16 ans+, 18 ans+.
RRT Setting	Set Rating Region Table.	
Reset RRT	Select to reset the RRT setting.	

NETWORK

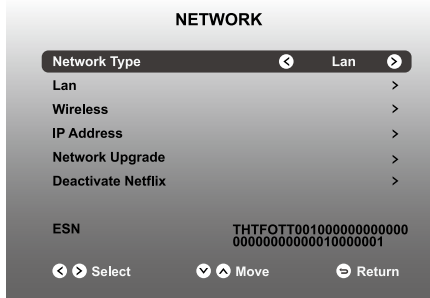

- Press ◀/▶ buttons to select **NETWORK** menu and then press **OK** button to enter. Press ▲/▼ buttons to select the following network options and then press ◀/▶ buttons to adjust each option's setting.

Network Type	Select two types of network: Wireless or Lan.
Lan	Connect the TV to the wired Lan: Auto Get IP/Manual Get IP.
Wireless	Connect the TV to the wireless network through searching the available Wifi.
IP Address	Display the current IP information.
Network Upgrade	Upgrade the TV software through the network.
Deactivate Netflix	Deactivate Netflix and clear the account information.
ESN	Electronic Serial Number

Auto Upgrade

- After the TV connects to network, the system will automatically detect software version.



- If there is a new version, it will be downloaded in the background. When you want to enter the app, a menu bar will pop up reminding you that upgrade software is downloading. Please try later...

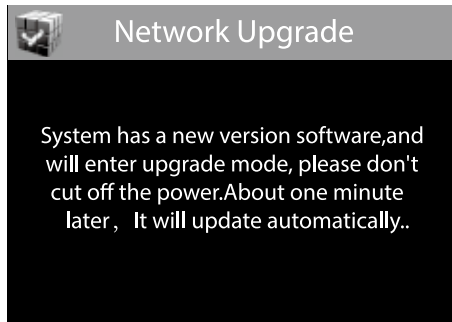

- After the download completed, it can upgrade automatically after users press the standby button.

Note: This procedure is fully automatic, and remember not to cut off the power.

Manual Upgrade

- After the TV connects to network, users can detect whether there is a new version through network manual option.

Reminder for internet connection:

- Below occasions are possible while your internet is connected to enjoy your OTT services.
- 1. Please check your internet signal strength while internet is connected, signal strength below 50 may result bad connection and non-smooth picture.
- 2. To enter OTT services, 30 second may be required for internet connection.

Recommended 10Mb above internet speed

PARENTAL CONTROL

Press the **MENU** button on the main unit or on the remote control and then press ◀/▶ buttons to select **LOCK** menu. Use the **0-9** buttons to input the 4-digit password to enter the **LOCK** menu. If used, this option feature can "block" undesirable programming from appearing on the TV. Parental Control offers the user a wide variety of options and settings that restrict or "block" the programming that can appear on the TV. Parental Control allows the user to define which program rating they consider acceptable for younger more sensitive viewer. It can be preset and turned either on or off by the user who specifies the secret 4-number code, the password. The number of hours blocked are specified. General audiences and children blocks should be both programmed into the TV's memory. Separate different viewer ratings are specified for both TV and the motion picture Industry; both rating systems should be used and based on the ages of children.

Overview

To ensure complete coverage for all TV programs, (movies and regular TV shows) choose a rating for MPAA, from the selections below, as well as ratings from the TV Parental Guidelines Rating Systems below, using the Age Block option for General Audiences, and for children. In addition, you may wish to add additional restrictions from the content block menu, and submenu examples below.

Things to Consider before Setting up Parental Control

Determine which rating you consider acceptable to the viewer. (For example, if you choose TV-PG, more restrictive ratings will be automatically blocked; the viewer will not be able to see: TV-PG, TV-14, or TV-MA rated programming.) You may block the auxiliary video source entirely. (Blocks the signal sent by the equipment, such as VCR, connected to the TV Audio/Video Input Jacks) or remain unblocked, then choose acceptable ratings. Block program "Content" based on individual parameters such as: Strong Dialog, Bad Language, Sex Scenes, Violence Scenes or Fantasy. Violent Scenes; in Content Blk option. Select a secret password, in the Set Password option, using the numbers keys on the remote control. Save the password, it is the only way to access the Parental Control menu and change rating setting, or turn off Parental Control.

- You can set different Parental Control viewing restrictions for general audiences and for children, both can be active at the same time.
- Simply specifying one content block such as Sex Scenes, will not automatically restrict the programming that appears from the video sources.
- Even If you choose to leave the AUX Inputs unblocked, the ratings you specify will automatically restrict the programming that appears from the video sources.
- You cannot disable Parental Control by disconnecting the TV from power. Block hours will be automatically reset to the original block time setting specified if power is disconnected.

PARENTAL CONTROL

• Motion Picture Association of America (MPAA) Rating System

	Grade	Meaning
G	General Audiences	Content not offensive to most viewers.
PG	Parental Guidance Suggested	Content is such that parents may not want their children to view the program.
PG-13	Parents Strongly Cautioned	Program is inappropriate for preteens, with a greater degree of offensive material suggested than a PG rated program.
R	Restricted	Not for children under 17-contains strong element of sex and/or violence.
NC-17	No children under age 17	Not for children under 17-under any circumstances. Contains strong sexual content.
X	Hard Core Films	Same as NC-17 rating.
No Rating	No Rating	MPAA did not rate

• TV Parental Guideline Rating System

	Grade	Meaning
TV-Y	All Children	Content not offensive to most viewers.
TV-Y7	Directed to Older Children	Considered suitable for children over 7- may contain fantasy violence scenes.
TV-G	General Audience	Considered suitable for all audience; children may watch unattended.
TV-PG	Parental Guidance Suggested	Suggested unsuitable for younger children-may contain suggestive language, bad language, sex and violence scenes.
TV-14	Parents Strongly Cautioned	unsuitable for children under 14 - may contain strong language, bad language, sex, and violence scenes.
TV-MA	Mature Audience Only	Adults only- may contain strong language, bad language, sex, and violence scenes.

Canadian Rating:

Canadian English is used throughout all English-speaking Canada (C, C8+, G, PG, 14+, 18+).

Canadian French is used in Quebec (G, 8 ans+, 13 ans+, 16 ans+, 18 ans+)

Note: The V-Chip will automatically block certain categories that are "more restrictive". If you block TV-Y category, then TV-Y7 will be automatically blocked. Similarly, if you block TV-G category, then all the categories in the "young adult" will be blocked (TV-G, TV-PG, TV-14, and TV-MA).

TROUBLESHOOTING

If your TV does not operate normally or cannot be turned on, please check the following troubleshooting questions. Remember also to check any other connected electronic device, such as DVD or Blu-ray player to pinpoint the problem. If the TV still fails to operate normally, please contact technical support.

The TV does not operate properly	
The TV does not respond when pressing any buttons	<ul style="list-style-type: none"> The TV may freeze up during use. Disconnect the power cord from the power socket for a few minutes. Reconnect the power cord and try to operate it again as usual.
TV cannot be switched on	<ul style="list-style-type: none"> Check that the TV is connected to the power supply. Make sure all connected AV devices are switched off before switching on your TV.
The remote control does not work	<ul style="list-style-type: none"> Check to see if there are any objects between the TV and the remote control causing an obstruction. Ensure that you are pointing the remote control directly at the TV. Ensure that the batteries are installed with the correct polarity (+ to +, - to -). Install new batteries.
Power is suddenly turned off	<ul style="list-style-type: none"> Check the power of the TV. The power supply maybe interrupted. Check if the sleep timer is set. Check whether the Auto Standby is activated.
The video function does not work	
No picture & No Sound	<ul style="list-style-type: none"> Check whether the TV is switched on. Try another channel. The problem may be caused by the broadcaster.
Picture appears slowly after switching on	<ul style="list-style-type: none"> This is normal; the image is muted during the TV startup process. Please contact your service centre if the picture has not appeared after five minutes.
No or poor color or poor picture	<ul style="list-style-type: none"> Adjust the settings in the PICTURE menu. Try another channel. The problem may be caused by the broadcaster. Check if video cables are connected properly.
Horizontal/Vertical bar or picture shaking	<ul style="list-style-type: none"> Check for local interference such as an electrical appliance or power tool.
Poor reception on some channels	<ul style="list-style-type: none"> The station or cable channel may be experiencing problems; tune to another station. Station signal may be weak, reposition the antenna for better reception. Check for sources of possible interference.
Lines or streaks in pictures	<ul style="list-style-type: none"> Check antenna (change the position of the antenna.)
No pictures when connecting HDMI	<ul style="list-style-type: none"> Check if the input source is HDMI1/HDMI2/HDMI3.
Pictures appear in wrong ratio	<ul style="list-style-type: none"> Adjust the Aspect Ratio settings in the SETUP menu or press the ASPECT button on the remote control.

TROUBLESHOOTING

The audio function does not work	
Picture OK but no sound	<ul style="list-style-type: none">• Press the VOL +/- buttons.• Sound muted? Press the MUTE button.• Try another channel. The problem may be caused by the broadcaster.
No output from one of the speakers	<ul style="list-style-type: none">• Adjust the Balance settings in the AUDIO menu.
Unusual sound from inside the TV	<ul style="list-style-type: none">• A change in ambient humidity or temperature may result in an unusual noise when the TV is switched on or off and does not indicate a fault with the TV.
No sound when connecting HDMI	<ul style="list-style-type: none">• Check if the input source is HDMI1/HDMI2/HDMI3.
Audio noise	<ul style="list-style-type: none">• Keep the RF coaxial cable away from the other connected cables.
Password	
Lost password	<ul style="list-style-type: none">• Select the SET Password setting in the LOCK menu, then enter the following master password "8899". The master password clears your previous password and allows you to enter a new password.
There is a problem in PC mode	
The signal is out of range (invalid format)	<ul style="list-style-type: none">• Adjust the resolution, horizontal frequency, or vertical frequency.
Vertical bar or stripe on background & Horizontal Noise & Incorrect position	<ul style="list-style-type: none">• Use Auto configures or adjust clock, phase, or H/V position.
Screen color is unstable or show a single color	<ul style="list-style-type: none">• Check the signal cable.• Reinstall the PC video card.

Maintaining

- Do not use your TV in areas that are too hot or too cold, because the cabinet may warp or the screen may malfunction. Your TV works best in temperatures that are comfortable to you.
- Storage temperatures are 32° to 122°F(0° to 50°C)
- Working temperatures are 32° to 95°F(0° to 35°C)
- Do not place your TV in direct sunlight or near a heat source

SPECIFICATION

Panel Size	31.5inch diagonally
Display Type	DLED
Panel Technology	TFT
Panel 60 Hz Vs. 120 Hz	60 Hz
Display Resolution	720P
HDMI Support	Up to 1080P
Panel Resolution	1366 x 768
Aspect Ratio	16:9
Dynamic Contrast Ratio-Panel	4000:1
Response Time (G To G)	6.5 ms
Lamp Life (Typ. Hours)	30,000 hours
Horizontal Viewing Angle (At CR>10)	178
Vertical Viewing Angle (At CR>10)	178
Wall-mount(LxW-mm)	200*200 VESA(mm)

IC Statement

This device complies with Industry Canada licence-exempt RSS standard(s). Operation is subject to the following two conditions:

(1) This device may not cause harmful interference, and (2) this device must accept any interference, including interference that may cause undesired operation of the device."

This equipment should be installed and operated with a minimum distance of 20 cm between the radiator and your body.

CAN ICES-3(B).

Canadian DOC Statement

Standard Television Receiving Apparatus Canade BETS-7

This Class B digital apparatus complies with Canadian ICES-003.

OTT APP SERVICE

If you want to know about these APP information or get more service. Please refer to following content.

- Netflix



You can call the following telephone for more help: **866-579-7172**

If your matter is regarding customer service, please refer to <https://contactus.netflix.com/help> for alternative contact information.

- YouTube



You can browse the following website for more help:

<https://productforums.google.com/forum/#!categories/youtube/smart-tvs>

- TG



You can call the following telephone for more help: **888-874-5411**

- AccuWeather



You can send E-mail to AccuWeather for more help: CustomerService@AccuWeather.com

TABLE DES MATIÈRES

1	Consignes de sécurité importantes	2
2	Renseignements sur la sécurité	3
3	Préparation	Éléments compris 4
		Vue avant 5
		Vue arrière 6
		Installation du socle 7
		Retrait du socle en vue d'un montage mural 7
		Télécommande 8
4	Connexion des appareils externes	9
5	Personnalisation des paramètres du téléviseur	Configuration initiale 10
		Naviguer dans les paramètres de configuration 11
		APPS 12
		Média 13
		Regarde JPEG 13
		Regarde MJPEG 14
		Source 14
		Configuration 15
		Paramètres 15
		Audio 16
		Image 17
		Canal 18
		Heure 18
Verrouillage 19		
Réseau 20		
6	Contrôle parental	22
7	Dépannage	24
8	Entretien	25
9	Caractéristiques technique	26
10	OTT APP Service	27

CONSIGNES DE SÉCURITÉ IMPORTANTES

- **Lisez ces consignes** – Avant d'utiliser ce produit, vous devez lire toutes les consignes liées à la sécurité et au fonctionnement de l'appareil.
 - **Conservez ces consignes** – Nous vous conseillons de conserver les consignes liées à sécurité et au fonctionnement de l'appareil pour consultation future.
 - **Observez toutes les mises en garde** – Vous devez suivre toutes les consignes liées au fonctionnement et à l'utilisation de l'appareil.
 - **Suivez toutes les consignes** – Vous devez suivre toutes les consignes liées au fonctionnement et à l'utilisation de l'appareil.
 - **N'utilisez pas cet appareil près de l'eau** – L'appareil ne doit pas être utilisé près de l'eau ou dans un lieu humide, par exemple dans un sous-sol humide ou près d'une piscine et autres.
 - Nettoyez uniquement à l'aide d'un chiffon sec.
 - N'obstruez pas les orifices de ventilation. Installez l'appareil conformément aux consignes du fabricant.
 - N'installez pas l'appareil à proximité d'une source de chaleur comme un radiateur, une bouche de chaleur, une cuisinière ou d'autres appareils qui produisent de la chaleur (y compris les amplificateurs).
 - Ne contournez pas le dispositif de sécurité de la fiche polarisée ou de la fiche de mise à la terre. Une fiche polarisée comporte deux lames dont l'une est plus large que l'autre. Une fiche avec mise à la terre comporte deux lames, en plus d'une broche de masse. La lame plus large ou la broche de masse vise à assurer votre sécurité. Si la fiche fournie n'est pas compatible avec votre prise, adressez-vous à un électricien pour faire remplacer la prise, qui est probablement désuète. Protect the power cord from being walked on or pinched particularly at plugs, convenience receptacles, and the point where they exit from the apparatus.
 - Placez le cordon d'alimentation de sorte qu'il ne risque pas d'être piétiné ou coincé, particulièrement au niveau de la fiche et de la prise de courant, ainsi qu'au point de sortie de l'appareil.
 - N'utilisez que les fixations et les accessoires recommandés par le fabricant.
 - Utilisez l'appareil uniquement avec le chariot de manutention, le support, le trépied ou la table recommandé par le fabricant ou vendu avec l'appareil. Si vous utilisez un chariot, déplacez-le avec précaution afin d'éviter de le renverser et de vous blesser.
- Débranchez l'appareil en cas d'orage ou lorsqu'il reste inutilisé pendant une période prolongée.
- Confiez toute réparation à un technicien qualifié. Une réparation est nécessaire si l'appareil a été endommagé d'une manière ou d'une autre, par exemple lorsque le cordon d'alimentation ou la fiche est endommagé, si un liquide a été renversé sur l'appareil, ou si des objets sont tombés sur celui-ci, l'appareil a été exposé à la pluie ou à l'humidité, s'il fonctionne mal ou s'il est tombé. Please keep the unit in a well-ventilated environment.





- Veuillez installer l'appareil à un endroit bien aéré.
- **MISE EN GARDE** : pour réduire les risques d'incendie et de choc électrique, n'exposez pas cet appareil à la pluie ou à l'humidité. Ne l'exposez pas non plus aux égouttements ou aux éclaboussures. Ne placez pas d'objets remplis de liquide, par exemple un vase, sur le dessus de l'appareil.
- **MISE EN GARDE** : n'exposez pas les piles à une chaleur excessive comme celle induite par la lumière du soleil, un feu ou autrement.
- **MISE EN GARDE** : la prise secteur sert de dispositif de désaccouplage; elle doit demeurer facilement accessible.
- **MISE EN GARDE** : afin de réduire les risques d'électrocution, retirez pas le couvercle (ou le panneau arrière), car il n'y a aucune pièce réparable par l'utilisateur à l'intérieur. Confiez les réparations à un technicien qualifié.



 Le symbole représentant un éclair terminé par une flèche à l'intérieur d'un triangle équilatéral vise à avertir l'utilisateur du danger de la présence d'une « tension dangereuse » présentée par des pièces non isolées à l'intérieur de l'appareil, éventuellement suffisante pour constituer un risque d'électrocution.

 Le symbole de point d'exclamation à l'intérieur un triangle équilatéral, vise à informer l'utilisateur de la présence de consignes de fonctionnement et de maintenance importantes dans la documentation qui accompagne l'appareil.

 Cet équipement est un appareil électrique de classe II ou à double isolation. Il a été conçu de sorte à ne pas nécessiter une connexion de sécurité mise à la terre.

 Ce produit contient des composants électriques ou électroniques. S'ils ne sont pas mis aux rebuts adéquatement, ces composants pourraient nuire à l'environnement ou à la santé des humains.

 La présence de cette étiquette sur le produit signifie qu'il ne doit pas être mis aux rebuts en tant que déchet non trié, mais faire l'objet d'une collecte sélective. Comme consommateur, vous devez vous assurer que ce produit est mis aux rebuts de la bonne manière.

Ce produit est conforme aux directives ENERGY STAR® pour l'efficacité énergétique. ENERGY STAR et la marque ENERGY STAR sont des marques américaines déposées. ENERGY STAR est une marque déposée appartenant au gouvernement des États-Unis.



Licences et brevets information

Ce produit WESTINGHOUSE peut être couvert par un ou plusieurs brevets américains et étrangers et des brevets applications.

RENSEIGNEMENTS SUR LA SÉCURITÉ

Pour vous assurer du fonctionnement fiable et sécuritaire de cet équipement, veuillez lire avec attention les consignes de ce guide d'utilisation, et plus particulièrement les renseignements ci-dessous portant sur la sécurité.

Sécurité électrique

- Le téléviseur ne doit être raccordé qu'à l'alimentation principale, à une tension correspondant à celle indiquée sur l'étiquette à l'arrière de l'appareil.
- Pour éviter les surcharges, ne branchez pas plusieurs autres appareils électroniques sur la prise utilisée pour le téléviseur.
- Pour éviter le piétinement et les chutes, ne placez pas les câbles de connexion à des endroits où les gens circulent.
- Pour éviter d'endommager les câbles de connexion, ne posez pas d'objets lourds sur ceux-ci.
- Lors du désaccouplement de la fiche d'une prise, tirez sur la fiche et non sur le câble.
- En cas d'orage ou lorsque le téléviseur reste inutilisé pendant une période prolongée, fermez l'interrupteur d'alimentation à l'arrière de l'appareil.
- Évitez de laisser de l'eau ou de l'humidité pénétrer à l'intérieur du téléviseur ou de l'adaptateur de courant. N'utilisez PAS l'appareil dans une pièce mouillée ou humide, comme une salle de bain ou une cuisine pleine de vapeur, ou près d'une piscine.
- Débranchez immédiatement l'appareil et demandez l'aide d'un professionnel si la fiche ou le câble est endommagé, si du liquide a été renversé sur le téléviseur, si celui-ci est exposé accidentellement à de l'eau ou de l'humidité, si un objet quelconque pénètre dans les orifices de ventilation par inadvertance ou si le téléviseur ne fonctionne pas normalement.
- Laissez les couvercles de sécurité en place. Il n'y a aucune pièce réparable par l'utilisateur à l'intérieur. Il est dangereux de tenter par vous-même de réparer l'appareil; en outre, cela pourrait annuler la garantie du produit. Seuls des techniciens qualifiés peuvent réparer cet appareil.
- Pour éviter qu'elles fuient, retirez les piles de la télécommande si vous ne l'utilisez pas pendant une période prolongée ou si les piles sont épuisées.

- N'ouvrez pas les piles et ne les jetez pas au feu lorsqu'elles sont épuisées.

Sécurité physique

- N'obstruez pas les orifices de ventilation sur le panneau arrière. Vous pouvez placer le téléviseur dans un meuble, mais assurez-vous de laisser un espace de dégagement d'au moins 5 cm (2 po) tout autour.
- Ne tapez sur l'écran du téléviseur et ne le secouez pas; vous risqueriez d'endommager les circuits à l'intérieur. Prenez bien soin de la télécommande.
- Pour nettoyer le téléviseur, utilisez un chiffon doux sec. N'utilisez pas de solvants, ni de liquides à base de pétrole..
- N'installez pas l'appareil à proximité d'une source de chaleur comme un radiateur, une bouche de chaleur, une cuisinière ou d'autres appareils qui produisent de la chaleur (y compris les amplificateurs).
- Ne contournez pas le dispositif de sécurité de la fiche polarisée ou de la fiche de type mise à la terre. Une fiche polarisée comporte deux lames dont l'une est plus large que l'autre. Une fiche avec mise à la terre comporte deux lames, en plus d'une broche de masse. La lame plus large ou la broche de masse vise à assurer votre sécurité. Si la fiche fournie n'est pas compatible avec votre prise, adressez-vous à un électricien pour faire remplacer la prise, qui est probablement désuète.
- Placez le cordon d'alimentation de sorte qu'il ne risque pas d'être piétiné ou coincé, particulièrement au niveau de la fiche.
- Confiez toute réparation à un technicien qualifié. Une réparation est nécessaire si l'appareil fonctionne mal ou s'il a été endommagé d'une manière ou d'une autre (y compris le cordon d'alimentation ou la fiche).
- Une réparation est aussi nécessaire lorsqu'un liquide a été renversé sur l'appareil ou que des objets sont tombés sur celui-ci, si l'appareil a été exposé à la pluie ou à l'humidité, ou s'il est tombé.
- Raccordez toujours votre téléviseur à une prise de courant protégée par une connexion de masse.

PRÉPARATION

Éléments compris

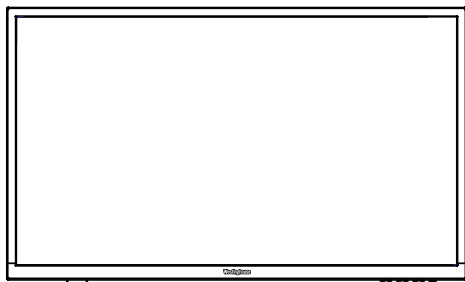

Poste de télévision

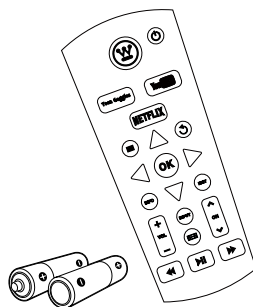

Télécommande et piles



Socle de télévision

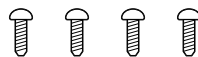

Quatre vis



Manuel d'utilisation

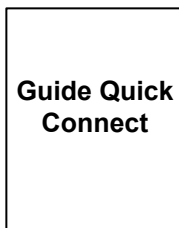

Guide Quick Connect

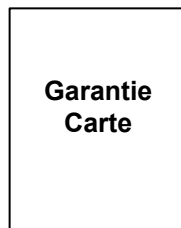

Garantie Carte

Vue avant

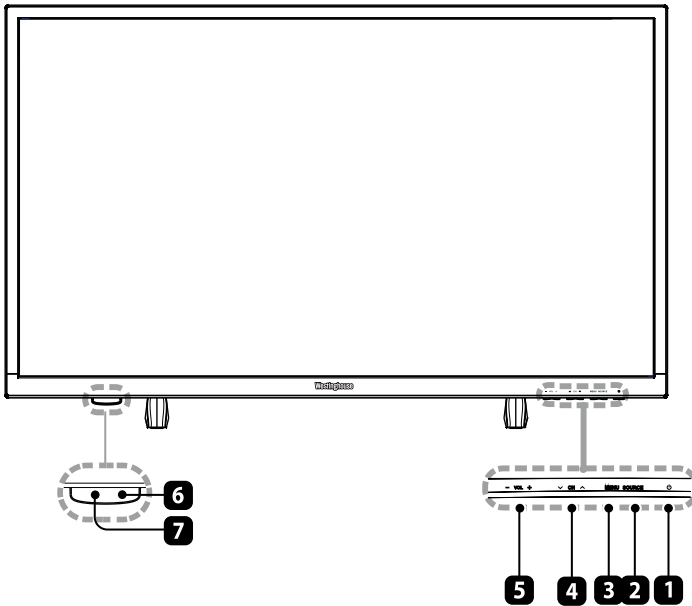

1. **MISE SOUS TENSION**
Pour faire basculer le téléviseur entre les modes Sous tension et Veille.
2. **SOURCE**
Appuyez sur cette touche pour choisir la source du signal d'entrée.
3. **MENU**
Afficher le menu principal.
4. **CH** ∇/\wedge
Appuyez sur cette touche pour choisir un canal.
5. **VOL -/+**
Appuyez sur cette touche pour régler le volume.
6. **Témoïn de mise sous tension**
Apparaît en bleu lorsque le téléviseur est allumé. Apparaît en rouge lorsque le téléviseur est en mode veille.
7. **IR** (Récepteur infrarouge)
Reçoit les signaux IR de la télécommande.

Vue arrière

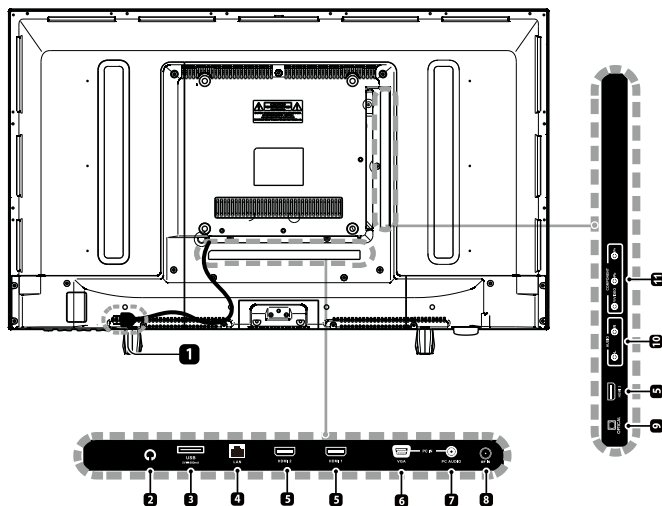

1. **Cordon d'alimentation**
Se branche dans une prise de courant c.a.
2. **Prise pour écouteurs**
Se raccorde aux écouteurs.
3. **Port USB**
Se raccorde à un dispositif de stockage USB afin de lire des fichiers de film et de photos compatibles.
4. **LAN**
Le port de connexion de réseau.
5. **Entrées HDMI**
Se raccordent à un appareil avec signal de sortie haute définition (HD).
6. **Entrée VGA**
Se raccorde à un ordinateur ou à d'autres appareils dotés d'une interface VGA.
7. **Entrée PC AUDIO**
Se raccorde à la sortie audio d'un ordinateur.
8. **Entrée DTV/TV**
Se raccorde à la prise de l'antenne (75Ω VHF/UHF) à l'aide du câble coaxial RF.
9. **OPTIQUE**
Pour connecter un système de son numérique à cette prise.
10. **Entrée Audio**
Se raccorde à la prise AUDIO (L / R) de connecteurs de sortie des appareils audio externes.
11. **COMPOSITE/COMPONENT IN**
Se raccorde aux appareils AV avec prises de sortie vidéo et audio pour composite/composants (Y/Pb/Pr). La vidéo composite/composante (Y/PB/PR) partage avec l'entrée audio (D/G).

Installation du socle

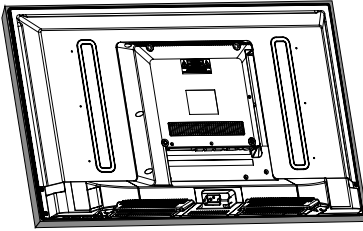

- 1. Couchez le téléviseur face vers le bas sur une surface plate et coussinée pour éviter de l'endommager ou de rayer l'écran.
- 2. Fixez le support de stand gauche à l'unité principale en utilisant les 2 vis fournies .
- 3. Fixez le support de stand droite à l'unité principale en utilisant les 2 vis fournies .

Retrait du socle en vue d'un montage mural

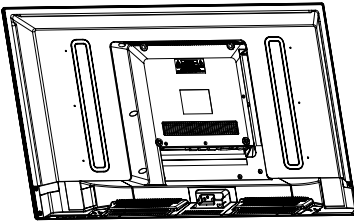

- 1. Couchez le téléviseur face vers le bas sur une surface plate et coussinée pour éviter de l'endommager ou de rayer l'écran.
- 2. Desserrez les 4 vis en tenant le socle, puis retirez-les..
- 3. Fixez le support mural au téléviseur en utilisant les trous de fixation à l'arrière du téléviseur. Installez ce téléviseur en suivant les consignes comprises avec le support mural.

MISE EN GARDE : Cet appareil doit être retenu par un support mural homologué UL.

Télécommande

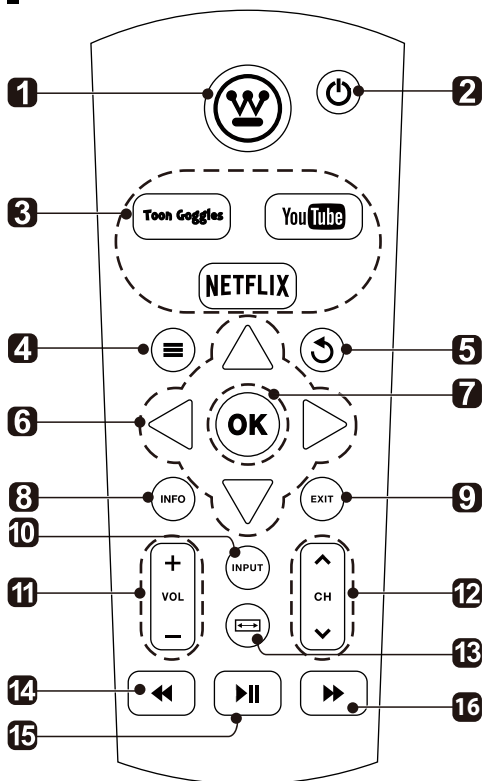

1. **HOME:** Afficher le menu d'accueil.
2. **POWER:** Tourner le téléviseur LED allumé ou éteint.
3. **APPS:** Appuyez sur pour sélectionner l'APPS désiré.
4. **≡:** Afficher le menu principal du téléviseur.
5. **↶:** Retour au bouton de menu précédent.
6. **◀▶▶▶:** Permet de naviguer dans les menus de l'OSD et de régler les paramètres système à votre préférence.
7. **OK:** Confirmez la sélection dans l'OSD (affichage à l'écran).
8. **INFO:** Affiche la source de courant d'entrée et l'information de canal.
9. **EXIT:** Quittez le menu principal du téléviseur.
10. **INPUT:** Sélectionnez Parmi les différentes sources de signal d'entrée: TV / AV / YPbPr / HDMI1 / HDMI2 / HDMI3 / VGA.
11. **VOL +/-:** Appuyez sur pour augmenter / diminuer le niveau sonore.
12. **CH^/v:** Appuyez sur pour parcourir les canaux.
13. **⊞:** Appuyez sur pour sélectionner Aspect Ratio.
14. **◀:** Pour inverser la lecture en mode rapide.
15. **⏸:** Lancer ou interrompre la lecture.
16. **▶▶:** Pour passer en mode de lecture rapide.

CONNEXION DES APPAREILS EXTERNES

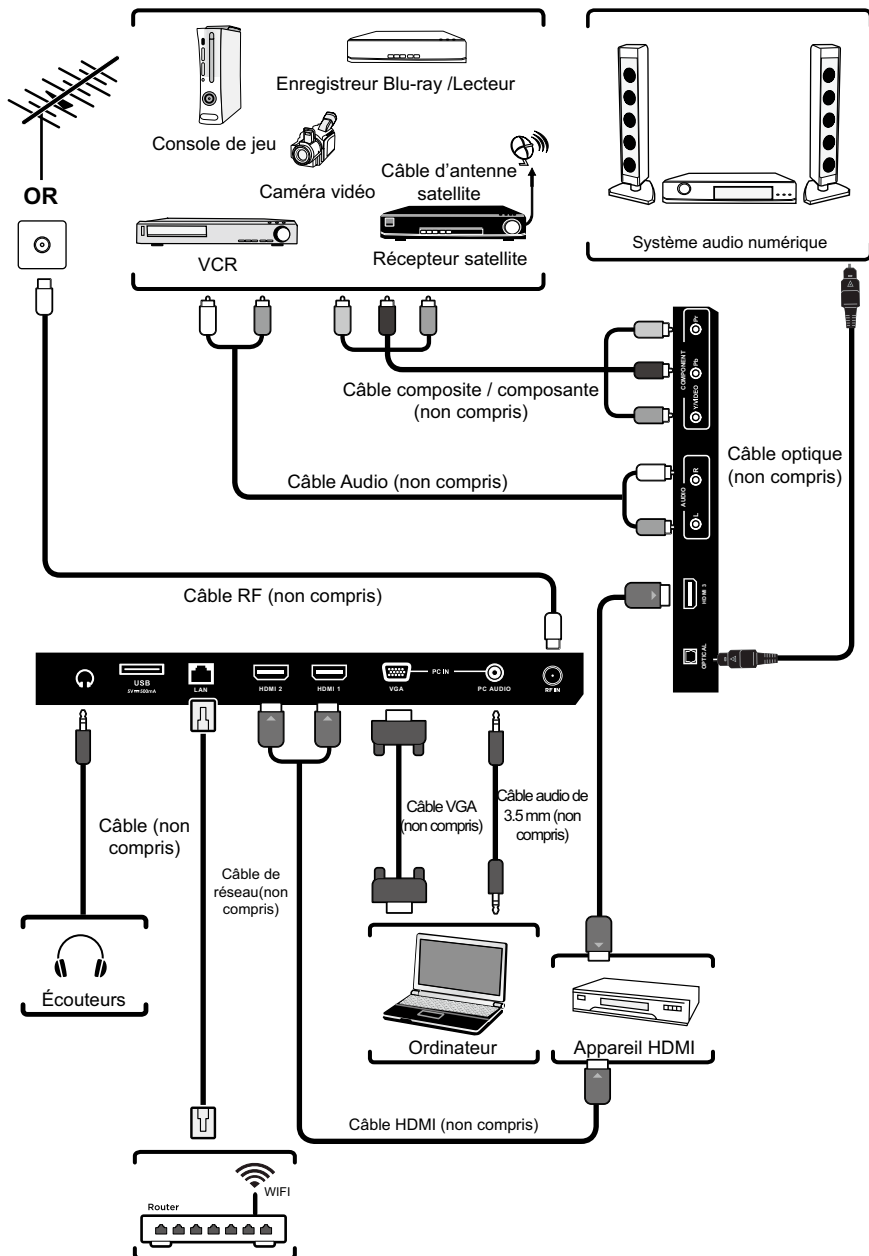

PERSONNALISATION DES PARAMÈTRES DU

Configuration initiale

- Une fois toutes les connexions physiques établies, branchez le cordon d'alimentation dans la prise de courant. À cette étape, le téléviseur passera en mode Veille et le témoin DEL rouge s'allumera.
- Une fois sous ce mode, appuyez sur la touches de l'appareil ou de la télécommande pour allumer le téléviseur. Le témoin DEL rouge passera au bleu.
- La première fois que vous allumez le téléviseur, l'assistant de configuration s'affiche. Appuyez sur les touches ▲/▼ pour sélectionner le mode désiré, puis appuyez sur **OK** pour confirmer.

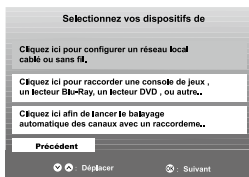
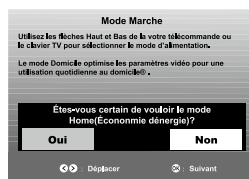
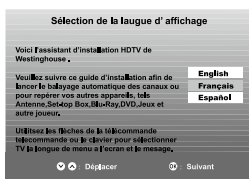

Home (économie star) constitue la configuration par défaut de la télévision au moment de la livraison. Et **Home (économie star)** est la configuration pour laquelle le produit est certifié **ENERGY STAR**. Toute modification apportée à la configuration par défaut du téléviseur entraîne des changements au niveau de la consommation d'énergie. L'activation de certaines fonctions et fonctionnalités facultatives peut augmenter la consommation d'énergie de ce produit au-delà des critères requis pour l'appellation **ENERGY STAR**.

Retail Mode : Sélectionner le mode magasin pour une image plus claire. Ce mode peut parfois consommer plus d'énergie pour utiliser le Volume/Sound Mode (mode volume/son) et le Picture Mode (mode image). Lorsque ce mode est activé, il est possible que la consommation d'énergie aille au-delà des critères requis pour l'appellation **ENERGY STAR**.

ENERGY STAR est un ensemble de directives d'économie d'énergie émis par les États-Unis de l'environnement Protection Agency (EPA).

Le programme **ENERGY STAR** est un programme de l'Agence de protection de l'environnement et du ministère de l'Énergie des États-Unis visant à fournir des directives d'économie d'énergie et à promouvoir les produits et pratiques énergétiquement efficaces.

- La consommation d'énergie du **ON-MODE (mode marche) du Home Mode (mode domicile)** devrait être inférieure à 28 W.
- La consommation d'énergie du **SLEEP-MODE (mode veille)** devrait être inférieure à 0.5 W.

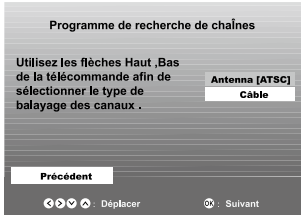

6



7

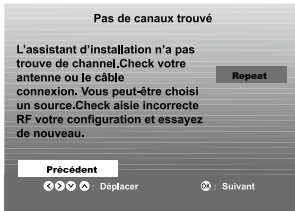

8

- *S'il est impossible de trouver des canaux, cette fenêtre s'affiche automatiquement.*

Naviguer dans les paramètres de configuration

- Appuyez sur la touche **MENU** pour afficher le menu principal.
- Utilisez les boutons ◀/▶ sélectionner le menu **SETUP**, puis appuyez sur les touches **OK** pour entrer, puis appuyez sur ◀/▶ pour naviguer et sélectionner le menu disponible.

