



KW5811

Wireless ADSL Router  
User Manual

## NOTICE

---

This document contains proprietary information protected by copyright, and this Manual and all the accompanying hardware, software, and documentation are copyrighted. All rights are reserved. No part of this document may be photocopied or reproduced by mechanical, electronic, or other means in any form.

The manufacturer does not warrant that the hardware will work properly in all environments and applications, and makes no warranty or representation, either expressed or implied, with respect to the quality, performance, merchantability, or fitness for a particular purpose of the software or documentation. The manufacturer reserves the right to make changes to the hardware, software, and documentation without obligation to notify any person or organization of the revision or change.

All brand and product names are the trademarks of their respective owners.

**© Copyright 2014**

**All rights reserved.**

## FCC Warning:

---

Any Changes or modifications not expressly approved by the party responsible for compliance could void the user's authority to operate the equipment.

This device complies with part 15 of the FCC Rules. Operation is subject to the following two conditions: (1) This device may not cause harmful interference, and (2) this device must accept any interference received, including interference that may cause undesired operation.

Note: This equipment has been tested and found to comply with the limits for a Class B digital device, pursuant to part 15 of the FCC Rules. These limits are designed to provide reasonable protection against harmful interference in a residential installation. This equipment generates, uses and can radiate radio frequency energy and, if not installed and used in accordance with the instructions, may cause harmful interference to radio communications. However, there is no guarantee that interference will not occur in a particular installation. If this equipment does cause harmful interference to radio or television reception, which can be determined by turning the equipment off and on, the user is encouraged to try to correct the interference by one or more of the following measures:

- Reorient or relocate the receiving antenna.
- Increase the separation between the equipment and receiver.
- Connect the equipment into an outlet on a circuit different from that to which the receiver is connected.
- Consult the dealer or an experienced radio/TV technician for help.

## FCC Radiation Exposure Statement:

---

This equipment complies with FCC radiation exposure limits set forth for an uncontrolled environment. This equipment should be installed and operated with minimum distance 20cm between the radiator & your body.

This transmitter must not be co-located or operating in conjunction with any other antenna or transmitter.

## Customer Information

---

1. This equipment complies with Part 68 of the FCC rules and the requirements adopted by the ACTA. On the bottom of this equipment is a label that contains, among other information, a product identifier in the format US:AAAEQ##TXXXX. If requested, this number must be provided to the telephone company.

2. A plug and jack used to connect this equipment to the premises wiring and telephone network must comply with the applicable FCC Part 68 rules and requirements adopted by the ACTA. A compliant telephone cord and modular plug is provided with this product. It is designed to be connected to a compatible modular jack that is also compliant. See installation instructions for details.

3. If this equipment [US: U5IDL01BKW5811] causes harm to the telephone network, the telephone company will notify you in advance that temporary discontinuance of service may be required. But if advance notice isn't practical, the telephone company will notify the customer as soon as possible. Also, you will be advised of your right to file a complaint with the FCC if you believe it is necessary.

4. The telephone company may make changes in its facilities, equipment, operations or procedures that could affect the operation of the equipment. If this happens the telephone company will provide advance notice in order for you to make necessary modifications to maintain uninterrupted service.

5. If trouble is experienced with this equipment [US: U5IDL01BKW5811], for repair or warranty information, Service can be facilitated through our office at:

U.S. Agent Company name:Kasda Networks Inc

Address: 5185 Cliffwood Dr.

Montclair, CA 91763

Tel: 909 628 6088

Fax: 909 628 7999

If the equipment is causing harm to the telephone network, the telephone company may request that you disconnect the equipment until the problem is resolved.

6. Please follow instructions for repairing if any (e.g. battery replacement section); otherwise do not alternate or repair any parts of device except specified. For repair procedures, follow the instructions outlined under the limited warranty.

7. Connection to party line service is subject to state tariffs. Contact the state public utility commission, public service commission or corporation commission for information.

8. If your home has specially wired alarm equipment connected to the telephone line, ensure the installation of this [US: U5IDL01BKW5811] does not disable your alarm equipment. If you have questions about what will disable alarm equipment, consult your telephone company or a qualified installer.

9. If the telephone company requests information on what equipment is connected to their lines, inform them of:

- a) The ringer equivalence number [0.1B]
- b) The USOC jack required [RJ11C]
- c) Facility Interface Codes ("FIC") [NA]
- d) Service Order Codes ("SOC") [NA]
- e) The FCC Registration Number [US: U5IDL01BKW5811]

10. The REN is used to determine the number of devices that may be connected to a telephone line. Excessive RENs on a telephone line may result in the devices not ringing in response to an incoming call. In most but not all areas, the sum of RENs should not exceed five (5.0). To be certain of the number of devices that may be connected to a line, as determined by the total RENs, contact the local telephone company. The REN for this product is part of the product identifier that has the format US:AAAEQ##TXXXX. The digits

represented by ## are the REN without a decimal point. For this product the FCC Registration number is [US: U5IDL01BKW5811] indicates the REN would be 0.1B.

11. If this product is equipped with a corded or cordless handset, it is hearing aid compatible.

# Content

<b>1 OVERVIEW</b> .....	<b>1</b>
1.1 FEATURES.....	1
1.2 PACKET CONTENTS .....	3
1.3 SYSTEM REQUIREMENTS.....	4
1.4 FACTORY DEFAULTS.....	4
1.5 WARNINGS AND CAUTIONS.....	4
<b>2 HARDWARE DESCRIPTION</b> .....	<b>5</b>
<b>3 HARDWARE INSTALLATION</b> .....	<b>7</b>
<b>4 PC CONFIGURATION GUIDE</b> .....	<b>8</b>
4.1 LOCAL PC CONFIGURATION IN WINDOWS 95, 98, ME, XP .....	8
4.2 LOCAL PC CONFIGURATION IN WINDOWS 2000 .....	8
<b>5 WEB-BASED MANAGEMENT GUIDE</b> .....	<b>9</b>
5.1 LAN SETTING PAGE .....	9
5.2 INTERNET ACCESS CONFIGURATION .....	9
5.3 WIRELESS SETTING.....	22
5.4 MANAGEMENT .....	29
<b>APPENDIX: FREQUENT ASKED QUESTIONS</b> .....	<b>33</b>



## 1 Overview

---

Thank you for choosing our product. The Starbridge 1511 Wireless ADSL Router uses Broadcom's CPE solution that fully complies with ADSL, ADSL2, ADSL2+ and IEEE802.11b/g/n standards. It will provide your SOHO with convenient Internet access.

### 1.1 Features

#### 1.1.1 Data rate

- Downstream data rate up to 24 Mbps,
- Upstream data rate up to 3.5Mbps (With AnnexM enabled)

#### 1.1.2 ADSL Compliance

- ITU G.992.1 (G.DMT)
- ITU G.992.2 (G.Lite)
- ITU G.994.1 (G.hs)
- ITU G.992.3 (G.DMT.BIS)
- ITU G.992.4 (G.lite.bis)
- ITU G.992.5
- Compatible with all T1.413 issue 2 (full rate DMT over analog POTS), and CO DSLAM equipment
- TR-069 compliant with ACS

#### 1.1.3 Wireless

- Fully IEEE 802.11b & IEEE 802.11g&IEEE 802.11n compatible.
- Wireless data rate up to 75 Mbps
- Operating in the unlicensed 2.4 GHz ISM band
- Supports 64/128 bits WEP, WPA, WPA2, WPA/WPA2-PSK, 802.1x

#### 1.1.4 Network Protocol and Features

- Ethernet to ADSL Self-Learning Transparent Bridging

- Internet Control Message Protocol (ICMP)
- IP Static Routing
- Routing Information Protocol (RIP, RIPv2)
- Network Address Translation (NAT)
- Virtual Server, Port Forwarding
- Dynamic Host Configuration Protocol (DHCP)
- DDNS
- Simple Network Time Protocol (SNTP)
- VPN pass-through (IPSec/PPTP/L2TP)
- Parent control

#### **1.1.5 ATM Capabilities**

- RFC 1483 Multi-protocol over ATM “Bridged Ethernet” compliant
- RFC 2364 PPP over ATM compliant
- RFC 2516 PPP over Ethernet compliant
- ATM Forum UNI3.1/4.0 PVC
- VPI Range: 0-255
- VCI Range: 32-65535
- UNI 3.0 & 3.1 Signaling
- ATM AAL5 (Adaption Layer type 5)
- OAM F4/F5

#### **1.1.6 FIREWALL**

- Built-in NAT
- MAC Filtering
- Packet Filtering

- Stateful Packet Inspection (SPI)
- Denial of Service Prevention (DoS)
- DMZ

#### 1.1.7 Management Support

- Web Based GUI
- Upgrade or update via FTP/HTTP
- Command Line Interface via Telnet
- Diagnostic Test
- Firmware upgrade-able for future feature enhancement

#### 1.1.8 Operating System Support

- WINDOWS 98/SE/ME/2000/XP/VISTA/7
- Macintosh
- LINUX

#### 1.1.9 Environmental

- Operating humidity: 10%-90% non-condensing
- Non-operating storage humidity: 5%-95% non-condensing

### 1.2 Packet Contents

The packet contents are as the following:

- ADSL ROUTER x 1
- External Splitter x 1
- Power Adapter x 1
- Telephone Line x 1
- Ethernet Cable x 1
- CD x 1

### 1.3 System Requirements

Before using this ROUTER, verify that you meet the following requirements:

- Subscription for ADSL service. Your ADSL service provider should provide you with at least one valid IP address (static assignment or dynamic assignment via dial-up connection).
- One or more computers, each contains an Ethernet 10/100M Base-T network interface card (NIC).
- A hub or switch, if you are connecting the device to more than one computer.
- For system configuration using the supplied web-based program: A web browser such as Internet Explorer v5.0 or later, or Netscape v4.7 or later.

### 1.4 Factory Defaults

The device is configured with the following factory defaults:







- IP Address: 192.168.1.1
- Subnet Mask: 255.255.255.0
- Encapsulation: LLC/SNAP-BRIDGING or VC/MUX
- VPI/VCI: According to local information

### 1.5 Warnings and Cautions

- Never install telephone wiring during storm. Avoid using a telephone during an electrical storm. There might be a risk of electric shock from lightening.
- Do not install telephone jacks in wet locations and never use the product near water.
- To prevent dangerous overloading of the power circuit, be careful about the designed maximum power load ratings. Not to follow the rating guideline could result in a dangerous situation.
- Please note that telephone line on modem must adopt the primary line that directly outputs from junction box. Do not connect Router to extension phone. In addition, if your house developer divides a telephone line to multi sockets inside the wall of house, please only use the telephone that has connected with the splitter of ADSL Router when you access the Internet. Under the above condition, if you also install telephone with anti-cheat-dial device, please pull out this kind of telephone, otherwise ADSL Router may occur frequently off-line.

## 2 Hardware Description

### Front Panel

	LED	Color	Function
 PWR	PWR	Orange	On: Power on Off: No power
 LAN1	LAN1,2	Orange	On: LAN link established and active via LAN port Blinking: ADSL data activity occurs Off: No LAN link via LAN port
 LAN2			
 WLAN	WLAN	Orange	On: The wireless module is ready and idle Blinking: Data transmitting or receiving over WLAN Off: The wireless function is off
 DSL	DSL	Orange	On: ADSL link established and active Quick Blinking: ADSL is trying to establish a connection Slow Blinking: No ADSL link
 INET	INET	Orange	On: IP connected Blinking: IP connected and IP traffic is passing thru the device Off: Modem power off or ADSL connection not present

## Rear panel



Port	Function
DSL	Connect the device to an ADSL telephone jack or splitter using a RJ-11 telephone cable
LAN1,2	Connect the device to user's PC's Ethernet port, or to the uplink port on user's hub/switch, using a RJ-45 cable
RESET	System reset or reset to factory defaults
PWR	Connect to the supplied power adapter
ON/OFF	Switch it on or off

### 3 Hardware Installation

This chapter shows user how to connect Router. Meanwhile, it introduces the appropriate environment for the Router and installation instructions.

1. Using a telephone line to connect the **DSL** port of ROUTER to the **Modem** port of the splitter, and using a other telephone line connect user's telephone to the **PHONE** port of the splitter, then connect the wall phone jack to the **LINE** port of the splitter.

The splitter comes with three connectors as below:

**LINE:** Connects to a wall phone jack (RJ-11 jack)

**ROUTER:** Connects to the DSL jack of ROUTER

**PHONE:** Connects to a telephone set

2. Using an Ethernet Cable to connect the LAN port of the ROUTER to user's LAN or a PC with network card installed.
3. Connect the power cable to the POWER connector on ROUTER, then plug in the power adapter to the power outlet, and then press the on-off button.

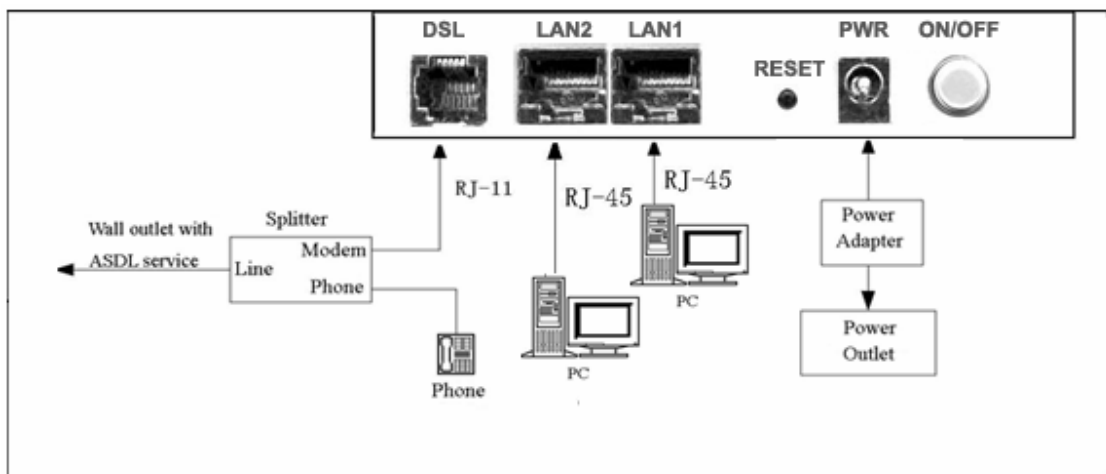

**Notes:** Without the splitter and certain situation, transient noise from telephone can interfere with the operation of the Router, and the Router may introduce noise to the telephone line. To prevent this from happening, a small external splitter must be connected to each telephone.

## 4 PC Configuration Guide

---

### 4.1 Local PC Configuration in Windows 95, 98, ME, XP

1. In the Windows task bar, click the “Start” button, point to “Settings”, and then click “Control Panel”.
2. Double-click the “Network” icon.
3. On the “Configuration” tab, select the TCP/IP network associated with user’s network card and then click “Properties”.
4. In the “TCP/IP Properties” dialog box, click the “IP Address” tab. Set the IP address as 192.168.1.x (x can be a decimal number from 2 to 254.) like 192.168.1.2, and the subnet mask as 255.255.255.0.
5. On the “Gateway” tab, set a new gateway as 192.168.1.1, and then click “Add”.
6. Configure the “DNS” tab if necessary. For information on the IP address of the DNS server, please consult with user’s ISP.
7. Click “OK” twice to confirm and save user’s changes.
8. User will be prompted to restart Windows. Click “Yes”.

### 4.2 Local PC Configuration in Windows 2000

1. In the Windows task bar, click the “Start” button, point to “Settings”, and then click “Control Panel”.
2. Double-click the “Network and Dial-up Connections” icon.
3. In the “Network and Dial-up Connections” window, right-click the “Local Area Connection” icon, and then select “Properties”.
4. Highlight “Internet Protocol (TCP/IP)”, and then click “Properties”.
5. In the “Internet Protocol (TCP/IP) Properties” dialog box, set the IP address as 192.168.1.x (x can be a decimal number from 2 to 254.), and the subnet mask as 255.255.255.0 and the default gateway as 192.168.1.1. Then click “OK”.
6. Configure the “DNS” tab if necessary. For information on the IP address of the DNS server, please consult with user’s ISP.
7. Click “OK” twice to confirm and save user’s changes.



## 5 Web-based Management Guide

In order to use the web-based management software it will be necessary to use a computer that occupies the same subnet as the Router. The simplest way to do this for many users will be to use DHCP server that is enabled by default on the Router.

### 5.1 LAN setting page

Launch a web browser, such as Internet Explorer, and then use <http://192.168.1.1> to log on to the setting pages.

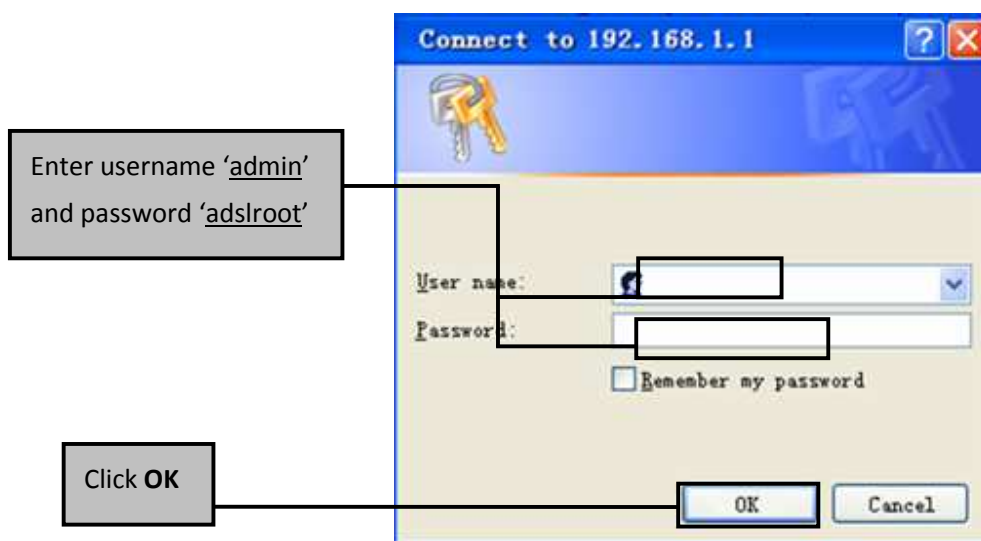

After user log in to the modem, the general status page appears.

### 5.2 Internet Access Configuration

The setup wizard will guide you to configure the DSL router to access Internet via PPPoE type.

#### 5.2.1 ADSL Setup

From home page, you can find **Advanced Setup** option on the left router configuration page.

1. From **Layer2 Interface**, click **ATM Interface**. you can set it up according to the following steps. You Choose **Add**, or **Remove** to configure DSL ATM interfaces.

Interface	Vpi	Vci	DSL Latency	Category	Link Type	Connection Mode	IP QoS	Scheduler Alg	Queue Weight	Group Precedence	Remove
<div style="display: flex; justify-content: center; gap: 10px;"> <span>Add</span> <span>Remove</span> </div>											

- Click **Add** to configure PVC identifier, select DSL latency and select connection mode according to your local occasion. After the configuration, you need to click **Apply/Save**.

VPI: [0-255]

VCI: [32-65535]

Select DSL Latency

Path0

Path1

Select DSL Link Type (EoA is for PPPoE, IPoE, and Bridge.)

EoA

PPPoA

IPoA

Select Connection Mode

Default Mode - Single service over one connection

VLAN MUX Mode - Multiple Vlan service over one connection

Encapsulation Mode:

Service Category:

- Click **WAN Service** from **Advanced Setup**.

Interface	Description	Type	Vlan8021p	VlanMuxId	Igmp	NAT	Firewall	Remove	Edit
-----------	-------------	------	-----------	-----------	------	-----	----------	--------	------

- Click **Add** to select a layer 2 interface for this service and then click **Next**.

### WAN Service Interface Configuration

Select a layer 2 interface for this service

Note: For ATM interface, the descriptor string is (portId\_vpi\_vci)

For PTM interface, the descriptor string is (portId\_high\_low)

Where portId=0 --> DSL Latency PATH0

portId=1 --> DSL Latency PATH1

portId=4 --> DSL Latency PATH0&1

low =0 --> Low PTM Priority not set

low =1 --> Low PTM Priority set

high =0 --> High PTM Priority not set

high =1 --> High PTM Priority set

atm0/(0\_0\_35) ▼

Back Next

5. Choose WAN service type, just choose PPPoE for example here. You can enter your own service description here if you want and then click **Next**.

### WAN Service Configuration

Select WAN service type:

- PPP over Ethernet (PPPoE)
- IP over Ethernet
- Bridging

Enter Service Description:

Back Next

6. Input **PPP Username & PPP Password** and then click **Next**. The user interface allows a maximum of 256 characters in the user name and a maximum of 32 characters in the password.

PPP Username:	<input type="text"/>
PPP Password:	<input type="password"/>
PPPoE Service Name:	<input type="text"/>
Authentication Method:	<input type="text" value="AUTO"/>
MTU [88-1492] :	<input type="text" value="1492"/>
<input type="checkbox"/>	Enable Fullcone NAT
<input type="checkbox"/>	Enable NAT
<input type="checkbox"/>	Enable Firewall
<input type="checkbox"/>	Dial on demand (with idle timeout timer)
<input type="checkbox"/>	PPP IP extension
<input type="checkbox"/>	Use Static IPv4 Address
<input type="checkbox"/>	Enable PPP Debug Mode
<input type="checkbox"/>	Bridge PPPoE Frames Between WAN and Local Ports
<b>Multicast Proxy</b>	
<input type="checkbox"/>	Enable IGMP Multicast Proxy

**PPPoE service name** can be blank unless your Internet Service Provider gives you a value to enter.

**Authentication method** is default to **Auto**. It is recommended that you leave the **Authentication method** in **Auto**, however, you may select **PAP** or **CHAP** if necessary. The default value for MTU (Maximum Transmission Unit) is **1500** for PPPoA and **1492** for PPPoE. Do not change these values unless your ISP asks you to.

**Enable FullCone NAT**, all requests from the same private IP address and port are mapped to the same public source IP address and port. Someone on the Internet only needs to know the mapping scheme in order to send packets to a device behind the ADSL router.

The gateway can be configured to disconnect if there is no activity for a specific period of time by selecting the **Dial on demand** check box and entering the **Inactivity timeout**. The entered value must be between 1 minute and 4320 minutes.

The **PPP IP Extension** is a special feature deployed by some service providers. Unless your service provider specifically requires this setup, do not select it. If you need to select it, the PPP IP Extension supports the following conditions:

- It allows only one computer on the LAN.
- The public IP address assigned by the remote using the PPP/IPCP protocol is actually not used on the WAN PPP interface. Instead, it is forwarded to the computer's LAN interface through DHCP. Only one system on the LAN can be connected to the remote, since the DHCP server within the ADSL gateway has only a single IP address to assign to a LAN device.
- NAPT and firewall are disabled when this option is selected.
- The gateway becomes the default gateway and DNS server to the computer through DHCP using the LAN interface IP address.
- The gateway extends the IP subnet at the remote service provider to the LAN computer. That is, the PC becomes a host belonging to the same IP subnet.
- The ADSL gateway bridges the IP packets between WAN and LAN ports, unless the packet is addressed to the gateway's LAN IP address.

**Use static IPv4 IP address**, If the ISP gave you a static IP address, select this option and enter it in the IP address field.

**Bridge PPPoE Frames Between WAN and Local Ports** is available when you do not use **PPP IP extension**. If you enable this function, LAN hosts can use PPPoE client software on their computers to connect to the ISP. Each host can have a separate account and a public WAN IP address.

7. Select a preferred wan interface as the system default gateway.

### Selected Default Gateway Interfaces

ppp0



### Available Routed WAN Interfaces

8. Get DNS server information from the selected WAN interface or enter static DNS server IP addresses. If only a single PVC with IPoA or static MER protocol is configured, you must enter static DNS server IP addresses.

Select DNS Server Interface from available WAN interfaces:

Selected DNS Server Interfaces

Available WAN Interfaces

ppp0



Use the following Static DNS IP address:

Primary DNS server:

Secondary DNS server:

9. Make sure that the settings below match the settings provided by your ISP. Click on the **Apply/Save** button to save your configurations.

<b>Connection Type:</b>	PPPoE
<b>NAT:</b>	Enabled
<b>Full Cone NAT:</b>	Disabled
<b>Firewall:</b>	Enabled
<b>IGMP Multicast:</b>	Disabled
<b>Quality Of Service:</b>	Enabled

### 5.2.2 Router Mode Setup

- From **Advanced Setup**, click **Layer2 Interface** and select **ETH Interface**. Before you configure ETH WAN interface, you'd better remove all PVC settings from **ATM interface**.

Interface/(Name)	Connection Mode	Remove

- Click **Add** and you'll see the following screen.

Select a ETH port:

eth0/ENET1 ▼

**Select Connection Mode**

Default Mode - Single service over one connection  
 VLAN MUX Mode - Multiple Vlan service over one connection

- Select a ETH port as you will. You can select ENET1 or ENET2 port as the WAN interface and Default Mode as connection mode.

eth1/ENET2 ▼

**Select Connection Mode**

Default Mode - Single service over one connection  
 VLAN MUX Mode - Multiple Vlan service over one connection

- Click **Apply/Save** and you'll see the following screen.

Interface/(Name)	Connection Mode	Remove
eth1/ENET2	DefaultMode	<input type="checkbox"/>

- From **Advanced Setup**, click **WAN Service** to configure a WAN service over the interface you selected.

Interface	Description	Type	Vlan8021p	VlanMuxId	Igmp	NAT	Firewall	Remove	Edit
-----------	-------------	------	-----------	-----------	------	-----	----------	--------	------

6. Click **Add** and you'll see the following screen.

### WAN Service Interface Configuration

Select a layer 2 interface for this service

Note: For ATM interface, the descriptor string is (portId\_vpi\_vci)

For PTM interface, the descriptor string is (portId\_high\_low)

Where portId=0 --> DSL Latency PATH0

portId=1 --> DSL Latency PATH1

portId=4 --> DSL Latency PATH0&1

low =0 --> Low PTM Priority not set

low =1 --> Low PTM Priority set

high =0 --> High PTM Priority not set

high =1 --> High PTM Priority set

eth1/ENET2 ▼

7. Click **Next** and you'll see the following screen. Select PPPoE as WAN service type for example. Click **Next**.

### WAN Service Configuration

Select WAN service type:

PPP over Ethernet (PPPoE)

IP over Ethernet

Enter Service Description:



8. Enter the user name and password that your ISP has provided to you. Click **Next**.

PPP Username:	<input type="text"/>
PPP Password:	<input type="password"/>
PPPoE Service Name:	<input type="text"/>
Authentication Method:	<input type="text" value="AUTO"/>
MTU [88-1492] :	<input type="text" value="1492"/>
<input type="checkbox"/>	Enable Fullcone NAT
<input type="checkbox"/>	Enable NAT
<input type="checkbox"/>	Enable Firewall
<input type="checkbox"/>	Dial on demand (with idle timeout timer)
<input type="checkbox"/>	PPP IP extension
<input type="checkbox"/>	Use Static IPv4 Address
<input type="checkbox"/>	Enable PPP Debug Mode
<input type="checkbox"/>	Bridge PPPoE Frames Between WAN and Local Ports
<b>Multicast Proxy</b>	
<input type="checkbox"/>	Enable IGMP Multicast Proxy

**PPPoE service name** can be blank unless your Internet Service Provider gives you a value to enter.

**Authentication method** is default to **Auto**. It is recommended that you leave the **Authentication method** in **Auto**, however, you may select **PAP** or **CHAP** if necessary.

The default value for MTU (Maximum Transmission Unit) is **1500** for PPPoA and **1492** for PPPoE. Do not change these values unless your ISP asks you to.

The gateway can be configured to disconnect if there is no activity for a specific period of time by selecting the **Dial on demand** check box and entering the **Inactivity timeout**. The entered value must be between 1 minute and 4320 minutes.

The **PPP IP Extension** is a special feature deployed by some service providers. Unless your service provider specifically requires this setup, do not select it. If you need to select it, the PPP IP Extension supports the following conditions:

- It allows only one computer on the LAN.
- The public IP address assigned by the remote using the PPP/IPCP protocol is actually not used on the WAN PPP interface. Instead, it is forwarded to the computer's LAN interface through DHCP. Only one system on the LAN can be connected to the remote, since the DHCP server within the ADSL gateway has only a single IP address to assign to a LAN device.
- NAPT and firewall are disabled when this option is selected.
- The gateway becomes the default gateway and DNS server to the computer through DHCP using the LAN interface IP address.
- The gateway extends the IP subnet at the remote service provider to the LAN computer. That is, the PC becomes a host belonging to the same IP subnet.
- The ADSL gateway bridges the IP packets between WAN and LAN ports, unless the packet is addressed to the gateway's LAN IP address.

9. Select WAN interface as the system default gateway. Click **Next**.

Selected Default Gateway Interfaces		Available Routed WAN Interfaces
ppp0	<input type="button" value="-&gt;"/> <input type="button" value="&lt;-"/>	

10. Get DNS server information from the selected WAN interface or enter static DNS server IP addresses. Click **Next**.

**Select DNS Server Interface from available WAN interfaces:**

Selected DNS Server Interfaces		Available WAN Interfaces
ppp0	<input type="button" value="-&gt;"/> <input type="button" value="&lt;-"/>	

**Use the following Static DNS IP address:**

Primary DNS server:

Secondary DNS server:

11. Make sure that the settings below match the settings provided by your ISP. Click on the **Apply/Save** button to save your configurations and reboot the ADSL router.

<b>Connection Type:</b>	PPPoE
<b>NAT:</b>	Enabled
<b>Full Cone NAT:</b>	Disabled
<b>Firewall:</b>	Enabled
<b>IGMP Multicast:</b>	Disabled
<b>Quality Of Service:</b>	Enabled

### 5.2.3 LAN Settings

From **LAN**, Configure the DSL Router's IP Address and Subnet Mask for LAN interface. In this page, you can use DHCP (Dynamic Host Configuration Protocol) to control the assignment of IP addresses on your local network (LAN only).

Configure the Broadband Router IP Address and Subnet Mask for LAN interface. GroupName Default ▼

IP Address:   
 Subnet Mask:

Enable IGMP Snooping

Enable LAN side firewall

Disable DHCP Server

Enable DHCP Server

Start IP Address:

End IP Address:

Leased Time (hour):

Static IP Lease List: (A maximum 32 entries can be configured)

MAC Address	IP Address	Remove
<div style="display: flex; justify-content: space-around; margin-top: 5px;"> <span style="border: 1px solid black; padding: 2px 10px;">Add Entries</span> <span style="border: 1px solid black; padding: 2px 10px;">Remove Entries</span> </div>		

Enable DHCP Server Relay

DHCP Server IP Address:

Configure the second IP Address and Subnet Mask for LAN interface

IP Address:

Subnet Mask:

Item	Description
<b>IP address</b>	This is the IP address that other devices on your local network will use to connect to the modem.
<b>Subnet mask</b>	This defines the size of your network. The default is <b>255.255.255.0</b> .

<b>Enable IGMP snooping</b>	<p>IGMP Snooping is a method that actually “snoops” or inspects IGMP traffic on a switch. When enabled, the switch will watch for IGMP messages passed between a host and a router, and will add the necessary ports to its multicast table, ensuring that only the ports that require a given multicast stream actually receive it.</p> <p>Use standard mode to flood unknown multicast traffic.</p> <p>Use blocking mode to discard unknown multicast traffic.</p>
<b>Disable / Enable DHCP server</b>	<p>The DHCP server assigns an IP addresses from a pre-set pool of addresses upon request from DHCP client (e.g. your computer). Do not disable the DHCP server unless you wish to let another device handle IP address issuance on the local network.</p>
<b>Start / end IP address</b>	<p>This is the beginning and ending range for the DHCP server addresses.</p>
<b>Leased time</b>	<p>The amount of time before the IP address is refreshed by the DHCP server.</p>
<b>Configure the second IP address and...</b>	<p>Select this option to let the device use a second IP address on the LAN interface. You can also use this second IP address to access the device for management. Enter the LAN IP address of your device in dotted decimal notation, for example, 10.0.0.1. Type the subnet mask.</p>

**Note: If you want to cancel all modification that you do on the Router, please select from “Management⇒Setting⇒Restore Default Settings” to restore factory default settings.**

## 5.3 Wireless setting

### 5.3.1 Basic

- Enable Wireless
- Hide Access Point
- Clients Isolation
- Disable WMM Advertise
- Enable Wireless Multicast Forwarding (WMMF)

SSID:

BSSID: 00:0E:F4:E1:3F:E2

Country:

Max Clients:

Option	Description
<b>Enable wireless</b>	A check box that enables or disables the wireless LAN interfaces. The default is to enable wireless communications.
<b>Hide Access Point</b>	<p>Select Hide Access Point to protect the ADSL route access point from detection by wireless active scans. If you do not want the access point to be automatically detected by a wireless station, this checkbox should be deselected.</p> <p>The station will not discover this access point. To connect a station to the access point, the station must manually add this access point name in it's wireless configuration.</p> <p>In Windows XP, go to the Network&gt;Properties function to view all of the available access points. You can also use other software programs such as NetStumbler to view available access points.</p>
<b>Clients isolation</b>	Enable this item if you don't want your wireless clients to communicate with each other.
<b>Network name (SSID)</b>	<p>Enter a name for user's wireless network here. SSID stands for Service Set Identifier. This name must be between 1 and 32 characters long. The default name is <b>WLAN</b>.</p> <p>All wireless clients must either detect the gateway or be configured with the correct SSID to access the Internet.</p>

<b>BSSID</b>	Displays the gateway's wireless MAC address. (User may need this address if user is using WDS or multiple gateways.) Click <b>Apply</b> to save changes.
<b>Country</b>	Drop-down menu that allows selection of specific channel.

### 5.3.2 Advanced Settings

This page is where user specifies a number of advanced settings for wireless communications.

Band:	2.4GHz ▾	
Channel:	Auto ▾	Current: 6 (interference: severe)
Auto Channel Timer(min)	<input type="text" value="0"/>	
802.11n/EWC:	Auto ▾	
Bandwidth:	20MHz in 2.4G Band and 40MHz in 5G Band ▾	Current: 20MHz
Control Sideband:	Lower ▾	Current: None
802.11n Rate:	Auto ▾	
802.11n Protection:	Auto ▾	
Support 802.11n Client Only:	Off ▾	
RIFS Advertisement:	Off ▾	
OBSS Co-Existence:	Enable ▾	
RX Chain Power Save:	Disable ▾	
RX Chain Power Save Quiet Time:	<input type="text" value="10"/>	
RX Chain Power Save PPS:	<input type="text" value="10"/>	
54g™ Rate:	1 Mbps ▾	
Multicast Rate:	Auto ▾	
Basic Rate:	Default ▾	
Fragmentation Threshold:	<input type="text" value="2346"/>	
RTS Threshold:	<input type="text" value="2347"/>	
DTIM Interval:	<input type="text" value="1"/>	
Beacon Interval:	<input type="text" value="100"/>	
Global Max Clients:	<input type="text" value="16"/>	
XPress™ Technology:	Disabled ▾	
Transmit Power:	100% ▾	
WMM(Wi-Fi Multimedia):	Enabled ▾	
WMM No Acknowledgement:	Disabled ▾	
WMM APSD:	Enabled ▾	

**Note:** After making any changes, click **Apply** to save.

**Warning:** The settings shown above are default settings. Changes made to these items can cause wireless communication problems.

Field	Description
<b>Band</b>	This is the range of frequencies the gateway will use to communicate with user's wireless devices.
<b>Channel</b>	Drop-down menu that allows selection of specific channel.
<b>54g™ Rate</b>	This drop-down list lets user specify the wireless communication rate, which can be <b>Auto</b> (uses the highest rate when possible, or else a lower rate) or a fixed rate between 1 and 54 Mbps.
<b>Multicast rate</b>	This drop-down list lets user specify the wireless communication rate for multicast packets, which are sent to more than one destination at a time. The value can be <b>Auto</b> (uses the highest rate when possible, or else a lower rate) or a fixed rate between 1 and 54 Mbps.
<b>Basic rate</b>	User has the option of supporting all rates listed in <b>Rate</b> above or using the 1-, 2-Mbps rates, which support only older 802.11b implementations.
<b>Fragmentation threshold</b>	<p>A threshold, specified in bytes, that determines whether packets will be fragmented and at what size. On an 802.11 connection, packets that are larger than the fragmentation threshold are split into smaller units suitable for the circuit size. Packets smaller than the specified fragmentation threshold value are not fragmented.</p> <p>Enter a value between <b>256</b> and <b>2346</b>. If user experience a high packet error rate, try to increase this value slightly. Setting the fragmentation threshold too low may result in poor performance.</p>
<b>RTS threshold</b>	This is number of bytes in the packet size beyond which the gateway invokes its RTS/CTS (request to send, clear to send) mechanism. Packets larger than this threshold trigger the RTS/CTS mechanism, while the gateway transmits smaller packets without using RTS/CTS. The default setting of <b>2347</b> , which is the maximum, disables the RTS threshold mechanism.



<b>DTIM interval</b>	A delivery traffic indication message (DTIM), also known as a beacon, is a countdown informing wireless clients of the next window for listening to broadcast and multicast messages. When the gateway has broadcast or multicast messages for its clients, it sends its next DTIM message with this DTIM interval value. The clients hear the beacons and awaken as needed to receive the broadcast and multicast messages.
<b>Beacon interval</b>	The amount of time (in milliseconds) between beacon transmissions, each of which identifies the presence of an access point. By default, wireless clients passively scan all radio channels, listening for beacons coming from access points. Before a client enters power-save mode, it needs the beacon interval to determine when to wake up for the next beacon (and learn whether the access point has any messages for it). User can enter any value between <b>1</b> and <b>65535</b> , but the recommended range is <b>1 - 1000</b> .
<b>XPress™ Technology</b>	<p><b>XPress™ Technology</b> is a feature in which two of our devices can communicate with each other at twice the normal rate.</p> <p>54g+ is a technology that achieves higher throughput with frame-bursting. With 54g+ enabled, aggregate throughput (the sum of the individual throughput of each network client) improves by up to 25% in 802.11g-only networks, and up to 75% in mixed networks containing both 802.11g and 802.11b equipment.</p>

### 5.3.3 Security

This page allows you to configure security features of the wireless LAN interface. You may set up configuration manually or through WiFi Protected Setup(WPS)

1. Click **Security** of **Wireless** item and you'll see the following page.

**WPS Setup**

Enable WPS

**Manual Setup AP**

You can set the network authentication method, selecting data encryption, specify whether a network key is required to authenticate to this wireless network and specify the encryption strength. Click "Apply/Save" when done.

Select SSID:

Network Authentication:

WEP Encryption:

2. Configure WPA Pre-shared key as below and click **Apply/Save**.

**WPS Setup**

Enable WPS

**Manual Setup AP**

You can set the network authentication method, selecting data encryption, specify whether a network key is required to authenticate to this wireless network and specify the encryption strength. Click "Apply/Save" when done.

Select SSID:

Network Authentication:

WPA/WAPI passphrase:  [Click here to display](#)

WPA Group Rekey Interval:

WPA/WAPI Encryption:

WEP Encryption:

3. Enable WPS as below.

Enable **WPS**

Add **Client** (This feature is available only when WPA-PSK, WPA2 PSK or OPEN mode is configured)  
 Push-Button  PIN   
  
[Help](#)

Set **WPS AP Mode**

Setup **AP** (Configure all security settings with an external registrar)  
 Push-Button  PIN

**Device PIN**  [Help](#)

4. Set WPS AP mode as **Unconfigured** and click **Config AP**.

Enable **WPS**

Add **Client** (This feature is available only when WPA-PSK, WPA2 PSK or OPEN mode is configured)  
 Push-Button  PIN   
  
[Help](#)

Set **WPS AP Mode**

Setup **AP** (Configure all security settings with an external registrar)  
 Push-Button  PIN

**Device PIN**  [Help](#)

5. Set WPS AP mode as **configured** and click **Save/Apply**.

6. Now you can use a wireless adaptor with WPS function and the WPS button to connect to access the Internet.

7. To configure security features for the Wireless interface, please open Security item from Wireless menu. This web page offers nine authentication protocols for user to secure user's data while connecting to networks. There are four selections including Open, Shared, 802.1X, WPA, WPA-PSK, WPA2, WPA2-PSK, Mixed WPA-WPA2, Mixed WPA-WPA2-PSK. Different item leads different web page settings. Please read the

following information carefully.

The wireless security page allows user to configure the security features of user's wireless network.

Select SSID:	WLAN
Network Authentication:	Open
WEP Encryption:	Enabled
Encryption Strength:	128-bit
Current Network Key:	1
Network Key 1:	1234567890123
Network Key 2:	1234567890123
Network Key 3:	1234567890123
Network Key 4:	1234567890123

There are several security methods to choose from, depending on user's needs and the capabilities of user's wireless machines.

- **WEP open** and **WEP shared** —WEP is an encryption scheme that is used to protect user's wireless data communications. WEP uses a combination of 64-bit keys or 128-bit keys to provide access control to user's network and encryption security for every data transmission. To decode a data transmission, each wireless client on the network must use an identical 64-bit or 128-bit key. WEP is an older wireless encryption method that is not as hard to break as the more-recent WPA.
- **802.1x** — In 802.1x (also known as RADIUS), a separate machine called an authentication server receives a user ID and password. It grants or denies access based on whether the ID and password match any entries in its account list. User can optionally enable WEP encryption with this option. Because it requires a separate machine acting as the authentication server, 802.1x is most often used in business environments.
- **WPA** — WPA is a more recent encryption method that addresses many of the

weaknesses in WEP. Any client capable of WPA encryption should use it instead of WEP.

- **WPA (PSK)** — This is WPA encryption combined with a *pre-shared key (PSK)*, which is a text string known only to the gateway and authorized wireless clients. The gateway rejects the login if the client's PSK does not match.
- **WPA2** — WPA2 is a more advanced encryption method than WPA. Because it is a more recent standard, some of user's wireless devices might not be able to use it.
- **WPA2 (PSK)** — This option uses WPA2 with a pre-shared key.
- **WPA2 and WPA** — This option supports WPA2/WPA encryption for devices capable of one or the other standard. The gateway automatically detects whether a particular device can use WPA2 or WPA.
- **WPA2 AND WPA (PSK)** — This has WPA2 or WPA encryption based on client abilities, as well as a pre-shared key.

After making changes, click **Apply** to save.

## 5.4 Management

### 5.4.1 Remote Access

When the firewall is enabled on a WAN or LAN interface, all incoming IP traffic is **BLOCKED**. However, some IP traffic can be **ACCEPTED** by setting up filters.

1. Select Advanced Setup=>Security=>IP Filtering=>Incoming and Choose Add or Remove to configure incoming IP filters.

Filter Name	IP Version	Protocol	SrcIP/ PrefixLength	SrcPort	DstIP/ PrefixLength	DstPort	Remove
<input type="button" value="Add"/> <input type="button" value="Remove"/>							

2. Click Add to add rules. If you want to do remote ping test, please select protocol as ICMP; If you want to do Http or Telnet test, please select protocol as TCP/UDP. If you want only Http remote access, you can set destination port as 80; If you want only Telnet remote access, you can set destination port as 23; If you want both, you can set destination port as blank.

Filter Name:

IP Version:

Protocol:

Source IP address[/prefix length]:

Source Port (port or port:port):

Destination IP address[/prefix length]:

Destination Port (port or port:port):

3. Click Apply/Save and select Device Info=>WAN. You can see the IP address of WAN interface

Interface	Description	Type	VlanMuxId	Igmp	NAT	Firewall	Status	IPv4 Address
atm0	ipoe_0_1_35	IPoE	Disabled	Disabled	Disabled	Disabled	Connecting	0.0.0.0

4. Now you can access the ADSL router remotely using username **support** and password **support**. You can input <http://x.x.x.x/> for Http and input telnet x.x.x.x for Telnet.

#### 5.4.2 TR-069 Client

WAN Management Protocol (TR-069) allows a Auto-Configuration Server (ACS) to perform auto-configuration, provision, collection, and diagnostics to this device.

Inform	<input checked="" type="radio"/> Disable <input type="radio"/> Enable
Inform Interval:	<input type="text" value="300"/>
ACS URL:	<input type="text"/>
ACS User Name:	<input type="text" value="admin"/>
ACS Password:	<input type="password" value="•••••"/>
WAN Interface used by TR-069 client:	<input type="text" value="Any_WAN"/> ▼
Display SOAP messages on serial console	<input checked="" type="radio"/> Disable <input type="radio"/> Enable
<input checked="" type="checkbox"/> Connection Request Authentication	
Connection Request User Name:	<input type="text" value="admin"/>
Connection Request Password:	<input type="password" value="•••••"/>
Connection Request URL:	<input type="text"/>
<input type="button" value="Apply/Save"/> <input type="button" value="GetRPCMethods"/>	

**Inform:** Whether or not the CPE must periodically send CPE information to Server using the Inform method call.

**Inform Interval:** The duration in seconds of the interval for which the CPE MUST attempt to connect with the ACS and call the Inform method if Inform is enabled.

**ACS URL:** URL for the CPE to connect to the ACS using the CPE WAN Management Protocol.

**ACS User Name:** Username used to authenticate an ACS making a Connection Request to the CPE.

**ACS Password:** Password used to authenticate an ACS making a Connection Request to the CPE. When read, this parameter returns an empty string, regardless of the actual value.

**WAN Interface used by TR-069 client:** Remember to choose the interface of PVC used for TR069

**Connection Request User Name:** Username used to authenticate the CPE when making a connection to the ACS using the CPE WAN Management Protocol. This username is used only for authentication of the CPE.

**Connection Request Password:** Password used to authenticate the CPE when making a connection to the ACS using the CPE WAN Management Protocol. This password is used only for authentication of the CPE.

**GetRPCMethods:** Used by a CPE or ACS to discover the set of methods supported by the ACS or CPE it is in communicate with.

### 5.4.3 SNMP Agent

SNMP (Simple Network Management Protocol) has been widely applied in the computer networks currently, which is used for ensuring the transmission of the management information between any two nodes. In this way, network administrators can easily search and modify the information on any node on the network. Meanwhile, they can locate faults promptly and implement the fault diagnosis, capacity planning and report generating.

An SNMP Agent is an application running on the Router that performs the operational role of receiving and processing SNMP messages, sending responses to the SNMP manager, and sending traps when an event occurs. So a Router contains SNMP "agent" software can be monitored and/or controlled by SNMP Manager using SNMP messages.

SNMP Agent  Disable  Enable

Read Community:	<input type="text" value="public"/>
Set Community:	<input type="text" value="private"/>
System Name:	<input type="text" value="Broadcom"/>
System Location:	<input type="text" value="unknown"/>
System Contact:	<input type="text" value="unknown"/>
Trap Manager IP:	<input type="text" value="0.0.0.0"/>

**SNMP Agent:** You can select the checkbox to disable or enable the function.

Note:

SNMP Community string provides a simple method of authentication between the Router (SNMP Agent) and a remote network manager (SNMP Manager). You can specify the community string as the password to authenticate the management station to the Router.



**Read Community:** This field allows you to specify the SNMP Community string which provides read-only access to the Router that the community is only permitted to read the device configuration. The default value is "public".

**Set Community:** This field allows you to specify the SNMP Community string which provides read and write access to the Router that the community has the authority to read and change the device configuration. The default value is "public".

**System Name:** Enter alphanumeric string to specify an SNMP community string name. Your Router (SNMP agents) will expose management data on the managed systems as this "system name".

**System Location:** The person to notify when problems occur.

**System contact:** The location of the person that is identified as the system contact.

**Trap Manager IP:** Enter the IP address of the SNMP Manager, where the SNMP Agent forwards trap notifications.

Select the desired values and click **Save/Apply** to configure the SNMP options.

## Appendix: Frequent Asked Questions

Q: None of the LEDs are on when user power on the ADSL router?

A: Please make sure what user use is the power adaptor attached with the ADSL router package, and check the connection between the AC power and ADSL router.

Q: DSL LED does not turn on after connect telephone line?

A: Please make sure what user use is the standard telephone line (as attached with the package), make sure the line is connected correctly and check whether there is poor contact at each interface. Wait for 30 seconds to allow the ADSL router establishes connection with user ADSL operator.

Q: DSL LED is in the circulation of slow-flashing and fast-flashing after connect telephone line?

A: This situation means the ADSL router is in the status of failing to establish connection with Central Office. Please check carefully and confirm whether the ADSL router has been installed correctly.

Q: LAN LED does not turn on after connect Ethernet cable?

A: Please make sure Ethernet cable is connected hub/PC and ADSL router correctly. Then please make sure the PC/hub have been power on.

Please make sure that user use parallel network cable to connect UpLink port of hub, or use parallel network cable to connect PC. If connect normal port of hub (not UpLink port), user must use cross-cable. Please make sure that user's network cables meet the networking requirements above.

Q: PC cannot access the Router?

A: Please make sure that all devices communicating with the device must use the same channel (and use the same SSID). Otherwise user's PC will not find the wireless Router.

Q: PC cannot access the Internet?

A: First check whether PC can ping the interface Ethernet IP address of this product successfully (default value is 192.168.1.1) by using ping application. If ping application fails, please check the connection of Ethernet cable and check whether the states of LEDs are in gear.

If the PC uses private IP address that is set manually (non-registered legal IP address), please check:

1. Whether IP address of the PC gateway is legal IP address. Otherwise please use the right gateway, or set the PC to Obtain an IP address automatically.
2. Please confirm the validity of DNS server appointed to the PC with ADSL operator. Otherwise please use the right DNS, or set the PC to Obtain an IP address automatically.
3. Please make sure user have set the NAT rules and convert private IP address to legal IP address. IP address range of the PC that user specify should meet the setting range in NAT rules.
4. Central Office equipment may have problem.
5. The country or the wireless network type user selected is wrong.

Q: PC cannot browse Internet web page?

A: Please make sure DNS server appointed to the PC is correct. User can use ping application program to test whether the PC can connect to the DNS server of the ADSL operator.

Q: Initialization of the PVC connection failed?

A: Be sure that cable is connected properly from the DSL port to the wall jack. The DSL LED on the front panel of the ADSL router should be on. Check that user's VPI, VCI, type of encapsulation and type of multiplexing setting are the same as what user collected from user's service provider, Re-configure ADSL router and reboot it. If user still can not work it out, user may need to verify these variables with the service provider.

***If the cause is not above given, please contact user's local service provider!***