



KW58293 Wireless ADSL Router User Manual

NOTICE

This document contains proprietary information protected by copyright, and this Manual and all the accompanying hardware, software, and documentation are copyrighted. All rights are reserved. No part of this document may be photocopied or reproduced by mechanical, electronic, or other means in any form.

The manufacturer does not warrant that the hardware will work properly in all environments and applications, and makes no warranty or representation, either expressed or implied, with respect to the quality, performance, merchantability, or fitness for a particular purpose of the software or documentation. The manufacturer reserves the right to make changes to the hardware, software, and documentation without obligation to notify any person or organization of the revision or change.

All brand and product names are the trademarks of their respective owners.

© Copyright 2014

All rights reserved.

FCC Warning:

Any Changes or modifications not expressly approved by the party responsible for compliance could void the user's authority to operate the equipment.

This device complies with part 15 of the FCC Rules. Operation is subject to the following two conditions: (1) This device may not cause harmful interference, and (2) this device must accept any interference received, including interference that may cause undesired operation.

Note: This equipment has been tested and found to comply with the limits for a Class B digital device, pursuant to part 15 of the FCC Rules. These limits are designed to provide reasonable protection against harmful interference in a residential installation. This equipment generates, uses and can radiate radio frequency energy and, if not installed and used in accordance with the instructions, may cause harmful interference to radio communications. However, there is no guarantee that interference will not occur in a particular installation. If this equipment does cause harmful interference to radio or television reception, which can be determined by turning the equipment off and on, the user is encouraged to try to correct the interference by one or more of the following measures:

- Reorient or relocate the receiving antenna.
- Increase the separation between the equipment and receiver.
- Connect the equipment into an outlet on a circuit different from that to which the receiver is connected.
- Consult the dealer or an experienced radio/TV technician for help.

FCC Radiation Exposure Statement:

This equipment complies with FCC radiation exposure limits set forth for an uncontrolled environment. This equipment should be installed and operated with minimum distance 20cm between the radiator & your body.

This transmitter must not be co-located or operating in conjunction with any other antenna or transmitter.

Customer Information

1. This equipment complies with Part 68 of the FCC rules and the requirements adopted by the ACTA. On the bottom of this equipment is a label that contains, among other information, a product identifier in the format US:AAAEQ##TXXXX. If requested, this number must be provided to the telephone company.
2. A plug and jack used to connect this equipment to the premises wiring and telephone network must comply with the applicable FCC Part 68 rules and requirements adopted by the ACTA. A compliant telephone cord and modular plug is provided with this product. It is designed to be connected to a compatible modular jack that is also compliant. See installation instructions for details.
3. If this equipment [US: U5IDL01BKW58293] causes harm to the telephone network, the telephone company will notify you in advance that temporary discontinuance of service may be required. But if advance notice isn't practical, the telephone company will notify the customer as soon as possible. Also, you will be advised of your right to file a complaint with the FCC if you believe it is necessary.
4. The telephone company may make changes in its facilities, equipment, operations or procedures that could affect the operation of the equipment. If this happens the telephone company will provide advance notice in order for you to make necessary modifications to maintain uninterrupted service.
5. If trouble is experienced with this equipment [US: U5IDL01BKW58293], for repair or warranty information, Service can be facilitated through our office at:

U.S. Agent Company name:Kasda Networks Inc

Address: 5185 Cliffwood Dr.

Montclair, CA 91763

Tel: 909 628 6088

Fax: 909 628 7999

If the equipment is causing harm to the telephone network, the telephone company may request that you disconnect the equipment until the problem is resolved.

6. Please follow instructions for repairing if any (e.g. battery replacement section); otherwise do not alternate or repair any parts of device except specified. For repair procedures, follow the instructions outlined under the limited warranty.

7. Connection to party line service is subject to state tariffs. Contact the state public utility commission, public service commission or corporation commission for information.

8. If your home has specially wired alarm equipment connected to the telephone line, ensure the installation of this [US: U5IDL01BKW58293] does not disable your alarm equipment. If you have questions about what will disable alarm equipment, consult your telephone company or a qualified installer.

9. If the telephone company requests information on what equipment is connected to their lines, inform them of:

- a) The ringer equivalence number [0.1B]
- b) The USOC jack required [RJ11C]
- c) Facility Interface Codes ("FIC") [NA]
- d) Service Order Codes ("SOC") [NA]
- e) The FCC Registration Number [US: U5IDL01BKW58293]

10. The REN is used to determine the number of devices that may be connected to a telephone line. Excessive RENs on a telephone line may result in the devices not ringing in response to an incoming call. In most but not all areas, the sum of RENs should not exceed five (5.0). To be certain of the number of devices that may be connected to a line, as determined by the total RENs, contact the local telephone company. The REN for this product is part of the product identifier that has the format US:AAAEQ##TXXXX. The digits

represented by ## are the REN without a decimal point. For this product the FCC Registration number is [US: U5IDL01BKW58293] indicates the REN would be 0.1B.

11. If this product is equipped with a corded or cordless handset, it is hearing aid compatible.

Content

| | |
|--|-----------|
| 1 OVERVIEW | 1 |
| 1.1 FEATURES..... | 1 |
| 1.1.1 <i>Data rate</i> | 1 |
| 1.1.2 <i>ADSL Compliance</i> | 1 |
| 1.1.3 <i>Wireless</i> | 1 |
| 1.1.4 <i>Network Protocol and Features</i> | 2 |
| 1.1.5 <i>ATM Capabilities</i> | 2 |
| 1.1.6 <i>FIREWALL</i> | 2 |
| 1.1.7 <i>Management Support</i> | 3 |
| 1.1.8 <i>Operating System Support</i> | 3 |
| 1.1.9 <i>Environmental</i> | 3 |
| 1.2 PACKET CONTENTS..... | 3 |
| 1.3 SYSTEM REQUIREMENTS | 4 |
| 1.4 FACTORY DEFAULTS | 4 |
| 1.5 WARNINGS AND CAUTIONS | 4 |
| 2 HARDWARE DESCRIPTION | 5 |
| 3 HARDWARE INSTALLATION..... | 7 |
| 4 PC CONFIGURATION GUIDE | 8 |
| 4.1 LOCAL PC CONFIGURATION IN WINDOWS 95, 98, ME, XP | 8 |
| 4.2 LOCAL PC CONFIGURATION IN WINDOWS 2000 | 8 |
| 4.3 LOCAL PC CONFIGURATION IN WINDOWS VISTA | 9 |
| 4.4 LOCAL PC CONFIGURATION IN WINDOWS 7 | 9 |
| 5 WEB-BASED MANAGEMENT GUIDE | 10 |
| 5.1 LAN SETTING PAGE | 10 |
| 5.2 ADSL SETUP..... | 10 |
| 5.2.1 <i>PPPoE(PPP over Ethernet)</i> | 11 |
| 5.2.2 <i>PPPoA(PPP over ATM)</i> | 13 |
| 5.2.3 <i>Bridged</i> | 15 |
| 5.2.4 <i>LAN Settings</i> | 16 |
| 5.3 WLAN SETTING..... | 19 |
| 5.3.1 <i>Basic</i> | 19 |

| | | |
|--|--------------------------------|-----------|
| 5.3.2 | <i>Advanced Settings</i> | 20 |
| 5.3.3 | <i>Security</i> | 22 |
| 5.4 | MANAGEMENT | 26 |
| 5.4.1 | <i>TR069</i> | 26 |
| 5.4.2 | <i>Port Mapping</i> | 27 |
| 5.4.3 | <i>Reset Router</i> | 29 |
| APPENDIX FREQUENT ASKED QUESTIONS | | 30 |

1 Overview

Thank you for choosing our product. The KW58293 Wireless ADSL Router uses Broadcom's CPE solution that fully complies with ADSL, ADSL2, ADSL2+ and IEEE802.11b/g/n standards. It will provide your SOHO with convenient Internet access.

1.1 Features

1.1.1 Data rate

- Downstream data rate up to 24 Mbps,
- Upstream data rate up to 3.5Mbps (With AnnexM enabled)

1.1.2 ADSL Compliance

- ITU G.992.1 (G.DMT)
- ITU G.992.2 (G.Lite)
- ITU G.994.1 (G.hs)
- ITU G.992.3 (G.DMT.BIS)
- ITU G.992.4 (G.lite.bis)
- ITU G.992.5
- Compatible with all T1.413 issue 2 (full rate DMT over analog POTS), and CO DSLAM equipment
- TR-069 compliant with ACS
- Support IPv6

1.1.3 Wireless

- Fully IEEE 802.11b & IEEE 802.11g&IEEE 802.11n compatible.
- Wireless data rate up to 300 Mbps
- Operating in the unlicensed 2.4 GHz ISM band
- Supports 64/128 bits WEP, WPA, WPA2, WPA/WPA2-PSK, 802.1x

1.1.4 Network Protocol and Features

- Ethernet to ADSL Self-Learning Transparent Bridging
- Internet Control Message Protocol (ICMP)
- IP Static Routing
- Routing Information Protocol (RIP, RIPv2)
- Network Address Translation (NAT)
- Virtual Server, Port Forwarding
- Dynamic Host Configuration Protocol (DHCP)
- DDNS
- Simple Network Time Protocol (SNTP)
- VPN pass-through (IPSec/PPTP/L2TP)

1.1.5 ATM Capabilities

- RFC 1483 Multi-protocol over ATM “Bridged Ethernet” compliant
- RFC 2364 PPP over ATM compliant
- RFC 2516 PPP over Ethernet compliant
- ATM Forum UNI3.1/4.0 PVC
- VPI Range: 0-255
- VCI Range: 32-65535
- UNI 3.0 & 3.1 Signaling
- ATM AAL5 (Adaption Layer type 5)
- OAM F4/F5

1.1.6 FIREWALL

- Built-in NAT
- MAC Filtering

- Packet Filtering
- Stateful Packet Inspection (SPI)
- Denial of Service Prevention (DoS)
- DMZ

1.1.7 Management Support

- Web Based GUI
- Upgrade or update via FTP/HTTP
- Command Line Interface via Telnet
- Diagnostic Test
- Firmware upgrade-able for future feature enhancement

1.1.8 Operating System Support

- WINDOWS 98/SE/ME/2000/XP/VISTA/7
- Macintosh
- LINUX

1.1.9 Environmental

- Operating humidity: 10%-90% non-condensing
- Non-operating storage humidity: 5%-95% non-condensing

1.2 Packet Contents

The packet contents are as the following:

- ADSL ROUTER x 1
- Power Adapter x 1
- Telephone Line x 1
- Ethernet Cable x 1
- External Splitter x 1
- CD x 1

1.3 System Requirements

Before using this ROUTER, verify that you meet the following requirements:

- Subscription for ADSL service. Your ADSL service provider should provide you with at least one valid IP address (static assignment or dynamic assignment via dial-up connection).
- One or more computers, each contains an Ethernet 10/100M Base-T network interface card (NIC).
- A hub or switch, if you are connecting the device to more than one computer.
- For system configuration using the supplied web-based program: A web browser such as Internet Explorer v5.0 or later, or Netscape v4.7 or later.

1.4 Factory Defaults

The device is configured with the following factory defaults:

- IP Address: 192.168.1.1
- Subnet Mask: 255.255.255.0
- Encapsulation: LLC/SNAP-BRIDGING or VC/MUX
- VPI/VCI: According to local information





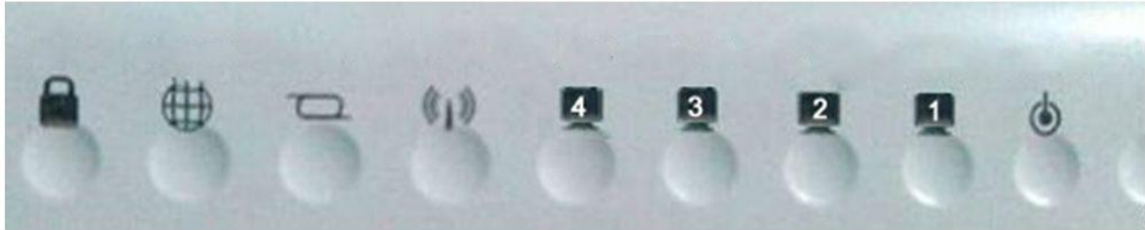

1.5 Warnings and Cautions

- Never install telephone wiring during storm. Avoid using a telephone during an electrical storm. There might be a risk of electric shock from lightning.
- Do not install telephone jacks in wet locations and never use the product near water.
- To prevent dangerous overloading of the power circuit, be careful about the designed maximum power load ratings. Not to follow the rating guideline could result in a dangerous situation.
- Please note that telephone line on modem must adopt the primary line that directly outputs from junction box. Do not connect Router to extension phone. In addition, if your house developer divides a telephone line to multi sockets inside the wall of house, please only use the telephone that has connected with the splitter of ADSL Router when you access the Internet. Under the above condition, if you also install telephone with anti-cheat-dial device, please pull out this kind of telephone, otherwise ADSL Router may occur frequently off-line.

2 Hardware Description

Front Panel



| LED | Color | Function |
|---|-------|---|
|  | Green | On: Power on Off: No power |
|  | Green | On: LAN link established and active via LAN port Blinking: ADSL data activity occurs Off: No LAN link via LAN port |
|  | Green | On: The wireless module is ready and idle Blinking: Data transmitting or receiving over WLAN Off: The wireless function is off |
|  | Green | On: ADSL link established and active Quick Blinking: ADSL is trying to establish a connection Slow Blinking: No ADSL link |
|  | Green | On: IP connected Blinking: IP connected and IP traffic is passing thru the device Off: Modem power off or ADSL connection not present |
|  | Green | On: WPS connection is established Blinking: Trying to establish a WPS connection Off: WPS function is off or no WPS connection |

Rear panel

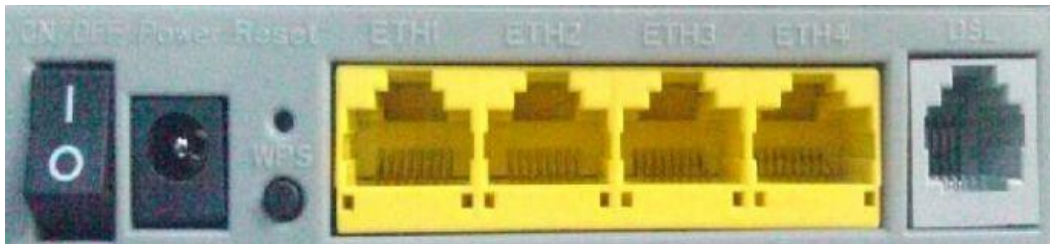

| Port | Function |
|--------|--|
| DSL | Connect the device to an ADSL telephone jack or splitter using a RJ-11 telephone cable |
| ETH1-4 | Connect the device to user's PC's Ethernet port, or to the uplink port on user's hub/switch, using a RJ-45 cable |
| Reset | System reset or reset to factory defaults |
| WPS | A convenient way for WPS set. |
| ON/OFF | Switch it on or off |
| Power | Connect to the supplied power adapter |

3 Hardware Installation

This chapter shows user how to connect Router. Meanwhile, it introduces the appropriate environment for the Router and installation instructions.

1. Using a telephone line to connect the **DSL** port of ROUTER to the **Modem** port of the splitter, and using a other telephone line connect user's telephone to the **PHONE** port of the splitter, then connect the wall phone jack to the **LINE** port of the splitter.

The splitter comes with three connectors as below:

LINE: Connects to a wall phone jack (RJ-11 jack)

ROUTER: Connects to the DSL jack of ROUTER

PHONE: Connects to a telephone set

2. Using an Ethernet Cable to connect the LAN port of the ROUTER to user's LAN or a PC with network card installed. Or using an USB cables to connect the USB port of the ROUTER to user's PC.
3. Connect the power cable to the POWER connector on ROUTER, then plug in the power adapter to the power outlet, and then press the on-off button.

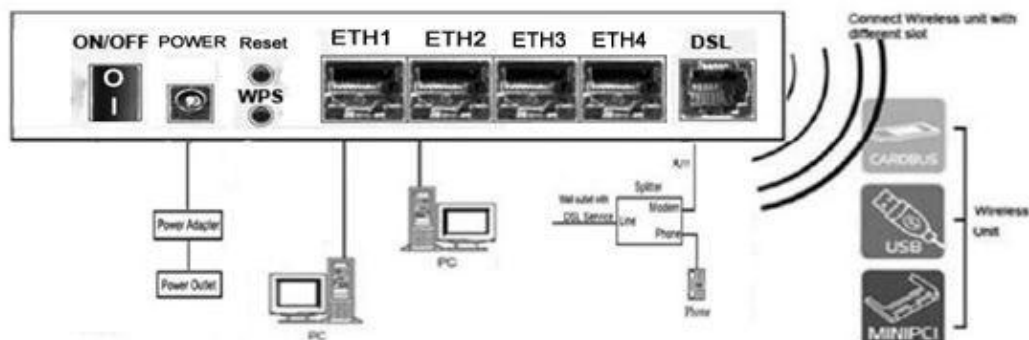

Notes: Without the splitter and certain situation, transient noise from telephone can interfere with the operation of the Router, and the Router may introduce noise to the telephone line. To prevent this from happening, a small external splitter must be connected to each telephone.

4 PC Configuration Guide

4.1 Local PC Configuration in Windows 95, 98, ME, XP

1. In the Windows task bar, click the “Start” button, point to “Settings”, and then click “Control Panel”.
2. Double-click the “Network” icon.
3. On the “Configuration” tab, select the TCP/IP network associated with user’s network card and then click “Properties”.
4. In the “TCP/IP Properties” dialog box, click the “IP Address” tab. Set the IP address as 192.168.1.x (x can be a decimal number from 2 to 254.) like 192.168.1.2, and the subnet mask as 255.255.255.0.
5. On the “Gateway” tab, set a new gateway as 192.168.1.1, and then click “Add”.
6. Configure the “DNS” tab if necessary. For information on the IP address of the DNS server, please consult with user’s ISP.
7. Click “OK” twice to confirm and save user’s changes.
8. User will be prompted to restart Windows. Click “Yes”.

4.2 Local PC Configuration in Windows 2000

1. In the Windows task bar, click the “Start” button, point to “Settings”, and then click “Control Panel”.
2. Double-click the “Network and Dial-up Connections” icon.
3. In the “Network and Dial-up Connections” window, right-click the “Local Area Connection” icon, and then select “Properties”.
4. Highlight “Internet Protocol (TCP/IP)”, and then click “Properties”.
5. In the “Internet Protocol (TCP/IP) Properties” dialog box, set the IP address as 192.168.1.x (x can be a decimal number from 2 to 254.), and the subnet mask as 255.255.255.0 and the default gateway as 192.168.1.1. Then click “OK”.
6. Configure the “DNS” tab if necessary. For information on the IP address of the DNS server, please consult with user’s ISP.
7. Click “OK” twice to confirm and save user’s changes.

4.3 Local PC Configuration in Windows Vista

1. Go to Start. Click on Network.
2. Then click on Network and Sharing Center at the top bar.
3. When the Network and Sharing Center window pops up, select and click on Manage network connections on the left window column.
4. Select the Local Area Connection, and right click the icon to select Properties.
5. Select Internet Protocol Version 4 (TCP/IPv4) then click Properties.
6. In the TCP/IPv4 properties window, select the Obtain an IP address automatically and Obtain DNS Server address automatically radio buttons. Then click OK to exit the setting.
7. Click OK again in the Local Area Connection Properties window to apply the new configuration

4.4 Local PC Configuration in Windows 7

1. Go to Start. Click on Control Panel. Then click on Network and Internet.
2. When the Network and Sharing Center window pops up, select and click on Change adapter settings on the left window panel.
3. Select the Local Area Connection, and right click the icon to select Properties.
4. Select Internet Protocol Version 4(TCP/IPv4) then click Properties.
5. n the TCP/IPv4 properties window, select the Obtain an IP address automatically and Obtain DNS Server address automatically radio buttons. Then click OK to exit the setting.
6. Click OK again in the Local Area Connection Properties window to apply the new configuration.

5 Web-based Management Guide

In order to use the web-based management software it will be necessary to use a computer that occupies the same subnet as the Router. The simplest way to do this for many users will be to use DHCP server that is enabled by default on the Router.

5.1 LAN setting page

Launch a web browser, such as Internet Explorer, and then use <http://192.168.1.1> to log on to the setting pages.

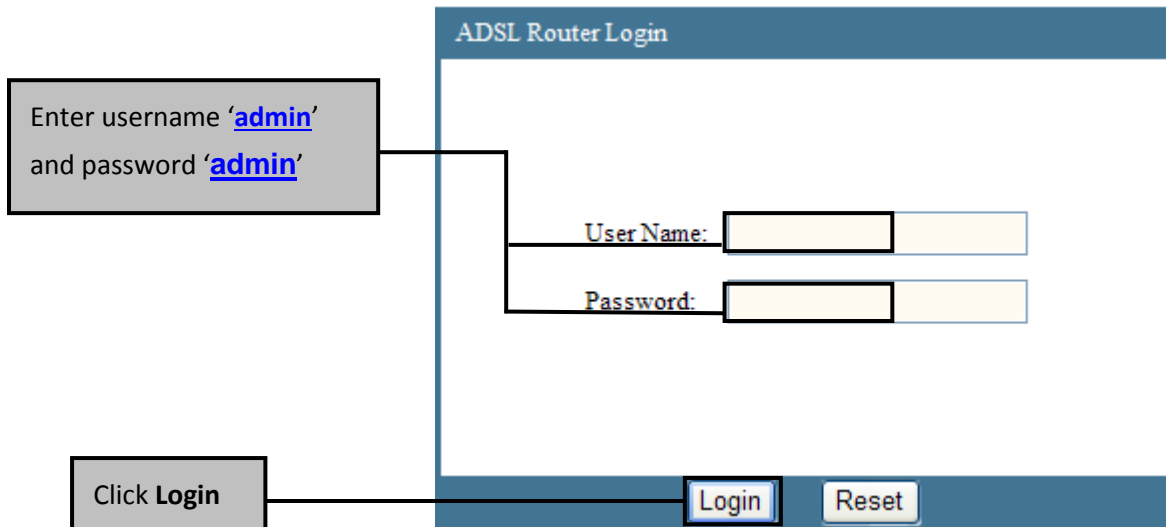

Attention: the username and password are both lowercase.

5.2 ADSL setup

From home page, you can find Setup option on the top router configuration page.

ADSL Router Status
This page shows the current status and some basic settings of the device.

System

| | |
|------------------|-----------------------|
| Alias Name | RTL867x ADSL Modem |
| Uptime | 0 0:3:27 |
| Date/Time | Sun Jan 1 0:3:27 2012 |
| Firmware Version | RTK V2.1.1 |
| Built Date | Aug 21 2013 15:37:29 |
| Serial Number | 000EF4D96F83 |

From **Setup**, click **WAN**, configure the parameters for the channel operation modes of your ADSL Router.

5.2.1 PPPoE(PPP over Ethernet)

PPPoE (Point to Point Protocol over Ethernet) provides access control and billing functionality in a manner similar to dial-up services using PPP. The router bridges a PPP session over Ethernet (PPP over Ethernet, RFC2516) from your computer to an ATM PVC (Permanent Virtual Circuit) which connects to ADSL Access Concentrator where the PPP session terminates. One PVC can support any number of PPP sessions from your LAN.

Select **PPP over Ethernet (PPPoE)** as **Channel Mode**, and select **LLC** as encapsulation mode.

WAN Configuration

This page is used to configure the parameters for the WAN interface of your ADSL and(or) Ethernet Modem/Router. Note : When connect type of PPPoE and PPPoA only is "Manual", the "Connect" and "Disconnect" button will be enable.

| | | | |
|--|---|--|-------------------------------------|
| Default Route Selection: | | | |
| <input type="radio"/> Auto | | <input checked="" type="radio"/> Specified | |
| VPI: | <input type="text" value="0"/> | VCI: | <input type="text"/> |
| Encapsulation: | <input checked="" type="radio"/> LLC | <input type="radio"/> VC-Mux | |
| Channel Mode: | <input type="text" value="PPPoE"/> | Enable NAPT: | <input checked="" type="checkbox"/> |
| Enable IGMP: | <input type="checkbox"/> | | |
| PPP Settings: | | | |
| User Name: | <input type="text"/> | Password: | <input type="text"/> |
| Type: | <input type="text" value="Continuous"/> | Idle Time (min): | <input type="text"/> |
| WAN IP Settings: | | | |
| Type: | <input checked="" type="radio"/> Fixed IP | <input type="radio"/> DHCP | |
| Local IP Address: | <input type="text"/> | Remote IP Address: | <input type="text"/> |
| NetMask: | <input type="text"/> | | |
| Default Route: | <input type="radio"/> Disable | <input checked="" type="radio"/> Enable | <input type="radio"/> Auto |
| Unnumbered: | <input type="checkbox"/> | | |
| <input type="button" value="Connect"/> <input type="button" value="Disconnect"/> <input type="button" value="Add"/> <input type="button" value="Modify"/> <input type="button" value="Delete"/> <input type="button" value="Undo"/> <input type="button" value="Refresh"/> | | | |

| Item | Description |
|-------------|---|
| VPI/VCI | Enter the PVC that your ISP gives you. |
| Enable NAPT | NAPT extends the notion of NAT one step further by also translating the transport identifier (TCP and UDP port numbers, ICMP query identifiers). This allows the transport identifiers of a number of private hosts to be multiplexed into the transport identifiers of a |

| | |
|---------------------------------------|--|
| | single public IP address. |
| Enable IGMP | IGMP(Internet Group Management Protocol) is a network-layer protocol used to establish membership in a Multicast group- it is not used to carry user data. IGMP version 2 (RFC 2236) is an improvement over version 1 (RFC 1112) but IGMP version 1 is still in wide use. |
| PPP settings: User name & password | Enter the user name and password that your ISP gives you. |
| PPP Settings: Type | <p>Continuous: If you want to access the Internet all the time, select Continuous type.</p> <p>Connect on Demand: Select this type when you don't want the connection up all the time and specify an idle time-out in the Idle Time field.</p> <p>Manual: When connect type of PPPoE and PPPoA only is "Manual", the "Connect" and "Disconnect" button will be enable.</p> |

5.2.2 PPPoA(PPP over ATM)

PPPoA stands for Point to Point Protocol over ATM Adaptation Layer 5 (AAL5). A PPPoA connection functions like a dial-up Internet connection. The router encapsulates the PPP session based on RFC1483 and sends it through an ATM PVC (Permanent Virtual Circuit) to the Internet Service Provider's (ISP) DSLAM (digital access multiplexer). Please refer to RFC2364 for more information on PPPoA.

Select PPP over ATM (**PPPoA**) as **Channel Mode** and **VC-Mux** as encapsulation mode.

| | | | |
|--|---|---|--|
| Default Route Selection: | | <input type="radio"/> Auto | <input checked="" type="radio"/> Specified |
| VPI: | <input type="text" value="0"/> | VCI: | <input type="text"/> |
| Encapsulation: | <input checked="" type="radio"/> LLC | <input type="radio"/> VC-Mux | |
| Channel Mode: | <input type="text" value="PPPoA"/> | Enable NAPT: | <input type="checkbox"/> |
| Enable IGMP: | <input type="checkbox"/> | | |
| PPP Settings: | | | |
| User Name: | <input type="text"/> | Password: | <input type="text"/> |
| Type: | <input type="text" value="Continuous"/> | Idle Time (min): | <input type="text"/> |
| WAN IP Settings: | | | |
| Type: | <input checked="" type="radio"/> Fixed IP | <input type="radio"/> DHCP | |
| Local IP Address: | <input type="text"/> | Remote IP Address: | <input type="text"/> |
| NetMask: | <input type="text"/> | | |
| Default Route: | <input type="radio"/> Disable | <input checked="" type="radio"/> Enable | <input type="radio"/> Auto |
| Unnumbered: | <input type="checkbox"/> | | |
| <input type="button" value="Connect"/> <input type="button" value="Disconnect"/> <input type="button" value="Add"/> <input type="button" value="Modify"/> <input type="button" value="Delete"/> <input type="button" value="Undo"/> <input type="button" value="Refresh"/> | | | |

| Item | Description |
|-------------|--|
| VPI/VCI | Enter the PVC that your ISP gives you. |
| Enable NAPT | NAPT extends the notion of NAT one step further by also translating the transport identifier (eg TCP and UDP port numbers, ICMP query identifiers). This allows the transport identifiers of a number of private hosts to be multiplexed into the transport identifiers of a single public IP address. |
| Enable IGMP | IGMP(Internet Group Management Protocol) is a network-layer protocol used to establish membership in a Multicast group- it is not used to carry user data. IGMP version 2 (RFC 2236) is an improvement over version 1 (RFC 1112) but IGMP version 1 is still |

| | |
|--|--|
| | in wide use. |
| PPP settings: User name & password | Enter the user name and password that your ISP gives you. |
| PPP Settings: Type | <p>Continuous: If you want to access the Internet all the time, select Continuous type.</p> <p>Connect on Demand: Select this type when you don't want the connection up all the time and specify an idle time-out in the Idle Time field.</p> <p>Manual: When connect type of PPPoE and PPPoA only is "Manual", the "Connect" and "Disconnect" button will be enable.</p> |

5.2.3 Bridged

With bridging the router has a static IP address for connection. The router passes traffic through to another device (a computer or router for example) that handles authenticating with the ISP. Enter VPI and VCI according to your local region and select the appropriate **Encapsulation mode**. Click **Add** to add your configuration and then click **Save** button on the left bottom.

| | | | |
|--|---|---|----------------------------|
| Default Route Selection: | | <input type="radio"/> Auto <input checked="" type="radio"/> Specified | |
| VPI: | <input type="text" value="0"/> | VCI: | <input type="text"/> |
| Encapsulation: | <input checked="" type="radio"/> LLC | <input type="radio"/> VC-Mux | |
| Channel Mode: | <input type="text" value="1483 Bridged"/> | Enable NAPT: | <input type="checkbox"/> |
| Enable IGMP: | <input type="checkbox"/> | | |
| PPP Settings: | | | |
| User Name: | <input type="text"/> | Password: | <input type="text"/> |
| Type: | <input type="text" value="Continuous"/> | Idle Time (min): | <input type="text"/> |
| WAN IP Settings: | | | |
| Type: | <input checked="" type="radio"/> Fixed IP | <input type="radio"/> DHCP | |
| Local IP Address: | <input type="text"/> | Remote IP Address: | <input type="text"/> |
| NetMask: | <input type="text"/> | | |
| Default Route: | <input type="radio"/> Disable | <input checked="" type="radio"/> Enable | <input type="radio"/> Auto |
| Unnumbered: | <input type="checkbox"/> | | |
| <input type="button" value="Connect"/> <input type="button" value="Disconnect"/> <input type="button" value="Add"/> <input type="button" value="Modify"/> <input type="button" value="Delete"/> <input type="button" value="Undo"/> <input type="button" value="Refresh"/> | | | |

5.2.4 LAN Settings

From **LAN**, Configure the DSL Router's IP Address and Subnet Mask for LAN interface. In this page, you can use DHCP (Dynamic Host Configuration Protocol) to control the assignment of IP addresses on your local network (LAN only). KW58293 support IPv4 /IPv6 dual stack.

From **LAN Interface**, Configure the DSL Router's IP Address and Subnet Mask for LAN interface.

Interface Name: e1
 IP Address:
 Subnet Mask:
 Secondary IP
 IGMP Snooping: Disable Enable

LAN Port:
 Link Speed/Duplex Mode:

ETHERNET Status Table:

| Select | Port | Link Mode |
|-----------------------|------|------------------|
| <input type="radio"/> | LAN1 | AUTO Negotiation |
| <input type="radio"/> | LAN2 | AUTO Negotiation |
| <input type="radio"/> | LAN3 | AUTO Negotiation |
| <input type="radio"/> | LAN4 | AUTO Negotiation |

MAC Address Control: LAN1 LAN2 LAN3 LAN4 WLAN

New MAC Address:

| Item | Description |
|---------------------|---|
| IP address | This is the IP address that other devices on your local network will use to connect to the modem. The default is 192.168.1.1 . |
| Subnet mask | This defines the size of your network. The default is 255.255.255.0 . |
| Secondary IP | Select this option is to let the device use a second IP on the LAN interface. You can also use this second IP address to access the device for management. Enter the LAN IP address of your device in dotted decimal notation, for example, |

| | |
|-------------------------------|---|
| | 10.0.0.1. Type the subnet mask. |
| IGMP snooping | IGMP Snooping is a method that actually “snoops” or inspects IGMP traffic on a switch. When enabled, the switch will watch for IGMP messages passed between a host and a router, and will add the necessary ports to its multicast table, ensuring that only the ports that require a given multicast stream actually receive it. |
| Link Speed/Duplex Mode | You have five choices here. 100Mbps/Full Duplex, 100Mbps/Half Duplex, 10Mbps/Full Duplex, 10Mbps/Half Duplex and Auto Negotiation. |
| MAC Address Control | Select the LAN interface for which you want to use MAC address control rule. Click Apply Changes to save and apply your configuration. |
| New MAC Address | Enter the MAC address allowed, for example, 00:0e:f4:33:33:22. |

5.3 WLAN Setting

5.3.1 Basic

Wireless Basic Settings

This page is used to configure the parameters for your wireless network :

Disable Wireless LAN Interface

Band:

Mode:

SSID:

Channel Width:

Control Sideband:

Channel Number: **Current Channel:** 1

Radio Power (Percent):

Associated Clients:

| Option | Description |
|----------------------------|--|
| Enable wireless | A check box that enables or disables the wireless LAN interfaces. The default is to enable wireless communications. |
| Band | This is the range of frequencies the gateway will use to communicate with user's wireless devices. |
| Channel | Drop-down menu that allows selection of specific channel. |
| Clients isolation | Enable this item if you don't want your wireless clients to communicate with each other. |
| Network name (SSID) | Enter a name for user's wireless network here. SSID stands for Service Set Identifier. This name must be between 1 and 32 characters long. All wireless clients must either detect the gateway or be configured with the correct SSID to |

| | |
|----------------|--|
| | access the Internet. |
| BSSID | Displays the gateway's wireless MAC address. (User may need this address if user is using WDS or multiple gateways.) Click Apply to save changes. |
| Country | Drop-down menu that allows selection of specific channel. |

5.3.2 Advanced Settings

This page is where user specifies a number of advanced settings for wireless communications.

Wireless Advanced Settings

These settings are only for more technically advanced users who have a sufficient knowledge about wireless LAN. These settings should not be changed unless you know what effect the changes will have on your Access Point.

Authentication Type: Open System Shared Key Auto

Fragment Threshold: (256-2346)

RTS Threshold: (0-2347)

Beacon Interval: (20-1024 ms)

DTIM Interval: (1-255)

Data Rate:

Preamble Type: Long Preamble Short Preamble

Broadcast SSID: Enabled Disabled

Relay Blocking: Enabled Disabled

Ethernet to Wireless Blocking: Enabled Disabled

Wifi Multicast to Unicast: Enabled Disabled

Aggregation: Enabled Disabled

Short GI: Enabled Disabled

Note: After making any changes, click **Apply** to save.

Warning: The settings shown above are default settings. Changes made to these items can cause wireless communication problems.

| Field | Description |
|--------------------------------|--|
| Fragmentation threshold | <p>A threshold, specified in bytes, that determines whether packets will be fragmented and at what size. On an 802.11 connection, packets that are larger than the fragmentation threshold are split into smaller units suitable for the circuit size. Packets smaller than the specified fragmentation threshold value are not fragmented.</p> <p>Enter a value between 256 and 2346. If user experience a high packet error rate, try to increase this value slightly. Setting the fragmentation threshold too low may result in poor performance.</p> |
| RTS threshold | <p>This is number of bytes in the packet size beyond which the gateway invokes its RTS/CTS (request to send, clear to send) mechanism. Packets larger than this threshold trigger the RTS/CTS mechanism, while the gateway transmits smaller packets without using RTS/CTS. The default setting of 2347, which is the maximum, disables the RTS threshold mechanism.</p> |
| DTIM interval | <p>A delivery traffic indication message (DTIM), also known as a beacon, is a countdown informing wireless clients of the next window for listening to broadcast and multicast messages. When the gateway has broadcast or multicast messages for its clients, it sends its next DTIM message with this DTIM interval value. The clients hear the beacons and awaken as needed to receive the broadcast and multicast messages.</p> |
| Beacon interval | <p>The amount of time (in milliseconds) between beacon transmissions, each of which identifies the presence of an access point. By default, wireless clients passively scan all radio channels, listening for beacons coming from access points. Before a client enters power-save mode, it needs the beacon interval to determine when to wake up for the next beacon (and learn whether the access point has any messages for it). User can enter any value between 1 and 65535, but the recommended range is 1 - 1000.</p> |

| | |
|---------------------------|---|
| XPress™ Technology | <p>XPress™ Technology is a feature in which two of our devices can communicate with each other at twice the normal rate.</p> <p>54g+ is a technology that achieves higher throughput with frame-bursting. With 54g+ enabled, aggregate throughput (the sum of the individual throughput of each network client) improves by up to 25% in 802.11g-only networks, and up to 75% in mixed networks containing both 802.11g and 802.11b equipment.</p> |
|---------------------------|---|

5.3.3 Security

This page allows you to configure security features of the wireless LAN interface. You may set up configuration manually or through WiFi Protected Setup(WPS)

1. Click **Security** of **Wireless** item and you'll see the following page.

Wireless Security Setup

This page allows you setup the wireless security. Turn on WEP or WPA by using Encryption Keys could prevent any unauthorized access to your wireless network.

SSID TYPE: Root VAP0 VAP1 VAP2 VAP3

Encryption:

Use 802.1x Authentication WEP 64bits WEP 128bits

WPA Authentication Mode: Enterprise (RADIUS) Personal (Pre-Shared Key)

Pre-Shared Key Format:

Pre-Shared Key:

Authentication RADIUS Server: Port IP address Password

Note: When encryption WEP is selected, you must set WEP key value.

2. Configure WPA Pre-shared key as below and click **Apply/Save**.

SSID TYPE: Root VAP0 VAP1 VAP2 VAP3

Encryption: **WPA (AES)**

Use 802.1x Authentication WEP 64bits WEP 128bits

WPA Authentication Mode: Enterprise (RADIUS) Personal (Pre-Shared Key)

Pre-Shared Key Format: **Passphrase**

Pre-Shared Key:

Authentication RADIUS Server: Port IP address Password

Note: When encryption WEP is selected, you must set WEP key value.

3. Enable WPS as below.

Wi-Fi Protected Setup

This page allows you to change the setting for WPS (Wi-Fi Protected Setup). Using this feature could let your wireless client automatically synchronize its setting and connect to the Access Point in a minute without any hassle.

Disable WPS

WPS Status: Configured UnConfigured

Self-PIN Number:

Push Button Configuration:

Current Key Info:

| Authentication | Encryption | Key |
|----------------|------------|-----|
| Open | None | N/A |

Client PIN Number:

4. Set **Start PBC** and click **Save/Changes**.

5. Now you can use a wireless adaptor with WPS function and the WPS button to connect to access the Internet.

6. To configure security features for the Wireless interface, please open Security item from Wireless menu. This web page offers nine authentication protocols for user to secure user's data while connecting to networks. There are four selections including Open, Shared, 802.1X, WPA, WPA-PSK, WPA2, WPA2-PSK, Mixed WPA-WPA2, Mixed WPA-WPA2-PSK. Different item leads different web page settings. Please read the following information carefully.

The wireless security page allows user to configure the security features of user's wireless network.

Wireless WEP Key Setup

This page allows you setup the WEP key value. You could choose use 64-bit or 128-bit as the encryption key, and select ASCII or Hex as the format of input value.

SSID TYPE: Root VAP0 VAP1 VAP2 VAP3

Key Length:

Key Format:

Default Tx Key:

Encryption Key 1:

Encryption Key 2:

Encryption Key 3:

Encryption Key 4:

There are several security methods to choose from, depending on user's needs and the capabilities of user's wireless machines.

- None
- WEP
- WPA (TKIP)
- WPA (AES)
- WPA2(AES)
- WPA2(TKIP)
- WPA2 Mixed

Use 802.1x Authentication

WPA Authentication Mode:

Pre-Shared Key Format:

Pre-Shared Key:

- **WEP** —WEP is an encryption scheme that is used to protect user's wireless data communications. WEP uses a combination of 64-bit keys or 128-bit keys to provide access control to user's network and encryption security for every data transmission. To decode a data transmission, each wireless client on the network must use an identical 64-bit or 128-bit key. WEP is an older wireless encryption method that is not as hard to break as the more-recent WPA.
- **802.1x** — In 802.1x (also known as RADIUS), a separate machine called an authentication server receives a user ID and password. It grants or denies access based on whether the ID and password match any entries in its account list. User can optionally enable WEP encryption with this option. Because it requires a separate machine acting as the authentication server, 802.1x is most often used in business environments.
- **WPA** — WPA is a more recent encryption method that addresses many of the weaknesses in WEP. Any client capable of WPA encryption should use it instead of WEP.
- **WPA (PSK)** — This is WPA encryption combined with a *pre-shared key (PSK)*, which is a text string known only to the gateway and authorized wireless clients. The gateway rejects the login if the client's PSK does not match.
- **WPA2** — WPA2 is a more advanced encryption method than WPA. Because it is a more recent standard, some of user's wireless devices might not be able to use it.
- **WPA2 (PSK)** — This option uses WPA2 with a pre-shared key.
- **WPA2 Mixed** — This option supports WPA2/WPA encryption for devices capable of one or the other standard. The gateway automatically detects whether a particular device can use WPA2 or WPA.

After making changes, click **Apply** to save.

5.4 Management

5.4.1 TR069

WAN Management Protocol (TR-069) allows a Auto-Configuration Server (ACS) to perform auto-configuration, provision, collection, and diagnostics to this device. Select **Configure TR-069** from **Advanced->CWMP**.

| | |
|---------------------------|---|
| ACS: | |
| Enable: | <input checked="" type="checkbox"/> |
| URL: | <input type="text" value="http://172.21.70.44/cpe/?pd128"/> |
| User Name: | <input type="text" value="rtk"/> |
| Password: | <input type="text" value="rtk"/> |
| Periodic Inform Enable: | <input type="radio"/> Disable <input checked="" type="radio"/> Enable |
| Periodic Inform Interval: | <input type="text" value="300"/> seconds |

| | |
|---------------------|-------------------------------------|
| Connection Request: | |
| User Name: | <input type="text" value="rtk"/> |
| Password: | <input type="text" value="rtk"/> |
| Path: | <input type="text" value="/tr069"/> |
| Port: | <input type="text" value="7547"/> |

URL: URL for the CPE to connect to the ACS using the CPE WAN Management Protocol. And through ACS (Auto-Configuration Server) you can perform auto-configuration, provision, collection, and diagnostics to this router.

User Name: Username used to authenticate an ACS making a Connection Request to the CPE.

Password: Password used to authenticate an ACS making a Connection Request to the CPE. When read, this parameter returns an empty string, regardless of the actual value.

Periodic Inform Enable: Whether or not the CPE must periodically send CPE information to Server using the Inform method call.

Periodic Inform Interval: The duration in seconds of the interval for which the CPE MUST attempt to connect with the ACS and call the Inform method if Inform is enabled.

Connection Request User Name: Username used to authenticate the CPE when

making a connection to the ACS using the CPE WAN Management Protocol. This username is used only for authentication of the CPE.

Connection Request Password: Password used to authenticate the CPE when making a connection to the ACS using the CPE WAN Management Protocol. This password is used only for authentication of the CPE.

Note: If you want to cancel all modification that you do on the Router, please select from “Admin⇒Commit/Reboot⇒Factory Default Configuration⇒Reboot” to restore factory default settings.

5.4.2 Port Mapping

Port Mapping supports multiple ports to PVC and bridging groups. Each group will perform as an independent network. To support this feature, you must create mapping groups with appropriate LAN and WAN interfaces using the Add button. The Del button will remove the grouping and add the ungrouped interfaces to the Default group. Only the default group has IP interface. For example, if you have PVC 8/35 and PPPoE service for internet, PVC 0/33 and bridge for IPTV, you can set the interface as the Default group and others as group IPTV as below.

1. Select **Port Mapping** from **Advanced**.

Disable
 Enable

WAN

Interface group

Add >

< Del

LAN

| Select | Interfaces | Status |
|-------------------------------|---|---------|
| Default | LAN1,LAN2,LAN3,LAN4,wlan,wlan-vap0,wlan-vap1,wlan-vap2,wlan-vap3,a0 | Enabled |
| Group 1 <input type="radio"/> | | -- |
| Group 2 <input type="radio"/> | | -- |
| Group 3 <input type="radio"/> | | -- |
| Group 4 <input type="radio"/> | | -- |

2. Enable it and select Group1 as below.

Disable
 Enable

WAN

Interface group

LAN

| Select | Interfaces | Status |
|---------|---|---------|
| Default | LAN1,LAN2,LAN3,LAN4,wlan,wlan-vap0,wlan-vap1,wlan-vap2,wlan-vap3,a0 | Enabled |
| Group 1 | | -- |
| Group 2 | | -- |
| Group 3 | | -- |
| Group 4 | | -- |

3. Set as below.

Disable
 Enable

WAN

pppoe1

Interface group

a0
LAN1

LAN

LAN2
LAN3
LAN4
wlan
wlan-vap0
wlan-vap1
wlan-vap2

| Select | Interfaces | Status |
|---------|--|---------|
| Default | LAN1,LAN2,LAN3,LAN4,wlan,wlan-vap0,wlan-vap1,wlan-vap2,wlan-vap3,a0,pppoe1 | Enabled |
| Group 1 | | -- |
| Group 2 | | -- |
| Group 3 | | -- |
| Group 4 | | -- |

4. Click **Apply** and you'll see the following screen.

Disable Enable

WAN

Interface group

Add >

< Del

LAN

| Select | Interfaces | Status |
|-------------------------------|--|---------|
| Default | LAN2, LAN3, LAN4, wlan, wlan-vap0, wlan-vap1, wlan-vap2, wlan-vap3, pppoe1 | Enabled |
| Group 1 <input type="radio"/> | LAN1, a0 | Enabled |
| Group 2 <input type="radio"/> | | -- |
| Group 3 <input type="radio"/> | | -- |
| Group 4 <input type="radio"/> | | -- |

5. Click Save, Now you can use LAN1 interface for IPTV and other Ethernet interface for internet.



Note: If you want to cancel all modification that you do on the Router, please select from “Admin⇒Commit/Reboot⇒Factory Default Configuration⇒Reboot” to restore factory default settings.

5.4.3 Reset Router

1. On the Rear Panel of the ADSL router you will find a small hole with the word "reset" written below it. It's just big enough for a ball-point tip. Insert a ball-point tip into this little hole (actually it's a reset switch) and keep the ball-point tip in there.
2. You can release the ball-point after about 5 seconds. You have then completed the full-reset. Your ADSL router will now have its factory default settings. IP address will be 192.168.1.1 and the subnet mask will be 255.255.255.0. User name will be admin and password will be admin.

Appendix Frequent Asked Questions

Q: None of the LEDs are on when you power on the ADSL router?

A: Please make sure what you use is the power adaptor attached with the ADSL router package, and check the connection between the AC power and ADSL router.

Q: DSL LED does not turn on after connect telephone line?

A: Please make sure what you use is the standard telephone line (as attached with the package), make sure the line is connected correctly and check whether there is poor contact at each interface. Wait for 30 seconds to allow the ADSL router establishes connection with you ADSL operator.

Q: DSL LED is in the circulation of slow-flashing and fast-flashing after connect telephone line?

A: This situation means the ADSL router is in the status of failing to establish connection with Central Office. Please check carefully and confirm whether the ADSL router has been installed correctly.

Q: LAN LED does not turn on after connect Ethernet cable?

A: Please make sure Ethernet cable is connected hub/PC and ADSL router correctly. Then please make sure the PC/hub have been power on.

Please make sure that you use parallel network cable to connect UpLink port of hub, or use parallel network cable to connect PC. If connect normal port of hub (not UpLink port), you must use cross-cable. Please make sure that your network cables meet the networking requirements above.

Q: PC cannot access the Internet?

A: First check whether PC can ping the interface Ethernet IP address of this product successfully (default value is 192.168.1.1) by using ping application. If ping application fails, please check the connection of Ethernet cable and check whether the states of LEDs are in gear.

If the PC uses private IP address that is set manually (non-registered legal IP address), please check:

1. Whether IP address of the PC gateway is legal IP address. Otherwise please use the right gateway, or set the PC to Obtain an IP address automatically.
2. Please confirm the validity of DNS server appointed to the PC with ADSL operator. Otherwise please use the right DNS, or set the PC to Obtain an IP address automatically.
3. Please make sure you have set the NAT rules and convert private IP address to legal IP address. IP address range of the PC that you specify should meet the setting range in NAT rules.

Central Office equipment may have problem.

Q: PC cannot browse Internet web page?

A: Please make sure DNS server appointed to the PC is correct. You can use ping application program to test whether the PC can connect to the DNS server of the ADSL operator.

Q: Initialization of the PVC connection failed?

A: Be sure that cable is connected properly from the DSL port to the wall jack. The DSL LED on the front panel of the ADSL router should be on. Check that your VPI, VCI, type of encapsulation and type of multiplexing setting are the same as what you collected from your service provider, Re-configure ADSL router and reboot it. If you still can not work it out, you may need to verify these variables with the service provider.

If the cause is not given above, please contact your local service provider!