

Use & Care Guide
Manual de Uso y Cuidado
English / Español

Model/Modelo: 790.9761*

Kenmore®

Double Oven Electric Range Estufa de eléctrica con un doble horno

* = color number, número de color

P/N 808574610 Rev. A

Sears Brands Management Corporation
Hoffman Estates, IL 60179 U.S.A.
www.kenmore.com
www.sears.com



Table of Contents

KENMORE LIMITED WARRANTY	2	Setting Oven Controls	13
Before Setting Surface Controls	8	Care and Cleaning	25
Setting Surface Controls.....	10	Before You Call	29
Before Setting Oven Controls	12		

KENMORE LIMITED WARRANTY

FOR ONE YEAR from the date of sale this appliance is warranted against defects in material or workmanship when it is correctly installed, operated and maintained according to all supplied instructions.

WITH PROOF OF SALE, a defective appliance will receive free repair or replacement at option of seller.

To arrange for warranty service, call 1 800-4-MY-HOME® (1-800-469-4663).

This warranty applies for only 90 DAYS from the sale date in the United States, and is void in Canada, if this appliance is ever used for other than private household purposes.

This warranty covers ONLY defects in material and workmanship, and will NOT pay for:

1. Cracks in a ceramic glass cooktop that are not a result of thermal shock.
2. Stains and scratches on a ceramic glass cooktop resulting from accident or improper operation or maintenance.
3. Expendable items that can wear out from normal use, including but not limited to filters, belts, screw-in base light bulbs and bags.
4. A service technician to instruct the user in correct product installation, operation or maintenance.
5. A service technician to clean or maintain this product.
6. Damage to or failure of this product if it is not installed, operated or maintained according to all instructions supplied with the product.
7. Damage to or failure of this product resulting from accident, abuse, misuse or use for other than its intended purpose.
8. Damage to or failure of this product caused by the use of detergents, cleaners, chemicals or utensils other than those recommended in all instructions supplied with the product.
9. Damage to or failure of parts or systems resulting from unauthorized modifications made to this product.

Disclaimer of implied warranties; limitation of remedies

Customer's sole and exclusive remedy under this limited warranty shall be product repair or replacement as provided herein. Implied warranties, including warranties of merchantability or fitness for a particular purpose, are limited to one year or the shortest period allowed by law. Seller shall not be liable for incidental or consequential damages. Some states and provinces do not allow the exclusion or limitation of incidental or consequential damages, or limitation on the duration of implied warranties of merchantability or fitness, so these exclusions or limitations may not apply to you.

This warranty applies only while this appliance is used in the United States or Canada*.

This warranty gives you specific legal rights, and you may also have other rights which vary from state to state.

* In-home repair service is not available in all Canadian geographical areas, nor will this warranty cover user or servicer travel and transportation expenses if this product is located in a remote area (as defined by Sears Canada Inc.) where an authorized servicer is not available.

Sears Brands Management Corporation, Hoffman Estates, IL 60179

Sears Canada Inc., Toronto, Ontario, Canada M5B 2C3

IMPORTANT SAFETY INSTRUCTIONS

Read all instructions before using this appliance.

This manual contains important safety symbols and instructions. Pay attention to these symbols and follow all instructions given.

Do not attempt to install or operate your appliance until you have read the safety precautions in this manual. Safety items throughout this manual are labeled with a WARNING or CAUTION statement based on the hazard type.

DEFINITIONS

⚠ This is the safety alert symbol. It is used to alert you to potential personal injury hazards. Obey all safety message that follow this symbol to avoid possible injury or death.

⚠ WARNING - Indicates a potentially hazardous situation which, if not avoided, may result in death or serious injury.

⚠ CAUTION - Indicates a potentially hazardous situation which, if not avoided, may result in minor or moderate injury.

Important: Indicates installation, operation, maintenance, or valuable information not hazard related.

⚠ WARNING Storage in or on appliance—Flammable materials should not be stored in an oven. This includes paper, plastic, and cloth items, such as cookbooks, plastic ware, and towels, as well as flammable liquids. Do not store explosives, such as aerosol cans, on or near the oven.

⚠ WARNING Do not leave children alone or unattended in the area where appliance is in use. They should never be allowed to sit or stand on any part of the appliance, including the storage drawer, lower broiler drawer, warmer drawer, or lower double oven.

⚠ WARNING When heating fat or grease, watch it closely. Grease may catch fire if it becomes too hot.

⚠ WARNING Stepping, leaning, or sitting on the door or drawers of an oven can result in serious injuries and also cause damage to the appliance. Do not allow children to climb or play around the oven. The weight of a child on an open oven door may cause the oven to tip, resulting in serious burns or other injury.

⚠ WARNING Tip Over Hazard

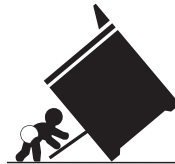

- A child or adult can tip the range and be killed.
- Verify the anti-tip device has been installed to floor or wall.

- Ensure the anti-tip device is re-engaged to floor or wall when the range is moved.
- Do not operate the range without the anti-tip device in place and engaged.
- Failure to follow these instructions can result in death or serious burns to children and adults.



Range leveling leg

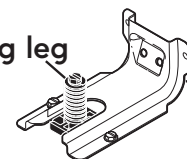

Anti-tip bracket

To check if the anti-tip bracket is installed properly, use both arms and grasp the rear edge of the range back. Carefully attempt to tilt range forward. When properly installed, the range should not tilt forward.

Refer to the anti-tip bracket installation instructions supplied with your range for proper installation.

⚠ WARNING Never cover any slots, holes, or passages in the oven bottom or cover an entire oven rack with materials, such as aluminum foil. Aluminum foil linings may trap heat, causing a fire hazard.

IMPORTANT SAFETY INSTRUCTIONS

Read all instructions before using this appliance.

⚠ WARNING Do not store items of interest to children in the cabinets above a range on the backguard of the ranges. Children climbing on the range to reach items could be seriously injured.

⚠ CAUTION Do not use water or flour on grease fires. Cover the fire with a pan lid, use baking soda, or use a dry chemical or foam type extinguisher.

⚠ CAUTION Wear proper apparel when cooking. Loose-fitting or hanging garments should never be worn while using this appliance. Do not let clothing or other flammable materials come into contact with hot surfaces.

⚠ CAUTION Use dry potholders. Moist or damp potholders on hot surfaces may result in burns from steam. Do not let potholders touch hot cooking areas. Do not use towels or other bulky cloths.

Important: The California Safe Drinking Water and Toxic Enforcement Act requires the governor of California to publish a list of substances known to cause cancer, birth defects, or other reproductive harms, and it requires businesses to warn customers of potential exposures to such substances.

⚠ CAUTION Do not touch heating elements or interior surfaces of oven. Heating elements may be hot even though they are dark in color. Interior surfaces of ovens become hot enough to cause burns. During and after use, do not touch, or let clothing or other flammable materials contact heating elements or interior surfaces of oven until they have sufficient time to cool. Other surfaces of the appliance may become hot enough cause burns such as the oven door, windows, and the oven vent.

⚠ CAUTION Do not heat unopened food containers. Build-up of pressure may cause container to burst and result in injury.

⚠ WARNING Read and follow all the warnings, cautions and important notes regarding the instructions and precautions for unpacking, installing, and servicing your appliance.

Important note: Remove all tape and packaging before using the oven. Destroy the carton and plastic bags after unpacking the oven. Never allow children to play with packaging material.

- **Proper Installation**—Be sure your appliance is properly installed and grounded by a qualified technician in accordance with the National Electrical Code ANSI/NFPA No. 70 latest edition and local electrical code requirements. In Canada, install in accordance with CSA Standard C22.1, Canadian Electrical code, Part 1, and local electrical code requirements. Install only per installation instructions provided in the literature package for this oven.
- **User Servicing**—Do not repair or replace any part of the appliance unless specifically recommended in the manuals. All other servicing should be done only by a qualified technician. This reduces the risk of personal injury and damage to the oven.
- Ask your dealer to recommend a qualified technician and an authorized repair service. Know how to disconnect the power to the oven at the circuit breaker or fuse box in case of an emergency.
- Never modify or alter the construction of an oven by removing the leveling legs, panels, wire covers, anti-tip brackets/screws, or any other part of the oven.
- Remove the oven door from any unused oven if it is to be stored or discarded.

IMPORTANT SAFETY INSTRUCTIONS

Read all instructions before using this appliance.

- Do not attempt to operate the oven during a power failure. If the power fails, always turn off the oven. If the oven is not turned off and the power resumes, the oven will begin to operate again. Once the power resumes, reset the clock and oven function.
- Cold temperatures can damage the electronic control. When using this appliance for the first time, or when the appliance has not been used for an extended period of time, be sure the appliance has been in temperatures above 32°F (0°C) for at least 3 hours before turning on the power to the appliance.
- Be sure to have an appropriate foam-type fire extinguisher available, visible, and easily located near the appliance.
- Never leave surface elements unattended. Boil-overs may cause smoking and greasy spills may ignite. A pan that has boiled dry could be damaged and may damage the cooktop.
- Only certain types of glazed cookware, glass, ceramic, earthenware, or other types of glazed utensils are suitable for use on the cooktop. Improper cookware may break due to sudden changes in temperature. Check the cookware manufacturer's recommendations for cooktop use.
- When you are flaming foods under a ventilating hood, turn on the fan.

IMPORTANT INSTRUCTIONS FOR USING YOUR COOKTOP

- Know which knob or keypad controls each surface heating area. Place cookware with food on the cooking area before turning it on. Turn the cooking area off before removing the cookware.
- Use proper pan size. This appliance is equipped with one or more surface units of different sizes. Select cookware with flat bottoms that match the surface unit heating element. The use of undersized cookware may expose a portion of the heating element to direct contact and may result in the ignition of clothing or other items. Using the proper cookware on the cooking zone will improve efficiency.
- To reduce the risk of burns, ignition of flammable materials, and spills due to unintentional contact with the utensil, the utensil handles should be turned inward and not extend over other cooking areas.

IMPORTANT INSTRUCTIONS FOR CERAMIC GLASS COOKTOPS

- Do not cook on a broken cooktop. If the cooktop is broken, cleaning solutions and spills may penetrate the cooktop and create a risk of electric shock. Contact a qualified technician immediately.
- Clean cooktop with caution. If a wet sponge or cloth is used to wipe spills on a hot cooking area, be careful to avoid steam burns. Some cleaners can produce noxious fumes if applied to a hot surface.

IMPORTANT INSTRUCTIONS FOR USING YOUR OVEN

- Never use your appliance for warming or heating the room.
- Use care when opening oven door, lower oven door, or warmer drawer (some models). Stand to the side of the oven when opening the door of a hot oven. Let hot air or steam escape before you remove or replace food in the oven.

Save these instructions for future reference.

IMPORTANT SAFETY INSTRUCTIONS

Read all instructions before using this appliance.

- Keep oven vent ducts clear. Touching surfaces in this area when the oven is on may cause severe burns. Do not place plastic or heat-sensitive items on or near the oven vent. These items can melt or ignite.
- Always handle oven racks when the oven is cool. Place oven racks in desired positions while the oven is cool. If a rack must be moved while the oven is hot, use extreme caution. Use potholders and grasp the rack with both hands to reposition. Do not let potholders contact the hot heating elements in the oven. Remove all bakeware and utensils before moving the rack.
- Do not use a broiler pan without its insert. Do not cover the broiler insert with aluminum foil because exposed fat and grease could ignite.
- Do not use aluminum foil or other protective liners to line the oven bottom. Only use aluminum foil as recommended in this manual. Improper installation of these liners may result in risk of electric shock or fire.
- Do not cook food on the oven bottom. Always use proper bakeware and use the oven racks.

IMPORTANT INSTRUCTIONS FOR CLEANING YOUR OVEN

⚠ CAUTION Before manually cleaning any part of the oven, be sure all controls are turned off and the oven is cool. Cleaning a hot oven can cause burns.

- Clean the oven regularly to keep all parts free of grease that could catch fire. Do not allow grease to accumulate. Always follow the manufacturer's recommended directions for use of kitchen cleaners and aerosols. Be aware that excess residue from cleaners and aerosols may ignite causing damage and injury.
- Clean ventilating hoods frequently. Grease should not be allowed to accumulate on the hood or filter. Follow the manufacturer's instructions for cleaning hoods.

SELF CLEANING OVENS

- Use the self clean cycle to clean only the parts listed in this manual. Before using self clean, remove the broiler pan, any food, utensils, and bakeware from the oven. Remove oven racks unless otherwise instructed.
- Do not use oven cleaners. No commercial oven cleaner, oven liner, or protective coating of any kind should be used in or around any part of the oven.
- Do not clean the oven door gasket. The door gasket is essential for a good seal. Do not rub, damage, or move the gasket.
- Some birds are extremely sensitive to the fumes given off during the self clean cycle of any oven. Move birds to another well-ventilated room.

Save these instructions for future reference.

IMPORTANT SAFETY INSTRUCTIONS

Read all instructions before using this appliance.

GROUNDING INSTRUCTIONS

⚠ WARNING Grounding Instructions Avoid fire hazard or electrical shock. Failure to follow this warning may cause serious injury, fire, or death.

For personal safety, this appliance must be properly grounded. For maximum safety, the power cord must be plugged into an electrical outlet that is the correct voltage, is correctly polarized and properly grounded in accordance with local codes. It is the personal responsibility of the consumer to have the appropriate outlet with the correct, properly grounded wall receptacle installed by a qualified electrician. It is the responsibility and obligation of the consumer to contact a qualified installer to assure that the electrical installation is adequate and is in conformance with all local codes and ordinances.

See the installation instructions packaged with this appliance for complete installation and grounding instructions.

Serial Plate Location

You will find the model and serial number printed on the serial plate. The serial plate is located as shown.

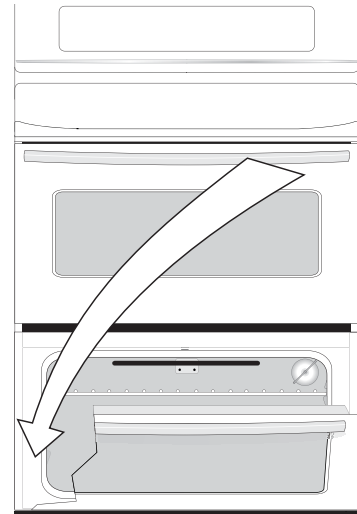

Figure 1: Location of serial plate

Product Record

In this space below, record the date of purchase, model and serial number of your product. You will find the model and serial number printed on the serial plate.

ModelNo. _____

SerialNo. _____

Date of purchase _____

Save these instructions for future reference.

Before Setting Surface Controls







Using Proper Cookware

The size and type of cookware used will influence the radiant element power level setting needed for best cooking results.

Be sure to follow the recommendations for using proper cookware shown on this page.

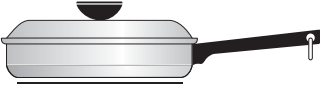

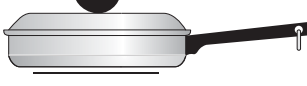
Figure 2: Check pan for flat bottom using ruler

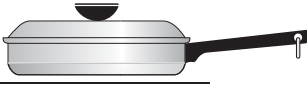
	
	
<ul style="list-style-type: none">• Flat bottom and straight sides.• Tight fitting lids.• Weight of handle does not tilt pan. Pan is well balanced.• Pan sizes match the amount of food to be prepared and the size of the surface element.• Made of material that conducts heat well.• Easy to clean.• Always match pot diameter to element size.	<ul style="list-style-type: none">• Curved and warped pans.• Cookware larger than cooking area marked on cooktop by more than one-half inch or 12mm.• Heavy handle tilts pan.• Pan is smaller than the heating area marked on cooktop.
	
	

Cookware Material Types

The cookware material determines how evenly and quickly heat is transferred from the surface element to the pan bottom.

Aluminum - Excellent heat conductor. Some types of food will cause it to darken (anodized aluminum cookware resists staining and pitting). If aluminum pans slide across the ceramic cooktop, they may leave metal marks which will resemble scratches. Remove these marks immediately.

Copper - Excellent heat conductor but discolors easily. May leave metal marks on ceramic glass (see Aluminum).

Stainless - Slow heat conductor with uneven cooking results. Is durable, easy to clean and resists staining.

Cast Iron - A slow heat conductor however will retain heat very well. Cooks evenly once cooking temperature is reached. Not recommended for use on ceramic cooktops.

Porcelain-enamel on metal - Heating characteristics will vary depending on base material. Porcelain-enamel coating must be smooth to avoid scratching the ceramic cooktop.

Glass - Slow heat conductor. Not recommended for ceramic cooktop surfaces because it may scratch the glass.

CAUTION Do not place empty aluminum, glass or porcelain-enamel coated cookware on the ceramic cooktop. The melting point of cookware made with these materials may be reached quickly especially if left empty and they may bond to the ceramic cooktop and will damage the cooktop. Be sure to follow all the cookware manufacturer's suggestions when using any type of cookware on the ceramic cooktop.

About the Ceramic Glass Cooktop

The ceramic cooktop has radiant surface elements located below the surface of the glass. The cooktop outlines the area of the surface element underneath. Be sure to match the pan size with the diameter of the element outline and use only flat-bottomed cookware. The type and size of cookware, the number of surface elements in use, and their settings are all factors that will affect the amount of heat that will spread to areas beyond the surface elements. The areas surrounding the elements may become hot enough to cause burns.

About the Radiant Surface Elements

The element temperature rises gradually and evenly. As the temperature rises, the element will glow red. To maintain the selected setting the element will cycle on and off. The heating element retains enough heat to provide a uniform and consistent heat during the off cycle. For efficient cooking, turn off the element several minutes before cooking is complete. This will allow residual heat to complete the cooking process.

⚠ CAUTION Radiant surface elements may appear to have cooled after they have been turned off. The glass surface may still be hot and burns may occur if the glass surface is touched before it has cooled sufficiently.

⚠ CAUTION Do not place plastic items such as salt and pepper shakers, spoon holders or plastic wrappings on top of the range when it is in use. These items could melt or ignite. Potholders, towels or wooden spoons could catch fire if placed too close to the surface elements. Do not allow aluminum foil, empty glass-porcelain cookware or any material that can melt to make contact with the ceramic cooktop. If these items melt on the cooktop they may damage the ceramic cooktop.

Element On and Hot Surface Indicator Lights

Your appliance is equipped with different types of surface indicator lights that will glow on the control panel. The element on indicator light will turn on when the surface element is turned on and will turn off when the surface element is turned off. The hot surface indicator light will turn on when the glass cooktop is hot and will continue to glow until the glass cooktop has cooled down to a moderate level. The light may remain on even though the controls are turned off.

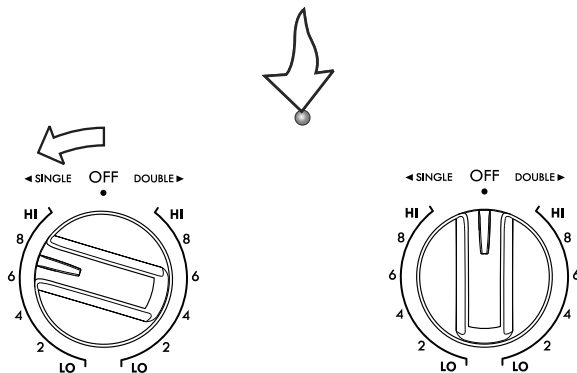

Figure 3: Element on and hot surface indicator light

Important notes:

- Radiant elements have a limiter that allows the radiant heating element to cycle on and off, even at the HI setting. Cycling at the HI setting is normal and will occur more often if the cookware is too small for the radiant element or if the cookware bottom is not flat.
- Be sure to read the detailed instructions for ceramic glass cooktop maintenance and cleaning in the “Care and Cleaning” and “Before You Call” sections of this Use and Care Guide.

Types of Cooktop Surface Elements

The ceramic glass cooktop has radiant surface elements located below the surface of the glass. The patterns on the ceramic glass will outline the size and type of element available.

The single radiant element or elements will have one round outline pattern shown on the cooktop.

The warmer zone feature (on some models), located on the center rear area of the cooktop, uses one round outline and is designed to keep food warm only.

A dual radiant element (on some models) allows the user to set the smaller inner portion as a single element or both inner and outer portions may be set to heat together.

Home Canning

Be sure to read and observe all the following points when home canning with your appliance. Check with the United States Department of Agriculture (USDA) website and be sure to read all the information they have available as well as follow their recommendations for home canning procedures.

Tips and procedures for canning foods:

- Use only quality flat bottom canners when home canning. Use a straight-edge to check canner bottom.
- Use only a completely flat bottom canner with no ridges that radiate from the bottom center when home canning using a ceramic cooktop.
- Make sure the diameter of the canner does not exceed 1 inch beyond the surface element markings or burner. It is recommended to use smaller diameter canners on electric coil and ceramic glass cooktops. Start with hot tap water to bring water to boil more quickly.
- Use the highest heat seating when first bringing the water to a boil. Once boiling is achieved, reduce heat to lowest possible setting to maintain that boil.
- Never place or straddle a cooking utensil over two different surface cooking areas at the same time. This will cause uneven heating results and may cause the ceramic cooktop to fracture.

Setting Surface Controls

Radiant Surface Element Settings

The suggested settings below are based when cooking with medium-weight aluminum pans with lids. Settings may vary when using other types of pans.

Suggested settings for single and dual (some models) radiant surface elements:

Settings	Type of Cooking
High (HI-9)	Start most foods, bring water to boil, pan broiling
Medium high (7-8)	Continue a rapid boil, fry, deep fat fry
Medium (5-6)	Maintain a slow boil, thicken sauces and gravies, steam vegetables
Medium-low (2-4)	Keep foods cooking, poach, stew
Low (LO-1)	Keep warm, melt, simmer

CAUTION Radiant surface elements may appear to have cooled after they have been turned off. The glass surface may still be hot and burns may occur if the glass surface is touched before it has cooled sufficiently.

CAUTION Do not place plastic items such as salt and pepper shakers, spoon holders or plastic wrappings on top of the range when it is in use. These items could melt or ignite. Potholders, towels or wooden spoons could catch fire if placed too close to the surface elements.

CAUTION Do not allow aluminum foil, empty glass-porcelain cookware or any material that can melt to make contact with the ceramic cooktop. If these items melt on the cooktop they may damage the ceramic cooktop.

Single Radiant Surface Elements (all models)

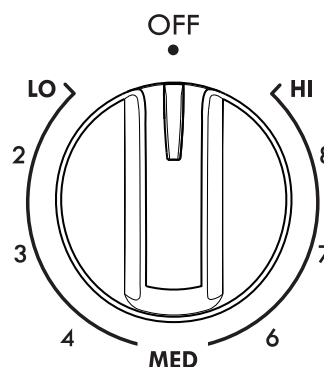

Figure 4: Single radiant element control

To operate the single radiant element:

1. Place correctly sized cookware on single radiant surface element.
2. Push in and turn the surface control knob in either direction to the desired setting (Figure 4).
3. When cooking is complete, turn the radiant surface element off before removing the cookware.

Important notes:

- For efficient cooking, turn off the element several minutes before cooking is complete. This will allow residual heat to complete the cooking process.
- The surface control knobs do not have to be set exactly on a particular spot. Use the graphics provided as a guide and adjust the control knob as needed. Each surface element provides a constant amount of heat at each setting.
- Refer to the suggested radiant surface element settings for suggested power level settings. A glowing red surface heating area extending beyond the bottom edge of the cookware indicates the cookware is too small for the surface heating area.
- Do not straddle cookware between two cooking elements unless the cookware and cooktop is designed for that purpose, such as bridges and griddles.

Dual Radiant Surface Element (some models)

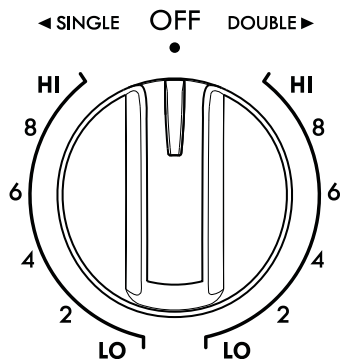

Figure 5: Dual radiant element control

⚠ CAUTION Radiant surface elements may appear to have cooled after they have been turned off. The glass surface may still be hot and burns may occur if the glass surface is touched before it has cooled sufficiently. Do not place plastic items such as salt and pepper shakers, spoon holders or plastic wrappings on top of the range when it is in use. These items could melt or ignite. Potholders, towels or wooden spoons could catch fire if placed too close to the surface elements.

⚠ CAUTION Do not allow aluminum foil, empty glass or porcelain cookware or any material that can melt to make contact with the ceramic cooktop. If these items melt on the cooktop they may damage the ceramic cooktop.

To operate the dual radiant element:

1. Place correctly sized cookware on single radiant surface element.
2. Push in and turn the surface control knob clockwise to begin heating both the inner and outer portions of the element. If only the inner heating portion is needed for smaller cookware, push in and turn the knob counter-clockwise to start.
3. When cooking is complete, turn the radiant surface element off before removing the cookware.

Important notes:

- Start most cooking operations on a higher setting and then turn to a lower setting to finish cooking.
- Radiant elements have a limiter that allows the radiant heating element to cycle on and off, even at the HI setting. This helps prevent damage to the ceramic smoothtop. Cycling at the HI setting is normal and will occur more often if the cookware is too small for the radiant element or if the cookware bottom is not flat.
- A glowing red surface heating area extending beyond the bottom edge of the cookware indicates the cookware is too small for the surface heating area.

Important note: Do not straddle cookware between two cooking elements unless the cookware and cooktop is designed for that purpose, such as bridges and griddles.

Before Setting Oven Controls

Oven Vent Location

The oven vent is located under the left side of the control panel (Figure 6). When the oven is on, warm air passes through this vent. This venting is necessary for proper air circulation in the oven and good baking results. It is normal for steam or moisture to appear near the oven vent. Do not block oven vent:

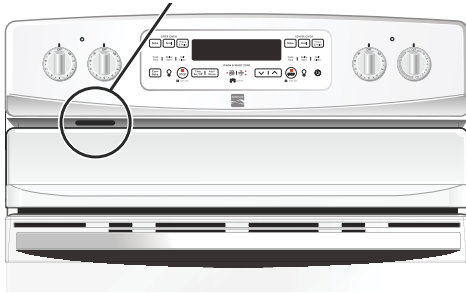

Figure 6: Oven vent location

CAUTION Protective Liners: Do not use aluminum foil to line the oven bottom, oven walls or oven racks. Doing so will alter heat distribution, produce poor baking results and may cause permanent damage to the oven interior. Only use aluminum foil as recommended in this manual. Improper installation of these liners may result in risk of electric shock, or fire.

CAUTION Always use pot holders or oven mitts when using the oven. When cooking, the oven interior and exterior, oven racks and cooktop will become very hot which can cause burns.

Removing, replacing, and arranging flat or offset oven racks

Important note: Always remove racks before starting a self clean cycle. Always wear oven mitts when handling racks in a hot oven.

- **To remove** - Pull the oven rack straight forward until it reaches the stop position. Lift up front of oven rack slightly and slide out.
- **To replace** - Place the oven rack on the rack guides on both sides of oven walls. Tilt the front of oven rack upward slightly and slide the oven rack back into place. Be sure oven racks are level before using the oven.
- **To arrange** - Always arrange the oven racks when the oven is cool (prior to operating the oven).

Types of Oven Racks

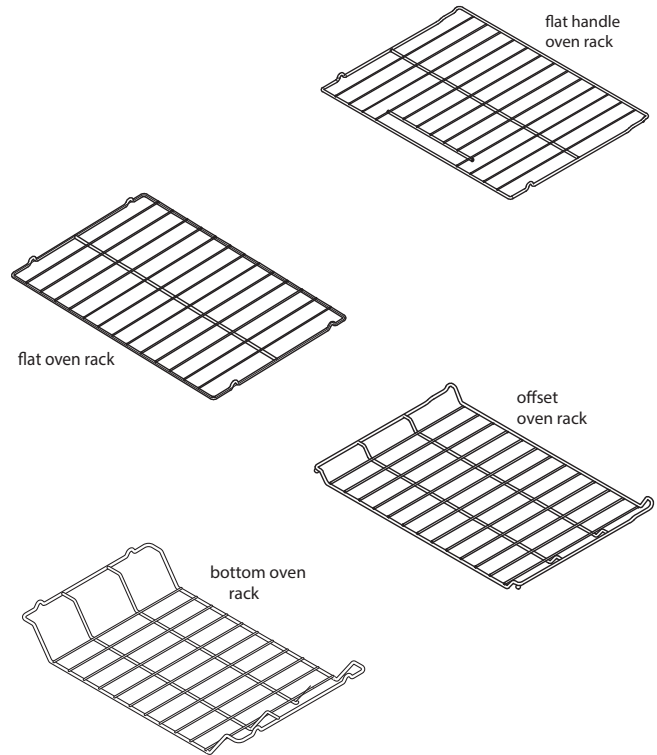

The flat oven rack (some models) or flat handle oven rack (some models) may be used for most cooking needs.

The offset oven rack (on some models) is designed to place the base of the rack about 1/2 of a rack position lower than flat oven racks. This design allows several additional positions between the flat rack positions.

To maximize oven cooking space place the bottom oven rack (on some models) in the lowest rack position for roasting large cuts of meat.

Air Circulation in the Oven

For best baking results allow 2-4" (5-10 cm) around the cookware for proper air circulation and be sure pans and cookware do not touch each other, the oven door, sides or back of the oven cavity. Hot air must be able to circulate around the cookware in the oven for even heat to reach around the food.

Setting Oven Controls

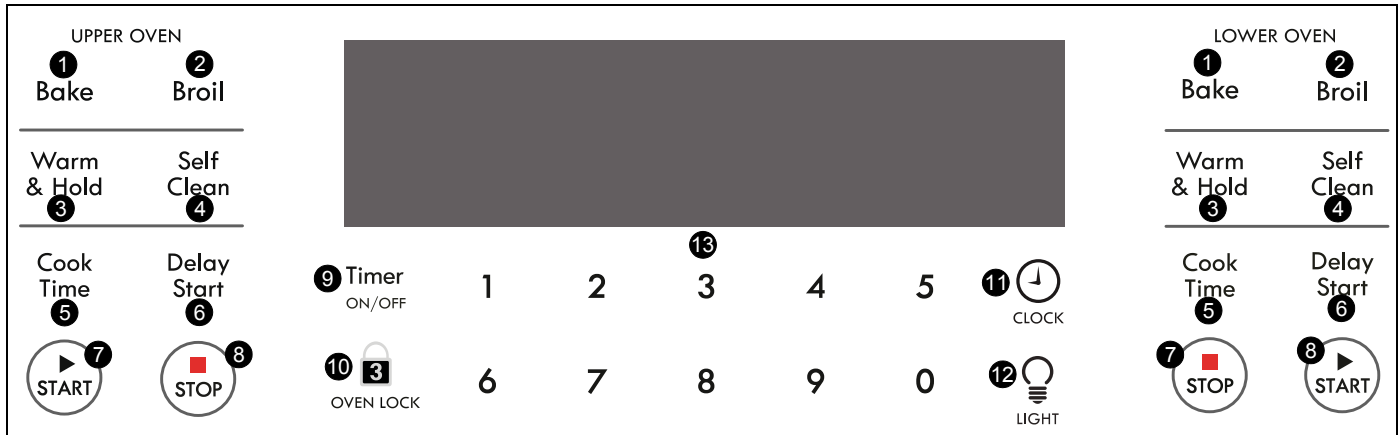

UPPER AND LOWER OVEN SETTINGS

- 1. Bake** - Used to enter the normal bake feature.
- 2. Broil** - Used to select variable broil feature.
- 3. Warm & Hold** - Used to set the Warm & Hold function.
- 4. Self Clean** - Used to set a 2 to 4 hours self clean cycle.
- 5. Cook Time** - Used to enter the length of the cook time desired.
- 6. Delay Start** - Used to set the desired start time for baking. May be used with cook time to program a delayed timed bake or clean cycle.
- 7. START** - Used to start all oven features (except oven light).
- 8. STOP** - Used to cancel any oven function except clock and timer.

OVEN FEATURES

- 9. Timer ON/Off** - Used to set or cancel timer. The minute timer does not start or stop cooking.
- 10. OVEN LOCK** - Used to lock the oven door.
- 11. CLOCK** - Used to set the time of day.
- 12. LIGHT** - Used to turn oven light on and off.
- 13. 0 thru 9 keypad** - Use to enter temperature and times.

Minimum and Maximum Control Settings



All of the features listed below have minimum and maximum time or temperature settings that may be entered into the control. An entry acceptance beep will sound each time a control key is touched (the oven lock is delayed 3 seconds).

An entry error tone (three short beeps) will sound if the entry of the temperature or time is below the minimum or above the maximum settings for the feature.

Feature	Min temp. or time	Max temp or time
Bake	170°F (77°C)	550°F (288°C)
Broil	400°F (205°C)	550°F (288°C)
Timer	1 Min.	11 Hrs. 59 Min.
Self Clean	2 hours	4 hours
Warm & Hold	170°F (77°C)	3 hours
Cook Time	1 Min.	11:59 Hr./Min.
Delay Time 12 Hr.	1 Min.	11:59 Hr./Min.
Delay Time 24 Hr.	0:01 Hr./Min.	23:59 Hr./Min.

Setting Oven Controls

Setting the Clock

 is used to set the clock. The clock may be set for 12 or 24 hour time of day operation. The clock has been preset at the factory for the 12 hour operation. When the range is first plugged in, or when the power supply to the range has been interrupted, the time in the display will flash. Press . The display will stop flashing.

To set the clock for 1:30:

1. Press . CLO will appear in the display.



Figure 7: Clock ready to set time of day



2. Press 1 3 0 using the numeric keypad to set time of day. Press .





Figure 8: Setting time of day

3. Time of day will now appear in the display.

Changing Between 12 or 24 Hour Time of Day Display

1. Press and hold  for 7 seconds until 12 Hr or 24 Hr appears in the display.
2. Press **Self Clean** to switch between the 12 and 24 hour time of day displays. The display will show either 12 Hr or 24 Hr.



3. Press  to accept the change or press  to reject.
4. Reset the correct time as prescribed in Setting the Clock above.

Note: if the 24 hour time of day was selected, the clock will now display time from 0:00 through 23:59 hours.

Setting Continuous Bake or 12 Hour Energy Saving

The **Timer ON/OFF** and **Self Clean** keys control the continuous bake or 12 hour energy saving features. The oven control has a factory preset 12 hour energy saving feature that shuts off the oven control if left on for more than 11 hours and 59 minutes. The oven can be programmed to override this feature for continuous baking.

To set the Continuous Bake or 12 Hour Energy feature:

1. Press and hold **Timer ON/OFF** for about 7 seconds. The dashes will change to show either 12Hr OFF or Stay On in the display and the control will beep once.



Figure 9: Display showing energy saving (top) and continuous bake features (middle). Once either is selected and start is pressed the display returns to show the time of day. (bottom)

2. Press **Self Clean** to switch between the 12 hr energy saving and continuous bake features.
3. Press  to accept your selection and the display will return to show the time of day.

Note: 12 Hr OFF indicates the control is set for the 12 hour energy saving mode. Stay On indicates the control is set for the continuous bake mode.

Setting Oven Timer

The **Timer ON/OFF** controls the timer and serves as an extra timer that will beep when the set time has run out. It does not start or stop cooking. The timer can be used during any of the other oven control functions, except self clean and Sabbath.

To set timer for 5 minutes:

1. Press **Timer ON/OFF**. When dashes appear in the display press the number 5 key and press . The timer will begin to count down.



Figure 10: Dashes appear in display before timer is set



Figure 11: Timer set for 5 minutes

Note: If the start key is not pressed timer will return to time of day after 25 seconds.

2. When timer runs out the clock will beep three times every 7 seconds until **Timer ON/OFF** is pressed.

Note: Press **Timer ON/OFF** to cancel the timer at any time.

Setting the Oven Lock

The  **OVEN LOCK** controls the oven lock feature. The oven lock automatically locks both oven doors and prevents the oven from being turned on. It does not disable the clock, timer or the interior oven light.

To activate the oven lock feature:

1. Press and hold  **OVEN LOCK** for 3 seconds.
2. After 3 seconds, **DOOR, LOCKED** will flash and **LOCKED** will appear in the display



Figure 12: Oven door in locking mode

Once the oven door is locked the **DOOR** and **LOCKED** indicator will stop flashing and remain in the display. Allow 15 seconds for the oven door to lock.

Note: Pressing the **OVEN LOCK** key locks both ovens.

Important: Do not attempt to open the oven door while it is locking or unlocking as this may ruin the automatic door locking mechanism.

To reactivate normal oven operation by unlocking door:

1. Press and hold  **OVEN LOCK** for 3 seconds. **LOCKED** will disappear from the display. **DOOR** and **LOCKED** will flash in the display until the door has completely unlocked and the oven will be operational.

Setting Oven Controls

Setting Silent Control Operation

The **Self Clean** and **Delay Start** keys control the silent control operation feature. The silent control operation feature allows the oven control to be operated without sounds or beeps whenever necessary. If desired the control can be programmed for silent operation and later returned to operating with all the normal sounds and beeps.

To change from normal sound to silent operation:

1. Press and hold **Delay Start** for 6 seconds. The display will show dashes and then change to **bEEP ON** in the display.





Figure 13: Display changes from dashes to show controls set for audible operation

2. Press **Self Clean** to switch between normal sound operation and silent mode (beep off).



Figure 14: Control in bEEP OFF setting allows for silent operation of oven controls

3. Press  to accept the change or press  to reject the change.

Note: The control will always beep at the end of a timer and will beep when a set temperature has been reached, even if the control is set to silent operation.

Setting Temperature Display for Fahrenheit or Celsius



The **Broil** and **Self Clean** keys control the Fahrenheit or Celsius temperature display modes. The oven control can be set to display temperatures in Fahrenheit or Celsius. The oven has been preset at the factory to display in Fahrenheit.

Note: Both ovens will be changed at the same time.

To change display from Celsius to Fahrenheit or Fahrenheit to Celsius:

1. Press and hold **BROIL** for about 6 seconds until it beeps and **F** or **C** appears in the display. The **F** means the oven is set for temperatures in Fahrenheit and when **C** is visible in the display it means the oven is set for temperatures in Celsius.



2. Press **Self Clean** and toggle to switch between Fahrenheit or Celsius modes.
3. Press  to accept the change or press  to reject the change.

Operating Oven Lights

The interior oven lights will turn on when the oven door is opened.

Press  to turn oven light on an off whenever the oven door is closed.

The interior oven light is located on the left side of the oven interior and are covered with a glass shield. The glass shield protects the bulb from high temperatures and should always be in place whenever the oven is in use.

Note: The oven light will not operate during a self clean operation.

To replace the interior oven lights, see [“Replacing the Oven Light”](#) in the [“Care and Cleaning”](#) section.

Setting Bake

Use the bake feature whenever the recipe calls for baking using normal temperatures. A reminder tone will sound indicating when the set bake temperature is reached and to place the food in the oven. During preheating, the oven temperature will appear in the display along with the bake icon. The bake element indicator light will cycle on and off during the cooking process.

Bake may be set for any temperature between 170°F (77°C) to 550°F (288°C).

To set bake for oven temperature of 425°F (218°C):

1. Press **Bake** in upper or lower oven.
2. Enter **4 2 5** using numeric keys.
3. Press **START**.

To cancel bake at any time press .

For best results:

- Fully preheat the oven before baking items like cookies, biscuits and breads.
- Dark or dull pans absorb more heat than shiny bakeware, resulting in dark or overbrowning of foods. It may be necessary to reduce the oven temperature or cook time to prevent overbrowning of some foods. Dark pans are recommended for pies. Shiny pans are recommended for cakes, cookies and muffins.
- Do not open oven door often. Opening the door will reduce the temperature in the oven and may increase cook time.

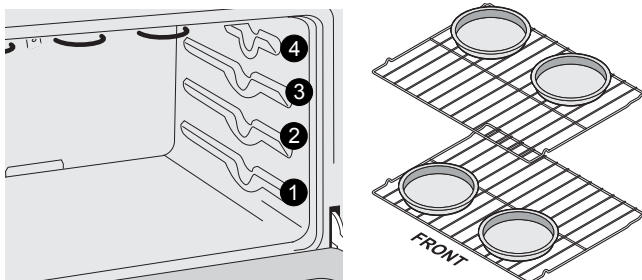

Figure 15: Rack positions and pan spacing recommendations

Radiant rack positions:

- When using any single rack, position the rack so that the food is in the center of the oven.
- When baking using two oven racks, position bakeware as shown in Figure 15. Place the top rack in position 3 and the bottom rack in position 1. Allow at least 2 inches (5 cm) of space between bakeware for proper air circulation and use the offset rack (if available) in the bottom position.

Setting Cook Time

The **Cook Time** key controls the cook time feature. The automatic timer of the cook time feature will turn the oven off after cooking for the desired amount of time you selected.

To program the oven to begin baking at 350° (177°C) immediately and to shut off automatically after 30 minutes:

1. Be sure the clock is set for the correct time of day. Arrange oven racks and place food in oven.
2. Press **Bake**. The default temperature of 350 will appear in the display.



Figure 16: Display showing set temperature of 350

3. Press .
4. Press **Cook Time**.
5. Enter desired bake time by pressing **30** using numeric keys.

Note: Baking time can be set for any time between 1 minute and 11 hours and 59 minutes..



Figure 17: Bake time set for 30 minutes



6. Press . The display returns to the time of day.



Figure 18: Display shows time of day and the actual oven temperature above the oven icon

A beep will sound once the oven has reached the set temperature.

While baking, press **Cook Time** to display the bake time remaining in the timed bake mode. When the bake time finishes, **END** and the time of day will show in the display and the oven turns off automatically. The control will beep three times and continue to beep every 30 seconds until  is pressed.

Setting Oven Controls

Setting Delay Start

The **Delay Start** feature (when combined with a cook time) will turn the oven on and off at the time you select in advance.

Note: If the clock is set for normal 12 hour display mode the delayed time bake or delayed timed convection bake cycle can not be set to start more than 12 hours in advance.

⚠ CAUTION Food poisoning hazard. Do not let food sit for more than one hour before or after cooking. Doing so can result in food poisoning or sickness. Foods that can easily spoil such as milk, eggs, fish, meat or poultry, should be chilled in the refrigerator first. Even when chilled, they should not stand in the oven for more than 1 hour before cooking begins, and should be removed promptly when finished cooking.

To program the oven for a delay start bake time of 30 minutes and to start at 5:30:

1. Be sure that the clock is set with the correct time of day.
2. Press **Bake**. The default temperature of 350 will appear in the display.



Figure 19: Oven ready to set at default temperature

3. Press **START**.
4. Press **Cook Time**.



Figure 20: Dashes appear showing oven control ready for cook time to be entered

5. Enter the desired baking time by using the numeric keypad and pressing **30**.



Figure 21: Cook time entered

6. Press **START**.
7. Press **Delay Start**. Dashes will appear in the display ----.

8. Enter **5 3 0** using the numeric keypad.



Figure 22: Oven set to start cooking at 5:30

9. Press **START**. The current time of day will appear in the display.

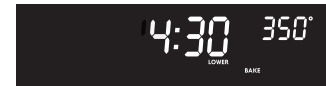

10. When the desired start time is reached, the oven turns on. The oven icon will appear in the display and the oven will start to bake at the previously selected temperature.
11. Press **STOP** when baking is finished or at any time to cancel the delayed time bake feature.

When the bake time runs out:

12. **END** will appear in the display and the oven will turn off automatically.



13. The control will beep three times. The control will continue to beep three times every 30 seconds until **STOP** is pressed.

Setting Broil

The **Broil** key controls the broil feature. When broiling, heat radiates downward from the oven broiler for even coverage. The broil temperature may be set between 400°F (205°C) and 550°F (288°C).

The broil pan and broil pan insert used together allow dripping grease to drain and be kept away from the high heat of the oven broiler (Figure 23). Do not use the broil pan without the insert. Do not cover the broil pan insert with foil. The exposed grease could catch fire.

CAUTION The broil burner may appear to have cooled after it has been turned off. The burners may still be hot and burns may occur if these burners are touched before they have cooled sufficiently. Always use oven mitts when working with a hot oven.

WARNING Should an oven fire occur, leave the oven door closed and turn off the oven. If the fire continues, throw baking soda on the fire or use a fire extinguisher. Do not put water or flour on the fire. Flour may be explosive and water can cause a grease fire to spread and cause personal injury.

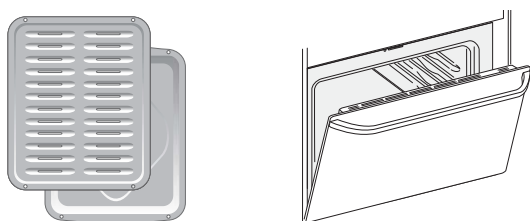

Figure 23: Broil pan and insert (L) Broil Stop position (R)

To set the oven to broil at 550°F.

1. Place the broiler pan insert on the broiler pan. Then place the food on the broiler pan insert.
2. Arrange the interior oven rack and place the broiler pan on the rack. Be sure to center the broiler pan directly under the broiler element. Make sure the oven door is open to the broil stop position when broiling (Figure 23).
3. Press **Broil**. Preheat the oven for 2 minutes.
4. If a lower broil temperature is desired (minimum broil temperature setting is 400°F), press the desired temperature before continuing to step 5.
5. Press **START**. The oven will begin the broil function.



Figure 24: Broil set for maximum heat

6. Broil on one side until food is browned then turn and cook on the second side. Season and serve.

Note: Always pull the rack out to the stop position before turning or removing food.

7. To cancel broiling or if finished broiling press **STOP**.

Important note: If a broiler pan and insert are not supplied with this appliance, they may be purchased from Sears. Order by calling 1-800-4-MY-HOME (1-800-469-4663) and order broiler pan kit 5304442087.

Food Item	Rack Position	Temperature	Cook time		Internal Temperature	Doneness
			1st side	2nd side		
Steak 1" thick	3rd or 4th*	550°F (288°C)	6:00	4:00	145°F (63°C)**	Medium-Rare
	3rd or 4th*	550°F (288°C)	7:00	5:00	160°F (71°C)	Medium
Pork Chops 3/4 "thick	3rd or 4th*	550°F (288°C)	8:00	6:00	170°F (77°C)	Well
Chicken - Bone In	3rd	450°F (232°C)	20:00	10:00	170°F (77°C)	Well
Chicken Boneless	3rd or 4th*	450°F (232°C)	8:00	6:00	170°F (77°C)	Well
Fish	3rd	500°F (260°C)	As directed As directed		170°F (77°C)	Well
Shrimp	3rd	550°F (288°C)			170°F (77°C)	Well
Hamburger 1" thick	3rd or 4th*	550°F (288°C)	9:00	7:00	160°F (71°C)	Medium
	3rd or 4th*	550°F (288°C)	10:00	8:00	170°F (77°C)	Well

*When broiling in the top oven rack position use an offset oven rack.

** The U.S. Department of Agriculture states, "Rare fresh beef is popular, but you should know that cooking it to only 140°F (60°C) means some food poisoning organisms may survive." (Source: Safe Food Book, Your Kitchen Guide, USDA Rev. June 1985.)

The lowest temperature recommended by the USDA is 145°F (63°C) for medium rare fresh beef. For well done 170°F (77°C)

Setting Oven Controls

Setting Warm & Hold™

The **Warm & Hold** key turns on the Warm & Hold feature that will maintain an oven temperature of 170°F (77°C).

The Warm & Hold feature will keep oven baked foods warm for serving up to 3 hours after cooking has finished. After 3 hours the feature will shut the oven off. Warm & Hold may be used without any other cooking operations or can be used after cooking has finished using bake and convection bake.

Warm & Hold may be used with timed bake if you wish to have the feature turn on automatically when cooking has finished. The timed bake features require you to set start time and the amount of cooking time. With this information the control can calculate the time when cooking will complete and can then start Warm & Hold automatically.

⚠ CAUTION Food poisoning hazard. Do not let food sit for more than one hour before or after cooking. Doing so can result in food poisoning or sickness. Foods that can easily spoil such as milk, eggs, fish, meat or poultry, should be chilled in the refrigerator first. Even when chilled, they should not stand in the oven for more than 1 hour before cooking begins, and should be removed promptly when finished cooking.

To set Warm & Hold:

1. Arrange oven racks and place food in desired oven.
2. Press **Warm & Hold**. **Hld** will appear in the display.



Figure 25: Oven with Warm & Hold selected

Note: If no key is touched within 25 seconds, the request to turn on the Warm & Hold feature will be cancelled.

3. Press **START**. **Hld** will remain on and the oven icon will appear in the display.



Figure 26: Oven set for Warm & Hold

4. To cancel Warm & Hold at any time press **STOP**.

Note: The feature will automatically turn off after 3 hours.

To set Warm & Hold to turn on automatically after a timed cooking function:

1. Arrange oven racks and place food in oven.
2. Set oven for timed bake or delayed timed bake.
3. Press **Warm & Hold**. **Hld** will appear in the display.



Figure 27: Warm & Hold set to begin after timed bake

Note: If no key is touched within 25 seconds, the request to turn on the Warm & Hold feature will be cancelled.

4. Press **START**. **WARM** will stop flashing and the programmed temperature will appear in the display.
5. When the timed bake has finished, Warm & Hold will turn on automatically and remain on for 3 hours unless cancelled.



Figure 28: Warm & Hold shown active in display

Pressing **STOP** at any time will stop all oven baking operations.

Setting the Sabbath Feature (for use on Jewish Sabbath and Holidays)



The **Cook Time** and **Delay Start** keys are used to set the Sabbath feature. For further assistance, guidelines for proper usage, and a complete list of models with the Sabbath feature, please visit the web at www.star-k.org.

The Sabbath feature may only be used with the bake function. Once the oven is properly set using bake with the Sabbath feature active, the oven will remain on until cancelled. The Sabbath feature overrides the factory preset 12 hour energy saving feature.

Important: The bake function can be set for the upper or lower oven or both before entering Sabbath. If the oven light is needed during the Sabbath, press **LIGHT** before activating the Sabbath feature. Once the oven light is turned on and the Sabbath feature is active, the oven light will remain on until the Sabbath feature is turned off. If the oven light needs to be off, be sure to turn the oven light off before activating the Sabbath feature. During Sabbath mode all normal sounds of the control will be turned off and no acceptance tones will sound.

CAUTION Food poisoning hazard. Do not let food sit for more than one hour before or after cooking. Doing so can result in food poisoning or sickness. Foods that can easily spoil such as milk, eggs, fish, meat or poultry, should be chilled in the refrigerator first. Even when chilled, they should not stand in the oven for more than 1 hour before cooking begins, and should be removed promptly when finished cooking.

To program the oven to begin baking immediately and to activate the Sabbath feature (example: baking at 350°F):

1. Be sure that the clock is set to correct time of day and place food in oven.
2. Press **Bake**. The display will show **350**.



3. Press **START**.

Important: If you desire to set the oven control for a cook time or delay start do so at this time. Refer to the “[Setting Cook Time](#)” or “[Setting Delay Start](#)” section for complete instructions. Remember the oven will shut down after using cook time or delay start and therefore may only be used once during the Sabbath and Jewish Holidays. The maximum delay start time is 11 hours and 59 minutes. If setting for Sabbath to start cooking immediately, skip to the next step.

4. The oven will turn on and begin heating. If you need to set both ovens for the Sabbath, both should be set at this time.
5. Press and hold both the **Cook Time** and **Delay Start** keys for at least 3 seconds. **SAb** will appear in the display. Once **SAb** appears in the display the oven control will no longer beep or display any further changes. The oven is properly set for the Sabbath feature.



Note: You may change the oven temperature once baking has started. Press **BAKE**, enter the oven temperature change (170°F to 550°F) and then press **START** twice (for Jewish Holidays only). Remember that the oven control will no longer beep or display any further changes once the oven is set for the Sabbath feature.

To exit the Sabbath feature:

The oven may be turned off at any time by first pressing **STOP** (this will turn the oven off only). To turn off the Sabbath feature press and hold both the **Cook Time** and **Delay Start** keys on the lower oven only for at least 3 seconds. This also turns off the oven. **SAb** will disappear from the display.

Power failure while using Sabbath feature:

Should you experience a power failure or interruption, the oven will shut off. When power is returned, **SF** (Sabbath Failure) will be displayed and the oven will not turn back on automatically. If your food was nearly fully cooked, you may allow the trapped heat in the oven to finish the cooking process. Otherwise, you should remove the food when the power failure occurs, because you may only start the oven once during the Sabbath and Jewish Holidays.

After the Sabbath observance turn off the Sabbath feature. Press and hold both the **Bake Time** and **Delay Start** keys for at least 3 seconds. **SAb** will disappear from the display and the oven may be used with all normal functions.

For further assistance, guidelines for proper usage, and a complete list of models with the Sabbath feature, please visit the web at www.star-k.org.

Setting Oven Controls

Adjusting Oven Temperature

The temperature in the oven is pre-set at the factory. Before adjusting, be sure to follow recipe times and temperatures. Test a recipe by using a temperature setting higher or lower than the recommended temperature. The baking results should help you to decide how much of an adjustment is needed.

Important: Do not use thermometers such as those found in grocery stores to check the temperature settings inside the oven. These thermometers may display temperatures that vary as much as 20 to 40 degrees from the actual temperature.

If you think the oven is cooking too hot or too cool for the temperature you select, you can adjust the actual oven temperature to be 35°F (19°C) more or 35°F less than the default setting of 0.

To adjust the oven temperature higher by 30°:

1. Press **Broil** for 6 seconds. **UPO 0** will appear in the display.
2. Press the numeric keys **3 0**.
3. Press  to accept the temperature change and the display will return to the time of day. Press **STOP** to reject the change if necessary.

To adjust the oven temperature lower by 30°:

1. Press **Broil** for 6 seconds. **UPO 0** will appear in the display.
2. Press the numeric keys **3 0**.
3. Press **Self Clean** to change the 30 to - 30.
4. Press  to accept the temperature change and the display will return to the time of day.
5. Press **STOP** to reject the change if necessary.

Restoring Factory Default Settings

Your appliance is programmed with default control settings. Over time, users may make changes to these settings. The following options have settings that can be modified and may have been changed since the appliance was new:

- 12 or 24 hour display mode
- Continuous bake or 12 hour energy savings mode
- Silent or audible control
- Oven temperature display (Fahrenheit or Celsius)
- Oven temperature adjustments (offsets)

Important: If you choose to restore factory default settings, all of the above user preferences will be restored to their original settings (factory default).

To restore oven control to factory default settings:

1. When the oven is in idle and no cooking function is in operation, press and hold the **7** key until the acceptance tone sounds (about 3 seconds).
2. Press **START**. The control is now reset to default settings.

Self Cleaning Oven

A self cleaning oven cleans itself with very high temperatures (well above cooking temperatures) which eliminate soils completely or reduces them to a fine powdered ash you can wipe away with a damp cloth.

Adhere to the following cleaning precautions

- Allow the oven to cool before cleaning.
- Before starting the self clean cycle, hand clean any soil from the oven frame, the door liner outside the oven door gasket, and the small area at the front center of the oven. These surfaces are not in the self cleaning area. Clean with soap and water. Burned-on residue can be cleaned off with a stiff nylon brush and water or nylon scrubber.
- Wear rubber gloves when cleaning any exterior parts of the oven manually.
- Do not use oven cleaners or oven protective coatings in or around any part of the oven interior.
- Do not clean the oven door gasket. The woven material of the oven door gasket is essential for a good seal. Care should be taken not to rub, damage or remove the gasket.
- Do not use any cleaning materials on the oven door gasket. Doing so could cause damage.
- Remove all utensils and any aluminum foil. These items cannot withstand high cleaning temperatures.
- Porcelain coated racks: Some ovens come with lubricated porcelain oven racks, which can remain in the oven during the self clean cycle. Do not clean this vegetable oil lubrication off the racks. It is important that the sides of the oven racks always have a light coating of vegetable oil. To maintain optimal rack performance, re-apply a thin layer of vegetable oil to the sides of the rack after every self clean cycle or when the rack becomes difficult to slide.
- Chrome oven racks: Some models come with chrome oven racks, which have to be removed from the oven during the self clean cycle or else their finish will turn dull and their color slightly blue. If left in, after the cycle is complete and the oven has cooled, rub the sides of the oven racks with wax paper or a cloth containing a small amount of salad oil (this will make the racks glide easier into the rack position). Clean chrome oven racks by using a mild cleaner following manufacturer's instructions. Rinse with clean water and dry.
- Do not allow foods with a high sugar or acid content (milk, tomatoes, sauerkraut, fruit juices, pie fillings, etc.) to remain on surfaces. They may leave a dull spot even after cleaning.

Self Clean

CAUTION During the self cleaning cycle, the outside of the range can become very hot to the touch. Do not leave small children unattended near the appliance.

CAUTION The health of some birds is extremely sensitive to the fumes given off during the self clean cycle of any range. Move birds to another well ventilated room.

CAUTION Do not line the oven walls, racks, bottom or any other part of the appliance with aluminum foil. Doing so will destroy heat distribution, produce poor baking results and cause permanent damage to the interior. Aluminum foil will melt to the interior surface of the oven.

CAUTION Do not force the oven door open. This can damage the automatic door locking system. Use caution when opening the door after the self cleaning cycle is completed. To avoid possible burns when opening oven after a self clean, stand to the side of the door to allow hot air and steam to escape. The oven may still be very hot.



Figure 29: Care in cleaning oven by hand

Note: See additional cleaning information for the oven door in the “Care and Cleaning” section.

Setting Oven Controls

To Start Self Clean

The **Self Clean** key controls the self clean feature. If you are planning to use the oven directly after a self clean cycle remember to allow time for the oven to cool down and the oven door to unlock. This normally takes about one hour. A 3 hour self clean cycle will take about 4 hours to complete. It is recommend to use a 2 hour self clean cycle for light cleaning, a 3 hour cycle for average cleaning, 4 hours for a heavy cleaning.

⚠ CAUTION When the self clean cycle is over, stand to the side of the oven when opening the door to allow hot air or steam to escape. Do not force the oven door open. This can damage the automatic door locking system. Use caution and avoid possible burns when opening the door after the self cleaning cycle has completed. The oven may still be very hot.

To start an immediate 3 hour self clean cycle:

1. Be sure clock is set for correct time of day and door is closed.
2. Press **Self Clean**. **CLEAN** will flash and **3:00** will show in the display. The oven will automatically clean for a 3 hour period. **Note:** if a 2 or 4 hour clean time is desired, press **2 0 0** for 2 hour or **4 0 0** for a 4 hour clean time.



3. Press **START**. The **DOOR, LOCKED** icon will flash and the **CLEAN** icon and the letters **CLn** will remain in the display.

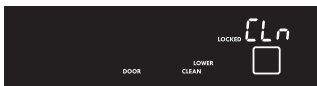

4. As soon as the control is set, the motor driven oven door lock will begin to close automatically. Once the door has been locked the **DOOR LOCKED** indicator light will stop flashing and remain on. Also, the oven icon will appear in the display.

Note: Allow 15 seconds for the oven door to lock.

⚠ CAUTION Do not force the oven door open. This can damage the automatic door locking system. Use caution when opening the door after the self cleaning cycle is completed. The oven may still be very hot.

Important: When one oven is set for a self clean, the other oven will not be operational.

If at this time you wish to delay the self clean starting time, follow steps 6 through 9:

5. Press **Delay Start**.



6. Enter the start time numbers **4 3 0** and press **START**. **CLEAN, DELAY, LOCK, and DOOR** will be displayed.



7. The control will start the self clean at the set delay start time selected. At that time, the **DELAY** message will disappear.



When the self clean is over:

1. **HOT** will appear in the display. The time of day, the **DOOR LOCKED** and **CLEAN** icon will remain in the display.
2. Once the oven has cooled down for approximately 1 hour, and the **DOOR LOCKED** icon is no longer displayed, the oven door can then be opened.

Stopping or Interrupting a Self Cleaning Cycle

If it becomes necessary to stop or interrupt a self cleaning cycle due to excessive smoke or fire in the oven:

1. Press **STOP**.
2. The oven door can only be opened after the oven has cooled down for approximately 1 hour and the **DOOR LOCKED** icon is no longer displayed.

Note: If your clock is set for normal 12 hour display mode the delayed self clean cycle can never be set to start more than 12 hours in advance. To set for delayed self clean cycle 12 to 24 hours in advance set the control for the 24 hour time of day display mode.

Care and Cleaning

Cleaning Various Parts of Your Oven

Before cleaning any part of the oven, be sure all controls are turned off and the oven is cool. Remove spills and any heavy soiling as soon as possible. Regular cleaning will reduce the difficulty of major cleaning later.

Surface Type	Recommendation
Aluminum and Vinyl Painted body parts Painted decorative trim	Use hot, soapy water and a cloth. For more difficult soils and built-up grease, apply a liquid detergent directly onto the soil. Leave on soil for 30-60 minutes. Rinse with a damp cloth and dry. Do not use abrasive cleaners on any of these materials to avoid scratching the surfaces.
Oven control panel Control knobs Control membrane Decorative trim (some models)	Before cleaning the control panel, turn all controls off, activate oven lockout. Do not use abrasive cleaners on any of these materials. Clean using hot, soapy water and a cloth or sponge. Be sure to squeeze excess water from cloth or sponge before wiping control panel, especially when wiping around the controls area. When rinsing, use clean water and a cloth or sponge and be sure to squeeze excess water from cloth or sponge before wiping the control panel.
Easy Care™ Stainless Steel (some models)	Do not use cleaners with high concentrations of chlorides or chlorine. Do not use harsh scrubbing cleaners. Polish with a lint free cloth. Always be sure to wipe excess cleaner or polish off from the metal surface as bluish stains may occur during future oven heating that cannot be removed. Clean heavier soils with hot, soapy water and a cloth or sponge. Rinse and dry using clean water and a cloth.
Stainless Steel (some models)	Only use cleaners and polishes that are specifically manufactured for cleaning stainless steel. Always rub in direction of metal grain to avoid damaging. Do not use cleaners with high concentrations of chlorides or chlorine. Do not use harsh scrubbing cleaners. Polish with a lint free cloth. Always be sure to wipe excess cleaner or polish off from the metal surface as bluish stains may occur during future oven heating that cannot be removed. Clean heavier soils with hot, soapy water and a cloth or sponge. Rinse and dry using clean water and a cloth.
Porcelain enamel broiler pan and insert Porcelain parts Door liner and body parts	Gentle scouring with a soapy scouring pad will remove most spots. Rinse with a 1:1 solution of clear water and ammonia. If necessary, cover difficult spots with an ammonia-soaked paper towel for 30 to 40 minutes. Rinse with clean water and a damp cloth, and then scrub with a soap-filled scouring pad. Rinse and wipe dry with a clean cloth. Remove all cleaners or the porcelain may become damaged during future heating.
Oven racks	Oven racks must be removed from oven cavity. Clean by using a mild, abrasive cleaner following manufacturer's instructions. Rinse with clean water and dry.
Oven door Oven cavity	Use soap and water to thoroughly clean the top, sides, and front of the oven door. Rinse well. You may use a glass cleaner on the outside glass of the door. Do not immerse the door in water. Do not spray or allow water or the glass cleaner to enter the door vents. Do not use oven cleaners, cleaning powders, or any harsh abrasive cleaning materials on the outside of the oven door or on the oven cavity.
Cooktop Care and Cleaning Ceramic Cooktop	Be sure to read all information on how to care for your cooktop contained in the " Cooktop Maintenance " and " Cooktop Cleaning " sections starting on page 26 . Do not use spray oven cleaners on the cooktop. See " Cooktop Maintenance " on page 26 .
Cooktop surface burners cleaning	Do not use a cooktop cleaner on a hot cooktop. The fumes can be hazardous to your health and can chemically damage the ceramic-glass surface.

Care and Cleaning

Cooktop Maintenance

Consistent and proper cleaning is essential to maintaining your ceramic glass cooktop.

Prior to using your cooktop for the first time, apply the recommended CookTop® Cleaning Creme to the ceramic surface (on the web visit www.sears.com for replacement cooktop cleaner, item number 40079). Buff with a nonabrasive cloth or cleaning pad. This will make cleaning easier when soiled from cooking. The special cooktop cleaning cream leaves a protective finish on the glass to help prevent scratches and abrasions.

Sliding aluminum or copper clad bottom pans on the cooktop can cause metal markings on the cooktop surface. These marks should be removed immediately after the cooktop has cooled using the cooktop cleaning cream. Metal marks can become permanent if not removed prior to future use.

Cookware (cast iron, metal, ceramic or glass) with rough bottoms can mark or scratch the cooktop surface.

Do not:

- Slide anything metal or glass across the cooktop.
- Use cookware with dirt or dirt build up on bottom. (Replace with clean cookware before using.)
- Use your cooktop as a cutting board or work surface in the kitchen.
- Cook foods directly on the cooktop surface without a pan.
- Drop heavy or hard objects on the ceramic glass cooktop, they may cause it to crack.

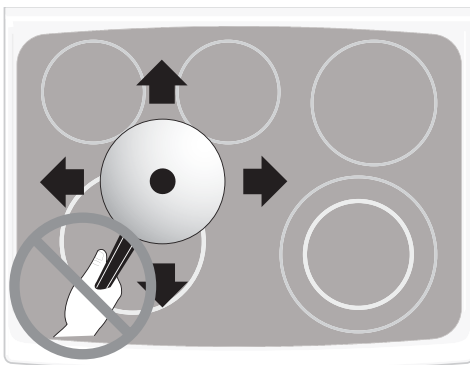

Figure 30: Do not slide pans

Cooktop Cleaning

⚠ WARNING Do not use a cooktop cleaner on a hot cooktop. The fumes can be hazardous to your health, and can chemically damage the ceramic-glass surface.

⚠ CAUTION Before cleaning the cooktop, be sure the controls are turned to off and the cooktop is cool. The glass surface could be hot and burns may occur if the glass surface is touched before it has cooled sufficiently.

For light to moderate soil:

Apply a few drops of CookTop® Cleaning Creme directly to the cooktop. Use a paper towel or use a non-abrasive cleaning pad to clean the entire cooktop surface. Make sure the cooktop is cleaned thoroughly, leaving no residue.

For heavy, burned on soil:

Apply a few drops of CookTop® Cleaning Creme directly to the soiled area. Rub the soiled area using a non-abrasive cleaning pad applying pressure as needed. Do not use the pad you use to clean the cooktop for any other purpose.

If soils remain, carefully scrape soils with a metal razor blade scraper, holding scraper at a 30 degree angle to the surface. Remove loosened soils with cooktop cleaning cream and buff surface clean.

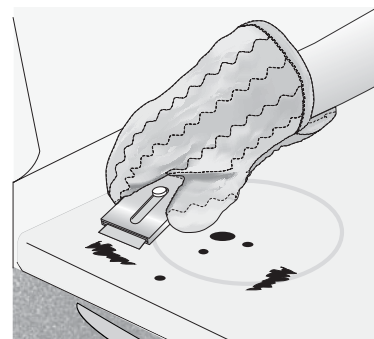

Figure 31: Using razor blade to remove burned on matter

Plastic or foods with a high sugar content:

These types of soils need be removed immediately if spilled or melted onto the ceramic cooktop surface. Permanent damage (such as pitting of the cooktop surface) may occur if not removed immediately. After turning the surface elements off, use a razor blade scraper or a metal spatula with a mitt and scrape the soil from the hot surface (Figure 31). Allow the cooktop to cool, and use the same method for heavy or burned on soils.

Care and Cleaning (continued)

Do not use the following on the cooktop:

- Do not use abrasive cleaners and scouring pads, such as metal and some nylon pads. They may scratch the cooktop, making it more difficult to clean.
- Do not use harsh cleaners, such as chlorine bleach, ammonia or oven cleaners, as they may etch or discolor the cooktop.
- Do not use dirty sponges, cloths or paper towels, as they can leave soil or lint on the cooktop which can burn and cause discoloration.

Important note:

Damage to the ceramic glass cooktop may occur if you use an abrasive type cleaning pad. Only use cleaning products that have been specifically designed for ceramic glass cooktops.



General Cleaning

Refer to the Cleaning recommendation table at the front of this section for more detailed information about cleaning specific parts of the range.

⚠ CAUTION Before manually cleaning any part of the range, be sure all controls are turned off and the range is cool. The range may be hot and can cause burns.

⚠ CAUTION Ammonia must be rinsed before operating the oven. Provide adequate ventilation.

Aluminum Foil and Utensils

⚠ WARNING Never cover any slots, holes or passages in the oven bottom or cover an entire oven rack with materials such as aluminum foil. Aluminum foil linings may trap heat, causing a fire hazard.

⚠ WARNING Protective Liners: Do not use aluminum foil to line the oven bottom. Only use aluminum foil as recommended in this manual. Improper installation of these liners may result in risk of electric shock, or fire.

- **Aluminum foil** - Use of aluminum foil on a hot cooktop can damage the cooktop. Do not allow aluminum foil to touch the surface elements under any circumstances.
- **Aluminum cookware and utensils** - The melting point of aluminum is much lower than that of other metals. Care must be taken when aluminum cookware are used on the cooktop. If aluminum pans are allowed to boil dry when using the cooktop, not only will the utensil be damaged or destroyed, but it may fuse to, break or mark the ceramic glass surface, permanently damaging the cooktop surface.

Replacing the Oven Light

⚠ CAUTION Be sure the oven is unplugged and all parts are cool before replacing oven light.

The interior oven light is located on the left side of the oven cavity. (See [Figure 32](#)).

To replace the oven interior light bulbs:

Important note:

Use a paper towel or cotton glove while handling the new bulb when installing.

1. Turn electrical power off at the main source or unplug the appliance. Carefully remove glass shield.
2. Replace bulb with a new 40 watt halogen bulb. Replace glass shield.
3. Turn power back on again at the main source (or plug the appliance back in). Be sure to reset the time of day on the clock.

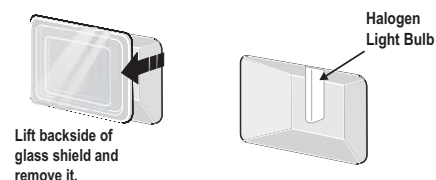

Figure 32: Replacing oven light

Care and Cleaning

Removing and Replacing the Oven Door

⚠ CAUTION The door is heavy. For safe, temporary storage, lay the door flat with the inside of the door facing down.

To remove the oven door:

1. Open oven door completely, horizontal with floor (See [Figure 33](#)).
2. Pull the door hinge locks on both left and right door hinges down from the oven frame completely toward the oven door (See [Figure 34](#)). A tool such as a small flat-blade screwdriver may be required.
3. Firmly grasp both sides of oven door along the door sides. Do not use the oven door handle (See [Figure 35](#)).
4. Close the door to approximately 10 degrees from the oven door frame.
5. Lift the oven door hinge arms over the roller pins located on each side of the oven frame (See [Figure 35](#)).

To replace oven door:

1. Firmly grasp both sides of oven door along the door sides. Do not use the oven door handle (See [Figure 35](#)).
2. Holding the oven door at the same angle as the removal position (See [Figure 35](#)), seat the hook of the hinge arm over the roller pins located on each side of the oven door frame (See [Figure 36](#)). The hook of the hinge arms must be fully seated onto the roller pins.
3. Fully open the oven door, horizontal with floor (See [Figure 33](#)).
4. Push the door hinge locks up toward and into the oven frame on both left and right oven door hinges to the locked position ([Figure 34](#)).
5. Close the oven door.

Special Door Care Instructions:

- Most oven doors contain glass that can break.
- Do not close the oven door until all the oven racks are fully in place.
- Do not hit the glass with cookware, bakeware, or any other object. Scratching, hitting, jarring, or stressing the glass may weaken its structure causing an increased risk of breakage at a later time.

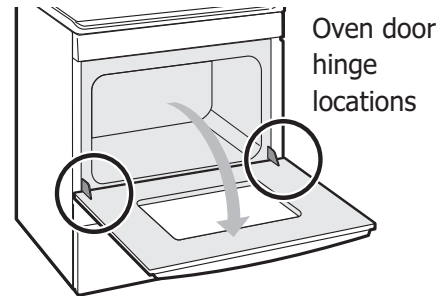

Figure 33: Door hinge location

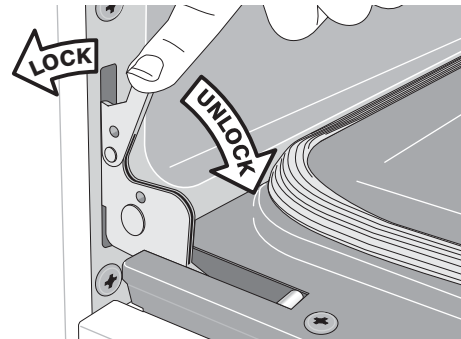

Figure 34: Door hinge locks

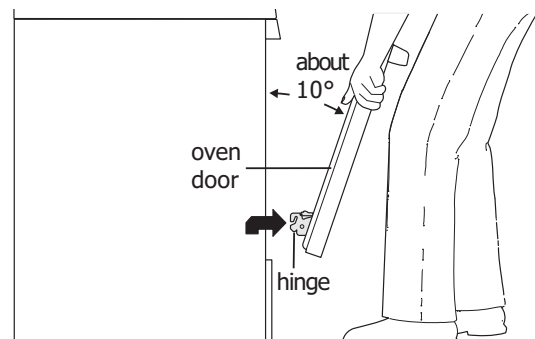

Figure 35: Holding door for removal

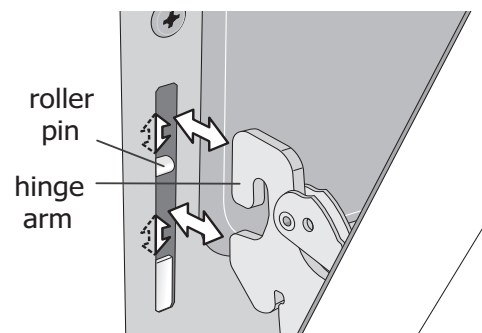





Figure 36: Location of hinge arm and roller pin

Before You Call

Oven Baking

The cooking times and temperatures needed to bake a product may vary slightly from your previously owned appliance.

Baking Problems and Solutions

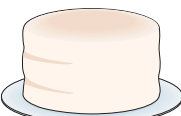
Baking Problems	Causes	Corrections
Cookies and biscuits burn on the bottom 	<ul style="list-style-type: none"> • Cookies and biscuits put into oven before the preheating time is completed. • Oven rack is overcrowded. • Dark pans absorb heat too fast. 	<ul style="list-style-type: none"> • Allow oven to preheat to desired temperature before placing food in oven. • Choose pan sizes that allow 2" to 4" of air space (5.1 cm to 10.2 cm) on all sides when placed in the oven. • Use a medium weight baking sheet.
Cakes too dark on top or bottom 	<ul style="list-style-type: none"> • Cakes put in oven before preheating time is completed. • Rack position too high or too low. • Oven too hot. 	<ul style="list-style-type: none"> • Allow oven to preheat to the selected temperature before placing food in the oven. • Use proper rack position for baking needs. • Set oven temperature 25°F (13°C) lower than recommended.
Cakes not done in center 	<ul style="list-style-type: none"> • Oven too hot. • Incorrect pan size. • Pan not centered in oven. 	<ul style="list-style-type: none"> • Set oven temperature 25°F (13°C) lower than recommended. • Use pan size suggested in recipe. • Use proper rack position and place pan so there is 2" to 4" (5.1 cm to 10.2 cm) of space on all sides of pan.
Cakes not level 	<ul style="list-style-type: none"> • Oven not level. • Pan too close to oven wall or rack overcrowded. • Pan warped. 	<ul style="list-style-type: none"> • Place a marked glass measuring cup filled with water on the center of the oven rack. If the water level is uneven, refer to the installation instructions for leveling the oven. • Be sure to allow 2" to 4" (5.1 cm to 10.2 cm) of clearance on all sides of each pan in the oven. • Do not use pans that are dented or warped.
Foods not done when cooking time is over 	<ul style="list-style-type: none"> • Oven too cool. • Oven overcrowded. • Oven door opened too frequently. 	<ul style="list-style-type: none"> • Set oven temperature 25°F (13°C) higher than suggested and bake for the recommended time. • Be sure to remove all pans from the oven except the ones to be used for baking. • Open oven door only after shortest recommended baking time.

Before You Call

Solutions to Common Problems

Before you call for service, review the following list. It may save you time and expense. Possible solutions are provided with the problem listed:

Problem	Solution
Poor baking results	<ul style="list-style-type: none">• Many factors affect baking results. Use proper oven rack position. Center food in the oven and space pans to allow air to circulate. Preheat oven to the set temperature before placing food in the oven. Try adjusting the recipe's recommended temperature or baking time. See "Adjusting Oven Temperature" on page 22 if you feel the oven is too hot or cold.
Oven does not operate	<ul style="list-style-type: none">• The time of day is not set. The oven clock must first be set in order to operate the oven.• Be sure oven controls are set properly. See "Minimum and Maximum Control Settings" on page 13 and review instructions for the desired cooking function in this manual.• Service wiring is not complete.
Oven light does not work	<ul style="list-style-type: none">• Be sure the oven light is secure in the socket. See "Replacing the Oven Light" on page 27.
Flames inside oven or smoking from oven vent	<ul style="list-style-type: none">• Excessive spills in oven. Grease or food spilled onto oven bottom or oven cavity. Wipe up excessive spills before starting oven. If flames or excessive smoke are present when using broil, see "Setting Broil" on page 19.
Self clean does not work	<ul style="list-style-type: none">• Oven control not set properly. Review Self Clean section.
Oven racks discolored or do not slide easily	<ul style="list-style-type: none">• Oven racks left in oven cavity during self clean. Always remove oven racks from oven cavity before starting a self clean cycle. Clean using a mild abrasive cleaner following manufacturer's instructions. Rinse with clean water, dry, and replace in oven.
Oven smokes excessively when broiling	<ul style="list-style-type: none">• Incorrect setting. Follow broiling instructions in "Setting Broil" on page 19.• Meat too close to the broil element. Reposition broil rack to provide proper clearance between the meat and broil element. Remove excess fat from meat. Cut remaining fatty edges to prevent curling.• Grease build up on oven surfaces. Regular cleaning is necessary when broiling frequently. Grease or food splatters will cause excessive smoking.
Oven control panel beeps and displays any F or E code error	<ul style="list-style-type: none">• Oven control has detected a fault or error condition. Press STOP to clear the error code. Try bake or broil function. If the F or E code error repeats, turn off power to appliance, wait 5 minutes and then repower appliance. Set clock with correct time of day. Try bake or broil function again. If fault recurs, press STOP to clear. Call a service technician.
Soil not completely removed after self clean	<ul style="list-style-type: none">• Self Clean was interrupted. Review Self Clean instructions.• Excessive spills on oven bottom. Clean before starting self clean.
Surface element is too hot or not hot enough	<ul style="list-style-type: none">• Incorrect surface control setting. Adjust power level setting.
Surface element does not heat or does not heat evenly	<ul style="list-style-type: none">• Be sure the correct surface control is turned on for element needed.• Lightweight or warped pans used. Use only flat, evenly balanced, medium or heavy-weight cookware. Flat pans heat better than warped pans. Cookware materials and weight of the material affect heating. Heavy and medium-weight pans heat evenly. Because lightweight pans heat unevenly, foods may burn easily.

Scratches or abrasions on cooktop surface	<ul style="list-style-type: none"> • Coarse particles such as salt or hardened soils between cooktop and utensils can cause scratches. Be sure cooktop surface and bottoms of utensils are clean before usage. Small scratches do not affect cooking and will become less visible with time. • Cleaning materials not recommended for ceramic-glass cooktop have been used. Apply the recommended CookTop® Cleaning Creme to the ceramic surface (on the web visit www.sears.com for replacement cooktop cleaner, item number 40079). Buff with a non-abrasive cloth or sponge. • Cookware with rough bottom was used. Use smooth, flat-bottomed cookware.
Brown streaks or specks on cooktop surface	<ul style="list-style-type: none"> • Boil overs are cooked onto surface. Use razor blade scraper to remove soil.
Appliance is not level	<ul style="list-style-type: none"> • Be sure floor is level, strong, and stable enough to adequately support range. If floor is sagging or sloping, contact a carpenter to correct the situation. • Poor installation. Place oven rack in center of oven. Place a level on the oven rack. Adjust leveling legs at base of appliance until the rack is level. Kitchen cabinet alignment may make range appear not level. Be sure cabinets are square and have sufficient room for appliance clearance.
Cannot move appliance easily. Appliance must be accessible for service	<ul style="list-style-type: none"> • Cabinets not square or are built in too tightly. Contact builder or installer to make appliance accessible. • Carpet interferes with appliance. Provide sufficient space so appliance can be lifted over carpet.
Entire appliance does not operate	<ul style="list-style-type: none"> • Make sure power cord is plugged properly into outlet. • Electrical power outage. Check house lights to be sure. Call your local electric company for service outage information. • Service wiring is not complete. Call 1-800-4-MY-HOME® for assistance (See back cover).
Fan noise during cooking operation	<ul style="list-style-type: none"> • A cooling fan may automatically turn on and off to cool internal parts. It is normal, and the fan may continue to run even after oven is turned off.
Areas of discoloration with metallic sheen on cooktop surface	<ul style="list-style-type: none"> • Mineral deposits from water and food. Remove using the recommended CookTop® Cleaning Creme to the ceramic surface (on the web visit www.sears.com for replacement cooktop cleaner, item number 40079). Buff with a non-abrasive cloth or sponge

Master Protection Agreements

Congratulations on making a smart purchase. Your new Kenmore® product is designed and manufactured for years of dependable operation. But like all products, it may require preventive maintenance or repair from time to time. That's when having a Master Protection Agreement can save you money and aggravation.

The Master Protection Agreement also helps extend the life of your new product. Here's what the Agreement* includes:

- ☑ **Parts and labor** needed to help keep products operating properly **under normal use**, not just defects. Our coverage goes **well beyond the product warranty**. No deductibles, no functional failure excluded from coverage – **real protection**.
- ☑ **Expert service** by a force of more than **10,000 authorized Sears service technicians**, which means someone you can trust will be working on your product.
- ☑ **Unlimited service calls and nationwide service**, as often as you want us, whenever you want us.
- ☑ **"No-lemon" guarantee** – replacement of your covered product if four or more product failures occur within twelve months.
- ☑ **Product replacement** if your covered product can't be fixed.
- ☑ **Annual Preventive Maintenance Check** at your request – no extra charge.
- ☑ **Fast help by phone** – we call it **Rapid Resolution** – phone support from a Sears representative on all products. Think of us as a "talking owner's manual".
- ☑ **Power surge protection** against electrical damage due to power fluctuations.
- ☑ **\$250 Food Loss Protection** annually for any food spoilage that is the result of mechanical failure of any covered refrigerator or freezer.
- ☑ **Rental reimbursement** if repair of your covered product takes longer than promised.
- ☑ **25% discount** off the regular price of any non-covered repair service and related installed parts.

Once you purchase the Agreement, a simple phone call is all that it takes for you to schedule service. You can call anytime day or night, or schedule a service appointment online.

The Master Protection Agreement is a risk free purchase. If you cancel for any reason during the product warranty period, we will provide a full refund. Or, a prorated refund anytime after the product warranty period expires. Purchase your Master Protection Agreement today!

Some limitations and exclusions apply. For prices and additional information in the U.S.A. call 1-800-827-6655.

*** Coverage in Canada varies on some items. For full details call Sears Canada at 1-800-361-6665.**

Sears Installation Service

For Sears professional installation of home appliances, garage door openers, water heaters, and other major home items, in the U.S.A. or Canada call **1-800-4-MY-HOME®**.

Acuerdos maestros de protección

Enhorabuena por haber hecho una compra inteligente. Su nuevo producto Kenmore® está diseñado y fabricado para brindarle años de funcionamiento fiable. Pero, como cualquier producto, puede necesitar mantenimiento preventivo o reparaciones periódicas. Es por eso que tener un Acuerdo maestro de protección podría ahorrarle dinero y molestias.

El Acuerdo maestro de protección también sirve para prolongar la durabilidad de su nuevo producto. El acuerdo* incluye lo siguiente:

- ☑ **Piezas y mano de obra** necesarias para contribuir a mantener el funcionamiento adecuado de los productos **utilizados en condiciones normales de uso**, no sólo en caso de defectos de los productos. Nuestra cobertura va **mucho más allá que la garantía del producto**. No se aplican deducibles ni exclusiones por fallas del funcionamiento: es decir, **verdadera protección**.
- ☑ **Servicio técnico por expertos** (más de **10000 técnicos autorizados de Sears**), lo cual significa que quien repare o realice el mantenimiento de su producto será un profesional de confianza.
- ☑ **Servicio técnico a escala nacional y número ilimitado de llamadas de solicitud de servicio técnico**: se puede poner en contacto con nosotros cuantas veces lo desee y cuando lo desee.
- ☑ **Garantía "sin sorpresas"**: se reemplaza el producto cubierto por el acuerdo si ocurren cuatro o más fallas del producto en un periodo de 12 meses.
- ☑ **Reemplazo del producto**: en caso de que no se pueda reparar el producto cubierto por el acuerdo.
- ☑ **Revisión anual preventiva de mantenimiento del producto**: puede solicitarla en cualquier momento, sin costo alguno.
- ☑ **Rápida asistencia telefónica**, la cual denominamos **Solución rápida**: es decir, asistencia telefónica a través de cualquiera de nuestros representantes de Sears, sobre cualquiera de nuestros productos. Piense en nosotros como en un "manual parlante del usuario".
- ☑ **Protección contra fallas eléctricas**, contra daños debidos a fluctuaciones de la corriente eléctrica.
- ☑ **\$250 al año para cubrir cualquier posible deterioro de alimentos** que haya tenido que desechar debido a una falla mecánica de cualquiera de nuestros refrigeradores o congeladores cubiertos por este acuerdo.
- ☑ **Devolución de gastos de alquiler de electrodomésticos** si la reparación de su producto asegurado toma más que el tiempo prometido.
- ☑ **25% de descuento** aplicable tanto a los costos del servicio de reparación, como de las piezas instaladas relacionadas que no hayan quedado cubiertos por este acuerdo.

Una vez que haya realizado el pago de este acuerdo, bastará una simple llamada telefónica para concertar una visita de servicio. Puede llamar a cualquier hora del día o de la noche, o bien concertar una visita de servicio por Internet.

La adquisición del Acuerdo maestro de protección es una inversión exenta de riesgos. Si por cualquier motivo decide cancelar dicho acuerdo durante el periodo de garantía del producto, le haremos un reintegro total del valor. O bien un importe proporcional si cancela el acuerdo en cualquier otro momento posterior al vencimiento del periodo de garantía del producto. ¡Adquiera hoy mismo su Acuerdo maestro de protección!

Algunas limitaciones y exclusiones podrían aplicarse. Para solicitar precios e información adicional, llame al 1-800-827-6655 (en los EE.UU.).

*** La cobertura en Canadá varía en el caso de algunos artículos. Para obtener detalles completos al respecto, llame al 1-800-361-6665 de Sears de Canadá.**

Servicio de instalación de Sears

Para solicitar la instalación por profesionales de Sears de electrodomésticos, abridores de puertas de garaje, calentadores de agua y otros artículos de uso prioritario en el hogar, **llame al 1-800-4-MY-HOME** en los EE.UU. o Canadá.

Get it fixed, at your home or ours!

Your Home

For troubleshooting, product manuals and expert advice:



www.managemylife.com

For repair – **in your home** – of **all** major brand appliances, lawn and garden equipment, or heating and cooling systems, **no matter who made it, no matter who sold it!**

For the replacement parts, accessories and owner's manuals that you need to do-it-yourself.

For Sears professional installation of home appliances and items like garage door openers and water heaters.

1-800-4-MY-HOME[®] (1-800-469-4663)

Call anytime, day or night (U.S.A. and Canada)

www.sears.com www.sears.ca

Our Home

For repair of carry-in items like vacuums, lawn equipment, and electronics, call anytime for the location of your nearest

Sears Parts & Repair Service Center

1-800-488-1222 (U.S.A.)

www.sears.com

1-800-469-4663 (Canada)

www.sears.ca

To purchase a protection agreement on a product serviced by Sears:

1-800-827-6655 (U.S.A.)

1-800-361-6665 (Canada)

Para pedir servicio de reparación a domicilio, y para ordenar piezas:

1-888-SU-HOGAR[®]

(1-888-784-6427)

www.sears.com

Au Canada pour service en français:

1-800-LE-FOYER^{MC}

(1-800-533-6937)

www.sears.ca

sears

® Registered Trademark / TM Trademark of KCD IP, LLC in the United States, or Sears Brands, LLC in other countries

® Marca Registrada / TM Marca de Fábrica de KCD IP, LLC en Estados Unidos, o Sears Brands, LLC in otros países

^{MC} Marque de commerce / ^{MD} Marque déposée de Sears Brands, LLC