

Equipment marketed to a consumer must be capable of complying with the necessary regulations in the configuration in which the equipment is marketed. Where special accessories, such as shielded cables and/or special connectors are required to enable an unintentional or intentional radiator to comply with the emission limits in this part, the equipment must be marketed with, i.e. shipped and sold with, those special accessories. However, in lieu of shipping or packaging the special accessories with the unintentional or intentional radiator, the responsible party may employ other methods of ensuring that the special accessories are provided to the consumer, without additional charge.

Information detailing any alternative method used to supply the special accessories for a grant of equipment authorization or retained in the verification records, as appropriate. The party responsible for the equipment, as detailed in § 2.909 of this chapter, shall ensure that these special accessories are provided with the equipment. The instruction manual for such devices shall include appropriate instructions on the first page of text concerned with the installation of the device that these special accessories must be used with the device. It is the responsibility of the user to use the needed special accessories supplied with the equipment.

MFA p98b0010, p98c0030

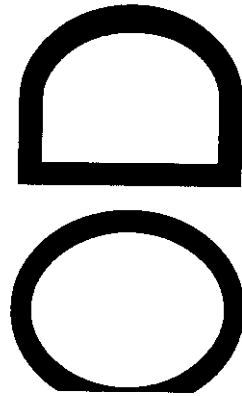

KENWOOD CORPORATION

© B&Z-0994-00 (K)
09 08 07 06 05 04 03 02 01 00

98.11.9.09:38

TK-780/880 E 00 Cover



THANK YOU!

We are grateful you chose **KENWOOD** for your personal mobile applications. We believe this easy-to-use transceiver will provide dependable communications to keep personnel operating at peak efficiency.

KENWOOD transceivers incorporate the latest in advanced technology. As a result, we feel strongly that you will be pleased with the quality and features of this product.

MODELS COVERED BY THIS MANUAL

The models listed below are covered by this manual:

- **TK-780:** VHF FM Transceiver
- **TK-880:** UHF FM Transceiver

One or more of the following statements may be applicable:

FCC WARNING

This equipment generates or uses radio frequency energy. Changes or modifications to this equipment may cause harmful interference unless the modifications are expressly approved in the instruction manual. The user could lose the authority to operate this equipment if an unauthorized change or modification is made.

INFORMATION TO THE DIGITAL DEVICE USER REQUIRED BY THE FCC

This equipment has been tested and found to comply with the limits for a Class B digital device, pursuant to Part 15 of the FCC Rules. These limits are designed to provide reasonable protection against harmful interference in a residential installation.

This equipment generates, uses and can generate radio frequency energy and, if not installed and used in accordance with the instructions, may cause harmful interference to radio communications. However, there is no guarantee that the interference will not occur in a particular installation. If this equipment does cause harmful interference to radio or television reception, which can be determined by turning the equipment off and on, the user is encouraged to try to correct the interference by one or more of the following measures:

- *Reorient or relocate the receiving antenna.*
- *Increase the separation between the equipment and receiver.*
- *Connect the equipment to an outlet on a circuit different from that to which the receiver is connected.*
- *Consult the dealer for technical assistance.*

- Please observe the following precautions to prevent fire, personal injury, and transmitter damage.
- Do not attempt to configure the transmitter while driving; it is too dangerous.
 - Do not modify the transmitter for any reason.
 - Do not expose the transmitter to long periods of direct sunlight, nor place it near heating appliances.
 - Do not place the transmitter in excessively dusty, humid, or wet areas, not on unstable surfaces.
 - If an abnormal odor or smoke is detected coming from the transmitter, turn OFF the power immediately. Contact your **KENWOOD** dealer.

PRECAUTIONS

- WARNING!**
- ◆ **EXPLOSIVE ATMOSPHERES (GASES, DUST, FUMES, etc.)**
Turn OFF your transmitter while taking on fuel or while parked in gasoline service stations. Do not carry spare fuel containers in the trunk of your vehicle if your transmitter is mounted in the trunk area.
 - ◆ **INJURY FROM RADIO FREQUENCY TRANSMISSIONS**
Do not operate your transmitter when somebody is either touching the antenna or standing within two to three feet of it, to avoid the possibility of radio frequency burns or related physical injury.
 - ◆ **DYNAMITE BLASTING CAPS**
Operating the transmitter within 500 feet of dynamite blasting caps may cause them to explode. Turn OFF your transmitter when in an area where blasting is in progress, or where "TURN OFF TWO-WAY RADIO" signs have been posted. If you are transporting blasting caps in your vehicle, make sure they are carried in a closed metal box with a padded interior. Do not transmit while the caps are being placed into or removed from the container.

SAFETY: It is important that the operator is aware of, and understands, hazards common to the operation of any transmitter.

- ◆ **GOVERNMENT LAW PROHIBITS THE OPERATION OF UNLICENSED RADIO TRANSMITTERS WITHIN THE TERRITORIES UNDER GOVERNMENT CONTROL.**
- ◆ **ILLEGAL OPERATION IS PUNISHABLE BY FINE OR IMPRISONMENT OR BOTH.**
- ◆ **REFER SERVICE TO QUALIFIED TECHNICIANS ONLY.**

NOTICES TO THE USER

CONTENTS

1	UNPACKING AND CHECKING EQUIPMENT
1	Supplied Accessories
2	PREPARATION
2	Tools Required
2	Power Cable Connection
3	Installing the Transceiver
4	ORIENTATION
4	Front Panel and Microphone
5	Display
5	Rear Panel
6	PROGRAMMABLE AUXILIARY FUNCTIONS
8	BASIC OPERATIONS
8	Switching Power ON/OFF
8	Adjusting the Volume
8	Selecting a System/ Group/ Channel
8	Time-out Timer (TOT)
8	Horn Alert
9	OPERATION OVERVIEW
9	Trunking Format
9	Conventional Format
10	TRUNKED OPERATION (Trunking Format)
10	Placing a Dispatch Call
10	Receiving a Dispatch Call
10	Placing a Telephone Call
10	Receiving a Telephone Call
12	CONVENTIONAL OPERATION (Trunking Format)
12	Transmitting
12	Receiving
13	SYSTEM SCAN (Trunking Format)
13	General
13	Scanning Trunked Systems
13	Scanning Conventional Systems
13	Scan Lockout
13	Scan Revert
14	GROUP SCAN (Trunking Format)
15	CONVENTIONAL OPERATION (Conventional Format)
15	Transmitting
15	Receiving
16	SYSTEM SCAN (Conventional Format)
16	General
16	Priority Scan
17	2-TONE SIGNALLING (Conventional Format)
18	AUDIBLE USER FEEDBACK TONES

Screw set



Fuse



Speaker jack cap



Mounting bracket

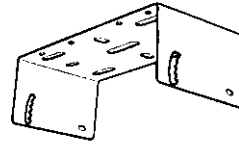

DC power cable

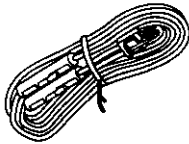

Microphone hanger with self-tapping screws

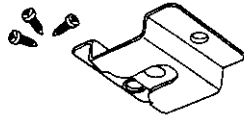

Microphone

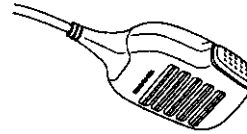

Item	Part Number	Quantity
Microphone	T91-0593-XX	1
Microphone hanger with self-tapping screws	J19-1584-XX	1 set
DC power cable	E30-3339-XX	1
Mounting bracket	J29-0627-XX	1
Speaker jack cap	B09-0235-XX	1
Fuse	F51-0016-XX	2
Screw set	N99-0395-XX	1
Warranty card (U.S.A. only)	-	1
Instruction manual	B62-0994-XX	1

■ Supplied Accessories

Note: The following unpacking instructions are for use by your KENWOOD dealer, an authorized KENWOOD service facility, or the factory.
 Carefully unpack the transceiver. We recommend that you identify the items listed in the following table before discarding the packing material. If any items have been damaged during shipment, file a claim with the carrier immediately.

UNPACKING AND CHECKING EQUIPMENT

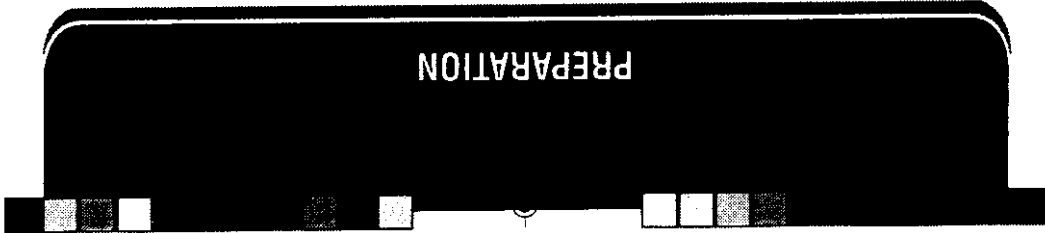

WARNING! VARIOUS ELECTRONIC EQUIPMENT IN YOUR VEHICLE MAY MALFUNCTION IF THEY ARE NOT PROPERLY PROTECTED FROM THE RADIO FREQUENCY ENERGY WHICH IS PRESENT WHILE TRANSMITTING. ELECTRONIC FUEL INJECTION, ANTI-SKID BRAKING, AND CRUISE CONTROL SYSTEMS ARE TYPICAL EXAMPLES OF EQUIPMENT THAT MAY MALFUNCTION. IF YOUR VEHICLE CONTAINS SUCH EQUIPMENT, CONSULT THE DEALER FOR THE MAKE OF VEHICLE AND ENLIST HIS AID IN DETERMINING IF THEY WILL PERFORM NORMALLY WHILE TRANSMITTING.

Note: The following preparation instructions are for use by your **KENWOOD** dealer, an authorized **KENWOOD** service facility, or the factory.

■ Tools Required

Note: Before installing the transceiver, always check how far the mounting screws will extend below the mounting surface. When drilling mounting holes, be careful not to damage vehicle wiring or parts.

The following tools are required for installing the transceiver:

- 6 mm (1/4 inch) or larger electric drill
- Drill bits (sizes listed below) and circle cutters

Drill Bit Size	Purpose
4.2 mm (5/32 inch)	5 x 16 mm self-tapping screws
3.2 mm (1/8 inch)	4 x 16 mm self-tapping screws

■ Power Cable Connection

CAUTION: THE TRANSCEIVER OPERATES IN 12 V NEGATIVE GROUND SYSTEMS ONLY! CHECK THE BATTERY POLARITY AND VOLTAGE OF THE VEHICLE BEFORE INSTALLING THE TRANSCEIVER.

- 1 Check for an existing hole, conveniently located in the firewall, where the power cable can be passed through.
 - If no hole exists, drill the firewall and install a rubber grommet.
- 2 Run the two power cable leads through the fire wall and into the engine compartment, from the passenger compartment.
 - Keep the plug end of the cable at the transceiver.
- 3 Connect the red lead to the positive (+) battery terminal, or switched power source, and the black lead to the negative (-) battery terminal.
 - Locate the fuse as close to the battery as possible.
- 4 Recoil and secure the surplus cable with the provided retaining band.
 - Be sure to leave enough slack in the cables so the transceiver can be removed for servicing while keeping the power applied.

■ Installing the Transceiver

WARNING! FOR PASSENGER SAFETY, INSTALL THE TRANSCEIVER SECURELY, USING THE SUPPLIED MOUNTING BRACKET, SO THE TRANSCEIVER WILL NOT BREAK LOOSE IN THE EVENT OF A COLLISION.

1 Locate the holes in the dash by using the mounting bracket as a template. Drill the holes. Attach the mounting bracket using the supplied 5 x 16 mm screws.

- Be sure to mount the transceiver in a location where the controls are within easy reach of the user, and where there is sufficient space at the rear of the transceiver for cable connections.

2 Connect the antenna and the supplied power cable to the transceiver.

3 Slide the transceiver into the mounting bracket and secure it using the supplied machine screws.

4 Mount the microphone hanger, using the supplied 4 x 16 mm screws, in a location easily reached by the user.

- The microphone and microphone cable should be located in a place where they will not interfere with the safe operation of the vehicle.

5 Attach the microphone hanger ground cable to both the microphone hanger and the mounting bracket, as shown in the diagram below.

6 Connect one plug of the microphone cable to the jack on the front of the microphone, and the other plug to the microphone jack on the front of the transceiver. Place the microphone on the hanger.

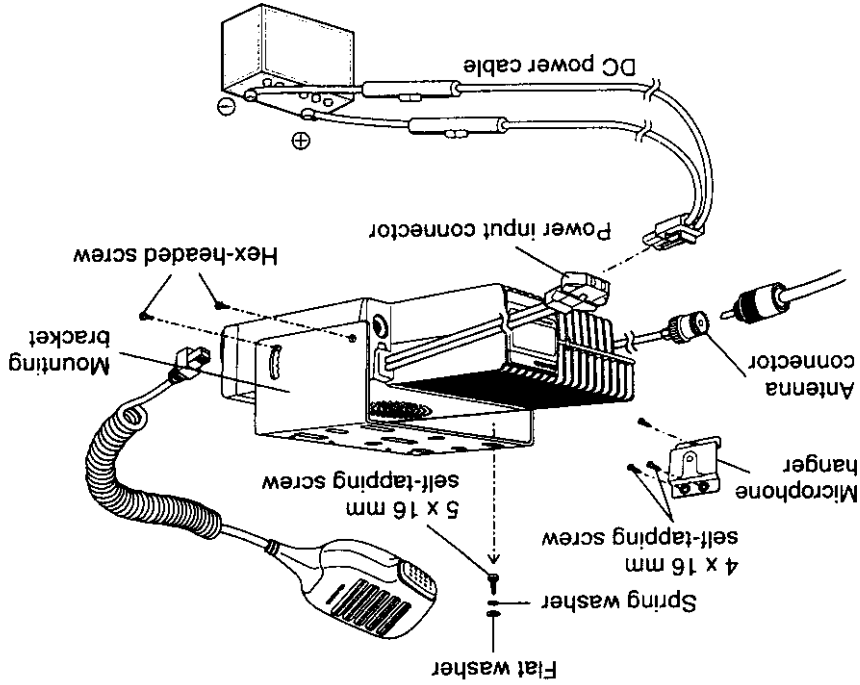

3

4

- ① I O (Power) switch
Press to switch the power ON (or OFF).
- ② up/down keys
Press these keys to activate their auxiliary functions (page 6).
- ③ Display
See page 5 for more information.
- ④ up/down keys
Press these keys to activate their auxiliary functions (page 6).
- ⑤ Microphone connector
Insert the microphone plug into this connector.
- ⑥ MON, A, B, C, D, and SCN keys
Press these keys to activate their auxiliary functions (page 6).
- ⑦ PTT switch
Press and hold this switch, then speak into the microphone to transmit.
Release to receive.

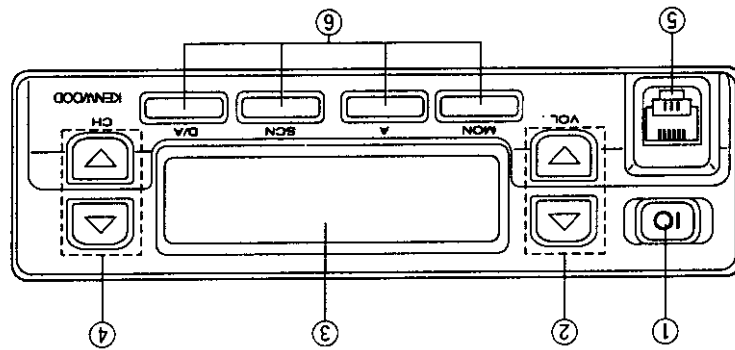

■ Front Panel and Microphone

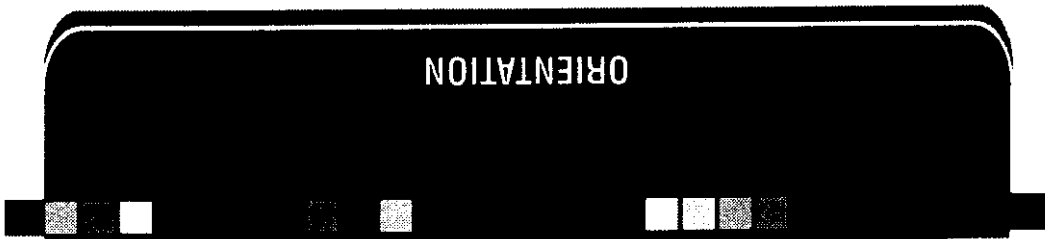

■ Rear Panel

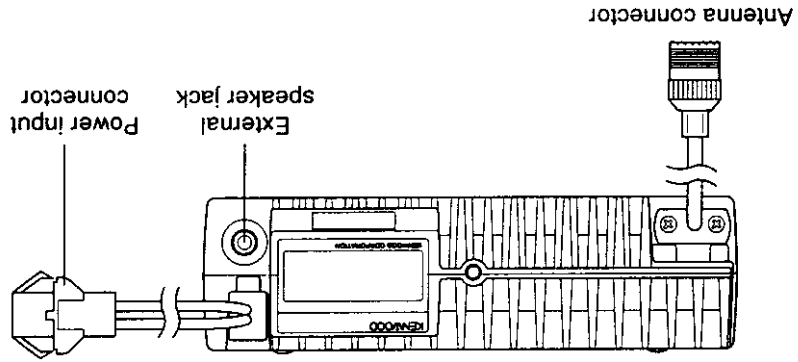

Indicator	Description
	Displays the system, channel and group numbers. Also displays various functions which have been programmed by your dealer.
	Appears when the selected channel is programmed as priority (Conventional Format).
	Appears when the key programmed as Monitor is pressed.
	This icon is not used on this transceiver.
	Appears when you are using the System Scan mode.
	Appears when the auxiliary function programmed by your dealer is activated.
	Appears when the selected group is programmed as telephone IDs.
	Appears and flashes when receiving a status message and when a message is in the stack. Contact your dealer for more information.
	Displays the system, group, and channel numbers. Your dealer can program group and channel names with up to 10 characters, in place of numbers. The left display is used as a delete indicator () in Tunking Format and an add indicator () in Conventional Format. The right display is used for the Selective Call () or Scrambler (-) function. The delete/add indicators show the systems that are locked/not locked out of the scanning sequence. Selective Call and Scrambler are optional functions that can be programmed by your dealer.

■ Display



PROGRAMMABLE AUXILIARY FUNCTIONS

Keys ②, ④, and ⑥ {page 4} can be programmed with the auxiliary functions listed in the following table. The keys can only be programmed with functions, depending on whether you are using Conventional Format or Trunking Format. Please contact your dealer for further details on these functions.

Note: If "Function" is programmed onto one of the above mentioned keys, the DTMF keypad (keypad models only) can also be used for additional programmable keys.

Function	Conventional Format	Trunking Format
Auto Tel	No	Yes
AUX A ¹	Yes	Yes
AUX B ¹	Yes	Yes
Channel Down	Yes	No
Channel Up	Yes	No
Connect ID	Yes	Yes
Disconnect ID	Yes	Yes
Display Character	Yes	Yes
Emergency	Yes	Yes
Function	Yes	Yes
Group Down	Yes	Yes
Group Up	Yes	Yes
Home Channel	Yes	No
Home Group	No	Yes
Horn Alert	Yes	No
Key Lock	Yes	Yes
Memory (RCL/STO)	Yes	Yes
Memory (RCL)	Yes	Yes
Memory (STO)	Yes	Yes
Monitor A (Monitor Unmute (Momentary))	Yes	Yes
Monitor B (Monitor Unmute (Toggle))	Yes	Yes
Monitor C (Carrier Squelch (Momentary))	Yes	Yes
Monitor D (Carrier Squelch (Toggle))	Yes	Yes
Operator Sel Tone	Yes	No
Public Address	Yes	Yes
Redial	Yes	Yes

7

¹ This function can be selected only when the Scrambler/ANI board has not been installed.
² This function can be selected only when the Scrambler/ANI board has been installed.

Function	Conventional Format	Trunking Format
Scan	Yes	Yes
Scan Del/Add	Yes	Yes
Scan Temporary Delete	No	Yes
System Down	No	Yes
System Up	No	Yes
Scrambler ²	Yes	Yes
Talk Around	Yes	No
Tel Disconnect	No	Yes
Volume Down	Yes	Yes
Volume Up	Yes	Yes



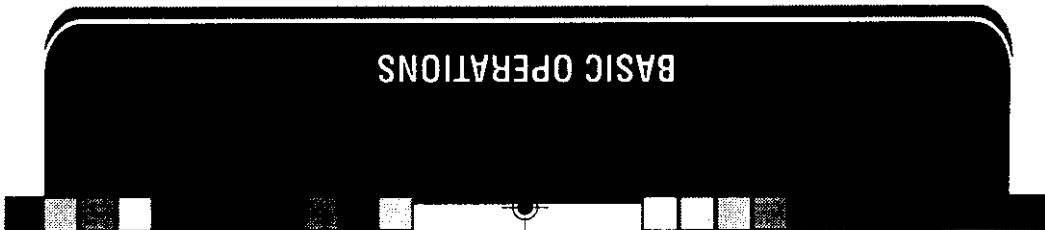

■ **Switching Power ON/OFF**

Press the **IO** switch to switch the transceiver ON (or OFF).

■ **Adjusting the Volume**

Press the keys programmed as **Volume Up** and **Volume Down** to adjust the volume. **Volume Up** increases the volume and **Volume Down** decreases it.

■ **Selecting a System/ Group/ Channel**

Select the desired system and group (Trunking Format) using the **System/ Group** keys.

Select the desired group and channel (Conventional Format) using the **Group/ Channel** keys.

■ **Time-out Timer (TOT)**

The purpose of the Time-out Timer is to prevent any single person from using a channel for an extended period of time.

If you continuously transmit for a period of time that exceeds the programmed time, the transceiver will stop transmitting and an alert tone will sound. To stop the tone, release the **PTT** switch.

Your dealer can program the TOT time in the range of 15 seconds to 10 minutes.

■ **Horn Alert**

If Horn Alert has been installed by your dealer, your vehicle horn, or some other type of external alert, will sound when certain calls are received. This is a useful function when you are away from your vehicle.

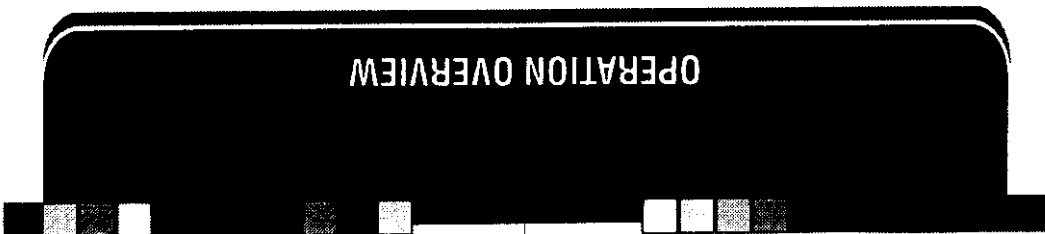

Your dealer can program your transceiver for either Trunking Format or Conventional Format.

■ **Trunking Format**

This format can handle up to 32 systems with up to 250 groups in each system. The transceiver can be used in both trunked mode and conventional mode. Systems, groups, and their functions are programmed by your dealer.

■ **Conventional Format**

This format can handle up to 250 groups with 250 channels in each group. The transceiver can be used only in conventional mode. Groups, channels, and their functions are programmed by your dealer.

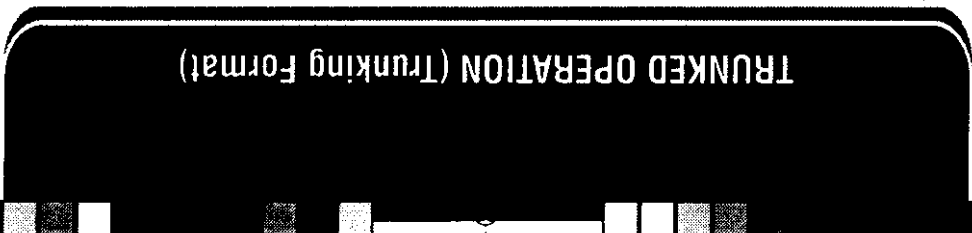

■ Placing a Dispatch Call

- 1 Select the desired system and group using the **System/Group** keys.
- 2 Press the **PTT** switch.
- 3 If the busy tone or intercept tone does not sound, communication is possible; start speaking into the microphone. Release the **PTT** switch to receive.
 - For best sound quality at the receiving station, hold the microphone approximately 1.5 inches (3 ~ 4 cm) from your mouth.
- 4 When your conversation is finished, return the microphone to its hanger.

■ Receiving a Dispatch Call

- 1 Switch ON the transmitter.
- 2 Set the volume level using the volume level tones as guides.
- 3 Select the desired system and group using the **System/Group** keys. (If the Scan function has been programmed, you can switch it ON or OFF as desired.)
- 4 When you hear the dispatcher's voice, readjust the volume as necessary.

■ Placing a Telephone Call

Note: You can only make a telephone call if that service is available in your area. Consult your dealer for details.

- 1 Select the desired system and group using the **System/Group** keys.
- 2 Press and hold the **PTT** switch for approximately 1 second to ensure a connection.
- 3 Release the **PTT** switch and confirm that there is a dial tone from the repeater.
- 4 Dial using the microphone keypad.
 - After dialing, wait for a response from the called party.
- 5 When the called party responds, press the **PTT** switch and speak into the microphone. Release the **PTT** switch to receive.
 - Only one person can speak at a time.
- 6 To end the call, press the # key or the key programmed as **Tel Disconnect**.



■ Receiving a Telephone Call

- 1 Select the desired system and group using the **System/Group** keys. (If the Scan function has been programmed, you can switch it ON or OFF as desired.)
 - A ringing tone will sound when a call is received.
- 2 Press and hold the **PTT** switch to speak, and release it to listen.
 - Only one person can speak at a time.
- 3 To end the call, press the # key or the key programmed as **Tel Disconnect**.



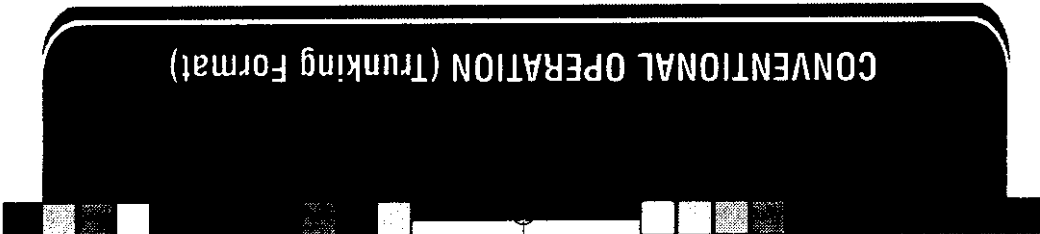

■ Transmitting

Note: Before transmitting, you must monitor the channel to make sure it is not already in use. If the selected group is not programmed with QT (Quiet Talk) or DQT (Digital Quiet Talk), simply listen to the channel to make nobody is talking on it. You do not need to remove the microphone from the hook to monitor the channel. If the selected group is programmed with QT or DQT, remove the microphone from the hook to disable QT or DQT, then listen to the channel to make sure nobody is talking on it.

- 1 Select the desired system and group using the **System/ Group** keys.
 - If the channel is busy, wait until it becomes free.
- 2 Press the **PTT** switch and speak into the microphone. Release the **PTT** switch to receive.
 - For best sound quality at the receiving station, hold the microphone approximately 1.5 inches (3 - 4 cm) from your mouth.
- 3 When your conversation is finished, return the microphone to its hanger.

■ Receiving

- 1 Switch ON the transceiver.
- 2 Set the volume level using the volume level tones as guides.
- 3 Select the desired system and group using the **System/ Group** keys. (If the Scan function has been programmed, you can switch it ON or OFF as desired.)
- 4 When you hear the dispatcher's voice, readjust the volume as necessary.

■ General

If the Scan function is programmed, systems can be scanned by pressing the key programmed as **Scan**. When it is pressed, the SCN indicator and "SCAN" or the revert system/group number, appear on the display and scanning starts. The systems not locked out of the scanning sequence are scanned.

When a call is received, scanning stops and the system and group digits appear. Press the **PTT** switch and speak into the microphone to respond to the call. The transceiver will continue scanning after an adjustable time delay if the **PTT** switch is released and no further signal is received.

■ Scanning Trunked Systems

When scanning trunked systems, the revert groups and the groups not locked out of the scanning sequence are scanned. See "GROUP SCAN" on page 14.

■ Scanning Conventional Systems

When scanning conventional systems, the revert groups and the groups not locked out of the scanning sequence are scanned. See "GROUP SCAN" on page 14.

■ Scan Lockout

If a programmable auxiliary key is programmed with Scan Lockout, each system can be locked out of the scan sequence manually. The delete indicator will appear in the left hand display when the system displayed is locked out.

■ Scan Revert

Scan Revert refers to the revert systems and groups being scanned. You can select revert systems and groups using the **System/Group** keys. Three types of Scan Reverts which can be programmed by your dealer are available:

- **Last Called Revert:** The last system/group received is assigned as the new revert system and group.
- **Last Used Revert:** The last system/group responded to is assigned as the new revert system and group.
- **Last Selected:** The last system/group selected is assigned as the new revert system and group.

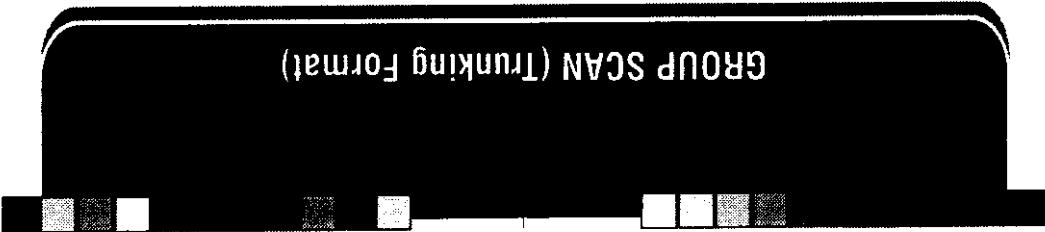

Group Scan is available for both trunked and conventional systems. This feature is useful when more than one group is programmed in a system. Group Scan is set by the dealer on request. It scans the revert groups as well as groups that are allowed to be scanned.

When a call is received, the group indicator shows the group number, and that group becomes the revert group. Simply press the **PTT** switch to respond to the call.

Note: Please contact your dealer for information concerning Priority Scan.

CONVENTIONAL OPERATION (Conventional Format)

■ Transmitting

Note: Before transmitting, you must monitor the channel to make sure it is not already in use. If the selected group is not programmed with QT (Quiet Talk) or DQT (Digital Quiet Talk), simply listen to the channel to make nobody is talking on it. You do not need to remove the microphone from the hook to monitor the channel. If the selected group is programmed with QT or DQT, remove the microphone from the hook to disable QT or DQT, then listen to the channel to make sure nobody is talking on it.

- 1 Select the desired system and group using the **System/Group** keys.
 - If the channel is busy, wait until it becomes free.
- 2 Press the **PTT** switch and speak into the microphone. Release the **PTT** switch to receive.
 - For best sound quality at the receiving station, hold the microphone approximately 1.5 inches (3 ~ 4 cm) from your mouth.
- 3 When your conversation is finished, return the microphone to its hanger.

■ Receiving

- 1 Switch ON the transceiver.
- 2 Set the volume level using the volume level tones as guides.
- 3 Select the desired system and group using the **System/Group** keys. (If the Scan function has been programmed, you can switch it ON or OFF as desired.)
- 4 When you hear the caller's voice, readjust the volume as necessary.

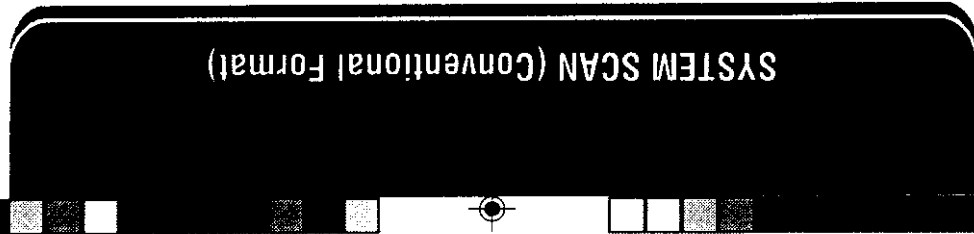

■ General

If the Scan function is programmed, groups or channels can be scanned by pressing the key programmed as **Scan**. The Scan function has a Single Scan or a Multi Scan. When the **Scan** key is pressed, the SCN indicator and "SCAN-" or the revert group/channel number, appear on the display and scanning starts.

When a call is received, scanning stops and the group and channel digits appear. Press the **PTT** switch and speak into the microphone to respond to the call. The transceiver will continue scanning after an adjustable time delay, if the **PTT** switch is released, and no further signal is received. When the displayed group is not locked out of the scanning sequence, the add indicator () will appear on the display.

■ Priority Scan

The priority channel must be programmed in order for Priority Scan to function.

When a signal is received on the priority channel, the transceiver will automatically change to that channel, even if it is receiving a signal on a different channel.

The indicator appears when the displayed channel is the priority channel.

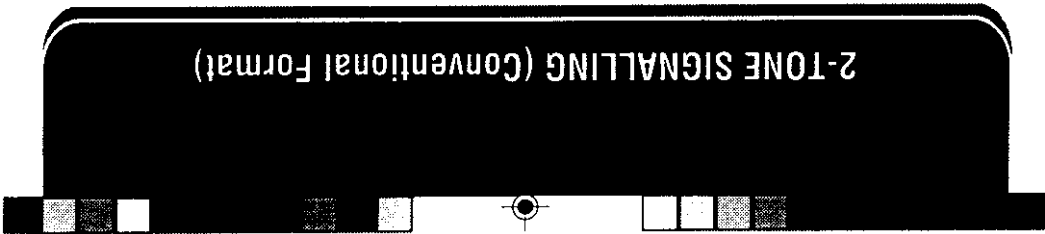

2-Tone Signalling is either activated or deactivated by your dealer.
2-Tone Signalling only opens the squelch when the transceiver receives two tones corresponding to those set up in the transceiver. When the squelch opens, you will be able to hear the caller without any further action.
After a correct code is received and the squelch opens, pressing the key programmed as Monitor will cancel the connection.
If your dealer programmed Transpond for 2-Tone Signalling, your transceiver will automatically send an acknowledgment signal to the station that called when the correct tone is received. Transpond does not function when you are called with a Group code.
If your dealer programmed Tone Alert for 2-Tone Signalling, your transceiver will emit a beep when a correct tone is received.

Note: This transceiver is only capable of decoding 2-Tone Signals. It cannot encode a 2-Tone Signal.

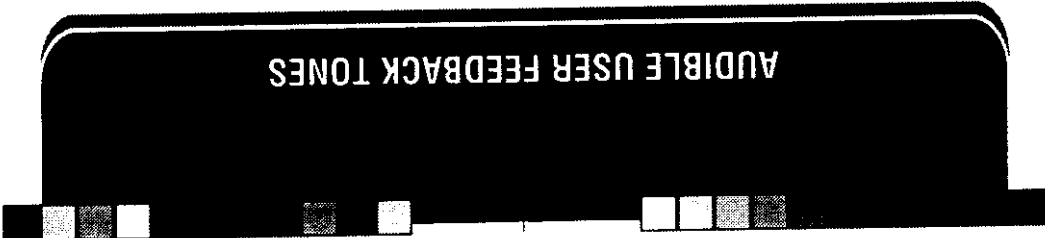

The transceiver emits various tones to indicate the transceiver's operating status. Please contact your dealer for further information on these tones.

Tone		Conventional Format	Trunking Format
Alert	Yes	Yes	Yes
Busy	Yes	Yes	Yes
DBD On	Yes	Yes	Yes
DBD Off	Yes	Yes	Yes
Delay	No	No	Yes
Deny	No	No	Yes
Free System Ring Back Mode/ System Search Mode	No	No	Yes
Group Call	Yes	Yes	Yes
Individual Call	Yes	Yes	Yes
Intercept	No	No	Yes
Key Input Error	Yes	Yes	Yes
Key Press [A]	Yes	Yes	Yes
Key Press [B]	Yes	Yes	Yes
Key Press [C]	Yes	Yes	Yes
Password Agreement	Yes	Yes	Yes
Power ON	Yes	Yes	Yes
Pre Alert	Yes	Yes	No
Proceed	No	No	Yes
PTT Release	Yes	Yes	Yes
Queue	No	No	Yes
Ringling	No	No	Yes
Roll Over	Yes	Yes	Yes
System Search	No	No	Yes
System Search End	No	No	Yes
Transpond	Yes	Yes	Yes