

KENWOOD

INSTRUCTION MANUAL



VHF FM TRANSCEIVER

TK-2102/

TK-2107

UHF FM TRANSCEIVER

TK-3102/

TK-3107

KENWOOD CORPORATION

© B62-1163-10 (K,M)
09 08 07 06 05 04 03 02 01

THANK YOU!

We are grateful for your purchase of this **KENWOOD** transceiver. We believe this easy-to-use transceiver will provide you with dependable and reliable communications.

KENWOOD MEANS WIRELESS

Founded more than 50 years ago, **KENWOOD's** Car and Home Audio products are in demand around the world. **KENWOOD** is also a major developer and producer of wireless and digital wireless communications products. **KENWOOD** provides top quality Amateur Radio products for the serious hobbyist, and commercial radio products and systems for business, industry, and public safety users, worldwide.

MODELS COVERED BY THIS MANUAL

TK-2102: 2-channel VHF FM Transceiver

TK-2107: 16-channel VHF FM Transceiver

TK-3102: 2-channel UHF FM Transceiver

TK-3107: 16-channel UHF FM Transceiver

PRECAUTIONS

- Refer service to qualified technicians only.
- Do not operate the transceiver or charge a battery pack in an explosive atmosphere (gases, dust, fumes, etc.).
- Turn OFF the transceiver while taking on fuel or while parked in a gasoline service station.
- Do not modify or attempt to adjust this transceiver for any reason.
- Do not expose the transceiver to long periods of direct sunlight, nor place it close to heating appliances.
- Do not place the transceiver in excessively dusty, humid, and/or wet areas, nor on unstable surfaces.

SAFETY: It is important that the operator is aware of, and understands, hazards common to the operation of any transceiver.

CONTENTS

UNPACKING AND CHECKING EQUIPMENT	1
Supplied Accessories	1
PREPARATION	3
Charging the NiCd Battery Pack	3
Installing/ Removing the Battery Pack	5
Installing the Antenna	6
Installing the Belt Clip	6
Installing the Cover over the Speaker/ Microphone Jacks	7
Installing the Optional Speaker/ Microphone	7
GETTING ACQUAINTED (TK-2102/ TK-3102)	8
TK-2102/ TK-3102 OPERATION	9
GETTING ACQUAINTED (TK-2107/ TK-3107)	10
TK-2107/ TK-3107 OPERATION	11
AUXILIARY FUNCTIONS	12
Time-out Timer	12
Battery Save	12
Low Battery Warning	12
Monitor	13
Quiet Talk (QT) and Digital Quiet Talk (DQT)	13
OPTIONAL ACCESSORIES	14
TROUBLESHOOTING GUIDE	15
FREQUENCY CHART	16

UNPACKING AND CHECKING EQUIPMENT

Carefully unpack the transceiver. We recommend that you identify the items listed in the following table before discarding the packing material. If any items are missing or have been damaged during shipment, file a claim with the carrier immediately.

■ Supplied Accessories

Item		Part Number	Qty	
Antenna	TK-2102/ TK-2107	K,M K2,M2	T90-0695-X5 T90-0681-X5	1
	TK-3102/ TK-3107	K,M,K2,M2	T90-0694-X5	
		K3,M3	T90-0683-X5	
		K4	T90-0684-X5	
Battery charger (TK-2102/ TK-3102 only)		W08-0598-X5	1	
AC adaptor (TK-2102/ TK-3102 only)	K	W08-0479-X5	1	
	M	W08-0558-X5		
NiCd battery pack (KNB-15A) (TK-2102/ TK-3102 only)		W09-0940-X5	1	
Speaker/ microphone jack cover		B09-0351-X3	1	
Speaker/ microphone locking bracket		J21-4493-X4	1	
Belt clip		J29-0624-X3	1	
Screw set		N99-0396-X5	1	
Warranty card	K	—	1	
Instruction manual		B62-1163-XX	1	

Note: A market code (K, K2, K3, K4, M, M2, M3) can be found on the label attached to the package box.

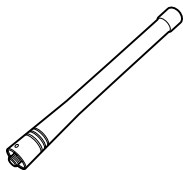

Antenna
(TK-2102/ TK-2107)

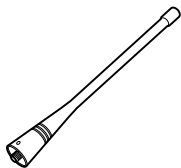

Antenna
(TK-3102/ TK-3107)

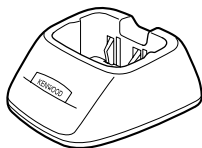

Battery charger
(TK-2102/ TK-3102 only)

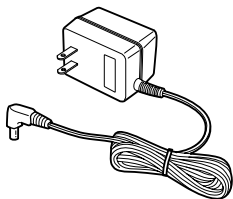

AC adaptor (K market)
(TK-2102/ TK-3102 only)

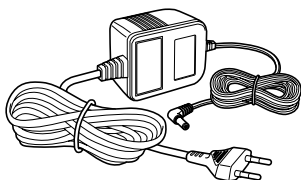

AC adaptor (M market)
(TK-2102/ TK-3102 only)

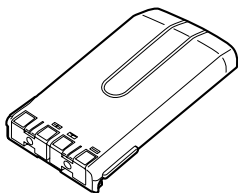

NiCd battery pack
(KNB-15A)
(TK-2102/ TK-3102 only)



Speaker/ microphone
jack cover

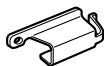

Speaker/ microphone
locking bracket



Belt clip



Screw set

PREPARATION

■ Charging the NiCd Battery Pack

The battery pack is not charged at the factory; charge it before use.

Initially charging the battery pack after purchase or extended storage (greater than 2 months) will not bring the battery pack to its normal operating capacity. After repeating the charge/discharge cycle two or three times, the operating capacity will increase to normal.



CAUTION

- ◆ DO NOT RECHARGE THE BATTERY PACK IF IT IS ALREADY FULLY CHARGED. DOING SO MAY CAUSE THE LIFE OF THE BATTERY PACK TO SHORTEN OR THE BATTERY PACK MAY BE DAMAGED.
- ◆ AFTER RECHARGING THE BATTERY PACK, DISCONNECT IT FROM THE CHARGER. CHARGING THE BATTERY PACK FOR MORE THAN 5 DAYS MAY REDUCE THE BATTERY PACK LIFE DUE TO OVERCHARGING.

Note:

- ◆ The ambient temperature should be between 41 and 104°F (5 and 40°C) while charging is in progress. Charging outside this range may not fully charge the battery.
- ◆ Always switch OFF the transceiver equipped with a NiCd battery pack before charging. Using the transceiver while charging its battery pack will interfere with correct charging.
- ◆ The battery pack life is over when its operating time decreases even though it is fully and correctly charged. Replace the battery pack.

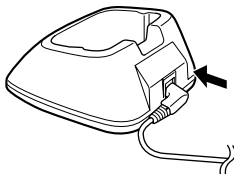

Plug the AC adaptor cable into the adaptor jack located on the rear of the charger.

Plug the AC adaptor into an AC outlet.

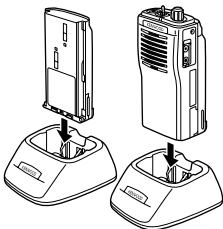

Slide the NiCd battery pack or transceiver with a NiCd battery pack into the charger.

- Make sure the battery pack contacts are in contact with the charging terminals.
- The charger LED lights and charging begins.

After charging the supplied KNB-15A battery pack for 8 hours, remove it or the transceiver equipped with it from the charger.

- The charger does not turn OFF automatically after charging is completed.

Unplug the AC adaptor from the AC outlet.

Note: It takes approximately 6 hours to fully charge the optional KNB-14 battery pack.

■ Installing/ Removing the Battery Pack

The average life of the supplied KNB-15A NiCd battery pack is 8 hours. Average times are calculated using 5% transmit time, 5% receive time, and 90% standby time.



CAUTION

- ◆ *DO NOT SHORT THE BATTERY TERMINALS OR DISPOSE OF THE BATTERY BY FIRE.*
- ◆ *NEVER ATTEMPT TO REMOVE THE CASING FROM THE BATTERY PACK.*

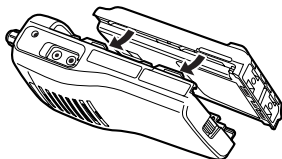

Match the four grooves of the battery pack with the corresponding guides on the back of the transceiver.

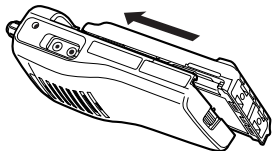

Slide the battery pack along the back of the transceiver until the release latch on the base of the transceiver locks.

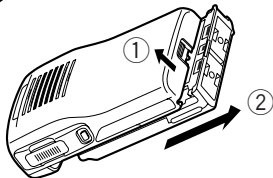

To remove the battery pack, pull back on the release latch and slide the pack away from the transceiver.

■ Installing the Antenna

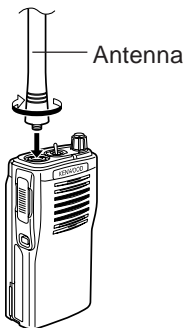

Screw the antenna into the connector on the top of the transceiver by holding the antenna at its base and turning it clockwise until secure.

Note: The antenna is neither a handle, a key ring retainer, nor a speaker/microphone attachment point. Using the antenna in these ways may damage the antenna and degrade your transceiver's performance.

■ Installing the Belt Clip

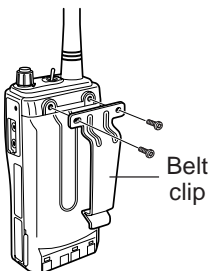

If necessary, attach the belt clip using the two supplied 3 x 8 mm screws.

Note:

- ◆ If the belt clip is not installed, its mounting location may get hot during continuous transmission or when left sitting in a hot environment.
- ◆ You must remove the belt clip before removing the battery pack.



CAUTION

DO NOT USE GLUE WHICH IS DESIGNED TO PREVENT SCREW LOOSENING WHEN INSTALLING THE BELT CLIP, AS IT MAY CAUSE DAMAGE TO THE TRANSCEIVER. ACRYLIC ESTER, WHICH IS CONTAINED IN THESE GLUES, MAY CRACK THE TRANSCEIVER'S BACK PANEL.

■ Installing the Cover over the Speaker/ Microphone Jacks

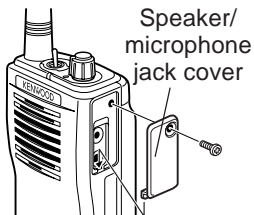

If you are not using a speaker/ microphone, install the cover over the speaker/ microphone jacks using the supplied 3 x 6 mm screw.

Note: To keep the transceiver water resistant, you must cover the speaker/ microphone jacks with the supplied cover.

■ Installing the Optional Speaker/ Microphone

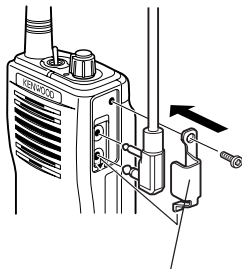

Insert the speaker/ microphone plugs into the speaker/ microphone jacks.

Attach the locking bracket using the supplied 3 x 6 mm screw.

Note: The transceiver is not fully water resistant while using the speaker/ microphone.

GETTING ACQUAINTED (TK-2102/ TK-3102)

Antenna

LED indicator

Lights red while transmitting.
Lights green while receiving a signal.
Flashes red when the battery voltage is low while transmitting.

Speaker

Microphone

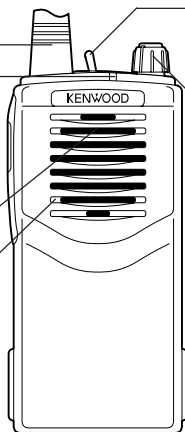

Channel switch

Toggle this switch to select channel 1 or channel 2.

Power switch/ Volume control

Turn clockwise to switch ON the transceiver. To switch OFF the transceiver, turn counterclockwise until a click sounds. Rotate to adjust the volume level.

PTT (Push-To-Talk) switch

Press, then speak into the microphone to call a station. Release to receive.

Monitor key

Press and hold to turn the squelch OFF. You will hear background noise. Release to turn the squelch back ON.

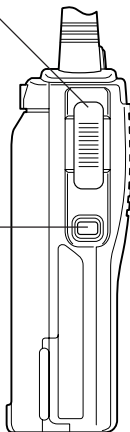

Speaker/ microphone jacks

Battery pack (KNB-15A)

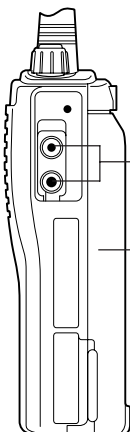

TK-2102/ TK-3102 OPERATION

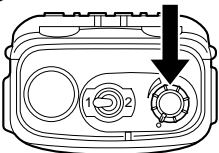

Switch ON the transceiver by turning the **Power** switch/ **Volume** control clockwise.

- A beep sounds.

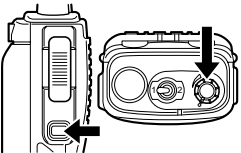

Adjust the volume by pressing and holding the **Monitor** key, then rotating the **Power** switch/ **Volume** control.

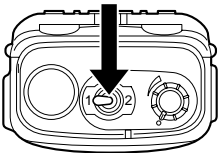

Toggle the **Channel** switch to select your desired channel.

- When you receive an appropriate signal, you will hear audio from the speaker.

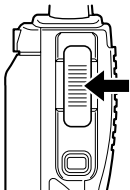

To make a call, press and hold the **PTT** switch, then speak into the microphone using your normal speaking voice.

- Hold the microphone approximately 1.5 inches (3 to 4 cm) from your lips.

Release the **PTT** switch to receive.

Note: When the battery pack voltage becomes too low, transmission will stop and the LED will blink red. See "Low Battery Warning" on page 12.

GETTING ACQUAINTED (TK-2107/ TK-3107)

Antenna

LED indicator

Lights red while transmitting.
Lights green while receiving a signal.
Flashes red when the battery voltage is low while transmitting.

Speaker

Microphone

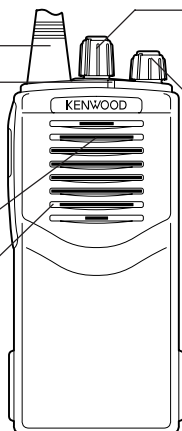

Channel selector

Rotate to select channels 1 ~ 16.

**Power switch/
Volume control**

Turn clockwise to switch ON the transceiver. To switch OFF the transceiver, turn counterclockwise until a click sounds. Rotate to adjust the volume level.

PTT (Push-To-Talk) switch

Press, then speak into the microphone to call a station. Release to receive.

Monitor key

Press and hold to turn the squelch OFF. You will hear background noise. Release to turn the squelch back ON.

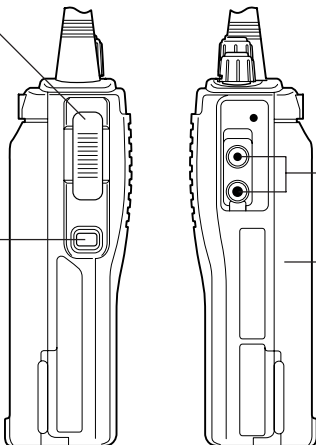

**Speaker/
microphone jacks**

**Battery pack
(KNB-15A)**

TK-2107/ TK-3107 OPERATION

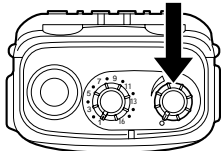

Switch ON the transceiver by turning the **Power** switch/ **Volume** control clockwise.

- A beep sounds.

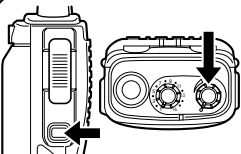

Adjust the volume by pressing and holding the **Monitor** key, then rotating the **Power** switch/ **Volume** control.

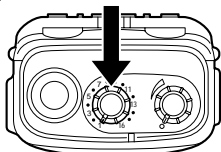

Rotate the **Channel** selector to select your desired channel.

- When you receive an appropriate signal, you will hear audio from the speaker.

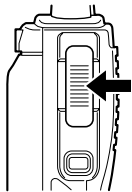

To make a call, press and hold the **PTT** switch, then speak into the microphone using your normal speaking voice.

- Hold the microphone approximately 1.5 inches (3 to 4 cm) from your lips.

Release the **PTT** switch to receive.

Note: When the battery pack voltage becomes too low, transmission will stop and the LED will blink red. See "Low Battery Warning" on page 12.

AUXILIARY FUNCTIONS

■ Time-out Timer

The purpose of the Time-out Timer is to prevent any single person from using a channel for an extended period of time.

If you continuously transmit for 10 minutes, the transceiver will stop transmitting and a tone will sound. To stop the tone, release the **PTT** switch. You can press the **PTT** switch again to resume transmitting.

■ Battery Save

The Battery Save function decreases the amount of power used when a signal is not being received and no operations are being performed (no keys are being pressed, and no switches are being turned).

While the channel is not busy and no operation is performed for 10 seconds, Battery Save turns ON. When a signal is received or an operation is performed, Battery Save turns OFF.

■ Low Battery Warning

Low Battery Warning alerts you when the battery needs to be recharged.

While transmitting, if the battery power goes below a pre-determined value, the LED will blink red. When a tone sounds, the transceiver stops transmitting. Replace or recharge the battery pack.

■ Monitor

When no signals are present, the squelch on the transceiver automatically mutes the speaker so you will not hear background noise. To manually deactivate the squelch, press and hold the **Monitor** key. This is useful when you want to adjust the volume level, or when you need to hear a weak signal.

- The LED indicator lights green while the **Monitor** key is pressed.

■ Quiet Talk (QT) and Digital Quiet Talk (DQT)

Some channels may have pre-programmed QT/DQT tones. A QT/DQT tone is a subaudible tone which allows you to ignore (not hear) calls from other parties who are using the same channel.

When you receive a signal that has a tone different from the one set up in your transceiver, you will not hear the signal. Likewise, signals that you transmit will only be heard by parties whose QT/DQT tone matches the tone set up in your transceiver.

Note: *Although using channels set up with QT/DQT tones relieves you from listening to unwanted calls, it does not mean your calls will be private.*

OPTIONAL ACCESSORIES

You can use the following accessories with your transceiver:

- KNB-14: Standard Battery (7.2 V/ 600 mAh)
- KNB-15A: Long Life Battery (7.2 V/ 1100 mAh)
- KSC-15: Regular Battery Charger
- KSC-16: Rapid Battery Charger
- KSC-21R: Refreshable Rapid Battery Charger
- KHS-1: Head Set with VOX (Voice Operated Transmit)
- KMC-17: Speaker/ Microphone (Standard Duty)
- KMC-21: Speaker/ Microphone (Light Duty)
- KBP-1: Alkaline Battery Case
- KBH-8: Spring-action Belt Clip
- KWR-1: Water Resistant Bag

TROUBLESHOOTING GUIDE

Problem	Solution
No power.	<ul style="list-style-type: none">• The battery pack may be dead. Recharge or replace the battery pack.• The battery pack may not be installed correctly. Remove the battery pack and install it again.
Battery power dies shortly after charging.	<ul style="list-style-type: none">• The battery pack life is finished. Replace the battery pack with a new one.
Cannot talk to or hear other members in your group.	<ul style="list-style-type: none">• Make sure you are using the same frequency and Quiet Talk tone as the other members in your group.• Other group members may be too far away. Make sure you are within range of the other transceivers.
Other voices (besides group members) are present on the channel.	<ul style="list-style-type: none">• Change the Quiet Talk tone. Be sure to change the tone on all transceivers in your group.

FREQUENCY CHART

Model Name: TK-_____

Serial Number: _____

Channel	Transmit Frequency	Receive Frequency	QT/DQT
1			
2			
3			
4			
5			
6			
7			
8			
9			
10			
11			
12			
13			
14			
15			
16			