

KENWOOD

AUDIO VIDEO SURROUND RECEIVER

VR-507
KRF-V7050D

INSTRUCTION MANUAL

KENWOOD CORPORATION

**This instruction manual is used to describe multiple models listed above.
Model availability and features (functions) may differ depending on the country and sales area.**

About the supplied remote control

Compared to standard remote controls, the remote control supplied with this receiver has several operation modes. These modes enable the remote control to control other audio/video components. In order to effectively use the remote control it is important to read the operating instructions and obtain a proper understanding of the remote control and how to switch its operation modes (etc.). Using the remote control without completely understanding its design and how to switch the operation modes may result in incorrect operations.

Before applying the power

⚠ Caution : Read this page carefully to ensure safe operation.

Units are designed for operation as follows.

- U.S.A. and Canada** AC 120 V only
- Australia** AC 240 V only
- Europe and U.K.** AC 230 V only
- China and Russia** AC 220 V only
- Other countries** AC 110-120 / 220-240 V switchable*

* AC voltage selection

The AC voltage selector switch on the rear panel is set to the voltage that prevails in the area to which the unit is shipped. Before connecting the power cord to your AC outlet, make sure that the setting position of this switch matches your line voltage. If not, it must be set to your voltage in accordance with the following direction.

AC voltage selector switch

Move switch lever to match your line voltage with a small screw-driver or other pointed tool.

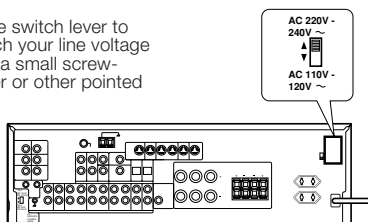

Note:
Our warranty does not cover damage caused by excessive line voltage due to improper setting of the AC voltage selector switch.

Safety precautions

WARNING :

TO PREVENT FIRE OR ELECTRIC SHOCK, DO NOT EXPOSE THIS APPLIANCE TO RAIN OR MOISTURE.



CAUTION
RISK OF ELECTRIC SHOCK
DO NOT OPEN



CAUTION: TO REDUCE THE RISK OF ELECTRIC SHOCK, DO NOT REMOVE COVER (OR BACK). NO USER-SERVICEABLE PARTS INSIDE, REFER SERVICING TO QUALIFIED SERVICE PERSONNEL.



THE LIGHTNING FLASH WITH ARROWHEAD SYMBOL, WITHIN AN EQUILATERAL TRIANGLE, IS INTENDED TO ALERT THE USER TO THE PRESENCE OF UNINSULATED "DANGEROUS VOLTAGE" WITHIN THE PRODUCT'S ENCLOSURE THAT MAY BE OF SUFFICIENT MAGNITUDE TO CONSTITUTE A RISK OF ELECTRIC SHOCK TO PERSONS.



THE EXCLAMATION POINT WITHIN AN EQUILATERAL TRIANGLE IS INTENDED TO ALERT THE USER TO THE PRESENCE OF IMPORTANT OPERATING AND MAINTENANCE (SERVICING) INSTRUCTIONS IN THE LITERATURE ACCOMPANYING THE APPLIANCE.

Unpacking

Unpack the unit carefully and make sure that all accessories are put aside so they will not be lost.

Examine the unit for any possibility of shipping damage. If your unit is damaged or fails to operate, notify your dealer immediately. If your unit was shipped to you directly, notify the shipping company without delay. Only the consignee (the person or company receiving the unit) can file a claim against the carrier for shipping damage.

We recommend that you retain the original carton and packing materials for use should you transport or ship the unit in the future.

Keep this manual handy for future reference.

Accessories

FM indoor antenna (1)

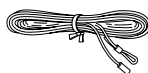

AM loop antenna (1)

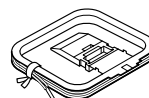

For VR-507

Remote control unit (1)
RC-R0720

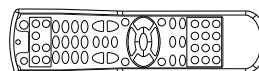

Batteries (R6/AA) (2)

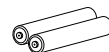

For KRF-V7050D

Remote control unit (1)
RC-R0613

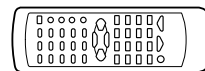

Batteries (R6/AA) (2)

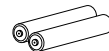

*AC plug adaptor (1)

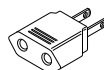

*Use to adapt the plug on the power cord to the shape of the wall outlet. (Accessory only for regions where use is necessary.)

Microcomputer malfunction

If operation is not possible or an erroneous display appears, even though all connections have been made properly, reset the microcomputer referring to "In case of difficulty".

-[45]

Maintenance of the unit

When the front panel or case becomes dirty, wipe with a soft, dry cloth. Do not use thinner, benzene, alcohol, etc. for these agents may cause discoloration.



In regard to contact cleaner

Do not use contact cleaners because it could cause a malfunction. Be specially careful not to use contact cleaners containing oil, for they may deform the plastic component.

Contents

Caution : Read the pages marked  carefully to ensure safe operation.

Preparations

-  **Before applying the power** 2
 -  Safety precautions 2
 - Unpacking 2
 - How to use this manual 4
 - Special features 5
- Names and functions of parts** 6
 - Remote control unit (RC-R0720) (VR-507) 7
 - Remote control unit (RC-R0613) (KRF-V7050D) .. 8
- Setting up the system** 9
 - Connecting audio components 10
 - Connecting video components 11
 - Connecting a DVD player (6-channel input) 12
 - Digital connections 13
 - Connecting to the AV AUX jacks 14
 - Connecting the antennas 14
 - Connecting the system control 15
 - Connecting the speakers 16
 - Connecting the terminals 17
 - Preparing the remote control 18
- Preparing for surround sound** 19
 - Speaker settings 19

Operations

- Normal playback** 20
 - Preparing for playback 20
 - Listening to a source component 21
 - Adjusting the sound 21
- Recording** 22
 - Recording audio (analog sources) 22
 - Recording video 23
 - Recording audio (digital sources) 23
- Listening to radio broadcasts** 23
 - Tuning radio stations 23
 - Presetting radio stations manually 24
 - Receiving preset stations 24
 - Receiving preset stations in order (P.CALL) 24
- Ambience effects** 25
 - Surround modes 25
 - Surround play 27
 - DVD 6-channel playback 28
 - Convenient functions 28

Remote Control

- Basic remote control operations for other components** 31
 - Registering setup codes for other components (RC-R0720) 31
 - Programming TV/VCR combo control 31
 - Searching for your code 32
 - Checking the codes 32
 - Re-assigning device keys 32
 - Changing volume lock 33
 - Operating other components 33
 - Registering setup codes for other components (RC-R0613) 34
 - Operating other components (RC-R0613) 34
 - Setup code chart (for VR-507 (RC-R0720)) 35
 - Setup code chart (for KRF-V7050D (RC-R0613)) 39
 - CASSETTE deck, CD player & MD recorder operations 40
 - Other components' operations 42

- Additional Information** **In case of difficulty** 45
-  **Specifications** 47

For the U.S.A.

FCC WARNING

This equipment may generate or use radio frequency energy. Changes or modifications to this equipment may cause harmful interference unless the modifications are expressly approved in the instruction manual. The user could lose the authority to operate this equipment if an unauthorized change or modification is made.

NOTE:

This equipment has been tested and found to comply with the limits for a Class B digital device, pursuant to Part 15 of the FCC Rules. These limits are designed to provide reasonable protection against harmful interference in a residential installation. This equipment may cause harmful interference to radio communications, if it is not installed and used in accordance with the instructions. However, there is no guarantee that interference will not occur in a particular installation. If this equipment does cause harmful interference to radio or television reception, which can be determined by turning the equipment off and on, the user is encouraged to try to correct the interference by one or more of the following measures:

- Reorient or relocate the receiving antenna.
- Increase the separation between the equipment and receiver.
- Connect the equipment into an outlet on a circuit different from that to which the receiver is connected.
- Consult the dealer or an experienced radio / TV technician for help.

For the U.S.A.

Note to CATV system installer:

This reminder is provided to call the CATV system installer's attention to Article 820-40 of the NEC that provides guidelines for proper grounding and, in particular, specifies that the cable ground shall be connected to the grounding system of the building, as close to the point of cable entry as practical.



As an ENERGY STAR® Partner, Kenwood Corporation has determined that this product meets the ENERGY STAR® guidelines for energy efficiency.

This product can save energy. Saving energy reduces air pollution and lowers utility bills.

How to use this manual

This manual covers the VR-507 and KRF-V7050D. Items such as functions, number of jacks, and remote control details somewhat differ between these models. To confirm the functions available on the model you have purchased, refer to the table below.

Model name	Remote Control	Terminal		
		Speaker out	Video 3 jacks	Front input
VR-507	RC-R0720	2 systems (A, B)	Equipped	Equipped
KRF-V7050D	RC-R0613	2 systems (A, B)	Equipped	Equipped

This manual is divided into four sections, Preparations, Operations, Remote Control, and Additional Information.

Preparations

Shows you how to connect your audio and video components to the receiver and prepare the surround processor.

We will guide you to make setting up your system as easy as possible. However, since this receiver works with all of your audio and video components, connecting the system can be fairly complex.

Operations

Shows you how to operate the various functions available on the receiver.

Remote Control

Shows you how to operate other components using the remote control, as well as a detailed explanation of all remote control operations. Once you have registered your components with the proper setup codes, you'll be able to operate both this receiver and your other AV components (TV, VCR, DVD player, CD player, etc.) using the remote control supplied with this receiver.

Additional Information

Shows you additional information such as "In case of difficulty" (troubleshooting) and "Specifications".

Memory back up function

Please note that the following items will be deleted from the unit's memory if the power cord is disconnected from the AC outlet for approximately 2 days.

- Power mode.
- Input selector settings.
- Device preset.
- Picture output.
- Speaker ON/OFF
- Volume level.
- BASS, TREBLE, INPUT level.
- Subwoofer ON/OFF.
- Dimmer level.
- Monitor ON/OFF.
- MD/TAPE settings.
- 6ch/2ch input setting.
- Listen mode setting.
- Speaker settings.
- Input mode setting.
- Midnight mode setting.
- Broadcast band.
- Frequency setting.
- Preset stations.
- Tuning mode.
- CINEMA EQ.
- Source Direct.

Special features

True home theater sound

This receiver incorporates a wide variety of surround modes to bring you maximum enjoyment from your video software. Select a surround mode according to your equipment or the software you are going to play and enjoy! — [25]

Dolby Digital

The DOLBY DIGITAL mode lets you enjoy full digital surround from software processed in the Dolby Digital format. Dolby Digital provides up to 5.1 channels of independent digital audio for better sound quality and more powerful presence than conventional Dolby Surround.

Dolby PRO LOGIC II

Pro Logic II, whilst totally compatible with its predecessor PRO LOGIC, provides greater advantages in surround sound. It allows user to enjoy the conventional stereo or Dolby Surround with a convincing "5.1 like" presentation. PRO LOGIC II offers special features for controlling the overall spatial, dimensionality and frontal sound field imaging. Dolby PRO LOGIC II produces an impressive surround sound from video software marked  and three-dimensional space from music CD. When listening to music, you will be able to enjoy the experience of sheer STEREO surround sound.

Dolby 3 Stereo

This surround system reproduces theater-like surround sound from video software marked . The 3 STEREO mode will redirect the Surround signal to the front left and right speakers when only the front and center speakers are used.

DTS

DTS (Digital Theater System) is a 5.1 channel digital audio format that provides five full-spectrum channels and one low-frequency (subwoofer) channel for unprecedented clarity, optimum channel separation and a (wide) dynamic range.

In the DTS mode, the 5.1 channel digital input from a DTS CD, LD or DVD disc (carrying the "DTS" marking) can be played in Digital Surround. Important:

When a DTS disc is played on a CD, LD or DVD player, noise may be output from the analog output. It is recommended that you connect the digital output of the player to the digital input of this unit.

Multi channel music (SRS Circle Surround (●)CS)

SRS Circle surround enables you to listen to multi channel sound from the stereo source. We assume you have already enjoyed listening to Dolby digital sound/DTS multi channel sound with your multi speakers. Now, this time try listening to the stereo source (ex. Audio CD) using your multi speakers. You may discover a new type of "stereo" sound through SRS Circle Surround.

DSP surround modes

The DSP (Digital Signal Processor) used for this receiver incorporates a variety of high quality adjustable sound fields, like "ARENA", "JAZZ CLUB", "THEATER", "STADIUM" and "DISCO". It is compatible with almost any kind of program source.

DVD 6-channel input

If you own a DVD player equipped with 6-channel output, this receiver allows you to obtain the full surround sound impact of DVD source material featuring multi-channel encoding. Since the source signals are digital and each channel is input independently, the resulting ambience is far superior to what can be achieved with conventional surround sound systems.

CINEMA EQ.

Cinema EQ. mode will produce a more dynamic sound quality in any conditions. You can enjoy a more impressive sound effect when you switch CINEMA EQ. ON during Dolby Digital and DTS playback.

Universal IR (InfraRed) remote control

In addition to the basic receiver, the remote control supplied with this receiver can also operate almost all of your remote controllable audio and video components. Just follow the simple setup procedure to register the components you have connected.

Names and functions of parts

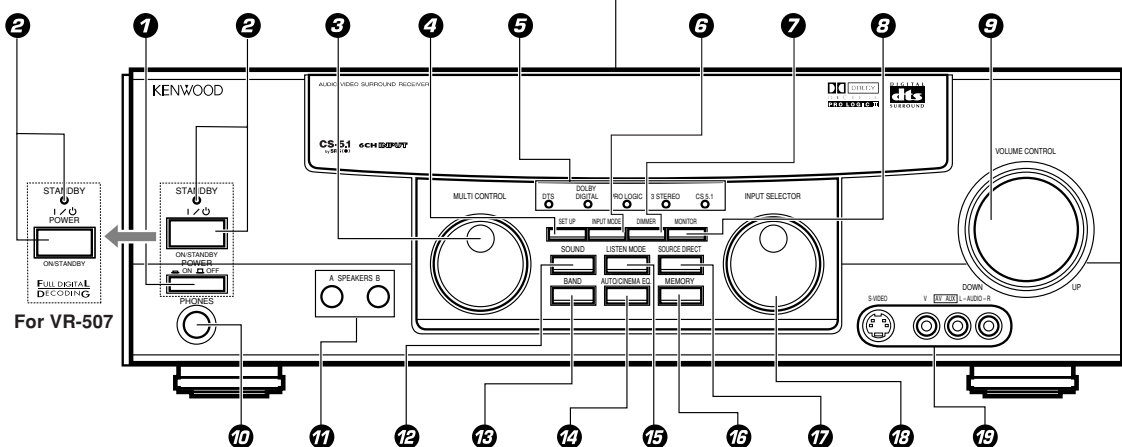
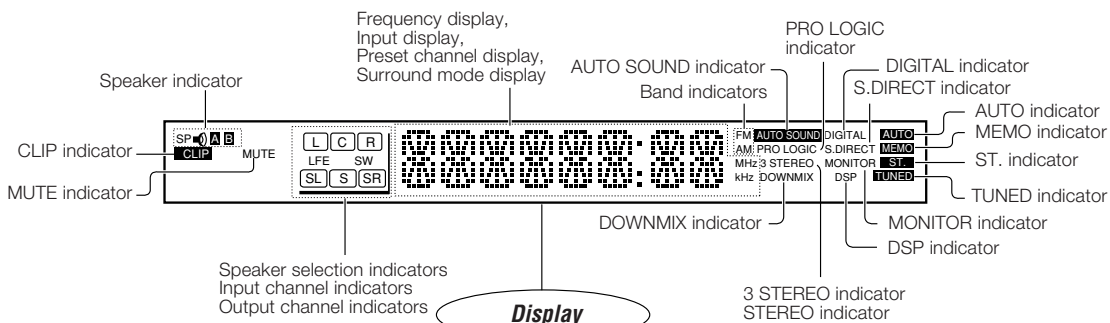

- 1 POWER key (For KRF-V7050D)** - 19
Use to turn the main power ON/OFF.
- 2 ON/STANDBY (1/0) key (For KRF-V7050D)** - 19
Use to switch the power ON/STANDBY when the POWER is turned ON.
STANDBY indicator
- 2 POWER (1/0) key (For VR-507)** - 19
Use to turn the power ON/STANDBY.
STANDBY indicator
- 3 MULTI CONTROL knob** - 19
Use to control a variety of settings.
- 4 SET UP key** - 19
Use to select the speakers' settings etc.
- 5 Surround indicators**
DTS indicator - 27
Lights when the receiver is in the DTS mode.
DOLBY DIGITAL indicator - 27
Lights when the receiver is in the Dolby Digital mode.
PRO LOGIC indicator - 27
Lights when the receiver is in the PRO LOGIC mode.
- 3 STEREO indicator** - 27
Lights when the receiver is in the 3 STEREO mode.
- 6 INPUT MODE key** - 9
Use to switch between the digital and analog inputs.
- 7 DIMMER key** - 23 - 30
Use to adjust the brightness of the display.
- 8 MONITOR key** - 22
Use to monitor the source that is connected to the MONITOR jack.
- 9 VOLUME CONTROL knob** - 21
- 10 PHONES jack** - 22
Use for headphone listening.
- 11 SPEAKERS A/B keys** - 20
Use to turn the A/B speakers ON/OFF.
- 12 SOUND key** - 28
Use to adjust the sound quality and the ambience effects.
- 13 BAND key** - 23
Use to select the broadcast band.
- 14 AUTO/CINEMA EQ. key** - 20
Use to change "TAPE" indication to "MD".
Use to select the auto tuning mode. - 23
Use to switch the status of CINEMA EQ. - 22
- 15 LISTEN MODE key** - 27
Use to select the listening mode.
- 16 MEMORY key** - 22
Use to store radio stations in the preset memory.
- 17 SOURCE DIRECT key** - 24
Use to pass the source material directly to the amplifier.
- 18 INPUT SELECTOR knob** - 21
Use to select the input sources.
- 19 AV AUX (S VIDEO, V, AUDIO L/R) jacks** - 14

Standby mode

When standby indicator is lit, this receiver is in standby mode and consumes a small amount of current for back-up. This system can be switched on using remote controls.

Remote control unit (RC-R0720) (VR-507)

This remote control unit can be used not only for Kenwood products but also for other non-Kenwood products by setting the appropriate maker setup codes. → [31]

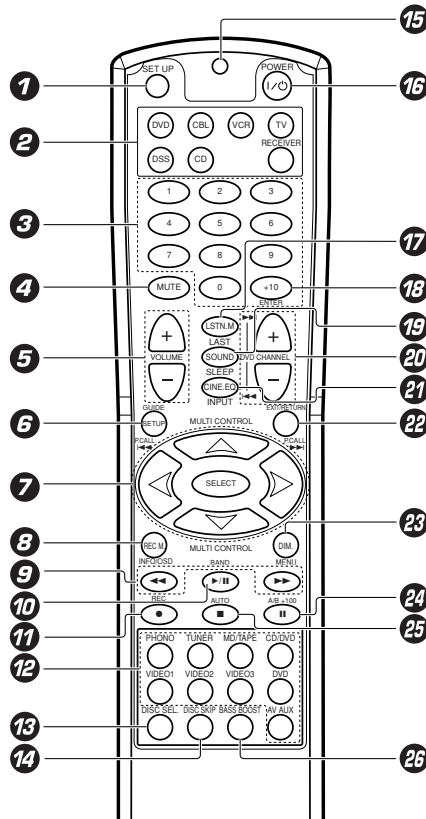

If the name of a function is different on the receiver and on the remote control, the name of the remote control key in this manual is indicated in parentheses.

1 SET UP key → [31]
Use to register other components.

2 Source key (DVD, CBL, VCR, TV, DSS, CD, RECEIVER)
Use to select the components registered at the respective input. Press POWER (1/ϕ) key to switch the component ON/OFF.

3 Numeric keys → [31]
Provide functions identical to those of the original remote control supplied with the component you are controlling.

4 MUTE key → [22]
Use to temporarily mute the sound.

5 VOLUME +/- keys → [21]
Use to adjust the receiver volume.

6 GUIDE key
Use to operate other components.
SET UP key → [19]
Use to select the speakers' settings etc.

7 MULTI CONTROL keys → [19]
Use to control a variety of settings.
Use to operate other components.

P.CALL <<|>|> keys → [24]
If tuner is selected as the input source, these keys function as P.CALL keys.

SELECT key
Use to operate other components.

8 REC M. key
Use to select the REC MODE.

INFO/OSD key
Use to operate other components.

9 TUNING <<|>|> key
Use to operate the tuner or selected component.
If CD, MD or TAPE is selected as the input source, this key functions as search key.

10 BAND key → [23]
Use to select the broadcast band.

▶|| key
If CD is selected as the input source, this key functions as the play/pause key.
If MD or TAPE is selected as the input source, this key functions as the play key.

11 ● key
If VCR is selected, this key functions as record key.
If TAPE is selected, this key functions as reverse play key.

12 INPUT SELECTOR keys (PHONO, TUNER, MD/TAPE, CD/DVD, VIDEO1, VIDEO2, VIDEO3, DVD, AV AUX) → [21]
Use to select the input sources.

13 DISC SEL. key
Use to operate other components.

14 DISC SKIP key
If CD is selected as the input source, this key functions as the multi-CD player disc skip key.

15 LED indicator
Blinks to show that a signal is sending.

16 POWER (1/ϕ) key → [18] → [31]
Use to switch the receiver and other registered components ON/OFF.

17 LSTN.M key → [27]
Use to select the listening mode.

LAST key
Use to operate other components.

18 ENTER key
Use to operate other components.

19 SOUND key → [28]
Use to adjust the sound quality and the ambience effects.

SLEEP key
Use to operate other components.

20 CHANNEL +/- keys
Use to select the channel.

<<||>||> keys
When in DVD player operations, these keys function as skip keys.

21 CINE.EQ key → [22]
Use to switch the status of CINEMA EQ.

INPUT key
Use to operate other components.

22 EXIT/RETURN key
Use to operate other components.

23 DIM. key
Use to adjust the brightness of the display.

MENU key
Use to operate other components.

24 A/B key
If TAPE is selected as the input source, this is (A and B) of a double cassette deck.
+100 key
Use to select the disc number with the multi-CD player.

|| key
Use to operate other components.

25 AUTO key → [23]
Use to select the auto tuning mode.

■ key
If CD, MD or TAPE is selected as the input source, this key functions as the stop key.

26 BASS BOOST key → [21]
Use to select the maximum adjustment setting for the low frequency range.

Remote control unit (RC-R0613) (KRF-V7050D)

This remote control unit can be used not only for Kenwood products but also for other non-Kenwood products by setting the appropriate maker setup codes. → [31]

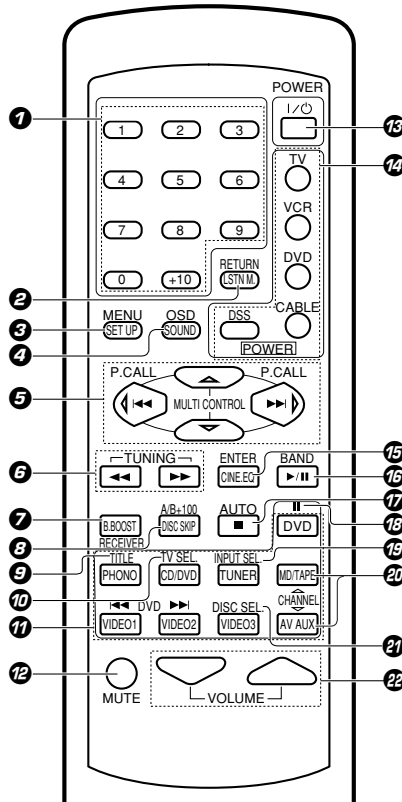

If the name of a function is different on the receiver and on the remote control, the name of the remote control key in this manual is indicated in parentheses.

- 1 Numeric keys** → [31]
Provide functions identical to those of the original remote control supplied with the component you are controlling.
- 2 LSTN M. key** → [27]
RETURN key
Use to select the listening mode.
- 3 SET UP key** → [19]
MENU key
Use to operate other components.
- 4 SOUND key** → [28]
OSD key
Use to operate other components.
- 5 MULTI CONTROL keys** → [19]
P.CALL <<</>>> keys
Use to control a variety of settings. Use to operate other components.
- 6 TUNING <<</>>> keys** → [24]
Use to select the input source, these keys function as P.CALL keys.
- 7 B.BOOST key** → [21]
Use to select the maximum adjustment setting for the low frequency range.
- 8 DISC SKIP key** → [21]
Use to return to the operation of the receiver.
- 9 TITLE key** → [21]
Use to operate other components.
- 10 TV SEL. key** → [21]
Use to operate other components.
- 11 INPUT SELECTOR keys (DVD, PHONO, CD/DVD, TUNER, MD/TAPE, VIDEO1, VIDEO2, VIDEO3, AV AUX)** → [21]
Use to select the input sources.
- 12 MUTE key** → [22]
Use to temporarily mute the sound.

- 13 POWER (I/O) key** → [19]
Use to turn the receiver on and off.
- 14 Source POWER key (TV, VCR, DVD, DSS, CABLE)** → [19]
Use to turn the other components on and off.
- 15 ENTER key** → [22]
Use to operate other components.
- 16 BAND key** → [23]
CINE.EQ key
Use to switch the status of CINEMA EQ.
- 17 II key** → [23]
Use to select the broadcast band.
- 18 DVD key** → [23]
Use to select the auto tuning mode.
- 19 AUTO key** → [23]
■ key
Use to select the input source, this key functions as the play/pause key.
- 20 CHAN. key** → [23]
Use to select the channel.
- 21 DISC SEL. key** → [21]
Use to operate other components.
- 22 VOLUME keys** → [21]
Use to adjust the receiver volume.

Setting up the system

Make connections as shown in the following pages. When connecting the related system components, be sure to also refer to the instruction manuals supplied with the components you are connecting. Do not connect the power cord to a wall outlet until all connections are completed.

DTS disclaimer clause

DTS Digital Surround™ is a discrete 5.1 channel digital audio format available on CD, LD, and DVD software which consequently cannot be decoded and played back inside most CD, LD, or DVD players. For this reason, when DTS-encoded software is played back through the analog outputs of the CD, LD, or DVD player, excessive noise will be exhibited. To avoid possible damage to the audio system, proper precautions should be taken by the consumer if the analog outputs are connected directly to an amplification system. To enjoy DTS Digital Surround™ playback, an external 5.1 channel DTS Digital Surround™ decoder system must be connected to the digital output (S/P DIF, AES/EBU, or TosLink) of the CD, LD or DVD player.

Notes

1. Be sure to insert all connection cords securely. If their connections are imperfect, the sound may not be produced or noise may interfere.
2. Be sure to remove the power cord from the AC outlet before plugging or unplugging any connection cords. Plugging/unplugging connection cords without disconnecting the power cord can cause malfunctions and may damage the unit.
3. Do not connect power cords from components whose power consumption is larger than what is indicated on the AC outlet at the rear of this unit.

Analog connections

Audio connections are made using RCA pin cords. These cables transfer stereo audio signal in an "analog" form. This means the audio signal corresponds to the actual audio of two channels. These cables usually have 2 plugs each end, one red for the right channel and one white for the left channel. These cables are usually packed together with the source unit, or are available at your local electronics retailer.

Input mode settings

CD/DVD, VIDEO2, VIDEO3 and DVD/6ch inputs each include jacks for digital audio input and analog audio input.

You must select beforehand which type of input is to be used for each connected component.

The initial factory settings for audio signal playback (CD/DVD, DVD/6ch) and (VIDEO2, VIDEO3) are digital and analog respectively.

To use the analog audio input for playback instead (if, for example, you have connected a VCR to the VIDEO2 or VIDEO3 input), you must set the input mode for the corresponding input to the analog mode.

After completing connections and turning on the receiver, follow the steps below.

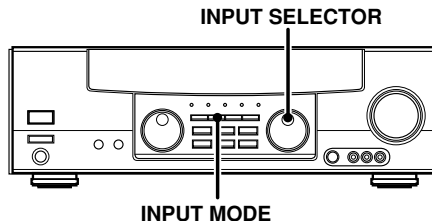

- 1 Use the **INPUT SELECTOR** knob to select **CD/DVD**, **VIDEO2**, **VIDEO3** or **DVD/6ch**.
- 2 Press the **INPUT MODE** key.

Each press switches the setting as follows:

In DTS play mode

- 1 **D-AUTO** (digital input, auto sound)
- 2 **D-MANUAL** (digital input, manual sound)

In DVD/6ch play mode

- 1 **D-AUTO** (digital input, auto sound)
- 2 **D-MANUAL** (digital input, manual sound)
- 3 **6ch INPT** (DVD/6ch input)
- 4 **ANALOG** (analog input, manual sound)

In modes other than DTS or DVD/6ch play mode

- 1 **D-AUTO** (digital input, auto sound)
- 2 **D-MANUAL** (digital input, manual sound)
- 3 **ANALOG** (analog input, manual sound)

Digital input:

Select this setting to play digital signals from a DVD, CD, or LD player.

Analog input:

Select this setting to play analog signals from a cassette deck, VCR, or record player.

Auto sound:

In the auto sound mode (**AUTO SOUND** indicator lights), the receiver selects the listening mode automatically during playback to match the type of input signal (Dolby Digital, PCM, DTS) and the speaker setting. The initial factory setting is auto sound on.

To keep the receiver set to the currently selected listening mode, use the **INPUT MODE** key to select "**D-MANUAL**" (manual sound). However, even when this setting is selected, there may be cases in which the listening mode is selected automatically to match a Dolby Digital source signal depending on the combination of listening mode and source signal.

If the **INPUT MODE** key is pressed quickly, sound may not be produced.

10 **Connecting audio components**

Preparations

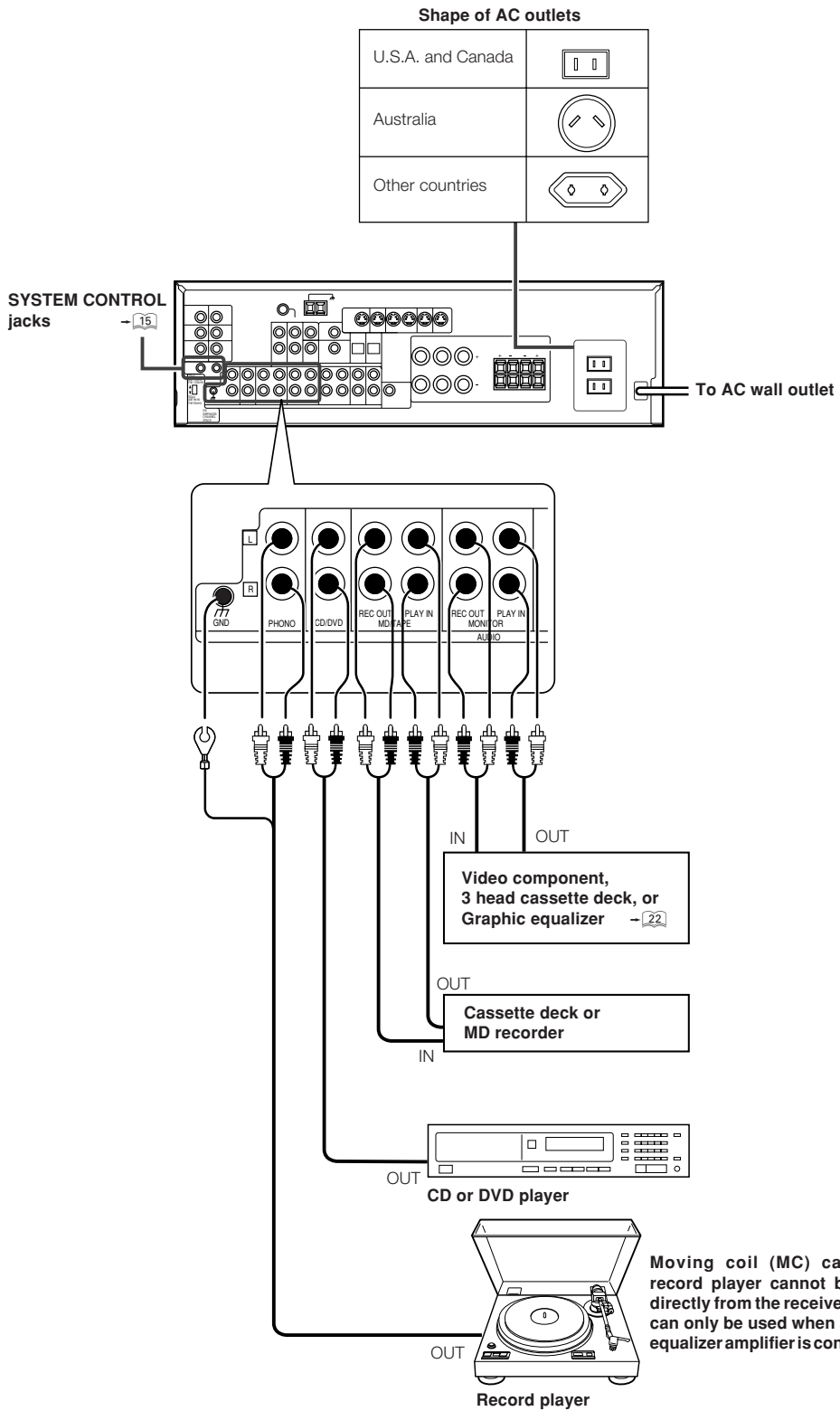

Connecting video components

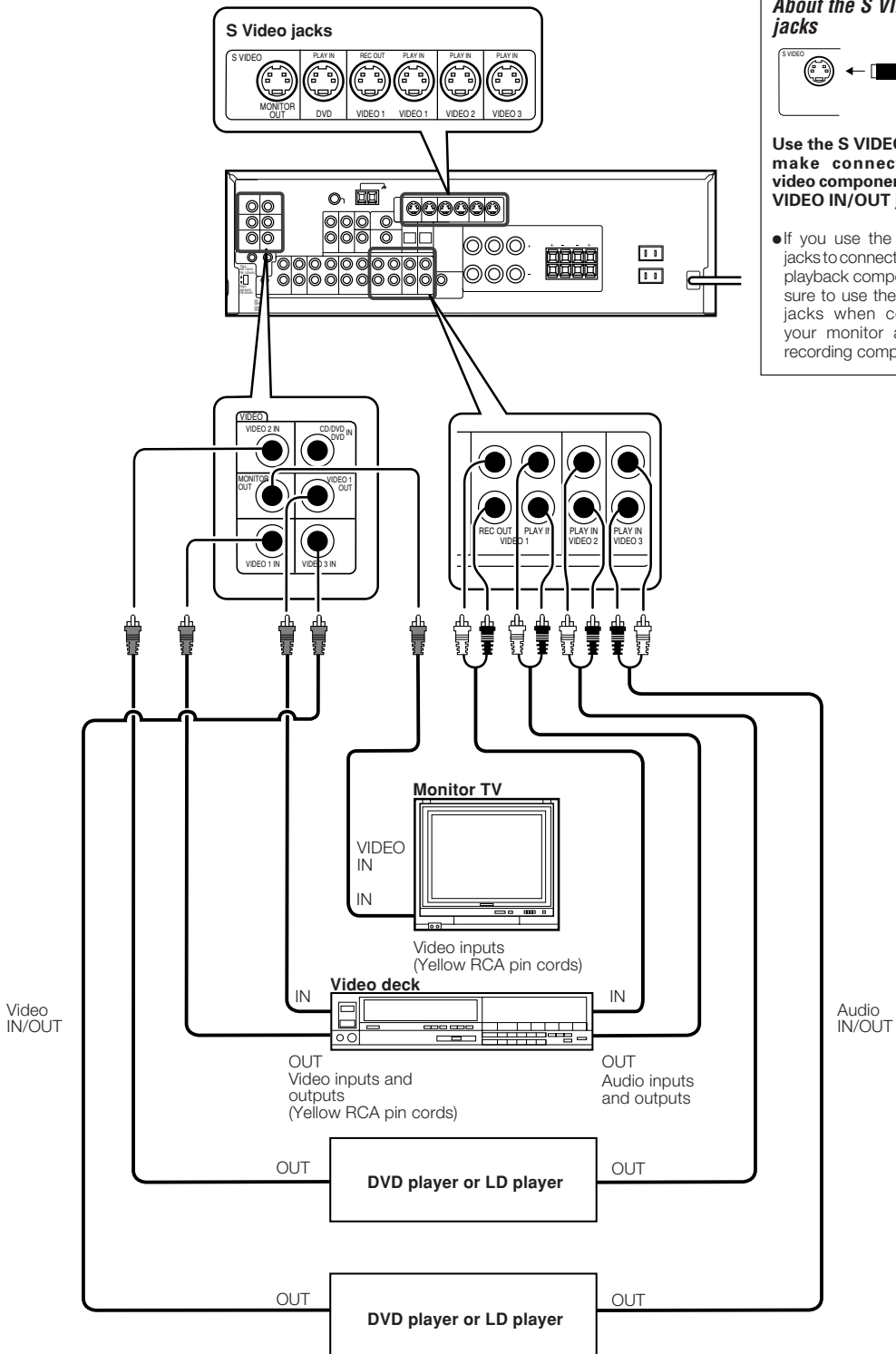

About the S VIDEO jacks

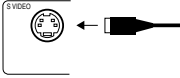

Use the S VIDEO jacks to make connections to video components with S VIDEO IN/OUT jacks.

- If you use the S VIDEO jacks to connect your video playback components, be sure to use the S VIDEO jacks when connecting your monitor and video recording components.

A video component with digital audio outputs should be connected to the VIDEO2 or VIDEO3 jacks.

Connecting a DVD player (6-channel input)

If you have connected a DVD player to the receiver with digital connection, be sure to read the "Input mode settings" section carefully. 

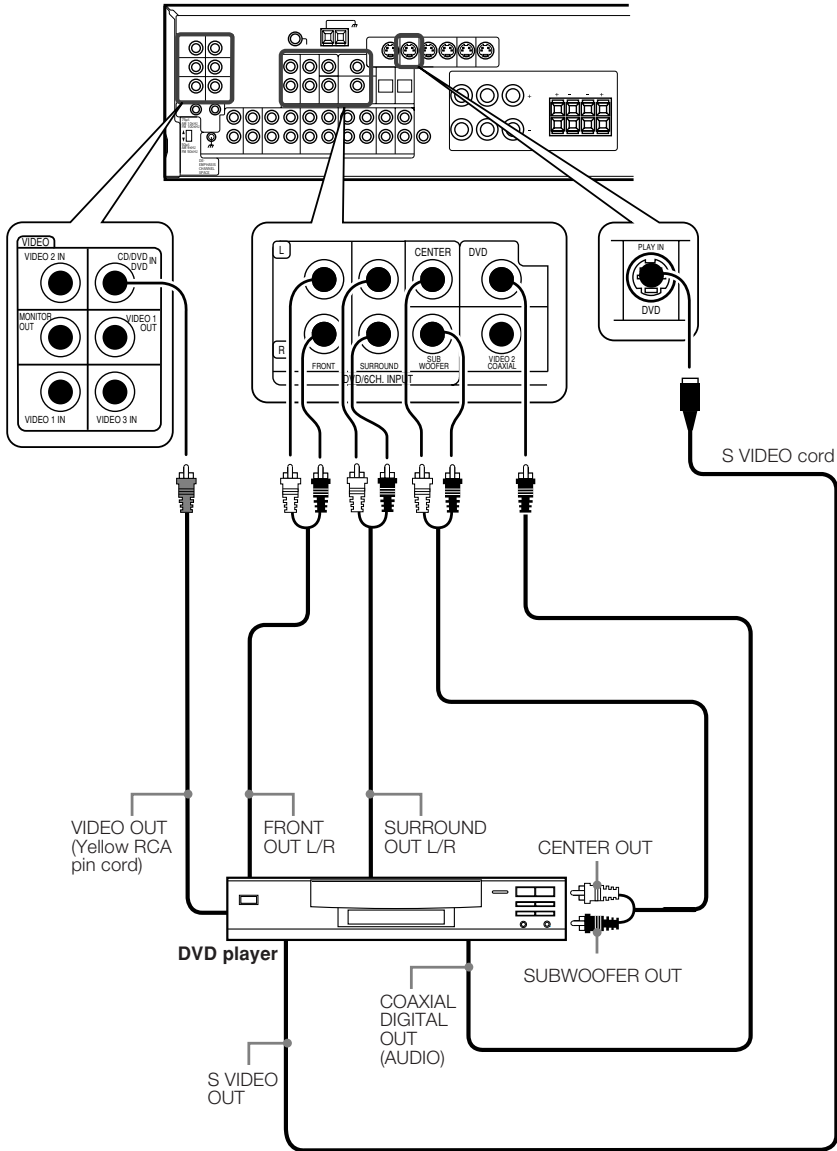

To switch the speakers off, press the MUTE key.

CAUTION (Except for U.S.A. and Canada)

Be sure to adhere to the following. Or proper ventilation will be blocked causing damage or fire hazard.

- Do not place any object impairing heat radiation onto the top of the unit.
- Leave a space around the unit (from the largest outside dimension including projection) equal or greater than, shown below.

Top panel : 50 cm Side panel : 10 cm Back panel : 10 cm

CAUTION (For U.S.A. and Canada)

Be sure to adhere to the following. Or proper ventilation will be blocked causing damage or fire hazard.

- Do not place any object impairing heat radiation onto the top of the unit.

Digital connections

The digital in jacks can accept DTS, Dolby Digital, or PCM signals. Connect components capable of outputting DTS, Dolby Digital, or standard PCM (CD) format digital signals.

If you have connected any digital components to the receiver, be sure to read the "Input mode settings" section carefully. 

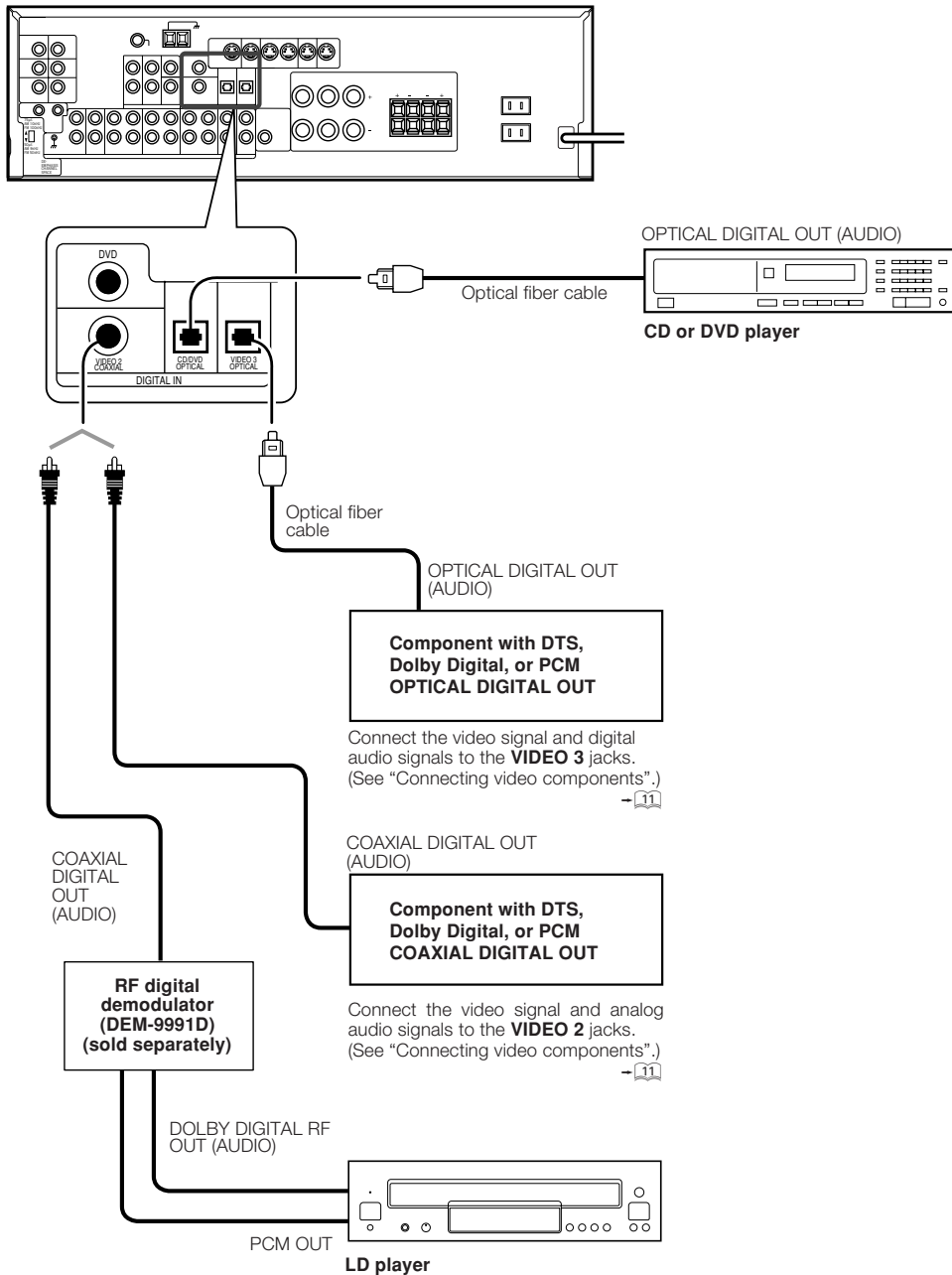

To connect an LD player with a DIGITAL RF OUT, connect the LD player to the KENWOOD RF digital demodulator (DEM-9991D). Next, connect the DIGITAL OUT jacks of the demodulator to the DIGITAL IN jacks of the receiver. Connect the video signal and analog audio signals to the VIDEO 2 or VIDEO 3 jacks. (See "Connecting video components".)

Connecting to the AV AUX jacks

The **AV AUX** jacks are convenient for connection of video components such as a camcorder or a video game.

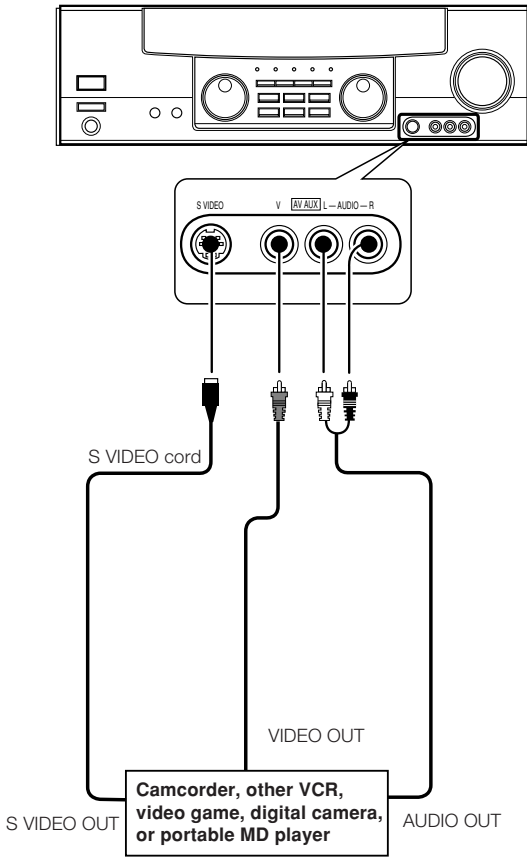

- To select the source connected to the AV AUX jacks, select AV AUX by using the INPUT SELECTOR knob. - 21
- When you connect the audio source such as the MD player, you do not need to connect the video cable.
- When you connect the unit and the component with the S VIDEO cord, you can get better picture quality.

Connecting the antennas

AM loop antenna

The supplied loop antenna is for use indoors. Place it as far as possible from the receiver, TV set, speaker cords and power cord, and adjust the direction for best reception.

AM antenna terminal connections

- 1 Push lever.
- 2 Insert cord.
- 3 Release lever.

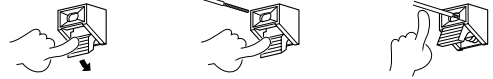

FM indoor antenna

The supplied indoor antenna is for temporary use only. For stable signal reception we recommend using an outdoor antenna. Disconnect the indoor antenna when you connect one outdoors.

FM antenna terminal connections

Insert cord.



FM outdoor antenna

Lead the 75Ω coaxial cable connected to the FM outdoor antenna into the room and connect it to the **FM 75Ω** terminal.

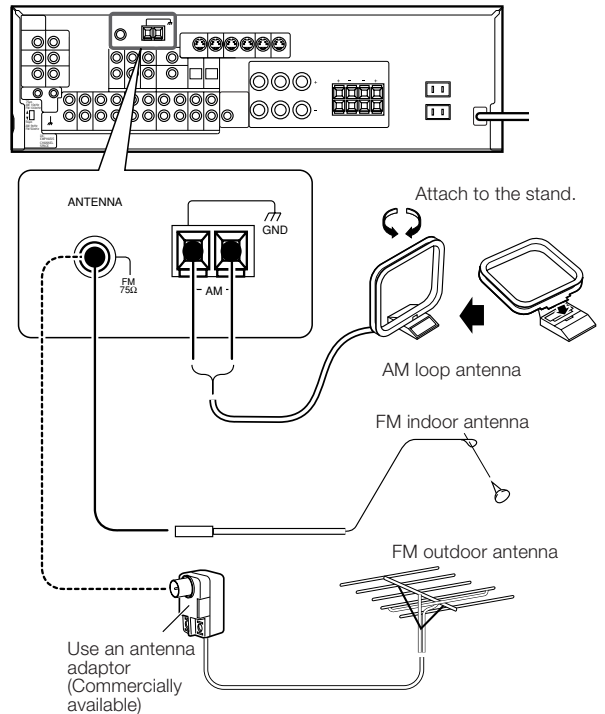

Connecting the system control

Connecting system control cords after connecting a KENWOOD audio component system lets you take advantage of convenient system control operations.

This unit is compatible only with the [SL-16] mode. The system control operation is not available if the unit is connected in the [XS8], [XS], or [XR] connection mode.

If your component has the mode select switch, set the connected components to the [SL16] mode.

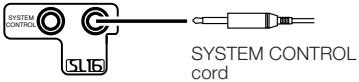

- You may connect the system control cord to either the left or right jack.

EXAMPLE: [SL16] mode connections

The underlined portion represents the setting of the system control mode.

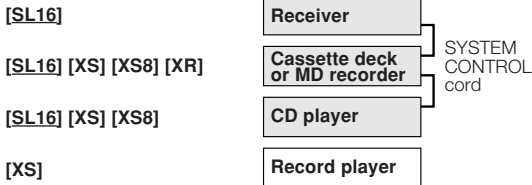

- In order to take advantage of the system control operations, the components must be connected to the correct jacks. To use a CD player it must be connected to the CD jacks. To use a cassette deck (or MD recorder) it must be connected to the MD/TAPE jacks. When using more than one CD player (etc.) only the one connected to the specified jacks may be connected for system control.
- Some CD players and cassette decks are not compatible with the [SL16] system control mode. Do not make system connections with equipment that is not [SL16] compatible.
- Some MD players are not system control compatible. You cannot make system control connections to this kind of equipment.

Notes

- [SL16] equipment cannot be combined with [XR], [XS], and [XS8] equipment for system operations. If your equipment consists of this kind of combination, please do not connect any system control cords. Even without system control cords, normal operations can be carried out without effecting performance.
- Do not connect system control cords to any components other than those specified by KENWOOD. It may cause a malfunction and damage your equipment.
- Be sure the system control plugs are inserted all the way in to the system control terminals.

SYSTEM CONTROL OPERATIONS

Remote Control

Lets you operate this unit with the system remote supplied with the receiver.

Automatic Operation

When you start playback from a source component, the input selector on this unit switches to that component automatically.

Synchronized Recording

Lets you synchronize recording with the start of playback when recording from CD, MD or analog discs.

Registering setup codes for KENWOOD audio components

If you own remote controllable KENWOOD audio components that are not compatible with system control, registering the setup code enables you to control those components using the remote control supplied with this unit (without connecting system control cords). To register setup codes for your remote controllable KENWOOD audio components, see "Registering setup codes for other components".

— 35 — 39

Connecting the speakers

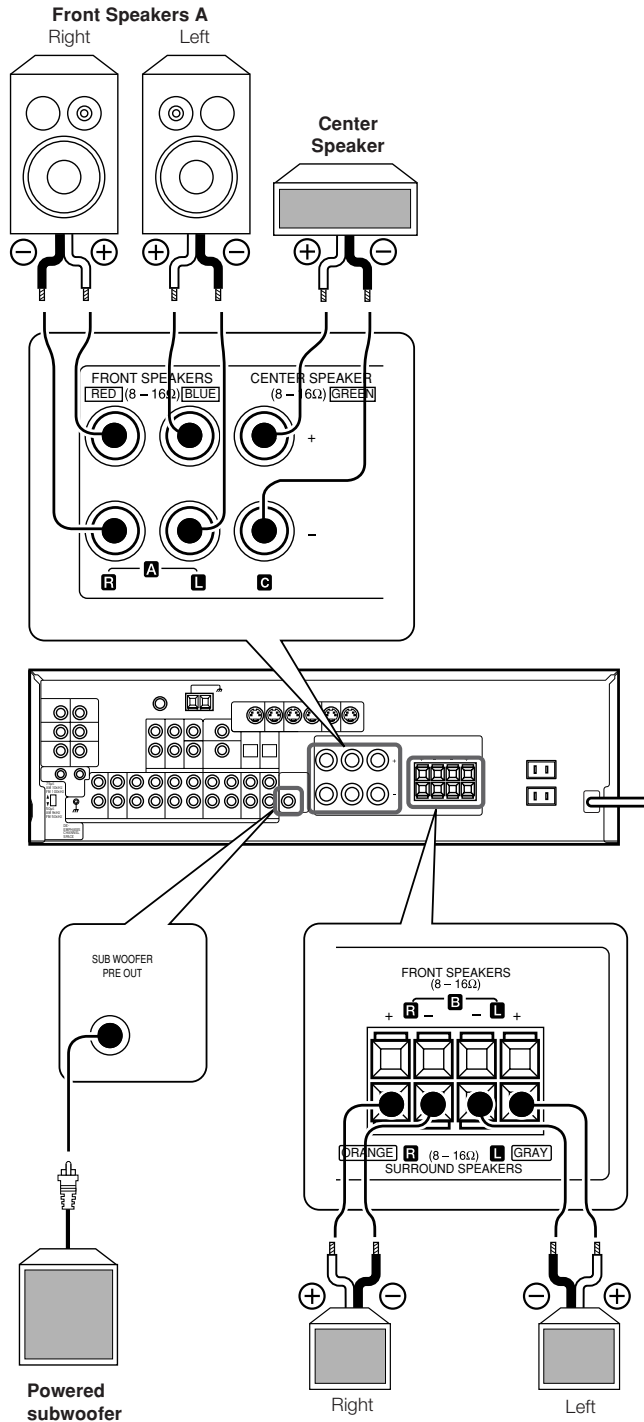

Surround Speakers
 (Be sure to connect both surround speakers)

Use the FRONT SPEAKERS B terminals if you want to connect a second front speaker system.

Connecting the terminals

1 Strip coating. 

2 Loosen. 

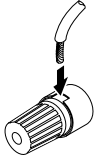
3 Insert. 

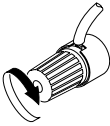
4 Secure. 

1 Strip coating. 

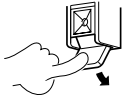
2 Push the lever. 

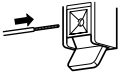
3 Insert the cord. 

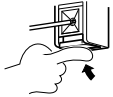
4 Return the lever. 

Connection of banana plugs (For U.S.A. and Canada)

1 Secure. 

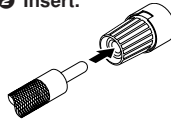
2 Insert. 

• Sound will not be heard if the speaker terminal is not fully secured.

- Never short circuit the + and – speaker cords.
- If the left and right speakers are connected inversely or the speaker cords are connected with reversed polarity, the sound will be unnatural with ambiguous acoustic imaging. Be sure to connect the speakers correctly.

Speaker impedance

After confirming the speaker impedance indications printed on the rear panel of the receiver, connect speakers with matching impedance ratings. Using speakers with a rated impedance other than that indicated on the rear panel of the receiver could result in malfunctions or damage to the speakers or receiver.

Speaker placement

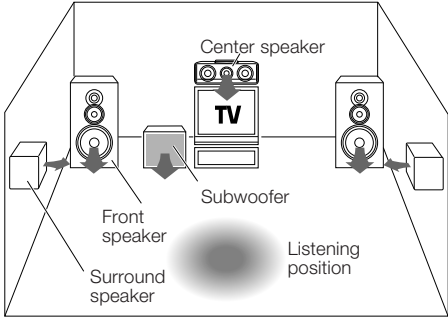

Front speakers : Place to the front left and right of the listening position. Front speakers are required for all surround modes.

Center speaker : Place front and center. This speaker stabilizes the sound image and helps recreate sound motion. Be sure to connect a center speaker when using the Dolby 3 Stereo mode.

Surround speakers : Place to the direct left and right, or slightly behind, the listening position at even heights, approximately 1 meter above the ears of the listeners. These speakers recreate sound motion and atmosphere. Required for surround playback.

Subwoofer : Reproduces powerful deep bass sounds.

- Although the ideal surround system consists of all the speakers listed above, if you don't have a center speaker or a subwoofer, you can divide those signals between the available speakers in the speaker settings steps to obtain the best possible surround reproduction from the speakers you have available.



Channel space switching

(Except for the USA, Canada, UK, Europe, and Australia)

The space between radio channels has been set to the one that prevails in the area to which the system is shipped. However, if the current channel space setting does not match the setting in the area where the system is to be used, for instance when you move from area 1 or area 2 shown in the following table or vice versa, proper reception of AM/FM broadcasts cannot be expected. In this case, change the channel space setting in accordance with your area by referring to the following table.

Area	CHANNEL Space Frequency
1 USA, Canada and South American countries	FM: 100 kHz AM: 10 kHz
2 Other countries	FM: 50 kHz AM: 9 kHz

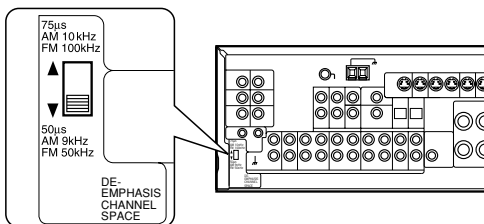

Move switch lever to match your area with a small screwdriver or other pointed tool.

Preparing the remote control

For VR-507 (RC-R0720)

Loading the batteries

① Remove the cover.

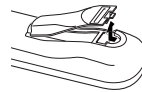

② Insert the batteries.

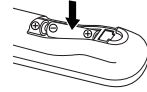

③ Close the cover.

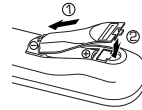

- Insert two AA-size (R6) batteries as indicated by the polarity markings.

For KRF-V7050D (RC-R0613)

Loading the batteries

① Remove the cover.

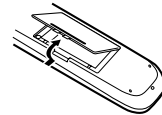

② Insert the batteries.

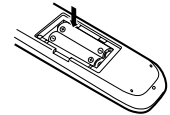

③ Close the cover.

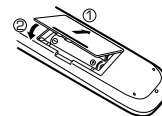

- Insert two AA-size (R6) batteries as indicated by the polarity markings.

Operation

When the **STANDBY** indicator is lit, the power turns ON when you press the **POWER** key on the remote control. When the power comes ON, press the key you want to operate.

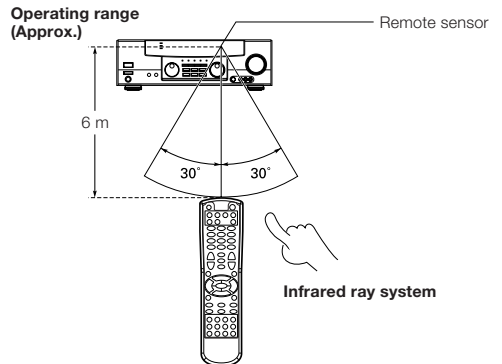

- When pressing more than one remote control key successively, press the keys securely by leaving an interval of 1 second or more between keys.

Notes

1. The supplied batteries may have shorter lives than ordinary batteries due to use during operation checks.
2. When the remote-controllable distance gets shorter than before, replace both batteries with new ones.
3. Placing the remote sensor in direct sunlight, or in direct light from a high frequency fluorescent lamp may cause a malfunction. In such a case, change the location of the system installation to prevent malfunction.

Speaker settings

To enable you to obtain optimum enjoyment from the receiver's listening modes, make sure to complete the speaker settings (subwoofer, front, center, and surround speakers) as described below.

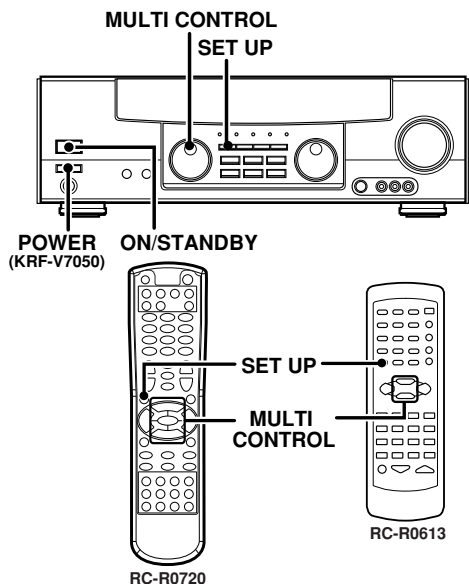

1 Turn on the power to this receiver by pressing **POWER** (I/O) key.

2 Select a speaker system.

1 Press the **SET UP** key such that the subwoofer setting indication "SUBW ON" appears.



2 Use the **MULTI CONTROL** knob or keys to select the appropriate subwoofer setting.

- ➔ **1 SUBW ON:** Subwoofer setting mode to the receiver is ON.
- ➔ **2 SUBW OFF:** Subwoofer setting mode to the receiver is OFF.

- The initial setting is "SUBW ON".
- When the setting "SUBW OFF" is selected, the front speakers are automatically set to "FRNT LRG" and the procedure skips to step **4**.
- When subwoofer output sound is required, select "FRNT NML".

3 Press the **SET UP** key to accept the setting.

- The front speakers setting indication "FRNT" appears.



4 Use the **MULTI CONTROL** knob or keys to select the appropriate front speakers setting.

- ➔ **1 FRNT NML (normal):** Average size front speakers are connected to the receiver.
- ➔ **2 FRNT LRG (large):** Large front speakers are connected to the receiver.

- For "FRNT LRG" selection, no sound will be heard from SUBW even when it is set to ON. However, if you select CINEMA EQ when subwoofer is selected, you will be able to hear sound from the subwoofer.
- When in STEREO mode, the sound goes directly to front speaker.

5 Press the **SET UP** key to accept the setting.

- The center speaker setting indication "CNTR" appears.

6 Use the **MULTI CONTROL** knob or keys to select the appropriate center speaker setting.

If you selected "LRG" as the front speakers setting,

- ➔ **1 CNTR LRG (large):** A large center speaker is connected to the receiver.
- ➔ **2 CNTR NML (normal):** An average size center speaker is connected to the receiver.
- ➔ **3 CNTR OFF:** Center speaker setting mode to the receiver is OFF.

If you have selected "NML" as the front speakers setting,

- ➔ **1 CNTR ON:** Center speaker setting mode to the receiver is ON.
- ➔ **2 CNTR OFF:** Center speaker setting mode to the receiver is OFF.

7 Press the **SET UP** key again to accept the setting.

- The surround speaker setting indication "SURR" appears.

8 Use the **MULTI CONTROL** knob or keys to select the appropriate surround speaker setting.

If you selected "LRG" as the center speaker setting,

- ➔ **1 SURR LRG (large):** Large surround speakers are connected to the receiver.
- ➔ **2 SURR NML (normal):** Average size surround speakers are connected to the receiver.
- ➔ **3 SURR OFF:** Surround speaker setting mode to the receiver is OFF.

If you have selected other than "LRG" as the center speaker setting,

- ➔ **1 SURR ON:** Surround speaker setting mode to the receiver is ON.
- ➔ **2 SURR OFF:** Surround speaker setting mode to the receiver is OFF.

9 Press the **SET UP** key again to accept the setting.

- The receiver enters the speaker volume level adjustment mode.
- In steps **2** and **4**, indications appear only for the selected channels of the speakers that require adjusting.

3 Adjust the speaker volume level.

From your usual listening position, adjust the volume levels. The volume levels from each speaker should be the same.

1 Use the **MULTI CONTROL** knob or keys to adjust the volume level of the test tone output from the speaker channel to be adjusted.

The channel indication blinks while the test tone is being output.

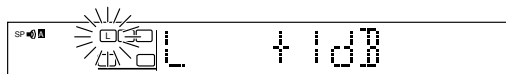

The test tone is heard from the speakers in the following sequence for 2 seconds each:

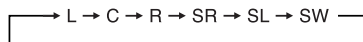

- If you change the volume level settings for the speakers while listening to music, the settings referred to on this page are also changed.
- If the speaker setting selects are OFF, the speaker level settings are reset.

2 Press the **SET UP** key.

- The test tone is turned off. The receiver enters the mode for inputting the distance to the speakers.

Continued to next page

20 4 Input the distance to the speakers.

1 Measure the distance from the listening position to each of the speakers.

Jot down the distance to each of the speakers.

- Distance to front speakers: ___ feet (meters)
- Distance to center speaker: ___ feet (meters)
- Distance to surround speakers: ___ feet (meters)

2 Use the MULTI CONTROL knob or keys to select the distance to the front speakers.

The speaker indicator to be adjusted blinks.

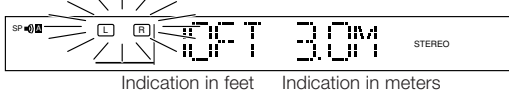

- The allowable setting range is 1 to 30 feet (0.3 to 9.0 m), adjustable in 1 foot (0.3 m) increments.

3 Press the SET UP key to accept the settings.

4 Repeat steps 2 and 3 to input the distance for each of the speakers.

5 Setup is complete when the input indication reappears.

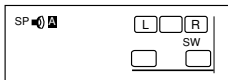

Display when all speakers have been selected.

- The speakers you have selected should appear on the display. Confirm that all the speakers have been correctly selected.

Input level adjustment (analog sources only)

If the input level of an analog source signal is too high, the CLIP indicator will blink to indicate the source signal. Adjust the input level.

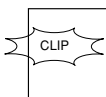

1 Use the INPUT SELECTOR knob to select the source of which the input level you want to adjust.

- You can store a separate input level for each input source. If the MONITOR function is ON, you can store an input level for when MONITOR is on independently of the input levels for the input sources.

2 Press the SOUND key repeatedly until the "INPUT" indication appears.

3 Use the MULTI CONTROL knob or keys to adjust the input level.



- The adjustment mode is displayed for approximately eight seconds.
- The input level may be adjusted to any one of three settings: 0dB, -3dB, and -6dB. (The initial setting is 0dB.)

4 Press the SOUND key again to return to the input indication.

Preparing for playback

Some preparatory steps are needed before starting playback.

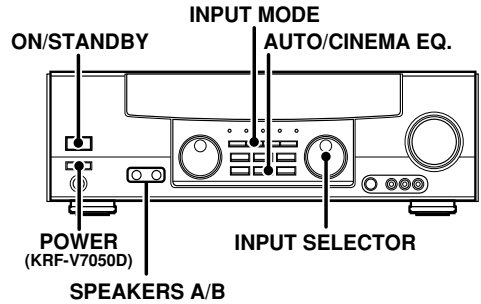

Selecting the input mode

If you have selected a component connected to the CD/DVD, VIDEO2, VIDEO3 or DVD/6ch jacks, make sure that the input mode setting is correct for the type of audio signal to be used.

Selecting MD/TAPE

Select the source name corresponding to the component connected to the MD/TAPE jacks. The initial factory setting is "TAPE". To change the source to "MD," follow the steps below:

- 1 Use the INPUT SELECTOR knob to select "TAPE".
- 2 Hold down the AUTO/CINEMA EQ. key for more than 2 seconds.
 - The source indication changes to "MD".
 - To return to the original indication, repeat procedure 2.

Selecting the speaker system

Press the SPEAKERS A or B key to select the speaker system to be used.

- A ON** : Sound from the speakers connected to the SPEAKERS A terminals on the rear panel.
- B ON** : Sound from the speakers connected to the SPEAKERS B terminals on the rear panel. No sound will be heard from the subwoofer.
- A+B ON** : Sound from both the speakers connected to the SPEAKERS A and B terminals on the rear panel.
- A+B OFF** : No sound from the speakers. Use this setting when listening with headphones for stereo sound in all playback modes.

The indicator for the speakers you want to use should be lit.

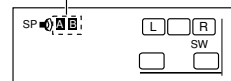

- Selecting "6ch INPT" by pressing the INPUT MODE key, whereby "DVD/6ch" is the input source will cause SPEAKER A to be selected automatically.

Turning on the receiver

- 1 Turn on the power to the related components.
- 2 Turn on the power to this receiver by pressing POWER and ON/STANDBY keys.

Listening to a source component

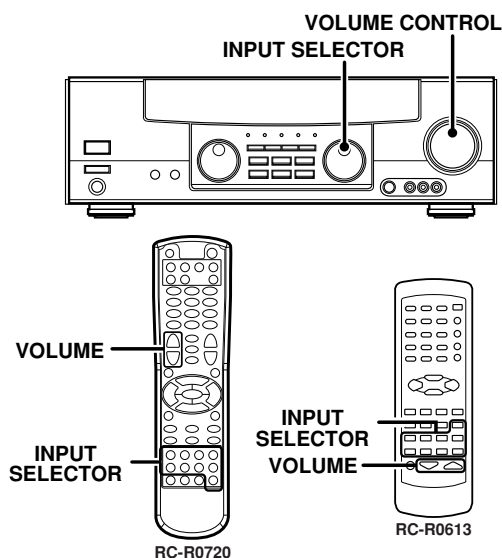

- 1 Use the **INPUT SELECTOR** knob to select the source you want to listen to.

The input sources change as shown below:
Selecting a source using the **INPUT SELECTOR** knob.

- 1 "PHONO"
- 2 "TUNER"
- 3 "CD/DVD"
- 4 "TAPE" or "MD"
- 5 "VIDEO1"
- 6 "VIDEO2"
- 7 "VIDEO3"
- 8 "DVD/6ch"
- 9 "AV AUX"

- 2 Start playback from the selected source.

- 3 Use the **VOLUME CONTROL** knob or **VOLUME** keys to adjust the volume.

Adjusting the sound

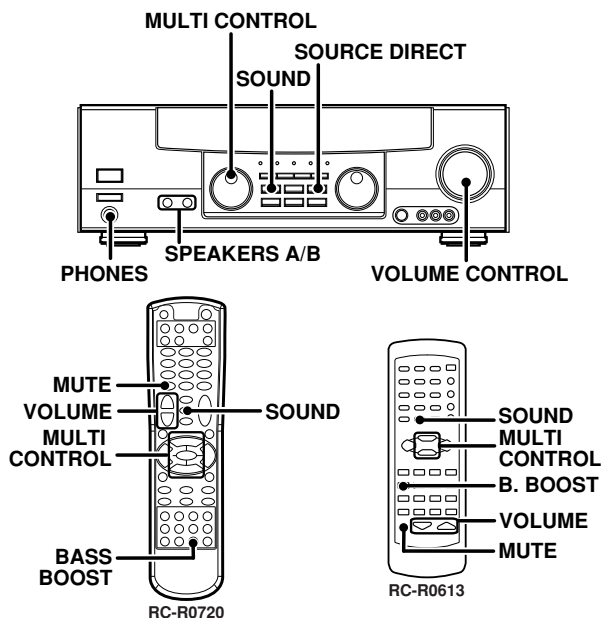

Adjusting the tone

You can adjust the sound quality when the receiver is in the PCM stereo and analog stereo mode.

- 1 Press the **SOUND** key to select the tone mode to be adjusted.

BASS: Select this to adjust the low frequency range.
(Press the **SOUND** key once.)

TREB: Select this to adjust the high frequency range.
(Press the **SOUND** key twice.)



- 2 Use the **MULTI CONTROL** knob or keys to adjust the sound quality.

- The bass and treble levels are adjustable from -10dB to +10dB in 2 step increments.
- The adjustment item is displayed for approximately 8 seconds.

Once-touch low frequency emphasis (bass boost) (remote control only)

You can adjust the sound quality when the receiver is in the PCM stereo and analog stereo modes.

Press the **B. BOOST** or **BASS BOOST** key.

- Press the key once to select the maximum (+10dB) low frequency emphasis setting.
- This key does not function when the receiver is in the sound quality or ambience effects adjustment mode.

Switching back to the previous setting

Press the **B. BOOST** or **BASS BOOST** key again.

Muting the sound

The **MUTE** key lets you mute the sound of the speakers.

Press the **MUTE** key.

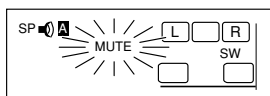

Blinks

To cancel

Press the **MUTE** key again so that the “**MUTE**” indicator goes off.

- **MUTE ON** can also be deactivated by turning the volume control knob.

SOURCE DIRECT playback (for analog input sources only)

Use this function to pass the source material direct to the amplifier, bypassing any audio processing.

Press the **SOURCE DIRECT** key.

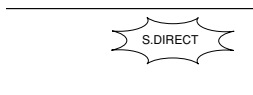

- When you press the **LISTEN MODE**, **SOUND**, or **SET UP** keys, or switch to another input source, **SOURCE DIRECT** playback will be canceled.
- If **CINEMA EQ.** is switched **ON**, **SOURCE DIRECT** key will not be effective.
- If **SOURCE DIRECT** is switched **ON**, **CINEMA EQ.** function will not be effective.

To cancel

Press the **SOURCE DIRECT** key again.

- If **SOURCE DIRECT** playback was activated while in surround mode, canceling **SOURCE DIRECT** playback will reactivate the previous surround mode.

Listening with headphones

- 1 Press the **SPEAKERS A** or **B** key so that the speaker indicator goes off.

Make sure the **SPEAKERS** indicators are turned off.

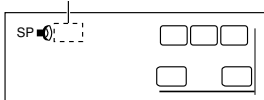

- If you turn off all of the speakers when in surround mode, the surround mode will be canceled as well, resulting in stereo playback.

- 2 Connect headphones to the **PHONES** jack.

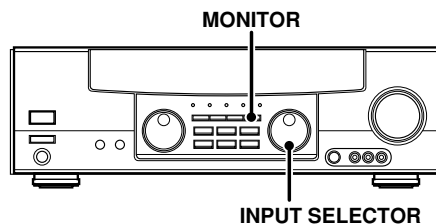

- 3 Use the **VOLUME CONTROL** knob or **VOLUME** keys to adjust the volume.

Recording**Recording audio (analog sources)****Recording a music source**

- 1 Use the **INPUT SELECTOR** knob to select the source (other than “**MD/TAPE**”) you want to record.
- 2 Set the cassette deck or MD recorder to record.
- 3 Start playback, then start recording.

Recording tapes or MD (with MONITOR function)**MONITOR → MD/TAPE recording**

- 1 Press the **MONITOR** key.
- 
- 2 Use the **INPUT SELECTOR** knob to select a source other than “**MD/TAPE**”.
 - 3 Start playback on the cassette deck connected to the **MONITOR** jacks and start recording on the cassette deck or MD recorder connected to the **MD/TAPE** jacks.

MD/TAPE → MONITOR recording

- 1 Use the **INPUT SELECTOR** knob to select “**MD/TAPE**.”
 - 2 Start playback on the cassette deck connected to the **MD/TAPE** jacks and start recording on the cassette deck or MD recorder connected to the **MONITOR** jacks.
- To copy tapes using a double cassette deck, refer to the instruction manual of the double cassette deck.

MONITOR function (analog sources only)

You can connect a cassette deck or graphic equalizer to the **MONITOR** jacks of the receiver. If a graphic equalizer is connected, the **MONITOR** key should be left in the on position. Alternately, if a cassette deck equipped with a 3-head system is connected to the **MONITOR** jacks, you will be able to monitor the just-recorded signal while making recordings on the cassette deck. By switching the **MONITOR** key on and off, you can compare the sound of the source signal and the just-recorded signal. For more information, refer to the instruction manual of the connected component.

Recording video

- Use the **INPUT SELECTOR** to select the video source (other than "VIDEO1") you want to record.
- Set the video deck connected to **VIDEO 1** to record.
 - Select the **REC MODE** to record a digital input source.
- Start playback, then start recording.
 - Recording may not be normal for some video software. This is due to the copy guard condition. — [45]

Recording audio (digital sources)

Switch on the **REC** mode to record a digital input source. Usually use the **A-REC (Auto-Record)** mode to record audio input sources. When the digital mode changes during recording in the **A-REC** mode, the audio input source may be interrupted momentarily.

Recording music in A-REC or M-REC mode

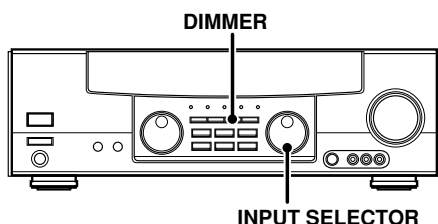

- Use the **INPUT SELECTOR** knob to select the source (CD/DVD, DVD/6ch, VIDEO2 or VIDEO3) you want to record.
- Set the cassette deck or MD recorder to record.
- Press and hold the **DIMMER** key for more than 2 seconds to select the **A-REC** or **M-REC** mode.
 - The mode changes every 2 seconds as shown below.

- | | |
|--|---|
| <ol style="list-style-type: none"> Rec mode off : A-REC : M-REC : | <p>The digital input record mode is switched off.</p> <p>The digital input signals (DTS, Dolby Digital, or PCM) are identified automatically and converted into stereo signals that are ready for recording.</p> <p>The input signal type at the moment this mode is selected is held throughout this mode.</p> |
|--|---|

For A-REC mode:

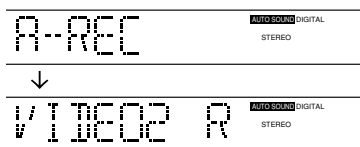

For M-REC mode:

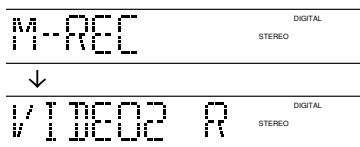

- Start playback, then start recording.
 - If the audio reproduction stops in the middle due to change in the input signals, etc., press the **DIMMER** key.

Listening to radio broadcasts

The receiver can store up to 40 stations in the memory and recall them by one-touch operation.

Tuning radio stations

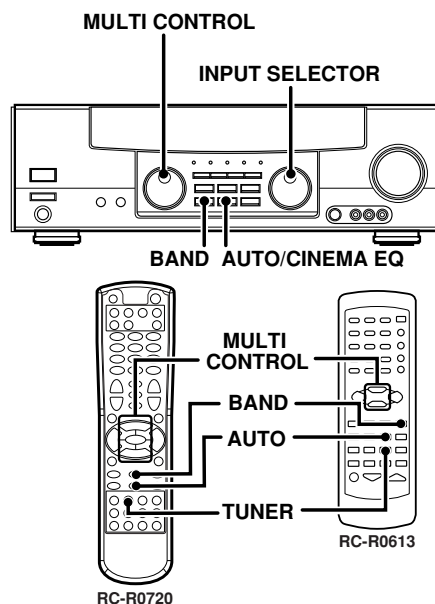

- Use the **INPUT SELECTOR** knob or **TUNER** key to select the tuner.
- Use the **BAND** key to select the desired broadcast band.

Each press switches the band as follows:

- FM
- AM

"AM" or "FM" indicator appears in the display

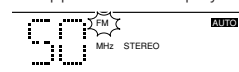

- Use the **AUTO/CINEMA EQ** key to select the desired tuning method.

Each press switches the tuning method as follows:

- AUTO lit (auto tuning)
- AUTO not lit (manual tuning)

"AUTO" indicator lights up in the display.

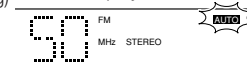

- Normally, set to "AUTO" (auto tuning). If the radio waves are weak and there is a lot of interference, switch to manual tuning. (With manual tuning, stereo broadcasts will be received in monaural.)

- Use the **MULTI CONTROL** knob or keys to select the station.

Frequency display "ST." lights when a broadcast is being received in stereo.



"TUNED" is displayed when a station is received.

- Auto tuning** : The next station is tuned automatically.
- Manual tuning** : Turn the knob (press the key) to select the desired station.

Presetting radio stations manually

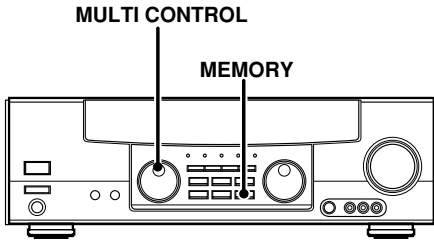

- 1** Tune to the station you want to store.
- 2** Press the **MEMORY** key while receiving the station.

Blinks for 5 seconds Lights for 5 seconds

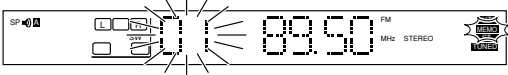

Proceed to step **3** within 5 seconds.
(If more than 5 seconds elapse, press the **MEMORY** key again).

- 3** Use the **MULTI CONTROL** knob to select one of the station presets (1 – 40).
- 4** Press the **MEMORY** key again to confirm the setting.

- Repeat steps **1**, **2**, **3**, and **4** to store as many stations as necessary.
- If you store a station at a previously used preset, the old station will be replaced by the new one.

Receiving preset stations

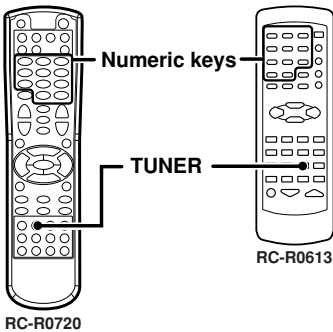

- 1** Press **TUNER** to select tuner as the source.
- 2** Enter the number of the preset station you want to receive (up to "40").

Press the numeric keys in the following order:

For "15", press **+10**, **5**
 For "20", press **+10**, **+10**, **0**

- If you make a mistake entering a two digit number, press the **+10** key repeatedly to return to the original display and start again.



Receiving preset stations in order (P.CALL)

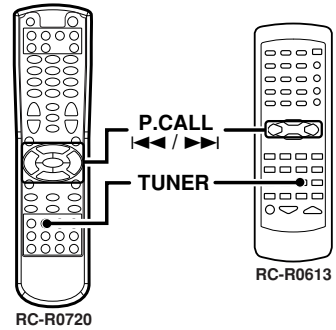

- 1** Press **TUNER** key to select the tuner as the source.
- 2** Use the **P.CALL** **◀◀/▶▶** key to select the desired station.

- Each time you press the key, another preset station is received in order.

Pressing the **P.CALL ▶▶** does the following:

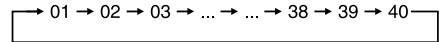

Pressing the **P.CALL ◀◀** does the following:

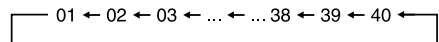

Holding down the **▶▶** or **◀◀** key, lets you skip through the presets, receiving each preset station at 0.5 second intervals.

This receiver is equipped with listening modes that allow you to enjoy an enhanced sonic ambience with a variety of video sources.

In order to obtain the optimum effect from the surround modes, make sure to input the proper speaker settings beforehand. 

Surround modes

DTS

The DTS multi-channel audio format is available on CD, LD and DVD software. DTS is a strictly digital format and can not be decoded inside most CD, LD or DVD players. For this reason, if you attempt to listen to DTS encoded software through the analog output of your new CD, LD or DVD player, you will experience digital noise in most cases. This noise can be quite loud if the analog output is connected directly to a high power amplification system. Proper measures for playing the digital output as described below should be taken to avoid this situation. To enjoy DTS Digital Surround playback, an external 5.1 channel DTS Digital Surround decoder system or an amplifier with a built-in DTS Digital Surround decoder must be connected to the digital output (S/P DIF, AES/EBU or TosLink) of a CD, LD or DVD player. All models are incorporated with the DTS decoder.

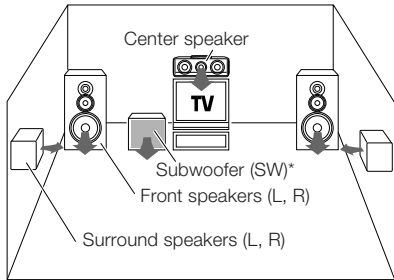

* Optional in this mode.

* LFE = Low Frequency Effects. This channel delivers separate non-directional bass signals to the subwoofer for more dynamic deep bass sound effects. DTS has a .1 or LFE channel. The indication "LFE" appears in the display when a signal is being input for this channel.

Manufactured under license from Digital Theater Systems, Inc. US Pat. No. 5,451,942 and other worldwide patents issued and pending. "DTS" and "DTS Digital Surround" are trademarks of Digital Theater Systems, Inc. © 1996 Digital Theater Systems, Inc. All rights reserved.



Manufactured under license from Dolby Laboratories. Dolby, Pro Logic and the double-D symbol are trademarks of Dolby Laboratories. Confidential Unpublished Works. ©1992-1999 Dolby Laboratories, Inc. All rights reserved.

"Circle Surround and the  symbol are trademarks of SRS Labs, Inc. in the United States and selected foreign countries. Circle Surround technology is incorporated under license from SRS Labs, Inc".

Dolby Digital

The Dolby Digital surround format lets you enjoy up to 5.1 channels of digital surround sound from Dolby Digital program sources (such as Laserdisc or DVD software marked ). Compared with previous Dolby surround, Dolby Digital provides even better sound quality, greater spatial accuracy, and improved dynamic range.

Note

Although a full set of speakers (front left, right, and center, surround left and right, and a subwoofer) is required for true 5.1 channel Dolby Digital surround sound, this receiver lets you enjoy Dolby Digital (and Dolby Surround) program sources, even if you connect only the front speakers.

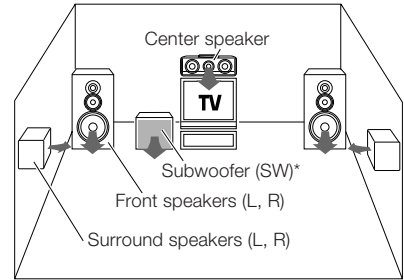

* LFE = Low Frequency Effects. This channel delivers separate non-directional bass signals to the subwoofer for more dynamic deep bass sound effects. Although only Dolby Digital soundtracks incorporate a separate low frequency channel, connecting a subwoofer will also improve deep bass performance in the other surround modes. The indication "LFE" appears in the display when a signal is being input for this channel.

Dolby 3 Stereo

Dolby 3 Stereo is available for systems that do not have surround speakers. When in the Dolby 3 Stereo mode, the surround information is redirected to the front left and right speakers. This mode is designed for use with Dolby Surround program sources, but can also improve sound field unity for programs that are not Dolby Surround encoded. Dialog positioning and sound image definition, however, may not be as accurate when used with programs that are not Dolby Surround encoded.

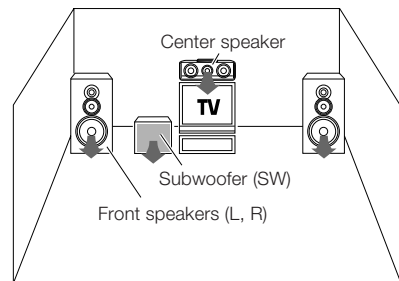

Dolby PRO LOGIC II

Dolby Pro Logic II was designed specifically to provide a new sense of spatiality, directionality and articulation of sounds from Dolby Surround encoded sources (such as video and Laserdisc software marked **DD** [DOLBY SURROUND]). This is achieved with an intelligent, built-in feedback logic design, a matrix surround decoding and the decoding of stereo, full bandwidth surround outputs. The PRO LOGIC II modes programmed into this receiver are "MOVIE", "MUSIC" and "PRO LOGIC". The "MOVIE" mode of the PRO LOGIC II has preset characteristics to produce a calibrated, high-level surround sound playback while the "MUSIC" mode has user-adjustable characteristics to offer the three optional controls, like "Dimension", "Center Width" and "Panorama mode" to allow optimization of the soundfields as desired. The "Dimension" control allows the user to gradually adjust the soundfield either towards the front or towards the rear; the "Center Width" control allows various adjustment of the left-center-right speakers' balance; the "Panorama mode" extends the front stereo image to include the surround speakers for an exciting "wraparound" effect with side wall imaging.

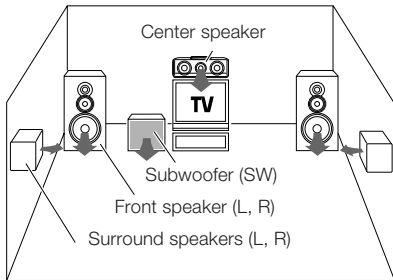

Multi channel music (SRS Circle Surround)

SRS Circle surround enables you to listen to multi channel sound from the stereo source. We assume you have already enjoyed listening to Dolby digital sound/DTS multi channel sound with your multi speakers. Now, this time try listening to the stereo source (ex. Audio CD) using your multi speakers. You may discover a new type of "stereo" sound through SRS Circle Surround.

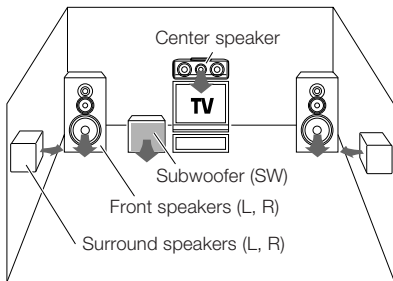

DSP mode

The DSP mode lets you add the atmosphere of a live concert or hall to almost any type of program source. These modes are particularly effective when used with stereo program sources, like CD, television, and FM radio. You might enjoy trying the ARENA, JAZZ CLUB, THEATER, STADIUM or DISCO mode the next time you watch a concert or sporting event!

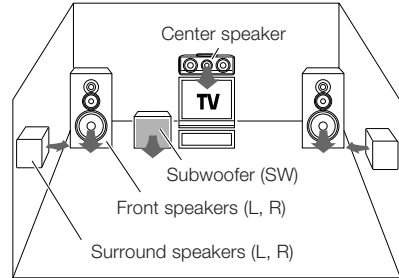

What's DSP?

DSP stands for Digital Signal Processor. The way a sound is heard in an actual environment depends on a variety of different factors. One of the most important is reverberation (the act of decaying elements of sound echoing in various places). The DSP modes produce the feeling of presence by using the DSP to create reverberation, without spoiling the sound quality of the original signal.

DVD 6-channel mode

Using a DVD player or the like equipped with six (5.1) output channels and the receiver, you can enjoy multi-channel encoded DVD source material in all its splendor. Since the source signals are digital and each channel is input independently, the resulting sound quality, sense of spaciousness, and dynamic range are superb.

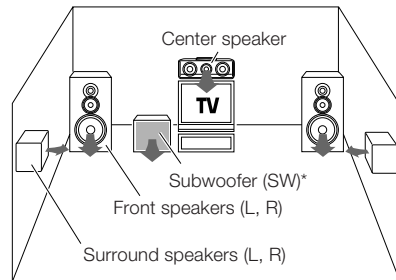

* LFE = Low Frequency Effects. This channel delivers separate non-directional bass signals to the subwoofer for more dynamic deep bass sound effects.

Surround play

The DTS compatible models can reproduce a CD, DVD, or LD carrying the DTS mark. DOLBY DIGITAL can be used when playing DVD or LD software bearing the **DOLBY DIGITAL** mark and DOLBY DIGITAL format digital broadcasts (etc.). DOLBY PRO LOGIC and DOLBY 3 STEREO can be used when playing video, DVD, or LD software bearing the **DOLBY SURROUND** mark.

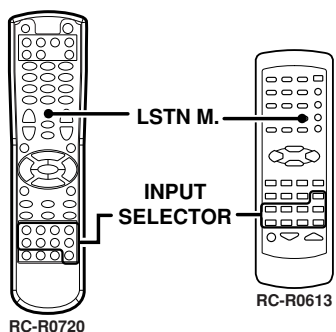
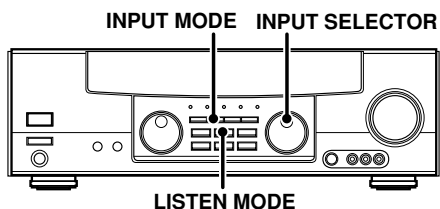

Preparations

- Turn ON related components.
- Complete "Preparing for surround sound" (speaker settings). → [19]
- Use the **INPUT SELECTOR** to select the component you wish to play back with surround sound.
- Use the **INPUT MODE** key to select the input mode (analog or digital) for the source you wish to play back. → [9]
- Noise will be produced when a DTS source is played by selecting the analog input.

1 Start playing the video software.

2 Press the LISTEN MODE or LSTN M. key to select the listening mode.

The listening mode settings are stored separately for each input. If the input mode is set to digital auto ("AUTO SOUND" lights), the receiver selects the optimal listening mode automatically based on the type of input signal and the speaker settings.

Each press of the **LISTEN MODE** or **LSTN M.** key switches the setting as listed below. The listening mode settings are different depending on the type of input signal.

When the DOLBY DIGITAL signal is input:

(The DOLBY DIGITAL, PROLOGIC, or 3 STEREO indicator lights up.)

- 1 **DOLBY DIGITAL**: DOLBY DIGITAL surround
- 2 **PL II MOVIE**: PRO LOGIC II surround MOVIE mode (The PRO LOGIC indicator lights up.)
- 3 **PL II MUSIC**: PRO LOGIC II surround MUSIC mode (The PRO LOGIC indicator lights up.)
- 4 **PRO LOGIC**: PRO LOGIC II surround PRO LOGIC mode (The PRO LOGIC indicator lights up.)
- 5 **3 STEREO**: 3-STEREO mode (The 3 STEREO indicator lights up)
- 6 **STEREO**: Normal stereo playback

When you select DOLBY DIGITAL

"DOLBY DIGITAL" will be scrolled from right to left.

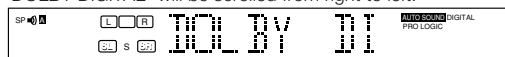

When the DTS signal is input:

(The DTS indicator lights up.)

- 1 **DTS**: DTS surround
- 2 **STEREO**: Normal stereo playback

When the analog signal or the digital signal (except for DOLBY DIGITAL or DTS signal) is input:

- 1 **PL II MOVIE**: PRO LOGIC II surround MOVIE mode (The PRO LOGIC indicator lights up.)
- 2 **PL II MUSIC**: PRO LOGIC II surround MUSIC mode (The PRO LOGIC indicator lights up.)
- 3 **PRO LOGIC**: PRO LOGIC II surround PRO LOGIC mode (The PRO LOGIC indicator lights up.)
- 4 **3 STEREO**: 3-STEREO mode (The 3 STEREO indicator lights up.)
- 5 **CIRCLE SURROUND**: CS 5.1 surround (The CS 5.1 indicator lights up.)
- 6 **ARENA**: DSP Surround ARENA mode.
- 7 **JAZZ CLUB**: DSP Surround JAZZ CLUB mode.
- 8 **THEATER**: DSP Surround THEATER mode.
- 9 **STADIUM**: DSP Surround STADIUM mode.
- 10 **DISCO**: DSP Surround DISCO mode.
- 11 **STEREO**: Normal stereo playback. Sound is produced from the two front channels only.

- If Dolby Digital or DTS signal having more channels than the maximum number of playback channels available using the receiver's current settings is input, the **DOWNMIX** indicator on the front panel lights up and downmixing is performed to match the number of available channels.

3 Adjust the volume.

Notes

- Depending on the type of the signal or speaker setting, some listening modes cannot be selected.
- When playback is started, the sound may be cut or interrupted before the input source is confirmed as Dolby Digital.
- To enjoy Dolby Digital surround (as well as all the other listening modes) from a single component, be sure to use a Dolby Digital compatible source component. Connect the Dolby Digital compatible source component's Dolby Digital format digital audio signal to one of the **DIGITAL INPUT** jacks on the back of the receiver. Connect the normal audio signal correctly to the respective component's **AUDIO** jacks. → [10] → [11] → [12] → [13]

DVD 6-channel playback

Using a DVD player or the like equipped with six (5.1) output channels and the receiver, you can enjoy surround sound playback.

When you try to play a disc other than Dolby Digital such as DTS CD, no sound is produced or, noise may be heard. To avoid this situation, make sure that you connect the component to the receiver's DVD/6ch. INPUT jacks through a surround processor which can decode the surround signal you want to listen to.

Connecting a DVD player which can decode the surround signal itself is also acceptable.

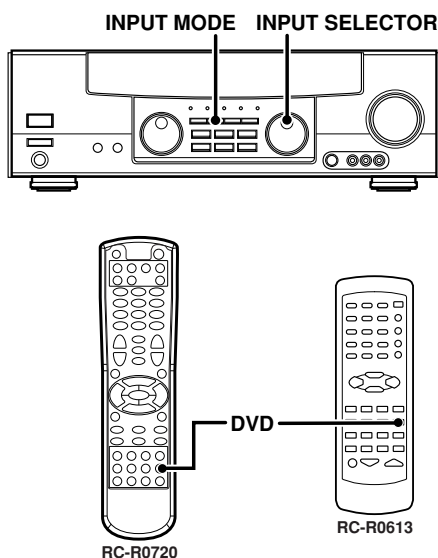

Preparations

- Connect your DVD player to the DVD/6ch jacks of the receiver.
- Turn on all other components that will be used.
- Complete "Preparing for surround sound".

- [19]

1 Select "DVD/6ch" as the input source.

- If speaker system B is on when "DVD/6ch" is selected as the input source, it switches off and speaker system A turns on automatically.

2 Select "6ch INPT" by pressing the INPUT MODE key.

3 Start playback of the DVD software.

4 Adjust the volume.

- It is not possible to adjust the volume level or sound quality (SET UP, SOUND) of the channels separately when the receiver is in the DVD/6ch mode. Adjust the volume with the controls of the DVD player. For the powered subwoofer, you can adjust the volume of the subwoofer using the subwoofer's own volume control.

Convenient functions

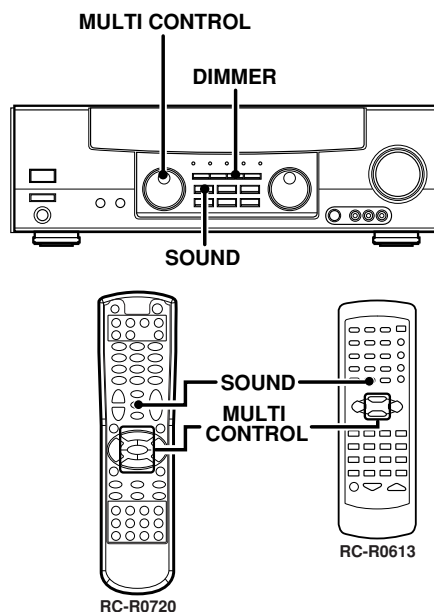

Adjusting the sound

You can make further adjustments to the sound while listening to playback in the surround mode.

- 1 Press the SOUND key until the desired item appears in the display.

Each time you press the button, the menu changes as follows: Note that some items are not displayed in certain modes.

- 1 BASS (low frequency range sound quality adjustment - PCM and analog stereo mode only) → [21]
- 2 TREB (high frequency range sound quality adjustment - PCM and analog stereo mode only) → [21]
- 3 C (center speaker level adjustment)
- 4 SR (right surround speaker level adjustment)
- 5 SL (left surround speaker level adjustment)
- 6 SW (subwoofer level adjustment)
- 7 INPUT (input level adjustment - analog mode only) → [20]
- 8 NIGHT (midnight mode on/off - Dolby Digital mode only)
- 9 CINEMA or MUSIC (Circle surround mode only)
- 10 PANORAMA (panorama mode on/off)*
- 11 DIMENSION (dimension adjustment)*
- 12 CENTER WIDTH (center width adjustment)*

* Pro Logic II Music mode only

- 2 Use the MULTI CONTROL knob or keys to adjust the setting as desired.

- The adjustment item is displayed for approximately 8 seconds.

Midnight mode (Dolby Digital mode only)

When watching movies at night, you might not be able to raise the volume as loud as normal. Midnight mode compresses the dynamic range of previously specified parts of the Dolby Digital sound track (like scenes with sudden increases in volume) to minimize the difference in volume between the specified and non-specified parts. This makes it easy to hear all of the sound track, even when listening at low volumes.

1 Press the SOUND key repeatedly until "NIGHT" appears on the display.

- This can be selected only if CD/DVD, DVD/6ch, VIDEO2 or VIDEO3 is selected as the source and the listen mode is set to "DOLBY DIGITAL."

2 Use the MULTI CONTROL knob or keys to select the ON or OFF setting.



- The adjustment item is displayed for approximately 8 seconds.
- Some Dolby Digital software may not be compatible with the Midnight mode.

Circle surround mode

When you enjoy multi sound from the stereo source (Circle Surround), you can select the circle surround mode.

1 Press the LISTEN MODE or LSTN M. key repeatedly until "CIRCLE SURROUND" appears on the display.

2 Press the SOUND key repeatedly until "CINEMA" or "MUSIC" appears on the display.

3 Use the MULTI CONTROL knob or keys to select "CINEMA" (for movies) or "MUSIC" (for music).

Panorama mode (Pro Logic II music mode only)

When listening to music, you will be able to enjoy the "wraparound" sound effect when you adjust the panorama mode.

1 Press the SOUND key repeatedly until "PANORAMA" appears on the display.

- The PANORAMA setting indication scrolls across the display.

"PANORAMA" will be scrolled from right to left.



2 Use the MULTI CONTROL knob or keys to select PANORAMA ON or OFF.

- ➔ **1 ON** :PANORAMA mode is ON.
- ➔ **2 OFF** :PANORAMA mode is OFF.

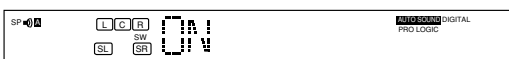

Dimension mode (Pro Logic II music mode only)

When listening to music with certain recordings, you will also be able to achieve a suitable balance from all the speakers by adjusting the dimension mode.

1 Press the SOUND key repeatedly until "DIMENSION" appears on the display.

- The DIMENSION indication scrolls across the display.

2 Use the MULTI CONTROL knob or keys to adjust the soundfield towards the rear or the front.

Soundfield is adjusted towards the front.

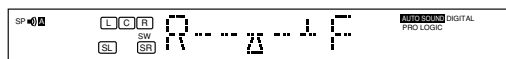

Soundfield is in neutral position.



Soundfield is adjusted towards the rear.

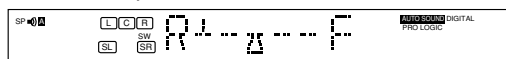

Center width mode (Pro Logic II music mode only)

Center width adjustment allows you to enjoy an enhanced sound when listening to music through center image from only center speaker, or left and right speakers or various combinations adjustments.

1 Press the SOUND key repeatedly until "CENTER WIDTH" appears on the display.

- The CENTER WIDTH indication scrolls across the display.
- When the center speaker is switched OFF, this mode will not be effective.

2 Use the MULTI CONTROL knob or keys to adjust the left-center-right output.

Center image will be heard from center speaker only.



Center image will be heard from left and right speakers only.



- When in other positions, center image from center speaker, left and right speakers can be heard simultaneously with various combinations.

Subwoofer adjustment

It is easy to adjust the volume of the subwoofer using the remote control.

- 1 Press the **SOUND** key repeatedly until “SW” appears on the display.



- 2 Use **MULTI CONTROL** knob or keys to adjust the volume.
 - The adjustment range is -10 dB to $+10$ dB.

Display dimmer adjustment

The dimmer function lets you select the brightness of the receiver's display. You might find this useful if you darken your room to watch movies or listen to music.

Each time you press the DIMMER key, the display brightness changes among the three available settings. Select the brightness level you find most pleasing.

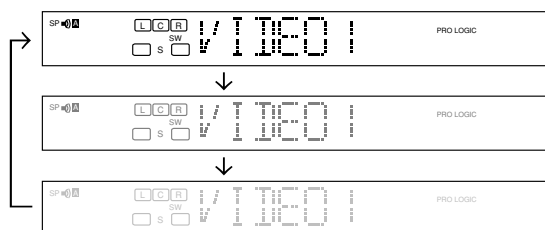

96kHz LPCM playback

The receiver is compatible with the 96kHz LPCM playback. To play a 96kHz DVD, set the listen mode to “STEREO”.

- When “96kHz” appears in the display, press the LISTEN MODE key (the listen mode changes to the STEREO mode).

Basic remote control operations for other components

(For VR-507)

The remote control supplied with this receiver) is also capable of controlling components from a variety of manufacturers once you register the appropriate setup codes into the remote control unit.

Low battery warning

Replace all two batteries with new ones when you notice a shortening of the distance from which the remote control will operate. The remote control is designed to retain setup codes in memory while you change batteries.

Registering setup codes for other components (RC-R0720)

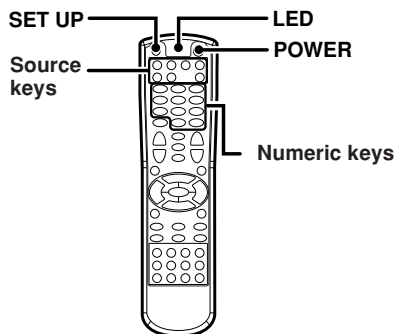

1 Find the setup code of the component to be registered.

- Refer to the setup code lists to find the setup code for the component to be registered. --[35]
- Example: To register a DVD made by KENWOOD, you would enter "0534".

Input	Component	Maker	Code	Key
(DVD)	DVD player	KENWOOD	0534	DVD

2 Press the source key (DVD, CBL, VCR, TV, DSS, CD, RECEIVER).

3 Press and hold the SET UP key until the LED blinks twice, then release the SET UP key.

4 Press the numeric key to enter the first four-digit code for the component.

- If performed correctly, the LED will blink twice.
- Point the remote control at the component and press POWER key once. It should turn ON/OFF but if it does not repeat step 2 to 4.
- If the component still does not work, try searching for the code. --[32]
- If the component does not have a POWER key, press PLAY key instead.

5 Repeat steps 2 to 4 to register additional components until all components have been registered.

Notes

- Although each setup code is designed to work with a number of different models, certain codes may not work with some models. (Also, certain codes may only operate some of the functions available on a given model.)
- In case the code for TV/VCR combos does not work, enter the TV code and the VCR code respectively after checking the codes (See "Searching for your code").
- For TV/VCR combos—if there is no separate TV code listed, enter the code, enter "9-9-3," and press VCR key instead.

Programming TV/VCR combo control

Perform the following instructions to control a TV/VCR Combo:

1 Turn on the TV/VCR Combo and insert a video cassette.

- Read steps 2 to 4 completely before proceeding. You may want to highlight or write down the code for the component you wish to program before moving onto step 2.

2 Press the VCR key once. Next, press and hold the SET UP key until the LED blinks twice, then release the SET UP key.

3 Use the setup codes for TV/VCR Combos to locate the brand name, then press the numeric key to enter the first four-digit code for your component. --[36]

- If performed correctly, the LED will blink twice.
- If the LED did not blink twice, repeat steps 2 through 3 and try entering the same code again.

4 Point the remote control at the component and press the POWER key once.

- It should turn off. If it does not respond, repeat steps 2 through 3, trying each code for your component until you find one that works.
- If it still does not work, try searching for the code, see "Searching for your code". --[32]
- If the device does not have a POWER key, press PLAY key instead.

5 If you have located a setup code that works, but it has a separate TV code, you will also need to program it into the remote control to access the volume control as follows:

- Press the TV key once.
 - The LED will blink twice.
- Press the numeric key to enter the TV code for your TV/VCR combo.
 - If the code is correct, the LED will blink twice.

If there is no separate TV code listed, you will need to perform the following steps to access the volume control:

- Press and hold the SET UP key until the LED blinks twice, then release the SET UP key.
- Press the numeric key to enter "9 - 9 - 3".
 - The LED will blink twice.
- Press the VCR key once.
 - The LED will blink twice.

Searching for your code

If your component does not respond after trying all the codes listed for your component, or if your component is not listed at all, try searching for your code.

For example, to search for a code for your TV:

- 1** Press the TV key once. Next, press and hold the SET UP key until the LED blinks twice, then release the SET UP key.
- 2** Press the numeric key to enter "9 - 9 - 1".
 - The LED will blink twice.
- 3** Point the remote control at the TV and slowly alternate between pressing the POWER and TV keys.
 - Stop when the TV turns ON/OFF.
 - In the search mode, the remote control will send IR codes from its library to the selected device, starting with the most popular code first.
- 4** Press the SET UP key once to lock in the code.
- 5** To search for the codes of your other components, repeat steps 1 through 4, but substitute the appropriate key (i.e., DVD, CBL, VCR, TV, DSS, CD or RECEIVER) for the component you are searching for.

Checking the codes

If you have set up the remote control using the procedures described in "Searching for your codes", you may need to find out which four-digit code is operating your equipment:

For example, to find out which code is operating your TV:

- 1** Press the TV key once. Next, press and hold the SET UP key until the LED blinks twice, then release the SET UP key.
- 2** Press the numeric key to enter "9 - 9 - 0".
 - The LED will blink twice.
- 3** To view the code for the first digit, press "1" once. Wait for 3 seconds, count the number of times the LED blinks (e.g., blinks = 3) and write down that number.
 - If a code digit is "0", the LED will not blink.
- 4** Repeat step 3 three more times for the remaining digits. Use "2" for the second digit, "3" for the third digit, and "4" for the fourth digit.
- 5** To check the codes of your other components, repeat steps 1 through 4, but substitute the appropriate key (i.e., DVD, CBL, VCR, TV, DSS, CD or RECEIVER) for the component you are checking.
 - As suggested earlier on, write down each of the four-digit code.

Re-assigning device keys

The remote control can be set up to control a second TV or VCR, or any combination of eight home entertainment components.

For example, to control a TV, a Cable Converter, and two VCRs using the remote control, you will need to re-assign the unused CD key to operate the second VCR as follows:

- 1** Press and hold the SET UP key until the LED blinks twice, then release the SET UP key.
- 2** Press the numeric key to enter "9 - 9 - 2".
 - The LED will blink twice.
- 3** Press the VCR key once, then press the CD key once.
- 4** To re-assign other device keys, repeat steps 1 through 3 by substituting the key sequence from the below chart for the most popular components:

To re-assign key

Sequence	Perform
TV as 2nd VCR key	SETUP - 9 - 9 - 2 - VCR - TV
TV as 2nd CBL key	SETUP - 9 - 9 - 2 - CBL - TV
TV as 2nd RECEIVER key	SETUP - 9 - 9 - 2 - RECEIVER - TV
TV as 2nd CD key	SETUP - 9 - 9 - 2 - CD - TV
TV back to TV	SETUP - 9 - 9 - 2 - TV - TV
VCR as 2nd TV key	SETUP - 9 - 9 - 2 - TV - VCR
VCR as 2nd CBL key	SETUP - 9 - 9 - 2 - CBL - VCR
VCR as 2nd RECEIVER key	SETUP - 9 - 9 - 2 - RECEIVER - VCR
VCR as 2nd CD key	SETUP - 9 - 9 - 2 - CD - VCR
VCR back to VCR	SETUP - 9 - 9 - 2 - VCR - VCR

- When a re-assignment is done, the LED will blink twice to confirm your choice. At that time, you will need to program the remote control in order to control the new component.

Changing volume lock

The remote control is set to control volume of a component through your TV while in the TV, VCR, or Cable mode. However, in an Audio mode (i.e. CD), you have separate control of your audio component's volume. If your TV is not remote controllable, or if you want volume to be controlled by a different component, you can change the Volume Lock setting to control a volume through a non-associated mode (e.g., through the cable in the TV mode).

To change Volume Lock to the another mode:

- ❶ Press and hold the SET UP key until the LED blinks twice, then release the SET UP key.
- ❷ Press the numeric key to enter "9 - 9 - 3", then press any mode key once (except TV).
 - The LED will blink twice.
- ❸ At this point, whenever you press the VOLUME +/- keys, or the MUTE key, volume will be controlled by your mode choice.
- ❹ To unlock, press the SET UP key until the LED blinks twice, and press the numeric key to enter "9-9-3", then press the VOLUME + key.
 - The LED will blink 4 times upon being unlock.

To change Volume Lock back to the TV mode:

- ❶ Press and hold the SET UP key until the LED blinks twice, then release the SET UP key.
- ❷ Press the numeric key to enter "9 - 9 - 3", then press the TV key.
 - The LED will blink twice.
- ❸ At this point, whenever you press the VOLUME +/- keys, or MUTE key, volume will be controlled by your TV.
- ❹ To unlock, press the TV key, then the SET UP key until the LED blinks twice, and press the numeric key to enter "9-9-3", then press the VOLUME - key.
 - The LED will blink 4 times upon being unlock.

Operating other components

This operation lets you operate the registered components. KENWOOD audio components with system control turn on and off automatically with the receiver via the system control connections.

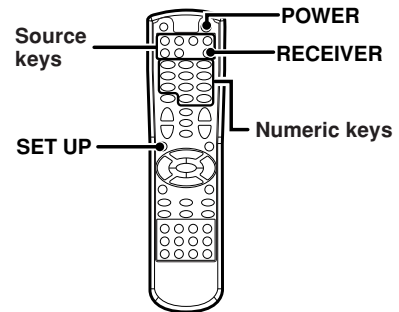

❶ Use the input selector keys to select the component you desire.

- Pressing the input selector keys also changes the input selector on the receiver.
- When you operate your registered TV, VCR, or DVD player, go to step 2.
- When you operate the CD player, Cassette deck, MD player, or Tuner with system control connection, go to step 3.

❷ Press the source key.

❸ Press the operation keys you desire.

→ 42

- To return to the receiver operation mode, press the RECEIVER key.

Notes

- Be sure to point the remote control at the remote sensor on the receiver when you want to operate KENWOOD components connected by system control cords. Otherwise, point the remote control at the component you want to operate.
- To initialize the remote control, press the SET UP key until the LED blinks twice. Then press the numeric key to enter "9-8-0". The LED blinks twice.

Source key	Other components
TV	TV
VCR	VCR, Audio Cassette, DVD, LD, DAT
CBL	Cable, Video Accessories, DSS, Satellite
DVD	VCR, Audio Cassette, DVD, LD
DSS	Satellite, DSS, CABLE, Video Accessories
CD	CD, Home Automation, MD, Amplifier, Tuner, Miscellaneous Audio

(For KRF-V7050D)

The remote control supplied with this receiver is also capable of controlling components from a variety of manufacturers once you register the appropriate setup codes into the remote control unit.

Low battery warning

Replace all two batteries with new ones when you notice a shortening of the distance from which the remote control will operate. The remote control is designed to retain setup codes in memory while you change batteries.

Registering setup codes for other components (RC-R0613)

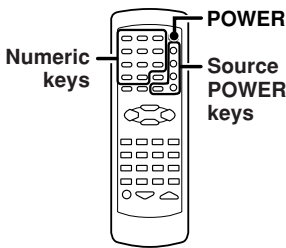

1 Find the setup code of the component to be registered.

- Refer to the setup code lists to find the setup code for the component to be registered. → 39
- Example: To register a DVD made by KENWOOD, you would enter "805".

Input	Component	Maker	Code	Key
(DVD)	DVD player	KENWOOD	805, 808	DVD

2 Hold down the POWER key and press the numeric keys to enter the setup code.

- Example: Press "805" to register a DVD player made by KENWOOD.
- If you push an invalid key, the remote will exit the setup mode.

3 Press the source POWER (TV, VCR, DVD, CABLE, DSS) key for more than 2 seconds, and check to see that the component you want to control turns on.

If the component does not react, and there is more than one setup code, enter another setup code and try again.

- If the component is already on, pressing the source POWER keys for more than 2 seconds will turn it off.

4 Repeat steps 2 to 3 to register additional components until all components have been registered.

Note

Although each setup code is designed to work with a number of different models, certain codes may not work with some models. (Also, certain codes may only operate some of the functions available on a given model.)

Operating other components (RC-R0613)

This operation lets you operate the registered components. KENWOOD audio components with system control turn on and off automatically with the receiver via the system control connections.

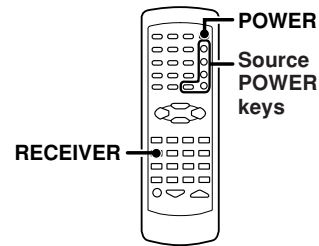

1 Use the input selector keys to select the component you desire.

- Pressing the input selector keys also changes the input selector on the receiver.
- When you operate your registered TV, VCR, DVD player, Cable tuner, or DSS receiver, go to step 2.
- When you operate the CD player, Cassette deck, MD player, or Tuner with system control connection, go to step 2.

2 Press the source POWER key.

3 Press the operation keys you desire.

→ 42

- To return to the receiver operation mode, press the RECEIVER key.

The remote control mode returns to the receiver operation mode when you do not operate for more than 15 seconds.

Note

Be sure to point the remote control at the remote sensor on the receiver when you want to operate KENWOOD components connected by system control cords. Otherwise, point the remote control at the component you want to operate.

Setup code chart (for VR-507 (RC-R0720))

TV Setup codes

Maker	Setup codes
AOC	0030, 0019
Admiral	0093, 0463
Aiko	0092
Akai	0030
Alaron	0179
Ambassador	0177
America Action	0180
Ampro	0751
Anam	0180
Audiovox	0451, 0180, 0092, 0623
Baysonic	0180
Belcor	0019
Bell & Howell	0154, 0016
Bradford	0180
Brockwood	0019
Broksonic	0236, 0463
CXC	0180
Candle	0030, 0056
Carnivale	0030
Carver	0054
Celebrity	0000
Cineral	0451, 0092
Citizen	0060, 0030, 0056, 0039, 0092
Concerto	0056
Contec	0180
Craig	0180
Crosley	0054
Crown	0180, 0039
Curtis Mathes	0047, 0054, 0154, 0051, 0451, 0093, 0060, 0030, 0145, 0056, 0016, 0039, 0166, 0466, 1147, 1347
Daewoo	0451, 0019, 0039, 0092, 0623, 0624
Daytron	0019
Denon	0145
Dumont	0017, 0019
Dwin	0720, 0774
Electroband	0000
Emerson	0154, 0236, 0463, 0180, 0282, 0178, 0019, 0179, 0039, 0177, 0623, 0624
Envision	0030
Fisher	0154
Fujitsu	0179
Funai	0180, 0179, 0171
Futuretech	0180
GE	0047, 0051, 0451, 0093, 0282, 0178, 0021, 0135, 1147, 1347
Gibraltar	0017, 0030, 0019
GoldStar	0030, 0178, 0019, 0056
Gradiente	0053, 0056
Grunpy	0180, 0179
Hallmark	0178
Harley Davidson	0179
Harman/Kardon	0054
Harvard	0180
Hitachi	0145, 0056, 0016, 0151
Infinity	0054
Inteq	0017
JBL	0054
JCB	0000
JVC	0053

Maker	Setup codes
KEC	0180
KTV	0180, 0030, 0039
Kenwood	0030, 0019
LG	0056
LXI	0047, 0054, 0154, 0156, 0178
Logik	0016
Luxman	0056
MGA	0150, 0030, 0178, 0019
MTC	0060, 0030, 0019, 0056
Magnavox	0054, 0030, 0179
Majestic	0016
Marantz	0054, 0030
Matsushita	0250
Megatron	0178, 0145
Memorex	0154, 0250, 0463, 0150, 0178, 0179, 0056, 0016
Midland	0047, 0017, 0051, 0039, 0135
Minutz	0021
Mitsubishi	0093, 0150, 0178, 0019
Motorola	0093
Multitech	0180
NAD	0156, 0178, 0166
NEC	0030, 0019, 0056
NTC	0092
Nikko	0030, 0178, 0092
Onwa	0180
Optimus	0154, 0250, 0166
Optonica	0093, 0165
Orion	0236, 0463, 0179
Panasonic	0051, 0250
Penney	0047, 0156, 0051, 0060, 0030, 0178, 0021, 0019, 0056, 0039, 0135, 1347
Philco	0054, 0463, 0030, 0145, 0019
Philips	0054
Pilot	0030, 0019, 0039
Pioneer	0166
Portland	0019, 0039, 0092
Prism	0051
Proscan	0047
Proton	0178, 0466
Pulsar	0017, 0019
Quasar	0051, 0250, 0165
RCA	0047, 0051, 0093, 0019, 0090, 0135, 1047, 1147, 1247, 1347
Radio Shack	0047, 0154, 0165, 0180, 0030, 0178, 0019, 0056, 0039
Realistic	0154, 0165, 0180, 0030, 0178, 0019, 0056, 0039
Runco	0017, 0030, 0603
SSS	0180, 0019
Sampo	0030, 0039
Samsung	0060, 0030, 0178, 0019, 0056
Samsux	0039
Sansei	0451
Sansui	0463
Sanyo	0154
Scimitzu	0019
Scotch	0178

Maker	Setup codes
Scott	0236, 0180, 0178, 0019, 0179
Sears	0047, 0054, 0154, 0156, 0178, 0179, 0056, 0171
Semivox	0180
Semp	0156
Sharp	0093, 0165, 0039
Shogun	0019
Signature	0016
Sony	0000
Soundesign	0180, 0178, 0179
Squareview	0171
Starlite	0180
Supreme	0000
Sylvania	0054, 0030
Symphonic	0171
TMK	0178, 0056, 0177
Tandy	0093
Technics	0051, 0250
Technol Ace	0179
Techwood	0051, 0056
Teknika	0054, 0180, 0150, 0060, 0019, 0179, 0056, 0016, 0039, 0092
Telefunken	0056
Toshiba	0154, 0156, 0060
Totevision	0039
Vector Research	0030
Victor	0053
Vidikron	0054
Vidtech	0178, 0019
Wards	0054, 0165, 0030, 0178, 0021, 0019, 0179, 0056, 0016
White Westinghouse	0463, 0623, 0624
Yamaha	0030, 0019
Zenith	0017, 0463, 0016, 0092, 0624

Setup code chart (for VR-507 (RC-R0720))

VCR Setup codes

Maker	Setup codes
Admiral	0048, 0209
Adventura	0000
Aiko	0278
Aiwa	0037, 0000
Akai	0041
America Action	0278
American High	0035
Asha	0240
Audiovox	0037
Beaumarck	0240
Bell & Howell	0104
Broksonic	0184, 0121, 0209, 0002
CCE	0072, 0278
Calix	0037
Canon	0035
Carver	0081
Cineral	0278
Citizen	0037, 0278
Colt	0072
Craig	0037, 0047, 0240, 0072, 0271
CurtisMathes	0060, 0035, 0041, 0162
Cybernex	0240
Daewoo	0045, 0278
Denon	0042
Dynatech	0000
Electrohome	0037
Electrohome	0037
Emerex	0032
Emerson	0037, 0184, 0000, 0121, 0043, 0209, 0002, 0278
Fisher	0047, 0104
Fuji	0035, 0033
Funai	0000
GE	0060, 0035, 0048, 0240
Garrard	0000
Go Video	0526
GoldStar	0037, 0038
Gradiente	0000
HI-Q	0047
Harley Davidson	0000
Harman/Kardon	0081, 0038
Harwood	0072
Headquarter	0046
Hitachi	0000, 0042, 0041
Hughes Net. Sys.	0042
JVC	0067, 0041
Jensen	0041
KEC	0037, 0278
KLH	0072
Kenwood	0067, 0041, 0038
Kodak	0035, 0037
LXI	0037
Lloyd's	0000
Logik	0072
MEI	0035
MGA	0240, 0043
MGN Technology	0240
MTC	0240, 0000
Magnasonic	0278
Magnavox	0035, 0039, 0081, 0000, 0149
Magnin	0240
Marantz	0035, 0081

Maker	Setup codes
Marta	0037
Matsushita	0035, 0162, 0454
Memorex	0035, 0037, 0048, 0039, 0047, 0240, 0000, 0104, 0209, 0162, 0046, 0454, 1162, 1262
Minolta	0042
Mitsubishi	0048, 0067, 0043
Motorola	0035, 0048
Multitech	0000, 0072
NEC	0104, 0067, 0041, 0038
Nikko	0037
Noblex	0240
Olympus	0035
Optimus	0037, 0048, 0104, 0162, 0454, 1062, 1162, 1262
Orion	0184, 0209, 0002
Panasonic	0035, 0162, 0225, 0454, 1064, 1162, 1262
Penney	0035, 0037, 0240, 0042, 0038
Pentax	0042
Philco	0035, 0209
Philips	0035, 0081
Pilot	0037
Pioneer	0067
Polk Audio	0081
Profitronic	0240
Proscan	0060
Protec	0072
Pulsar	0039
Quarter	0046
Quartz	0046
Quasar	0035, 0162, 0454, 1162
RCA	0060, 0035, 0048, 0240, 0042, 0149
Radio Shack	0000
Radix	0037
Randex	0037
Realistic	0035, 0037, 0048, 0047, 0000, 0104, 0046
Runco	0039
STS	0042
Samsung	0240, 0045
Sanky	0048, 0039
Sansui	0000, 0067, 0209, 0041, 0271
Sanyo	0047, 0240, 0104, 0046
Scott	0184, 0045, 0121, 0043
Sears	0035, 0037, 0047, 0000, 0042, 0104, 0046
Semp	0045
Sharp	0048
Shintom	0072
Shogun	0240
Singer	0072
Sony	0035, 0032, 0000, 0033
Sylvania	0035, 0081, 0000, 0043
Symphonic	0000
TMK	0240
Tatung	0041
Teac	0000, 0041
Technics	0035, 0162
Teknika	0035, 0037, 0000
Thomas	0000

Maker	Setup codes
Toshiba	0045, 0043
Totevision	0037, 0240
Unitech	0240
Vector	0045
Vector Research	0038
Video Concepts	0045
Videosonic	0240
Wards	0060, 0035, 0048, 0047, 0081, 0240, 0000, 0042, 0072, 0149
White Westinghouse	0209, 0072, 0278
XR-1000	0035, 0000, 0072
Yamaha	0038
Zenith	0039, 0000, 0209, 0033

TV/VCR combos Setup codes

Maker	Setup codes
American High	0035 (for TV use 0051)
Brocksonic	0002, 0294,
Colt	0072
Curtis Mathis	0035 (for TV use 0051)
Daewoo	0278
Emerson	0002, 0294, 0479
Funai	0000
GE	0035 (for TV use 0051), 0060 (for TV use 0047), 0048 (for TV use 0093), 0240
Hitachi	0035 (for TV use 0051), 0000
HQ	0000
Lloyds	0000
MGA	0240
Magnavox	0081 (for TV use 0054), 0035 (for TV use 0051), 0000
Magnin	0240
Memorex	0037, 0162 (for TV use 0250)
Mitsubishi	0048 (for TV use 0093)
Orion	0002, 0294, 0479
Panasonic	0035 (for TV use 0051), 0162 (for TV use 0250)
Penney	0035 (for TV use 0051), 0240, 0162 (for TV use 0250)
Quasar	0035 (for TV use 0051), 0162 (for TV use 0250)
RCA	0060 (for TV use 0047), 0035 (for TV use 0051), 0048 (for TV use 0093)
Sansui	0000, 0479
Sanyo	0240
Sears	0000, 0037
Sharp	0048 (for TV use 0093)
Sony	0032 (for TV use 0000)
Symphonic	0000
Zenith	0000

Setup code chart (for VR-507 (RC-R0720))**Cable tuner Setup codes**

Maker	Setup codes
ABC	0003, 0008, 0014, 0017, 0007, 0011, 0013
Allegro	0153, 0315
Archer	0153, 0797
Bell & Howell	0014
Century	0153
Citizen	0153, 0315
Comtronics	0040
Contec	0019
Eastern	0002
Emerson	0797
Everquest	0015, 0040
Focus	0400
Garrard	0153
Gemini	0015
General Instrument	0476, 0276, 0011, 0810
GoldStar	0144, 0040
Goodmind	0797
Hamlin	0020, 0259, 0009, 0034
Hitachi	0011
Hytex	0007
Jasco	0015, 0153, 0315
Jerrold	0003, 0012, 0476, 0276, 0014, 0015, 0011, 0810
Memorex	0000
Movie Time	0063
NSC	0063
Oak	0019, 0007
Optimus	0021
Panasonic	0000, 0107, 0021
Paragon	0000
Philips	0153
Pioneer	0144, 0533, 0877
Popular Mechanics	0400
Pulsar	0000
Quasar	0000
RCA	0021
Radio Shack	0015, 0315, 0797, 0883
Recoton	0400
Regal	0020, 0259
Regency	0002
Rembrandt	0011
Runco	0000
SL Marx	0040
Samsung	0144, 0040
Scientific Atlanta	0008, 0477, 0017, 0877
Signal	0015, 0040
Signature	0011
Sprucer	0021
Starcom	0003, 0015
Stargate	0015, 0040, 0797
Starquest	0015
TV86	0063
Televiue	0040
Tocom	0012, 0013
Toshiba	0000
Tusa	0015
Unika	0153
United Artists	0007
Universal	0153, 0191
Viewstar	0063
Zenith	0000, 0525
Zentek	0400

DBS/DSS receiver Setup codes

Maker	Setup codes
AlphaStar	0772
Chaparral	0216
Echostar	0775
Expressvu	0775
General Instrument	0627, 0361, 0869
HTS	0775
Hitachi	0819
Hughes Net. Sys.	0749
JVC	0775
Jerrold	0627, 0361
Magnavox	0724, 0722
Memorex	0724
Next Level	0869
Panasonic	0701
Philips	0724, 0722
Primestar	0627, 0361
RCA	0566, 0143, 0392, 0855
Radio Shack	0869
Realistic	0052
Sony	0639
Star Choice	0869
Toshiba	0749, 0790
Uniden	0724, 0722, 0052
Zenith	0856

Receiver Setup codes

Maker	Setup codes
ADC	0531
Adcom	0616
Aiwa	0158, 0189, 0121, 0405
Akai	0224
Capetronic	0531
Carver	0189, 0008, 0042, 0360
Casio	0195
Clarinette	0195
Curtis Mathes	0080
Denon	0004
Emerson	0424
Fisher	0042, 0219, 0360
Garrard	0463, 0424
Harman/Kardon	0110, 0189, 0891
JBL	0110
JVC	0074
Kenwood	0027, 0186, 0042, 0077, 1570
Koss	0424
LXI	0181
Linn	0189
Lloyd's	0195
MCS	0039, 0346
Magnavox	0531, 0189, 0195, 0391
Marantz	0039, 0189
Modulaire	0195
NAD	0320
Nakamichi	0097, 0347
Onkyo	0135
Optimus	0531, 0670, 0186, 0080, 0042, 0177, 0181, 0219, 0738, 0801, 1023
Panasonic	0039, 0309
Penney	0195
Philips	0189, 0391
Pioneer	0531, 0014, 0150, 0630, 0080, 1023
Quasar	0039
RCA	0531, 0054, 0346, 0360, 0530, 1023
Realistic	0195, 0163, 0181
Sansui	0189, 0346
Sanyo	0219, 0801
Scott	0163, 0322
Sharp	0186
Sherwood	0491, 0502
Sony	0158, 0168, 0474
Soundesign	0670
Teac	0463, 0163
Technics	0039, 0309, 0208
Victor	0074
Wards	0158, 0014, 0189, 0080, 0054
Yamaha	0176, 0186
Yorx	0195
Zenith	0857

Setup code chart (for VR-507 (RC-R0720))

CD player Setup codes

Maker	Setup codes
Aiwa	0157, 0124
Burmester	0420
California Audio Lab	0029, 0303
Carver	0157, 0179, 0437
DKK	0000
Denon	0003, 0873
Emerson	0305
Fisher	0179, 0174
Garrard	0420, 0393
Genexxa	0032, 0305
Harman/Kardon	0157, 0173
Hitachi	0032
JVC	0072
Kenwood	0028, 0037, 0190, 0626, 0681, 0826
Krell	0157
LXI	0305
Linn	0157
MCS	0029
MTC	0420
Magnavox	0157, 0305
Marantz	0029, 0157, 0180
Mission	0157
NSM	0157
Nikko	0174
Onkyo	0101, 0868
Optimus	0000, 0032, 0179, 0305, 0037, 0420, 0145, 0468, 0437
Panasonic	0029, 0303
Parasound	0420
Philips	0157, 0626
Pioneer	0032, 0305, 0468, 0244
Polk Audio	0157
Proton	0157
QED	0157
Quasar	0029
RCA	0179, 0305, 0053, 0764
Realistic	0179, 0420, 0180
Rotel	0157, 0420
SAE	0157
Sansui	0157, 0305
Sanyo	0179
Scott	0305
Sears	0305
Sharp	0037, 0180, 0861
Sherwood	0180
Sony	0000, 0185, 0490
Soundesign	0145
Tascam	0420
Teac	0420, 0393, 0174, 0180
Technics	0029, 0303
Victor	0072
Wards	0157, 0053
Yamaha	0036, 0187
Yorx	0461

DVD player Setup codes

Maker	Setup codes
Demon	0490
GE	0522
Harman/Kardon	0582
JVC	0558
Kenwood	0534
Magnavox	0503
Marantz	0539
Mitsubishi	0521
Onkyo	0503
Optimus	0571
Panasonic	0490
Philips	0503, 0539
Pioneer	0525, 0571
Proscan	0522
RCA	0522
Samsung	0573
Sony	0533
Technics	0490
Theta Digital	0571
Toshiba	0503
Yamaha	0490, 0545
Zenith	0503, 0591

LD player Setup codes

Maker	Setup codes
Denon	0059
Mitsubishi	0059
NAD	0059
Pioneer	0059
Sony	0193, 0201

Cassette deck Setup codes

Maker	Setup codes
Aiwa	0029, 0197
Carver	0029
Denon	0076
Harman/Kardon	0182, 0029
JVC	0244, 0273
Kenwood	0070
Magnavox	0029
Marantz	0029
Onkyo	0135, 0282
Optimus	0027, 0220
Panasonic	0229
Philips	0029
Pioneer	0027, 0220, 0099
Polk Audio	0029
Sansui	0029
Sony	0243, 0170, 0291
Technics	0229
Victor	0273
Wards	0027
Yamaha	0097, 0094

DBS/DSS audio service Setup codes

Maker	Setup codes
Aiwa	0010, 0159, 0404
Fisher	0052
Harman/Kardon	0477
JBL	0477
JVC	0073
Jerrold	0459, 0520
RCA	0056
Scientific Atlanta	0460
Sony	0010, 0159
Starcom	0459

Stereo Amplifier Setup codes

Maker	Setup codes
Aiwa	0406
Carver	0269
Curtis Mathes	0300
Denon	0160
Harman/Kardon	0892
JVC	0331
Linn	0269
Magnavox	0269
Marantz	0269
Panasonic	0308
Philips	0269, 0892
Pioneer	0013, 0300
Polk Audio	0269, 0892
RCA	0300
Sony	0220, 0689
Technics	0308
Victor	0331
Wards	0013
Yamaha	0354

Home Automation Setup codes

Maker	Setup codes
GE	0240
Lutron	0597
One For All	0167
Radio Shack	0240
Security System	0167
Universal X10	0167
X10	0167

Setup code chart (for KRF-V7050D (RC-R0613))**TV Setup codes**

Maker	Setup codes
SONY	101
GE/RCA	102
RCA	103, 104, 105, 106, 117
ZENITH	107, 108
MAGNAVOX	109
SHARP	110
PANASONIC	111, 112, 122
SAMSUNG	109
JVC	113
HITACHI	114, 115
PIONEER	116
PROSCAN	117
QUASAR	118
PHILIPS	109
SANYO	119
TOSHIBA	120
MITUBISHI	121
LOEWE	123, 124

VCR Setup codes

Maker	Setup codes
SONY	301, 302, 303, 304, 305, 306
GE/HITACHI	307
RCA/HITACHI	308
PANASONIC	309, 310
MAGNAVOX	311, 312, 313
TOSHIBA	314
MITSUBISHI	315, 316, 317, 318
SHARP	319, 320
G.E	321
ZENITH	322
GOLD STAR	323
JVC	324, 325, 326, 327
PHILIPS	313
HITACHI	328, 329
SANYO	330
TOSHIBA	331

DVD Setup codes

Maker	Setup codes
JVC	801
SONY	802
PIONEER	803
PANASONIC	804
KENWOOD	805, 808
TOSHIBA	806
PHILIPS	807

CABLE Setup codes

Maker	Setup codes
JERROLD	201, 202
S.ATLANTA	203
ZENITH	204, 205
PIONEER	206, 207
TOCOM	208
G.I.	209
HAMLIN	210, 211
OAK	212, 213, 214
MACOM	215, 216, 217
GEMINI	218
PHILIPS	219, 220
PANASONIC	221, 222
SAMSUNG	223

DSS Setup codes

Maker	Setup codes
RCA	901
G.I.	902
ECHOSTAR	903
TOSHIBA	904
PANASONIC	905
HUGHES	906
SONY	907
HITACHI	908
PRIMESTAR	909

CASSETTE deck, CD player & MD recorder operations

You can perform these basic operations using the keys described below when connected to KENWOOD cassette deck, MD recorder or CD player equipped with system control operations. → 15

Cassette deck operations keys

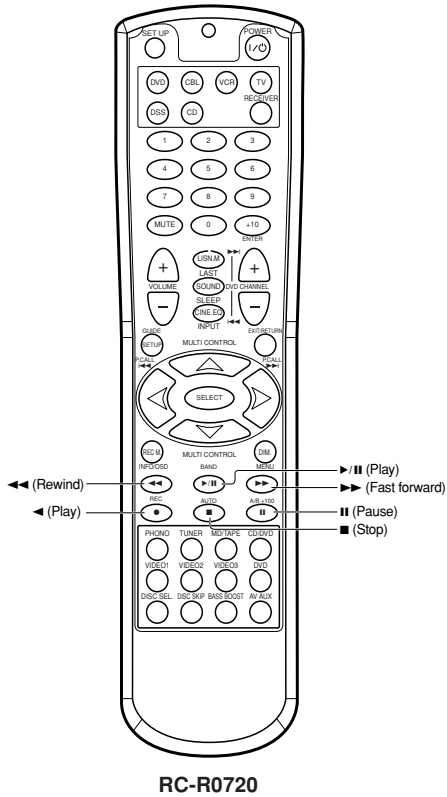

RC-R0720

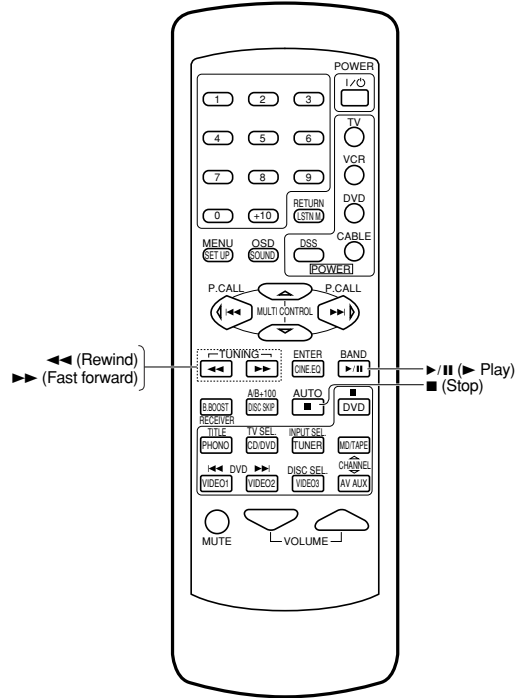

RC-R0613

CD player operation keys

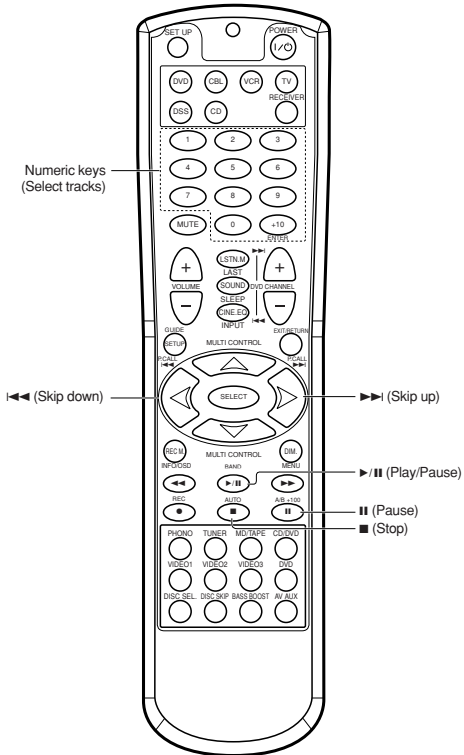

RC-R0720

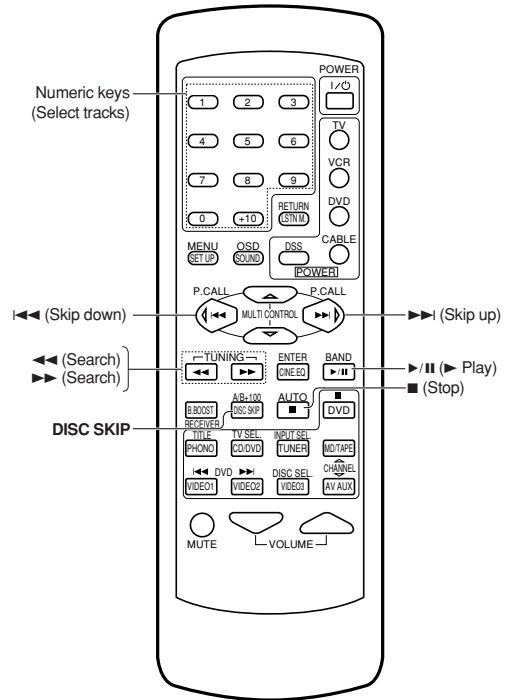

RC-R0613

MD recorder operation keys

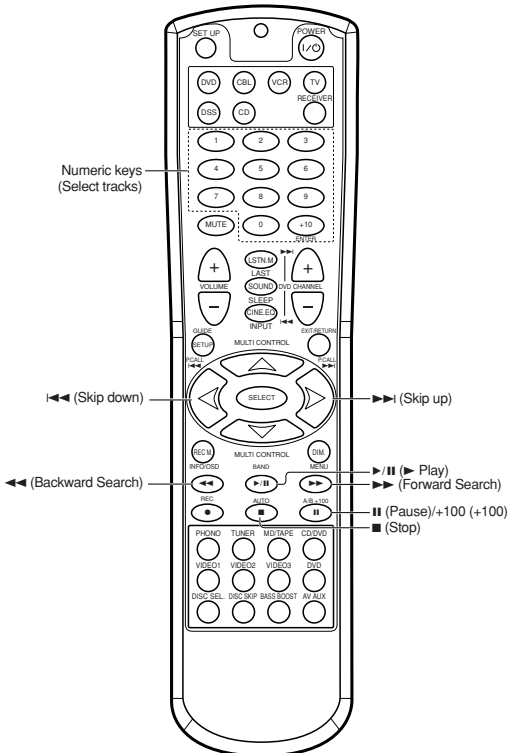

RC-R0720

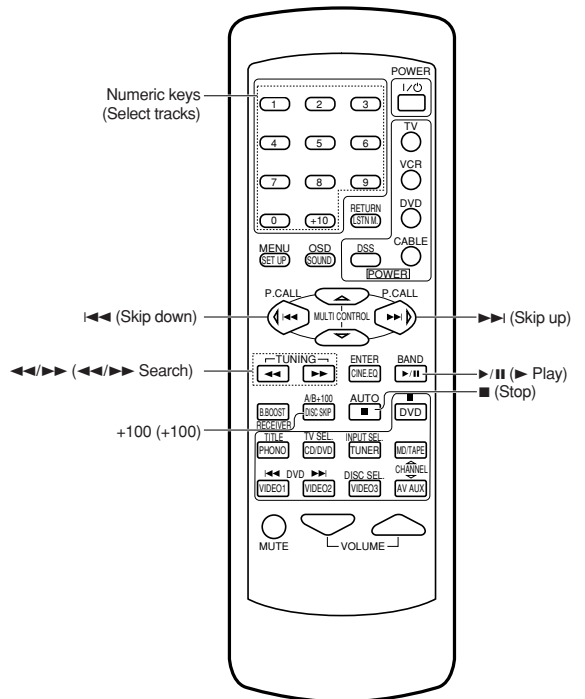

RC-R0613

Other components' operations

Refer to the following for the type of remote control operations available for each component.

- ❶ Select the input source.
- ❷ Press the keys corresponding to the operations you desire. Refer to the following sections for details.

- When pressing keys in succession, press each key firmly and be sure to wait at least 1 second before pressing the next key.
- Numeric keys function the same as the numeric keys on the original remote.

These keys can be used to perform the basic operations of KENWOOD and other makers' components which the setup code for each component had been entered beforehand.

→ 31 ← 34

TV operation keys

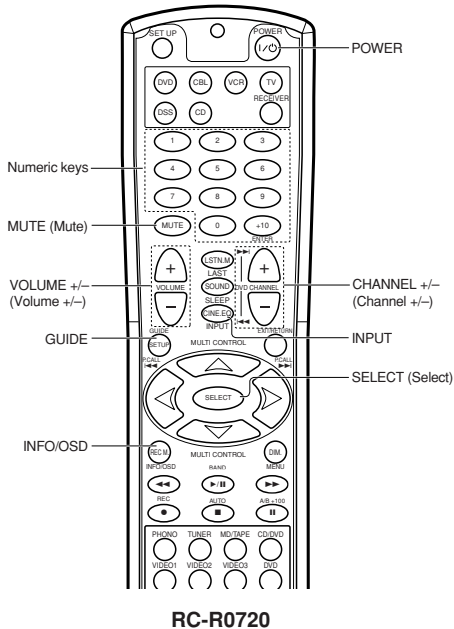

RC-R0720

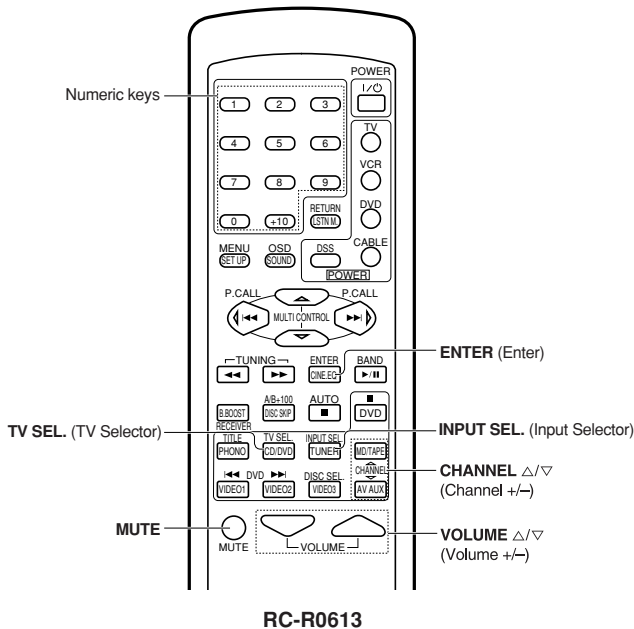

RC-R0613

CD player operation keys

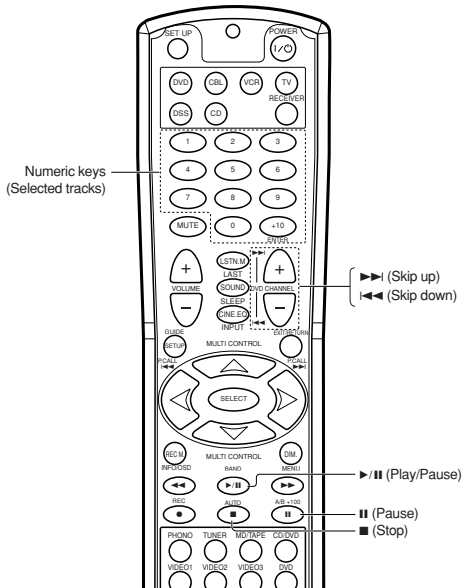

RC-R0720

Continued to next page

VCR operation keys

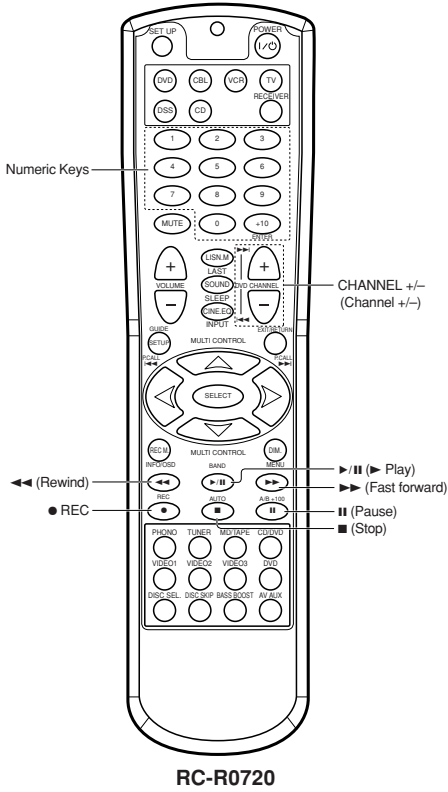

RC-R0720

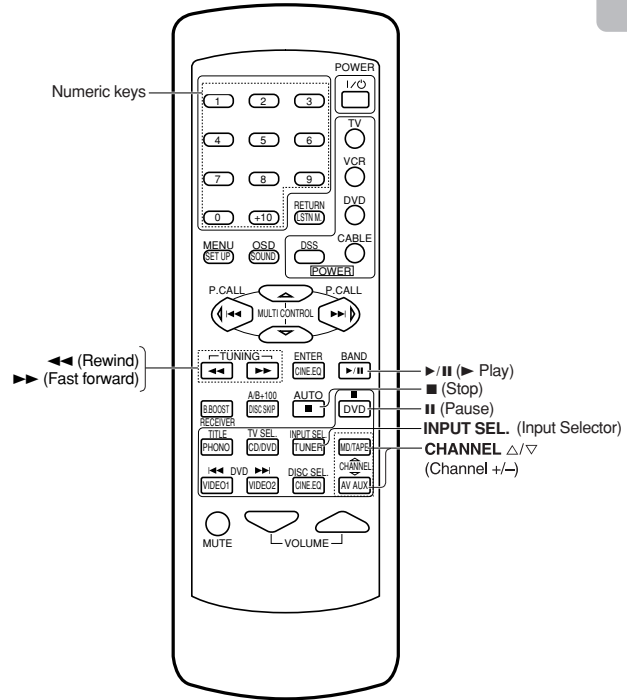

RC-R0613

DVD player operation keys

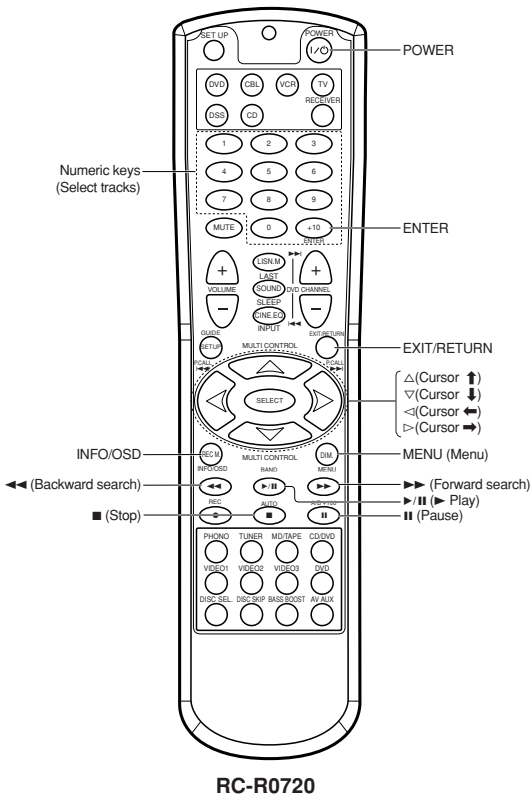

RC-R0720

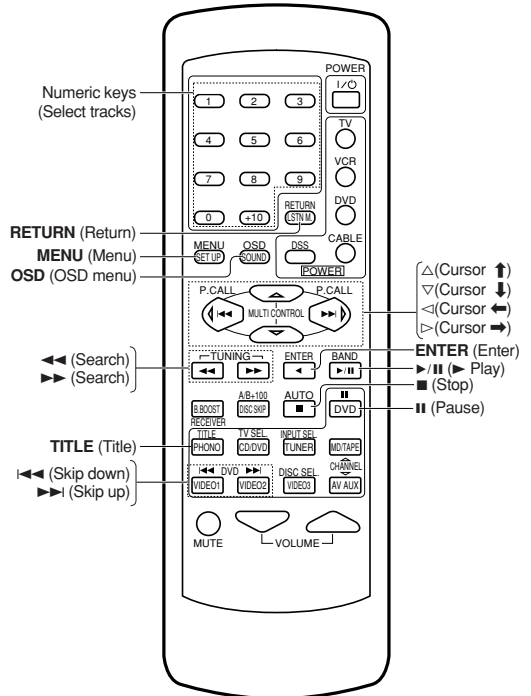

RC-R0613

DBS/DSS receiver operation keys

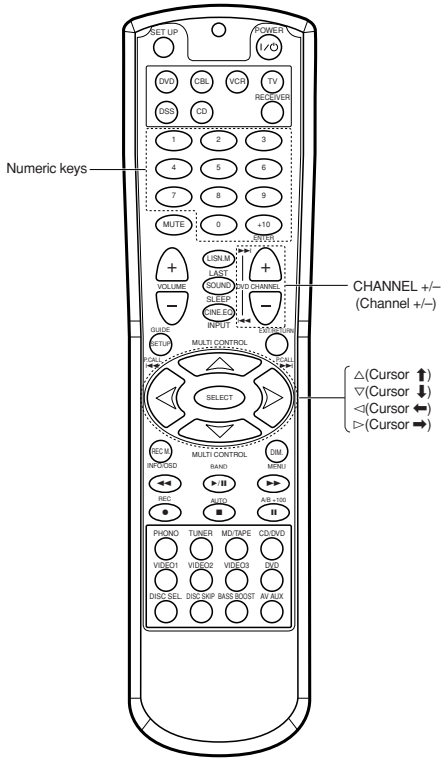

RC-R0720

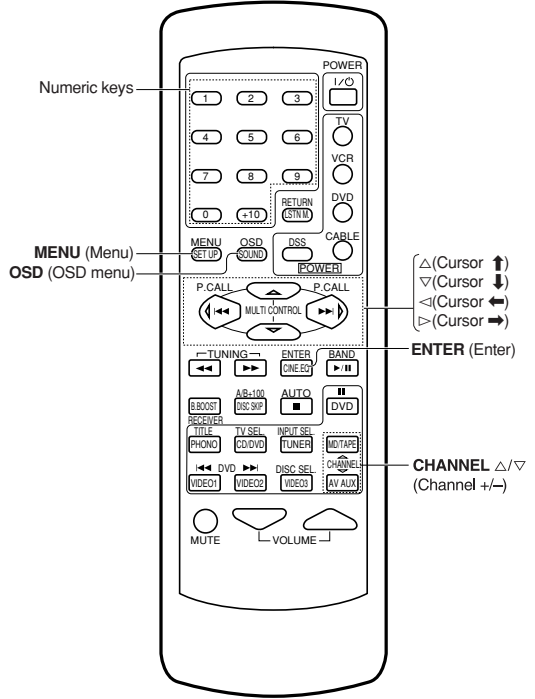

RC-R0613

Cable tuner operation keys

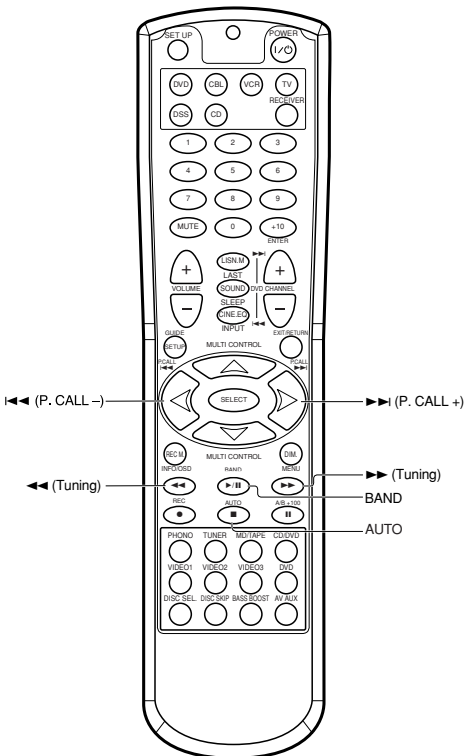

RC-R0720

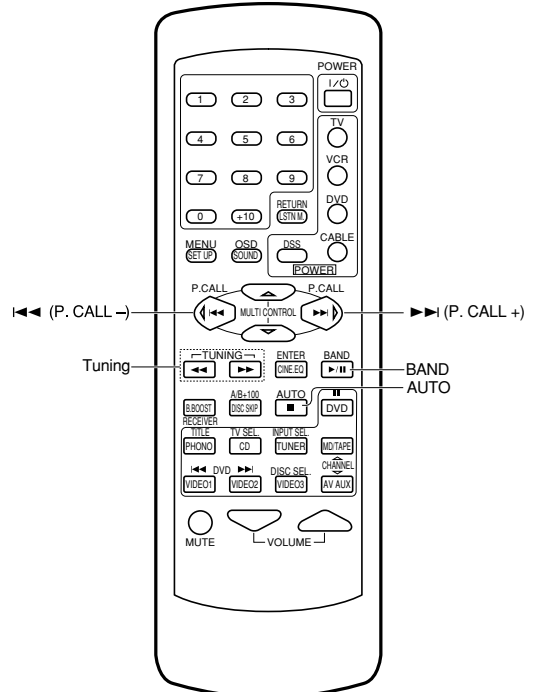

RC-R0613

Resetting the Microcomputer

The microcomputer may malfunction (unit cannot be operated, or shows an erroneous display) if the power cord is unplugged while the power is ON, or due to some other external factor. If this happens, execute the following procedure to reset the microcomputer and return the unit to its normal operating condition.

- Please note that resetting the microcomputer will clear the contents of the memory and returns the unit to the state it was in when it left the factory.

For U.S.A. and Canada

Unplug the power cord from the wall outlet, then plug it back in while holding down the POWER key.

For other countries

With the power cord plugged in, turn the POWER key OFF. Then, while holding down the ON/STANDBY key, press POWER.

Amplifier

Symptom	Cause	Remedy
No sound from the speakers.	<ul style="list-style-type: none"> • The speaker cords are disconnected. • VOLUME is set to the minimum position. • MUTE is ON. • The SPEAKERS switches are set to OFF. 	<ul style="list-style-type: none"> • Connect them properly referring to "Connecting the speakers" → 16 • Adjust the volume to a proper level. • Turn OFF the MUTE. → 22 • Set the SPEAKERS switch(es) to ON. → 20
The standby indicator blinks and sound is not output.	<ul style="list-style-type: none"> • Speaker cords are short-circuited. 	<ul style="list-style-type: none"> • Turn the power off, eliminate the short-circuiting, then turn on the power again.
Sound is not output from one of the speakers.	<ul style="list-style-type: none"> • The speaker cord is disconnected. 	<ul style="list-style-type: none"> • Connect it properly referring to "Connecting the speakers". → 16
Sound is not output from the surround speakers and / or the center speaker, or their sound is very small.	<ul style="list-style-type: none"> • The surround speaker cords and/or the center speaker cord is disconnected. • A surround mode has not been engaged. • The surround and/or center volume controls are set to the minimum level. 	<ul style="list-style-type: none"> • Connect it properly referring to "Connecting the speakers". → 16 • Select a surround mode. • Adjust the speaker levels using the test tone. → 19
A humming noise is generated when the PHONO input selector is selected.	<ul style="list-style-type: none"> • The audio cord from the turntable is not connected to the PHONO jacks. • The turntable is not grounded. 	<ul style="list-style-type: none"> • Insert the audio cord plugs securely into the PHONO jacks. • Connect the grounding wire to the GND terminal on the rear panel.
When playing a Dolby Digital source signal using a DVD player, the sound is cut off soon after it starts.	<ul style="list-style-type: none"> • There are many possible causes for this problem, depending on the type of DVD player used. 	<ul style="list-style-type: none"> • Set the input mode to digital manual before starting playback of the Dolby Digital source. → 9
No sound is produced during playback from a DVD player.	<ul style="list-style-type: none"> • The input mode is set to digital manual. 	<ul style="list-style-type: none"> • Press the INPUT MODE key to select to digital auto mode. → 9
A video source cannot be recorded normally.	<ul style="list-style-type: none"> • The software is copy-guarded. 	<ul style="list-style-type: none"> • Copy-guarded video software cannot be recorded.

Tuner

Symptom	Cause	Remedy
Radio stations cannot be received.	<ul style="list-style-type: none"> • No antenna is connected. • The broadcast band is not set properly. • The frequency of the desired station is not tuned. 	<ul style="list-style-type: none"> • Connect an antenna. → 14 • Set the broadcast band properly. • Tune the frequency of the desired station. → 23
Interference.	<ul style="list-style-type: none"> • Noise due to ignition noise from an automobile. • Noise due to interference from an electric appliance. • Noise due to a nearby TV set. 	<ul style="list-style-type: none"> • Install the outdoor antenna away from the road. • Turn off the power to the appliance. • Install the receiver farther away from the TV.
A station which was preset cannot be received by pressing the corresponding numeric key.	<ul style="list-style-type: none"> • The preset station belongs to a frequency that cannot be received. • The preset memory was cleared because the power cord had been unplugged for a long period of time. 	<ul style="list-style-type: none"> • Preset a station with a receivable frequency. • Preset the station again.

46 Remote control unit

Symptom	Cause	Remedy
Certain inputs cannot be selected using the remote control.	<ul style="list-style-type: none"> No setup codes registered at for the respective input(s). 	<ul style="list-style-type: none"> Register a setup code at the respective input(s). - 35 - 39
Remote control operation is not possible.	<ul style="list-style-type: none"> The remote control is set to a different operation mode. Batteries are exhausted. The remote control unit is too far away from the main system, controlling angle is too large, or there is an obstacle between the receiver and the remote. The audio cords and system control cords are not connected properly. No software is loaded in the source component. An attempt is made to play a tape which is being recorded in the cassette deck. The remote control has not been set to the operation mode for the component you wish to control. The microprocessor of the remote control malfunctions. 	<ul style="list-style-type: none"> Press the source select keys or source POWER keys to select the appropriate operation mode. Replace with new batteries. Operate the remote control unit within the controllable range. Connect properly referring to "Setting up the system". Place software in the source component you want to play. Wait until recording has completed. Press the source select keys or source POWER keys to activate the operation mode for the component you want to control before operation. - 31 - 34 Reset the microprocessor.

For U.S.A and Canada

AUDIO section (VR-507)

Rated power output during STEREO operation

100 watts per channel minimum RMS, both channels driven, at 8 Ω from 20 Hz to 20 kHz with no more than 0.7% total harmonic distortion. (FTC)

Effective power output during SURROUND operation

FRONT (20-20kHz, 0.7% T.H.D. at 8 Ω one channel driven)	100 W + 100 W
CENTER (20-20kHz, 0.7% T.H.D. at 8 Ω one channel driven)	100 W
SURROUND (20-20kHz, 0.7% T.H.D. at 8 Ω one channel driven)	100 W + 100 W

Total harmonic distortion 0.05% (1 kHz, 50W, 8 Ω)

Frequency response

CD	10 Hz ~ 60 kHz, +0 dB, -3.0 dB
----	--------------------------------

Signal to noise ratio (IHF'66)

PHONO (MM)	75 dB
CD	91 dB

Input sensitivity / impedance

PHONO (MM)	2.5 mV / 27 kΩ
CD	200 mV / 47 kΩ
MONITOR IN	200 mV / 47 kΩ
DVD/6CH INPUT	200 mV / 47 kΩ

Output level / impedance

TAPE REC	200 mV / 1 kΩ
MONITOR OUT	200 mV / 1 kΩ
PRE OUT (SUBWOOFER)	1.5 V / 2.2 kΩ

Tone control

BASS	±10 dB (at 70 Hz)
TREBLE	±10 dB (at 10 kHz)

For other countries

AUDIO section (KRF-V7050D)

Effective power output during STEREO operation
1kHz,10% T.H.D.,at 8 Ω 140 W + 140 W

Rated power output during STEREO operation

100 watts per channel minimum RMS, both channels driven, at 8 Ω from 20 Hz to 20 kHz with no more than 0.7% total harmonic distortion. (FTC)

Effective power output during SURROUND operation

FRONT (1kHz, 10% T.H.D. at 8 Ω one channel driven)	140 W + 140 W
CENTER (1kHz, 10% T.H.D. at 8 Ω one channel driven)	140 W
SURROUND (1kHz, 10% T.H.D. at 8 Ω one channel driven)	140 W + 140 W

Total harmonic distortion 0.05% (1 kHz, 50W, 8 Ω)

Frequency response

CD	10 Hz ~ 60 kHz, +0 dB, -3.0 dB
----	--------------------------------

Signal to noise ratio (IHF'66)

PHONO (MM)	73 dB
CD	91 dB

Input sensitivity / impedance

PHONO (MM)	2.5 mV / 27 kΩ
CD	200 mV / 47 kΩ
MONITOR IN	200 mV / 47 kΩ
DVD/6CH INPUT	200 mV / 10 kΩ

Output level / impedance

TAPE REC	200 mV / 1 kΩ
MONITOR OUT	200 mV / 1 kΩ
PRE OUT (SUBWOOFER)	1.5 V / 2.2 kΩ

Tone control

BASS	±10 dB (at 70 Hz)
TREBLE	±10 dB (at 10 kHz)

DIGITAL AUDIO section

Sampling frequency	32 kHz, 44.1 kHz, 48 kHz, 96kHz
Input level / impedance / wave length	Optical (-15 dBm ~ -21 dBm), 660 nm ±30nm
Coaxial	0.5 Vp-p / 75 Ω

VIDEO section

VIDEO inputs / outputs	
VIDEO (composite)	1 Vp-p / 75 Ω
S VIDEO inputs /outputs	
S VIDEO (luminance signal)	1 Vp-p / 75 Ω
S VIDEO (chrominance signal)	0.286 Vp-p / 75 Ω

FM tuner section

Tuning frequency range	87.5 MHz ~ 108.0 MHz
Usable sensitivity (MONO)	VR-507 1.3 μV (75 Ω)/ 13.2 dBf (75 kHz DEV., SINAD 30 dB)
	KRF-V7050D 1.6 μV (75 Ω)/ 15.2 dBf (75 kHz DEV., SINAD 30 dB)
50dB quieting sensitivity	
STEREO	28 μV (75 Ω)/ 40.2 dBf
Total harmonic distortion (1 kHz)	
MONO	0.5% (65 dBf input)
STEREO	0.7% (65 dBf input)
Signal to noise ratio (1 kHz, 75 kHz DEV.)	
MONO	75 dB (65 dBf input)
STEREO	68 dB (65 dBf input)
Stereo separation (1 kHz)	40 dB
Selectivity (±400 kHz) (VR-507)	70 dB
	(KRF-V7050D) 50 dB
Frequency response	(30 Hz ~ 15kHz), +0.5 dB, -3.0 dB

AM tuner section

Tuning frequency range	
10 kHz step	530 kHz ~ 1,700 kHz (VR-507)
10 kHz step	530 kHz ~ 1,610 kHz (KRF-V7050D)
9 kHz step	531 kHz ~ 1,602 kHz (KRF-V7050D)
Usable sensitivity	16 μV / (600 μV/m)
Signal to noise ratio (30% mod. 1 mV input)	50 dB

GENERAL

Power consumption VR-507	2.6 A
	KRF-V7050D 270W
Maximum power consumption (For other countries)	1000 W
AC outlet	
SWITCHED VR-507	(total 150 W, 1.25 A max.)
	KRF-V7050D (total 90 W, 1.25 A max.)
Dimensions	W : 440 mm (17-5/16")
	H : 144 mm (5-11/16")
	D : 399 mm(15-11/16")
Weight (Net)	
VR-507	8.8 kg (19.40 lb)
KRF-V7050D	8.6 kg (19.00 lb)

Notes
1. KENWOOD follows a policy of continuous advancements in development. For this reason specifications may be changed without notice.
2. The full performance may not be exhibited in an extremely cold location (under a water-freezing temperature).

KENWOOD

For your records

Record the serial number, found on the back of the unit, in the spaces designated on the warranty card, and in the space provided below. Refer to the model and serial numbers whenever you call upon your dealer for information or service on this product.

Model _____ Serial Number _____