

KENWOOD

CD PLAYER

DPF-3030

INSTRUCTION MANUAL

KENWOOD CORPORATION



B60-4517-08 (EN)

Introduction





Before applying power **Caution : Read this section carefully to ensure safe operation.**

2 Units are designed for operation as follows.

Europe and U.K. AC 230 V only

Safety precautions **Caution : Read this section carefully to ensure safe operation.**

WARNING : TO PREVENT FIRE OR ELECTRIC SHOCK, DO NOT EXPOSE THIS APPLIANCE TO RAIN OR MOISTURE.

	CAUTION RISK OF ELECTRIC SHOCK DO NOT OPEN		CAUTION: TO REDUCE THE RISK OF ELECTRIC SHOCK, DO NOT REMOVE COVER (OR BACK). NO USER-SERVICEABLE PARTS INSIDE, REFER SERVICING TO QUALIFIED SERVICE PERSONNEL.
	THE LIGHTNING FLASH WITH ARROWHEAD SYMBOL, WITHIN AN EQUILATERAL TRIANGLE, IS INTENDED TO ALERT THE USER TO THE PRESENCE OF UNINSULATED "DANGEROUS VOLTAGE" WITHIN THE PRODUCT'S ENCLOSURE THAT MAY BE OF SUFFICIENT MAGNITUDE TO CONSTITUTE A RISK OF ELECTRIC SHOCK TO PERSONS.		
	THE EXCLAMATION POINT WITHIN AN EQUILATERAL TRIANGLE IS INTENDED TO ALERT THE USER TO THE PRESENCE OF IMPORTANT OPERATING AND MAINTENANCE (SERVICING) INSTRUCTIONS IN THE LITERATURE ACCOMPANYING THE APPLIANCE.		

The marking of products using lasers (Except for some areas)



The marking is located on the rear panel and says that the component uses laser beams that have been classified as Class 1. It means that the unit is utilizing laser beams that are of a weaker class. There is no danger of hazardous radiation outside the unit.

Unpacking

Unpack the unit carefully and make sure that all accessories are put aside so they will not be lost. Examine the unit for any possibility of shipping damage. If your unit is damaged or fails to operate, notify your dealer immediately. If your unit was shipped to you directly, notify the shipping company without delay. Only the consignee (the person or company receiving the unit) can file a claim against the carrier for shipping damage.

We recommend that you retain the original carton and packing materials for use should you transport or ship the unit in the future.

Keep this manual handy for future reference.

Special features

Advanced technologies incorporated in pursuit of improved sound quality and stability

- D.R.I.V.E. (Dynamic Resolution Intensive Vector Enhancement) IC is built in for drastic reduction of distortion at small signal level.
- High-performance 1-bit D/A converter achieving a 24-bit resolution.

Convenient features for dubbing CD onto tape

- CD peak search for setting the recording level that does not cause distortion. → 19
- Edit function for rearranging tracks according to the tape length so that no music is interrupted in the middle. → 18

Easy operation functions

- Auto space function. → 15
- Easy operation functions allow systematic operation with other KENWOOD components connected through the system control connection. → 8

Accessories

Audio cord (1)

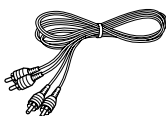

System control cord (1)

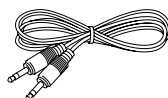

Remote control unit (1)

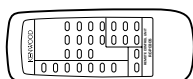



Batteries (R6/AA) (2)



Contents

Caution: Read the pages marked  carefully to ensure safe operation.

Introduction	2
 Before applying power	2
 Safety precautions	2
Special features	3
 IMPORTANT SAFEGUARDS	4
System connections	6
To use the headphone	7
Maintenance	9
Controls and indicators	10
Operation of remote control unit	11
Normal play (TRACK mode)	12
Playing tracks in order from track No.1	12
Playback from desired track	13
Skipping tracks	13
Searching	13
Time display on CD player (TIME DISPLAY)	13

Programmed play (PGM mode)	14
To check or change the programmed tracks	15
To add a track to the program	15
To clear tracks from the program	15
Repeated playback	16
To repeat only the programmed tracks	16
To repeat the entire disc	17
Editing	18
Playing or recording the edited contents	18
To check the edited contents	19
To clear the edited contents	19
Peak search	19
Playback in random order (Random playback)	20
Timer operations	21
In case of difficulty	22
Specifications	23

IMPORTANT SAFEGUARDS

 **Caution :** Read this page carefully to ensure safe operation.

4

Please read all of the safety and operating instructions before operating this appliance. Adhere to all warnings on the appliance and in the instruction manual. Follow all the safety and operating instructions. These safety and operating instructions should be retained for future reference.

1. **Power sources** – The appliance should be connected to a power supply only of the type described in the instruction manual or as marked on the appliance. If you are not sure of the type of power supply to your home, consult your appliance dealer or local power company. For appliances intended to operate from battery power, or other sources, refer to the instruction manual.
2. **Power-cord protection** – Power-supply cords should be routed so that they are not likely to be walked on or pinched by items placed upon or against them, pay particular attention to cords at plugs, convenience receptacles, and the point where they exit from the appliance.
3. **CAUTION – Polarization** – This appliance may be equipped with a polarized alternating-current line plug (a plug having one blade wider than the other). This plug will fit into the power outlet only one way. This is a safety feature. If you are unable to insert the plug fully into the outlet, try reversing the plug. If the plug should still fail to fit, contact your electrician to replace your obsolete outlet. Do not defeat the safety purpose of the polarized plug.
4. **Ventilation** – Slots and openings in the cabinet are provided for ventilation and to ensure reliable operation of the appliance and to protect it from overheating, and these openings must not be blocked or covered. The appliance should be situated so that its location or position does not interfere with its proper ventilation.
To maintain good ventilation, do not put records or a table-cloth on the appliance. Place the appliance at least 10 cm away from the walls.
Do not use the appliance on a bed, sofa, rug or similar surface that may block the ventilation openings. This appliance should not be placed in a built-in installation such as a bookcase or rack unless proper ventilation is provided or the manufacturer's instructions have been adhered to.
5. **Water and moisture** – The appliance should not be used near water - for example, near a bathtub, washbowl, kitchen sink, laundry tub, in a wet basement, or near a swimming pool, etc.
6. **Temperature** – The appliance may not function properly if used at extremely low, or freezing temperatures. The ideal ambient temperature is above +5°C (41°F).
7. **Heat** – The appliance should be situated away from heat sources such as radiators, heat registers, stoves, or other appliances (including amplifiers) that produce heat.
8. **Electric shock** – Care should be taken so that objects do not fall and liquid is not spilled into the enclosure through openings. If a metal objects, such as a hair pin or a needle, comes into contact with the inside of this appliance, a dangerous electric shock may result. For families with children, never permit children to put anything, especially metal, inside this appliance.
9. **Enclosure removal** – Never remove the enclosure. If the internal parts are touched accidentally, a serious electric shock might occur.

10. Cleaning – Unplug this appliance from the wall outlet before cleaning. Do not use volatile solvents such as alcohol, paint thinner, gasoline, or benzine, etc. to clean the cabinet. Use a clean dry cloth.

11. Lightning – For added protection for this appliance during a lightning storm, or when it is left unattended and unused for long periods of time, unplug it from the wall outlet and disconnect the antenna or cable system. This will prevent damage to the appliance due to lightning and power-line surges.

12. Abnormal smell – If an abnormal smell or smoke is detected, immediately turn the power OFF and unplug the appliance from the wall outlet. Contact your dealer or nearest service center.

13. Damage requiring service – The appliance should be serviced by qualified service personnel when:

- A. The power-supply cord or the plug has been damaged.
- B. Objects have fallen, or liquid has been spilled into the appliance.
- C. The appliance has been exposed to rain or water.
- D. The appliance does not appear to operate normally by following the instruction manual. Adjust only those controls that are covered by the instruction manual as an improper adjustment of other controls may result in damage and will often require extensive work by a qualified technician to restore the appliance to its normal operation.
- E. The appliance has been dropped, or the enclosure damaged.
- F. The appliance exhibits a marked change in performance.

14. Servicing – The user should not attempt to service the appliance beyond that described in the instruction manual. All other servicing should be referred to qualified service personnel.

15. Power lines – An outside antenna system should not be located in the vicinity of overhead power lines or other electric light or power circuits, or where it can fall into such power lines or circuits. When installing an outside antenna system, extreme care should be taken to keep from touching such power lines or circuits as contact with them might be fatal.

16. AC outlets – Do not connect other audio equipment with a power consumption larger than that specified to the AC outlet on the rear panel. Never connect other electrical appliances, such as an iron or toaster, to it to prevent fire or electric shock.

17. Overloading – Do not overload wall outlets, extension cords, or integral convenience receptacles as this can result in a risk of fire or electric shock.

18. Attachment – Do not use attachments not recommended by the appliance manufacturer as they may cause hazards.

19. Replacement parts – When replacement parts are required, be sure the service technician has used replacement parts specified by the manufacturer or have the same characteristics as the original parts. Unauthorized substitutions may result in fire, electric shock, or other hazards.

20. Safety check – Upon completion of any service or repairs to this appliance, ask the service technician to perform safety checks to determine that the appliance is in proper operating condition.



System connections

6

Caution:

Do not plug in the power lead until all connections are completed.

Malfunction of microcomputer

If operation is not possible or erroneous display appears even though all connections have been made properly, reset the microcomputer referring to "In case of difficulty". → 22

Make connections as shown below.

When connecting the related system components, refer also to the instruction manuals of the related components.

Caution

Be sure to adhere followings. Or proper ventilation will be blocked causing damage or fire hazard.

- Do not place any objects impairing heat radiation onto the top of unit.
- Leave a space around the unit (from the largest outside dimension including projection) equal or greater than, shown below.

Top panel : 50 cm Side panel : 10 cm Back panel : 10 cm

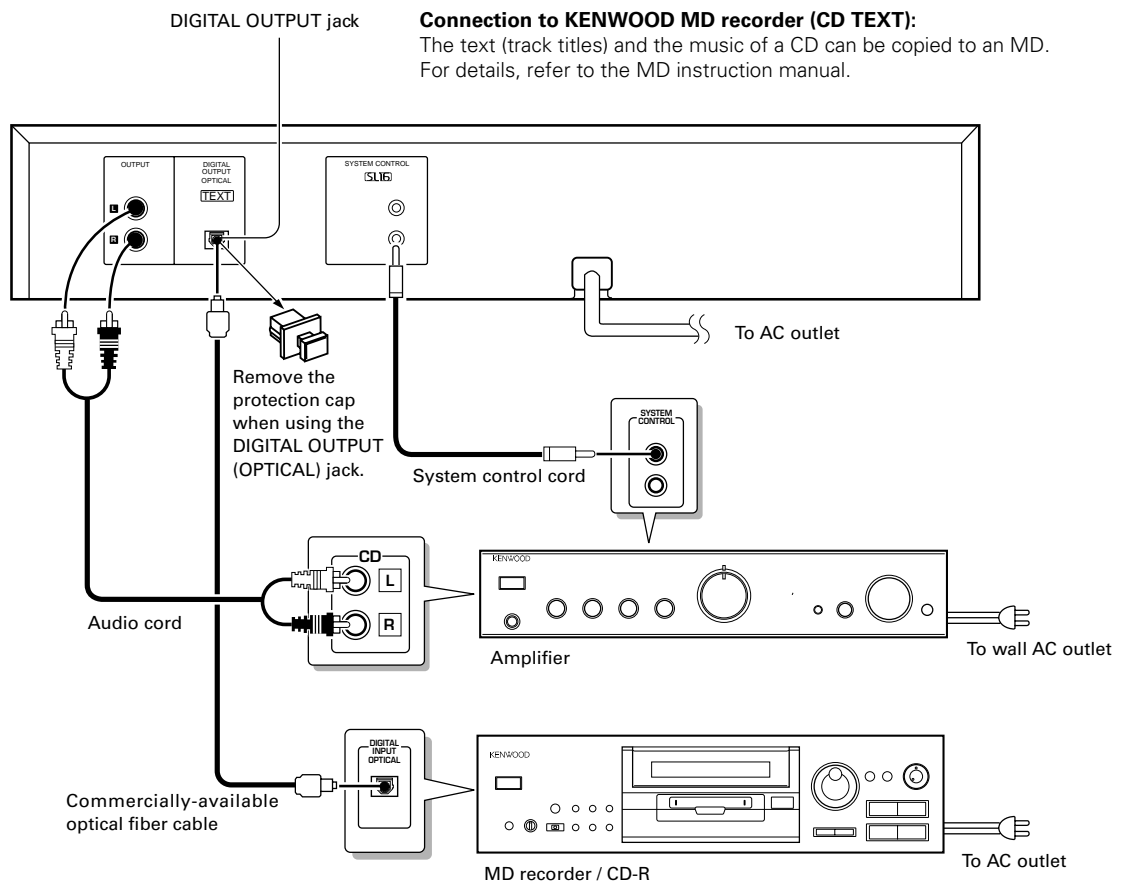

1. Connect all cords firmly. If connections are loose there could be loss of sound or noise produced.
2. When plugging and unplugging connection cords, be sure to first remove the power cord from the AC outlet. Plugging/unplugging connection cords without removal of the power cord can cause malfunctions or damage to the unit.

Connection to a general-use amplifier

Use the provided audio cords to connect the OUTPUT jacks of this unit to the CD input jacks (or AUX jacks) of the amplifier.

Connection to digital amplifier, MD or CD-R

Connect the DIGITAL OUTPUT (OPTICAL) jack to the digital input jack of the amplifier, DAT recorder, MD recorder, etc., using an optical fiber cable (sold separately) which are commercially available in audio stores.

- When using an optical fiber cable to connect this unit to a digital amplifier, insert the plug straight into the jack until a snap sound is heard.
- Be careful not to bend, coil, or bundle the optical fiber cable.
- Optical fiber cables available on the market may not always be able to be used with this player. If your cord cannot be used with this unit, consult the store from which you purchased the cord or your nearest dealer.

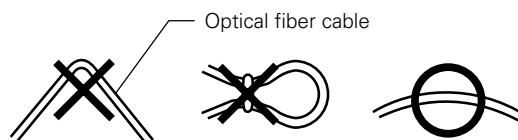

Adjusting the output levels of the output jacks and headphone output

The OUTPUT level (UP/DOWN) keys of the remote control unit can adjust the output levels from the LINE/OUT jacks and PHONES jack of the unit.

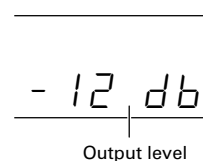
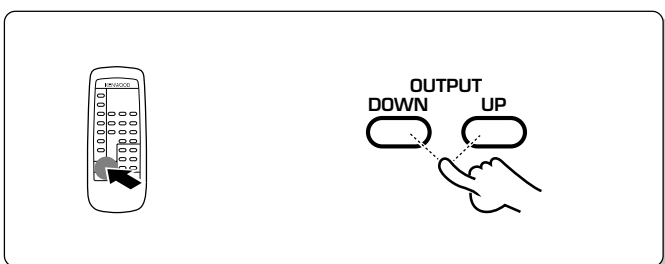

To use the headphone

Connect a stereo headphone to the PHONES jack of the CD player. Adjust the sound volume using the remote control unit.

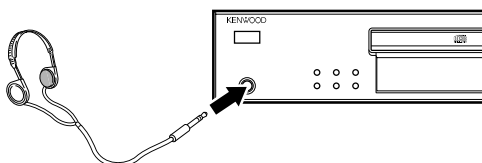

- It is not favorable for the sound quality to decrease the output level from this unit too much. Use these keys for coordination with other line levels.
- Adjusting the headphone output level also changes the LINE/OUT level. Do not adjust the output level from this unit particularly during recording.
- Please note that the sound output is at the maximum level when the power is turned on.

SYSTEM CONTROL CONNECTIONS

Connecting system control cords after connecting a KENWOOD audio component system lets you take advantage of convenient system control operations.

This unit is compatible only with the [SL16] mode. The system control operation is not available if the unit is connected in the [XS-8] connection mode.

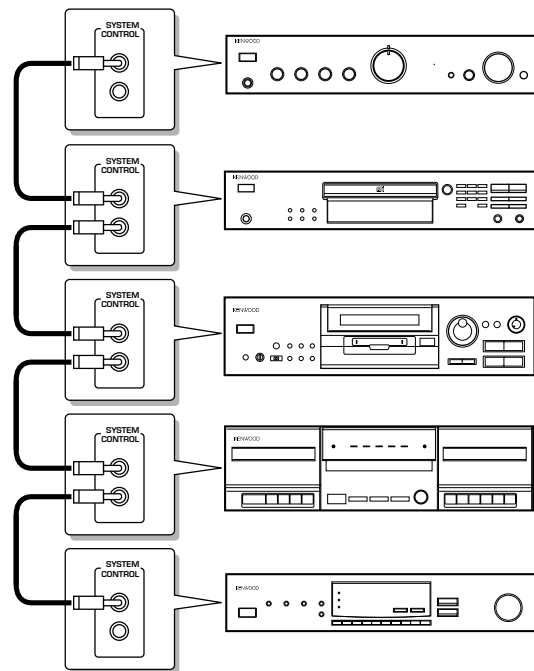

- Do this operation after completing all connections.
(Ensure that the unit is set to POWER OFF.)



1. If your amplifier or receiver does not have a system control terminal, do not connect any system control cords to the system control terminals on the other components.
2. Do not connect system control cords to any components other than those specified by Kenwood. It may cause a malfunction and damage your equipment.
3. Be sure the system control plugs are inserted all the way in to the system control terminals.

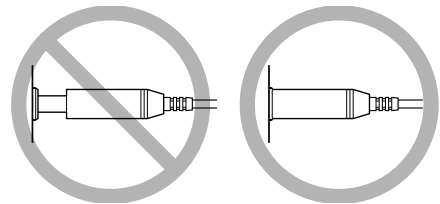

SYSTEM CONTROL OPERATIONS

Remote Control

Lets you operate this unit with the system remote control unit supplied with the amplifier or receiver.

Automatic Operation

Automatically switches the input selector on the amplifier or receiver when you start playback from this unit.

Synchronized Recording

Lets you synchronize recording with the start of playback when recording from CD. Also, the simple CCRS operation lets you make great recordings from CD.

See the operating instructions supplied with your cassette deck and MD recorder for details.

Disc handling precautions

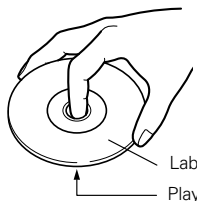

Handling

Hold the discs so that you do not touch the playing surface.

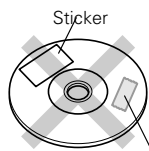

Do not attach paper or tape to either the playing side or the label side of the discs.

Sticky paste

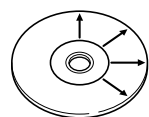

Cleaning

If fingerprints or foreign matter become attached to the disc, lightly wipe the disc with a soft cotton cloth (or similar) from the center of the disc outwards in a radial manner.

Storage

When a disc is not to be played for a long period of time, remove it from the player and store it in its case.

Discs which can be played with this unit

DVD (12 cm, 8cm), CD (12 cm, 8 cm), VCD, and the audio part of CDV, CD-G, CD-EG and CD-EXTRA.

Use discs that comply with the IEC standard, for example a disc carrying the  marking on the label surface.

Never play a cracked or warped disc

During playback, the disc rotates at high speed in the player. Therefore, to avoid danger, never use a cracked or deformed disc or a disc repaired with tape or adhesive agent. Please do not use discs which are not round because they may cause a malfunction.

Disc accessories

The disc accessories (stabilizer, protection sheet, protection ring, etc.) which are marketed for improving the sound quality or protecting discs as well as the disc cleaner should not be used with this system because they may cause malfunction.

Cleaning

Do not use volatile solvents such as alcohol, paint thinner, gasoline, or benzene, etc. to clean the cabinet. Use a clean dry cloth.

Do not use contact cleaners because it could cause a malfunction. Be specially careful against contact cleaners containing oil, for they may deform the plastic components.

Note related to transportation and movement

Before transporting or moving this unit, carry out the following operations.

1. Turn the power ON but do not load a disc.
2. Verify that the display shown appears.

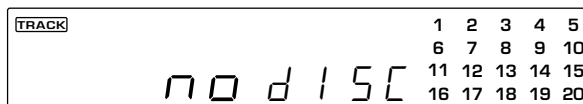

3. Wait a few seconds and set the unit to STANDBY mode.

Caution on condensation

Condensation (of dew) may occur inside the unit when there is a great difference in temperature between this unit and the outside. This unit may not function properly if condensation occurs. In this case, leave the unit for a few hours with the power left ON, and restart the operation after the condensation has dried up.

Be specially cautious against condensation in a following circumstance:

When this unit is carried from a place to another across a large difference in temperature, when the humidity in the room where this unit is installed increases, etc.

Controls and indicators

10

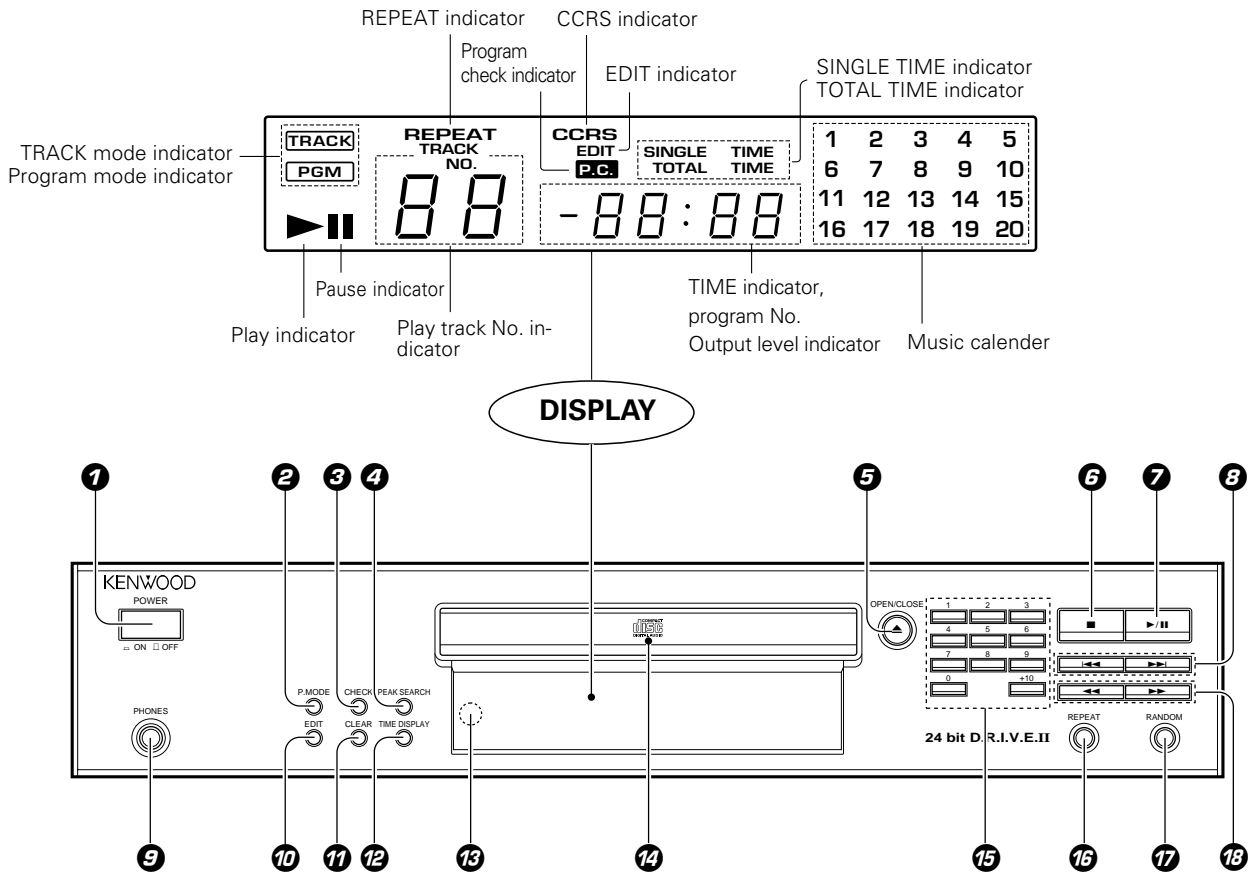

The keys with the same name as those on the remote control unit operate the same way as the remote control unit.

- | | | | |
|--|------|---|------|
| 1 POWER switch | → | 10 EDIT key | → |
| 2 P.MODE key
Press for program playback. | → | 11 CLEAR key
Press to clear the contents of a program. | → → |
| 3 CHECK key
Press to display the programmed contents in order. | → → | 12 TIME DISPLAY key
Press to switch the time display mode. | → |
| 4 PEAK SEARCH key | → | 13 Remote control light sensor | → |
| 5 Open/Close key (▲)
Opens and closes the disc tray. | → | 14 Disc tray
Load the disc to be played back. | → |
| 6 STOP key (■) | → | 15 Numeric keys
Use the numeric keys to select the desired track. | → |
| 7 PLAY/PAUSE key (▶/⏸)
Each time the key is pressed, playback and pause switch each other. | → | 16 REPEAT key
Press to start repeated playback. | → |
| 8 Skip keys (◀◀, ▶▶)
Press to skip to the beginning of another track. | → | 17 RANDOM key
Press to start random playback. | → |
| 9 PHONES jack
Use to connect (optional) headphones. | → | 18 Search keys (◀◀, ▶▶)
Fast forwards or fast reverses the track. | → |

Operation of remote control unit

The keys with the same name as those on the main unit operate the same way as the main unit. The keys marked * are provided only on the remote control unit.

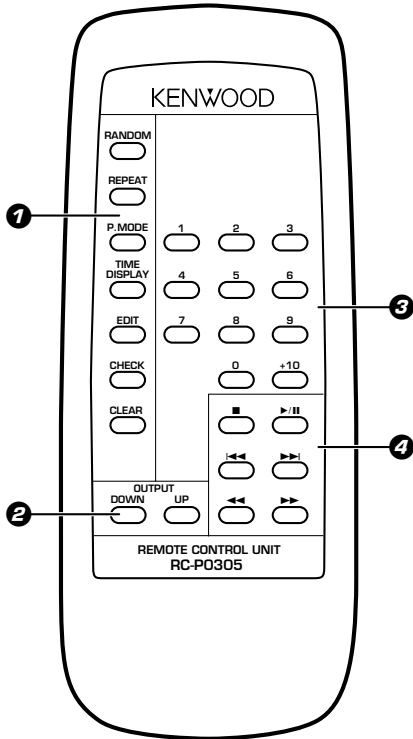

Model: RC-P0305
Infrared ray system

1 Program-related and other keys

RANDOM key	→	20
REPEAT key	→	16
P.MODE key	→	14
TIME DISPLAY key	→	13
EDIT key	→	18
CHECK key	→	15 → 19
CLEAR key	→	15 → 19

* 2 OUTPUT (DOWN, UP) key → 7

3 Numeric keys (1 ~ 0 , +10) → 13

4 Basic function keys

Skip keys (⏮, ⏭)	→	13
Search keys (⏪, ⏩)	→	13
Stop key (■)	→	12
Play/Pause key (▶/⏸)	→	12

Loading batteries

1 Remove the cover.

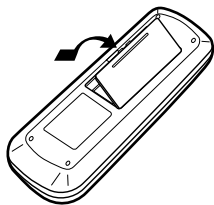

2 Insert batteries.

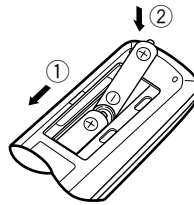

3 Close the cover.

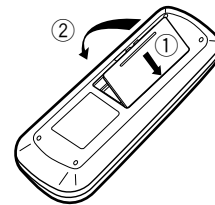

- Insert two AA-size (R6) batteries as indicated by the polarity marking.

Operation

After plugging in the power cord, press the **POWER** switch of the main unit to turn the unit **ON**. When the unit is turned **ON**, press the key of the function to be operated.

- When pressing more than one remote control key successively, press the keys securely by leaving an interval of 1 second or more between keys.

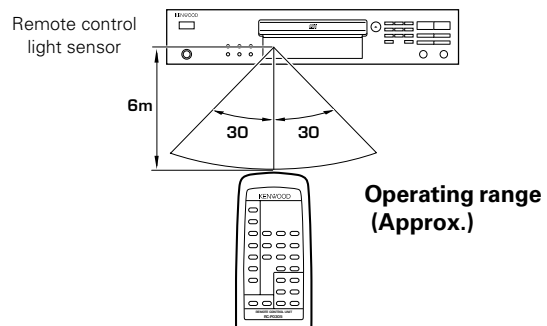

1. The supplied batteries are intended for use in operation checks. Therefore, their lives may be shorter than ordinary batteries.
2. When the remote-controllable distance gets shorter than before, replace both batteries with new ones.
3. Malfunction may occur if direct sunlight or the light of a high-frequency lighting fluorescent lamp enters the remote control light sensor. In such a case, change the system installation position to prevent the malfunction.

Normal play (TRACK mode)

Use the following procedure to play a CD in the original order of tracks from track No. 1.

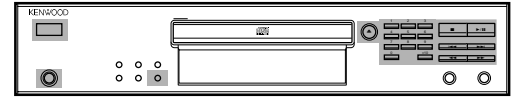
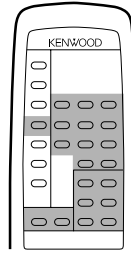

 : Keys and control used in the operations described on this page.

Playing tracks in order from track No. 1

1 Press the POWER switch to ON.

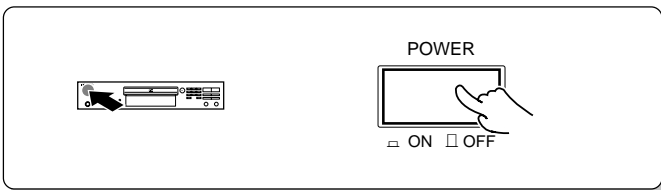

- Playback starts when a disc has been loaded.

2 Load a disc.

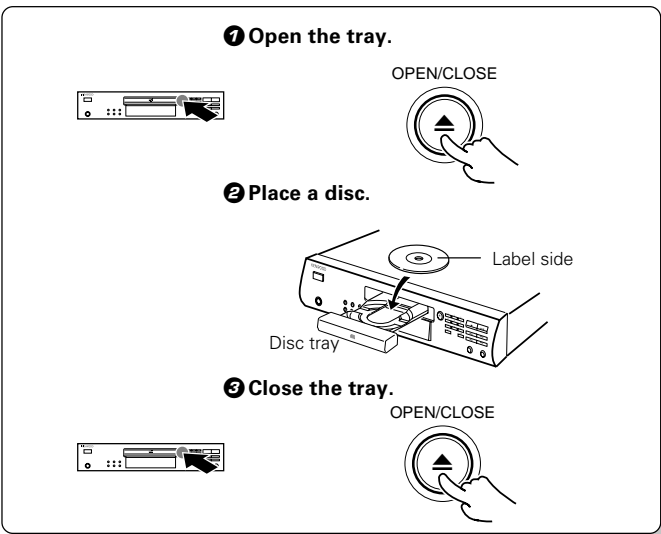

- Do not touch the played side of disc.
- Loading two discs together will cause malfunctioning.
- Place the disc properly along the groove on the tray. (If the disc is not placed horizontally, malfunction will result.)
- A single CD (8 cm disc) can also be played.
- Ordinary CD single (8 cm) disc adapters sold in audio stores cannot be used with this unit.



The track Nos. recorded on the CD are displayed.

3 Start playback.

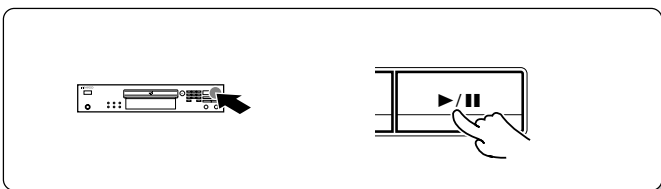

- After a few seconds, play starts from the track No. 1.

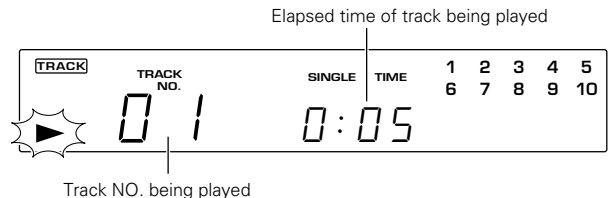

Track NO. being played

To pause playback

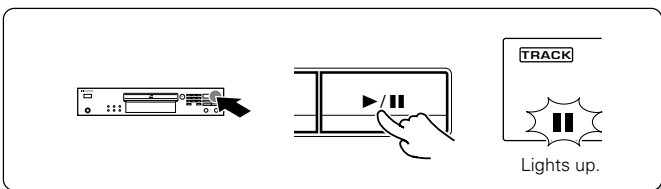

- Each press pauses and plays the CD alternately.

To stop playback

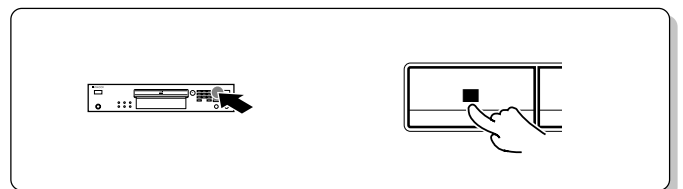

Playback from desired track

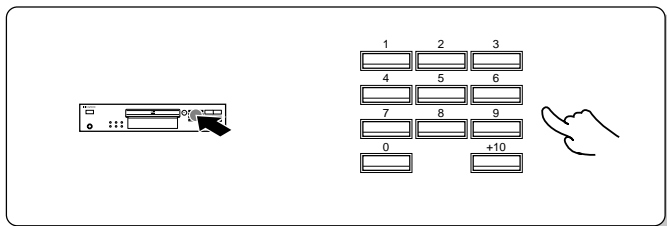

Press the numeric keys as shown below....

- To enter track No. 23 : **+10 +10 3**
- To enter track No. 40 : **+10 +10 +10 +10 0**

- Playback starts from the selected track and continues on the subsequent tracks.

Skipping tracks

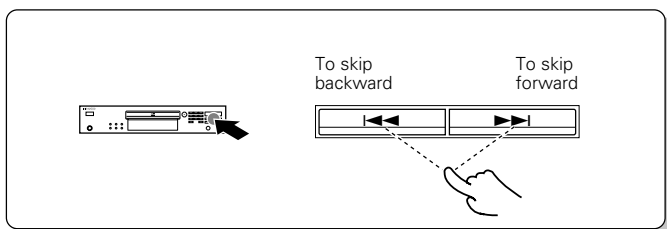

- The track in the direction of the pressed key is skipped, and the selected track will be played from the beginning.
- When the **I◀◀** key is pressed once during playback, the track being played will be played from the beginning.

Searching

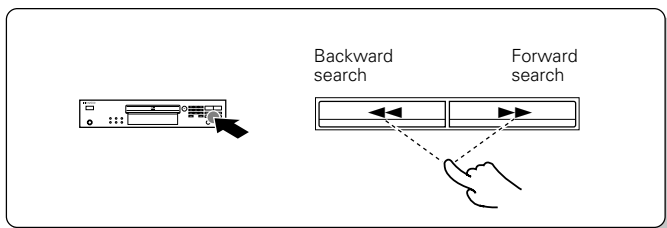

- Playback starts from the position where the key is released.

Time display on CD player (TIME DISPLAY)

Each press of the TIME DISPLAY key changes the displayed contents.

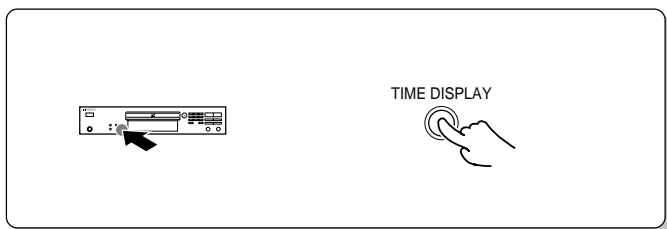

- ① ^{SINGLE TIME} 1:23 : Elapsed time of track being played (**SINGLE TIME** lights up.)
- ② ^{SINGLE TIME} -2:37 : Remaining time of track being played (**SINGLE TIME** lights up.)
- ③ ^{TOTAL TIME} 23:45 : Elapsed time of entire disc (**TOTAL TIME** lights up.)
- ④ ^{TOTAL TIME} -36:15 : Remaining time on entire disc (**TOTAL TIME** lights up.)

- Only the display ① and ② will be displayed in **RANDOM** and **EDIT** modes.

Programmed play (PGM mode)

Use the following procedure to program desired tracks in a desired order. (up to 20 tracks)

14

Preparation

- Load a disc in the CD player.

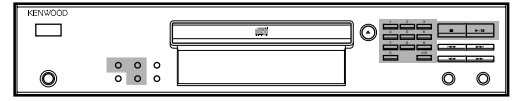
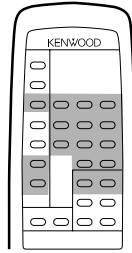

 : Keys and control used in the operations described on this page.

1 Press so that the "PGM" indicator lights.

Do this operation in the stop mode.

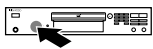

P.MODE



Lights up.

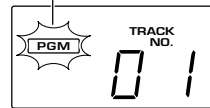

2 Program desired tracks.

1 Select the desired track No.

Press the numeric keys as shown below....
To enter track No. 25: **+10 +10 5**

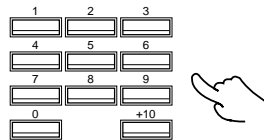

Go to step 2 within 5 seconds.

2 Set the entry.



P.MODE



3 Repeat steps 1 and 2 above.

Displays the entered program No. for a few seconds.

Displays the total playing time of the programmed tracks.

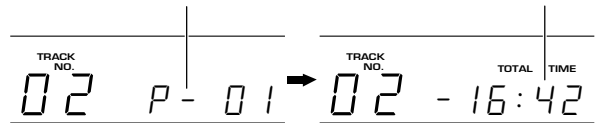

- Up to 20 tracks can be programmed. When "FULL" is displayed, no more tracks can be programmed.
- If you make a mistake, press the **CLEAR** key and enter the track No. from the beginning.
- When the total playing time of the programmed tracks exceeds 100 minutes, the remaining time on the disc will not be displayed any more.

3 Start playback.

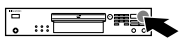

- When the **⏮** or **⏭** key is pressed during playback, the track will be skipped in the direction of the pressed button.
- When the **⏮** key is pressed once during playback, the play position returns to the beginning of the current track being played.

To stop playback

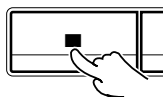

- The programmed contents remain in memory.

Auto space function

During programming of tracks, a non-recorded space of a few seconds will be automatically created between tracks. By recording tracks with these spaces on tape, the search and repeat play operations of tape using the DPSS function (which works by searching the non-recorded spaces) can be performed reliably.

- Even when the performances of two tracks are continuous (which occurs with classical or live recording music), the spaces will be created if they have different track numbers.

To check or change the programmed tracks

1 Press the CHECK key.

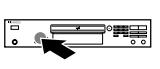

CHECK Press until the track No. to be changed is displayed.

2 Select the new track No.

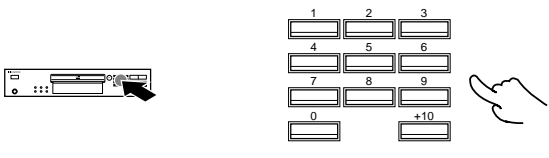

3 Set the entry.

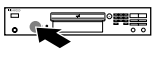

P.MODE

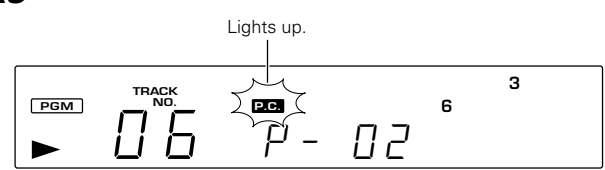

- Perform only step 1 to simply check the program.
- Each time the key is pressed, the program No. (P-No.) and the track No. on CD are displayed.
- The previous display resumes in a few seconds.
- Press it while the "P.C." indicator is lit.
- The track being played cannot be changed.

To add a track to the program

1 Select the desired track No.

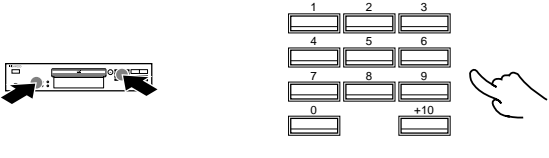

2 Press the P.MODE key.

- When a track No. is selected, the track will be added to the end of the existing program.

To clear tracks from the program

Press to clear tracks from the end.

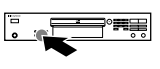

CLEAR

To clear all track.

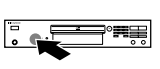

P.MODE

- Each time the key is pressed, the last track in the program is cleared.
- The tracks which are programmed earlier than the track being played cannot be cleared.

- Selected tracks can be also completely cleared just by operating the ▲ key.
- The entire program is cleared.

Repeated playback

Preparation

- Load a disc in the CD player.

→ 12

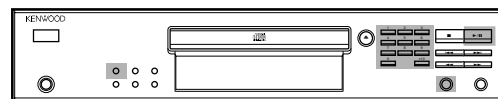
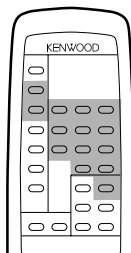

 : Keys and control used in the operations described on this page.

To repeat only the programmed tracks

- 1 Press so that the "PGM" indicator lights.



Do this operation in the stop mode.

- 2 Select the desired track No.

Press the numeric keys as shown below...
To enter track No. 25: **+10 +10 5**

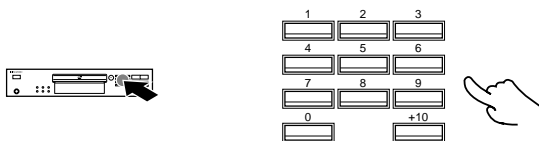

Go to step 3 within 5 seconds.

- 3 Set the entry.



- 4 Repeat steps 2 and 3 above.

- 5 Switch REPEAT ON.



- 6 Start playback.

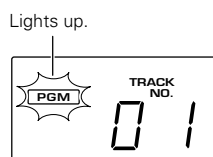
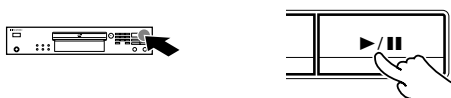

- All of the programmed tracks will be repeated.
- In case only one track is programmed, only that track will be repeated.
- Up to 20 tracks can be programmed. When "FULL" is displayed, no more tracks can be programmed.

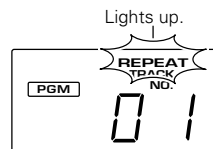

To cancel repeated playback

Press the REPEAT key again.

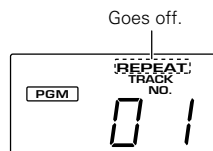

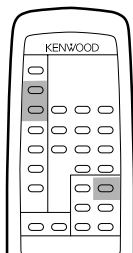

 : Keys and control used in the operations described on this page.

To repeat the entire disc

1 Press so that the "TRACK" indicator lights.



2 Switch REPEAT ON.



3 Start playback.



Lights up.



Lights up.



To cancel repeated playback

Press the REPEAT key again.



Goes off.

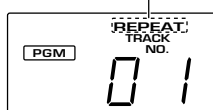

Editing

18

The following procedure allows to record a CD within the specified tape length so that no music is interrupted in the middle at the ends of sides A and B.

Preparation

- Load a disc in the CD player.

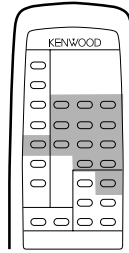

 : Keys and control used in the operations described on this page.

1 Light the "EDIT" indicator.

Do this operation in the stop mode.

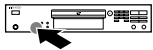



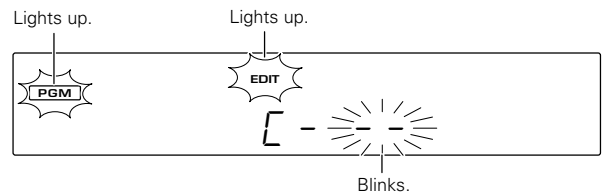

Go to step 2 within 5 seconds. If more than 5 seconds have elapsed, press the key again.

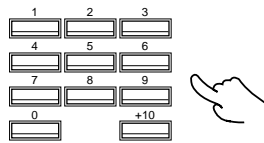





2 Enter the recording time of the tape.



Press the numeric keys as shown below.

30-minute tape :    

46-minute tape :     

- Recording within 99 minutes can be specified in minutes (2 digits).
- While you can edit with a different time setting to that of the tape you are using, part of the tape may be left with nothing recorded on it, or the last track on side A or side B may be cut short.

The CD contents are edited as follows.

- (1) The tape recording time input is divided by two, and tracks that can be accommodated in file A (which refers to tracks on tape side A) are selected in order of their track Nos.
- (2) In a few seconds, the time left on tape side A is displayed, then file B (tracks on tape side B) is edited in the same manner.

- The EDIT function may not operate properly for discs having only one track or having tracks of long duration such as classical music. ("no FILE" is displayed.)

Playing or recording the edited contents

Press the ►/|| key to start playback according to the edited content. The playback pauses at the beginning of the track edited for tape side B. Press the ►/|| key again to continue playback.

When recording the edited content onto a tape, it is recommended to use the synchro recording or **CCRS** recording function of KENWOOD cassette decks.

- Do not adjust the output level from this unit particularly during recording.
- For details, see the instruction manual of the cassette deck.

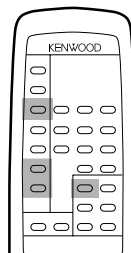

 : Keys and control used in the operations described on this page.

To check the edited contents

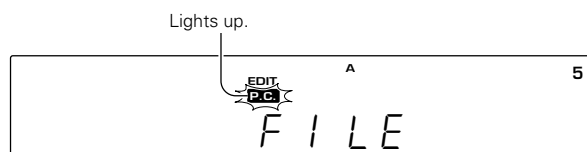
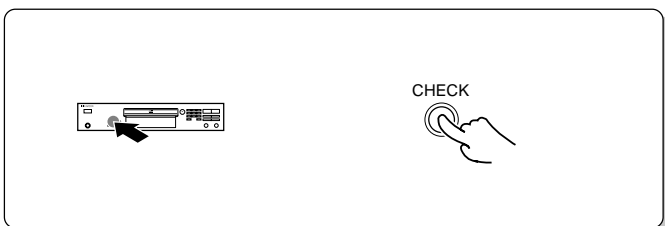

- When the **CHECK** key is pressed, track numbers and remaining time in the file A are displayed first, then those in the file B.
- The "**P.C.**" indicator goes off in a few seconds.

To clear the edited contents

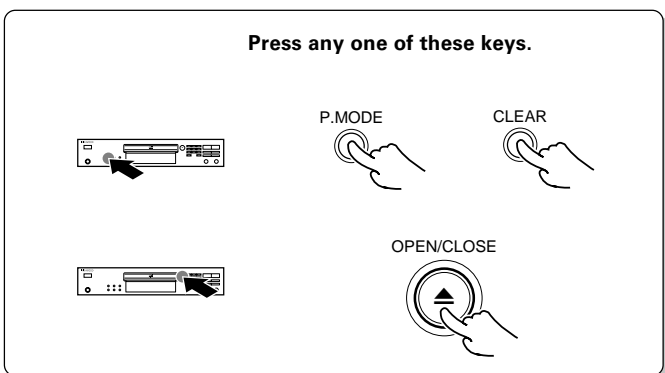

- The edited data is cleared entirely.

Peak search

This function identifies the highest peak level of the entire recording on a CD before recording the CD on the cassette deck. With this unit, after the peak level of each track recorded on the CD has been searched, the section of the music containing the highest peak level will be played repeatedly so that the recording level of the cassette deck or MD (analog recording) can be adjusted easily. This feature is particularly convenient when using a cassette deck with manual recording level adjustment which does not have the automatic recording level adjustment function. (This unit cannot perform peak search recording when used with a cassette deck equipped with the peak search function.)

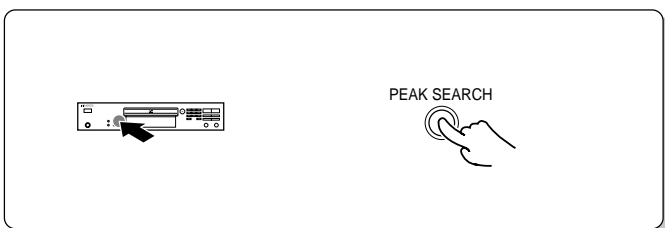

- Press the **PEAK SEARCH** key.
- After a high-speed search of all tracks, the searched peak level section will be repeated at normal speed.
- The peak level is detected by sampling the section which seems to contain the maximum level in the disc. However, it may happen that the transient maximum level is not detected. Therefore, it is recommended to set the recording level by leaving a certain margin above the detected peak level.

To cancel Peak search:

Press the  key.

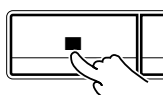



Playback in a random order (Random playback)

As tracks are selected at random, you can enjoy listening to for a long time.

Preparation

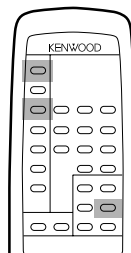
- Load a disc in the CD player.
→ [12]



 : Keys and control used in the operations described on this page.

1 Press the P.MODE key so that the "TRACK" indicator lights.

If the "PGM" indicator is lit, press the P.MODE key.



Lights up.

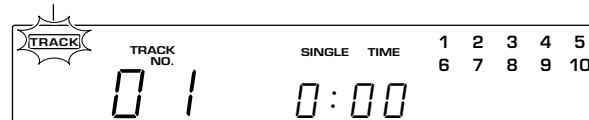

2 Press the RANDOM key.

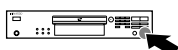

In case track No. 5 is selected

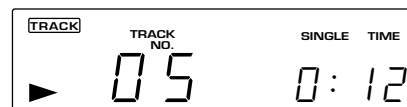

- Each time a track ends, another track is selected and played.
- Random play stops after all of the tracks have been played once.
- The random playback can also be repeated by pressing the **REPEAT** key.

To select another track in the middle of playing one

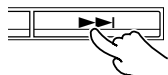
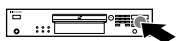

- Pressing the **◀◀** key once returns to the beginning of the track being played.

To cancel random playback

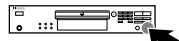

- Press the **RANDOM** key to start normal playback.

Timer operations

Timer playback of CD can be started at any time using an audio timer which is available in audio stores.

Preparation

- Connect the power cords of the associated components so that their power can be turned ON through the audio timer. (Also, be sure to read carefully the instruction manual of the timer.)

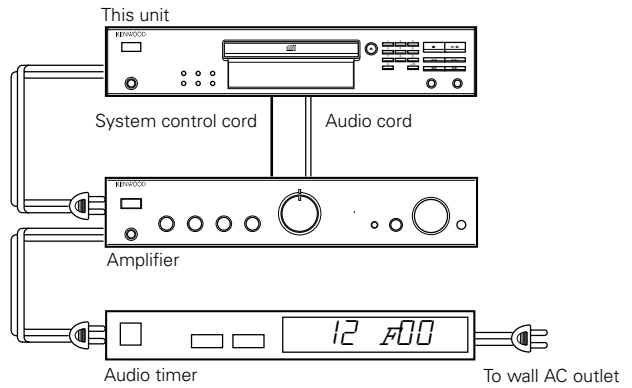

1 Turn the powers of the associated components ON.

2 Preparation

Load a disc in the CD player. → 12

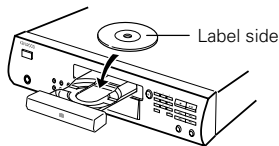

3 Set the amplifier volume.

1 Play the disc.



2 Adjust the amplifier volume. (Use the remote control unit of this unit to adjust the volume to the maximum level.)

3 Stop the disc.



4 Set the timer ON time.

Set the timer so that it supplies power at the specified time.

5 Turn OFF the power output from the audio timer.

- If the amplifier is not connected to the CD player through a system control cord, select the "CD" input with the input selector.

Note **Adjusting the volume:** Set the volume the maximum (0 dB) using the OUTPUT (UP) key on the remote control unit, and adjust the volume to the desired level on the amplifier side. (Since the sound output is at the maximum level when the power is turned on, lowering the level with the remote control will change the volume.)

- With some audio timer models, the power is automatically turned OFF when the timer ON time is set. With such a model, skip step 5 below.

- Do not touch the ON/STANDBY or POWER switches of the amplifier and CD player.
- When the set time comes, the disc playback starts automatically.



1. Some amplifiers cannot be used with a timer. Before using an amplifier, check it.
2. When operating the unit other than CD player using an audio timer, be sure to remove the disc from the CD player.

In case of difficulty

What appears to be a malfunction may not always be serious. If your unit should not perform as expected, consult the table below to see if the problem can be corrected before seeking help from your dealer or service representative.





Operation to reset

The microcomputer may fall into malfunction (impossibility to operate, erroneous display, etc.) when the connection cords are unplugged while unit is ON or due to an external factor. In this case, execute the following method to reset the microcomputer and return it to normal condition.



Set the unit to OFF by pressing the POWER switch, and after a few seconds, turn the unit ON by pressing the POWER switch again.

- Please be aware that resetting the CD player will erase all stored information and return it to the factory settings.

CD player unit

Symptom	Cause	Remedy
The unit is not turned ON with the POWER switch ON.	<ul style="list-style-type: none"> ● Power plug is loosely connected. ● With the power plug connected to the switched AC outlet of an amplifier, the power of the amplifier is turned off. 	<ul style="list-style-type: none"> ● Insert the power plug firmly to the AC outlet. ● Turn the amplifier's power ON.
Disc is loaded, player does not play.	<ul style="list-style-type: none"> ● Disc is loaded upside down. ● Disc is loose. ● Disc is dirty. ● Disc is cracked. ● Condensation has occurred on the optical lens unit. 	<ul style="list-style-type: none"> ● Load the disc again with its label side up. ● Insert the disc properly. ● Wipe off the dust on the surface of the disc referring to "Disc handling precautions". →  9 ● Replace the disc with a new one. ● Leave the player for about 1 hour so that the condensation is removed. →  9
No sound.	<ul style="list-style-type: none"> ● Play mode is not entered. ● Disc is too dirty. ● Disc is cracked. ● The connection cords are inserted loosely. ● Output level is attenuated too low. 	<ul style="list-style-type: none"> ● Press the ►/ key. ● Wipe off the dust on the disc surface referring to "Disc handling precautions". →  9 ● Replace the disc with a new one. ● Connect all connection cords firmly. ● Adjust the output level with OUTPUT key on the remote control unit. →  7
Music is interrupted. (Sound is skipped.)	<ul style="list-style-type: none"> ● Disc is too dirty. ● Disc is cracked. ● Oscillation is applied to this unit. 	<ul style="list-style-type: none"> ● Wipe off the dust on the disc surface referring to "Disc handling precautions". →  9 ● Replace the disc with a new one. ● Try selecting a place where no strong vibrations occur by changing the installation place, etc.
Play begins as soon as the unit is turned ON.	<ul style="list-style-type: none"> ● This unit is designed so that play begins automatically when the unit is turned ON if a disc is already loaded. 	<ul style="list-style-type: none"> ● If automatic play is not required, remove the disc from the player before setting the unit to POWER OFF.

Remote control unit

Symptom	Cause	Remedy
Remote control operation is not possible.	<ul style="list-style-type: none"> ● Batteries are exhausted. ● The remote control unit is too far away from the main system, controlling angle is too large, or there is an obstacle in between. 	<ul style="list-style-type: none"> ● Replace with new batteries. →  11 ● Operate the remote control unit within the controllable range. →  11

Specifications

[Format]

System **Compact disc digital audio system**
Laser **Semiconductor laser**

[D/A Convertors]

D/A Conversion **1-bit D/A converter achieving a 24-bit resolution**
Oversampling **8 fs (352.8 kHz)**

[Audio]

Frequency response **4 Hz ~ 20 kHz, ± 0.5 dB**
Signal to noise ratio **More than 120 dB**
Dynamic range **More than 98 dB**
Total harmonic distortion + noise **Less than 0.003% (at 1 kHz)**
Channel separation **More than 100 dB (at 1 kHz)**
Wow & flutter **Unmeasurable Limit**
Output level/impedance
Variable **(Max.) 2.0 V/0.8 k Ω**
Digital output
Optical **-15 dBm – -21 dBm**
(Wave length 660 nm)
Headphone output (Max.) **20 mW (32 Ω)**

[General]

Power consumption **12 W**
Dimensions **W : 440 mm (17-5/16")**
H : 95 mm (3-3/4")
D : 370 mm (14-9/16")
Weight (Net) **4.3 kg (9.5 lb)**



1. KENWOOD follows a policy of continuous advancements in development. For this reason specifications may be changed without notice.
2. The full performance may not be exhibited in an extremely cold location (under a water-freezing temperature).

KENWOOD

For your records

Record the serial number, found on the back of the unit, in the spaces designated on the warranty card, and in the space provided below. Refer to the model and serial numbers whenever you call upon your dealer for information or service on this product.

Model _____ Serial Number _____