

WINAUTO



(044)361-05-06
(067)469-02-12
(099)048-99-03
(093)672-77-76

ICQ:495-089-192
ICQ:613-211-859

User's Manual

CD receiver Kenwood KDC-314A

In the online store Winauto you also can [buy car receiver Kenwood KDC-314A](http://winauto.ua) . Delivery in Kiev and throughout Ukraine with payment upon receipt!

<http://winauto.ua>



Car Receivers - Facia Plates - Head Units - TV and Monitors - Car Antennas - Car Audio - Car DVRs - GPS Navigation - Trip Computers - Security Systems - Mechanical Locking - Car Park Systems - Cameras - Optic and Light - Car Tuning - Car Heating - Marine Audio and Electronics - Car Accessories - Car Isolation - Car Installation Components - Car Batteries - Liquid and Oil -



KENWOOD

CD-RECEIVER

KDC-3047

KDC-3047GY

KDC-3047M

KDC-3247

KDC-3347

KDC-314

INSTRUCTION MANUAL

Kenwood Corporation



Contents

Before Use	3
Basic Operations	4
Before Using	
Common Operation	
Playing Music	
Listening Radio	
General	6
Removing the Faceplate	
Muting Volume upon Reception of Phone Call	
Display Indicator	
Text Display Selection	
Function Setting	8
<SETTINGS>	
<INITIAL SET>	
<DEMO MODE>	
<AUDIO CONTROL>	
Music Disc/Audio File Operation	12
Play Function	
Music Search	
Direct Music Search	
Tuner Operation	13
PTY (Program Type)	
Program Type preset	
Changing Language for PTY Function	
Basic Operations of Remote Control	14
Appendix	15
Accessories/Installation Procedure	16
Connecting Wires to Terminals	17
Installation/Removing the Unit	19
Troubleshooting Guide	20
Specifications	22



Declaration of Conformity with regard to the EMC Directive 2004/108/EC

Manufacturer:

Kenwood Corporation

2967-3 Ishikawa-machi, Hachioji-shi, Tokyo, 192-8525 Japan

EU Representative's:

Kenwood Electronics Europe BV

Amsterdamseweg 37, 1422 AC UITHOORN, The Netherlands

For Turkey

Bu ürün 26891 sayılı Resmi Gazete'de yayımlanan Elektrikli ve Elektronik Eşyalarda Bazı Zararlı Maddelerin Kullanımının Sınırlanmasına Dair Yönetmeliğe uygun olarak üretilmiştir.

This product complies with Directive, Number 26891 regarding "REGULATION ON THE RESTRICTION OF THE USE OF CERTAIN HAZARDOUS SUBSTANCES IN ELECTRICAL AND ELECTRONIC EQUIPMENT".

Before Use

▲WARNING

To prevent injury or fire, take the following precautions:

- To prevent a short circuit, never put or leave any metallic objects (such as coins or metal tools) inside the unit.

Before using this unit for the first time

This unit is initially set on the Demonstration mode. When using this unit for the first time, cancel the Demonstration mode. Refer to <Exit of the Demonstration Mode> (page 4).

How to reset your unit

- If the unit fails to operate properly, press the Reset button. The unit returns to factory settings when the Reset button is pressed.
 1. Release the faceplate lock so that it can be removed. Refer to <Removing the Faceplate> (page 6)
 2. Press the Reset button and reattaching the faceplate.

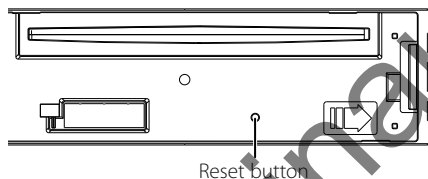

Cleaning the Unit

If the faceplate of this unit is stained, wipe it with a dry soft cloth such as a silicon cloth. If the faceplate is stained badly, wipe the stain off with a cloth moistened with neutral cleaner, then wipe it again with a clean soft dry cloth.



- Applying spray cleaner directly to the unit may affect its mechanical parts. Wiping the faceplate with a hard cloth or using a volatile liquid such as thinner or alcohol may scratch the surface or erase characters.

About the Terminals of the Unit and Faceplate

- To prevent deterioration, do not touch the terminals of the unit and faceplate with your fingers.
- If the terminals on the unit or faceplate get dirty, wipe them with a clean soft dry cloth.

Lens Fogging

When you turn on the car heater in cold weather, dew or condensation may form on the lens in the CD player of the unit. Called lens fogging, this

condensation on the lens may not allow CDs to play. In such a situation, remove the disc and wait for the condensation to evaporate. If the unit still does not operate normally after a while, consult your Kenwood dealer.

Notes

- If you experience problems during installation, consult your Kenwood dealer.
- When you purchase optional accessories, check with your Kenwood dealer to make sure that they work with your model and in your area.
- The characters which can be displayed by this unit are A-Z 0-9 @ " ' ` % & * + - = , . / \ < > [] () ; : ^ - { } | ~ .
- The RDS feature won't work where the service is not supported by any broadcasting station.
- The illustrations of the display and the panel appearing in this manual are examples used to explain more clearly how the controls are used. Therefore, what appears on the display in the illustrations may differ from what appears on the display on the actual equipment, and some of the illustrations on the display may be inapplicable.

Handling CDs

- Do not touch the recording surface of the CD.
- Do not stick tape etc. on the CD, or use a CD with tape stuck on it.
- Do not use disc type accessories.
- Clean from the center of the disc and move outward.
- When removing CDs from this unit, pull them out horizontally.
- If the CD center hole or outside rim has burrs, use the CD only after removing the burrs with a ballpoint pen etc.

CDs that cannot be used

- CDs that are not round cannot be used.
- CDs with coloring on the recording surface or CDs that are dirty cannot be used.
- This unit can only play the CDs with CD-ROM CD-DA CD-TEXT CD-EXTRA CD-R/CD-RW

This unit may not correctly play discs which do not have the mark.

- You cannot play a CD-R or CD-RW that has not been finalized. (For the finalization process refer to your CD-R/CD-RW writing software, and your CD-R/CD-RW recorder instruction manual.)
- 3 inch CD cannot be used. Attempt to insert using an adapter can cause malfunction.

Basic Operations

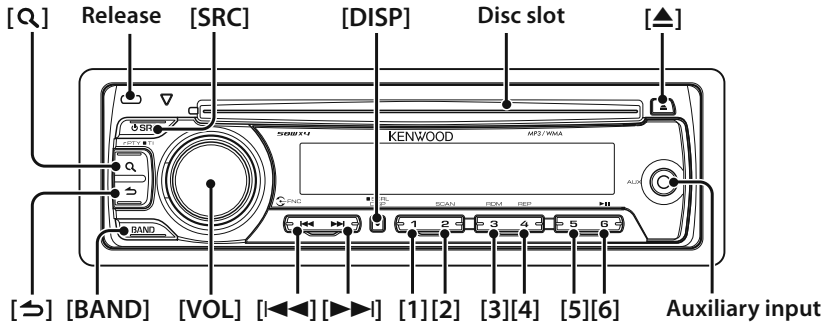

Before Using

Exit of the Demonstration Mode

Turn off the demonstration mode when you use it for the first time after installation.

- 1 Press the [VOL] knob to quit the demonstration mode when the messages "CANCEL DEMO", "PRESS", "VOLUME KNOB" are displayed (approx. 15 seconds).
- 2 Select "YES" and press the [VOL] knob. When "NO" is selected, turn the [VOL] knob.



- Demonstration mode can also be cancelled in "DEMO MODE" of <Function Setting> (page 8).

Adjusting the Clock

- 1 Press the [DISP] button several times until clock display ("CLOCK") appears.
- 2 Keep pressing the [DISP] button until the hour display blinks.
- 3 Turn the [VOL] knob to adjust the hour.
- 4 Press the [VOL] knob to finish the hour adjusting. The minute display blinks.
- 5 Turn the [VOL] knob to adjust the minute.
- 6 Press the [VOL] knob to finish the minute adjusting.



- You can do this adjustment when "TIME SYNC" in <Function Setting> (page 8) is set to "OFF".

Common Operation

Power and source select

Turns the power ON by pressing the [SRC] button.

When power is ON, pressing the [SRC] button switches among playable sources in the following order:

Tuner ("TUNER") → CD ("CD") → Auxiliary Input ("AUX") → Standby ("STANDBY") → Tuner ("TUNER")

Keeping pressing the [SRC] button for at least 1 second turns the power OFF.



- The source "CD" can be selected when each source is ready to play.

Volume

Turning the [VOL] knob adjusts the sound volume.

Clock display and Display scroll

Pressing the [DISP] button selects the display mode.

Refer to <Text Display Selection> (page 7).

Keeping pressing the [DISP] button scrolls the display.

Auxiliary input

Portable audio device can be connected with the stereo mini-plug (3.5 mm ϕ).

Playing Music

Playing Disc

Insert a disc into the disc slot.
When inserted, the source is switched automatically and a song starts playing.

Folder select

Pressing the [BAND] button switches a folder.

Song select

Pressing the [◀◀] or [▶▶] button selects a song (track or file).
Fast reverses or forwards the music while pressing the [◀◀] or [▶▶] button.
(No sound is output while playing audio file.)

Pause and play

Pressing the [6] button pauses or resumes playing a song (track or file).

Removing Disc

Pressing the [▲] button ejects a disc.



- For the playable audio files, see <About Audio file> (page 15).

Listening Radio

Select Tuner source

Pressing the [SRC] button several times switches the source to "TUNER".

Band select

Pressing the [BAND] button switches the receiving band (FM1, FM2, FM3, AM).

Station select

Pressing the [◀◀] or [▶▶] button selects the station.

Station memory

Pressing the [1] – [6] button recalls the memorized station.
Keeping pressing the [1] – [6] button for at least 2 seconds memorizes the station currently selected.

Traffic information

Press the [Q] button for at least 1 second.
Turns ON or OFF the Traffic Information function. When the function is turned ON, "TI" indicator is ON.
If traffic bulletin starts when the function is ON, "TRAFFIC" is displayed and traffic information is received.



- Details of the station selecting in operation are set in the "SEEK MODE" of <Function Setting> (page 8).
- Receivable stations can be automatically memorized. See "AUTO MEMORY" of <Function Setting> (page 8).
- Up to 6 each stations can be memorized to the [1] – [6] button in each band (FM1, FM2, FM3, AM).
- Up to 6 stations with a different band (FM/AM) can be memorized to the [1] – [6] button according to the setting of "PRESET TYPE" of <Function Setting> (page 8).
- If the volume is adjusted during reception of traffic information, the adjusted volume is memorized automatically. The memorized volume will be applied next time the Traffic Information function is turned ON.

General

Removing the Faceplate

The faceplate of the unit can be detached and taken with you, helping to deter theft.

Detach the faceplate

Press the Release button.

Reattaching the Faceplate

Refer to the following diagram when reattaching the faceplate.

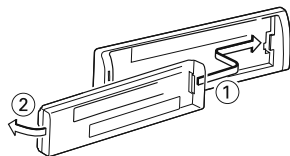

- After pressing the Release button, detach the faceplate immediately. If the faceplate is left attached, it can fall due to vibration and so on.
- The faceplate is a precision piece of equipment and can be damaged by shocks or jolts.
- Keep the faceplate in its faceplate case while detached.
- Do not place the faceplate (and the faceplate case) in areas exposed to direct sunlight, excessive heat or humidity. Also avoid places with too much dust or the possibility of water splashing.

Muting Volume upon Reception of Phone Call

The audio system automatically mutes when a call comes in.

When a call comes in

"CALL" is displayed.

The audio system pauses.

Listening to the audio during a call

Press the [SRC] button.

The "CALL" display disappears and the audio system comes back ON.

When the call ends

Hang up the phone.

The "CALL" display disappears and the audio system comes back ON.



- To use the TEL Mute feature, you need to hook up the MUTE wire to your telephone using a commercial telephone accessory. Refer to <Connecting Wires to Terminals> (page 17).

Display Indicator

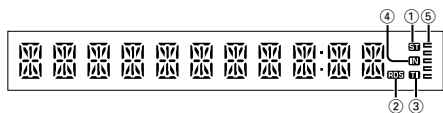

- ① “ST” indicator: Lights when a stereo broadcast is received.
- ② “RDS” indicator: Lights when the RDS service is available.
- ③ “TI” indicator: Lights when the Traffic Information function is on.
- ④ “IN” indicator: Lights when a disc is in the unit.
- ⑤ “= ” indicator: Shows the image indicating the operating state of each source or the setting of Audio Control.

Text Display Selection

Changes displayed information on each source following;

In Tuner source

Information	Display
Program Service name (FM)	“FREQ/PS”
Radio text (FM)	“RADIO TEXT”
Frequency (MW, LW)	“FREQUENCY”
Clock	“CLOCK”

In CD source

Information	Display
Disc title	“DISC TITLE”
Track title	“TRACK TITLE”
Play time & track number	“P-TIME”
Clock	“CLOCK”

In Audio file source

Information	Display
Music title & Artist name	“TITLE”
Album name & Artist name	“ALBUM”
Folder name	“FOLDER NAME”
File name	“FILE NAME”
Play time & Music number	“P-TIME”
Clock	“CLOCK”

In Standby/ Auxiliary input source

Information	Display
Source name	“SOURCE NAME”
Clock	“CLOCK”

Select the text

Press the [DISP] button.



- When you select the clock display, the display setting of each source will be changed to the clock display.
- If the selected display item does not have any information, alternative information is displayed.

Function Setting

Perform configuration for this unit. You can set up the following functions.

1 Select a source

Press the [SRC] button.

Items to be displayed vary depending on the selected source. Refer to the function list shown later.

2 Enter Function Setting mode

Press the [VOL] knob.

"FUNCTION" is displayed.

3 Select the Function item

Turn the [VOL] knob to display your desired item, and then press the [VOL] knob.

Repeat the above operation to select the function item to set.

Pressing the [↵] button allows you to go back to the previous item.

4 Set the Function item

Turn the [VOL] knob to select your desired setting, and then press the [VOL] knob.

5 Exit Function Setting mode

Press the [↵] button for at least 1 second.

Function item

Legend :

No Function name: "Function name displayed on this unit" ▶ "Setting 1", "Setting 2"...

The function related to the selected function item is described. For where it appears, refer to the **No** given in the function list.



- The setting marked with * is a factory setting.
- The function marked with *¹ is supported only by the KDC-3047/ KDC-3047M/ KDC-3247/ KDC-314.

<SETTINGS>

1 Clock Adjust: "CLOCK ADJ"

Sets the clock

1. Turn the [VOL] knob to adjust the hour.
2. Press the [VOL] knob to finish the hour adjusting. The minute display blinks.
3. Turn the [VOL] knob to adjust the minute.
4. Press the [VOL] knob to finish the minute adjusting.



- You can do this adjustment when "TIME SYNC" is set to

"OFF".

2 Synchronize the clock: "TIME SYNC" ▶

"ON"*,"OFF"

Synchronizing the RDS station time data and this unit's clock.

3 Dimmer: "DIMMER SET" ▶ "ON","OFF"*

Adjusts the brightness of the display according to the surrounding illumination.

4 Text Scroll: "TEXT SCROLL" ▶ "AUTO", "MANUAL"*

Scrolls the text display of CD, audio file and Radio text.

5 Local Seek: "LOCAL SEEK" ▶ "ON","OFF"*

Only stations whose reception is good are searched in auto seek tuning. (FM only)

6 Seek Mode: "SEEK MODE" ▶

"AUTO1"*,"AUTO2","MANUAL"

Selects the tuning mode of the radio.

Tuning mode	Display	Operation
Auto seek	"AUTO1"	Automatic search for a station.
Preset station seek	"AUTO2"	Search in order of the stations in the Preset memory.
Manual	"MANUAL"	Normal manual tuning control.

7 Auto Memory: "AUTO MEMORY"

Memorizes six stations with good reception automatically.

Selecting "YES" and then pressing the [VOL] knob starts the auto memory operation.



- This setting can be made when "TYPE NORM" is selected for the <Mixed Preset Memory Switching> item

8 Monaural Reception: "MONO SET" ▶

"ON","OFF"*

You can reduce the noise when stereo broadcasts are received as monaural. (FM only)

9 News: "NEWS SET" ▶ "OFF"*,"0"...90"

Automatically receives news bulletin when it starts. Set the time during which interrupt is to be disabled after start of another news bulletin.

Changing "NEWS 00M" to "NEWS 90M" turns this function ON.

If news bulletin starts when this function is ON, "NEWS" is displayed and news is received. If "20M" is has been set, reception of another news bulletin will not start for 20 minutes.

The news bulletin volume is the same level that was set for Traffic Information.

10 Alternative Frequency: "AF SET" ▶ "ON"*,"OFF"

When the reception is poor, automatically alternate to another frequency broadcasting the

same program in the same RDS network with better reception.

- 11 RDS Regional: "RDS REG" > "ON", "OFF"**
Sets whether to switch to the station only in the specific region using the "AF" control.
- 12 Auto TP Seek: "ATP SEEK" > "ON", "OFF"**
When traffic information station reception is poor, automatically searches for a station that can be received better.
- 13 Name Set: "AUX NAME" > "AUX", "DVD", "PORTABLE", "GAME", "VIDEO", "TV"**
Sets the display when switched to AUX source.

<INITIAL SET>

- 14 Mixed Preset Memory Switching: "PRESET TYPE" > "TYPE NORM", "TYPE MIX"**
"TYPE NORM":
1 station can be assigned to 1 preset button in each of 4 bands (FM1, FM2, FM3, and AM), i.e., a total of 24 stations (6 stations x 4 bands) can be preset.
"TYPE MIX":
A total of 6 stations can be assigned to a total of 6 preset buttons regardless of band (FM1, FM2, FM3, and AM). You can recall a preset station without switching between bands.

- 15 Beep: "KEY BEEP" > "ON", "OFF"**
Setting the operation check sound (beep sound) ON/OFF.
- 16 Russian language setting: "RUSSIAN SET" > "ON", "OFF"**
When this is set to ON, the following character strings are displayed in Russian:
Folder name/ File name/ Song title/ Artist name/ Album name

- 17 Power OFF Timer: "P-OFF WAIT" > "----", "20M", "40M", "60M"**
Setting the timer to turn this unit's power OFF automatically when Standby mode continues. Using this setting can save the vehicle's battery power.
----: Power OFF Timer function is OFF.
20M: Turns the power OFF after 20 minutes.
40M: Turns the power OFF after 40 minutes.
60M: Turns the power OFF after 60 minutes.

- 18 Built in AUX: "BUILT IN AUX" > "ON1", "ON2", "OFF"**
When this is set to ON, AUX source can be selected.

- ON1: Outputs the sound of external unit connected to the AUX terminal when switched to AUX source.
- ON2: Activates the attenuator function when turning on the power with AUX source selected.
Turn off the attenuator function when listening to output from external unit. This prevents the noise when no external unit is connected to AUX terminal.
- OFF: Disables the selection of AUX source.
Set to OFF when not using the AUX terminal.

- 19 CD READ: "CD READ" > "1", "2"**
Sets the method for reading CD.
When unable to play special format CD, set this function to "2" to force playing. Note that some music CD may be unplayable even when set to "2".
In addition, audio files cannot be played when set to "2". Normally, keep this set to "1".

- 1: Automatically distinguishes between audio file disc and music CD when playing disc.
- 2: Forces playing as music CD.

- 20 Switching Preout¹: "SWITCH PRE" > "REAR", "SUB-W"**
Switches the preout between rear output ("REAR") and subwoofer output ("SUB-W").

- 21 Speaker Select: "SP SELECT" > "OFF", "5/4", "6*9/6", "OEM"**
Fine-tuning so that the System Q value is optimal when setting the speaker type as follows;

Speaker type	Display
OFF	"SP OFF"
For 5 & 4 in. speaker	"SP 5/4"
For 6 & 6x9 in. speaker	"SP 6*9/6"
For the OEM speaker	"SP OEM"

- 22 Firmware Upgrade: "F/W UP xx.xx" >**
Upgrades the firmware.
Selecting "YES" and then pressing [VOL] knob starts upgrading the firmware.



- For how to update the firmware, access our web site.
<http://www.kenwood.com/cs/ce/>

<DEMO MODE>

- 23 Demo Mode: "DEMO MODE" > "ON", "OFF"**
Specifies whether to enable demonstration.

Function Setting

<AUDIO CONTROL>

24 Subwoofer output¹: "SUB-W SET" > "ON"^{*}, "OFF"



- This setting can be made when "SUB-W" is selected for the <Switching Preout> item.

25 Bass Boost: "BASS BOOST" > "LV1"^{*}, "LV2", "OFF"

26 System Q: "SYSTEM Q" > "NATURAL"^{*}, "ROCK", "POPS", "EASY", "TOP 40", "JAZZ", "GAME", "USER"

Switches between the following preset equalizer curves;
Natural, Rock, Pops, Easy, Top 40, Jazz, Game, User setting



- "USER": This appears when Bass level, Middle level, and Treble level are adjusted. When the System Q setting is changed, the Bass, Middle, and Treble set replace the System Q values.

27 Bass level adjust: "BASS LEVEL" > "-8" - "+8"

28 Middle level adjust: "MID LEVEL" > "-8" - "+8"

29 Treble level adjust: "TRE LEVEL" > "-8" - "+8"



- 27 - 29**: Source tone memory: Puts the set up value in the memory per source.

30 Balance: "BALANCE" > "L 15" - "R 15"

31 Fader: "FADER" > "R 15" - "F 15"

32 Subwoofer level adjust: "SUB-W LEVEL" > "- 15" - "+ 15"

33 Subwoofer Low Pass Filter: "LPF SUB-W" > "85", "120", "160", "THROUGH"(OFF)^{*}

34 Subwoofer Phase: "PHASE" > "REV"(180°), "NORM"(0°)^{*}



- 32 - 34**: These adjustments can be made when "ON" is selected for the <Subwoofer output> item.
- 34**: This adjustment can be made when a setting other than "THROUGH" is selected for the <Subwoofer Low Pass Filter> item.

35 Supreme: "SUPREME" > "ON"^{*}, "OFF"

Technology to extrapolate and supplement with proprietary algorithm, the high-frequency range that is cut off when encoding at low bit rate (less than 128Kbps, Sampling frequency is 44.1kHz). Supplementing is optimized by compression format (MP3 or WMA) and processed according to bit rate.

The effect is negligible with music that is encoded at high bit rate, variable bit rate or has minimal high frequency range.

Can be set while Audio file source of CD.

36 Volume offset: "VOL OFFSET" > "- 8" - "+0"^{*}
(When in AUX source: "-8" - "+8")

Sets each source's volume as a difference from the basic volume.

<Function List>

Function items appearing during standby

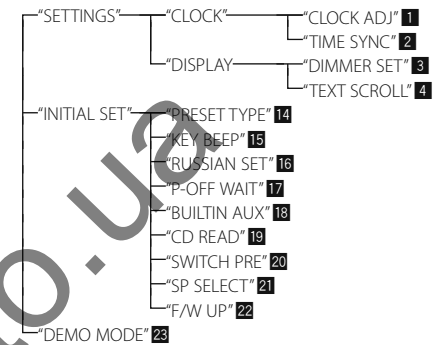

Function items appearing when the tuner source is selected

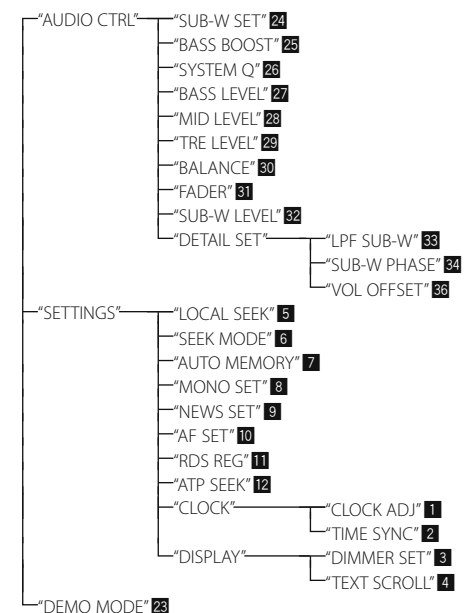

Function items appearing when the CD & audio file source is selected

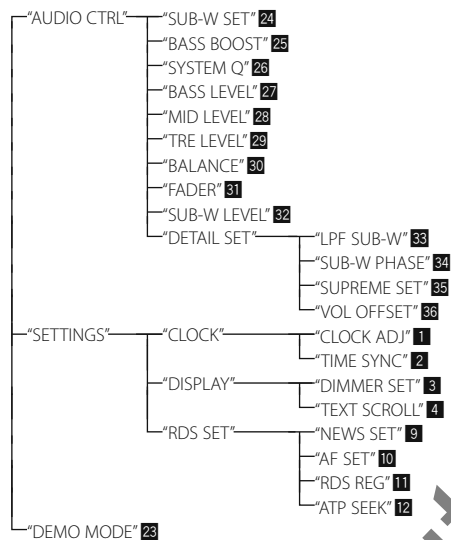

Function items appearing when an AUX source is selected

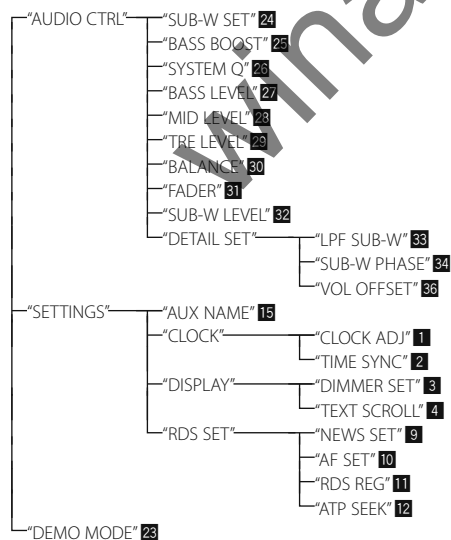

Music Disc/Audio File Operation

Play function

Repeat play

Press the [4] button.

Switches between Track Repeat ("TRAC REPEAT") and OFF ("REPEAT OFF") when pressed while playing a CD.

Switches between File Repeat ("FILE REPEAT"), Folder Repeat ("FOLD REPEAT"), and OFF ("REPEAT OFF") when pressed while playing an audio file.

Random play

Press the [3] button.

Randomly plays the music in the disc or folder. When Random Play is turned on, "DISC RANDOM"/"FOLD RANDOM" is displayed.

Pressing this button again cancels the Random play.

Scan play

Press the [2] button.

Successively plays the intro of the music in the disc or folder.

When Scan Play is turned on, "TRAC SCAN"/"FILE SCAN" is displayed.

Pressing this button again plays songs in the normal mode starting with the song being played now.

Music Search

Selecting the music you want to listen to from the device or media being played now.

1 Enter Music Search mode

Press the [Q] button.

"SEARCH" is displayed.

Displays the current Audio file name.

2 Search for music

Audio file

Operation type	Operation
Movement between folders/files	Turn the [VOL] knob.
Selection of folder/file	Press the [VOL] knob.
Return to previous folder	Press the [↶] button.
Return to root folder	Press the [BAND] button.

"<" or ">" beside the displayed folder name indicates that this folder is preceded or followed by another folder.

CD source

Operation type	Operation
Movement between track	Turn the [VOL] knob.
Selection of track	Press the [VOL] knob.
Return to first track	Press the [BAND] button before selecting a track.

Cancelling the Music Search mode

Press the [↶] button for at least 1 second.

Function of KDC-3347 with remote control

Direct Music Search

Searchs the music by entering the track number.

1 Enter Direct Music Search mode

Press the [DIRECT] button on the remote control.

"- - -" is displayed.

2 Enter the music number

Press the number buttons on the remote control.

3 Search the station

Press the [◀◀] or [▶▶] button.

Cancelling Direct Music Search

Press the [↶] button on the remote control.



- Direct Music Search cannot be performed during Random play or scan play.

Tuner Operation

PTY (Program Type)

Selecting the Program Type below and searching for a station;

Program Type	Display	Program Type	Display
Speech	"SPEECH"	Serious Classical	"CLASSICS"
Music	"MUSIC"	Other Music	"OTHER M"
News	"NEWS"	Weather	"WEATHER"
Current Affairs	"AFFAIRS"	Finance	"FINANCE"
Information	"INFO"	Children's programs	"CHILDREN"
Sport	"SPORT"	Social Affairs	"SOCIAL"
Education	"EDUCATE"	Religion	"RELIGION"
Drama	"DRAMA"	Phone In	"PHONE IN"
Culture	"CULTURE"	Travel	"TRAVEL"
Science	"SCIENCE"	Leisure	"LEISURE"
Varied	"VARIED"	Jazz Music	"JAZZ"
Pop Music	"POP M"	Country Music	"COUNTRY"
Rock Music	"ROCK M"	National Music	"NATION M"
Easy Listening	"EASY M"	Oldies Music	"OLDIES"
Music	"MUSIC"	Folk Music	"FOLK M"
Light Classical	"LIGHT M"	Documentary	"DOCUMENT"

- Speech and Music include the Program type shown below.
Music: Black character item.
Speech: White character item.

1 Enter PTY mode

Press the [Q] button.

2 Select the Program Type

Turn the [VOL] knob.

3 Search for the selected Program Type station

Press the [◀◀] or [▶▶] button.

4 Exit PTY mode

Press the [↶] button.



- This function cannot be used during a traffic bulletin or AM reception.
- When the selected Program Type is not found, "NO PTY" is displayed. Select another Program Type.

Program Type preset

Putting the Program Type in the Preset button memory and quick recall.

Presetting the Program Type

1 Select the Program Type to preset

Refer to <PTY (Program Type)> (page 13).

2 Preset the Program Type

Press the desired [1] — [6] button for at least 2 seconds.

Recalling the preset Program Type

1 Enter PTY mode

Refer to <PTY (Program Type)> (page 13).

2 Recall the Program Type

Press the desired [1] — [6] button.

Changing Language for PTY Function

Selecting the Program Type display language as follows;

Language	Display
English	"ENGLISH"
French	"FRENCH"
German	"GERMAN"

1 Enter PTY mode

Refer to <PTY (Program Type)> (page 13).

2 Enter Changing Language mode

Press the [Q] button.

3 Select the language

Turn the [VOL] knob.

4 Exit Changing Language mode

Press the [VOL] button.

Basic Operations of Remote Control

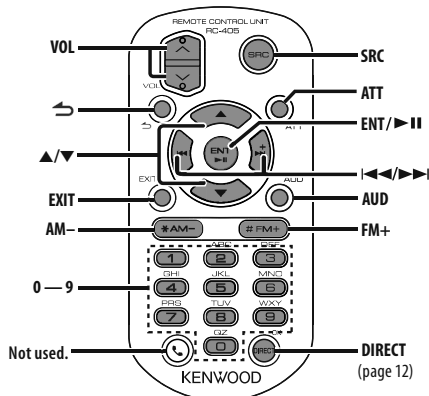

In CD/Audio File Source

Music select: [**◀◀**]/[**▶▶**]

Folder select: [**FM+**]/[**AM-**]

Pause/Play: [**||**]

Movement between folders/files: [**▲**]/[**▼**]

Return to previous folder: [**↶**]

Preparing the remote control unit

Pull the battery sheet out from the remote control unit to the direction of the arrow.

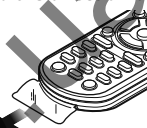

General Control

Volume control: [**VOL**]

Source select: [**SRC**]

Volume reduce: [**ATT**]

When the button is pressed again, the volume returns to the previous level.

Return to previous item: [**↶**]

Exit from mode: [**EXIT**]

Selection of item: [**▲**]/[**▼**]

Determination: [**ENT**]

Enter Audio Control mode: [**AUD**]

In Tuner Source

Band select: [**FM+**]/[**AM-**]

Station select: [**◀◀**]/[**▶▶**]

Recall preset stations: [**1**] — [**6**]

Changing the battery of the remote control unit

Use a commercially available button battery (CR2025). Insert something narrow like a paperclip into the hole 1 and pull out the battery tray.

Insert the battery with the + and - poles aligned properly, following the illustration inside the case.

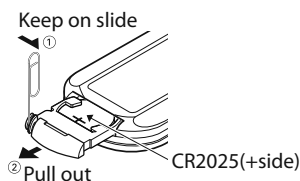

CAUTION

- Do not set the remote control in hot places such as on the dashboard.
- Lithium battery. Danger of explosion if the battery is incorrectly replaced. Replace only with the same or equivalent type.
- The battery pack or batteries shall not be exposed to excessive heat such as sunshine, fire or the like.
- Keep battery out of reach of children and in original package until ready to use. Dispose of used batteries promptly. If swallowed contact physician immediately.

Appendix

About Audio file

- **Playable Audio file**

MP3 (.mp3), WMA (.wma)

- **Playable disc media**

CD-R/RW/ROM

- **Playable disc file format**

ISO 9660 Level 1/2, Joliet, Romeo, Long file name.

Although the audio files are complied with the standards listed above, the play maybe impossible depending on the types or conditions of media.

- **Playing order of the Audio file**

In the example of folder/file tree shown below, the files are played in the order from ① to ⑩.

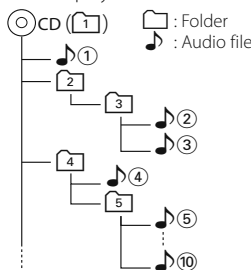

An online manual about audio files is put on the site, www.kenwood.com/cs/ce/audiofile/. On this online manual, detailed information and notes which are not written in this manual are provided. Make sure to read through the online manual as well.

This Product is not installed by the manufacturer of a vehicle on the production line, nor by the professional importer of a vehicle into an EU Member State.

Information on Disposal of Old Electrical and Electronic Equipment and Batteries (applicable for EU countries that have adopted separate waste collection systems)



Products and batteries with the symbol (crossed-out wheeled bin) cannot be disposed as household waste.

Old electrical and electronic equipment and batteries should be recycled at a facility capable of handling these items and their waste byproducts.



Contact your local authority for details in locating a recycle facility nearest to you. Proper recycling and waste disposal will help conserve resources whilst preventing detrimental effects on our health and the environment.

Notice: The sign "Pb" below the symbol for batteries indicates that this battery contains lead.

The marking of products using lasers (Except for some areas)

**CLASS 1
LASER PRODUCT**

The label is attached to the chassis/case and says that the component uses laser beams that have been classified as Class 1. It means that the unit is utilizing laser beams that are of a weaker class. There is no danger of hazardous radiation outside the unit.

Accessories/Installation Procedure

Accessories

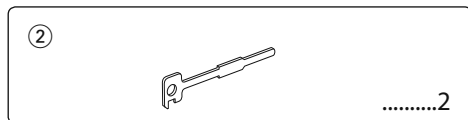
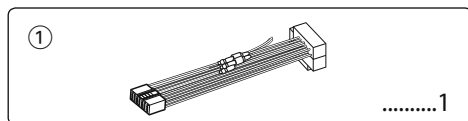

Installation Procedure

1. To prevent short circuits, remove the key from the ignition and disconnect the ⊖ terminal of the battery.
2. Make the proper input and output wire connections for each unit.
3. Connect the wire on the wiring harness.
4. Take Connector B on the wiring harness and connect it to the speaker connector in your vehicle.
5. Take Connector A on the wiring harness and connect it to the external power connector on your vehicle.
6. Connect the wiring harness connector to the unit.
7. Install the unit in your car.
8. Reconnect the ⊖ terminal of the battery.
9. Press the reset button.



- Mounting and wiring this product requires skills and experience. For safety's sake, leave the mounting and wiring work to professionals.
- Make sure to ground the unit to a negative 12V DC power supply.
- Do not install the unit in a spot exposed to direct sunlight or excessive heat or humidity. Also avoid places with too much dust or the possibility of water splashing.
- Do not use your own screws. Use only the screws provided. If you use the wrong screws, you could damage the unit.
- If the power is not turned ON ("PROTECT" is displayed), the speaker wire may have a short-circuit or touched the chassis of the vehicle and the protection function may have been activated. Therefore, the speaker wire should be checked.
- Make sure that all wire connections are securely made by inserting jacks until they lock completely.
- If your vehicle's ignition does not have an ACC position, or if the ignition wire is connected to a power source with constant voltage such as a battery wire, the power will not be linked with the ignition (i.e., it will not turn on and off along with the ignition). If you want to link the unit's power

with the ignition, connect the ignition wire to a power source that can be turned on and off with the ignition key.

- Use a commercially available conversion connector if the connector does not fit in the vehicle connector.
- Insulate unconnected wires with vinyl tape or other similar material. To prevent a short circuit, do not remove the caps on the ends of the unconnected wires or the terminals.
- If the console has a lid, make sure to install the unit so that the faceplate will not hit the lid when closing and opening.
- If the fuse blows, first make sure the wires aren't touching to cause a short circuit, then replace the old fuse with one with the same rating.
- Connect the speaker wires correctly to the terminals to which they correspond. The unit may be damaged or fail to work if you share the ⊖ wires or ground them to any metal part in the car.
- After the unit is installed, check whether the brake lamps, blinkers, wipers, etc. on the car are working properly.
- Mount the unit so that the mounting angle is 30° or less.

Connecting Wires to Terminals

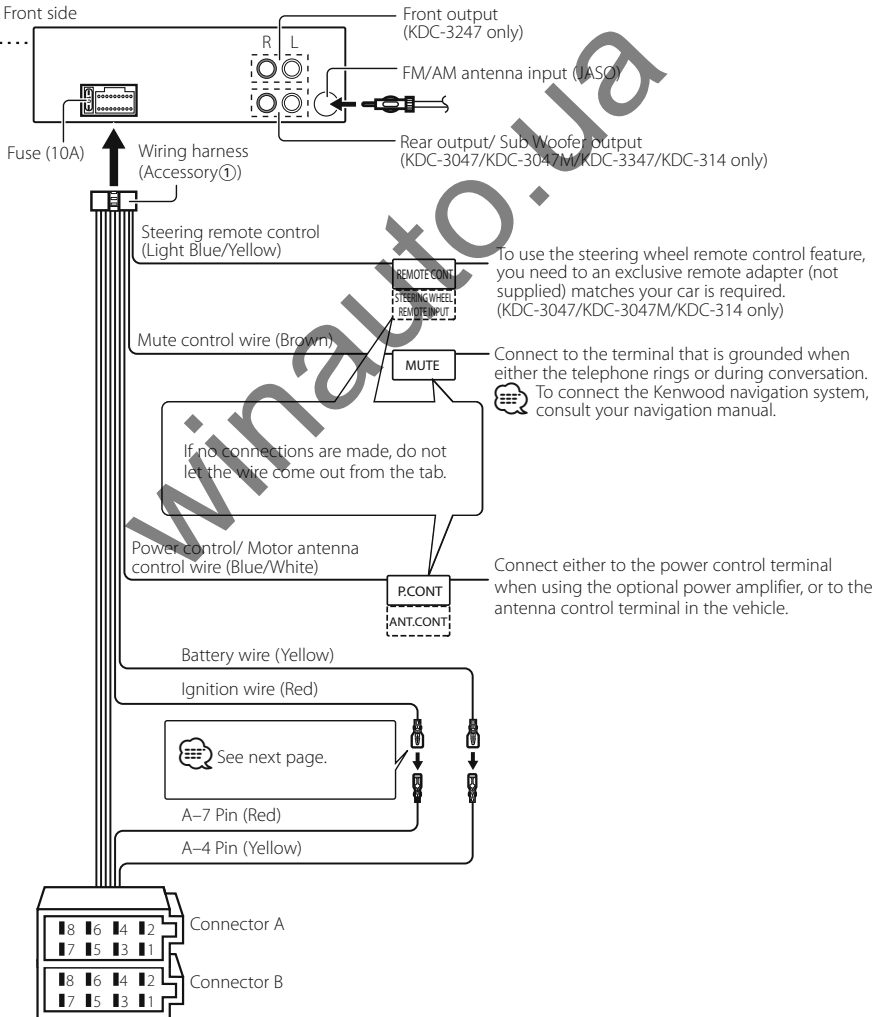
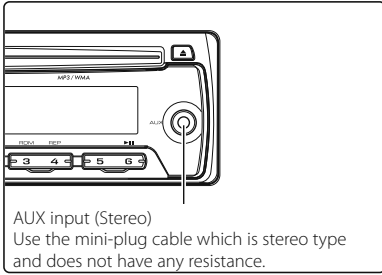

Connecting Wires to Terminals

Connector Function Guide

Pin Numbers for ISO Connectors	Cable Colour	Functions
External Power Connector		
A-4	Yellow	Battery
A-5	Blue/White	Power Control
A-7	Red	Ignition (ACC)
A-8	Black	Earth (Ground) Connection
Speaker Connector		
B-1	Purple	Rear Right (+)
B-2	Purple/Black	Rear Right (-)
B-3	Gray	Front Right (+)
B-4	Gray/Black	Front Right (-)
B-5	White	Front Left (+)
B-6	White/Black	Front Left (-)
B-7	Green	Rear Left (+)
B-8	Green/Black	Rear Left (-)

▲WARNING

Connecting the ISO Connector

The pin arrangement for the ISO connectors depends on the type of vehicle you drive. Make sure to make the proper connections to prevent damage to the unit.

The default connection for the wiring harness is described in **[1]** below. If the ISO connector pins are set as described in **[2]**, make the connection as illustrated.

Please be sure to reconnect the cable as shown **[2]** below to install this unit to the **Volkswagen** vehicles etc.

- [1]** (Default setting) The A-7 pin (red) of the vehicle's ISO connector is linked with the ignition, and the A-4 pin (yellow) is connected to the constant power supply.

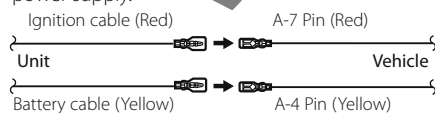

- [2]** The A-7 pin (red) of the vehicle's ISO connector is connected to the constant power supply, and the A-4 pin (yellow) is linked to the ignition.

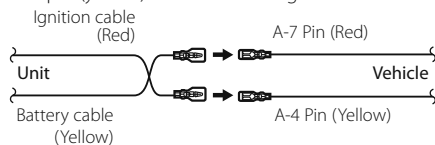

Installation/Removing the Unit

Installation

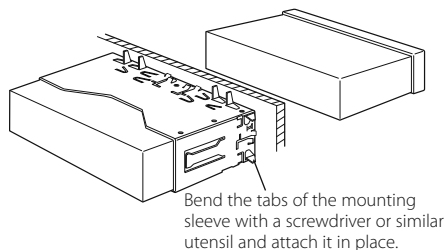

- Make sure that the unit is installed securely in place. If the unit is unstable, it may malfunction (for example, the sound may skip).

CAUTION

Install this unit in the console of your vehicle.
Do not touch the metal part of this unit during and shortly after the use of the unit. Metal part such as the heat sink and enclosure become hot.

Removing the Hard Rubber Frame

- 1 Engage the catch pins on the removal tool and remove the two locks on the upper level. Upper the frame and pull it forward as shown in the figure.

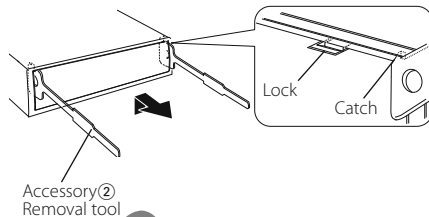

- 2 When the upper level is removed, remove the lower two locations.



- The frame can be removed from the bottom side in the same manner.

Removing the Unit

- 1 Refer to the section <Removing the Hard Rubber Frame> and then remove the hard rubber frame.
- 2 Detach the faceplate.
- 3 Insert the two removal tools deeply into the slots on each side, as shown.
- 4 Lower the removal tool toward the bottom, and pull out the unit halfway while pressing towards the inside.

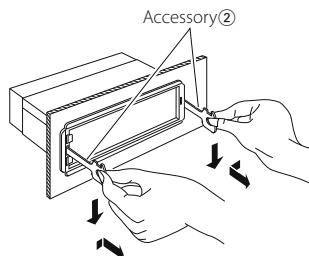

- Be careful to avoid injury from the catch pins on the removal tool.
- 5 Pull the unit all the way out with your hands, being careful not to drop it.



Troubleshooting Guide

Some functions of this unit may be disabled by some settings made on this unit.

- !** • **Cannot set up the subwoofer.**
- **Cannot set up the low pass filter.**
- **No output from the subwoofer.**
 - ▶ <Subwoofer output> of <Function Setting> (page 8) is not set to On.
 - Preout is not set to subwoofer.  "SWITCH PRE" of <Function Setting> (page 8)

- !** **Cannot set up the subwoofer Phase.**
 - ▶ Subwoofer Low Pass Filter is set to "THROUGH".  "LPF SUB-W" of <Function Setting> (page 8)

- !** **Power OFF Timer does not function.**
 - ▶ <Exit of the Demonstration Mode> (page 4) is not turned off.

- !** **Volume cannot be adjusted.**
 - ▶ The unit is set to Music Search mode.  Cancel the Music Search mode. (page 12)
 - The unit is set to Function Setting mode.  Cancel the Function Setting mode. (page 8)

What might seem to be a malfunction in your unit may just be the result of slight misoperation or miswiring. Before calling service, first check the following table for possible problems.

General

? The Touch Sensor Tone (beep sound) does not sound.

- ✓ The preout jack is being used.
 -  The Touch Sensor Tone cannot be output from the preout jack.



Tuner source

? Radio reception is poor.

- ✓ The car antenna is not extended.
 -  Pull the antenna out all the way.



Disc source

? The specified disc does not play, but another one plays instead.

- ✓ The specified CD is quite dirty.
 -  Clean the CD, referring to the CD cleaning of the section on <Handling CDs> (page 3).
- ✓ The disc is severely scratched.
 -  Try another disc instead.

Audio file source

? The sound skips when an Audio file is being played.

- ✓ The media is scratched or dirty.
 -  Clean the media, referring to the CD cleaning of the section on <Handling CDs> (page 3).
- ✓ The recording condition is bad.
 -  Record the media again or use another media.

The messages shown below display your systems condition.

- TOC ERROR: The CD is quite dirty. The CD is upside-down.
The CD is scratched a lot.
- ERROR 05: The disc is unreadable.
- ERROR 99: The unit is malfunctioning for some reason.
➔ Press the reset button on the unit. If the "ERROR 99" code does not disappear, consult your nearest service center.
- IN (Blink): The CD player section is not operating properly.
➔ Reinsert the CD. If the CD cannot be ejected or the display continues to flash even when the CD has been properly reinserted, please switch off the power and consult your nearest service center.
- PROTECT: The speaker wire has a short-circuit or touches the chassis of the vehicle, and then the protection function is activated.
➔ Wire or insulate the speaker cable properly and press the reset button. If the "PROTECT" code does not disappear, consult your nearest service center.
- NA FILE: An Audio file is played with a format that this unit can't support.
- COPY PRO: A copy-protected file is played.
- NO MUSIC/ERROR 15: Media was played that does not have data recorded that the unit can play.

winauto.ua

Specifications

FM tuner section

Frequency range (50 kHz space)
: 87.5 MHz – 108.0 MHz
Usable sensitivity (S/N = 26dB)
: 1 μ V/75 Ω
Quieting Sensitivity (S/N = 46dB)
: 2.5 μ V/75 Ω
Frequency response (\pm 3.0 dB)
: 30 Hz – 15 kHz
Signal to Noise ratio (MONO)
: 63 dB
Stereo separation (1 kHz)
: 40 dB

MW tuner section

Frequency range (9 kHz space)
: 531 kHz – 1611 kHz
Usable sensitivity (S/N = 20dB)
: 36 μ V

LW tuner section

Frequency range
: 153 kHz – 279 kHz
Usable sensitivity (S/N = 20dB)
: 57 μ V

CD player section

Laser diode
: GaAlAs
Digital filter (D/A)
: 8 Times Over Sampling
D/A Converter
: 24 Bit
Spindle speed
: 500 – 200 rpm (CLV)
Wow & Flutter
: Below Measurable Limit
Frequency response (\pm 1 dB)
: 20 Hz – 20 kHz
Total harmonic distortion (1 kHz)
: 0.01 %
Signal to Noise ratio (1 kHz)
: 105 dB
Dynamic range
: 93 dB
MP3 decode
: Compliant with MPEG-1/2 Audio Layer-3
WMA decode
: Compliant with Windows Media Audio

Audio section

Maximum output power
: 50 W x 4
Output power (DIN 45324, +B=14.4V)
: 22 W x 4
Speaker Impedance
: 4 – 8 Ω
Tone action
Bass : 100 Hz \pm 8 dB
Middle : 1 kHz \pm 8 dB
Treble : 10 kHz \pm 8 dB
Preout level / Load (CD) (KDC-3047/ KDC-3047GY/
KDC-3047M/ KDC-3347/ KDC-314)
: 2000 mV/10 k Ω
Preout impedance (KDC-3047/ KDC-3047GY/
KDC-3047M/ KDC-3347/ KDC-314)
: \leq 600 Ω

Auxiliary input

Frequency response (\pm 3 dB)
: 20 Hz – 20 kHz
Input Maximum Voltage
: 1200 mV
Input Impedance
: 10 k Ω

General

Operating voltage (11 – 16V allowable)
: 14.4 V
Maximum Current consumption
: 10 A
Installation Size (W x H x D)
: 182 x 53 x 155 mm
Weight
: 1.3 kg

Specifications subject to change without notice.

winauto.ua

winauto.ua



This symbol mark indicates that Kenwood manufactured this product so as to decrease harmful influence on the environment.

KENWOOD