

# KEURIG<sup>®</sup> HOT

USE & CARE GUIDE

2.0 **K500 PLUS** Series

SINGLE SERVE **PLUS** COFFEE MAKER



## IMPORTANT SAFEGUARDS

When using electrical appliances, basic safety precautions should be followed, including the following:

1. Read all instructions before using.
2. Do not touch hot surfaces. Use handles and knobs when available.
3. This appliance must be properly installed and located in accordance with these instructions before it is used.
4. The use of accessory attachments not recommended by the appliance manufacturer may result in fire, electrical shock, or injury to persons.
5. Do not place on or near a hot gas or electric burner, or in a heated oven.
6. Do not use outdoors.
7. To protect against fire, electric shock, and injury do not immerse cords, plugs, or the appliance in water or any other liquid.
8. Do not fill the Water Reservoir above the MAX FILL line.
9. **Use only water in this appliance!** Do not put any other liquids or foods in the Water Reservoir except as instructed in the cleaning instructions in this guide.
10. Turn off and unplug the brewer before cleaning or maintenance. Allow to cool before putting on or taking off parts and before cleaning the appliance.
11. For best operation, plug the appliance into its own electrical outlet on a dedicated circuit to prevent flickering of lights, blowing of fuses, or tripping a circuit breaker.
12. Do not operate any appliance with a damaged Power Cord or plug, or after the appliance malfunctions or is damaged in any manner. Contact Keurig Customer Service to report any malfunction of or damage to the brewer.
13. Do not let the Power Cord hang over the edge of the table or counter, or touch hot surfaces.
14. To disconnect, press the Power Button on the brewer to "OFF" status and then remove the plug from the wall outlet.
15. Close supervision is necessary when any appliance is used by or near children.
16. **Do not lift the brewer Handle while brewing is in progress.**
17. Always keep the Flip-Top Reservoir Lid on the Water Reservoir unless you are refilling it.
18. This appliance is equipped with a Power Cord that has a grounding wire with a grounding plug. The appliance must be grounded using a 3-hole properly grounded outlet. In the event of an electrical short circuit, grounding reduces the risk of electrical shock.
19. If the outlet is a standard 2-prong wall outlet, it is your personal responsibility and obligation to have it replaced with a properly grounded 3-prong wall outlet.
20. Do not, under any circumstances, cut or remove the third (ground) prong from the Power Cord or use an adapter.
21. Consult a qualified electrician if the grounding instructions are not completely understood, or if doubt exists as to whether the appliance is properly grounded.
22. Do not use the appliance for other than its intended use.
23. Remove the shipping disk before brewing.

2

## SAVE THESE INSTRUCTIONS.

### WARNING TO USERS AND PARENTS:

1. **DO NOT** permit children to use the brewer unless there is adult supervision. Brewer dispenses very hot water.
2. **SPECIAL NOTICE FOR HOT COCOA/OTHER USERS: IMMEDIATELY AFTER USING A HOT COCOA/OTHER POD, RUN A HOT WATER BREW CYCLE** without a pod to avoid the possibility of clogging the exit needle. **DO NOT** assume the next user will do this.

### WARNING

RISK OF FIRE OR  
ELECTRIC SHOCK  
DO NOT OPEN



WARNING: TO REDUCE THE RISK OF FIRE OR ELECTRIC SHOCK, DO NOT REMOVE THE BOTTOM COVER. NO USER SERVICEABLE PARTS ARE INSIDE. REPAIR SHOULD BE DONE BY AUTHORIZED SERVICE PERSONNEL ONLY.

3

**CAUTION:** There are three sharp needles that puncture pods, two above the Pod Holder and the other in the bottom of the Pod Holder. To avoid risk of injury, do not put your fingers in the Pod Holder Assembly.

**CAUTION:** There is extremely hot water in the Pod Holder during the brew process. To avoid risk of injury, do not lift the Handle or open the Pod Holder Assembly during the brewing process.

**CAUTION:** Do not fill above the MAX FILL line. If you fill the Water Reservoir above this point, you may occasionally get a larger brew than you selected for your first brew of the day. If you prefer to have your Water Reservoir filled to the top, we recommend you use a large mug for your first brew of the day to avoid any risk of overflow.

**CAUTION:** Please always keep the brewer in its upright position to avoid potential injury and/or damage to your brewer.

**CAUTION:** Very hot liquid. Adult supervision required.

**SHORT CORD INSTRUCTIONS:**

A short power supply cord is provided to reduce the risk of becoming entangled in or tripping over a longer cord. Longer detachable power-supply cords or extension cords are available and may be used if care is exercised in

their use. If an extension cord is used, (1) the marked electrical rating of the cord set or extension cord should be at least as great as the electrical rating of the appliance; (2) the cord should be arranged so that it will not drape over the countertop or tabletop where it can be pulled on by children or tripped over unintentionally; and (3) the extension cord must include a 3-prong grounding plug.

Your Keurig® Plus Series brewer will not work with pods that do not have the Keurig® logo on them.

Keurig® Plus Series brewers are not compatible with the My K-Cup® reusable filter accessory.

**THIS PRODUCT IS FOR HOUSEHOLD USE ONLY.**

## **WARNING**

**THIS PRODUCT CONTAINS CHEMICALS, INCLUDING LEAD, WHICH IS KNOWN TO THE STATE OF CALIFORNIA TO CAUSE CANCER, BIRTH DEFECTS OR OTHER REPRODUCTIVE HARM.**

## **USER GUIDE TABLE OF CONTENTS**

### **KEURIG® PLUS SERIES BREWING SYSTEM | 500 SERIES**

Features	6
Touch-Screen Controls	7
Quick Tips & To Dos	8
<b>1 Let's Get Brewing</b>	<b>9</b>
Set-Up	10
Cleansing Brew	11
Brew Your First K-Cup® Pod	12
Brew Your First K-Carafe® Pod	13
Set Carafe Auto Brew Mode	14
<b>2 Tips and Maintenance</b>	<b>15</b>
Stopping the Brew Process	16
Adding Water	16
Dispensing Hot Water into a Mug	17
Settings Menu	18
Caring For Your Brewer	27
Recycling K-Mug™ and K-Carafe® Pods	39
<b>3 Troubleshooting</b>	<b>40</b>
<b>4 Warranty</b>	<b>42</b>

## FEATURES



### K500 SERIES BREWER

- |                              |                    |  |
|------------------------------|--------------------|--|
| A. Flip-Top Reservoir Lid    | F. Handle          | K. Pod Holder                                    |
| B. Water Reservoir           | G. Brew Head       | L. Housing (K and L are the Pod Holder Assembly) |
| C. Top Housing               | H. Power Cord      | M. Base  |
| D. Touch-screen/Power Button | I. Drip Tray Plate |  |
| E. Brew Button               | J. Drip Tray       |  |

6

## TOUCH-SCREEN CONTROLS

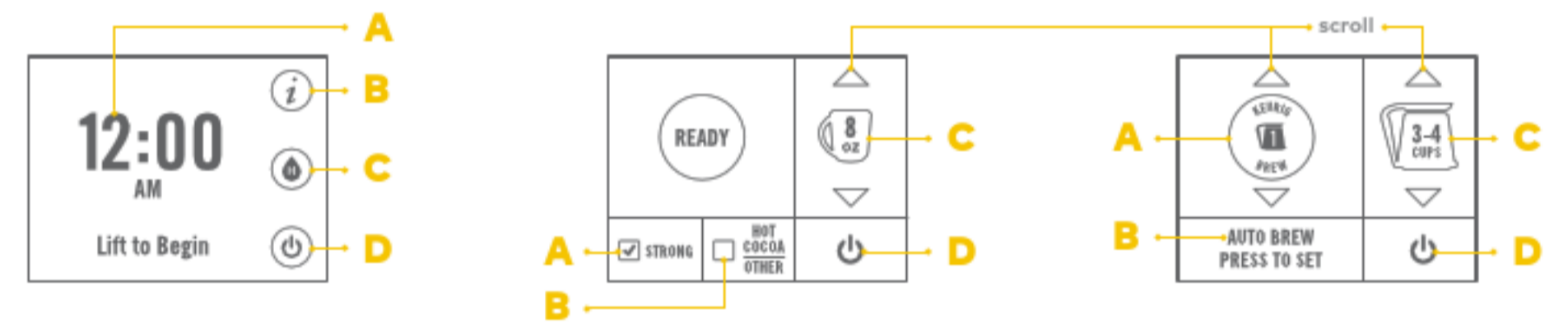

### HOME SCREEN

- A. Clock
- B. Settings Button
- C. Hot Water Button
- D. Power Button

### SCREEN FOR K-CUP® PODS

- A. STRONG  
(only available for coffee)
- B. HOT COCOA/OTHER  
(for select non-coffee beverages)
- C. Brew Size
- D. Power Button

### SCREEN FOR K-CARAFE® PODS

- A. KEURIG® BREW Setting 1
- B. AUTO BREW  
(only available for K-Carafe® pods)
- C. Brew Size
- D. Power Button

## BREW SETTINGS (OUTLINE INDICATES DEFAULT SIZE)

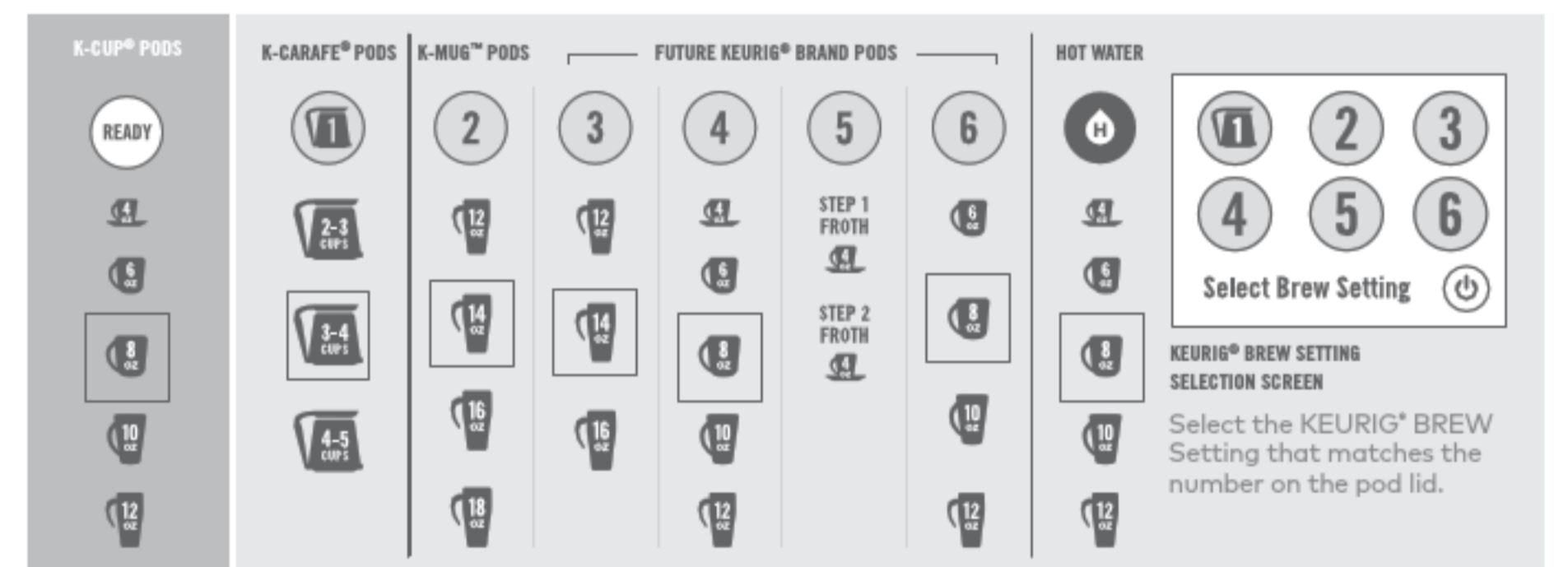

7

## QUICK TIPS & TO DOS

### QUICK TIPS

- ✓ With your Keurig® Plus Series brewer, you can brew a single cup or a full carafe.
- ✓ **Be sure to use Keurig® brand pods:** Your Keurig® Plus Series brewer is able to brew over 500 varieties of coffee, tea, and hot cocoa, plus seasonal and café-style beverages.

### TO DO

- ✓ Register your brewer at [Keurig.com](http://Keurig.com). We'll send you a special "thank you" when you do. Subject to availability and assortment/count will vary.
- ✓ Join Club Keurig™ for special savings on Keurig® brand pods when purchased on [Keurig.com](http://Keurig.com)

## SETUP

### SET-UP

1. Place the brewer on a counter and plug into a grounded outlet.



2. Lift the Handle, remove and discard the shipping disk.



3. Rinse the Water Reservoir, fill with bottled or filtered water, and return it to the brewer.



4. Press the Power Button and wait for preheating to complete, about three minutes.

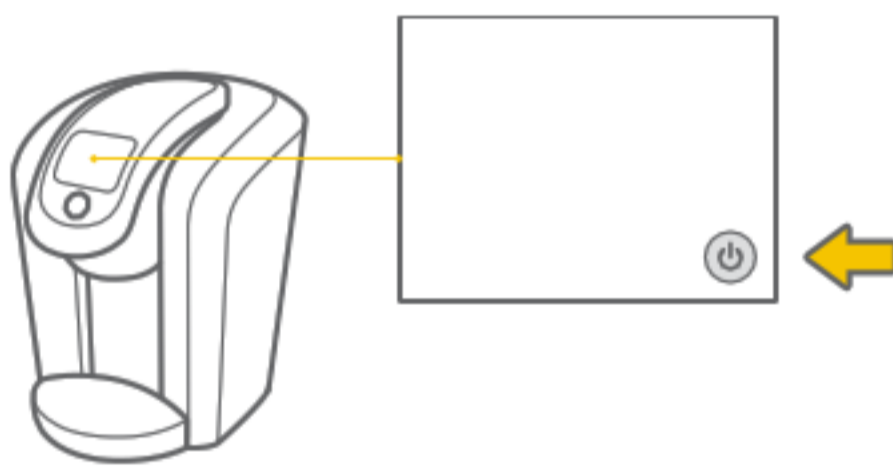

10

## CLEANSING BREW

### CLEANSING BREW

1. To begin a cleansing brew, place a 12 ounce mug on the Drip Tray.



2. Lift and lower the Handle. Do not place a Keurig® brand pod in the Pod Holder.

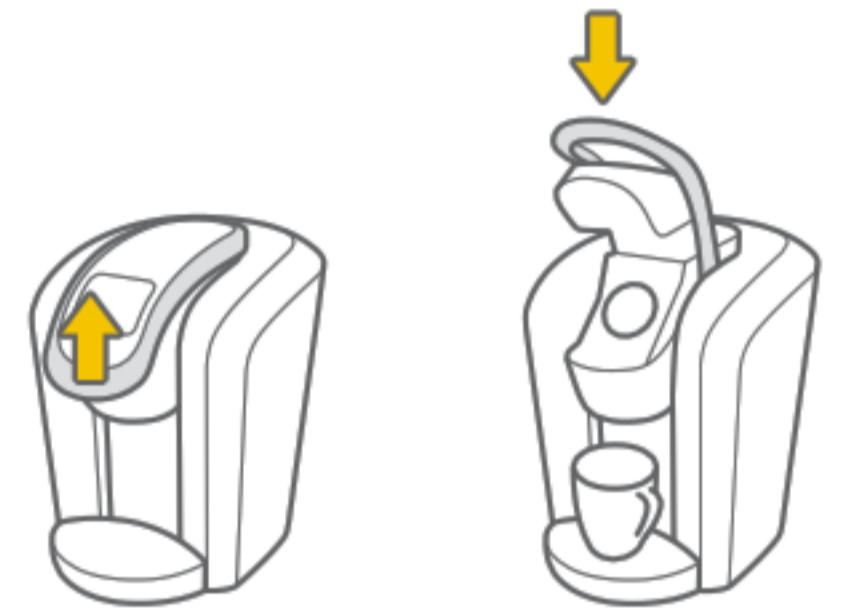

3. Press CONTINUE to dispense hot water. Select an 8 ounce Brew Size and press the Brew Button.

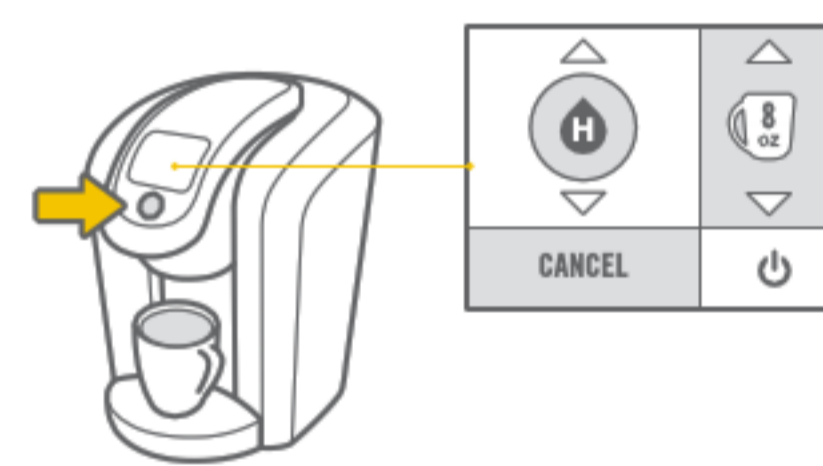

4. You are now ready to use your brewer!



11

1 | LET'S GET BREWING!

## BREW YOUR FIRST K-CUP® POD

- Place a mug on the Drip Tray. Select a K-Cup® pod, place firmly in the Pod Holder.

NOTE: Do not remove the foil lid or puncture the K-Cup® pod.

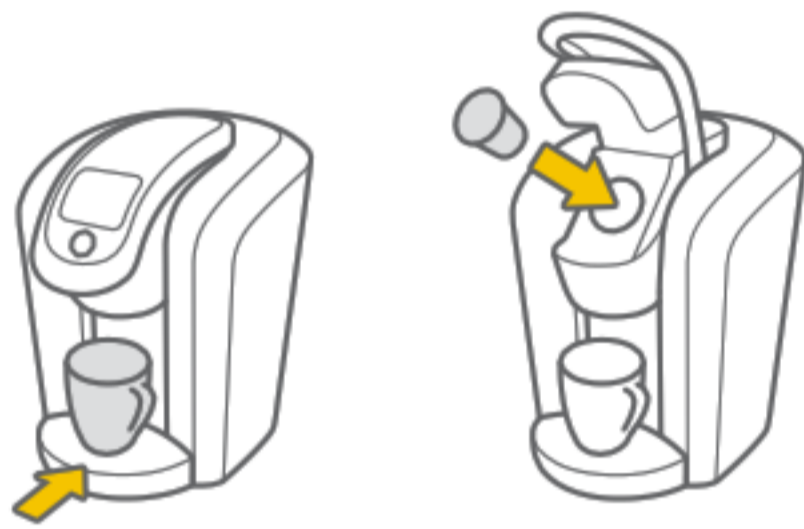

- Lower the Handle.

CAUTION: There are sharp needles that puncture the K-Cup® pod above and below the Pod Holder. To avoid injury, do not put your fingers in the Pod Holder.



- Select a Brew Size. Select STRONG if desired. (STRONG setting is for coffee.)



Press HOT COCOA/OTHER for select non-coffee beverages.

NOTE: Make sure to check instructions on pod packaging.



- Press the Brew Button and enjoy your first cup!

CAUTION: There is extremely hot water in the K-Cup® pod during the brew process. To avoid injury, do not lift the Handle during the brew process.



12

## BREW YOUR FIRST K-CARAFE® POD

1 | LET'S GET BREWING!

- Make sure the Keurig® Carafe is empty. Remove the Drip Tray and insert the Keurig® Carafe securely in its place.

NOTE: Do not remove the foil lid or puncture the K-Carafe® pod.

NOTE: Refer to page 33 for Keurig® Carafe operation.

**Carafe Sold Separately**  
Brewer only works with Keurig® Carafes. To purchase a Keurig® Carafe please visit [Keurig.com](http://Keurig.com)



- Select a K-Carafe® pod, place firmly in the Pod Holder and lower the Handle.

CAUTION: There are sharp needles that puncture the K-Carafe® pod above and below the Pod Holder. To avoid injury, do not put your fingers in the Pod Holder.

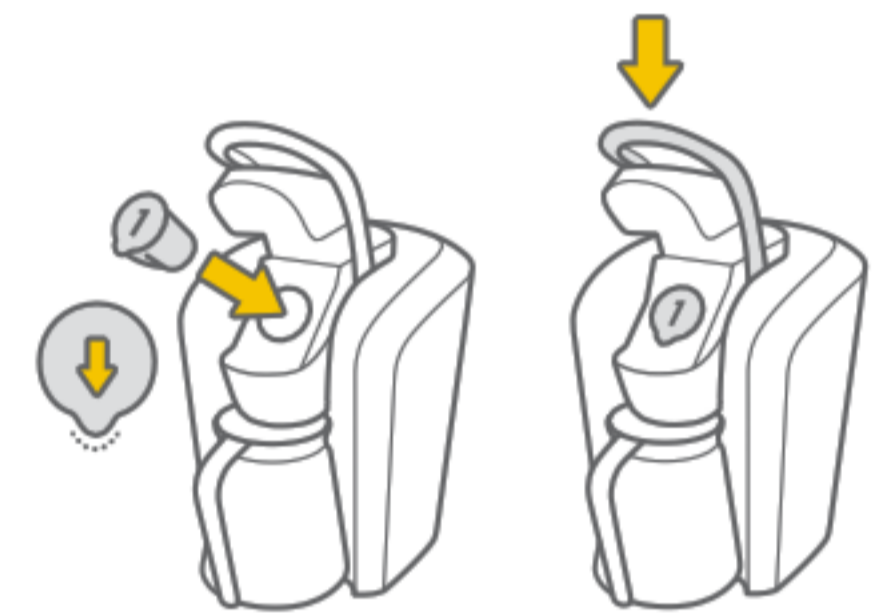

- Select a Brew Size.

NOTE: Make sure the number on the Touch-screen matches the number of the K-Carafe® pod you're brewing in the Pod Holder.

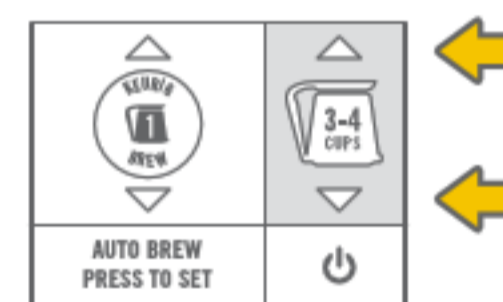

- Press the Brew Button and enjoy your first carafe of coffee!

CAUTION: There is extremely hot water in the K-Carafe® pod during the brew process. To avoid injury, do not lift the Handle during the brew process.



13

1. Make sure the Keurig® Carafe is empty. Remove the Drip Tray and insert the Keurig® Carafe securely in its place.



2. Select a K-Carafe® pod, place firmly in the Pod Holder and lower the Handle.   
 NOTE: Ensure the current time is accurate. Refer to page 19 to adjust.

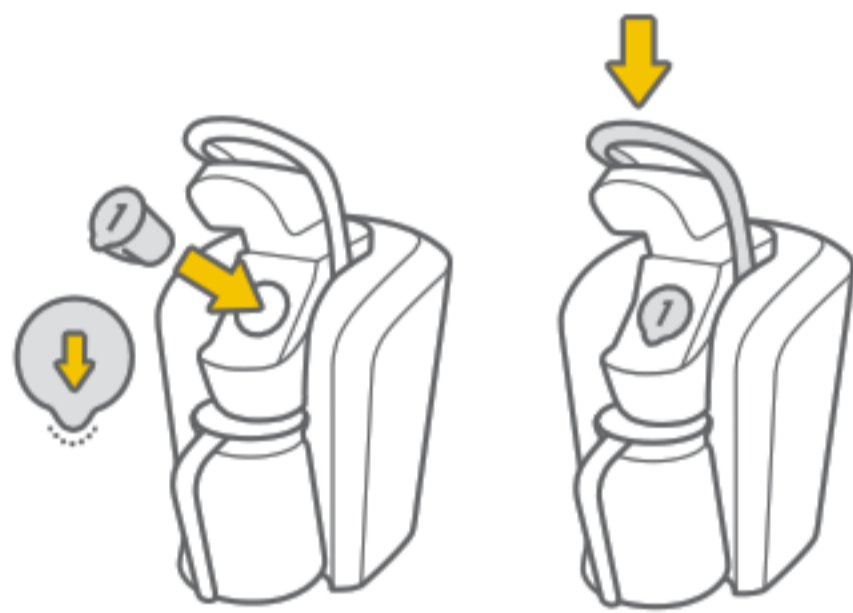

5. Select a Brew Size, then press SET.

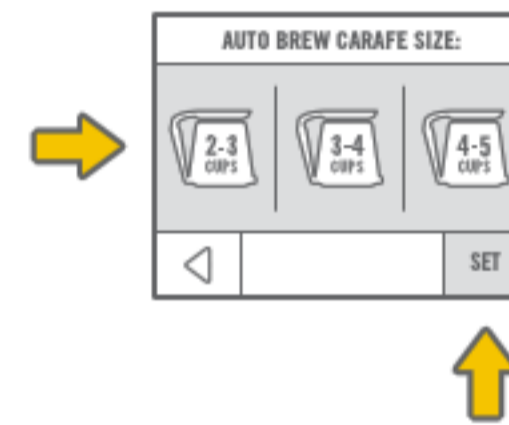

6. The Touch-screen will indicate DO NOT DISTURB!



3. Select AUTO BREW PRESS TO SET.



4. Select the time you want to begin brewing, then press the right arrow.

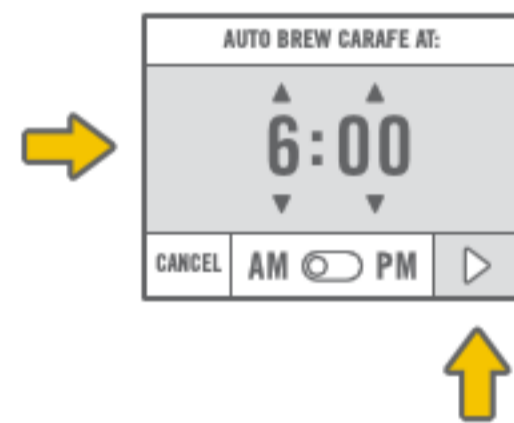

7. To edit any options, select TOUCH HERE TO EDIT.



8. To put the brewer in sleep mode, quickly press and release the Power Button. Removing the Keurig® Carafe or lifting the Handle will cancel the CARAFE AUTO BREW MODE.





## STOPPING THE BREW PROCESS

### FOR K-CUP®, K-MUG™, AND K-CARAFE® PODS

To stop the brewing process, press and hold the Power Button for one second or slowly lift the Handle. Remove and dispose of any used pod. Brewing a used pod is not recommended.



## ADDING WATER

Your Keurig® Plus Series brewer will indicate when the water level in the Water Reservoir is low and you will not be able to brew. The brewer will only indicate "More Water Please." if there is not enough to complete your brew.

For example: A Keurig® Carafe will require more water than a 10 ounce mug.

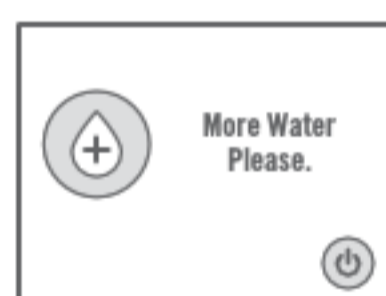

16

## DISPENSING HOT WATER INTO A MUG

## 2 | TIPS & MAINTENANCE

1. Press the Hot Water Button.



2. Follow the Touch-screen instructions.



3. Select your Brew Size and press the Brew Button.



4. When the brew process is complete, the Touch-screen will indicate Enjoy!



17

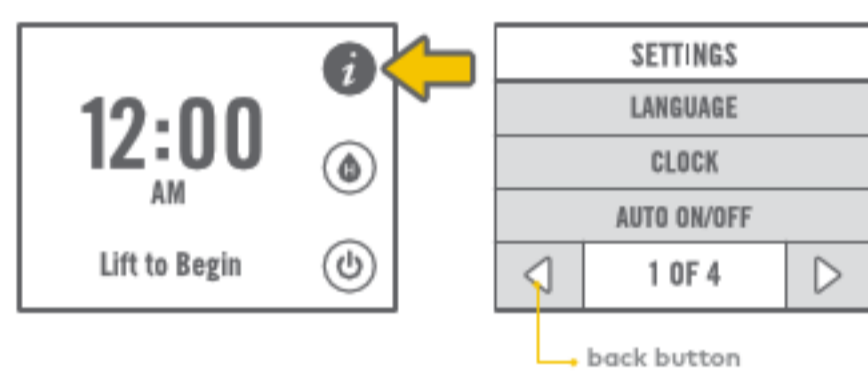

**ACCESS SETTINGS**

Explore everything your Keurig® Plus Series brewer has to offer by accessing the SETTINGS menu. From the home screen, select the Settings button.

Use the arrows to scroll through the menu. To exit, press the back button.

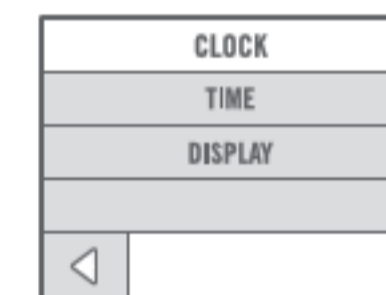
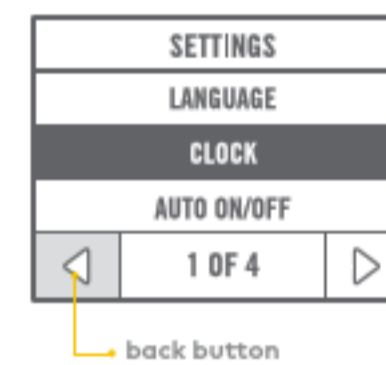

**SET CLOCK**

The CLOCK menu gives you the following three settings.

Use the back button to return to the SETTINGS menu.

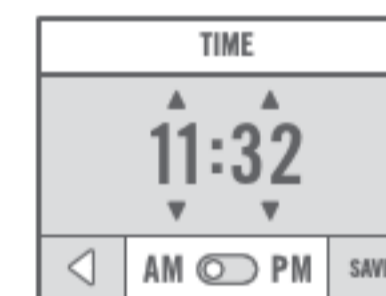

**Time:** Set the current time using the arrows, then choose AM or PM.

Press SAVE to confirm or use the back button to return to the SETTINGS menu.

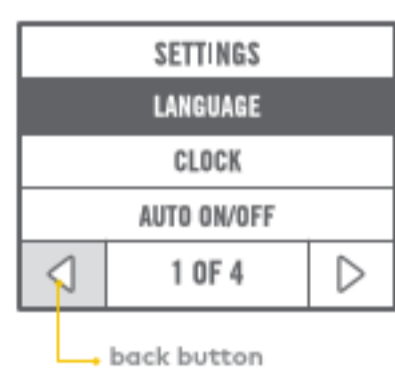

**CHOOSE LANGUAGE**

Press English, Spanish, or French to select the LANGUAGE.

Press SAVE to confirm or use the back button to return to the SETTINGS menu.



**Display:** Choose DIGITAL or ANALOG DISPLAY. For DIGITAL DISPLAY only, use the toggle to select 12 HR or 24 HR (military).

Press SAVE to confirm or use the back button to return to the SETTINGS menu.

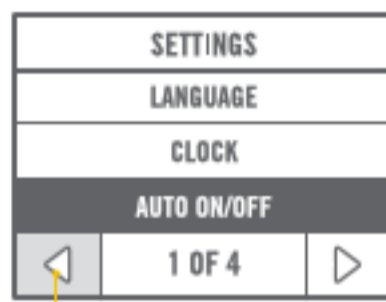

back button

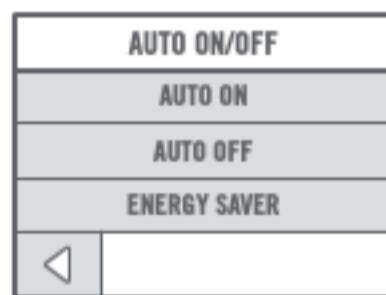

**ENABLE AUTO ON/OFF**

You can leave your brewer on at all times so it's ready to make your perfect cup any time of day, or you can set the AUTO ON, AUTO OFF, or ENERGY SAVER mode.

Use the back button to return to the SETTINGS menu.



**Auto On:** Select ENABLE to activate AUTO ON. Use the arrows to set the time for the brewer to automatically turn on.

Press SAVE to confirm or use the back button to return to the SETTINGS menu.



**Auto Off:** Select ENABLE to activate AUTO OFF. Use the arrows to set the time for the brewer to automatically turn off.

Press SAVE to confirm or use the back button to return to the SETTINGS menu.



**Energy Saver:** Select ENABLE to activate ENERGY SAVER mode. In increments of 15 minutes, set the brewer to turn off after a set length of time after the last brew.

Press SAVE to confirm or use the back button to return to the SETTINGS menu.

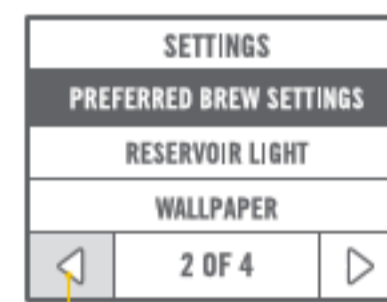

back button

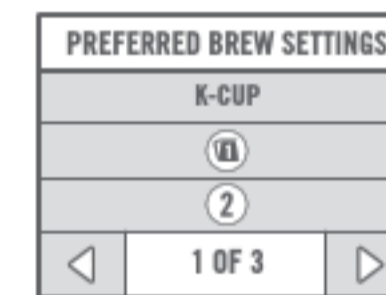

**PREFERRED BREW SETTINGS**

The PREFERRED BREW SETTINGS menu allows you to change the default settings for each Keurig Brew number.

Use the back button to return to the SETTINGS menu.

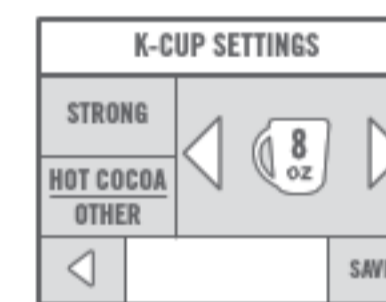

**K-Cup® Settings:** Adjust the brew size, enable STRONG or HOT COCOA/OTHER.

Press SAVE to confirm or use the back button to return to the SETTINGS menu.

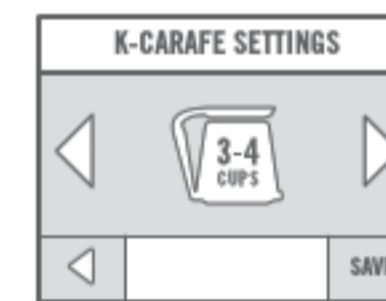

**K-Carafe® Settings:** Adjust your preferred size for brewing a carafe.

Press SAVE to confirm or use the back button to return to the SETTINGS menu.



**K-Mug™ Settings:** Adjust brew size and enable STRONG.

Press SAVE to confirm or use the back button to return to the SETTINGS menu.

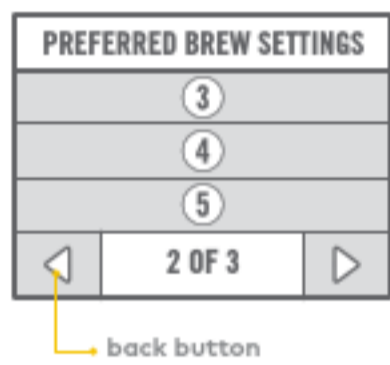

back button



**Keurig Brew #3:** Adjust brew size.  
Press SAVE to confirm or use the back button to return to the SETTINGS menu.



**Keurig Brew #4:** Adjust brew size and enable STRONG.  
Press SAVE to confirm or use the back button to return to the SETTINGS menu.



**Keurig Brew #5:** Enable/disable STRONG for brewing 2-STEP beverages.  
Press SAVE to confirm or use the back button to return to the SETTINGS menu.

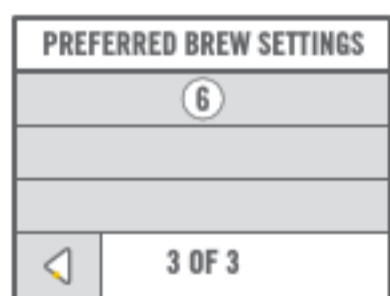

**Keurig Brew #6:** Adjust brew size.  
Press SAVE to confirm or use the back button to return to the SETTINGS menu.

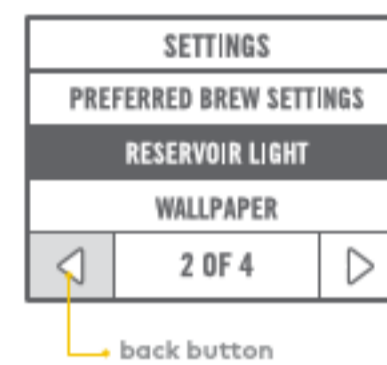

back button

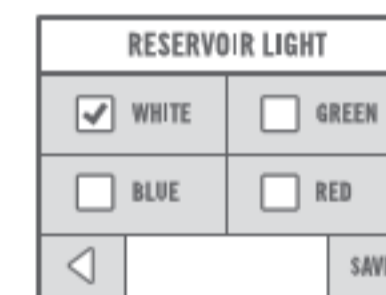

**WATER RESERVOIR LIGHT**  
Choose white, green, blue, or red.  
Use the back button to return to the SETTINGS menu.

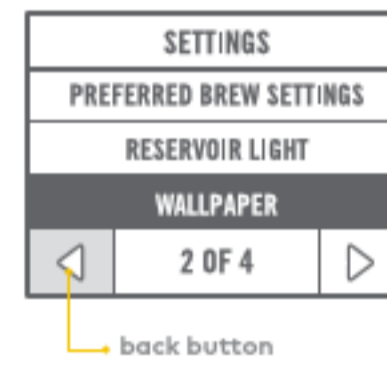

back button

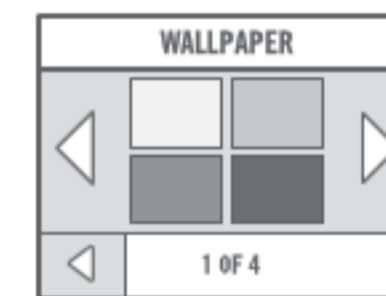

**WALLPAPER**  
You can customize your Touch-screen color. Simply press a color window to select a WALLPAPER for the home screen.

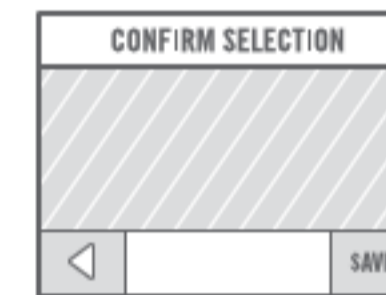

**Confirm Selection:** Press SAVE to CONFIRM SELECTION or use the back button to return to the WALLPAPER menu.

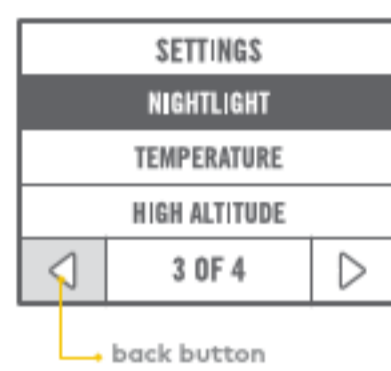

**NIGHTLIGHT**

Everything looks better in the right light. Choose the color of your home screen and set ON and OFF times to provide a warm glow in your kitchen at night.

Use the back button to return to the SETTINGS menu.

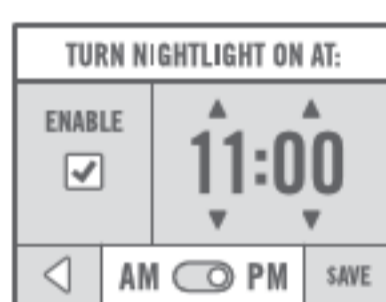

**Nightlight On:** Select ENABLE to activate the nightlight timer. Use the arrows to set the time for the home screen to change color.

Press SAVE to confirm or use the back button to return to the SETTINGS menu.



**Nightlight Off:** Select ENABLE to activate the nightlight timer. Use the arrows to set the time for the home screen to change color.

Press SAVE to confirm or use the back button to return to the SETTINGS menu.



**Nightlight Color:** Choose white, green, blue, or red.

Press SAVE to confirm or use the back button to return to the SETTINGS menu.

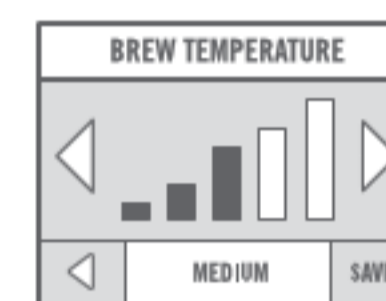
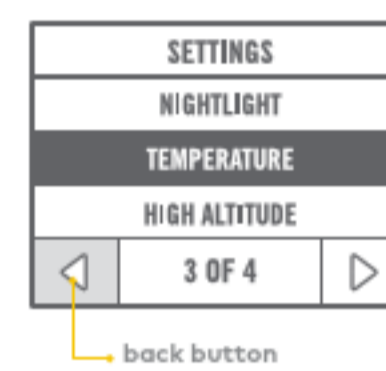

**TEMPERATURE**

The TEMPERATURE setting provides even more control over the brewing process.

Use the left and right arrows to choose from LOW, LOW/MEDIUM, MEDIUM, MEDIUM/HIGH, and HIGH.

Use the back button to return to the SETTINGS menu.

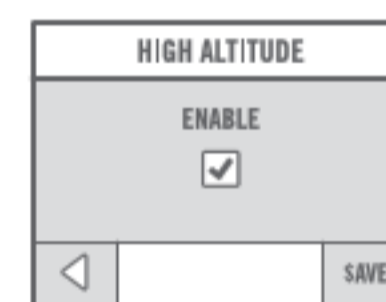
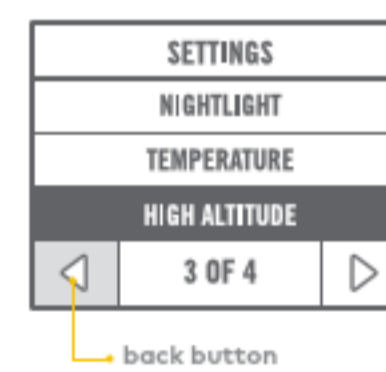

**ENABLE HIGH ALTITUDE**

To ensure your brewer works properly at higher altitudes (5,000 feet), ENABLE the HIGH ALTITUDE mode.

Press SAVE to confirm or use the back button to return to the SETTINGS menu.

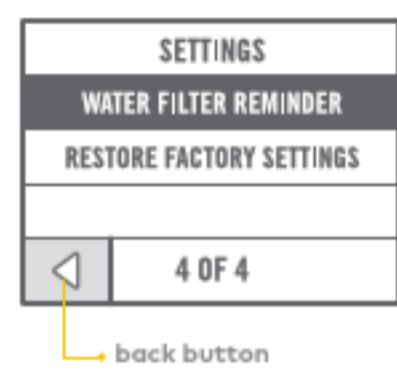

**ENABLE WATER FILTER REMINDER**

If you are using a Keurig™ Water Filter, select **ENABLE** to activate the **WATER FILTER REMINDER** notices.

Press **SAVE** to confirm or use the back button to return to the **SETTINGS** menu.

Refer to page 34 for more information.

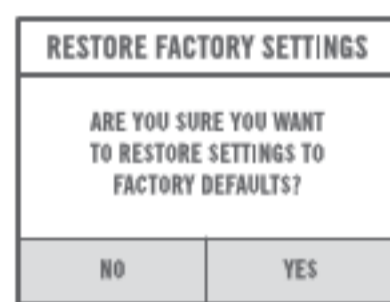
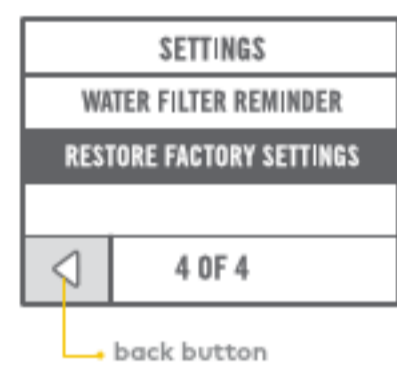

**RESTORE FACTORY SETTINGS**

Press **YES** to restore your brewer to the default settings.

Restoring defaults erases **PREFERRED BREW SETTINGS**, **TEMPERATURE**, **WALLPAPER**, **AUTO ON/OFF**, and **NIGHTLIGHT** settings.

The clock will be set to 12:00 AM.

Press **NO** to return to the **SETTINGS** menu.



**CLEANING THE BREWER EXTERIOR**

Keep your Keurig® Plus Series brewer looking its best by cleaning the exterior from time to time. Just clean with a damp, soapy, lint-free, non-abrasive cloth. Never immerse the brewer in water or other liquids.



**CLEANING THE DRIP TRAY**

The Drip Tray can accumulate up to 8 ounces of overflow. The Drip Tray and the Drip Tray Plate should occasionally be rinsed clean. To remove the Drip Tray, simply slide it toward you, keeping it level at all times to avoid spilling. Clean with a damp, soapy, lint-free, non-abrasive cloth.

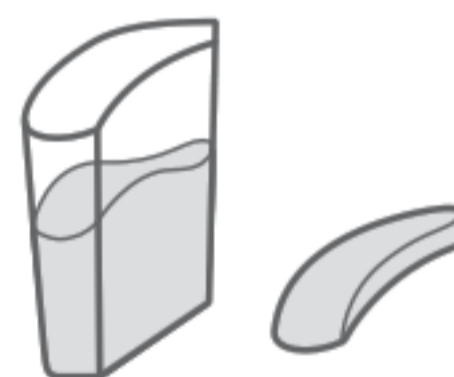

**CLEANING THE WATER RESERVOIR AND THE FLIP-TOP RESERVOIR LID**

Clean the Water Reservoir and the Flip-Top Reservoir Lid with a damp, soapy, lint-free, non-abrasive cloth and rinse thoroughly.

Do not dry the inside of the Water Reservoir with a cloth as lint may remain. Be sure to rinse the Water Reservoir thoroughly after cleaning to ensure that no cleaning solutions remain as they may contaminate the water supply in the brewer.

**DO NOT PLACE THESE ITEMS IN THE DISHWASHER.**

**CLEANING THE POD HOLDER**

1. Lift the Handle.

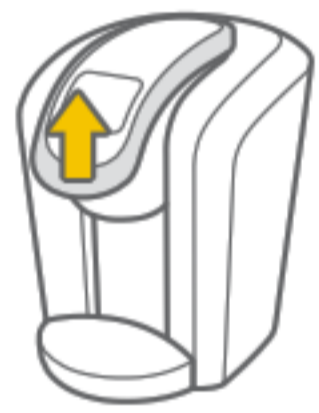

2. Push up while grabbing the sides of the Pod Holder Assembly. Pull away from the brewer.

**CAUTION:** Sharp needles. Do not put fingers in chamber.



3. Pull out the Pod Holder Assembly (1) and Base (2).



4. Press the release buttons on both sides of the Pod Holder Assembly.



5. Separate the Pod Holder from the Housing.

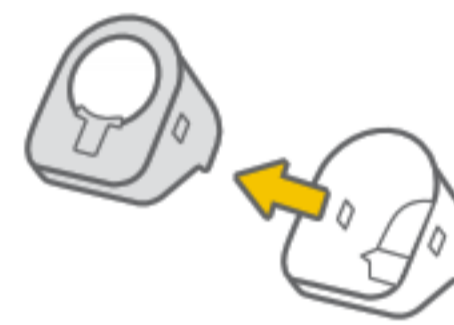

6. Clean the Pod Holder (1), Housing (2), and Base (3) with a damp, soapy, lint-free, non-abrasive cloth and rinse thoroughly.



8. After all pieces are cleaned, reassemble the Pod Holder Assembly by inserting the Pod Holder back into the Housing.

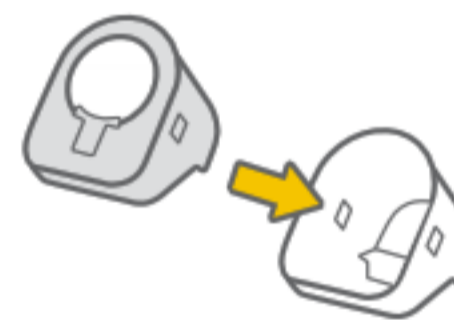

8. Place the Base, then the Pod Holder Assembly into the Brew Head. Lower the Handle.

**CAUTION:** Sharp needles. Do not put fingers in chamber.



**CLEANING THE BREWER ENTRANCE NEEDLE**

Having trouble brewing? You may have coffee grounds stuck in the brewer's Entrance Needle. Use your Brewer Maintenance Accessory and get back to brewing in a few quick steps!

NOTE: The Brewer Maintenance Accessory comes with the brewer. It is an orange tool.

1. Please ensure the brewer is powered off. With the printed text on your Brewer Maintenance Accessory facing up, fill silicon bulb with water.

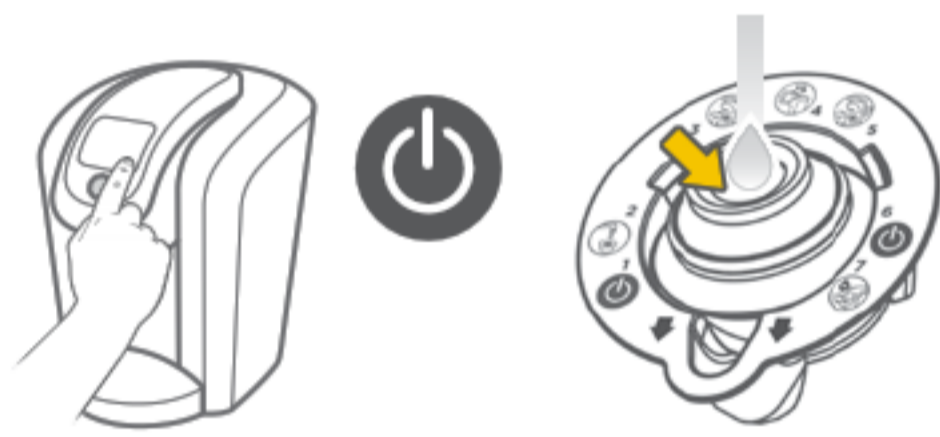

4. Remove Brewer Maintenance Accessory from Pod Holder.

Warning: Avoid sharp needles.



5. Once you have removed the Brewer Maintenance Accessory from the brewer, power the brewer back on.



2. Lift Handle, properly place Brewer Maintenance Accessory in Pod Holder with printed arrows pointing down.

Warning: Avoid sharp needles.



3. Raise and lower the Handle five times to loosen and remove any coffee grounds retained in your brewer's Entrance Needle.



6. Place a 12 ounce mug on the Drip Tray and perform a cleansing brew (refer to page 11).

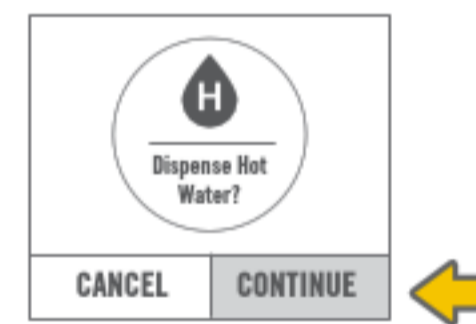

7. Brew your favorite Keurig® beverage and enjoy!



If you do not have this accessory please contact Keurig customer service at 1.866.901.BREW (2739).



**CLEANING THE EXIT NEEDLE**

1. If a clog arises in the Exit Needle, push the lever of the Pod Holder to reveal the Exit Needle.



2. Use a paper clip or similar tool to loosen the clog. Rinse thoroughly with hot water.

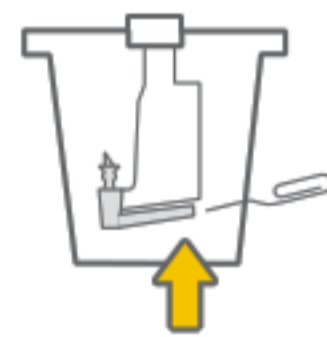

3. After all the pieces are cleaned, place the Base then the Pod Holder assembly into the Brew Head. Lower the Handle.

**CAUTION:** Sharp needles. Do not put fingers in chamber.



**KEURIG® CARAFE OPERATION**

The unique Keurig® Carafe was specifically designed for use with the Keurig® Plus Series brewer. To connect the Keurig® Carafe to the brewer, make sure the Keurig® Carafe is securely inserted into the brewer. The Keurig® Plus Series brewer contains a sensory system that determines when the Keurig® Carafe is in place and it is safe to begin brewing. If the Keurig® Carafe is not in place or is incorrectly inserted, the brewing process will not begin. If the Keurig® Carafe is removed during brewing, brewing will stop.

To maintain the ideal combination of taste, freshness, and temperature, we recommend preheating the Keurig® Carafe. To preheat the Keurig® Carafe, fill it with hot water for approximately 30 seconds and then pour out entirely prior to placing the Keurig® Carafe into the brewer.

**CAUTION:**

- Make sure the Keurig® Carafe is empty before each use.
- After brewing, the Keurig® Carafe will contain extremely hot liquid. Take care when pouring from the Keurig® Carafe. Never place your hand over the Keurig® Carafe where hot steam is venting. Never allow children to use the Keurig® Carafe or operate the brewer without adult supervision. Press the Power Button to terminate the brew process. Follow the instructions on the Touch Display before removing the Keurig® Carafe. The brewer will return to the home screen. Remove and discard the used K-Carafe® pod.
- There is extremely hot water in the Pod Holder during the brew process.
- To avoid risk of injury, do not lift the Handle during the brewing process.
- **HAND-WASH ONLY. DO NOT SUBMERGE. DO NOT MICROWAVE.**

**NOTE:** CARAFE NOT INCLUDED WITH BREWER.



**WATER FILTER ALERT**

Your brewer is designed to deliver the perfect cup time after time, year after year. To keep it working at peak performance, your Keurig® Plus Series brewer will let you know when it needs a little attention.

**TIME TO REPLACE THE KEURIG® WATER FILTER (VISIT KEURIG.COM TO PURCHASE)**

Your brewer will indicate “Time to replace the Water Filter.” after every 1,000 ounces or two months. Once you’ve replaced the Keurig® Water Filter, press YES to reset the WATER FILTER REMINDER notices.

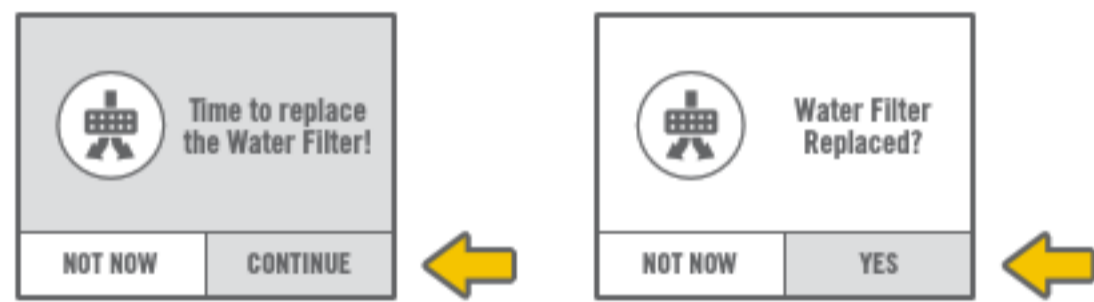

**SORRY, BREW INTERRUPTED**

Your brewer will indicate “Sorry, brew interrupted” if there is a problem brewing. To clear the problem, slowly lift and lower the Handle, remove the pod, and attempt a cleansing brew (see page 11).

**SORRY, THERE IS A PROBLEM**

If the brewer indicates “Sorry, there is a problem” coffee grounds may be stuck in the Entrance Needle. To release the clogged Needle, use the Brewer Maintenance Accessory included with your brewer. Refer to the instructions on page 30 or the guide included with the Accessory.



**TIME TO DESCALE THE BREWER**

Depending on the mineral content of your water, calcium deposits or scale may build up in your brewer, this is why we recommend using bottled or filtered water. Scale is non-toxic but if left unattended can hinder brewer performance. Regularly descaling your brewer every three to six months helps maintain the heating element, and other internal parts that come in contact with water. Calcium deposits may build up faster, making it necessary to descale more often.

You should promptly descale when the Touch Display indicates "Time to descale the brewer!" However, even if this is not indicated, you should continue to descale your brewer every three to six months.



**DESCALING YOUR BREWER**

Before you begin, you will need a large mug, fresh water, Keurig® Descaling Solution, and access to a sink. Do not use a paper cup.

- Empty the water from the Water Reservoir. If there is a Keurig® Water Filter, remove and set aside.

**STEP 1: FIRST DESCALING SOLUTION RINSE**

- Press and hold the Power Button to power the brewer off.
- Pour the entire bottle of Keurig® Descaling Solution into the Water Reservoir. Then fill the empty bottle with water and pour into the Water Reservoir. Press and hold the Power Button to turn the brewer back on.
- Place a large mug on the Drip Tray and run a cleansing brew by lifting and lowering the Handle, selecting a 10 ounce Brew Size and pressing the Brew Button. The brewer will stop dispensing after 10 ounces. Do not use a Keurig brand pod. Pour the contents of the mug into the sink.

**STEP 2: SECOND DESCALING SOLUTION RINSE**

- Repeat the cleansing brew process until the Touch Display indicates "More Water Please." Let the brewer stand for at least 30 minutes while still on.
- After 30 minutes, discard any residual solution and rinse the Water Reservoir thoroughly.

**STEP 3: FRESH WATER RINSE**

- Ensure the Water Reservoir is filled with fresh water to and not beyond the MAX FILL line.
- Place a large mug on the Drip Tray and run a cleansing brew. Pour the contents of the mug into the sink.
- Repeat the cleansing brew process at least 12 times. You may need to refill the Water Reservoir at least one time during this process.

NOTE: If "Time to descale the brewer!" is still indicated after completing the procedure, repeat the descaling procedure above.

**DESCALING YOUR BREWER (CONTINUED)**

The cleaning action of Keurig® Descaling Solution may result in a foam dispensed from the brewer. This is natural, as the solution is reacting with the scale inside. For a brewer that is heavily scaled, the brewer may not fill properly after the descaler is added. If this occurs, you may see only a small or no output dispensed followed by the sound of air blowing out. If this occurs:

- Turn off and unplug the brewer.
- If there is Keurig® Descaling Solution in the Water Reservoir, discard the contents, rinse the Water Reservoir thoroughly and refill with bottled or filtered water.
- Plug the brewer back in, power on, and repeat STEP 3: FRESH WATER RINSE (refer to page 37). The brewer should begin to function normally as the solution is rinsed out and the scale is removed. If the problem persists, allow the brewer to sit unplugged for at least 30 minutes then continue with the fresh water rinse.

Scan this QR code with your smartphone for step-by-step videos on cleaning, descaling, and more. Or if you prefer, you can watch the videos online at [Keurig.com](http://Keurig.com)



The plastic cups of K-Mug™ and K-Carafe® pods can be recycled wherever #5 plastic is accepted. #5 plastic may not be recyclable in your community today, so please check locally with your municipality or waste hauler, or visit [KeurigRecycling.com](http://KeurigRecycling.com) for more information.



For more information visit [www.KeurigRecycling.com](http://www.KeurigRecycling.com)

1. Once brewing is complete, lift the Handle and carefully remove the K-Mug™ or K-Carafe® pod by holding the outer rim.

**CAUTION:** The K-Mug™ or K-Carafe® pod will be hot after brewing. Use caution when removing. Allow it to cool completely before handling.



2. Once cool, separate the lid and filter from the cup. The filter will adhere to the lid.



3. Once separated, discard the lid and the attached filter. Recycle the pod's plastic cup wherever #5 plastic is accepted.



**BREWER DOES NOT HAVE POWER**

- Plug the brewer into an independent outlet without dimmer control.
- Check to be sure that the brewer is plugged in securely.
- Plug the brewer into a different outlet.
- Reset your home's circuit breaker if necessary.
- Press and hold the Power Button and ensure the Touch Display is illuminated.

**BREWER WILL NOT BREW**

- After placing a pod in the Pod Holder, make sure the Handle is lowered completely and the Touch Display displays the appropriate brew screen. Follow the brewing instructions in SECTION 1 (refer to pages 12–13).
- If the Touch Display indicates "More Water Please" add water to the Water Reservoir or make sure the Water Reservoir is seated properly in its Base.
- If the Touch Display indicates "More Water Please" even after refilling, remove the Water Reservoir and empty the water. Then thoroughly clean (refer to page 27). Fill the Water Reservoir to the MAX FILL line, return it to the brewer and ensure it is seated properly in its Base.
- The Pod Holder may need to be cleaned (refer to pages 28–29) or the brewer may need to be descaled (refer to pages 36–38).
- If you have completed the above procedure two times and this situation persists, contact Customer Service at 1.866.901.BREW (2739).

**BREWER BREWS ONLY A PARTIAL CUP**

- Clean the Pod Holder if necessary (refer to pages 28–29).
- The Water Reservoir may have been removed during brewing. Replace the Water Reservoir and perform a cleansing brew (refer to page 11) without a pod.
- Descale the brewer (refer to pages 36–38).
- If you have repeated the descale procedure on your brewer two times and it is still only brewing a partial cup, contact Customer Service at 1.866.901.BREW (2739).

40

**BREWER SHUTS OFF OR TURNS ON AUTOMATICALLY**

- Check to make sure that the AUTO ON/OFF settings have not been set (refer to page 20).

**THE TOUCH DISPLAY INDICATES "MORE WATER PLEASE."**

- If the water level is not low, remove the Water Reservoir and empty the water. Then thoroughly clean (refer to page 27). Fill the Water Reservoir to the MAX FILL line, return it to the brewer, and ensure it is seated properly in its Base.

**THE TOUCH DISPLAY INDICATES "SORRY, BREW INTERRUPTED." OR "SORRY, THERE IS A PROBLEM."**

- These screens indicate there are coffee grounds stuck in the Entrance Needle. Use caution and slowly lift the Handle and remove the pod from the brewer. To release the clogged needle, use the Brewer Maintenance Accessory included with your brewer. Refer to the instructions on page 30 or the guide included with the Accessory.

**THE K-CUP® POD HAS A KEURIG® LOGO, BUT TOUCH DISPLAY INDICATES "OOPS!"**

- Keurig cannot guarantee that pods without the Keurig® logo will work in the Keurig® Plus Series brewer. Some Keurig brand pods produced prior to January 2014 may not be enabled to work with the Keurig® Plus Series brewer. Please contact Customer Service at 1.866.950.2326 for a solution.

**STILL HAVING TROUBLE? VISIT KEURIG.COM FOR MORE INFORMATION.**

41

**LIMITED ONE YEAR WARRANTY**

Keurig warrants that your brewer will be free of defects in materials or workmanship under normal home use for one year from the date of purchase. It is recommended that you fill out and return the warranty card enclosed with your brewer so that your purchase information will be stored in our system. Keurig will, at its option, repair or replace a defective brewer without charge upon its receipt and proof of the date of purchase. If a replacement brewer is necessary to service this warranty, the replacement brewer may be new or reconditioned. If a replacement brewer is sent, a new limited one year warranty will be applied to the replacement brewer.

This warranty only applies to brewers operated in the United States and Canada.

This warranty gives you specific legal rights, and you may also have other rights that vary from state to state and, in the case of Canada, from province to province.

The Keurig® Plus Series brewer is designed to only work with Keurig® brand pods. Any damage to or malfunction of your brewer resulting from the use of non-Keurig® brand pods and accessories may not be covered by this warranty or may result in a service fee if the damage or malfunction is determined to be caused by such use.

**WHAT IS NOT COVERED BY THE LIMITED WARRANTY?**

THIS WARRANTY DOES NOT COVER CONSEQUENTIAL OR INCIDENTAL DAMAGES SUCH AS PROPERTY DAMAGE AND DOES NOT COVER INCIDENTAL COSTS AND EXPENSES RESULTING FROM ANY BREACH OF THIS WARRANTY, EVEN IF FORESEEABLE. Some states or provinces do not allow the exclusion or limitations of incidental or consequential damages, so the above limitation or exclusion may not apply to you depending on the state or province of purchase.

Nor does this warranty cover damages caused by use of non-Keurig® brand pods or accessories, services performed by anyone other than Keurig® or its authorized service providers, use of parts other than genuine Keurig® parts, or external causes such as abuse, misuse, inappropriate power supply, or acts of God.

**OTHER LIMITATIONS**

THIS WARRANTY IS EXCLUSIVE AND IS IN LIEU OF ANY OTHER EXPRESS WARRANTY, WHETHER WRITTEN OR ORAL. IN ADDITION, KEURIG HEREBY SPECIFICALLY DISCLAIMS ALL OTHER WARRANTIES WITH RESPECT TO YOUR K500 BREWER, INCLUDING ANY IMPLIED WARRANTY OF MERCHANTABILITY OR FITNESS FOR ANY PARTICULAR PURPOSE. Some states or provinces do not allow disclaimers of such implied warranties or limitations on how long an implied warranty lasts, so the above limitation may not apply to you depending on the state or the province of purchase.

**HOW DO YOU OBTAIN WARRANTY SERVICE?**

Keurig® brewers are high-quality appliances and, with proper care, are intended to provide years of satisfying performance. However, should the need arise for warranty servicing, simply call Keurig Customer Service at our toll free phone number 1.866.901.BREW (2739). Please do not return your brewer for servicing without first speaking to Keurig Customer Service to obtain an Authorization to Return number (ATR). Keurig® brewers returned without an ATR number will be returned to the sender without servicing.

Keurig Green Mountain, Inc.  
33 Coffee Lane  
Waterbury, VT 05676  
1.866.901.BREW (2739)



Keurig Green Mountain, Inc.  
33 Coffee Lane  
Waterbury, VT 05676  
1.866.901.BREW (2739)

P/N | Pièce n° | Pieza n.º DC0000000261 REV A  
12/15

