



SV1 SIRIUS One
SIRIUS Satellite Radio Plug and Play

User and Installation Guide

CONGRATULATIONS! Your new SV1 SIRIUS One SIRIUS® Satellite Radio Plug and Play Receiver lets you enjoy SIRIUS Satellite Radio's digital entertainment in your vehicle, home, or boat. Use this guide to familiarize yourself with all of SV1's features and capabilities. For the latest information about this and other SIRIUS products, please visit <http://www.siriusradio.com>.

Table of Contents

Safety Precautions	4	Selecting Channels Directly	16
FCC Warning	5	Advanced Features	17
Cleaning the Receiver	5	Channel Presets (BAND)	17
Package Contents	6	Storing Channel Presets	17
Installation	7	Using Channel Presets	17
Location	7	Searching for a Channel Preset (P.TUNE Mode)	18
Mounting the Receiver	7	FM Preset Button	18
Installing the Magnetic Antenna	8	Menu Options	19
Connecting the Receiver	10	FM Transmitter	20
Activating your SIRIUS Subscription	11	FM Presets	20
SV1 SIRIUS One Receiver Basic Operation	13	FM On/Off	21
Remote Control	14	Display Options	21
Installing Batteries in the Remote	14	Parental Control	22
Changing Channels	15	Lock/Unlock	22
Display Button (DISP)	15	Edit Code	23

Table of Contents (continued)

Audio Level	25
Signal Indicator	25
Factory Default	26
Troubleshooting	28
Specifications	29
12 MONTH LIMITED WARRANTY	30



© 2005 SIRIUS Satellite Radio Inc.

® "SIRIUS," the SIRIUS dog logo, channel names and logos are trademarks of SIRIUS Satellite Radio Inc. "NFL" and the NFL Shield logo, and the NFL Sunday Drive name and logo are registered trademarks of the National Football League. "NHL" and the NHL Shield are registered trademarks of the National Hockey League. "NBA" and the NBA silhouette logo are registered trademarks of NBA Properties Inc. Velcro is a registered trademark of Velcro Industries B.V. All other trademarks, service marks and logos are the property of their respective owners. All Rights Reserved.

Safety Precautions



Warning

Take the following precautions to prevent fire and avoid personal injury:

- Be sure the Receiver is installed as described in the Installation Guide.
- The use suggestions contained in this User Guide are subject to any restrictions or limitations that may be imposed by applicable law—the purchaser should check applicable law for any restrictions or limitations before installing and/or operating this Receiver.
- Failure to follow these safety instructions and warnings may result in a serious accident.
- To avoid short circuits, never put or leave any metallic objects (coins, tools, etc.) inside the Receiver.
- If the Receiver emits smoke or unusual odors, turn the power off immediately.
- Do not drop the Receiver, or subject it to strong shocks.

- If the LCD display on the Receiver becomes damaged or broken, do not touch the liquid crystal fluid. The fluid can be dangerous to your health. If the liquid crystal fluid contacts your body or clothing, immediately wash it off with soap and water.



Caution

Take the following precautions to keep the Receiver in proper working order:

- Do not open the Receiver.
- When replacing a fuse, use only a new one with the proper rating. Using a fuse with the wrong rating may cause the Receiver to malfunction.
- To prevent a short circuit when replacing a fuse, first disconnect the wiring harness.

Note:

If the Receiver doesn't seem to be working properly, turn the Receiver's power off, wait 5 – 10 seconds, then turn the power on again.



FCC Information

This device complies with Part 15 of the FCC Rules. Operation is subject to the following two conditions:

- (1) This Device may not cause harmful interference, and
- (2) This device must accept any interference received, including interference that may cause undesired operation.

Note: This equipment has been tested and found to comply with the limits for CLASS B digital device, pursuant to Part 15 of FCC Rules. These limits are designed to provide reasonable protection against harmful interference when the equipment is operated in a commercial environment. This equipment generates, uses and can radiate radio frequency energy and, if not installed and used in accordance with the instructions, may cause harmful interference to radio communications. However, there is no guarantee that interference will not occur in a particular installation. If this equipment does cause harmful interference to radio or television reception, which can be determined by turning the equipment off and on, the user is encouraged to try correct the interference by one or more of the following measures:

- 1.1. Reorient or relocate the receiving antenna.
- 1.2. Increase the separation between the equipment and receiver.
- 1.3. Connect the equipment into an outlet on a circuit different from that to which receiver is connected.
- 1.4. Consult the dealer or experienced radio/TV technician for help.

WARNING

Changes or modifications not expressly approved by the manufacturer could void the user's authority to operate the equipment.



Warning

Do not operate the Receiver in a way that might divert your attention from driving safely. As a driver, you alone are responsible for safely operating your vehicle in accordance with traffic safety laws at all times.

Cleaning the Receiver

If the Receiver becomes dirty, turn its power off and wipe it clean with a soft dry cloth. Do not use hard cloths, paint thinner, alcohol, or other volatile solvents to clean the Receiver. These may cause damage to the plastic or remove indicator characters.

Package Contents

The following items are packaged with the SV1 SIRIUS One. Check the package to be all of the items are included. If any of the items are missing, please contact the retailer where you purchased the product.



SV1 SIRIUS One
Receiver

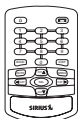

SIRIUS One
Remote Control



Magnetic Antenna



Rubber Antenna
Cable Cover/Tail
& Adhesive Strip



Alcohol Swab and
Velcro® Strips



Suction Cup Mount

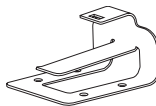

Visor/Dash Mount

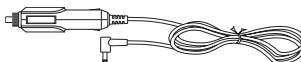

Cigarette Lighter
Power Cord



User Guide

Installation

Installation of your SV1 SIRIUS One is easy:

1. Choose a location in your vehicle where you will mount the Receiver, either on the visor, the dash, or the windshield.
2. Mount the Receiver on the visor using the visor/dash mount, or on the dash using the visor/dash mount and the velcro strips, or on the windshield using the suction cup mount.
4. Install the magnetic antenna on the roof of the vehicle, and route the antenna cable to the Receiver.
4. Connect the power cord for the Receiver to your vehicle's cigarette lighter.
5. Subscribe to the SIRIUS service and begin enjoying the SIRIUS entertainment!

Location

Choose a location in your vehicle where the Receiver will not block your vision, interfere with the vehicle controls, or obstruct the air bag. If you are using the suction cup mount, the location should be suitable for using the suction cup mount, such as the windshield or other flat, smooth surface.

The location should be easily reachable and provide good visibility of the Receiver.

Mounting the Receiver

Attach the desired mounting device, suction cup mount or visor/dash mount, to the Receiver by sliding the flat portion of the mount into slot on the top edge of the Receiver. Gently slide the mounting device in until it snaps into place.

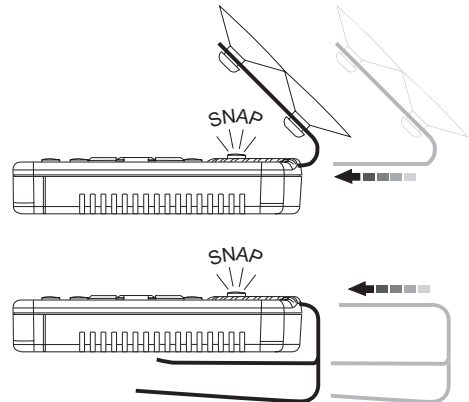

Depending upon your mounting choice, clip the Receiver to the visor, or, use the velcro strips to mount the Receiver to the dash, or, if you are using the suction cup mount, lightly moisten the surface of the suction cups which face the windshield (or other surface) and press the suction cups to the mounting surface.

Installing the Magnetic Antenna

The optimum mounting location for the antenna is on the roof of the vehicle, with a minimum unobstructed area of 12 inches by 12 inches, and exactly 6½ inches from the rear roof edge of the vehicle (the length of the rubber antenna cable cover/tail). It is important to avoid any obstructions that will block the SIRIUS signal, obstructions such as a roof rack, a sunroof, roof mounted cargo containers, or other antennas.

The following illustrations show the recommended mounting locations of the antenna for several types of vehicles. Follow these recommendations for best performance from the antenna.

Sedan/Coupe: Mount the antenna along the rear centerline of the vehicle roof, located at the rear of the roof near the rear window.



SUV/Mini-Van: Mount the antenna along the rear centerline of the vehicle roof, located at the rear of the roof near the rear door/hatch.



Pickup Truck: Mount the antenna along the rear centerline of the cab roof, located at the rear of the roof near the rear window.

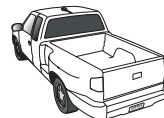

Convertible: Mount the antenna along the centerline of the trunk lid, with the rubber antenna cable cover/tail directed toward the rear window.

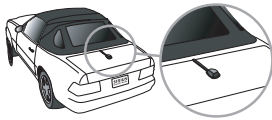

Clean the area where the antenna and rubber antenna cable cover/tail will be mounted with the supplied alcohol swab.

Connect the rubber antenna cable cover/tail to the antenna cable, making sure that the strain-relief on the antenna seats into the rubber antenna cable cover/tail groove. Route the antenna cable through the wire channel in the rubber antenna cable cover/tail. Do not yet attach the adhesive strip.

Temporarily position the antenna and rubber antenna cable cover/tail in the selected mounting area and route the cable from the antenna to the vehicle's interior by tucking it underneath the rubber molding around rear window, as shown.

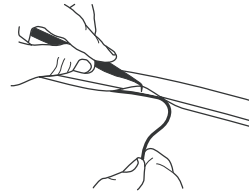

Route the cable from the lowest point of the rear window into the trunk. Take advantage of any existing cable channels or wiring conduits. For SUVs, mini-vans & 5-door vehicles, bring the cable into the vehicle under the rubber molding for the tailgate, and continue under the interior trim.

From the trunk, or rear of the vehicle, route the cable around the passenger compartment and to the front of the vehicle, to the receiver. Take care not pull the cable across sharp edges that could damage it, and keep it away from areas where it might entangle feet. Coil any excess antenna cable in a location where it can be hidden.

Once the antenna cable is routed through the vehicle, and you are satisfied with the cable routing,

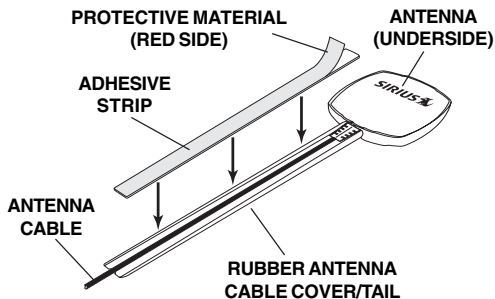

peel the **yellow** protective material from the adhesive strip and adhere the adhesive strip to the rubber antenna cover/tail. Next peel the **red** protective material from the adhesive strip and press the rubber antenna cable cover/tail firmly into place on the vehicle.

Double check that the location of the antenna and rubber antenna cable cover/tail are correct, and continue to press firmly down on rubber antenna cable cover/tail for another 30 seconds.

Note: At room temperature (68 degrees), maximum adhesion usually occurs within 72 hours. During this

period, avoid car washes and other contact with the antenna and rubber antenna cable cover/tail.

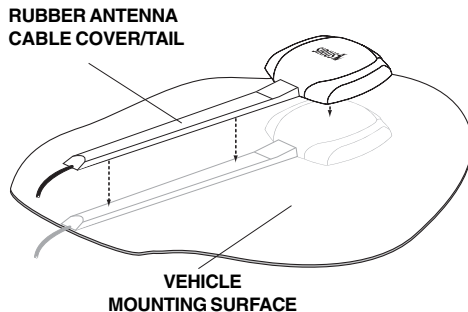

Connecting the Receiver

Connect the antenna and cigarette lighter power adapter to the Receiver to complete the installation. The illustration below shows the location of the antenna and power connectors on the Receiver.

Plug the cigarette lighter power adapter cord into your vehicle's cigarette lighter, and turn the Receiver On by pressing the power button. Once you have verified that Receiver has powered on, you can

proceed with activating your SIRIUS subscription.

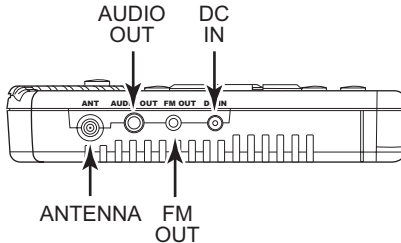

Activating your SIRIUS Subscription

Before you can listen to the SIRIUS service, you need to subscribe to the SIRIUS Satellite Radio service.

1. Be sure that the Receiver is correctly installed and that the antenna is oriented to receive the SIRIUS signal.
2. Press the power button to turn Receiver On. After displaying the SIRIUS logo, the Receiver will update the SIRIUS channel line up. The display will show, "UPDATING CHANNELS" and show the status of the update.

U P D C H S X X %

Wait until the channel updates have completed before pressing any buttons on the Receiver.

3. Once the channels have been updated, the display will change to "Call 1-888-539-SIRIUS to Subscribe" and will place you in SIRIUS Satellite Radio's Preview Channel, channel 184. You will not be able to tune to any other channels until you activate your SIRIUS subscription.

C a l l 1 - 8 8 8 - 5

4. To listen to the audio from your Receiver, you will need to tune the FM radio in your vehicle and the FM transmitter in the Receiver to the same FM frequency. The FM transmitter in the Receiver defaults to 88.1 MHz, so you can begin by tuning your FM radio to 88.1 MHz. If there is an FM station broadcasting on that frequency, you will have to

search for a quiet frequency to use. Refer to the section titled, *FM Transmitter* in this User Manual for instructions on how to tune the FM transmitter to other FM frequencies.

5. Press the **MENU** button on the remote control and use the channel up and down buttons to display the “SIRIUS ID” menu option. Then press the Select button. This will display your Receiver’s unique 12-digit SIRIUS ID number (SID). You may also press and hold the Select button for two seconds to display the SID. (The SID number is also available on the SV1 packaging.) Write the SID number down in the space provided at the end of this manual.

1 1 2 2 3 3 4 4 5 5 6 6

6. Have your credit card handy and contact SIRIUS on the Internet at:

<https://activate.siriusradio.com/>

and follow the prompts to activate your subscription. You can also call SIRIUS toll-free

at:

1-888-539-SIRIUS (1-888-539-7474)

7. When you have successfully subscribed to the SIRIUS service, and the Receiver has been updated with your subscription information, “UPDATED” will be followed by “PRESS A KEY”.

U P D A T E D



P R E S S A K E Y

To continue, press any key on the Receiver. The installation of your Receiver is now complete, and you are ready to begin enjoying SIRIUS Satellite Radio’s digital entertainment!

SIRIUS
SATELLITE RADIO

SV1 SIRIUS One Receiver Basic Operation

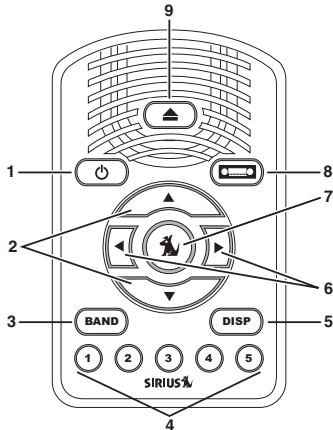

1. **POWER Button** (⏻) : Turns the Receiver's power On and Off.
2. **Channel Up/Down Buttons:** Navigates through channels and display screens.
3. **BAND Button (P.Tune):** Pressing and releasing switches between the five preset banks (A, B, C, D and E), which hold five presets each. Pressing and holding enables "Preset Tune Mode", which allows

for viewing and listening of stored presets with the channel up/down buttons.

4. **Preset Number Buttons (1-5):** Sets and selects preset channels. Also used to directly tune channels by entering the channel number.
5. **DISP (Display) Button:** Toggles display between the channel number and name, channel number and category, channel number and artist name, and channel number and song title. Holding the DISP button down flips the display screen 180 degrees to enable mounting the Receiver upside down on a vehicle visor.
6. **Category Previous/Next Buttons:** Navigates through the category (genre) list screen which displays SIRIUS channel categories.
7. **Select Button:** Selects items displayed on the screen.
8. **FM Preset Button:** Selects between preset FM frequencies used for the built-in wireless transmitter. Pressing and holding the FM Preset button will access the list of FM presets where you can change them.
9. **Mounting Release Button:** This button releases the mount which is connected to the Receiver.

Remote Control

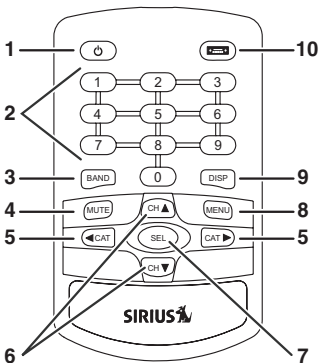

Installing Batteries in the Remote

1. Remove the battery cover.
2. Install CR2032 battery. (+ positive side is up)
3. Replace the battery cover.

1. **Power Button** (⏻) : Turns the Receiver power On and Off.
2. **Number Buttons (0-9)**: Used for directly selecting channels and for presets.
3. **BAND Button**: Switches between preset bands A, B, C, D, and E.
4. **MUTE Button**: Mutes the audio.
5. **Category Previous/Next Buttons**: Navigates through categories (genres).
6. **Channel Up/Down Buttons**: Navigates through channels and display screens.
7. **Select Button**: Selects items on the display screen.
8. **MENU Button**: Used to access menu options to make setup and feature changes.
9. **DISP Button**: Toggles display between the channel number and name, channel number and category, channel number and artist name, and channel number and song title. Holding the DISP button down flips the display screen 180 degrees to enable mounting the Receiver upside down on a vehicle visor.
10. **FM Preset Button**: Selects between preset FM frequencies used for the built-in wireless transmitter.

After you have successfully activated your SIRIUS subscription, and the Receiver has received the subscription information from the SIRIUS signal, the default display screen will be displayed.



When the Receiver is powered On, the previously selected channel will automatically begin playing, and the channel name of the current channel will be displayed.

Changing Channels

Pressing the channel up or down button will cause the Receiver to immediately tune to the next or previous channel.

Pressing the category previous or next button will cause the receiver to display a list of the channels in the current category. Use the channel up and down buttons to navigate through the list.



Pressing the category previous or next button will cause the Receiver to display a listing of the previous or next channel category.

Use the channel up/down buttons to display a channel within a category and press the select button to tune to the channel. When a new channel is selected, the display will revert to the default display screen for the new channel.

Display Button (DISP)

Momentarily pressing and releasing the **DISP** (Display) button while the default screen is displayed causes the Receiver to sequence the display between the channel number and channel name, channel number and category name, channel number and artist name, and channel number and song title.

0 1 4 C I S V i n y l



0 1 4 R O C K



0 1 4 A l i c e C o



0 1 4 S c h o o l ' s

Note: If you are viewing a sports category channel list (NFL®, NBA®, NHL®, or College), pressing and releasing the **DISP** button will instead toggle between the team names and the current score of any live play-by-play game.

Use the category previous and next buttons to scroll through the music and entertainment categories,

and the channel up and down buttons to scroll through the available channels in each category to find the channel to which you want to listen.

When you have found the channel you wish to listen to, press the select button to tune to the channel. The new channel will begin playing and the display will revert to the default display screen for the new channel.

Pressing and holding the **DISP** button for 1 second will cause the Receiver to flip the display screen 180 degrees to enable mounting the Receiver upside down on a vehicle visor.

Selecting Channels Directly

A channel may be directly selected by entering the channel number using 0-9 buttons on the remote control.

To enter a channel number, momentarily press and release the select button. At the display prompt, enter the three digit channel number.

CH# : _ _ _

Advanced Features

Channel Presets (BAND)

You can store up to 30 of your favorite channels as presets for quick recall access. The preset channels are stored in 5 bands, A, B, C, D, E, and F each containing 5 channel presets, and are numbered 1 to 5. The 5 channel presets in each band are accessed by pressing the appropriate number (1 to 5) on the Receiver. A momentary press and release of the **BAND** button cycles through the 5 preset bands (A, B, C, D, E, and F).

Storing Channel Presets

To store a favorite channel as a preset, do the following:

1. Momentarily press and release the **BAND** button until the desired preset band, A, B, C, D, E, or F, is displayed.
2. Tune the Receiver to the channel you wish to store as a preset. (See the section, *Basic Operation* for specific instructions for tuning to a channel.)
3. Press and hold for 1 second the numbered preset button in which you wish to store your

favorite channel. The band and preset number will then be displayed to confirm that the channel has been stored.



Note: If the preset button already has a channel stored in it, the preset will be replaced by the newly stored channel.

Using Channel Presets

Press and release the **BAND** button to cycle between the preset bands until the preset band you want is displayed.

The 5 preset channels in the active band can then be selected by momentarily pressing and releasing the 1 through 5 buttons.

When you have chosen a preset channel, the band and preset number will be displayed.



Searching for a Channel Preset (P.TUNE Mode)

To quickly search through all of your presets in the P.TUNE mode, do the following:

1. Press and hold the **BAND** button for approximately 1 second to enter the P.TUNE mode. "Preset Tuning Mode" will momentarily be displayed and the preset number will be displayed to indicate the Receiver is in the Preset Tune Mode.

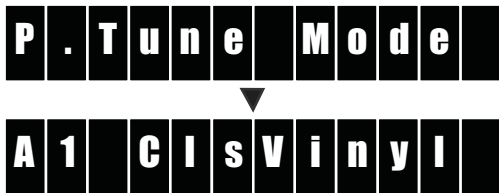

2. Use the channel up and down buttons to move up or down through your channel presets and immediately tune to each channel. Channel presets are grouped and displayed by bank and preset number, i.e., A1, A2...B1, B2, etc. Empty

presets are not displayed.

3. To exit the P.TUNE mode, press and hold the **BAND** button for approximately 1 second, until the default display screen is displayed.

FM Preset Button

The Receiver has a special button called the FM Preset button, which is identified by the  icon. When the FM Preset button is pressed, the Receiver turns on the built-in FM transmitter and begins transmitting on the next frequency from the FM frequency preset list. A screen will be displayed for 3 seconds showing the currently selected FM frequency. When the FM transmitter is turned on, an FM radio tuned to the same FM frequency will receive the currently tuned SIRIUS broadcast.



Each subsequent press of the FM Preset button advances to the next preset in the FM frequency preset list. By using the FM Preset button, a quiet FM frequency may be quickly tuned.

If no FM frequencies have been preset when the FM Preset button is pressed, the Receiver will default to a frequency of 88.1 MHz.

Pressing and holding the FM Preset button will display the list of FM presets. Use the channel up and down buttons to browse through the list.

F M - 1 8 8 . 1



F M - 2 9 1 . 5



F M - 5 1 0 3 . 9

If you want to change the FM frequency of a preset, press the select button to choose the preset when it is displayed. Use the channel up and down buttons to select an FM frequency and press the select

button. The preset will now display the new FM frequency. To select the preset, press the **MENU** button.

You may also change the FM presets by using the FM Presets menu option of the Receiver. (Refer to the *FM Transmitter* section in the *Menu Options* section of this manual for instructions on programming the FM presets list.)

Menu Options

To enter the Menu Options page of the Receiver, press and hold the select button, or press the **MENU** button on the remote control. The menu options will be then displayed.

S I R I U S I D

To select a menu option, use the channel up and down buttons to display the option you wish to adjust, and press the select button. If a selection is not made within 10 seconds, the Receiver will exit the menu options mode, and revert to the last active display mode.

To exit menu options, or any of the other menu option screens, repeatedly press and release the **MENU** key on the remote control until you are returned to the default display screen.

The following sections explain each of the menu options in the order in which they are displayed on the Menu Options screen.

SIRIUS ID

This option displays your 12 digit Sirius ID (SID) number. The SID is unique to every Receiver and is required to activate your service. It is recommended that you write this number in the space provided on the last page of this user guide. No adjustments are allowed in this mode. To exit the Sirius ID menu, press the **MENU** button.

FM Transmitter

The FM Transmitter feature allows you to create a preset list of 5 suitable FM frequencies which can then be accessed by using the FM Preset button. This option also allows you to turn the FM transmitter On and Off.

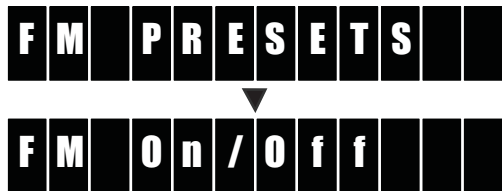

FM Presets

To create or add to a list of FM preset frequencies, do the following:

1. Using the channel up and down buttons, display the “FM PRESETS” menu item and press the select button. You will then enter a list of FM presets. (You may also enter this list by pressing and holding the FM Preset button.)



2. Using the channel up and down buttons, display the FM preset you wish to set (or change) and

press the select button. You will then enter a list of FM frequencies, beginning with the currently selected FM frequency for the preset.

8 8 . 1 M H Z

- Use your FM radio to locate quiet FM frequencies where there is no interference from adjacent FM stations. These are the frequencies which should be added to the FM presets list.
- Using the channel up and down buttons, display the frequency you wish to select for the preset and press the select button. The FM frequency will then be stored in the preset.
- You may then continue to select FM frequencies for other presets using the same steps. To exit the FM Presets menu, press the **MENU** button.

FM On/Off

To turn the Receiver's FM transmitter On or Off, use the channel up and down buttons to display the "FM On/Off" menu item and press the select button.

F M O N



F M O F F

Use the channel up and down buttons to display "FM On" or "FM Off", and press the select button.

To exit the FM On/Off menu, press the **MENU** button.

Display Options

The Receiver's display screen can be adjusted for brightness and contrast using the Display Options menu option.

B r i g h t n e s s



C o n t r a s t

Use the channel up and down buttons to display the “Brightness” or “Contrast” option, and press the select button.

Brightness adjusts the overall intensity of the LCD display to help with viewing in different lighting conditions. Contrast adjusts the relationship between the background and the text on the LCD display. Use the channel up and down buttons, to adjust the brightness/contrast. The bar graph will move to indicate the change.



To exit the Brightness/Contrast screen, press the **MENU** button.

Parental Control

The Receiver has the ability to lock out with password protection any channels you do not want others to access without your permission. A locked channel will not appear in the channel list.

C H A N N E L L O C K



E d i t C o d e

When access to a locked channel is attempted using the direct channel entry method, the “Enter Code” screen is displayed and the channel cannot be accessed until the correct code is entered.

C o d e # : _ _ _ _

If the wrong code is entered, a message will be displayed indicating that the wrong code has been entered.

W r o n g C o d e

Lock/Unlock

To lock or unlock a channel, do the following:

1. Use the channel up and down buttons to display the “Lock/Unlock” menu choice, and press the select button.
2. If this is the first time that Parental Control is being used, you will be prompted to create and enter a four digit numerical code. This code can be any four digit number from **0000** to **9999**.

N e w # : [] [] [] [] [] [] [] []

If you should exit this prompt without entering a code, you will be prompted to set a code next time you enter the Lock/Unlock option.

3. If a code has been previously set, a “Enter Code” prompt will be displayed. Enter your four digit code and press the select button to continue.

C o d e # : [] [] [] [] [] [] [] []

4. When the correct code has been entered, a you will enter a list of channels. Use the channel up and down buttons to navigate to the channel you wish to lock or unlock, and press the select button. A previously locked channel will have the lock icon displayed to the right of the channel number.

0 1 2  **S p i r i t** [] [] [] [] [] [] [] []

5. To lock or unlock a channels, use the channel up and down buttons to display a channel, and press the select button.
If you are locking a channel, the word “Lock” will be displayed to the right of the channel name. If you are unlocking a channel, the word “Lock” will be removed from the right of the channel name.

To exit the Parental Control menu, press the **MENU** button.

Edit Code

This setting allows you to change a previously selected Parental Control code.

The first time the Edit Code setting is accessed you will be prompted to enter a four digit code. This code can be any four digit number from **0000** to **9999**.

N e w # : [] [] [] [] [] [] [] []

If you should exit this prompt without entering a code, you will be prompted to set a code the next time you enter the Edit Code option.

To change the Parental Control code, do the following:

1. Use the channel up and down buttons to display the “Edit Code” menu option, and press the select button.
2. At the prompt, enter the four digit Parental Control code.

C o d e # : [] [] [] [] [] [] [] []

3. If you did not enter the correct code, a message will be displayed alerting you that the wrong

code was entered, and you will be prompted again to enter the code.

W r o n g C o d e [] [] [] []

4. If the correct code was entered, the “New Code” prompt will appear. Enter the new Parental Control code.

N e w # : [] [] [] [] [] [] [] []

5. You will then be prompted to confirm the new code by entering it again.

C O N F I R M : [] [] [] [] [] [] [] []

6. If you confirmed the correct code, the lock code is now changed and a confirmation screen is displayed. If you entered the wrong code at the confirmation prompt, a screen will be displayed to alert you that you have entered the wrong

code, and you will have to repeat the process again.

N o w C h a n g e d

To exit the Parental Control menu, press the **MENU** button.

If you have forgotten your Parental Control code, call SIRIUS Customer Service for help.

Audio Level

The Audio Level menu option adjusts the level of the audio output of the Receiver.

To adjust the audio level, use the channel up and down buttons to change the audio level. The bar graph will move to indicate the change.



To exit the Audio Level menu, press the **MENU** button.

Signal Level

The Signal Level display screen provides a visual display of the strength of the SIRIUS signal from the satellite antenna and also from terrestrial (ground) transmitters.

To display the Signal Level screen, do the following:

1. Use channel up and down buttons to display the “Signal Level” menu option, and press the select button.



2. The satellite signal strength screen will be displayed. Using the channel up and down buttons, you can display the terrestrial signal strength screen.
3. A 6 segment horizontal bar graph will be displayed with a “-” sign to the left and a “+” sign

Troubleshooting

This section lists several common problems and suggested solutions. If, after trying the suggested solutions listed here, you are still unable to resolve the problem you're having with your Receiver, contact your installer, dealer, or retailer for more help.

Problem	Cause and Suggested Solution
Receiver does not power on	Blown fuse, or the power cable is not properly connected. Check for a bad fuse and check power cable connection.
Receiver displays: "NO ANTENNA"	The satellite antenna is not connected to the Receiver. Check the satellite antenna connection to the Receiver.
Receiver displays: "NO SIGNAL"	Check for obstacles over or around satellite antenna. Change vehicle location to eliminate nearby obstacles (bridges, overpasses, etc.)
Audio static or loss of clarity	FM frequency contains static. Locate a quiet FM frequency on your vehicle radio and set the Receiver's FM transmitter frequency to match.
No sound	The vehicle antenna is not connected to radio. Check vehicle antenna cable to be sure it is connected. The audio cables are not connected, or the FM radio is set to the wrong frequency. Check the audio cables at the Receiver and the vehicle radio. Tune the vehicle FM radio to the same FM frequency the Receiver is tuned.

Specifications

Satellite Frequencies	2322.293/2330.207 MHz
Terrestrial Frequencies	2326.250MHz
Power Requirements	9-16 Volts, Negative Ground, DC
Audio Output	550mVrms (+/- 50mVrms)
Total Harmonic Distortion (THD)	<0.2%
Signal-to-noise (S/N)	Greater than 73dB
Fuse Requirement	2A ATC
Receiver Dimensions (Width x Length x Height)	70mm x 113.2mm x 20.2mm (2.8" x 4.5" x .8")
Receiver Weight	146.0g (4.7 oz.)
Antenna Type	Low Profile Magnetic
Antenna Cable Length	21' (single micro-cable)
Connector Type	SMB (right-angle)
Audio Interface	1/8" / 3.5mm Stereo Jack
FM Out Interface	2.5mm Jack
Remote Control Dimensions (Width x Length x Height)	54mm x 90mm x 11mm (2.13" x 3.5" x .43")
Remote Control Battery Requirements	CR2032

Note: Features and Specifications subject to change without notice.

12 MONTH LIMITED WARRANTY

SIRIUS Satellite Radio Inc. (the “Company”) warrants to the original retail purchaser of this product that should this product or any part thereof, under normal use and conditions, be proven defective in material or workmanship within 12 months from the date of original purchase, such defect(s) will be repaired or replaced with new or reconditioned product (at the Company’s option) without charge for parts and repair labor. To obtain repair or replacement within the terms of this Warranty, the product is to be delivered with proof of warranty coverage (e.g. dated bill of sale), specification of defect(s), transportation prepaid, to the location shown below under **WARRANTY RETURN**.

This Warranty does not extend to the elimination of externally generated static or noise, to correction of antenna problems, to costs incurred for installation, removal or reinstallation of the product, or to damage to tapes, compact discs, speakers, accessories, or vehicle electrical systems.

This Warranty does not apply to any product or part thereof which, in the opinion of the Company, has suffered or been damaged through alteration, improper installation, mishandling, misuse, neglect, accident, or by removal or defacement of the factory serial number/bar code label(s). THE EXTENT OF THE COMPANY’S LIABILITY UNDER THIS WARRANTY IS LIMITED TO THE REPAIR OR REPLACEMENT PROVIDED ABOVE AND, IN NO EVENT, SHALL THE COMPANY’S LIABILITY EXCEED THE PURCHASE PRICE PAID BY PURCHASER FOR THE PRODUCT.

This Warranty is in lieu of all other express warranties or liabilities. ANY IMPLIED WARRANTIES, INCLUDING ANY IMPLIED WARRANTY OF MERCHANTABILITY, SHALL BE LIMITED TO THE DURATION OF THIS WRITTEN WARRANTY. ANY ACTION FOR BREACH OF ANY WARRANTY HEREUNDER INCLUDING ANY IMPLIED WARRANTY OF MERCHANTABILITY MUST BE BROUGHT WITHIN A PERIOD OF 48 MONTHS FROM DATE OF ORIGINAL PURCHASE. IN NO CASE SHALL THE COMPANY BE LIABLE FOR ANY CONSEQUENTIAL OR INCIDENTAL DAMAGES FOR BREACH OF THIS OR ANY OTHER WARRANTY, EXPRESS OR IMPLIED, WHATSOEVER. No person or representative is authorized to assume for the Company any liability other than expressed herein in connection with the sale of this product. Some states do not allow limitations on how long an implied warranty lasts or the exclusion or limitation of incidental or consequential damage so the above limitations or exclusions may not apply to you. This Warranty gives you specific legal rights and you may also have other rights which vary from state to state.

WARRANTY RETURN: To obtain repair or replacement within the terms of this Warranty, please return product to an authorized retailer or call Customer Service at 1-888-869-5590; proof of purchase and description of defect are required. Products to be returned to an approved warranty station must be shipped freight prepaid.

Please record the SIRIUS ID (SID) in the space provided below:

SIRIUS ID:



SIRIUS Customer Service: 1-888-539-7474

SIRIUS Product Support: 1-800-869-5590

customer care@sirius-radio.com



**SIRIUS Satellite Radio Inc.
1221 Avenue of the Americas
New York, NY 10020
1-888-539-7474
www.sirius.com**