

# VISOR



## Instruction Manual

Model **XTR3CK**

To activate your XACT Visor Satellite Radio Receiver or for latest news and questions regarding SIRIUS® Satellite Radio service visit [sirius.com](http://sirius.com) or call 1-888-539-SIRIUS (7474).

For accessory & product information visit us at [www.getxact.com](http://www.getxact.com).

**XACT**™

**SIRIUS**  
SATELLITE RADIO

**KEEP MOVING**



This equipment has been tested and found to comply with the limits for a Class B digital device, pursuant to Part 15 of the FCC Rules. These limits are designed to provide reasonable protection against harmful interference in a residential installation. This equipment generates, uses, and can radiate radio frequency energy and, if not installed and used in accordance with the instructions, may cause harmful interference to radio communications. However, there is no guarantee that interference will not occur in a particular installation. If this equipment does cause harmful interference to radio or television reception, which can be determined by turning the equipment off and on, the user is encouraged to try to correct the interference by one or more of the following measures:

- Reorient or relocate the receiving antenna.
- Increase the separation between the equipment and receiver.
- Connect the equipment into an outlet on a circuit different from that to which the receiver is connected.
- Consult the dealer or an experienced radio/TV technician for help.

Changes or modifications not expressly approved by the Manufacturer for compliance could void the user's authority to operate the equipment

**NOTE!** Use only the appropriate XACT accessories or input devices with your receiver. Use only the 12v Vehicle Adapter that is provided with the kit. It is important that you do not modify it in any way since this will result in damaging your equipment and void the warranty.

## **COPYRIGHT / TRADEMARKS**

No part of this publication may be reproduced, stored in a retrieval system, or transmitted in any form or by any means, whether electronic, mechanical, photocopying, recording or otherwise without the prior writing of the publisher.



is a registered trademark of SIRIUS® Satellite Radio. To activate your XACT Visor Satellite Radio Receiver or for latest news and questions regarding SIRIUS® Satellite Radio service visit [sirius.com](http://sirius.com) or call 1-888-539-SIRIUS (7474).

# SAFETY PRECAUTIONS

## **Warning**

Follow these notifications to avoid any traffic accidents or personal injury:

1. Installation must be performed according to this user guide.
2. Do not install the device where it may obstruct your view through the windshield or of your vehicle's indicator displays.
3. Do not install the device where it may hinder the function of safety devices such as an airbag. Doing so may prevent the airbag from functioning properly in the event of an accident.
4. The installation and usage suggestions contained in this user guide are subject to any restrictions or limitations that may be imposed by applicable law. The purchaser should check applicable law for any restrictions or limitations before installing and/or operating this device.
5. Failure to follow these safety instructions and warnings may result in a severe accident.

## **Danger**

Be aware of the following precautions to prevent fire and avoid personal injury:

1. To avoid short circuits, never put or leave any metallic objects (coins, tools, etc.) inside the device.
2. If the device emits smoke or strange smells, turn the power off immediately and contact your dealer.
3. Do not drop the device or subject it to strong impacts or mechanical shocks.
4. If the LCD display becomes damaged or broken, do not touch the liquid crystal fluid. The fluid may be dangerous to your health or even fatal. If the liquid crystal fluid contacts your body or clothing, immediately wash it off with soap and water.

## **Caution**

Do not operate this device in a way that might divert your attention from driving safely. As a driver, you are responsible for safely operating your vehicle in accordance with traffic safety laws at all times.

# TABLE OF CONTENTS

<b>Introduction</b>	Page 3
Product Overview	Page 3
Package Contents	Page 3
<b>Components Guide</b>	Page 4
XACT Visor SIRIUS® Satellite Radio Receiver	Page 4
Wireless Remote Control	Page 5
<b>Getting Started</b>	Page 6
Mounting Your XACT Visor Satellite Radio Receiver at Home	Page 6
Mounting Your XACT Visor Satellite Radio Receiver in a Vehicle	Page 6
Activating Your SIRIUS® Subscription	Page 7
Make Note of Your Identification Number	Page 7
Using The Vehicle Kit	Page 8
Mounting to the Dashboard or Console	Page 8
Mounting to the Windsheild	Page 9
Mounting to the Sunvisor	Page 10
If you Have Purchased the Home Kit	Page 11
Mounting in your Home	Page 11
<b>Basic Operations</b>	Page 12
Tuning to Different Entertainment Categories	Page 12
Tuning to Different Channels in a Selected Category	Page 12
Direct Tuning (Remote Only)	Page 13
Presetting Channels	Page 13
<b>Menu Options Settings</b>	Page 14
<b>Basic Setting Procedure</b>	Page 14
SIRIUS® ID	Page 14
Display Settings	Page 15
Brightness Control	Page 15
Flip Display	Page 16
Contrast Control	Page 16
Factory Default	Page 17
Auto Shutoff	Page 18
Parental Block	Page 19
Block	Page 19
UnBlock	Page 20
Edit Code	Page 21
FM Transmitter	Page 22

# TABLE OF CONTENTS

<b>Display Messages</b>	Page 23
Acquiring Signal	Page 23
No Antenna	Page 23
Updating Channels	Page 23
Subscription Updated	Page 23
Mute	Page 24
UnMute	Page 24
Clearing	Page 24
<b>Problem Solving</b>	Page 25
<b>Warranty</b>	Page 26

Blank lines representing additional content in the table of contents.

# INTRODUCTION

## Product Overview

Thank you for purchasing this product! Your new plug and play XACT Visor Satellite Radio is specifically designed to mount in a vehicle or indoor/outdoor location.

## Package Contents

Carefully unpack your kit and ensure that you have the following items.

- XACT Visor Satellite Radio Receiver
- Wireless Remote Control
- CR2025 Battery (for the Wireless Remote Control)
- Vehicle Mounting Bracket (Windshield / Dashboard / Visor Mount)
- Vehicle Antenna
- 12v Vehicle Adapter
- 12v Vehicle Fused Hardwire Cable
- User's Guide

In the event that any item is missing or if you find any mismatch or damage, promptly contact your dealer.

Your Xact Visor Satellite Radio Receiver must be used in conjunction with any one of the following Xact Kits, such as the Universal kit, Home kit or Boom Box as required by your specific needs.

- Xact Vehicle Kit: Model Number XS051
- Xact Home Kit: Model Number XS052

The easiest way to activate your XACT Visor Satellite Radio Receiver is to log on to [sirius.com](http://sirius.com). You may also call 1-888-539-SIRIUS (7474).

# COMPONENTS GUIDE

## XACT Visor SIRIUS® Satellite Radio Receiver

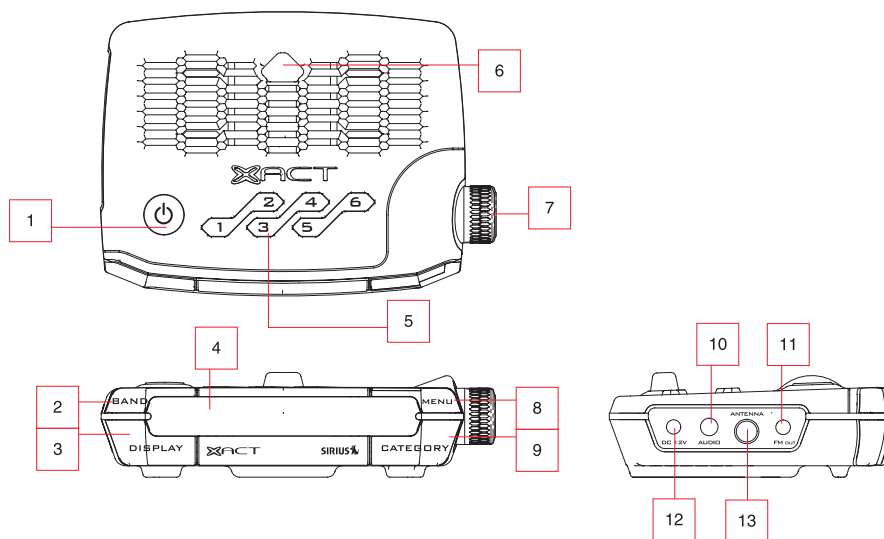

1. Power Button
2. BAND
3. DISPLAY (Press and release button to start scroll from the beginning. Press and hold to flip the display).
4. LCD Monitor (Main Display)
5. Numerical Keys
6. IR for Remote Control
7. Channel Up/Down Rotary Dial, Select Button (By pressing dial inward)
8. MENU Options List
9. CATEGORY Button
10. Audio Jack
11. FM Out Jack
12. DC Power Jack
13. Antenna Jack



# COMPONENTS GUIDE

## Wireless Remote Control

The wireless remote control packed with your plug and play XACT Visor Satellite Radio mirrors the operations of your plug and play XACT Visor Satellite Radio Receiver from a remote location.

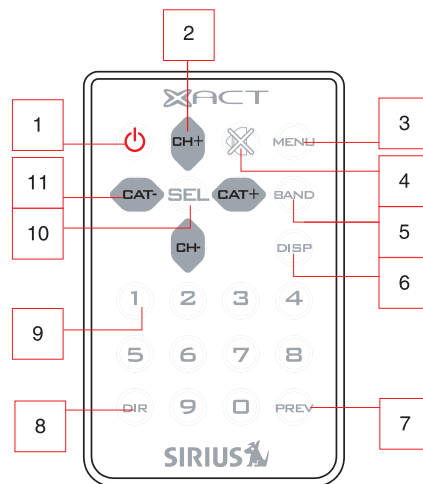

1. Power Button
2. CH (Channel) (Ascend/Descend Buttons)
3. MENU Options List
4. MUTE
5. BAND
6. DISP (Display) (Press and release button to start scroll from the beginning. Press and hold to flip the display)
7. PREV (Previous Channel)
8. DIR (Direct Input)
9. Numerical Keys
10. SELECT (OK Button)
11. CAT (Category) (Left/Right Directional Buttons)







# GETTING STARTED

## Mounting Your XACT Visor Satellite Radio at Home

Find an appropriate location near your stereo receiver to install your plug and play XACT Visor Satellite Radio Receiver.

## Mounting Your XACT Visor Satellite Radio in a Vehicle

Find an accessible location in your vehicle to install your plug and play XACT Visor Satellite Radio Receiver; usually, this is the dashboard. You may also mount the receiver to the vehicle's sun Visor.

-  Do not mount your device where it may obstruct your view through the windshield or your view of your vehicle's indicator displays.
-  Do not mount your device where it may impede your access to the vehicle's controls.
-  Do not mount your device where it may hinder the function of safety devices, such as an airbag. Doing so may prevent the airbag from functioning accordingly in the event of an accident.
-  Mount your Satellite Radio where it can be easily reached.
-  The device must be directly in line-of-sight of the remote controller.
-  If you're not going to operate your vehicle for an extended period of time (e.g. parking garage while on vacation) unplug your XACT Visor Satellite Radio Receiver from the the cigarette lighter adapter.

**NOTE!** Do not modify or alter in any way the wires or connections especially to the 12v vehicle adapter. Doing so will prevent the protection provided in the circuitry from functioning properly and result in damaging your receiver. This will void your warranty.

## Activating Your SIRIUS® Subscription

Before beginning to use your new device, you must first register to the SIRIUS® Satellite Radio service.



There are two ways to activate the SIRIUS® Satellite Radio Service:

1. Visit [sirius.com](http://sirius.com) and click activate, then follow the on-screen instructions.
2. Call SIRIUS® at 1-888-539-7474. A representative will help you activate your SIRIUS® Satellite Radio Service.

**Note:** Make sure to have your identification number accessible when calling SIRIUS®.

## Make Note of Your Identification Number

Activating your SIRIUS® Satellite Radio Service:

1. Press the MENU button to enter the Menu Options settings.



2. Rotate the Channel Up/Down Rotary Dial until SIRIUS® ID is displayed and press the Select button inward to enter the sub menu. Your own device's 12-digit SIRIUS® ID Number (ESN) will be displayed on the screen.



# USING THE VEHICLE KIT

## INSTALLATION

### Mounting to the Dashboard or Console

**NOTE!** Use only the appropriate XACT accessories or input devices with your receiver. Use only the 12v Vehicle Adapter that is provided with the kit. It is important that you do not modify it in any way since this will result in damaging your equipment and void the warranty.

If using the AMP's mounting holes to fasten the Visor Vehicle Mount to your vehicle, Bolt or screw the Visor Vehicle Mount in place and proceed to step 3.

1. Remove the protective film from one side of the supplied double sided 3M tape. Press firmly to secure the tape to the bottom of the Visor Vehicle Mount. (figure 1).

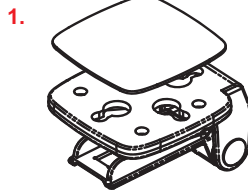

2. Remove the protective film from the remaining side of the double sided 3M tape. Place the mount in the appropriate location on the vehicle's dash or console and press firmly. (figure 2).

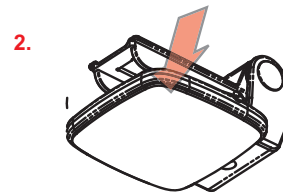

3. Slide the XACT Visor Satellite Radio Receiver onto the mounting tab of the Visor Vehicle Mount until it locks into place. (figure 3). To remove the XACT Visor Satellite Radio Receiver, push the locking tab on the bottom of the Visor inward and slide forward.

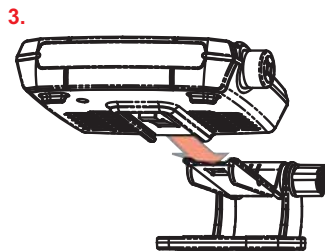

4. Connect the DC Power, antenna and audio (if required) to the appropriate jacks. (figure 4).

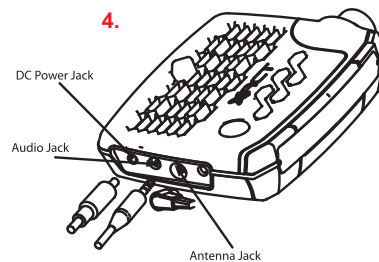

## INSTALLATION

### Mounting to the Windshield

**NOTE!** Use only the appropriate XACT accessories or input devices with your receiver. Use only the 12v Vehicle Adapter that is provided with the kit. It is important that you do not modify it in any way since this will result in damaging your equipment and void the warranty.

1. Insert the 4 suction cups into the larger side of the holes on the Visor Vehicle Mounting Bracket and slide outward to lock in place. (figure 1).
2. Loosen the thumb screw and rotate the Visor Mounting tab to the appropriate angle for your vehicle's windshield. Tighten the thumb screw. (figure 2).
3. Slide the XACT Visor Satellite Radio Receiver onto the mounting tab of the Visor Vehicle Mount until it locks into place. (figure 3). To remove the XACT Visor Satellite Radio Receiver, push the locking tab on the bottom of the Visor inward and slide forward.
4. Place the suction cups on the Visor Vehicle Mount in an appropriate location on your windshield. Press firmly to secure the Visor in place. (figure 4).
5. Connect the DC Power, antenna and audio (if required) to the appropriate jacks. (figure 5).

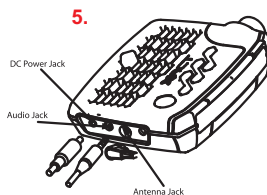
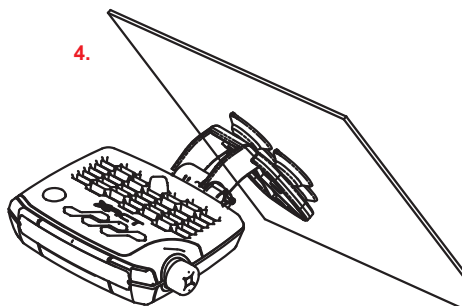
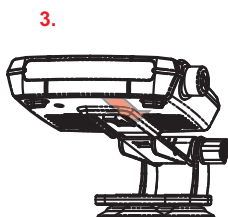
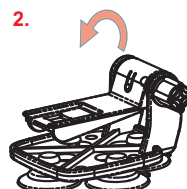
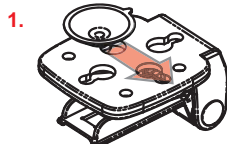

## INSTALLATION

### Mounting to the Sunvisor

**NOTE!** Use only the appropriate XACT accessories or input devices with your receiver. Use only the 12v Vehicle Adapter that is provided with the kit. It is important that you do not modify it in any way since this will result in damaging your equipment and void the warranty.

1. Slide the XACT Visor Satellite Radio Receiver onto the mounting tab of the Visor Vehicle Mount until it locks into place. (figure 1). To remove the XACT Visor Satellite Radio Receiver, push the locking tab on the bottom of the Visor inward and slide forward.

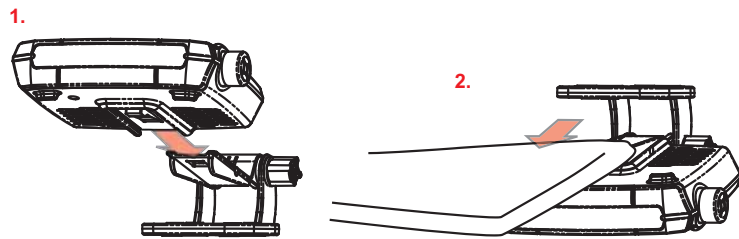

2. Loosen the thumb screw and slide the Visor Mount between the sunvisor and the vehicle's headliner. (figure 2).

3. Push the XACT Visor Satellite Radio Receiver up so it is flush with the bottom of the sunvisor and tighten the thumb screw. (figure 3).

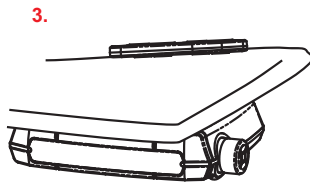

4. Connect the DC Power, antenna and audio (if required) to the appropriate jacks. (figure 4).

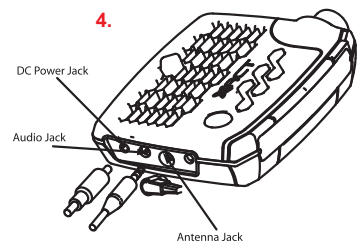

**Note:** Hardwiring is recommended. Care should be taken to ensure no obstruction of view, controls or safety equipment.

# IF YOU HAVE PURCHASED THE HOME KIT

## INSTALLATION

### Mounting in your Home

**NOTE!** Use only the appropriate XACT accessories or input devices with your receiver. Use only the 12v Vehicle Adapter that is provided with the kit. It is important that you do not modify it in any way since this will result in damaging your equipment and void the warranty.

1. Slide the XACT Visor Satellite Radio Receiver onto the mounting tab of the Visor Vehicle Mount until it locks into place. (figure 1). To remove the XACT Visor Satellite Radio Receiver, push the locking tab on the bottom of the Visor inward and slide forward.
2. Place the Visor Home Mount in an appropriate location on a table, desk, shelf, etc... (figure 2).
3. Connect the DC Power, antenna and audio (if required) to the appropriate jacks. (figure 3).

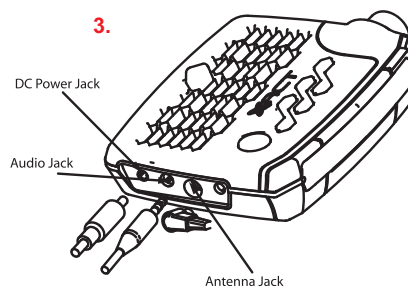
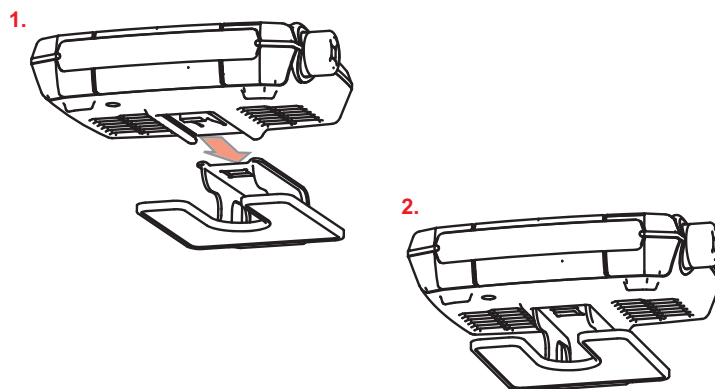

## BASIC OPERATIONS

After your SIRIUS® subscription is activated, the Normal (default) Operation screen will appear.



### Tuning to Different Entertainment Categories

1. Press the CATEGORY button to scroll through music and entertainment categories. Each press of the CATEGORY button advances to the next category. Press the Select button inward when the desired category is reached.



### Tuning to Different Channels in the Selected Category

2. Once you have chosen the desired category, rotate the Channel Up/Down Rotary Dial clockwise or counter clockwise until the desired channel is displayed. Press the Select button inward to tune to the desired channel.



**Note:** If the category or channel is not selected within 5 seconds, the XACT Visor Satellite Radio Receiver reverts to normal tuning mode.



### Direct Tuning (Remote Only)

Your XACT Visor Satellite Radio enables you to tune to a selected channel directly. This feature is only available through the Remote Control.



1. Press the DIR button on the Remote Control to activate the Direct Tuning mode.
2. The corresponding window is displayed and asks you to enter the desired channel number (3 digits).
3. The XACT Visor Satellite Radio Receiver will be tuned to your selected channel..

### Presetting Channels

Your XACT Visor Satellite Radio Receiver allows you to preset 36 channels. This design enables you to directly select between 6 different bands of preset channels (identified as A, B, C, D, E and F). Each band contains 6 specific channels (indicated as A-1, A-2, A-3...F-4, F-5 and F-6).

1. Tune to the channel you wish to store.
2. Press the BAND button to switch to your desired band (A-F) according to your preference.



3. Once the desired band is set, press and hold the 1, 2, 3, 4, 5, or 6 numerical buttons to store the specific channel. The Channel will now be recorded in memory.



**Note:** If a channel is already recorded into a preset, the new channel will overwrite the old one.

## MENU OPTIONS SETTINGS

The following options are included on the Menu Options list:

- SIRIUS® ID
- Display
- Factory Default
- Auto Shutoff
- Parental Block
- FM Transmitter

## BASIC SETTING PROCEDURE

1. Press the MENU button.
2. Rotate the Channel Up/Down Rotary Dial to select a desired menu option.
3. Press the Select button to enter into the selected menu option.
4. Set the menu option to your preference according to the steps described below.
5. To exit the menu option, press the MENU button.

### SIRIUS® ID

1. Press the MENU button to enter the Menu Options settings.



2. Rotate the Channel Up/Down Rotary Dial until SIRIUS® ID is displayed and press the Select button inward to enter the sub menu. Your own device's 12-digit SIRIUS® ID Number (ESN) will be displayed on the screen.



### Display Settings

1. Press the MENU button to enter the Menu Options settings.
2. Rotate the Channel Up/Down Rotary Dial until Display is shown and press the Select button inward to enter the sub menu.



The following options can be selected:

- Brightness Control
- Flip Display
- Contrast Control

### Brightness Control

1. Press the Select button to enter Brightness control.





2. A 10-segment horizontal bar graph is displayed. Rotate the Channel Up/Down Rotary Dial to adjust the dimming control function accordingly. Press the Select button to confirm the setting.

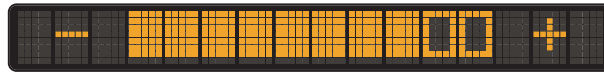

**Flip Display:**

1. Press the Select button to enter Flip Display.



2. Press the Select button to flip the screen upside down so that you may mount the unit on your vehicle's visor.



**Note:** You may also flip the display by pressing and holding the DISPLAY button on the XACT Visor Satellite Radio Receiver or the Remote Control for 2 seconds.

**Contrast Control:**

1. Press the Select button to enter Contrast control.





2. A 10-segment horizontal bar graph is displayed. Rotate the Channel Up/Down Rotary Dial to adjust the contrast control function accordingly. Press the Select button to confirm the setting.



**Factory Default**

The XACT Visor Satellite Radio Receiver can be reset.

- 1. Press the MENU button to enter the Menu Options settings.
- 2. Rotate the Channel Up/Down Rotary Dial until Factory Default is displayed and press the Select button inward to enter the sub menu.



3. Rotate the Channel Up/Down Rotary Dial until "Y" is selected press the Select button to continue.



4. Rotate the Channel Up/Down Rotary Dial until "Y" is selected press the Select button to confirm.

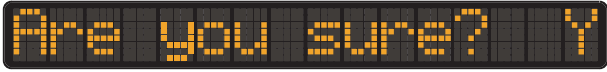

*Note: "Clearing" will display on the screen while performing Factory Default reset.*

Items revert to their original factory settings as follows:

All Presets revert to empty

Display Dimming to 80%

Flip Display to "Normal"

Display Contrast to 100%

FM Transmitter to "On"

Auto Shutdown "Off"

Lock Code Remains "Set"

Blocked channels remain Block

### **Auto Shutoff**

Your XACT Visor Satellite Radio Receiver will automatically turn off after an hour of inactivity. This feature is used when the vehicles cigarette lighter remains powered with the key off. Your XACT Visor Satellite Radio Receiver will power off even if you leave it powered on, conserving your vehicles battery. Pressing any button on the Xact Visor Satellite Radio Receiver or Remote Control will reset the Auto Shutoff feature.

1. Press the MENU button to enter the Menu Options settings.
2. Rotate the Channel Up/Down Rotary Dial until Auto Shutoff is displayed and press the Select button inward to enter the sub menu.



Auto Shutoff

3. Rotate the Channel Up/Down Rotary Dial until "Y" is selected press the Select button to confirm.



Auto Shutoff? Y

4. Rotate the Channel Up/Down Rotary Dial until "N" is selected press the Select button to confirm.



Auto Shutoff? N

## Parental Block

Access to particular channels can be set with a 3 digit code. When you attempt to tune to these particular channels, your receiver will require you to enter the access passcode.

1. Press the MENU button to enter the Menu Options settings.
2. Rotate the Channel Up/Down Rotary Dial until Parental Block is displayed and press the Select button inward to enter the sub menu.



The following options can be selected:

- Block
- UnBlock
- Edit Code (Default Code "000")

## Block

1. Rotate the Channel Up/Down Rotary Dial to scroll to Block and press the Select button inward to enter channel Block.



2. Rotate the Channel Up/Down Rotary Dial to scroll through numbers 0-9 until the first digit of your code is reached. Press the Select button inward to enter the number and move to the next digit.





3. Rotate the Channel Up/Down Rotary Dial to scroll to the channel you wish to block.



4. Press the Select button to block.



#### **UnBlock**

1. Rotate the Channel Up/Down Rotary Dial to scroll to UnBlock and press the Select button inward to enter channel UnBlock.



2. Rotate the Channel Up/Down Rotary Dial to scroll through numbers 0-9 until the first digit of your code is reached. Press the Select button inward to enter the number and move to the next digit.



3. Rotate the Channel Up/Down Rotary Dial to scroll to the channel you wish to unblock.



4. Press the Select button to unblock the channel.







**Edit Code**

1. Rotate the Channel Up/Down Rotary Dial to scroll to Edit Code and press the Select button inward to enter Edit Code.



2. Rotate the Channel Up/Down Rotary Dial to scroll through numbers 0-9 until the first digit of your code is reached. Press the Select button inward to enter the number and move to the next digit.



3. Entering your new code. Rotate the Channel Up/Down Rotary Dial to scroll through numbers 0-9 until the first digit of your new code is reached. Press the Select button inward to enter the number and move to the next digit.



4. Confirm your new code. Rotate the Channel Up/Down Rotary Dial to scroll through numbers 0-9 until the first digit of your new code is reached. Press the Select button inward to enter the number and move to the next digit.



### FM Transmitter

The FM Transmitter allows your XACT Visor Satellite Radio Receiver to transmit music to your car or home FM radio.

1. Press the MENU button to enter the Menu Options settings.
2. Rotate the Channel Up/Down Rotary Dial until FM Transmitter is displayed and press the Select button inward to enter the sub menu.



FM Transmitter

3. Rotate the Channel Up/Down Rotary Dial until "On" is selected press the Select button to continue.



FM Trans? On

4. Rotate the Channel Up/Down Rotary Dial until an FM Channel that is not being used by an FM Broadcaster in your area is displayed. Press the Select Button to set the FM Channel.



FM Channel 99.1

## DISPLAY MESSAGES

### Acquiring Signal

When the audio signal is lost, the flashing message “Acquiring Signal” is displayed until the signal is recovered.



Acquiring Signal

### No Antenna

When no antenna is detected and the signal is lost, the flashing message “No Antenna” is displayed until an antenna is detected and the signal is acquired.



No Antenna

### Updating Channels

When a channel or category update from the SIRIUS® broadcast system is detected, “Updating Chs X%” is displayed until the update is complete.



Updating Chs 20%

### Subscription Updated

When a subscription update from the SIRIUS® broadcast system is detected, “Subscription updated press any key to continue” will scroll until you press any button.



Subscription Upd



**Mute**

A single press of the “Mute” button on the Remote Control (see diagram on page 5 for the location of the button) will disable all audio from your device.



**UnMute**

A single press of the “Mute” button on the Remote Control (see diagram on page 5 for the location of the button) will enable all audio from your device.



**Clearing**

When performing Factory Default the flashing message “Clearing” is displayed until the reset is complete.



# PROBLEM SOLVING

## Problem Solving Section

**For your assistance, we have listed a few common problems below.**

### **The XACT Visor Satellite Radio Receiver does not work.**

Please check the Power Cables. Make sure you have contacted SIRIUS® to activate your Satellite Radio subscription 1-888-539-SIRIUS (7474).

### **I have no sound from my XACT Visor Satellite Radio Receiver.**

Check the audio cables and make sure they are plugged in correctly.

Check the FM Transmitter Setting and make sure that your FM radio is set to the correct channel.

### **The LCD displays Acquiring Signal.**

When the audio signal is lost the flashing message "Acquiring Signal" is displayed until the signal is recovered.

### **The LCD Displays No Antenna.**

When no antenna is detected and the signal is lost, the flashing message "No Antenna" is displayed until an antenna is detected and the signal is acquired.

### **Reception is weak or the audio has static and is unclear.**

Change the location of the Antenna making sure it is away from obstructions.

# WARRANTY

## Warranty Information

### XACT Communication

One-Year Limited Warranty

This limited warranty sets forth all **XACT Communication** responsibilities regarding your product. There are no other expressed or implied warranties from **XACT Communication**.

### Warranty Service Provided

If you purchased the product new from a retail vendor, **XACT Communication** warrants the equipment against defects in material and workmanship for a period of one (1) year from the original date of purchase. This warranty is in lieu of all other expressed warranties. This warranty begins when you purchase the product and continues for one (1) year unless you sell or rent the unit, in which case the warranty stops.

**XACT Communication** disclaims any implied warranty, including the warranty of merchantability and the warranty of fitness for a particular purpose, as of the date of one year from your original purchase of the product. **XACT Communication** assumes no responsibility for any special, incidental, or consequential damages.

This warranty gives you specific legal rights and you may have other rights which vary from state to state. Some states do not allow the exclusion or limitations of special, incidental, or consequential damages or limitations on how long a warranty lasts, so the above exclusion or limitation may not apply to you.

### Warranty Service Not Provided

This warranty does not cover damage resulting from accident, misuse, abuse, improper installation or operation, lack of reasonable care, unauthorized modification, or the affixing of any attachment not provided by **XACT Communication** with the equipment, and/or loss of parts. This warranty is voided in the event any unauthorized person opens, alters, or repairs the product.

All **XACT Communication** equipment being returned for repair must be suitably packaged.

# WARRANTY

## What To Do for Warranty Service

During the first thirty (30) days, a defective product is eligible for over-the-counter exchange at the retailer from whom it was purchased. After thirty (30) days, the defective product should be returned to the authorized service center. Please allow a minimum of 2-3 weeks for the return of your product. For the shipping address of the authorized service center, call one of the telephone numbers given below.

Your product will be repaired or replaced if examination by the service center determines the product is defective. Products received damaged as a result of shipping will require you to file a claim with the carrier prior to repair. A product received with missing parts or with damage due to abuse, inadequate packing or some other noncompliance with this limited warranty will be returned to you C.O.D., freight collect.

**NOTE:** A product received which was not made by **XACT Communication** or which is not defective as determined by our test procedures will not be repaired and will be returned to you C.O.D., freight collect.

## To Obtain Warranty Service

- Provide proof of the date of purchase within the package.
- Prepay all shipping costs to the authorized service center.
- Include a return shipping address within the package.

Please retain your sales receipt, the carton, the packing materials, and the printed material. The original carton is the best shipping container for the Product should you have to return it.

## For your reference:

Model Number \_\_\_\_\_ SID/ESN Number \_\_\_\_\_  
S/N Number \_\_\_\_\_ Date of Purchase \_\_\_\_\_  
Name of Dealer \_\_\_\_\_

**XACT Communication Customer Service Telephone Number:  
1-866-466-XACT (9228)**

**OUTSIDE THE U.S.A. AND CANADA CALL: 1-212-481-7950**

**Visit Us on the Web: [www.getxact.com](http://www.getxact.com)**

To activate your XACT Visor Satellite Radio Receiver or for latest news and questions regarding SIRIUS® Satellite Radio service visit [sirius.com](http://sirius.com) or call 1-888-539-SIRIUS (7474).

**XACT™**

**SIRIUS**  
SATELLITE RADIO

Call Toll Free 1-866-466-XACT (9228)  
or Visit our Website:

[www.getxact.com](http://www.getxact.com)