

2. CONTENTS

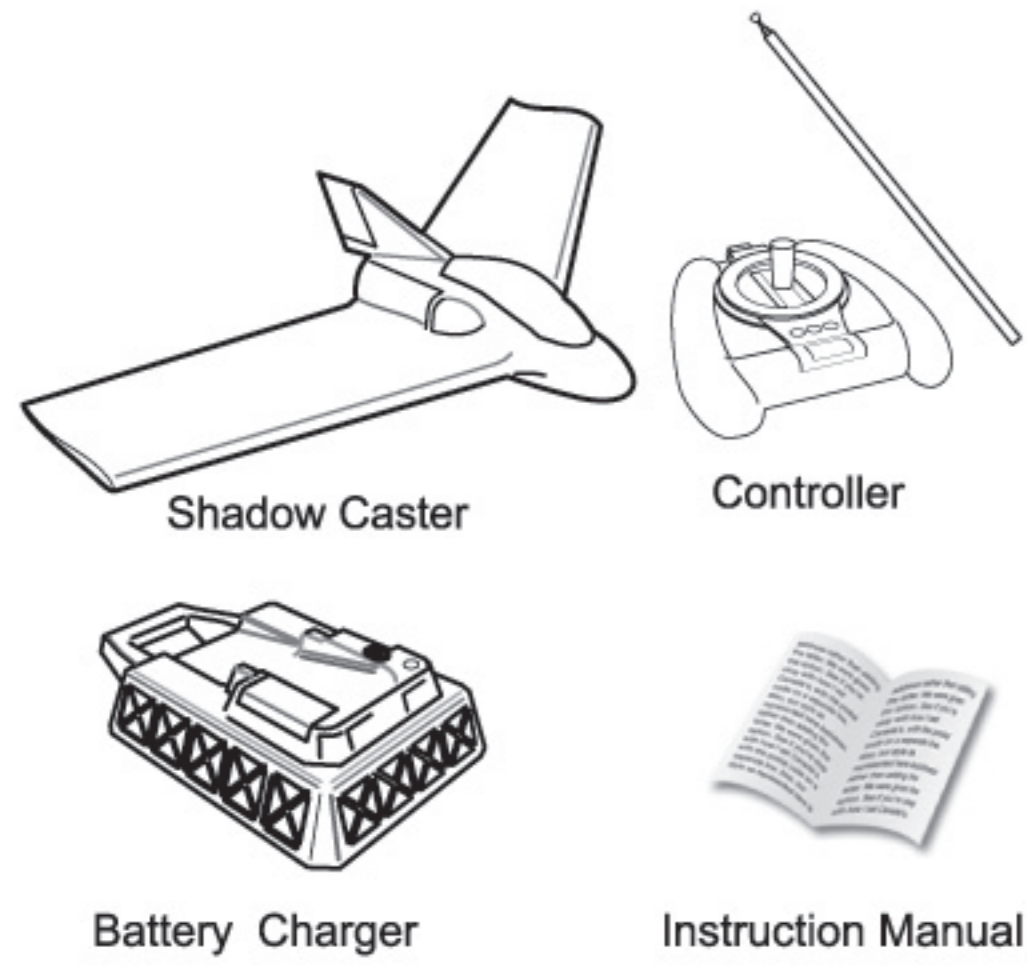

Batteries required:
10 x "C", 1 x "9v" (sold separately)
Full charge will take 5min 30sec .

3. NAME OF THE PARTS

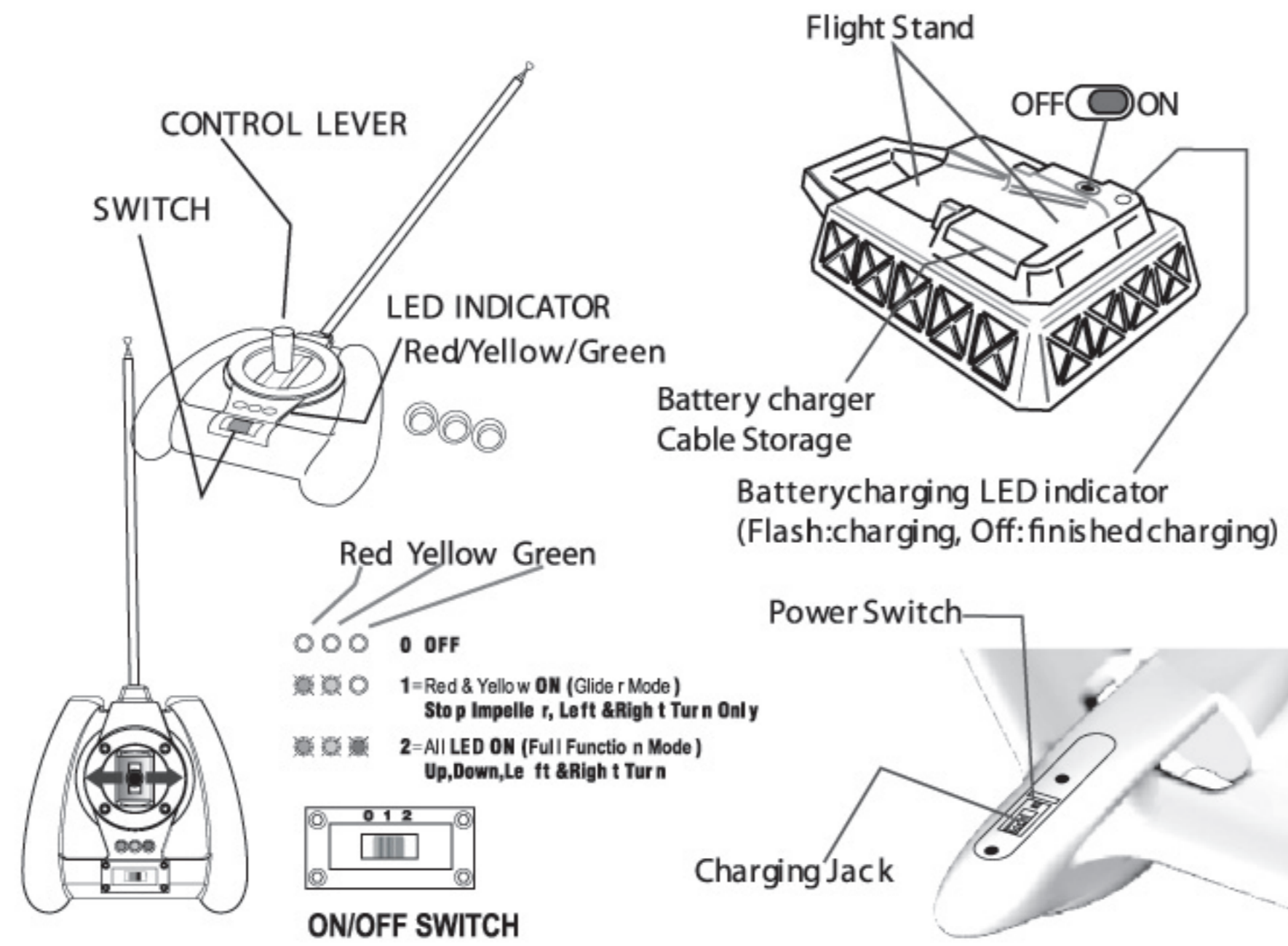

Red Yellow Green

0 OFF

1-Red & Yellow ON (Glide r Mode)
Stop Impeller, Left & Right Turn Only

2-All LED ON (Full Function Mode)
Up, Down, Left & Right Turn

4. HOW TO ATTACH THE ANTENNA/INSERTING THE BATTERIES

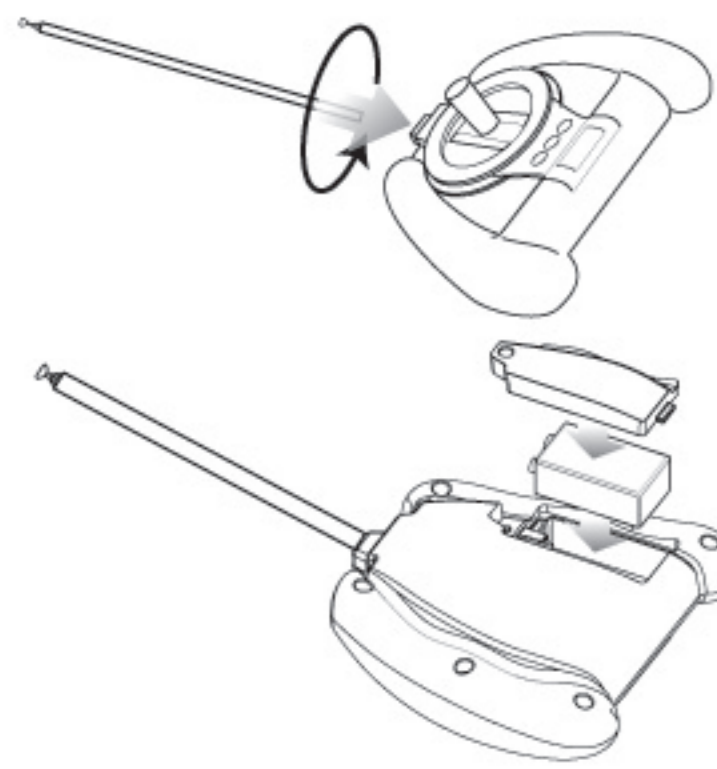

How to attach the antenna
Insert the antenna into the top of the controller and turn clockwise until tight.

How to insert batteries into controller
a. Use a Phillips screwdriver to open the battery box cover.
b. Insert one 9 volt battery, aligned to the (+) (-) signs as indicated.
c. Replace cover and tighten snugly using screwdriver.

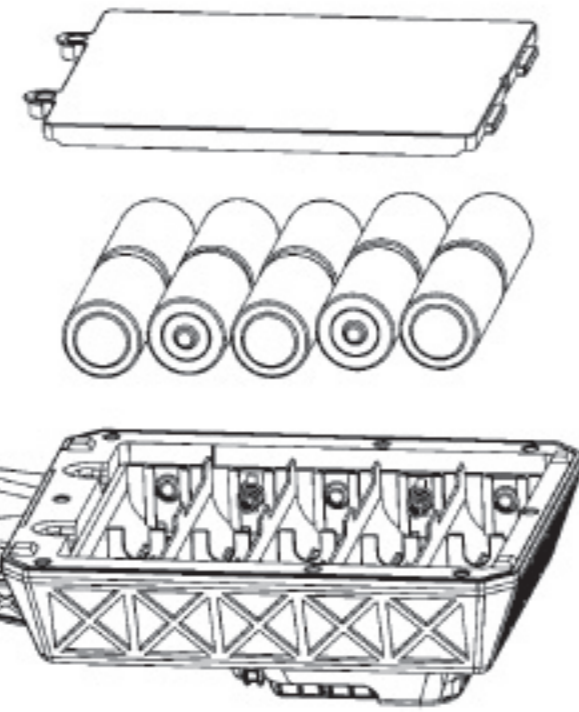

How to insert the batteries into the battery charger
a. Use a Phillips screwdriver to open the battery box cover.
b. Insert 10 x "C" batteries battery aligned to the (+) (-) signs as indicated.
c. Replace cover and tighten snugly using screwdriver.

5. HOW TO CHARGE THE SHADOW CASTER

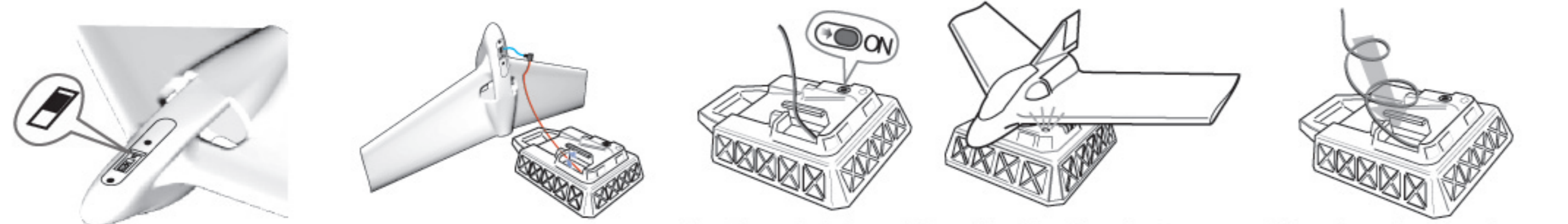

Turn the power switch to off position on both the Shadow Caster and the charger . If either is turned on, the Shadow Caster will not charge.

Insert the cable from the battery charger into the charging jack of the Shadow Caster.

After the cable is attached to the Shadow Caster, turn on the power switch on the battery charger.

Place the Shadow Caster on the charging platform. While the plane is charging the Red LED will be flashing. Once the plane is fully charged, the LED light will turn off.

After charging the plane, remove the cable from the Shadow Caster and wrap the cable to the storage compartment.

6. CAUTION

1 Play in an open field where there are no obstacles such as buildings, trees or power cables, and where there are no people, animals or vehicles. DO NOT play near power cables, railways or roads. It is recommended to play on grass, as this will reduce the impact of a fall or of a normal landing.

2 Play on clear or partly cloudy days where there is no strong wind, as this will cause difficulty in maneuvering. DO NOT play when it is raining, snowing, thundering, or in strong wind or other bad weather conditions. DO NOT play when the outside temperature is below 45 degree fahrenheit.

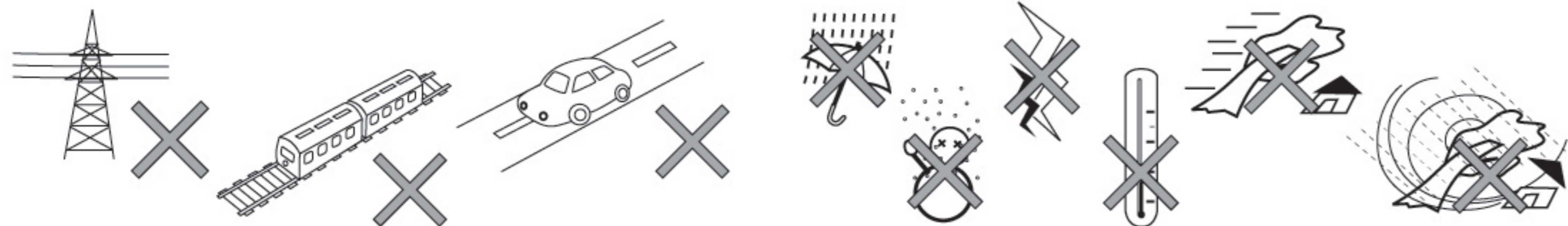

7. HOW TO USE YOUR RC SHADOW CASTER

Turn on the Shadow Caster



Extend the antenna of the controller and turn on the controller (the controller LED indicator will glow bright). Holding the Shadow Caster by its body and facing away from any person or obstacle, push the control lever forwards. The impeller will start to spin.

How to maneuver the controller

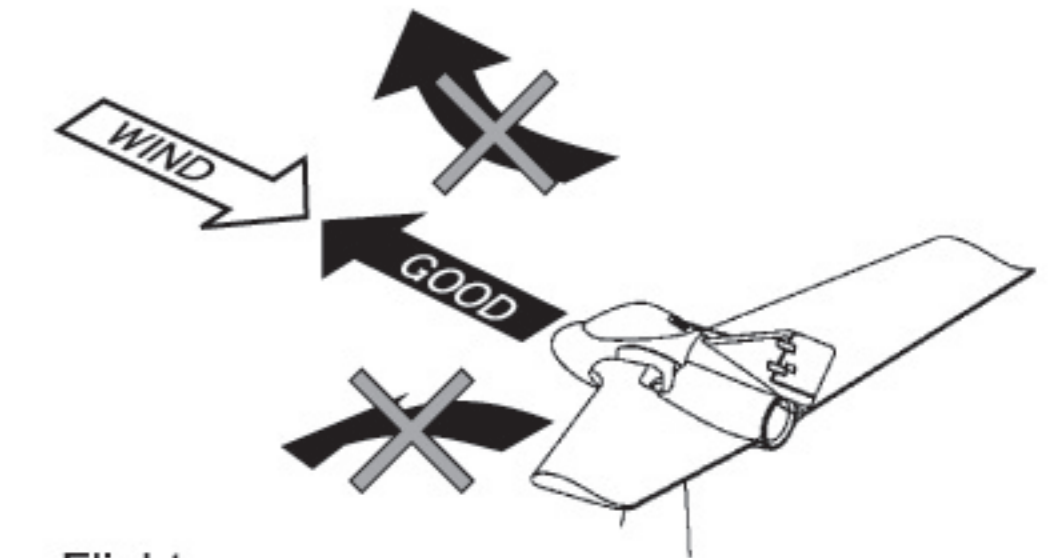
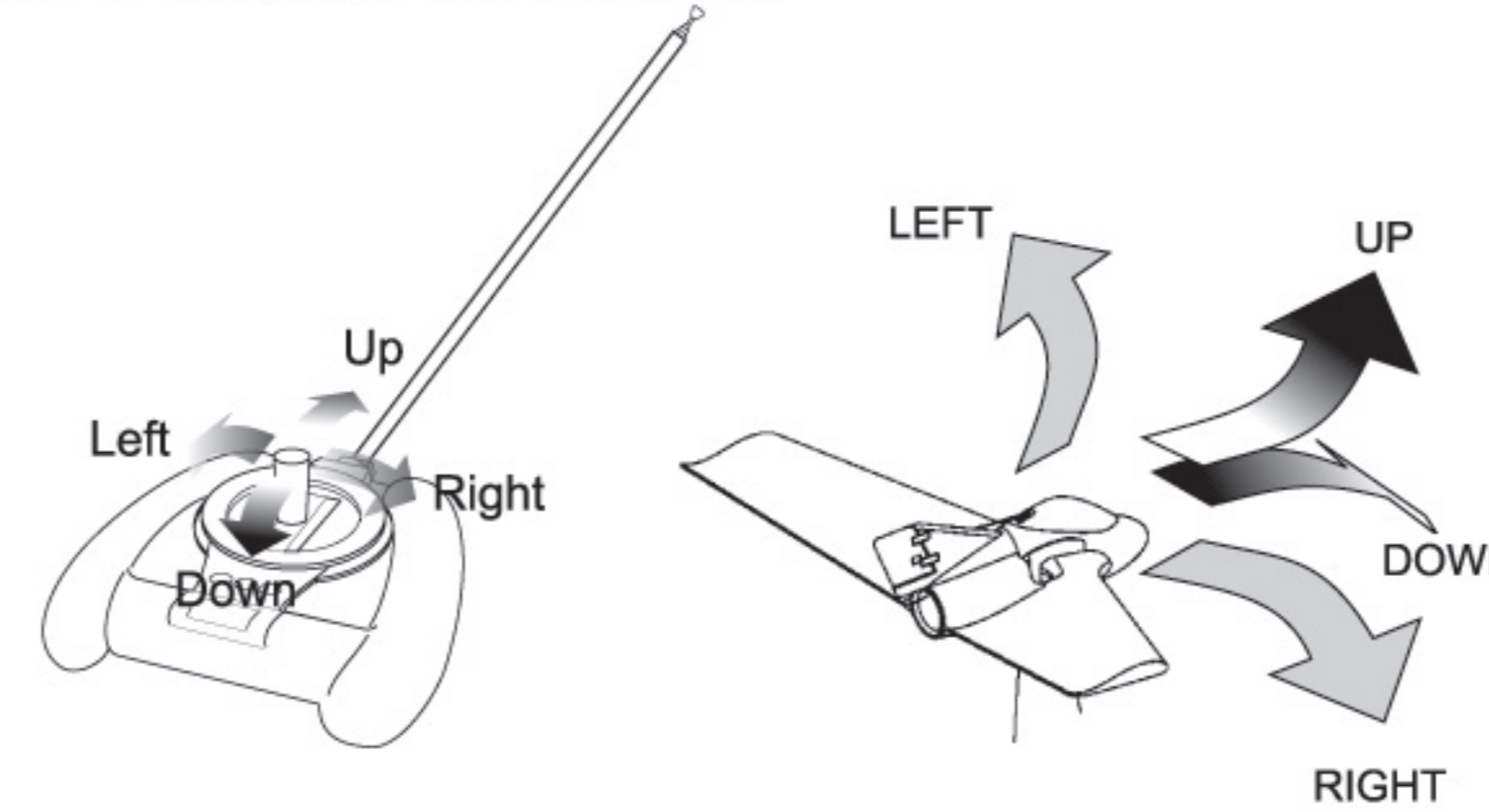

Flight
1) Aiming the Shadow Caster into the wind, throw it horizontally , gently.
2) Ensure that the Shadow Caster antenna wire is straight and not bent.

LANDING

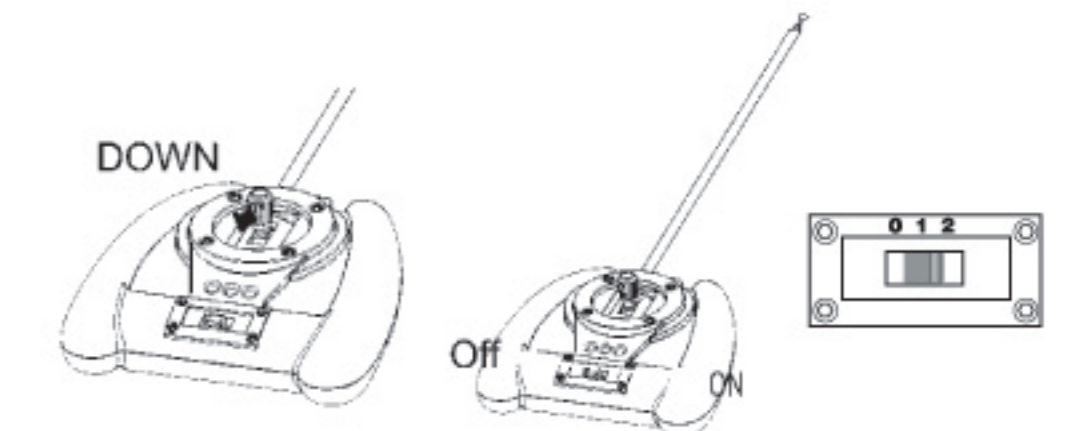

Set the lever on the controller to the DOWN position and the Shadow Caster will start to descend. Control the Shadow Caster to land on a soft surface such as a lawn.
As soon as the Shadow Caster lands, turn off the plane and slide the remote switch to position 1. This will stop the impeller.

8. HELPFUL TIPS

1. Avoid pushing the control level until the Shadow Caster flies about 15 feet high.

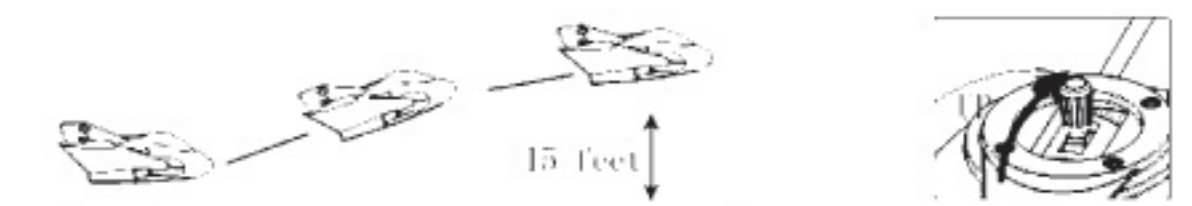

2. Avoid a stall: When the Shadow Caster is directed upward, it will start gaining altitude. However, it will eventually turn straight up and stall, resulting in a fall. To avoid this, please push the controller lever back to its CENTER or DOWN position until the Shadow Caster is parallel to the ground.

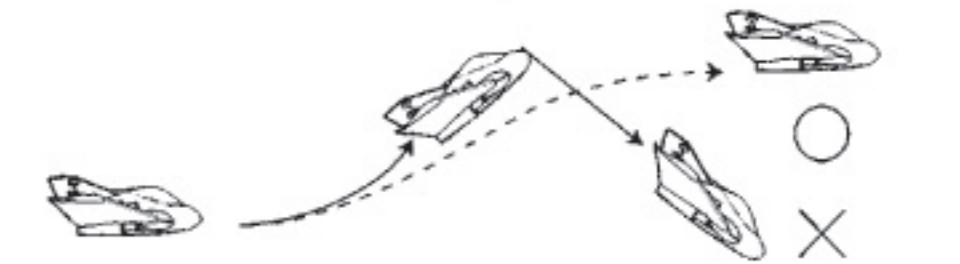

3. Correcting Windshear: When the Shadow Caster is flying straight and there is a sudden wind, its course will be disturbed. Set the control lever to the opposite direction in order to put the Shadow Caster back on course. For example, when the wind pushes the Shadow Caster leftward, set the control lever to RIGHT , and vice versa.

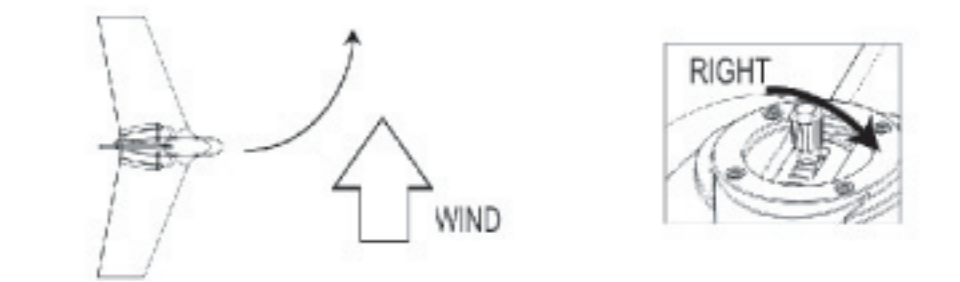

4. Turning: When the control lever is set to right or left, the Shadow Caster will turn in that direction, but will eventually start circling and will start losing altitude unless the control lever is pulled to CENTER occasionally. For example, when making a rightward circular flight, try setting the lever to RIGHT and to CENTER repeatedly.

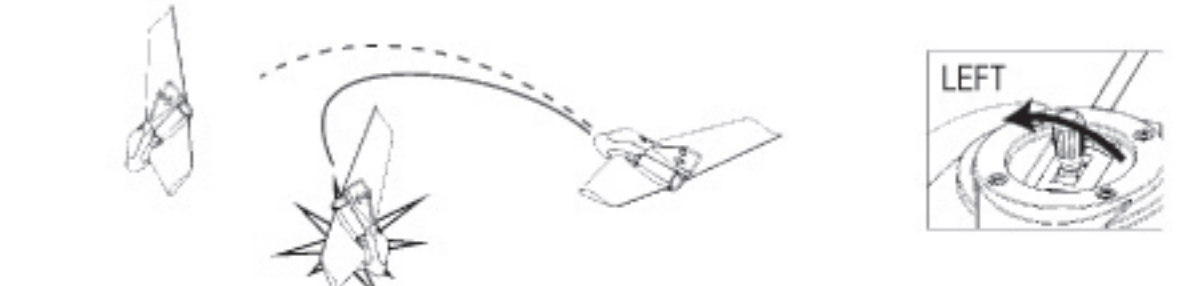

Ending circle: Push the control lever back to CENTER. Pushing the control lever in the opposite direction of the circling will return the Shadow Caster to straight flight faste

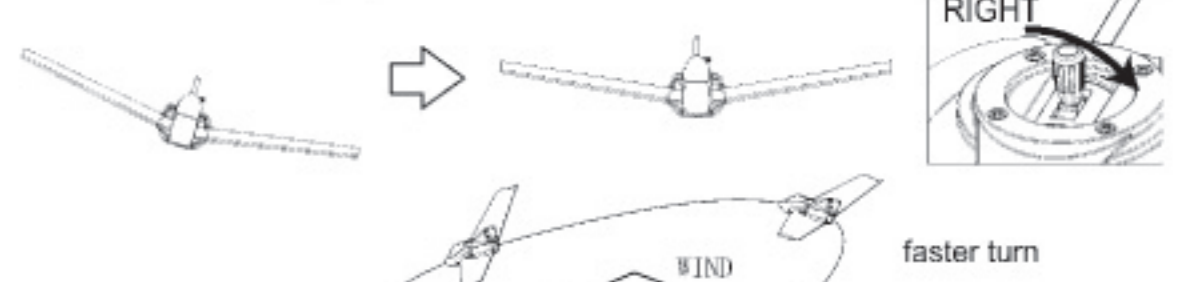

Flying into the wind: When flying into the wind, the Shadow Caster makes a faster turn than when flying with a tailwind.

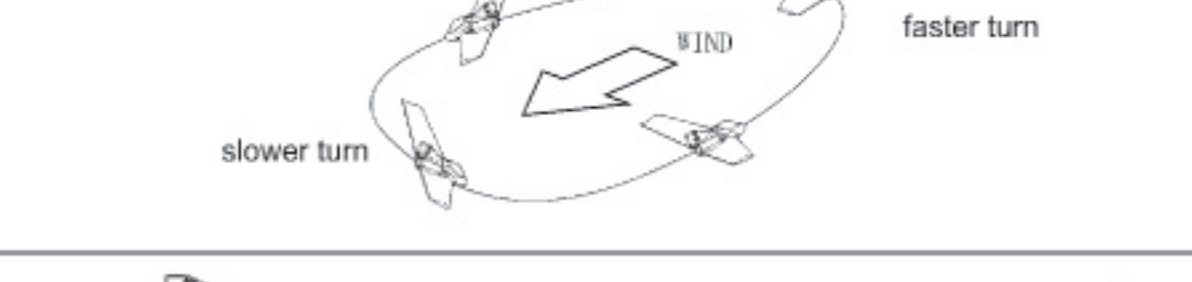

5. Landing: Aiming the Shadow Caster into the wind with the lever in CENTER position will cause it to descend slowly. When the Shadow Caster is about 2 feet of the ground set the lever to DOWN to complete the landing.

