

---

# PC7077ME USER MANUAL



Brand Name: Kinwei  
FCC ID: BRCPC7077ME

---

# Content

1. Preface
2. Safety Notices
3. Ready to Use
  - 3.1 Packing List
  - 3.2 Product Appearance
  - 3.3 Instructions on Keys
  - 3.4 Features Overview
4. Quick Guides
  - 4.1 Switch On/Off
  - 4.2 Battery Management and Charging
  - 4.3 Operation of the Function Icons
  - 4.4 Operation of the Function Icons on parent interface
5. Operation Details
  - 5.1.1 Music Player
  - 5.1.2 Video
  - 5.1.3 Gallery
  - 5.1.4 Recording
  - 5.1.5 File Manager
  - 5.1.6 Web Browser
  - 5.1.7 Calculator
  - 5.1.8 Clock
  - 5.1.9 Camera
  - 5.2.0 tf (Micro sd) Card Storage
  - 5.2.1 APK Install and Manage
  - 5.2.2 External Keyboard & Mouse:
6. System setting
  - 6.1.1 WIFI Setting
  - 6.1.2 External 3G USB Dongle:
  - 6.1.3 External RJ45 USB Dongle
  - 6.1.4 Sound
  - 6.1.5 Display and wall paper
  - 6.1.6 Screenshot
  - 6.1.7 Storage
  - 6.1.8 Battery
  - 6.1.9 Apps
  - 6.2.0 Location & security
  - 6.2.1 Language & input
  - 6.2.2 Backup & reset
  - 6.2.3 Date & time
  - 6.2.4 Accessibility
  - 6.2.5 Developer options
  - 6.2.6 About tablet

---

## 6.2.7 Add, Move or Delete Desktop Icon

## 7. Firmware Upgrade

## 8. Troubleshooting and FAQ

### 1. Preface

Dear Customers,

Thanks very much for purchasing our product!

This Tablet PC is a built-in high performance Wi-Fi receiver module, supporting an external 3G USB-DONGLE wireless network card, using broadband wireless networks, breaking through the restraint of network cables; it will bring you into the portable media player world and fulfill your entertainment needs. It also supports picture browsing, e-book reading, games, online chat and other functions; various settings will fully show your individuality.

To operate this player easily, first, please read this User Manual included with the player. Then you will have a better understanding of the operations. Before operating this player, please carefully read all data we provide about the player, so that you will have a better understanding of the product and its operations.

The Company will not be responsible for any loss of personal data and damage caused by incorrect operation of the Software/Hardware, artificial damages, replacement of batteries or any other accident. To avoid loss of your data, please backup your data to your computer at all times.

Also, since we can not control any dispute from users' misunderstanding or incorrect operation against the manual, the Company will not take any relevant responsibility for any accidental loss potentially occurring in the process of using this manual.

Due to constant product development, the information in this manual is subject to change without any prior notice.

This manual is protected by copyright and no part is permitted to be copied or reproduced in any way without prior written permission of the Company.

The Company reserves the final explanation right of this manual, warranty as well as its related information.

(Note: When compiling this manual, we are very careful to provide you completely reliable information. However, there is inevitably some error and oversight, please understand, and we welcome your suggestions. If any problem occurs during your use of this product, please immediately contact your local seller)

Thanks for your support and please pay attention to our other products.

### 2. Safety Notices

- 1) Please keep the Tablet PC away from strong magnetic fields in order to avoid damage to the product.
- 2) Please do not let the Tablet PC fall onto, rub against or knock against hard objects during use, because this may cause surface scratches on the Tablet PC, battery damage, data loss or other damage to the hardware.
- 3) Never let this product be exposed to a humid environment or rain as the water leaking into the Tablet PC could disable it to the extent of being beyond repair.
- 4) Never clean the Tablet PC with any chemicals or detergent, these will damage the product surface and corrode the finish.
- 5) You are recommended not to use the headset with the volume at its highest settings, please adjust the volume to an appropriate safe level and limit the amount of time you spend using headphones to avoid possible damage to your hearing. Excessive volume will cause permanent hearing damage.
- 6) Please do not cut off the power abruptly during software updates or downloading, because this may cause

---

data loss or system errors.

- 7) Over-voltage, power cable strain and bending or squeezing of the power cable by heavy objects must be avoided to prevent the possibility of overheating or fire.
  - 8) In order to eliminate the risk of electric shock, do not touch the cable power plug with wet hands.
  - 9) Some movies, music and pictures are under the protection of copyright, unauthorized usage is deemed as an infringement to the laws of copyright.
  - 10) Please don't turn on the Tablet PC on in locations where wireless equipment is forbidden or when the usage of the Tablet PC will cause interference and possible danger.
  - 11) All the wireless equipment is subject to external interference and this can affect its performance.
  - 12) Please comply with any related restrictions and rules, wireless equipment can influence the flight of the plane; please consult the relevant airline company if you intend to use the Tablet PC on a plane.
  - 13) Please don't use the Tablet PC in a petrol station, or near to fuel or chemicals.
  - 14) Please comply with any related restrictions and rules; do not use the Tablet PC where blasting operations are in progress.
  - 15) Only qualified maintenance personnel can install or repair the Tablet PC. Opening the Tablet PC in any way will invalidate the warranty.
  - 16) Please use the original accessories and battery provided with the Tablet PC, do not use the incompatible products.
  - 17) The Tablet PC is not waterproof, please keep it dry.
  - 18) For the sake of data safety, please back up any important information on the Tablet PC, or keep a handwritten record.
  - 19) When the Tablet PC is connecting with other devices, please read the user manual for detailed safety instructions. Don't connect the Tablet PC to incompatible products.
  - 20) Please upgrade device with enclosed optical disk when the device is set to operate in a different way.
- Note: Android4.2 system using the MTP protocol transfer files, rather than the original MSC agreement (ordinary U disk), currently supports the MTP protocol only (10) in Windows Media Player and Media Player, Windows Media Player 11) and older version. If there are no updates to the above two versions of the Player, the computer will not recognize MID or existing file cannot be copied down, etc., please correct in the computer, which is connected with the MID above installed version of the Player, can be installed to the computer, do not need to run for connection to the mid.

### 3. Ready to Use

#### 3.1 Packing list

Components	Quantity
MID Device	1
Leather Case (Optional)	1
Keyboard/Mouse (Optional)	1
TF card ( Optional )	1
Power Adaptor	1
Earphone	1
USB Cable	1
HOST cable(optional )	1
3G USB Dongle( optional )	1
RJ45 USB Dongle( optional )	1
User Manual	1
CD-ROM	1
Warranty Card	1

#### 3.2 Product Appearance

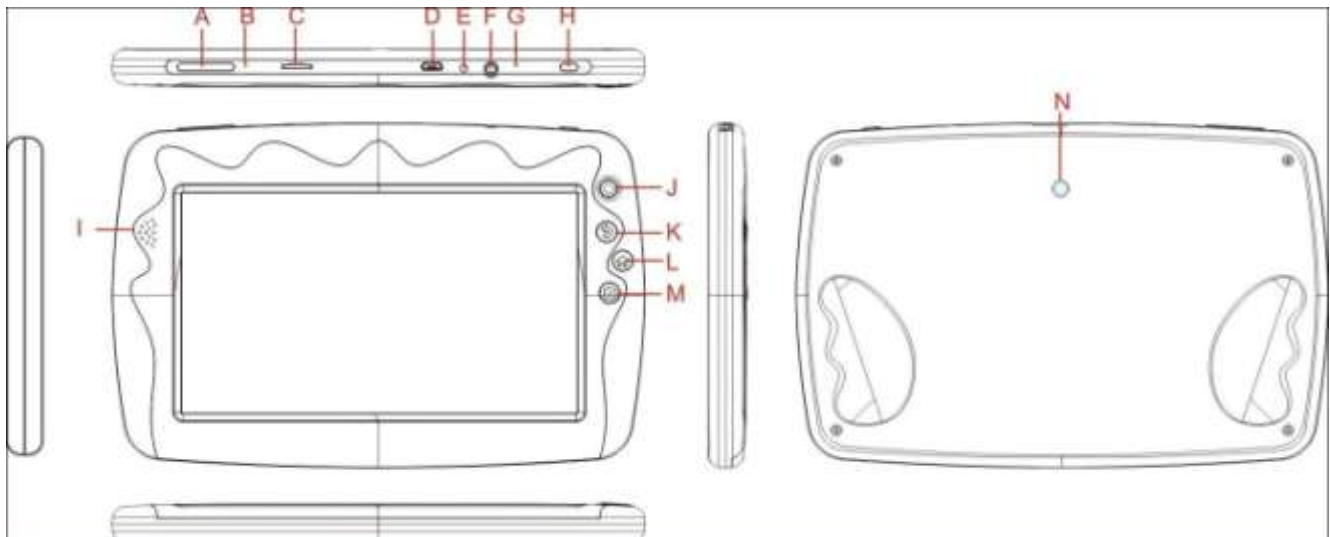

#### 3.3 Instructions on Keys

Symbol	Name	Description
A	volume	volume switch

B	RESET	When tablet does not work press the system reset function
C	TF card	TF card slot
D	USB/OTG/	MIC_5PIN slot
E	5VDC	5VDC charging port
F	Earphone Jack	Earphone Jack
G	MIC	microphone record hole
H	POWER	Short press the button to enter sleeping/wake up mode, long press to switch ON/OFF
I	speaker	High fidelity speaker
J	Camera	Front Camera
K	ESC	Short press to return
L	MENU	Short press the button to enter menu function
M	Snapshot	After the camera is turned on, press this button to take pictures
N	Camera	Rear Camera

### 3.4 Features Overview:

- ✧ Adopts Rockchip RK2926 as the main chip, ARM Cortex A9, max frequency at 1.0GHz. GPU Mail-400MP2 , support ANDROID 4.2;
- ✧ Support RAM 512M/1G DDR3 (optional);
- ✧ Build-in ROM Flash, 4GB/8GB/16GB/32GB (optional),
- ✧ Support max 32GB TF card
- ✧ 7 inch TFT Screen 1024\*600 (optional), capacitive multi-point touch.
- ✧ Support MPEG-1, MPEG-2, MPEG-4, H.263, H.264, AVS, VC-1, RV etc audio formats, Max resolution support: 1920\*1080/60fps.
- ✧ Support JPG、JPEG、BMP、GIF、PNG、JFIF etc picture format, max resolution support:8000\*8000.
- ✧ Support MP1、MP2、MP3、WMA、WAV、OGG、OGA、APE、FLAC、AAC、M4A、3GPP etc audio formats and multi EQ modes, and support Lyrics synchronized display or full-page display.
- ✧ Support TXT、LRC、PDF、Html、Htm、EPUB etc file formats, supports auto-browse, zoom, bookmarks, flip over functions
- ✧ Wi-Fi ready, you can connect with broadband wireless internet and operate various software in the Android 4.2 OS, the system preset parts of third software: Google browser, Online MP3, online novel, online video, E-book, etc
- ✧ Supports USB-HOST function for external U-disk, Keyboard, Mouse & 3g dongle etc.
- ✧ Built-in 0.3MP front camera and 0.3MP back camera.
- ✧ Supports G-sensor screen rotation function
- ✧ Supports built-in speaker and external stereo earphone
- ✧ Supports multiple languages
- ✧ USB disk, WIN\_2000 above system driver for free

### Technical Specifications

display	size	7 inch TFT screen
	resolution	1024*600
Interface	USB port, USB OTG 2.0/USB Host2.0 (MIC 5PIN shift 4PIN HOST)	
CPU	RK3026, ARM Cortex A9 Max frequency 1.0GHz	
Built-in Flash	Flash Memory : 8GB	
Built-in RAM	ROM: DDRIII 1GB	
Capacity Expansion	Support TF Card 1GB~32GB	
Power Supply	Built-in 3.7V@2500mAH (still in pending) Lithium rechargeable battery; output:DC5V/2A Adaptor	
Music Function	Play format	MP1、MP2、MP3、WMA、WAV、OGG、OGA、APE、FLAC、AAC、M4A、3GPP
	Headset max. output	(L) 5mW+ (R) 5mW (32Ohm)
	MP3 Bit rate	8Kbps ~ 392 Kbps
	WMA, WMV, Bit rate	5Kbps ~ 192 Kbps
	Frequency response	20Hz-20KHz
	SN ratio	90dB
	Distortion	<0.05%
Video Function	Play format	MPEG-1, MPEG-2,MPEG-4, H.263, H.264, AVS, VC-1, RV,etc
	Max Resolution	1920*1080
	Ratio	4: 3、16: 9、full screen optional.
Photo Browse	Support JPG、JPEG、BMP、GIF、PNG、JFIF, max resolution support: 8000*8000.	
E-book	Format	TXT、LRC、PDF、Html、Htm、EPUB etc.
	Max. capacit	5M
WIFI	Main chipset	NMC1000
	Transmission rate	Max54Mbps
	Transmission range	Max100m
	Frequency	b/g/n
Format	Format	WAV
Working temperature	-10 ~ 50 °C	
Supported OS	Windows2000/XP/WIN7/Vista Mac OS V9.0/10.0	

## 4. Quick Guides

### 4.1 Switch On/Off

●**Switch ON:** When the Tablet PC is in OFF mode, please press and hold the “POWER” key for 3 seconds .First start, the machine will enter the system desktop with boot screen, then it will enter parents using guide interface. Parents can set the requirements (Note: This is the most critical set a password). After completing the above operation, it will enter kid's System Interface. .



(Boot screen)



(kid's System Interface)

- **Unlock:** Please press and move the icon , the display will unlock automatically
- **Power Saving Mode and Locked Mode:** Pressing the “POWER” key when the Tablet PC is in use will result in the system entering SLEEP power save and locked mode. Press the “POWER” key, the Tablet PC will return the system to unlocked mode within 2 second.
- **Switch OFF:** When the Tablet PC is in use, please press and hold the “POWER” key for 3 seconds, the screen will display the power off interface, choose the power off option to confirm your selection and the system will shut down automatically.

#### 4.2 Battery Management and Charging

A Charge the battery at least 8-12 hours to make sure the battery is fully charged for the first time.

B Insert the adaptor into the DC slot on the Tablet PC, and connect the other side with the power socket. Then the Power indicating lamp on the top right side of the Tablet PC will turn purple, and the desktop icon of the battery  keeps rolling to show it is charging. Note: Please wait until the battery is fully charged and do not disconnect the adaptor when charging.

•Once the battery is fully charged, the indicating lamp will change into blue, the Icon on the desktop  will



---

stop rolling.

C When the battery is exhausted completely; please charge at least 1 minute before starting it up.

Note: In order to keep the battery working to its full potential, please pay attention to the following advice:

- 1) Don't charge the power in excessively high temperatures.
- 2) There is no need to run down the power for this Li-ion battery, you can charge the battery even when there is still power left in the battery without it affecting the lifespan of the battery.
- 3) In order to keep the battery in good condition, Make sure you charge it at least once every two weeks if the Tablet PC hasn't been used for a long time.

### 4.3 Operation of the Function Icons

◆ Operation of the Function Icons on kids interface



- Select Multimedia icon to enter, display the audio player and video player two application icons

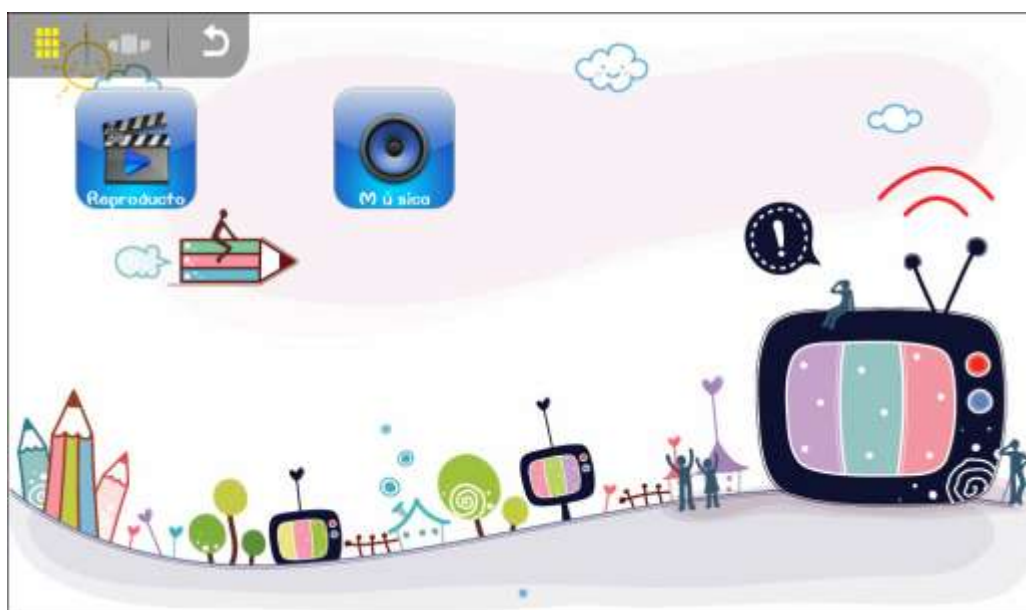

---

select  icon, show as above squares mode; select  icon, display the extended loop mode; select  icon, return to the main interface.

- Application icon interface, display downloaded application



- **Juegos:** select Juegos icon to enter below installed game application

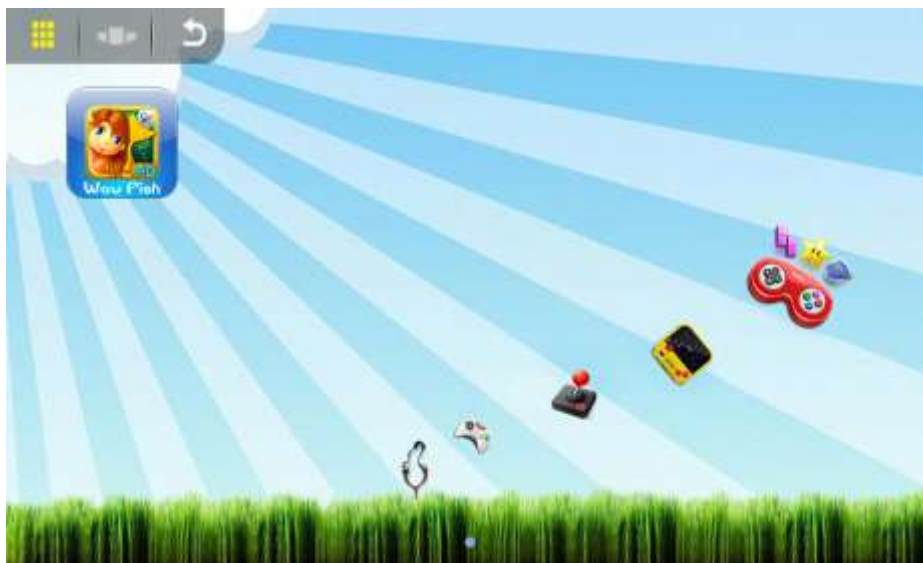

- **Pinture:** select pinture icon to enter paintpad application, Children can use the tools in the drawing board, draw pretty cute pictures; select  icon, the pictures will be Saved to the local library.

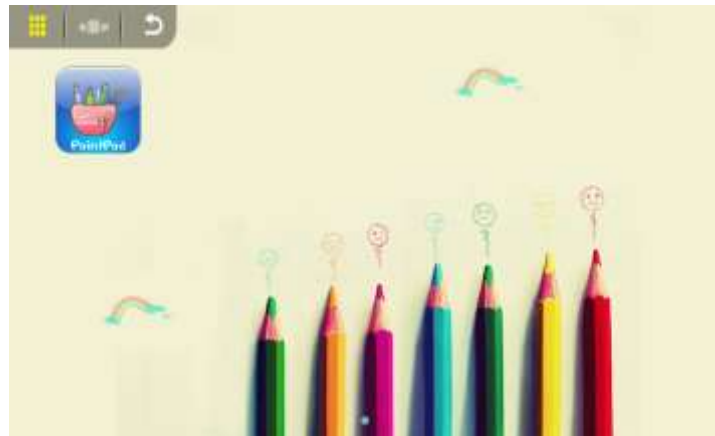

- **Notas:** select Notas icon to enter Note application. Open Note application, make handwriting, voice memo recording anywhere and anytime to leave a good memory.

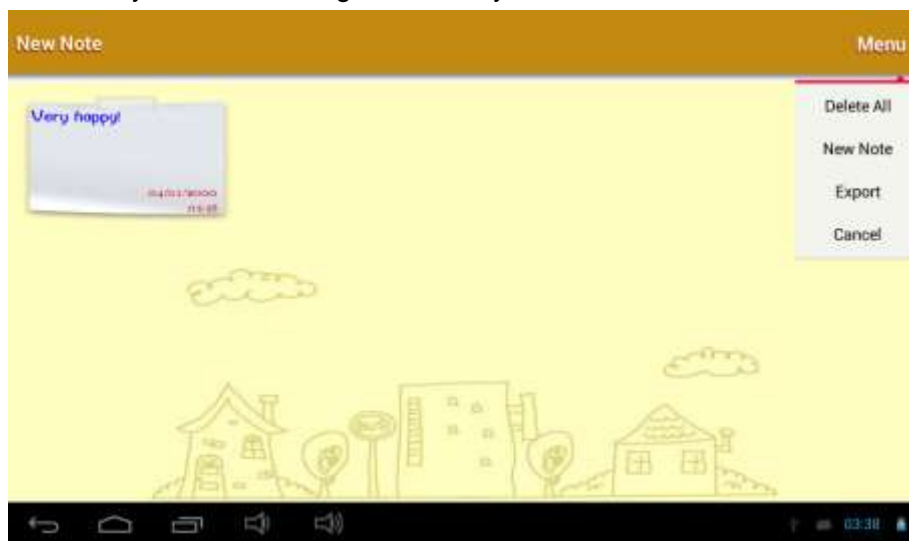

- **e-book:** Select e-book icon to enter BOOK READER application. Open this application, it will show characteristic bookshelf interface, it can collect kids favorite Electronic books like PDF, EPUB, TXT, HTML and other formats.





Tap this icon; you can let the whole earth spin up, function icons floating up, so that the whole interface lively and interesting.



Select this icon; fast enter the gallery, showing pictures saved there.



Select this icon to enter the date settings interface



Select this icon to enter kids system setting interface



- **Sistema:** Enter sistema setting, it will show WIFI switch key, battery, volume switch, brightness adjustment.
- **Padre:** Enter Padre, tap the password to choose EXIST APP, it will quit the kids user interface to parent' s interface.

Select Padre, it will show as below:





Parent setting password interface

 icon: : When the kids use the tablet pc out of time limit setting by parents, it will jump out the lock screen reminder, child can enter the application operation again after parents' permission, as below



This time usage management setting is the highlight of the kids tablet. Parents can effectively manage their children's time on using tablet pc to protect children's Eyesight. Custom setting is flexible for parents to control the time.

Parent add APP. Select a function icon on kids interface, such as "Media" (see below picture 1) ) to show existing application icons of parent interface(see below picture 2), set tick for the needed application, then tablet will exist. The needed application will save to kids interface directory lined below e-book.



(picture 1)



(picture 2)

Application: Enter the password setting screen, enter the password, parents can set website browsing permission for kids, only allow the kids to browse the health website.( Note: Only to be effective after ticking (√). )



#### 4.4 Operation of the Function Icons on parent interface

Select PADRE, enter password, touch “salir del app” to exist, then it will enter parent interface.



### 5. Operation Details

#### 5.1.1 Music Player

Press audio icon  which is in main menu or desktop to enter audio playing.



● Music Player Icons

	artist		Albums
	song		Music list
	Current Playing		Music list
	Random play		Loop playback
	lyrics switch		More Options(delete etc)
	Play the last song		Pause
	Play the next song		Volume- & Volume+





## 5.1.2 Video









In the application menu or on the desktop, tap the icon  to enter the video and picture player interface, Double click the movie you'd like to start playing:



Video formats support: MKV、AVI、RM、RMVB、MP4、MOV、VOB、DAT、FLV、3GP

- The system will automatically load any video files from the TF card to the playlist after the video player has been launched.
- Drag the playback progress bar  to adjust video playback progress.
- Video playing button icons:

Icons	description	Icons	description
	Add bookmark		brilliance control

	Last		Next
	Play & Pause		Video standard:16: 9 /4: 3/ recover
	quit		menu
	Decrease volume		Increase volume
	Turn movie player window to small window		

- During video playing, you can tap  to achieve selection such as delete bookmark, play mode etc as below shown:



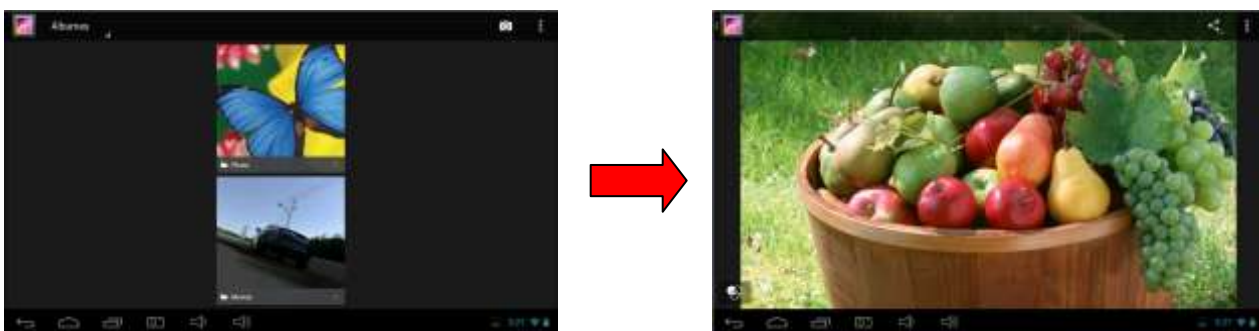

### 5.1.3 Gallery

In the application menu or on the desktop, tap  to enter picture player interface as below:



### Picture Player Icons Description:

Button	Function	Button	Function
--------	----------	--------	----------

	Take photos		Share picture
	Select and edit picture		





Load images (The Tablet PC supports: BMP、JPG、JPEG、PNG、GIF)

The system will automatically load the image files from the TF card to the photo browsing list after the photo browser has launched.

Tap  to slide show, browse images, set the image as wallpaper, edit, rotate, crop or resize your image.



#### 5.1.4 Recording

In the application menu or on the desktop, click  to the recording interface, tap  to start recording,  to pause,  to play. When recording finish, you'll be asked if you wanna "Discard" or "Save" the recording.

Recording playing: Select playing recording by video player, finding the recording files from root content of file manager, click the one you'd like to start playing, details see 5.1.1(video player).

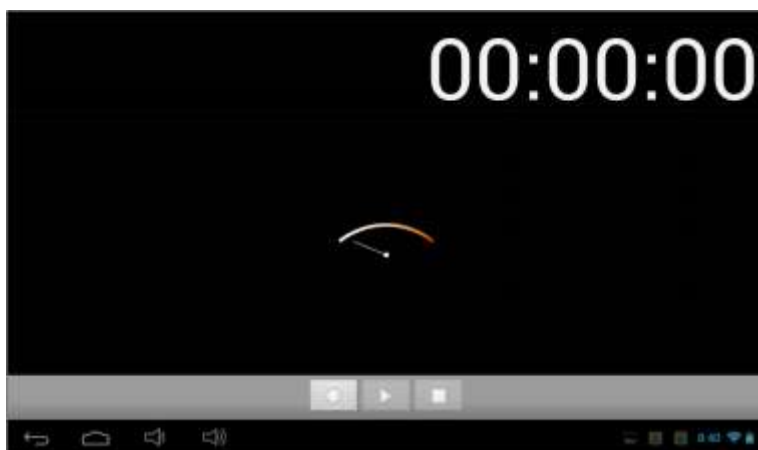

#### 5.1.5 File Manager

Tap icon  on the menu or desktop to enter the interface of File Manage, tap **【SD Card】**, **【Internal Memory】** & **【USB】**, long pressing the file or folder if you want to manage, the system will pop up the file or

folder operations window, then you can choose to Copy, Delete, Move, Rename etc  
When copy or move a file/folder, find the target folder and long press, choose paste into folder.



### 5.1.6 Web Browser

Under WIFI connected,(see chapter6.1.1 WiFi), tap icon  enter to the Web Browser interface; tap the address bar of the browser and input the website and enter:



Note: The IE Explorer uses the popular third-party IE Explorer software; please follow the IE Explorer's standard operating mode to operate.

### Voice Search

Tap icon  on the menu or desktop to enter the interface of voice search interface, speak to the tablet, it will automatically search after identifying the content of your speech.

### 5.1.7 Calculator

In the applications menu or on the desktop, tap the Calculator icon  on the desktop to open

---

the calculator:



### 5.1.8 Clock

In the applications menu or on the desktop, tap the Clock icon  to enter the settings interface

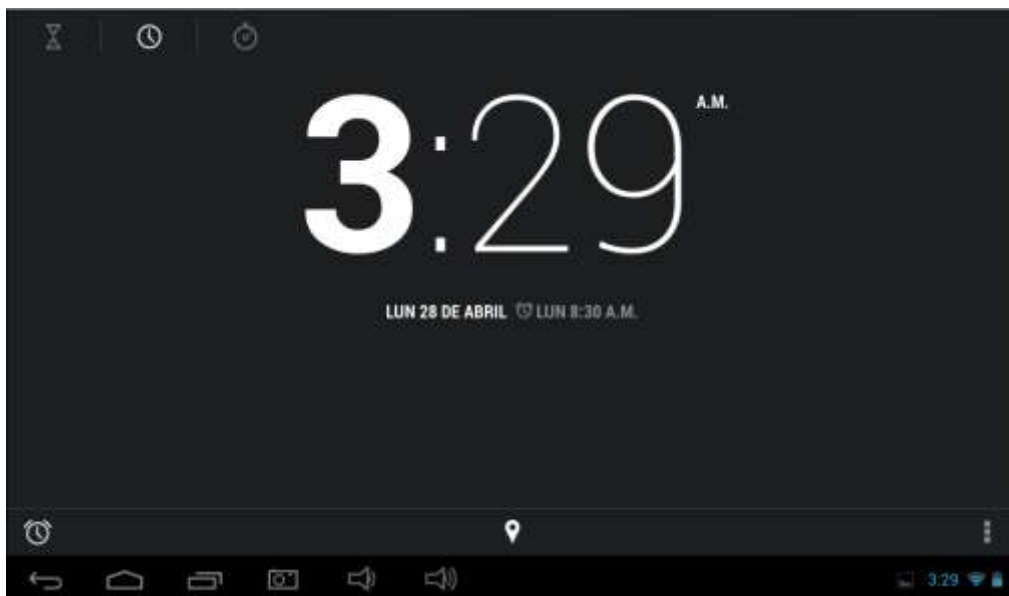

Click the *alarm settings*, alarm clock can be set

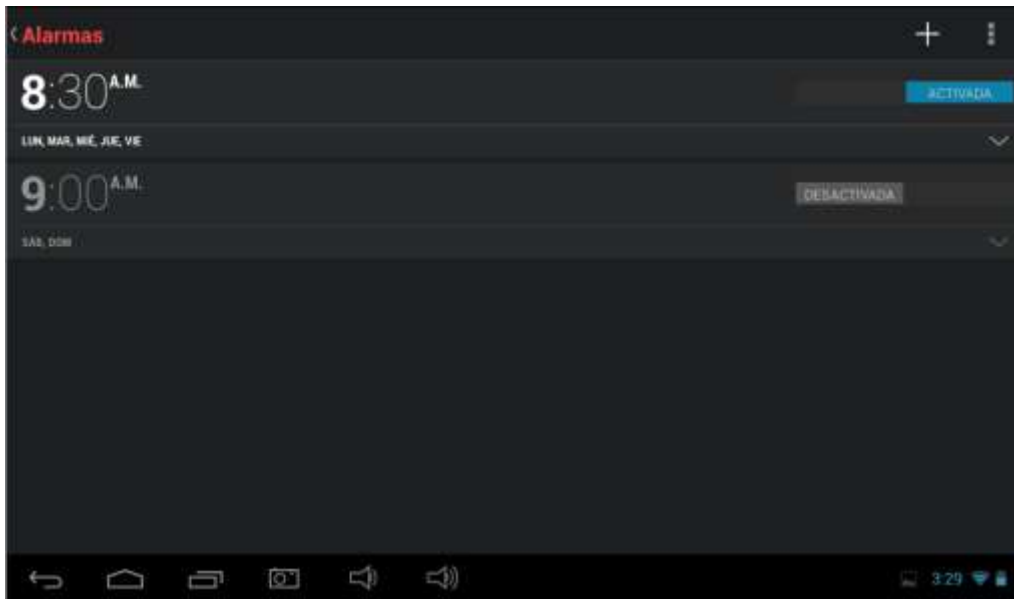



click accordingly the time, Can be set up alarm clock detailed information: The alarm clock time, alarm bell, repeated alarm condition, the label set.



Repeating: choose accordingly the day that the clock be expected to ring-down.

- On Monday, Tuesday, Wednesday, Thursday, Friday, Saturday and Sunday: check you need the number of days, for example: you choose from Monday to Friday alarm, respectively from Monday to Friday behind box ticked on, set the alarm clock on Monday to Friday at the same time of the repeated ring;
- No: set the alarm clock ring only once, don't repeat
- Click on the clock: select the clock model

### 5.1.9 Camera

Tap the App Menu icon  to enter into the app menu list, tap  to enter into the camera function interface:

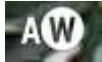

Icon	Description	Icon	Description
	Video Icon		Photo Icon
	Front and rear Camera switch		Setting of storage and adjust

	Shutter		Change of camera back ground
---	---------	---	------------------------------

### 5.2.0 TF (Micro SD) Card Storage

This device has SD or TF card slot and can read files in those cards. Operating should be in the right way when plug in or take out those cards.

When using, according to the card slot will set the SD card, insert into tablet correctly, push into the card, until you hear a click sound. If you want to take out the card, please push card into the slot tightly, and then release. Memory card will automatically pop up, and then remove the memory card.

- a. insert TF card properly
- b. Do not take out card if you want to copy or read files in card, or it will cause data mistake or lost problem
- c. Avoid high temperature and wet environment when using the card
- D. Avoid liquid and corrosive materials.

### 5.2.1 APK Install and Manage

Native support for third party applications based on Android platform, most applications can be obtained from the Internet, copy into the machine flash or T - flash card, and then to install and use.

- click  , for installation, see as below picture: Installation, management and exit, three options.

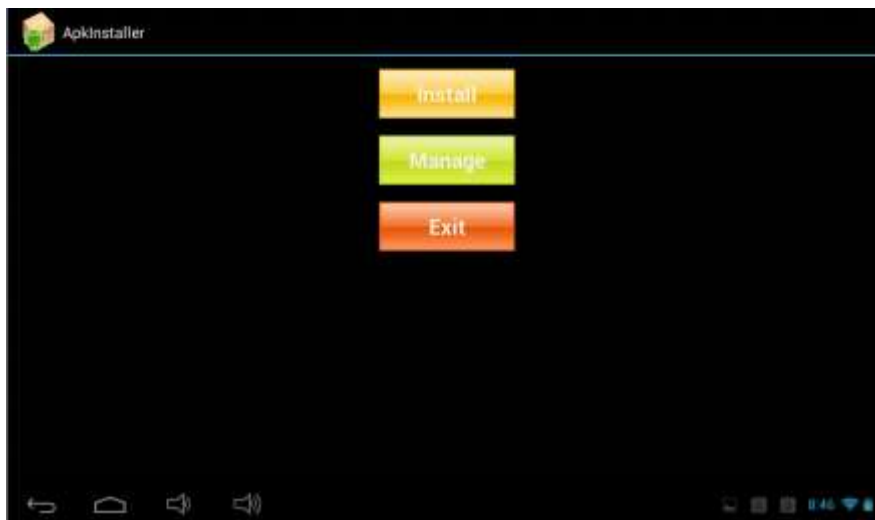

- Installation : Click install, enter the Apk installation interface.  
Internal Memory and SD Card corresponding flash ram disk and the T - flash Card storage;  
After entering, choose the right box APK format installer, double click install software.  
  
Operation after the completion of the return to the main interface, that is, complete the installation, and a corresponding software menu.



- Uninstall: Click on the management, into third party software interface.

Note: this system can only unload the users to install APK software, the original factory own software unable to uninstall and delete.

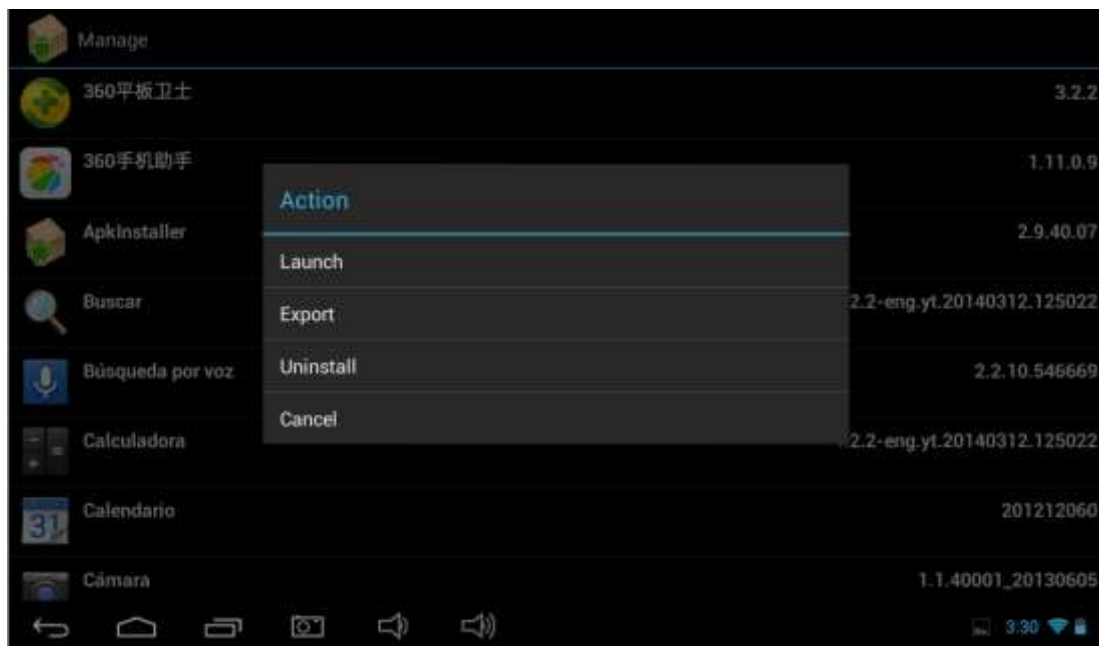

- Start: run the software
- Export: export software to the T - Flash CARDS
- unloading: uninstall the software
- Cancellation: cancel the operation

Exit: back to the main interface

(Note: this only to install the software, if you need other software installation please according to this instruction)



---

## 5.2.2 External Keyboard & Mouse

After add tieline before plug in the mouse on the screen appears the mouse pointer, mouse the left key is to confirm that key, right is the return key, middle pulley key is moved up and down:

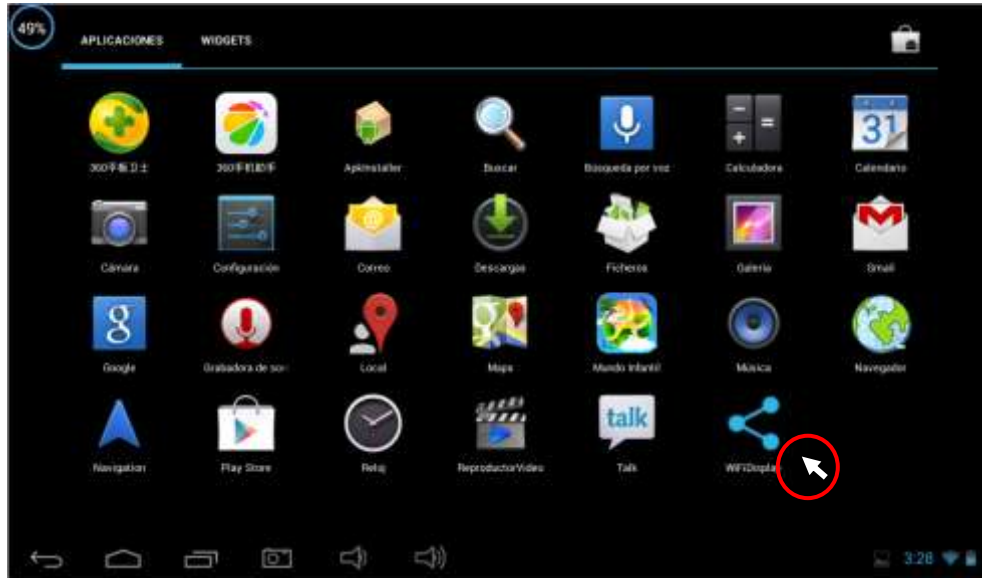

Note: For the standard keyboard some buttons are not available, it needs o reset the keyboard software according to ANDROID system. We suggest you can use the default USB keyboard.

## 6. System setting

### 6.1.1 WIFI Setting

In the applications menu or on the desktop tap  to enter into the setting interface, and then tap







a. Press WIFI and the system will search wireless networks automatically. Shown as below picture

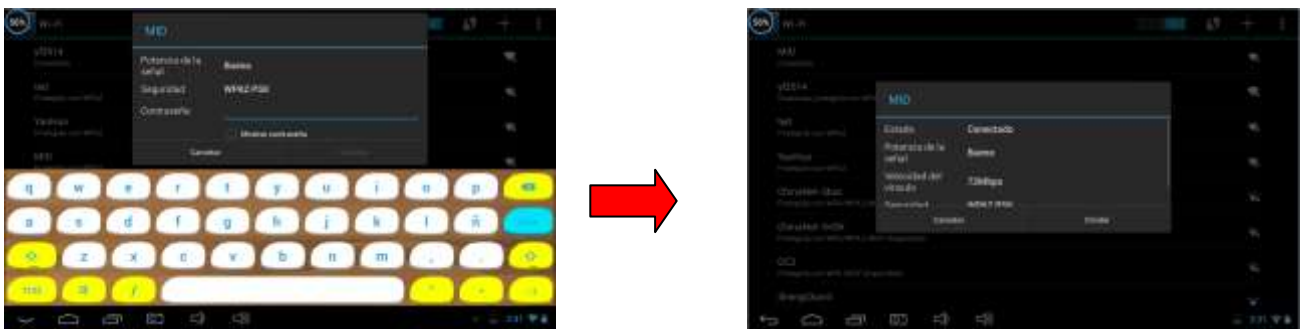

b. Connection ( It is dynamic IP address and needn't set the IP address)

The dynamic IP address is assigned by WIFI router. If it is automatically assigned the IP address, and then click the WiFi network name. For example, click “TestII” it will pop up a connection window where you can input the correct security code and then tap “connect”. The system will connect to the network automatically, and once connected will show a Status of “Connected” You can see the network connection status by pressing the network name, see the figure below:



There will be a WIFI icon  in the bottom right corner once it connected successfully.

Traffic usage query, Click the icon ()check the network traffic.

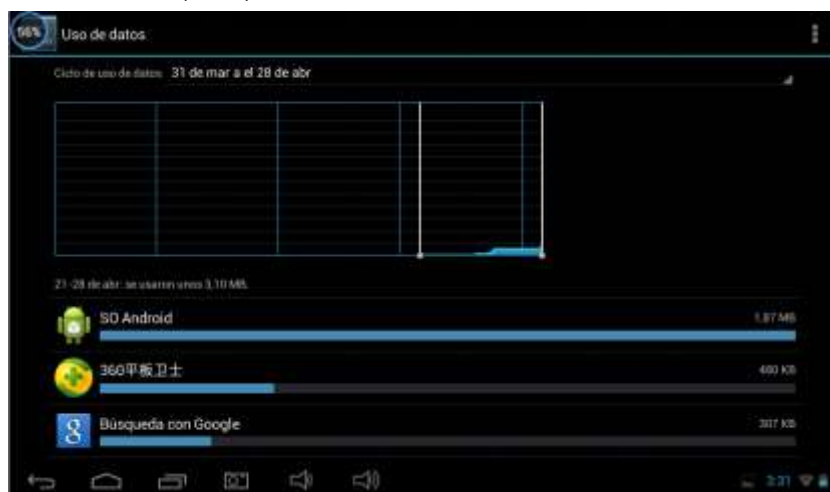

---

### 6.1.2 External 3G USB Dongle

Connect the 3G USB-Dongle to the Tablet PC by USB HOST cable. The 3G network icon will be showed in the bottom right corner of the screen when Tablet PC connects the 3G successfully as below picture:

You can use the internet normally.



### 6.1.3 External RJ45 USB Dongle (WIFI hotspot setting)

1、 Connected RJ45USB Dongle to the tablet PC by USB HOST cable, MID will obtain IP address automatically without any Settings.

In the applications menu or on the desktop, click icon , click icon **Más...**, as below picture, and tick

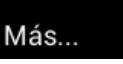
“” behind **Zona Wi-Fi portátil** . At the same time you can change the name and password of WIFI spot.

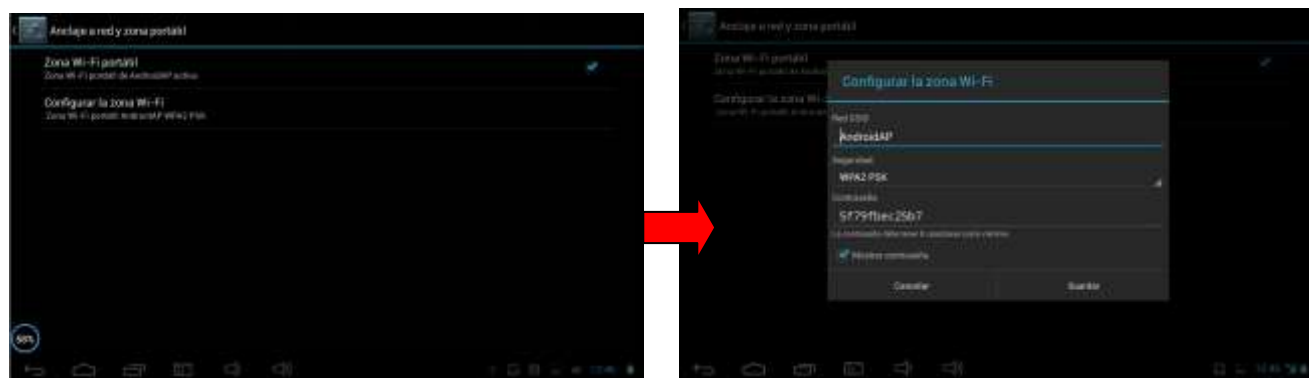

### 6.1.4 Sound

Tap the icon  to enter the sound setting interface as below:



- a. [Silent mode]: click **Volumen** into volumes settings , tablet will be no sound..
- b. [Volume]: Click into the volume Settings as shown in figure:  
Set the media, the alarm clock, notify the volume;



- c. Ring setting  
In the setting interface, tap “Ring notice” to enter into Ring setting interface:



---

System indicator sound setting:

A touch indicator sound (tap the touch screen)

B Lock indicator sound (lock and unlock the screen broadcast voice)

C touch vibration ;( if the machine is equipped with vibration motor, slight vibration when click on the touch screen machine)

This two functions are optional, press  to enter mute state if you do not want those functions.

### 6.1.5 Display and wall paper:

a. In Settings screen click show the wallpaper into the wallpaper Settings, can be in the position or dynamic wallpaper wallpaper to choose your own favorite picture.

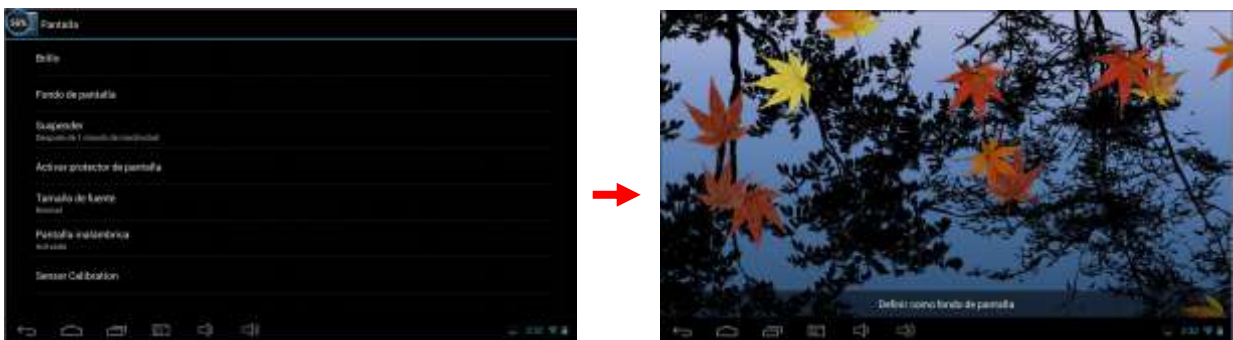

If you want to change the wallpaper you can long press the blank position of the desktop and you will see the menu as shown in below picture:

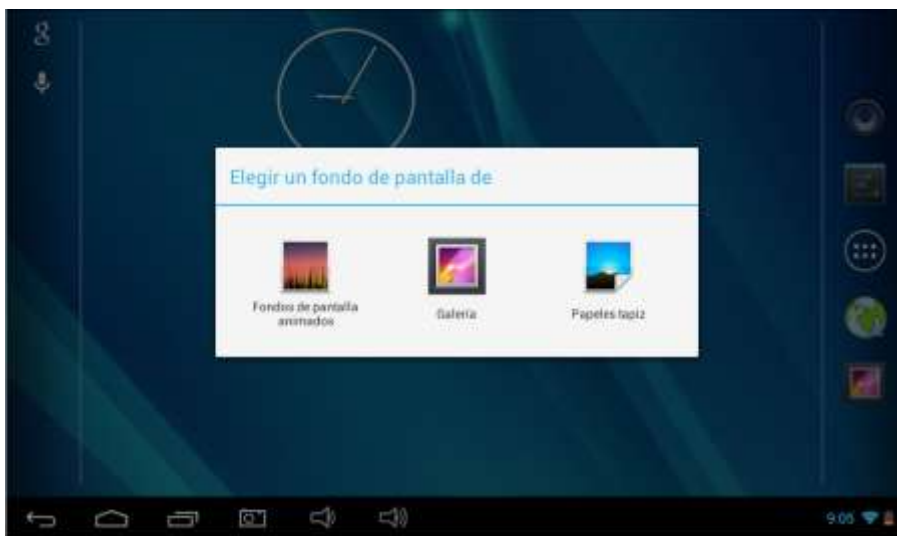

b. Brightness: drag this icon to  adjust the backlight brightness, Click confirm Settings and return

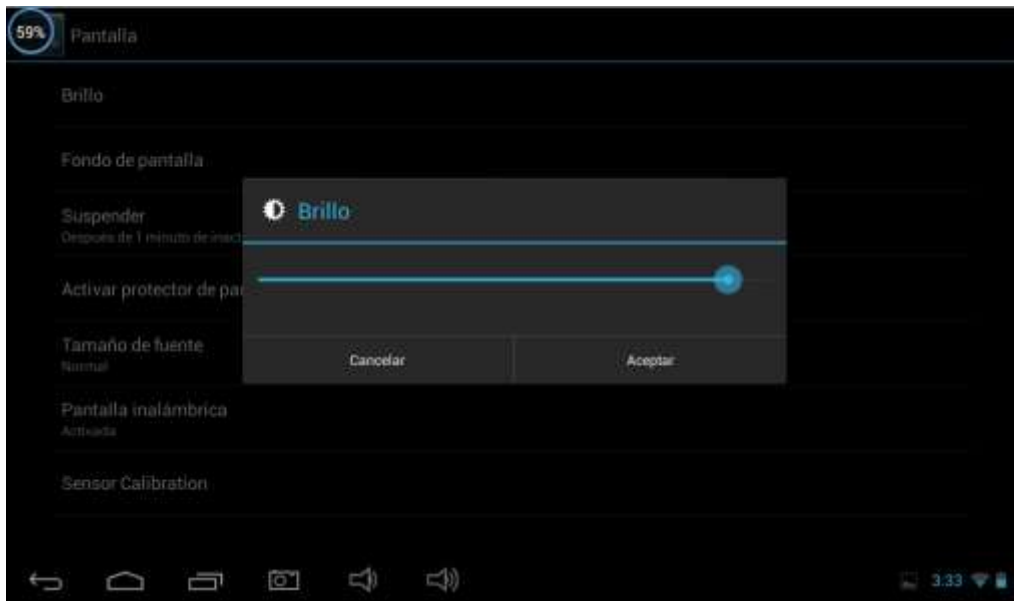

c. sleep time choice: Choose machine standby sleep time

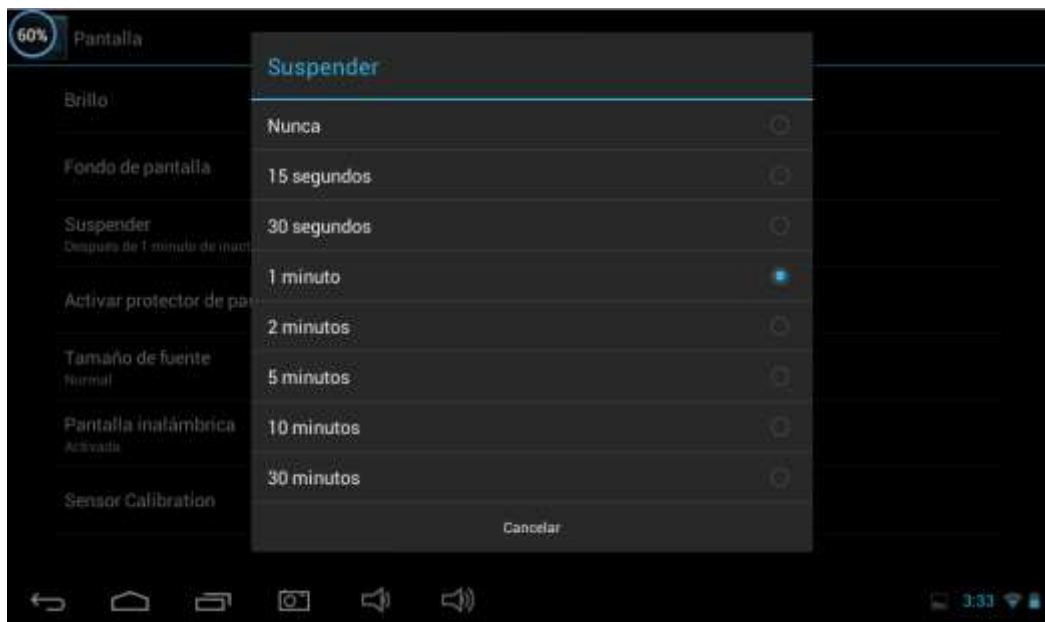

### 6.1.6 Screenshot:

Click  **ScreenshotSetting** and tick “Show the screenshot button in the status bar”



### 6.1.7 Storage

Click  in the setting application interface, it will show all the storages status:  
It can check the flash storage, SD storage, available storage and so on.



Press  on the right upper corner to choose the way how to connect computer through USB jack.



- 1: Media device/MTP ;
- 2: Camera/PTP;
- 3:message storage;

### 6.1.8 Battery

Tap the icon  to check the battery using status

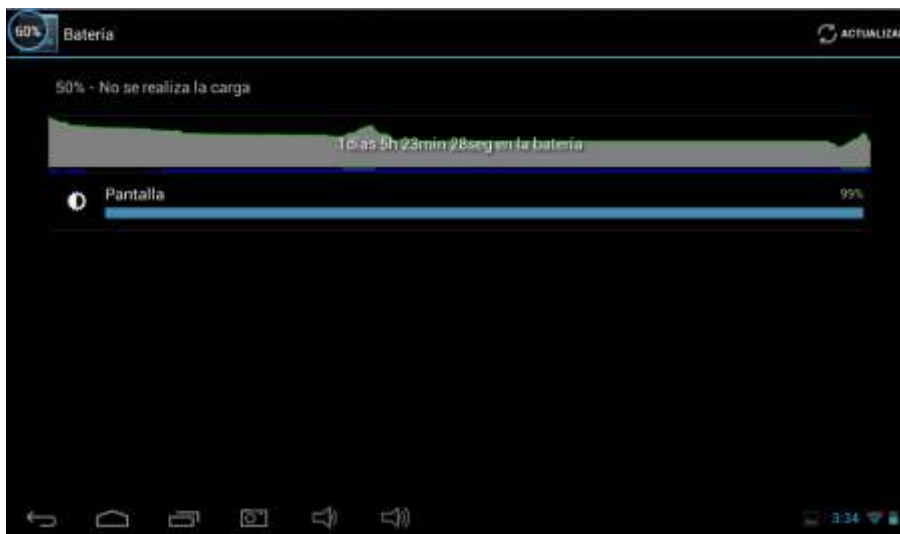

### 6.1.9 Apps

Tab the icon  to enter the Application setting interface as below:





- **Setting on running service**

Click **【program】** to check the running service:

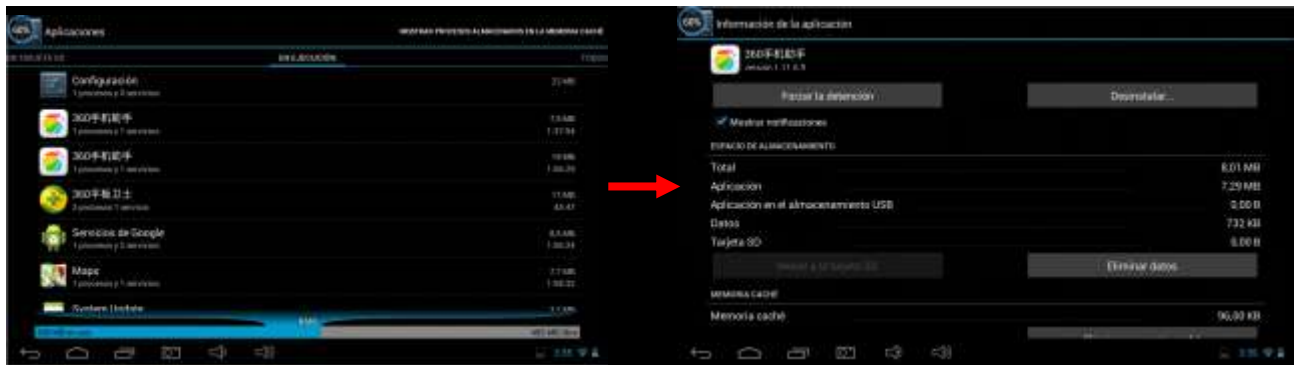

## 6.2.0 Location & security

Tap the icon  to set the Google's location service and Location & Google search as below:

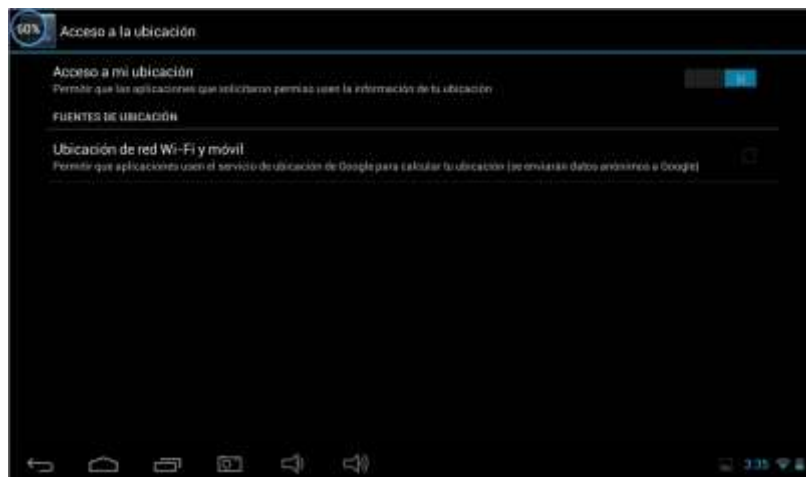

Tap the icon  to enter the security settings interface as below:



Screen Lock Settings: 1.None 2.Slide 3. Face Unlock 4.Pattern 5.PIN 6.Password



Pattern settings: Enter Settings-security-choose Pattern to set password for screen as below:

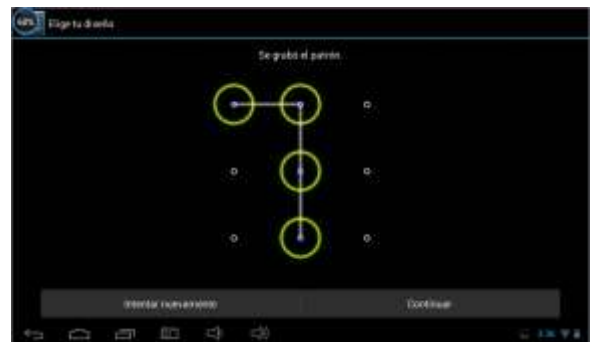

Choose at least four points when set pattern pass word, click NEXT STEP to finish the setting procedure.

[PIN settings]: Set PIN password:



Click OK button after input four pass words, and remember pass word for later use.  
It will inform you to input password when device boot ups:



Choose the way you like to unlock the screen

Equipment management settings:

In security interface, choose UNKNOWN SOURCES, then other APK can be installed on device, or it can not be done:



### 6.2.1 Language & input

Tap the icon  to enter the language and input method settings interface to choose the language as you need as below

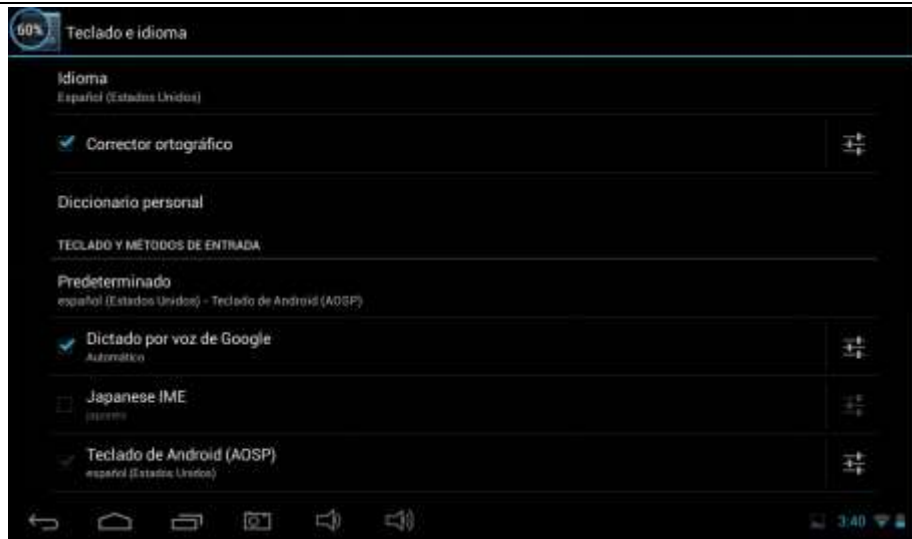

- **language settings:**

The Tablet PC supports multi-languages. You can select an operation interface of corresponding language according to your needs.



- **Keyboard and input settings:**

According to your needs to set the corresponding input method: Tap the icon  to enter the settings interface, Tap *settings*→*Language & input*→*Android keyboard settings*→*input language*, see as below:

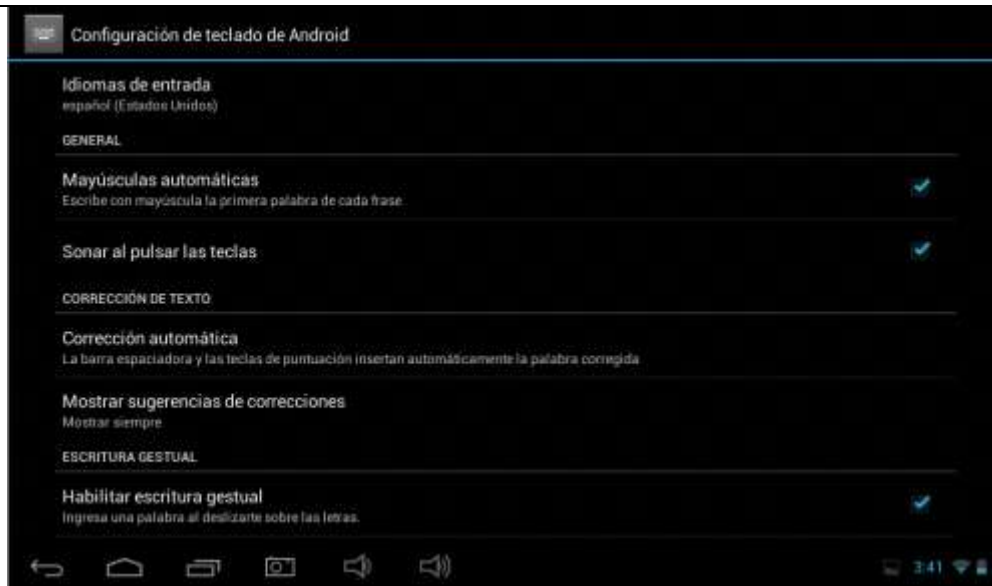

## 6.2.2 Backup & reset

Default factory recovery: Reset the tablet, erase everything, and restart.

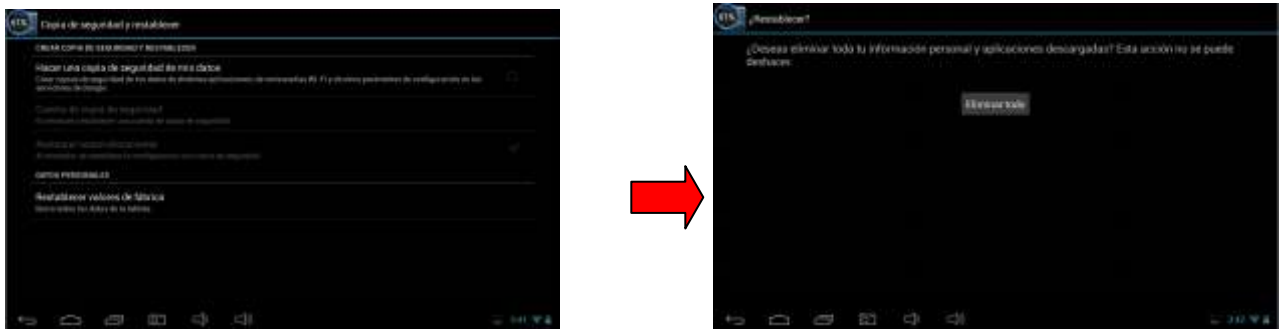

**Note:** Please back up all your data of the internal memory before reset the Tablet PC, or you will lose all the data.

## 6.2.3 Date & time

Tap the icon  **Date & time** to enter the date and time setting interface, click the box behind the “Automatic” (click date & time) to modify the system date and time by manual as below.

- **Date setting:**

Slip to select *Day, Month and Year* or click the right numbers, and press OK to finish.

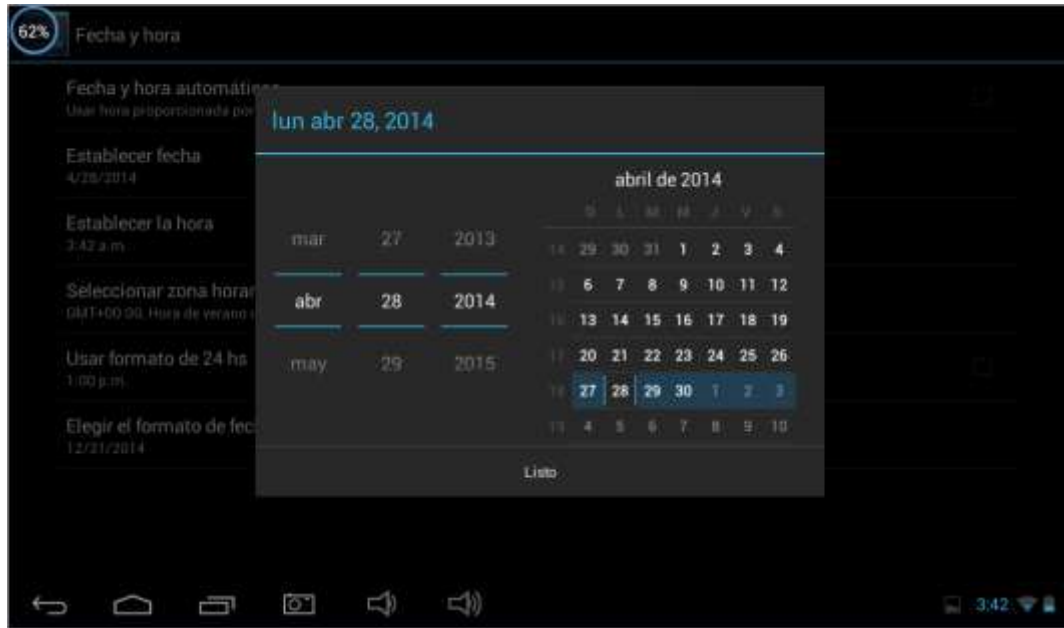

- Choose time zone:  
Choose the time zone where you are and click OK to finish:



- Set time:  
Slip to choose time: for example: 04: 13, Click OK to finish.



- Date format:



Click  to choose 12 hrs or 24hrs date format

### 6.2.4 Accessibility

- Can set the Auto-rotate screen, large text etc, as below.....

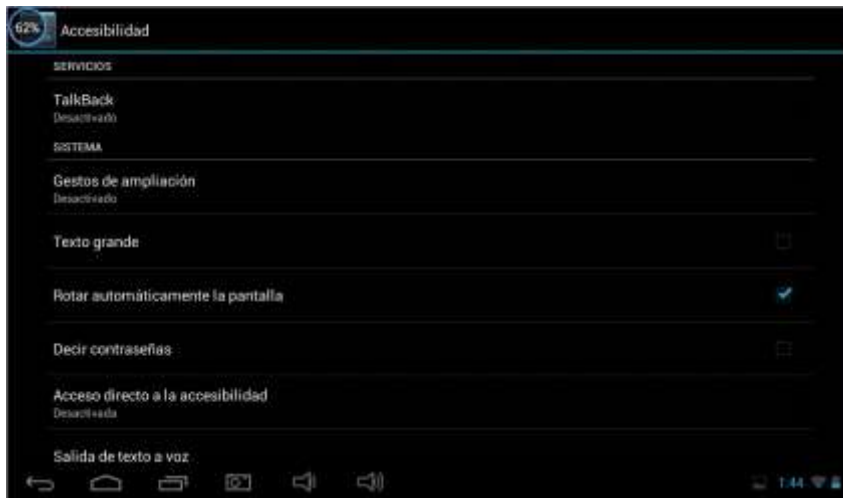

Touch & hold delay:

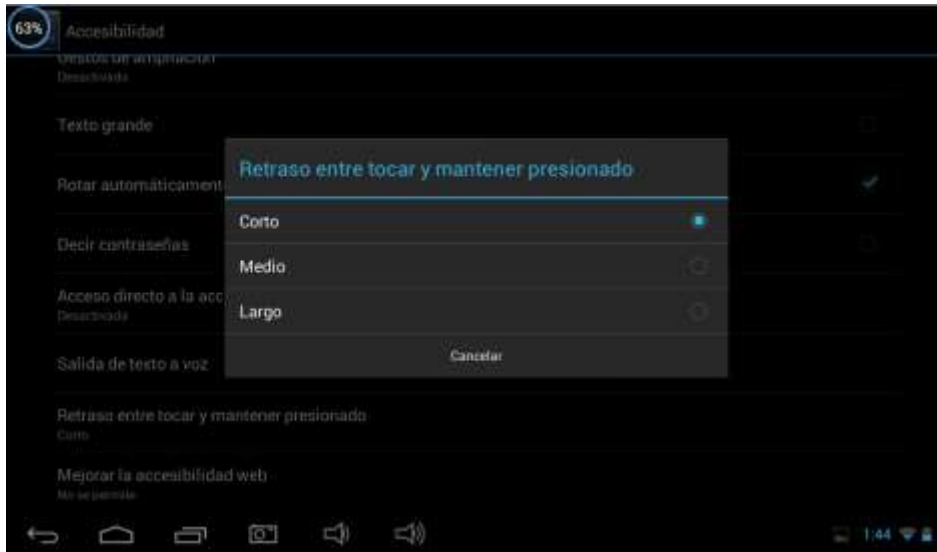

### 6.2.5 Developer options

It is recommended to use the factory default developer options setting, or some changes may affect the functions of the Tablet PC.

Tab the icon  to enter the developer options setting interface as below:



### 6.2.6 About Tablet

Check System updates, Status, Legal information and software version as below:





### 6.2.7 Add, Move or Delete Desktop Icon



Tap the icon on the desktop to enter the app menu list. lay out all the application icons with paging display, Tap and drag the application icon to the current desktop, Long tap the app icon on the desktop to enter the editing mode and you can remove the icon and set its location.



When you press and hold the application icon on the desktop, it will be edit status, you can move the location and remove it when it shows icon like 



## 7. Firmware upgrade

Press the POWER button to turn off the device before updating (NOTE: Press and hold the POWER button for at least 6 seconds if the device can not be turned on normally).

Insert the Driver CD and copy the file named "RK3028A Android Upgrade Tool" to your computer desktop (NOTE: The device can not be updated directly from CD), Then Open file "RKBatchTool.exe" in Folder "RK3028A Android Upgrade", click the button  next Image and choose "update.img" from the popup window, click open, as shown in the picture below:



Hold down the MENU button on the device and without releasing it after device has been turned off; connect the device to the PC by the USB cable supplied with the device.

The "Found New Hardware Wizard" window will pop up on the bottom right corner as shown below. Choose "Install from a list or specific location (Advanced)", and then click "Next" to install the USB driver, see the picture below:

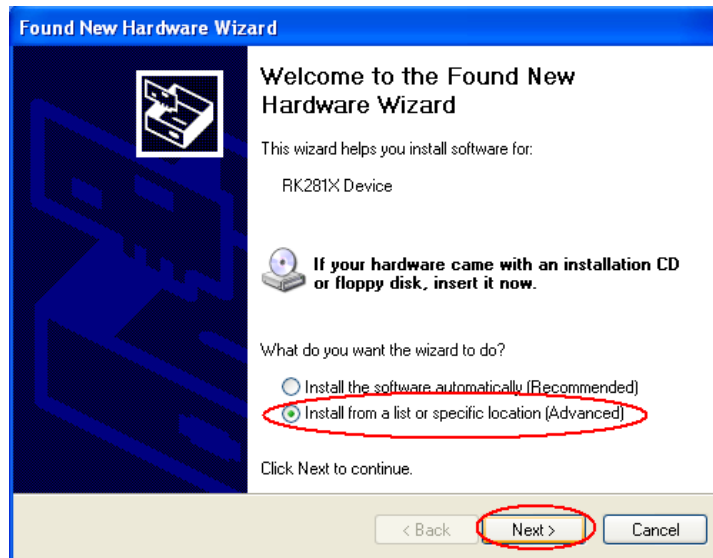

NOTE: The USB port of the PC must be USB2.0, or it cannot be used to update the device.

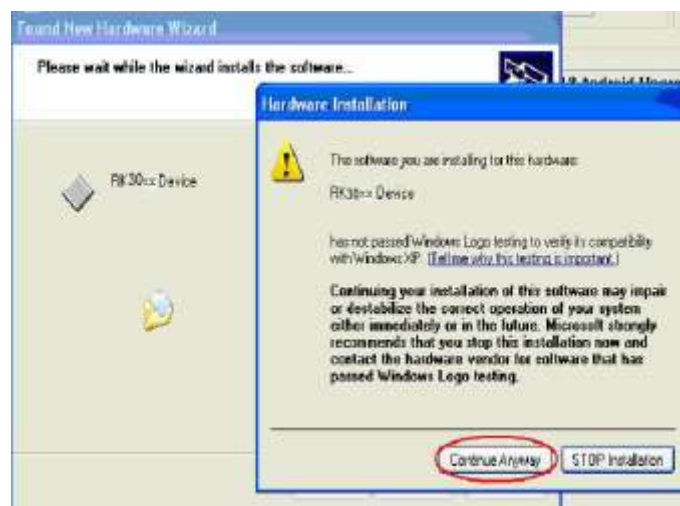
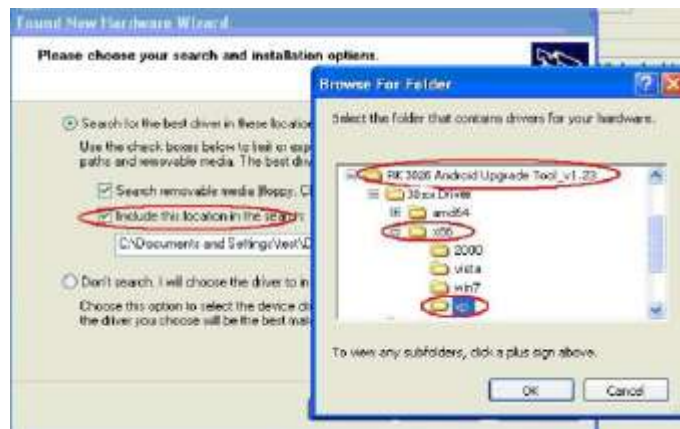



After the driver is installed successfully, “1” will turn green, see the picture as below:



Click “Upgrade” and begin to upgrade, during this process lots of information will be shown in the update status bar. No operation should be done at this time:

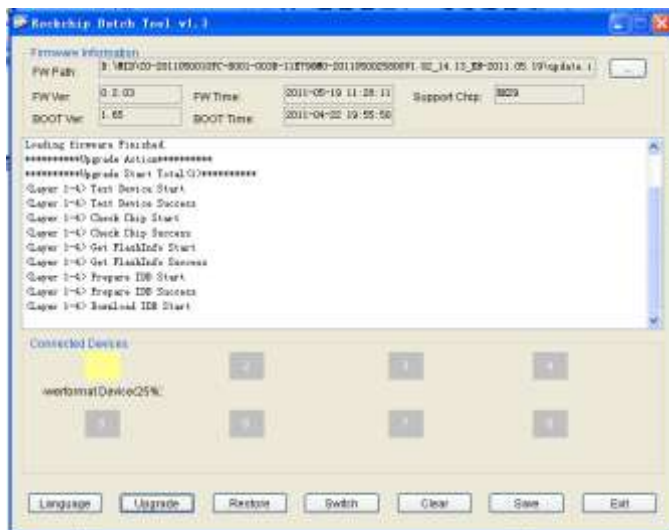

When waiting status bar shows: “\*\*\*\*\*Upgrade Done Success<1> Fail<0>\*\*\*\*\* ”it means the upgrading is successfully. Device will come to the main interface after run system. (Notes: Please don't disconnect the USB cable during the updating process because this will cause update failure or possible system failure of

the device.)



## 8. Troubleshooting and FAQ

### 1. Device doesn't turn on

- 1) You cannot turn on the device when the battery charge is below the critical level, please charge the battery.
- 2) Press the RESET button on the top of the device and check if it is restarting normally or not.
- 3) Check if the charger is connected correctly.

### 2. The stand-by time of the device is too short

- 1) The duration of the lithium battery varies with environmental temperature changes and the service conditions. If the environment temperature is too low or too high, the duration of the battery will be affected. It is recommended to use this device at normal temperature.
- 2) Battery life is dependent on usage. High volume, WIFI, and the frequent use may cause the battery to be drained at a higher rate.

### 3. No sound via earphone

- 1) Please check if the volume setting is 0.
- 2) Please check if audio file is broken, and try to play another audio file to confirm. If the audio file is broken, it may cause severe noise or static.

### 4. Cannot copy files

- 1) Please check if the device is connected to the computer correctly.
- 2) Please check if the memory space is full.
- 3) Please check if the USB cable is broken.

## **FCC statement**

This device complies with Part 15 of the FCC Rules: Operation is subject to the following two conditions:

1. This device may not cause harmful interference and
2. This device must accept any interference that is received, including any interference that may cause undesired operation.

\*RF warning for Portable device: The device has been evaluated to meet general RF exposure requirement. The device can be used in portable exposure condition without restriction.

This device is acting as slave and operating in the 2.4 GHz (2412 ~2462 MHz) band.

Ad Hoc function is supported but not able to operate on non-US frequencies. Do not use the device with the environment which below minimum -10 °C or maximum over 50°C .

**NOTE:** This equipment has been tested and found to comply with the limits for a Class B digital device, pursuant to part 15 of the FCC Rules. These limits are designed to provide reasonable protection against harmful interference in a residential installation. This equipment generates uses and can radiate radio frequency energy and, if not installed and used in accordance with the instructions, may cause harmful interference to radio communications. However, there is no guarantee that interference will not occur in a particular installation. If this equipment does cause harmful interference to radio or television reception, which can be determined by turning the equipment off and on, the user is encouraged to try to correct the interference by one or more of the following measures:

- Reorient or relocate the receiving antenna.
- Increase the separation between the equipment and receiver.
- Connect the equipment into an outlet on a circuit different from that to which the receiver is connected.
- Consult the dealer or an experienced radio/TV technician for help

Changes or modifications to this unit not expressly approved by the party responsible for compliance could void the user's authority to operate the equipment.