

TITAN TABLET PC7805ME

USER MANUAL

FCC ID: BRCPC7805ME

Content

1 Preface.....	3
1.1 Acknowledgements	3
1.2 Notes	3
1.3 Safety Notices	4
1.4 Abbreviation/Term	5
2 MID Introduction	5
2.1 Ready to use	5
3 Quick Guides	6
3.1 Packing list	
3.2 Product appearance	
3.3 Function Icons.....	7
3.4 Switch on/off.....	10
3.5 Power Saving Mode and Locked Mode:	10
3.6 Operation of touch panel.....	11
3.7 Main Interface	11
3.8 Apps	12
3.9 USB Connect.....	13
3.10 Input Text	14
3.11 Use Skills	15
4 General Setup.....	15
4.1 SIM Card management, WIFI & Network.....	15
4.2 Bluetooth (Optional)	17
4.3 Data Usage	20
4.4 More.....	21
4.5 Audio Profiles	26
4.6 Display	28
4.7 Storage	30
4.8 Battery.....	32
4.9 Apps	1
4.10 Account	34
4.11 Location access	35
4.12 Security	38
4.13 Language & input.....	40
4.14 Backup and reset	41
4.15 Date and Time	42
4.16 Scheduled power on&off	43

4.17 Accessibility	43
4.18 Developer options	44
4.19 About MID	45
5. Multimedia	45
5.1 Music Player	45
5.2 Video	46
5.3 Gallery	
5.4 Camera	48
5.5 FM Radio	49
6 Communication function.....	50
6.1 Phone.....	50
6.2 SMS.....	51
6.3 Contacts.....	51
7 Movil Teacher (Optional)	
8 Internet	60
8.1 Browser	60
8.2 E-mail.....	61
9 GPS function	63
10 Other Applications	64
10.1 Clock	64
10.2 Calculator	65
10.3 Explorer.....	65
10.4 Recorder	68
11 Application Installation	69
11.1 Installation.....	69
11.2 Uninstall	69
12 Troubleshooting	70
13 Updating Instruction	

1 Preface

1.1 Acknowledgements

Dear Customer,

Thank you for purchasing our products, the HD tablet pc in 7 inch. Adopting master chip MTK8377, 2*Cortex-A9 framework and O.S. Android 4.1, CPU speed at 1.0 GHz, the device is easily compatible with third party applications.

With functions like build-in 2G, 3G, WIFI, BT (optional), GPS (optional), FM (optional), Voice call etc, you can achieve wireless communication or use wireless network easily, surfing the internet whenever and wherever possible. And with high-accuracy build-in GPS module (optional), you can achieve navigation function just by installing the mapping software. You can also go through the brand-new entertainment through the functions of build-in multiple sensors, build-in mobile analog television, image pickup etc. So are you ready to embrace the new era of mobile internet entertainment in palm?

This manual will give you a general introduction about all kinds of functions, use skills and notes, please read it before using the device. Thanks.

1.2 Notes

Maintenance

- The device is not waterproof, please keep it dry. In order to avoid the risk of electric shock, do not touch the cable power plug with wet hands.
- Please do not let the device fall onto, rub against or knock against

hard objects during use, because this may cause surface scratches on the device, battery damage, data loss or other damage to the hardware.

- Over-voltage, power cable strain and bending or squeezing of the power cable by heavy objects must be avoided to prevent the possibility of overheating or fire.
- Please do not knock, throw or prod on MID. Please avoid dropping, knobbing or curving the device.
- Only qualified maintenance personnel can install or repair the device. Opening the device in any way will invalidate the warranty.

1.3 Safety Notices

Please read present section before using the device.

- Please comply with any related restrictions and rules; do not use the device during driving or where blasting operations are in progress.
- Please don't turn on the device on in locations where wireless equipment is forbidden or when the usage of the device will cause interference and possible danger.
- Please comply with any related restrictions and rules, wireless equipment can influence the flight of the plane; please consult the relevant airline company if you intend to use the device on a plane.
- All the wireless equipment is subject to external interference and this can affect its performance.
- Only qualified maintenance personnel can install or repair the device. Opening the device in any way will invalidate the warranty.
- Please keep the device away from strong magnetic fields in order to avoid damage to the product.
- Please don't use the device in a petrol station, or near to fuel or chemicals.
- Please put the device out of reach of children, and please make sure the device used by child only under supervise.
- Some movies, music and pictures are under the protection of copyright, unauthorized usage is deemed as an infringement to the laws of copyright.
- When connecting with other devices, please read the user manual for detailed safety instructions. Don't connect the device to incompatible products.
- Never clean the device with any chemicals or detergent, these will damage the product surface and corrode the finish. Never let this

product be exposed to a humid environment or rain as the water leaking into the device could disable it to the extent of being beyond repair.

1.4 Abbreviation/Term

Abbreviation/ Term	Full name	Explanation
MID	Mobile Internet Device	Mobile internet terminal
WIFI	Wireless Fidelity	WLAN based on IEEE 802.11b
TF	Tran Flash	Micro SD, super mini memory card
HD	High Definition Multimedia Interface	

2 MID Introduction

2.1 Ready to use

Battery Charging

Charge the battery firstly before initial use.

2.1.1 Please charge the MID with our original power adapter.

Note: Please use the original accessories and battery provided with the device, do not use the incompatible products in case of damage unexpected, any damage of problem result from this could be beyond of our range of maintenance.

3 Quick Guides

3.1 Packing List

Components	Quantity
MID Device	1
Power Adaptor	1
CD-ROM	1
USB Cable	1
HOST cable(optional)	1
Earphone(Optional)	1
User Manual (Optional)	1
Warranty Card (Optional)	1
HD Cable (Optional)	1
3G USB Dongle(Optional)	1
RJ45 USB Dongle (Optional)	1
Leather Case (Optional)	1
Keyboard/Mouse (Optional)	1
TF (Micro SD) Card (Optional)	1

3.2 Product appearance

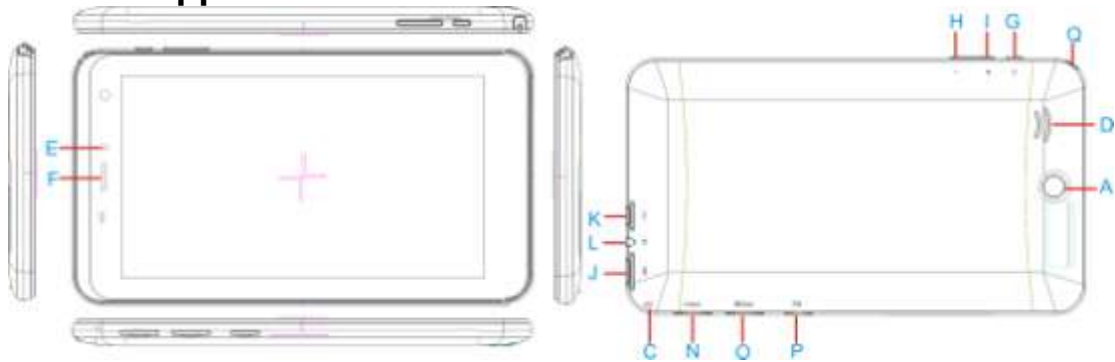

3.3 Instructions on Keys

Symbol	Name	Description
A	Rear Camera	Static and dynamic camera
B	Speaker	For music or movie
C	Microphones hole	Recording microphone
D	Front Camera	Static and dynamic camera
E	receiver	Telephone receiver
F	POWER	Short press this button to enter sleeping/wake up mode, press long to switch ON/OFF
G	Volume -	Decrease volume
H	Volume+	Increase volume
I	Stereo Earphone Jack	Stereo Earphone Jack
J	MIC USB port	MIC_5PIN USB Port
K	TF card Slot	TF (Micro SD) Card Slot
L	SIM Card slot	SIM Card slot

Note: 1. Device without RESET key. Please press “Power” key and hold for 10 seconds to restart the device if it crashed.

2. Press “POWER” + “V—” at the same time for screen cut

Function introduction:

- ✧ GPU:MTK8312 , Dual-core ARM® Cortex-A7 MPCore™at 1.3GHz processor Mali400-MP2 44.3M tri/sec and 832M pixel/sec @ 416MHz;support ANDROID4.2 OS and FLASH Play11.1
- ✧ support DDR3 1GB;
- ✧ support 16G FLASH, external TF card 1G~32GB storage;
- ✧ support 1024*768 HD 7.85” capacitive screen
- ✧ Video playback: mp4,3gp,AVI, MKV, MOV etc video formats;
- ✧ support JPG, PNG, BMP, GIF Format, such as image browsing, maximum support 8000 * 8000 resolution
- ✧ **Support** MP3, WAV video Forma.
- ✧ Support Adobe® PDF, TXT、LRC、Html、EPUB etc. formats
- ✧ support built-in WIFI access to broadband wireless Internet access, working software on ANDROID4.2 operating system are colorful, some of the commonly used software system preset: Google Internet browser (IE), MP3, online novels, online video, e-books, etc
- ✧ **Support** built-in microphone recording function, can realize and voice recording function.
- ✧ **Support** built-in 3 g (WCDMA (3 g), through the USIM card wireless communication function, answering/call, send/receive messages, email, contacts, etc.; have the same function as mobile phone.
- ✧ support USB HOST (through the Mini USB adapter)
- ✧ Built-in front 30W and rear 200W two camera,
- ✧ Support G-Sensor Screen direction function
- ✧ Built-in Bluetooth
- ✧ Support FM function(optional);
- ✧ Support GPS function (optional)
- ✧ support stereo headphones and speakers sound output voice
- ✧ support language: many languages
- ✧ USB mobile disk, WIN_2000 drive system from above

Specification:

















Screen	size	7.85 inch
	resolution	1024*768
Port	MINI USB	
CPU	MTK8312, Dual-core ARM® Cortex-A7 MPCore™ 1.3G	
Flash memory	16G	
RAM	DDRIII 1GB	
	TF Card 1GB~32GB	

Power supply	3.7V 3000MAH 5V/2A	
Music	MP3, WAV	
	Max output	(L) 5mW+ (R) 5mW (320hm)
	8Kbps ~ 392 Kbps	
	WMA、WMV、	5Kbps ~ 192 Kbps
	frequency	20Hz-20KHz
	SNR	90dB
Video	Distortion <0.05%	
	mp4,3gp, MKV, AVI,MOV	
Image view	1920*1088	
E-book	JPG, PNG, BMP, GIF	
E-book	TXT、LRC、PDF、EPUB	
	5M	
GPS	frequency	1.57542GHZ
	positional accuracy	3m,2D cep
	Receive the satellite channel number	16 ways
	location data update rate	1HZ
	Maximum height positioning	18,000m
	antenna	Built-in GPS antenna
WIFI	Transmission rate	Max54Mbps
	Transmission range	Max100m
	Frequency	2.412-2.462GHZ
	WI-FI agreement	802.11 b/g/n
Built-in function	format	WCDMA/GSM
	network protocol and frequency	WCDMA 850/1900/2100MHZ GSM 850/900/1800/1900MHZ
	Transmission range	HSDPA 7.2Mbps/HSUPA 5.76Mbps
record	Support format	Support WAV record
FM	Frequency	88MHZ-108MHZ
Temperature	-10 ~ 50 °C	
OS	Win98/2000/2003/XP/Vista/Win7、Mac9.1 above and Linux2.4	

Icons guideline



Icons Description:

Icon	Description	Icon	Description
	Back to main menu		downloading
	Power status		Web search
	Return		Language search
	Recently viewed		Functions menu
	WIFI Status (blue indicates Wi-Fi connected)		Network status (blue indicates 2G/3G network connected)
	New e-mail		New message
	Bluetooth signal		Flight mode
	Under USB connection		Under USB debugging

3.4 Switch on/off

Switch on and unlocked:

When the device is in powered OFF mode, press and hold the Power key for 3 seconds to enter the Android startup process. The device will take about 100 seconds to enter the system desktop, with the display in locked mode, please press and move the



icon by the white circle, the display will unlock automatically, see the image below:

Switch off:

1. When the device is in use, press and hold the POWER key for 3 seconds, the screen will display the power off interface, choose the power off option to confirm your selection and the system will shut down automatically.
2. Note: When the device is running low on battery power, it will sound an alarm and then shut down automatically if it isn't plugged into a power source to start charging. If the device cannot start up please check if the battery power is too low by charging the device

3.5 Power Saving Mode and Locked Mode:

Display turn off automatically when the device is under no usage status

(1) Starting power saving mode, display will turn off automatically when device not in using.

(2) Short press the "POWER" key when the device is in use will make the system enter SLEEP power save and locked mode.

Turn on the screen under inactive state

Under the power saving mode, the display is just turned off and showing a black screen. This means that music play, movies play etc. will still continue to run.

Short press the power key, the system will return to locked mode, unlock by pressing and moving the icon as pic show.



Pic. 3.1

3.6 Operation of touch panel

How to operate?

You can browse over the user interface, main menu or applications by kinds of ways:

Click:

Just touch and click, when you're going to input or choose applications on the main interface.

Press on:

Press on the icons or shortcut icons to open program you'd like, like textbox & linkage.

Slide

To move quickly on screen vertically or horizontally with your finger

Drug

Press on with certain pressure before drugging, and then keep pressing until the icon be drugged to the target place.

Rotate

To most interfaces, for example, the input text and music interface, the direction can be changed easily just by swaying the device

3.7 Main Interface

Main interface as pic.3.2, press blank place for seconds, you can use the interface of applications, shortcut icons or user-defined page as wallpaper.



Pic. 3.2

Extend out of main interface

Main interface can extend beyond of interface to provide more space for new-added shortcuts or gadgets. Pressing the blank place of interface, slide to left or to right quickly to extend to left or right of outsider interface of screen and there are two extensible interfacis available, see pic.3.3.



3.8 Apps

Click  on the top right corner of the screen, see pic 3.2, then choose your target app after entering into the main interface, see pic 3.6.

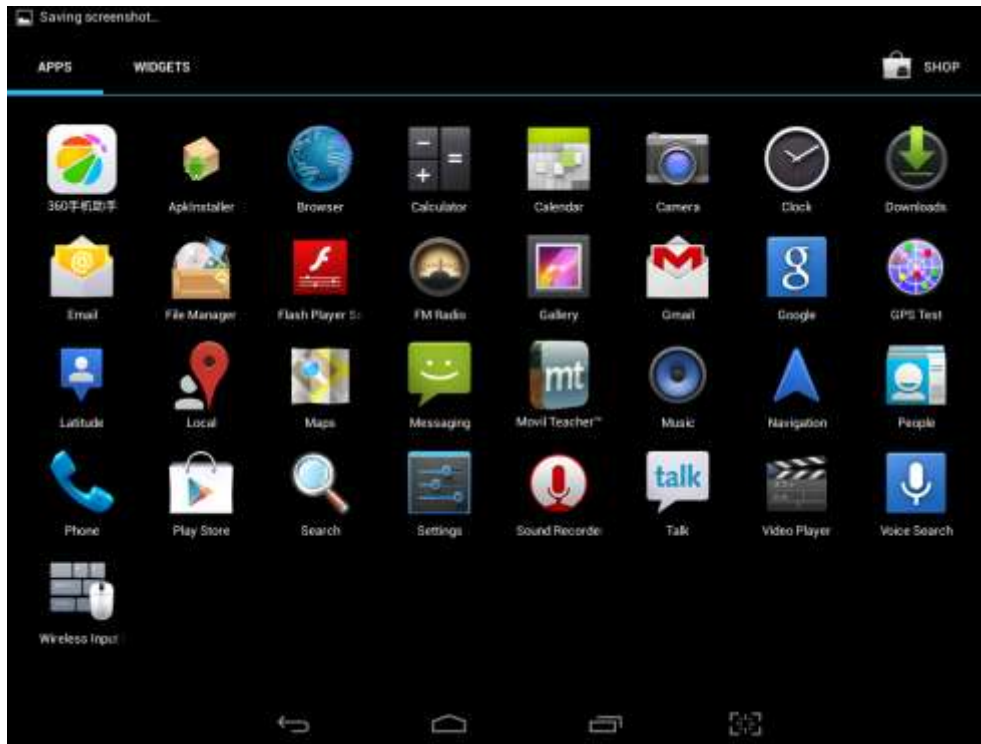

Pic 3.6

3.9 USB Connect

Storage setup

Set up the storage mode before transfer files. Connect MID and computer with USB cable.

- Open the notice interface, (refer to chapter 2.3- Condition and Status of MID).
- Clicking **USB Connected**, open the icon of USB Storage, see pic.3.7.
- USB connected successfully

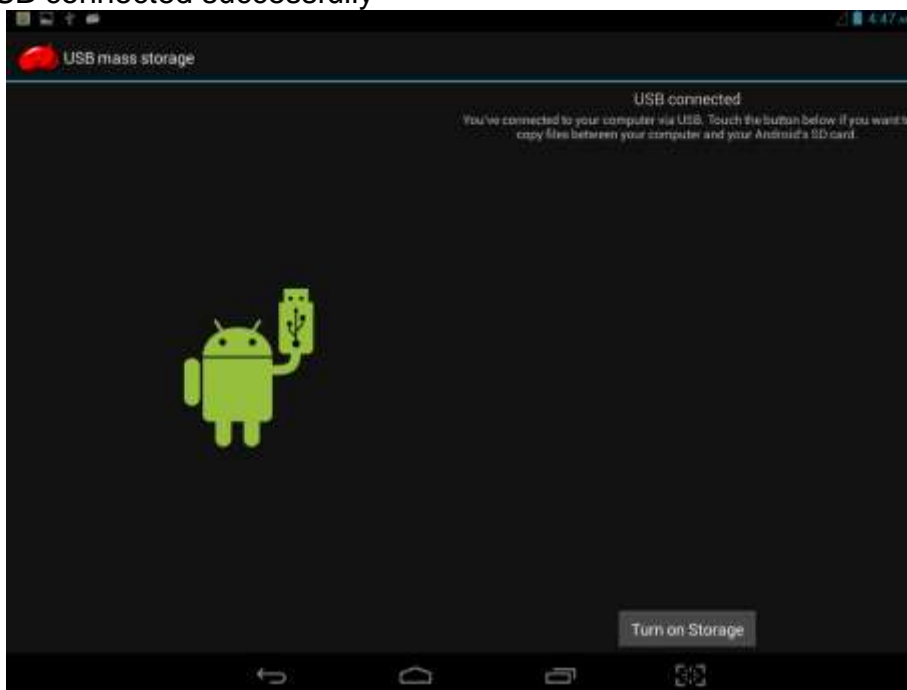

Pic 3.7

Copy files to memory card

- Connect MID and computer with USB cable.

- Set up storage mode.
- Opening the icon of *my computer*, check *removable disk(x)*.
- Find out the target files and copy them to this removable disk(x).
- Click “close USB Storage device” after copy finishes.

Note: You get no access to the memory card in MID when the MID is under USB Connection, but it is workable once USB Connection be breaking.

3.10 Input Text

Screen Keyboard

When you need to input or edit , android keyboard will show up.

Choose input method

- Open application setup.
- Click Language and input
- All input installed will list on text setup.
- Choose your target input.

Input Method use and switch

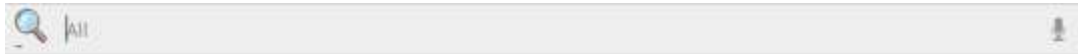

Pic 3.8

1	② Capital and small letter
2	Digital input
3	Insert whitespace
4	Execute
5	Select character on the left of cursor and long press to select all.

3.11 Use Skills

Widget interface

Click “widget” or slide on the screen to left to enter into widger interface. Long press the widget to create a shortcut, and you can enter related app quickly just through the shortcut icon on desktop.

Creat a shortcut icon on desktop

After enter into program interface or widget interface, longpress any icons, a shortcut icon will be created on the desktop, or press on and drug the icon to desktop.

Note: widget shortcut will not be created if there is no enough space left for main interface.

4 General Setup

4.1 SIM Card management, WIFI & Network

SIM Card management

Through SIM management, SIM setup can achieve, for example, turn on/off SIM or turn on/ off data connection. As pic 4.0

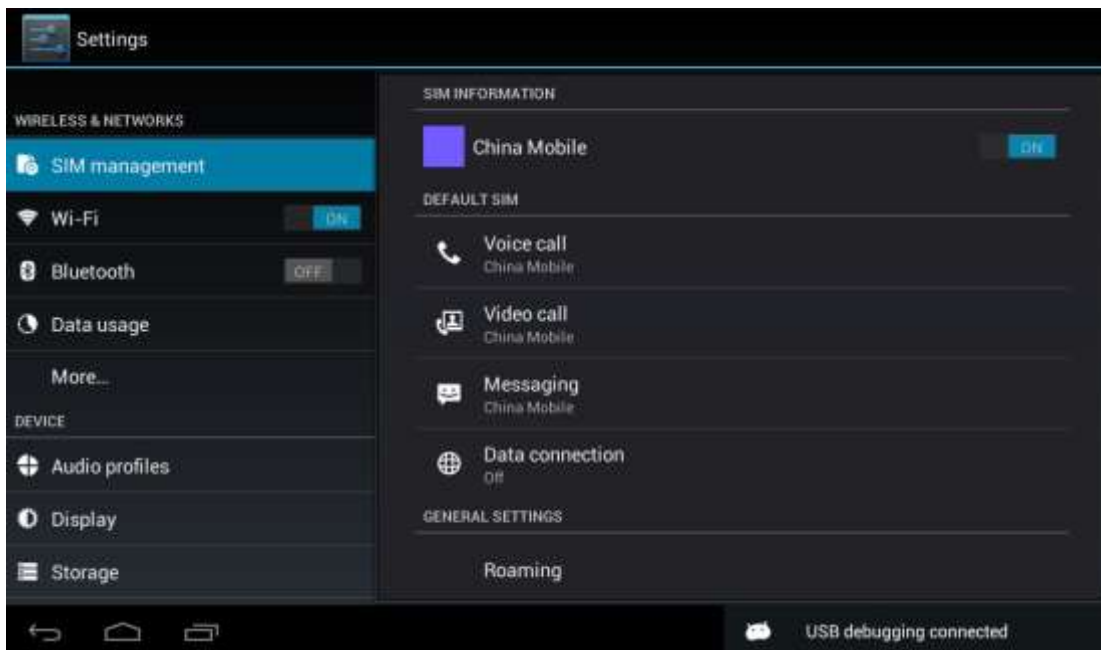

Pic 4.0

Connect WIFI

- Choose setup application on main interface.
- Turn on **WLAN**, MID will scan automatically available wifi network. See pic 4.1.
- Choose target wifi network, inputting password if requested, click “connect”



Pic 4.1

Add Network

- Click icon  top right at screen, see pic4.2.

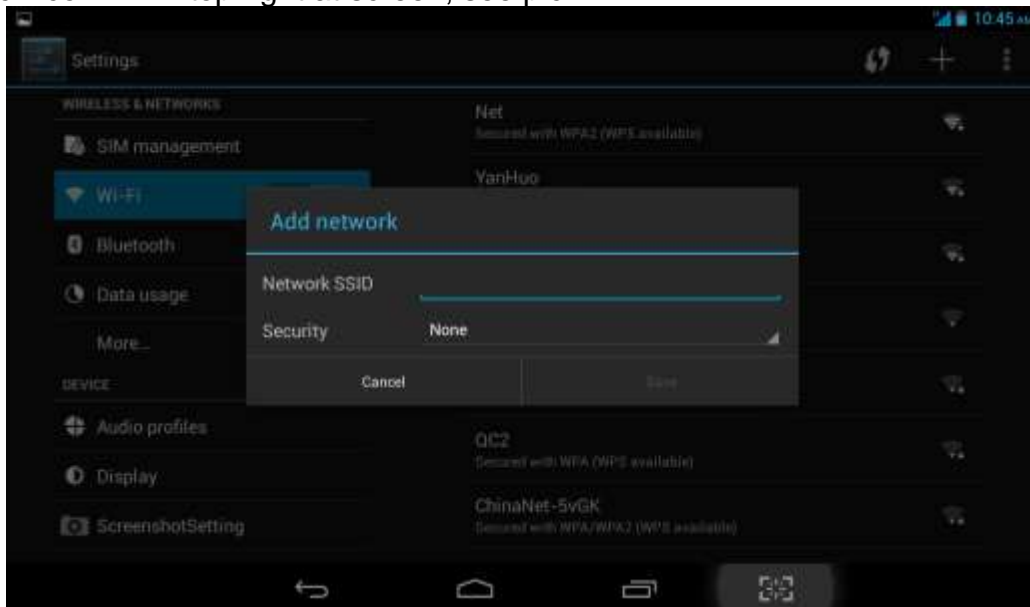

Pic 4.2

- Input network SSID, name of target network, and click “save”.
- Click user name saved and click “connect”. As pic 4.3

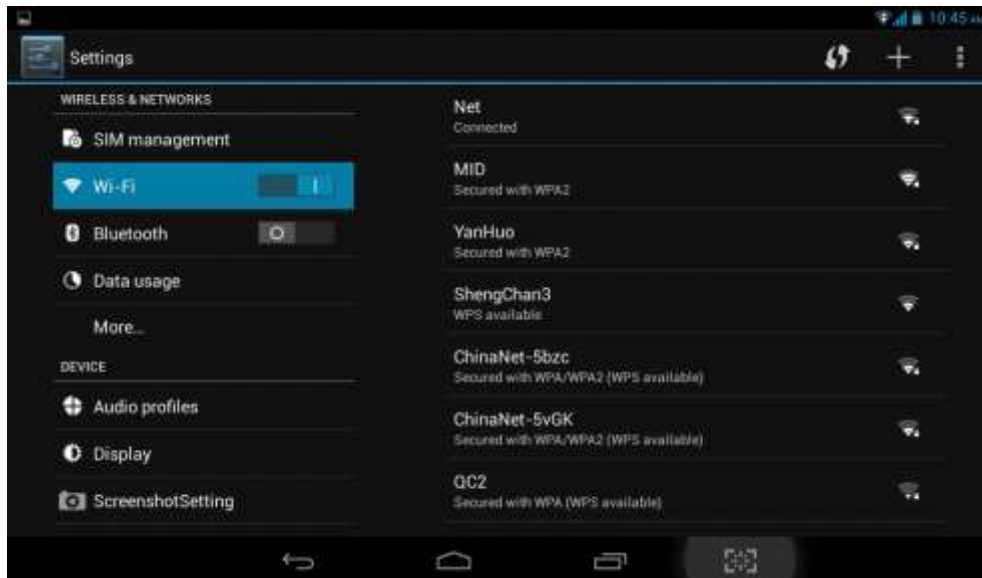

Pic 4.3

WIFI Status.

Under WIFI Status turned on, user can see the notice at bottom right corner when WLAN network available.

Connect WLAN during sleep mode.

- Click icon  top right at screen, see pic4.3, and choose high class mode.
- Click “keep Wi-Fi on during sleep” and choose accordingly the option prefer to. See pic4.4.

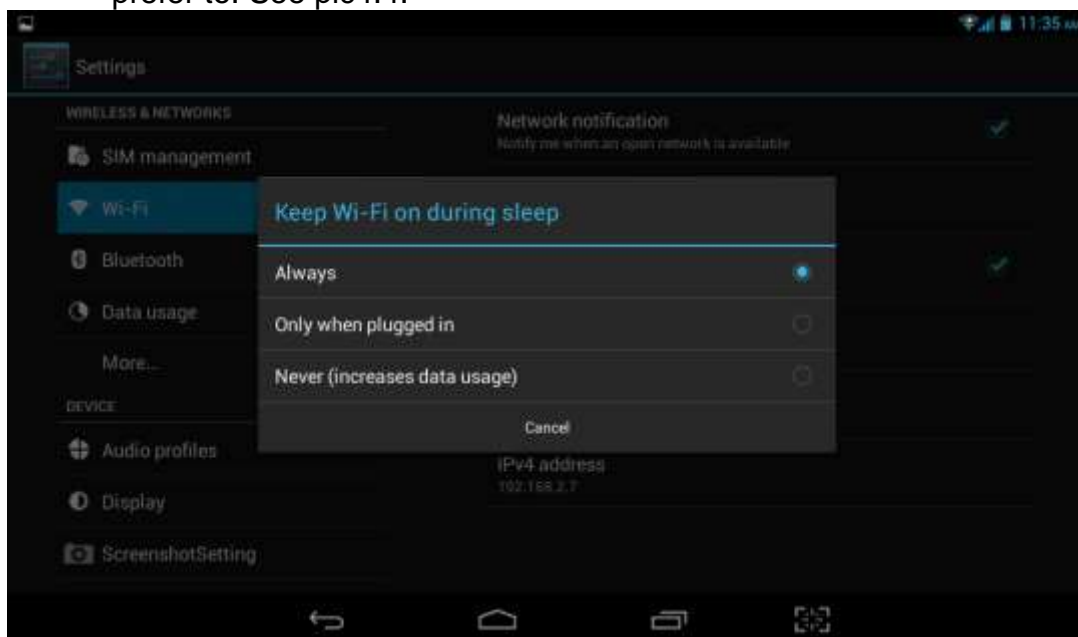

Pic 4.4

4.2 Bluetooth (Optional)

- . Choose *settings* application on main interface.
- Turn on Bluetooth as shown below.
- The device will find the nearby device automatically when you click “search for devices”. See pic. 4.5.

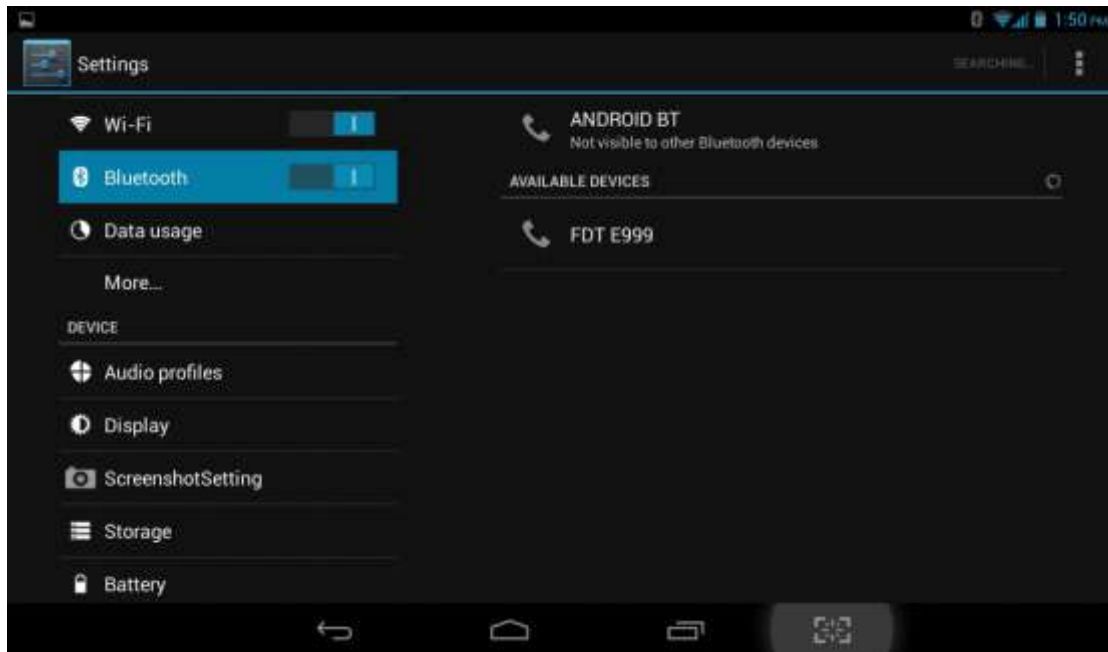

Pic 4.5

- Click the target device name, input the password and choose “pair” for sure after “Bluetooth pairing request” window pop up.
- Click icon , entering into the interface see pic4.6, and then you can operate accordingly. Target device name can be renamed if need.

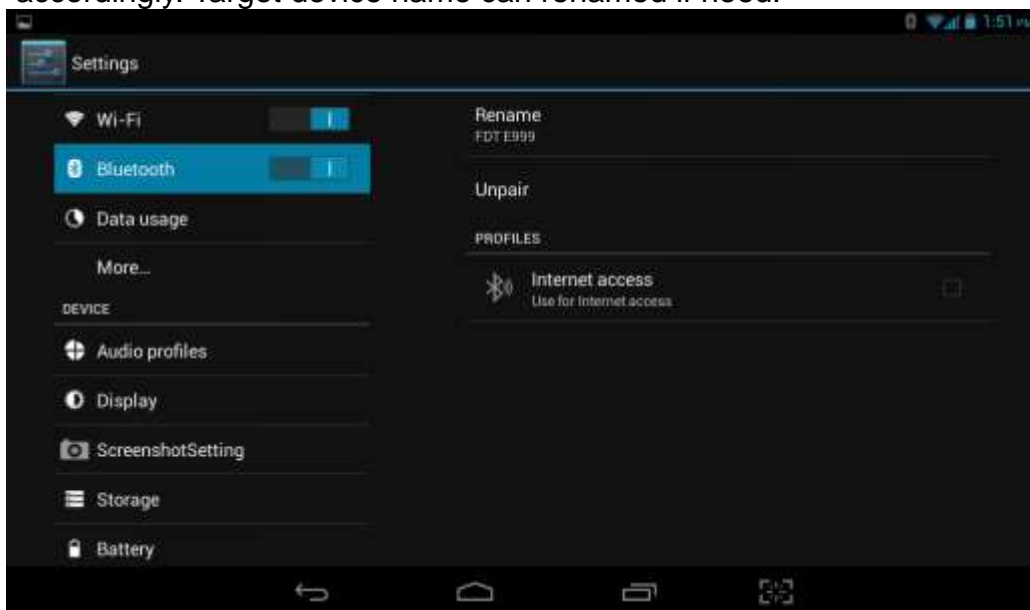

Pic 4.6

4.2.1 Bluetooth setup

Rename

Click icon , as pic. 4.7 shown, choose “rename tablet” and change to the name as what you want.

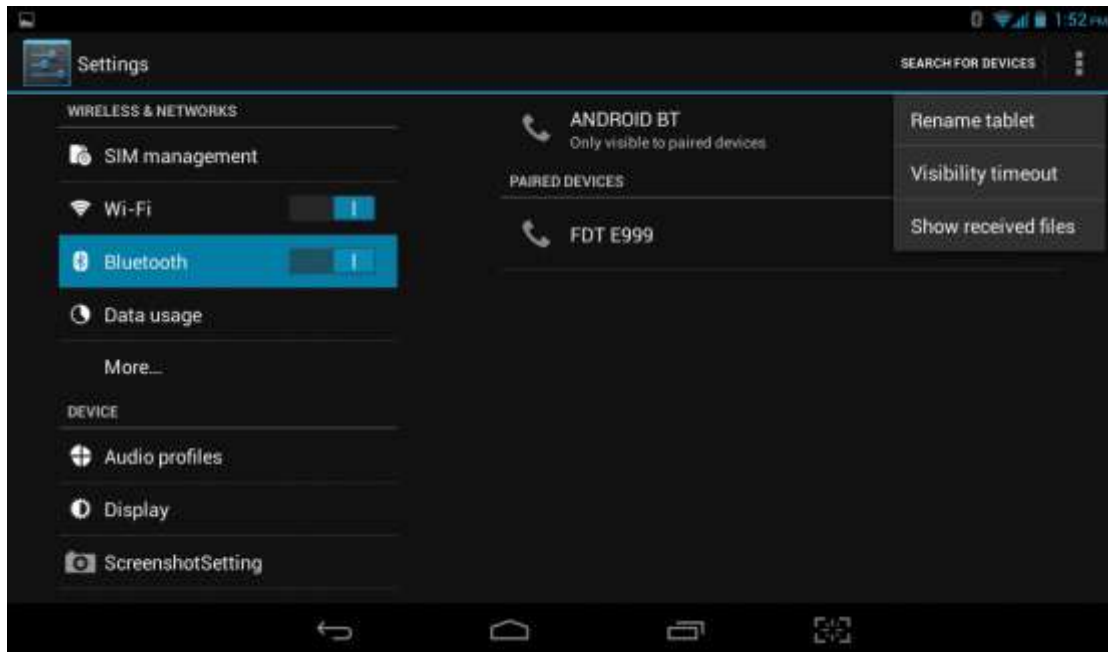

Pic 4.7

Visibility Timeout

As pic. 4.7 shown, click “visibility timeout” and choose time options accordingly. See pic4.8. (Note: visibility timeout refers to the time setup of device be visible.

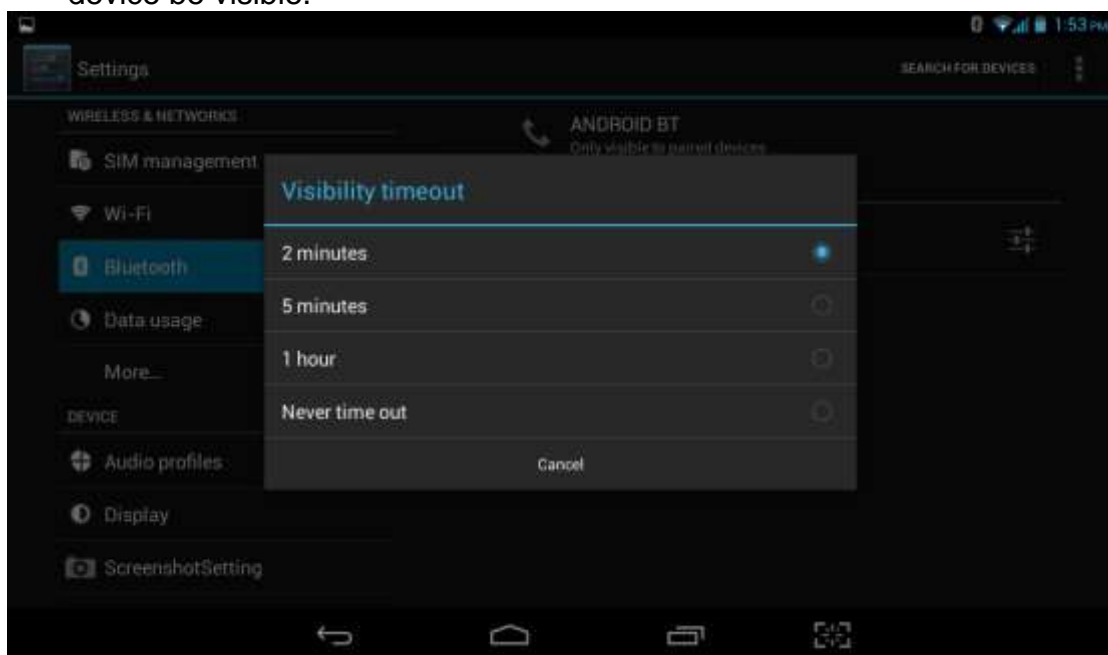

pic4.8

Show received files

As pic. 4.7 shown, choose “show received files” and you can see all the files download or upload.

Advanced setting.

As pic. 4.7 shown, choose “Advanced setting” and set up accordingly, as pic4.9.

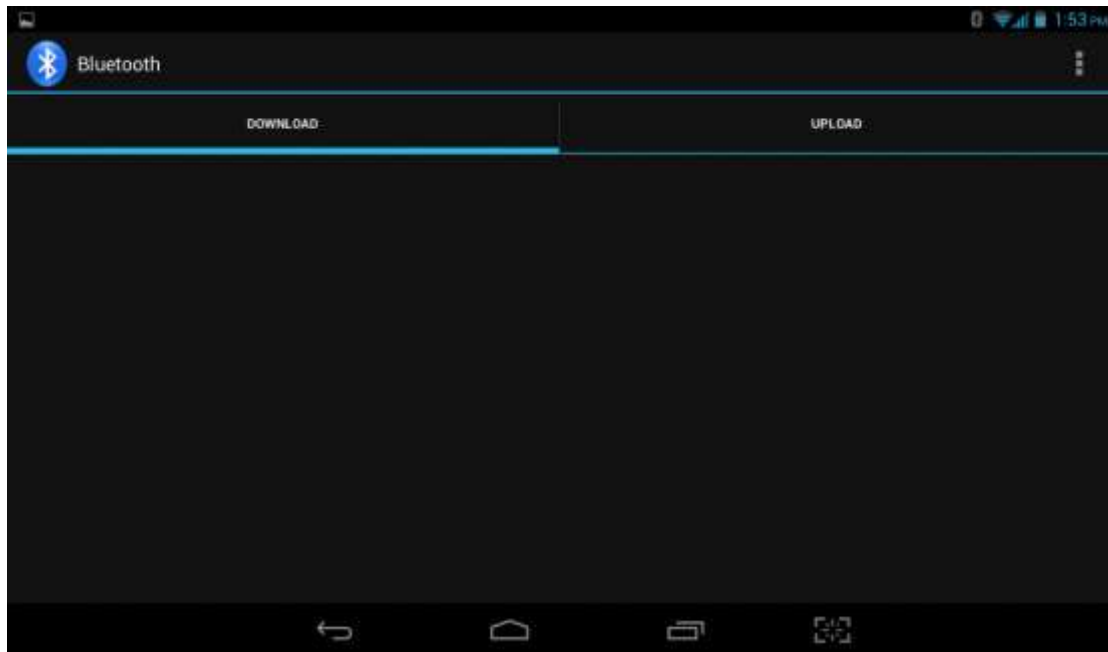

Pic 4.9

- **FTP Server**

Turn on FTP Server means access to server-side files and operation by client-side is allowed.
- **Proximity reporter**

Under proximity reporter turn on, the device will prompt by make a noise when distance between the two devices is too far away or when disconnect.

4.3 Data Usage

SIM Card data usage, see pic.4.10



pic4.10

WIFI data usage

Click icon , Choose "Show Wi-Fi usage", see pic. 4.11.



Pic 4.11

4.4 More...

4.4-1 Airplane Mode

Airplane mode is function for quick turn off of WIFI & SIM Card. WIFI & SIM card is out of reach under airplane mode, but it recovers once airplane mode turn off

4.4-2 VPN

Open VPN and add **VPN network**, see pic. 4.12. Input network name and related server address, and click “save” for sure.



Pic 4.12

Click VPN created, as pic.4.13 shows. Input VPN Account & password accordingly, and click “connect” to finish.

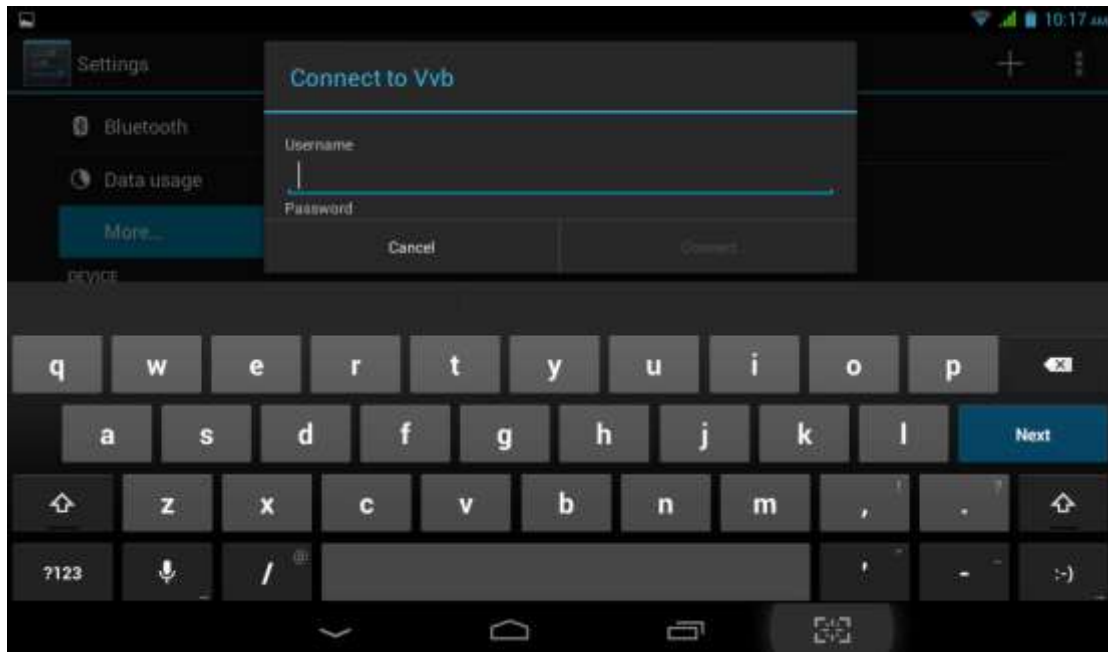

Pic 4.13

4.4-3 Tethering & portable hotspot

Tethering & portable hotspot

- Click the app “settings” on menu interface.
- Make sure the device is under wifi connected. Choose More... and click “Tethering & portable hotspot”.

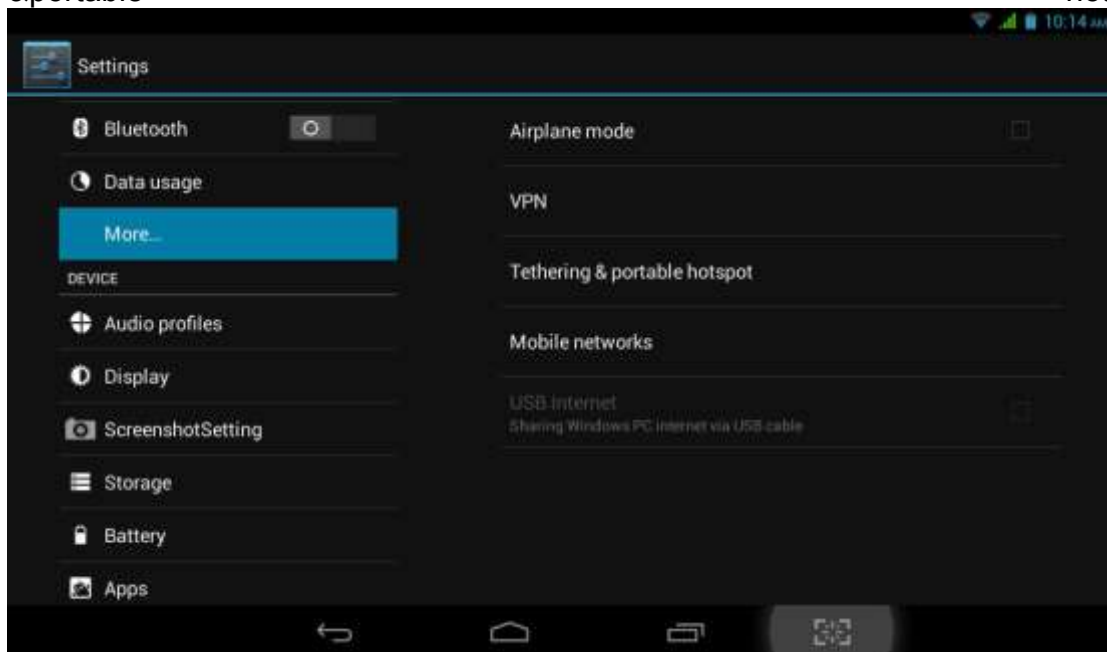

Pic. 4.14

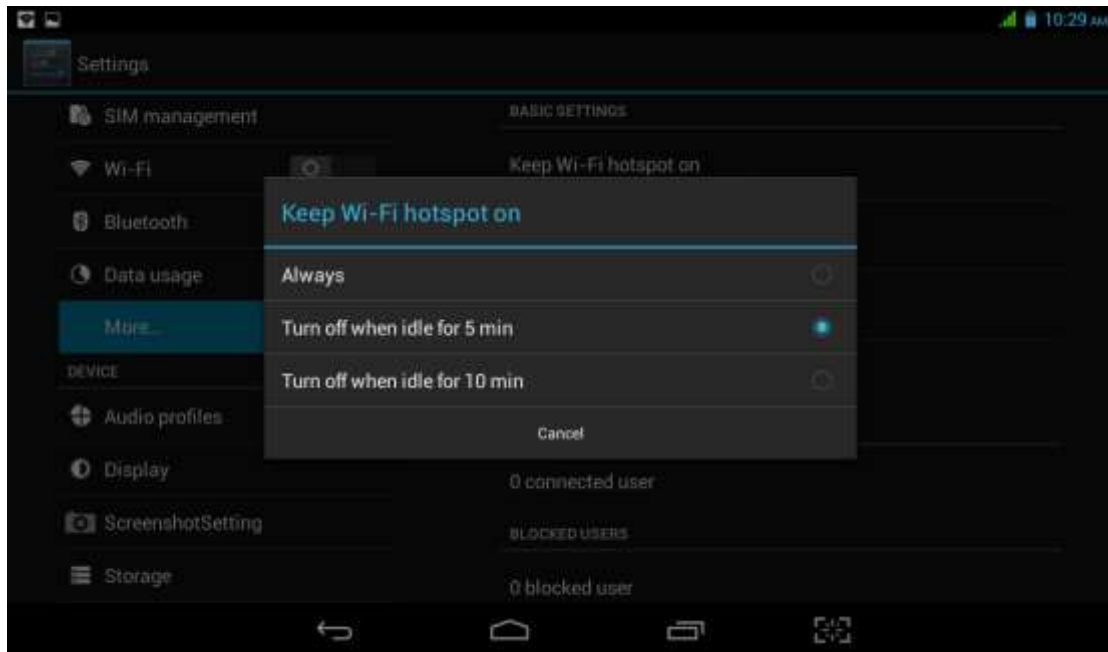

Pic 4.15

- Clicks “keep Wi-Fi hotspot on” and choose suitable period.
- Click icon “return”, opening portable Wi-Fi hotspot and click “setup Wi-Fi hotspot”.

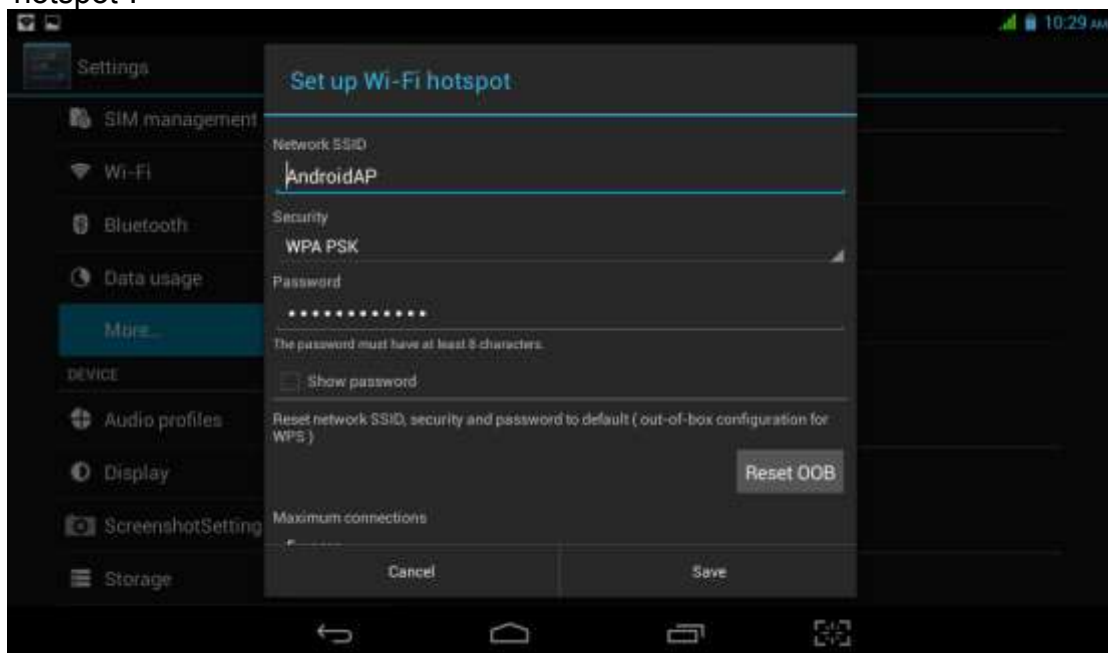

Pic 4.16

- Set up password for network encryption, and password should no less than 8 digits.

4.4-4 Mobile Networks

- **Data enabled**
Under data enabled, you can use 2G/3G network through the SIM card.
- **Data roaming**
Under data roaming, you can surf the internet by SIM card in the situation of roaming.
This data roaming means roaming between operators, but not areas.
- **Network mode**
Choose 2G/3G frequency channel. GSM means 2g network, this device

support GSM 850/900/1800/1900MHz and 3g WCDMA 2100MHz. 3g frequency channel WCDMA 850MHz/900MHz/1900MHz is optional. See pic 4.17.

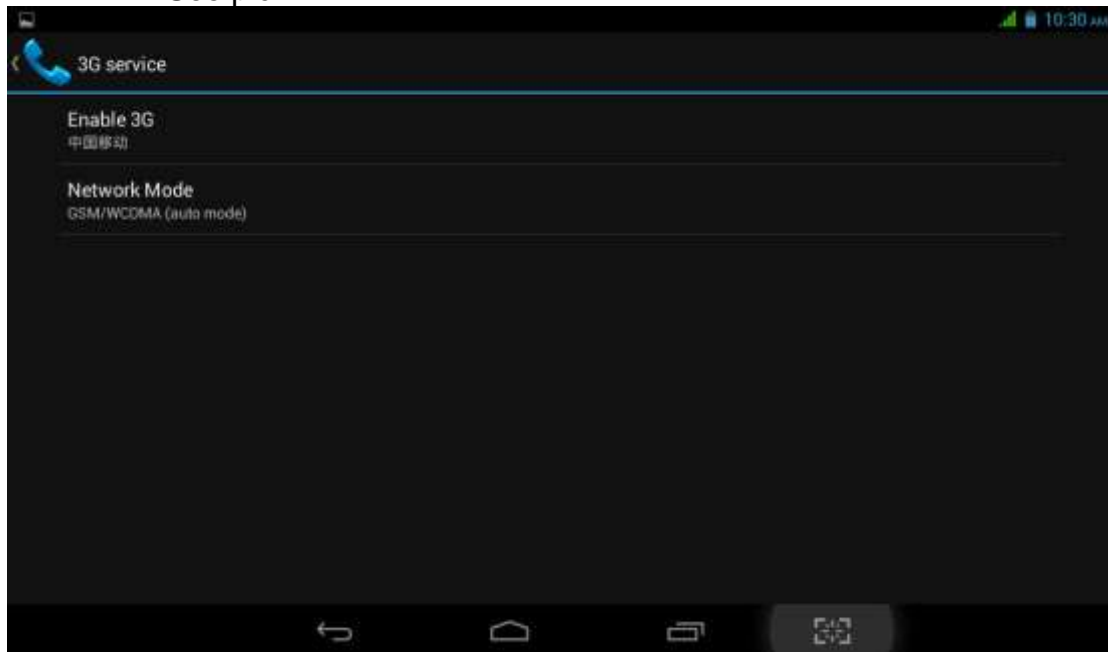

Pic 4.17

(1) Access Point Name(APN)

Click *Mobile network settings*, see as below picture 4.18:

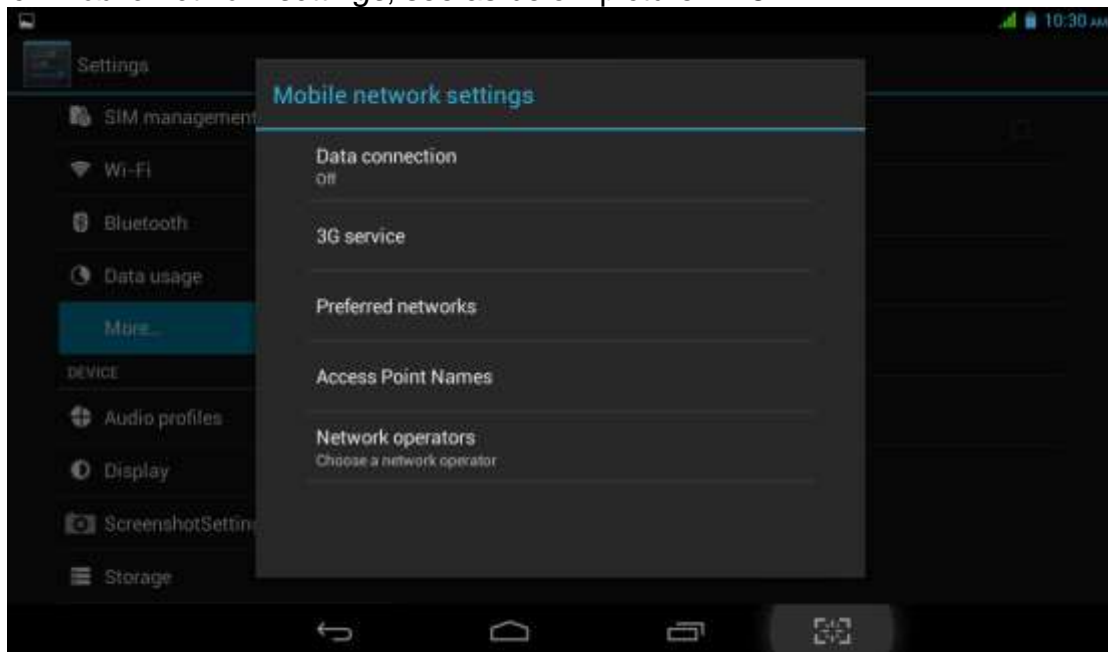

Pic 4.18

(2) Access point name (APN)

Choose the corresponding connection method see as below picture 4.19:

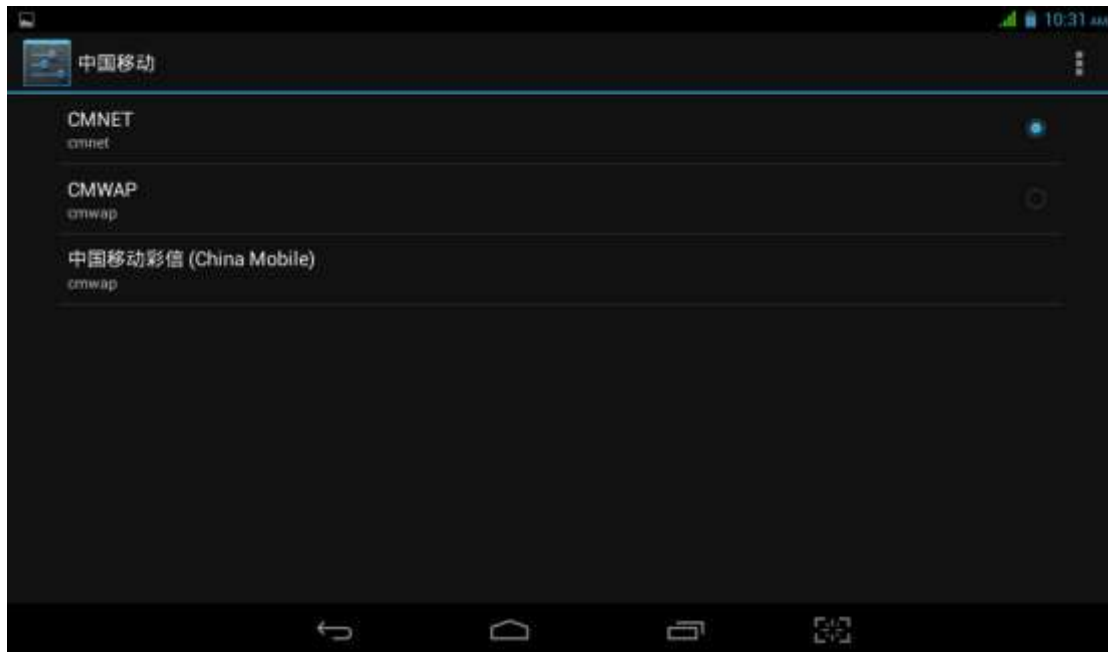

Pic 4.19

Notes : (CMWAP transfers the data via GPRS, it can only visit wap webpage, but CMNET supports www browser on mobile internet, it can log in the similar web page the same as we surfing on the computer. Meanwhile, the charges for them are different.)

(3) Network operator

Click operator, tablet system will automatically search available networks GSM and WCDMA, see as below picture 4.20;

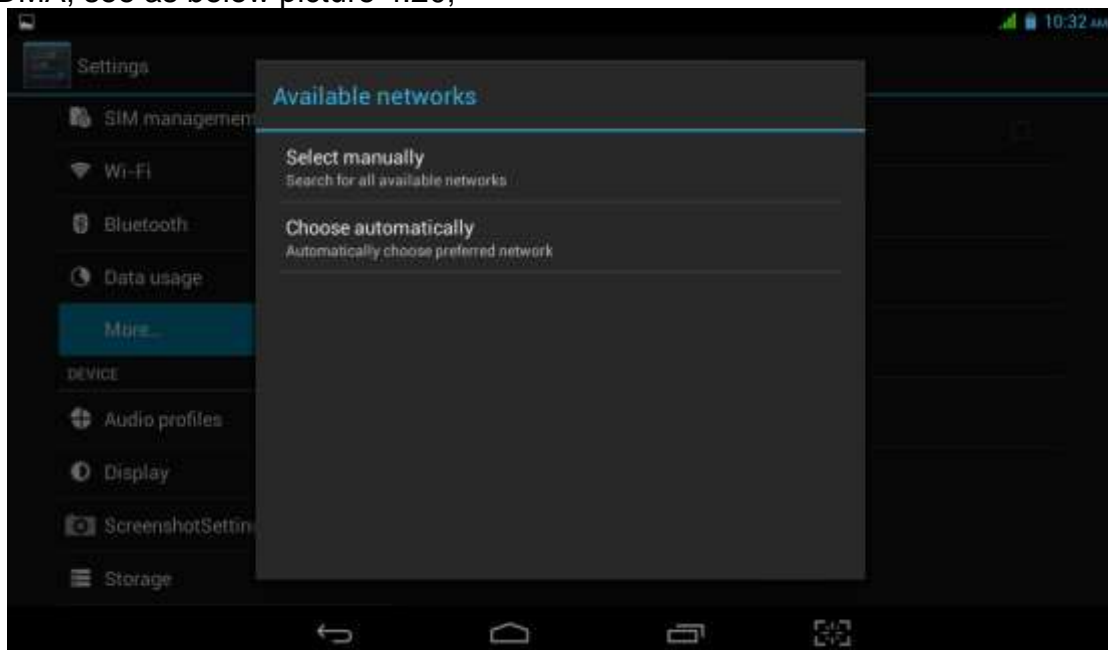

Pic 4.20

4.4-5 GPRS data priority mode

When open the GPRS data priority mode, it will give preference to your use of the telephone network.

4.5 Audio Profiles

Open *setting* and choose *Audio profiles* and you can choose different mode for setting see as below picture 4.21;

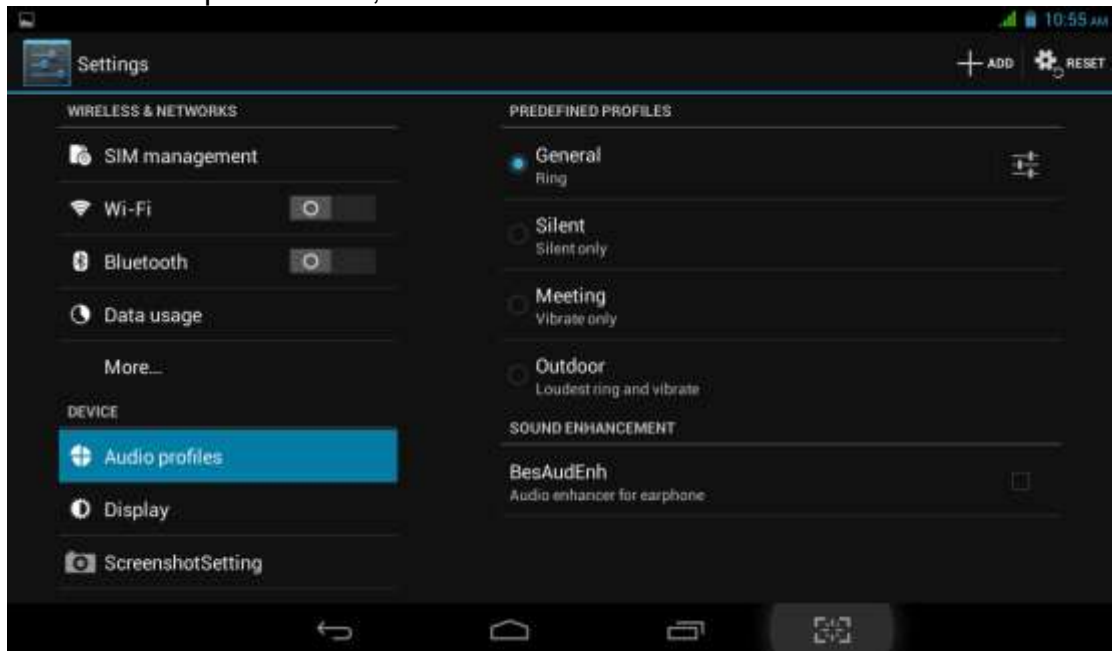

Pic 4.21

Click *General* and access to setting see as below picture 4.22;

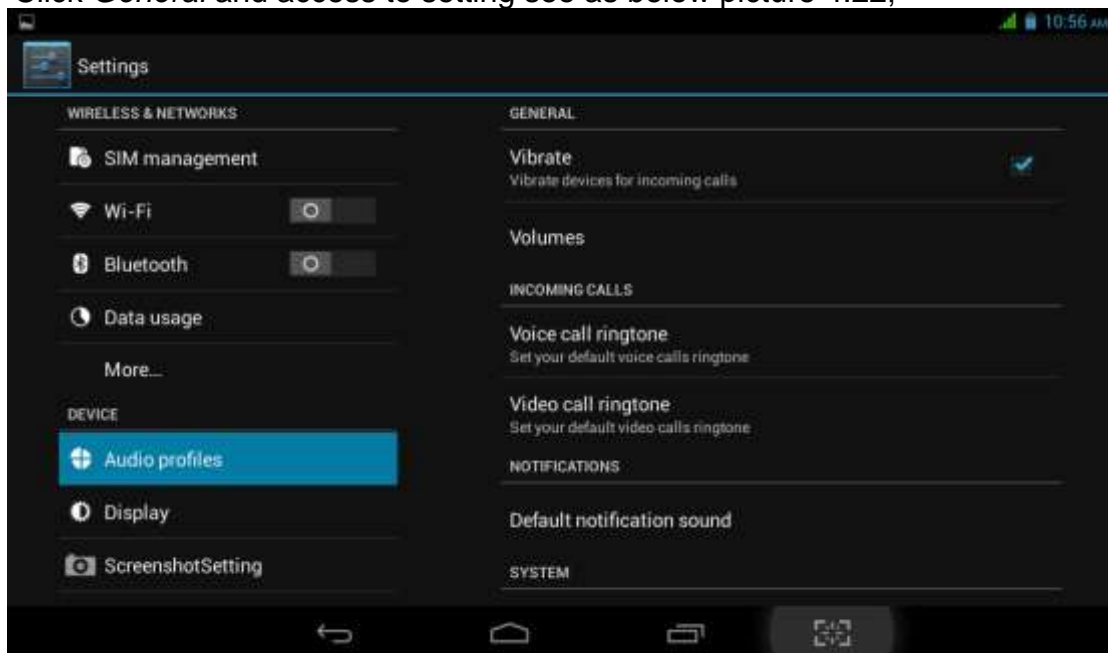

Pic 4.22

Vibrate

Click *Vibrate* which can realize the vibration effect on MID when you dial phone call, see as above picture:

Volumes

Click *Volumes* which can control the volumes of Ringtone & notifications、alarms, see as below picture 4.23;

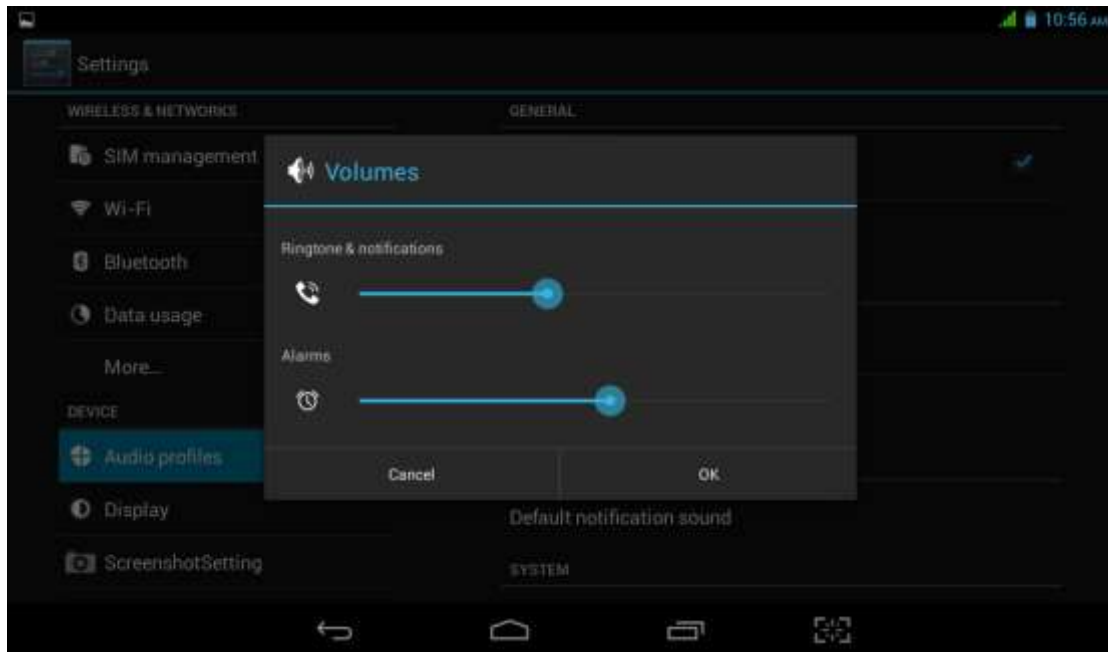

Pic 4.23

Voice call ringtone

Click *voice call ringtone* and you can choose the different ringtone as you like, see as below picture 4.24;

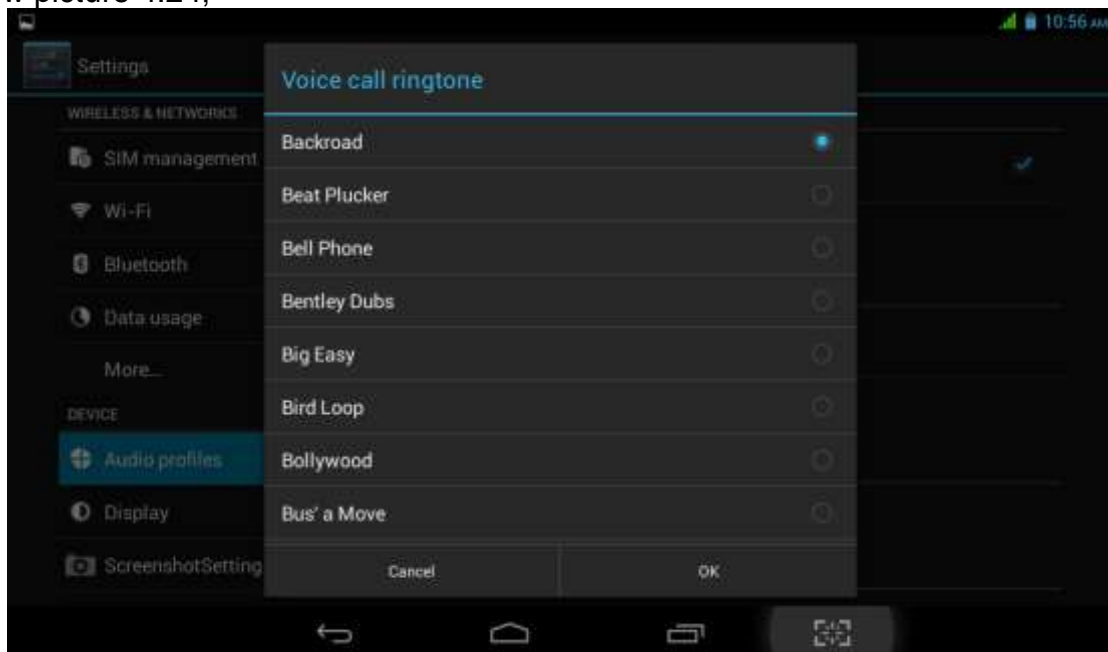

Pic 4.24

Video call ringtone

Click *video call ringtone* and you can choose different mode of ringtones, see as below picture 4.25;

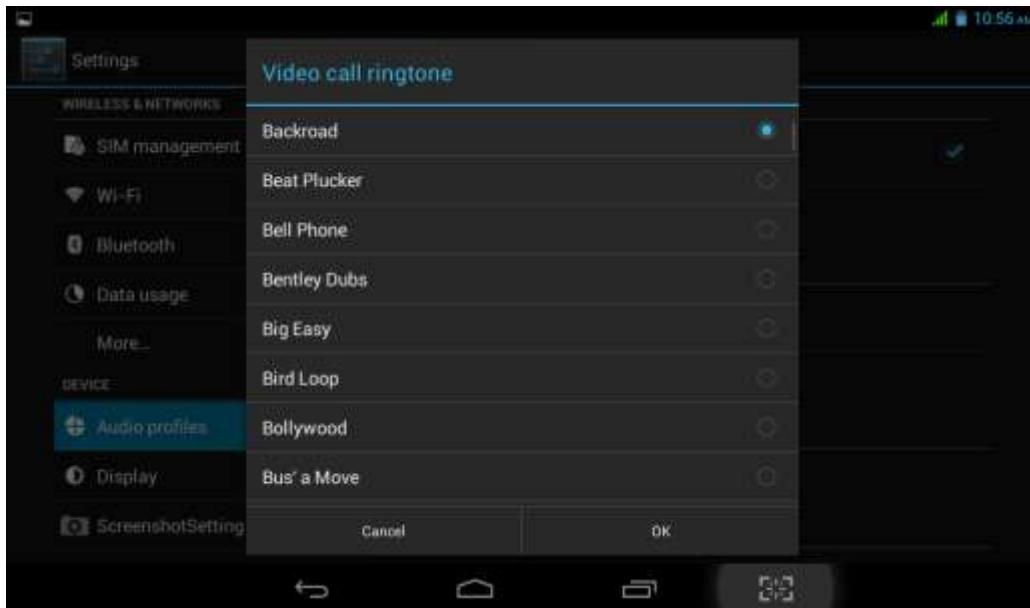

Pic 4.25

System

It can be checked by ON/OFF, “Dial pad touch tones”, “Touch sound”, “Screen lock sound”, “Vibrate on touch”.

(Notes: except *standard, silent, meeting, outdoor mode* can only be chosen but not be set.)

4.6 Display

4.6-1 Brightness

- Click *setting* Apps
- Click *Display* → *Brightness*.
- When pop-up brightness Settings panel, you can drag the brightness slider to adjust degree between dark and bright. See as shown picture 4.26;

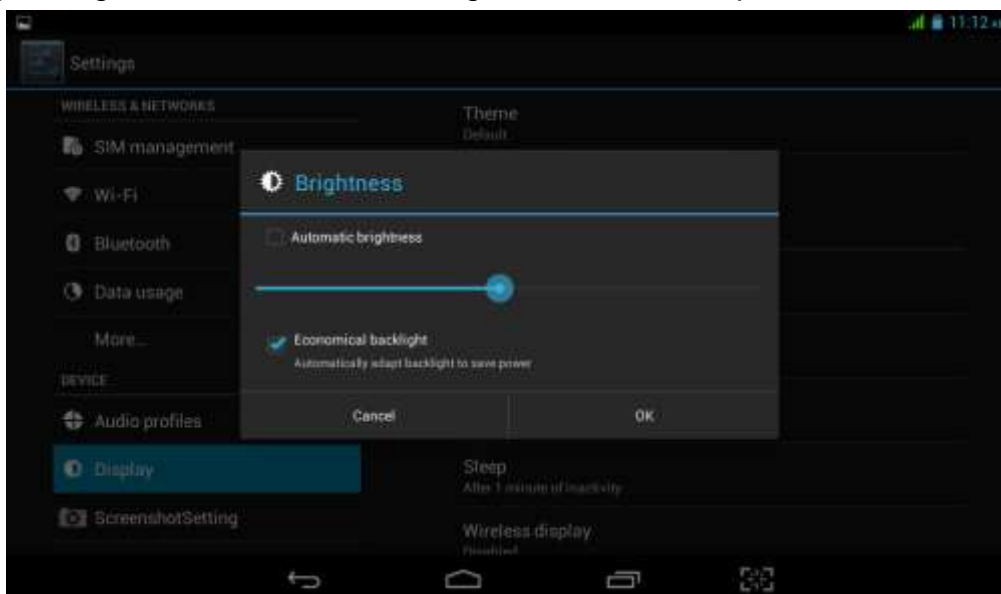

Pic 4.26

- Once you set up the brightness, click *ok*.

4.6-2 Wallpaper

- Click *Setting* Apps
- Click ***Display***→***wallpaper***
- You can choose the wallpaper as you like, such as *live wallpaper - gallery* (custom) - *wallpaper* (system) - *video wallpaper*, as shown in picture 4.27;

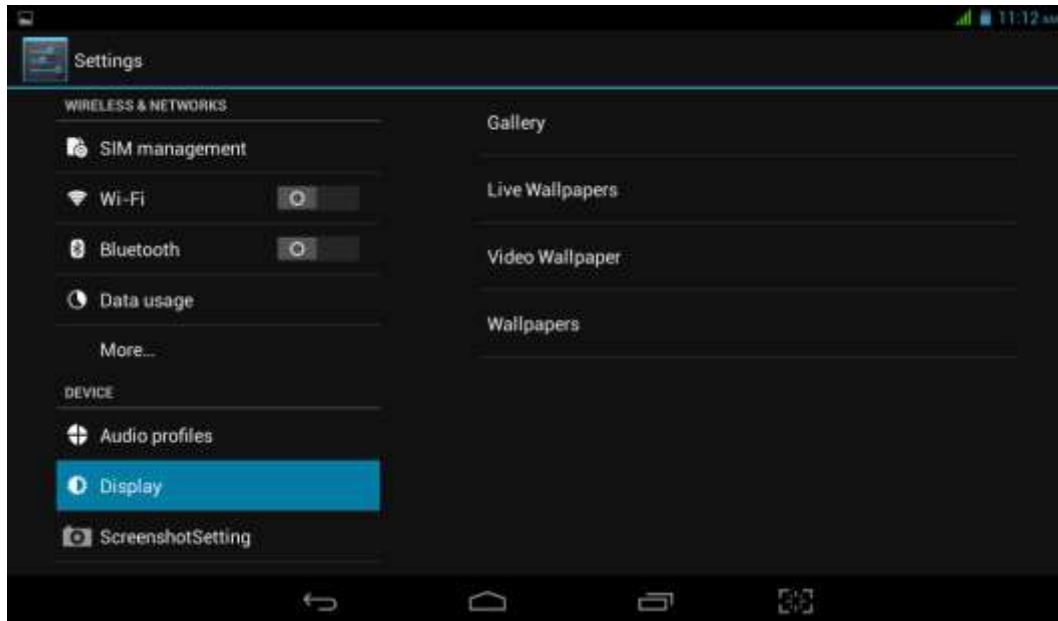

pic4.27

4.6-3 Automatic rotation

System as the default open, when closed, the system will not rely on gravity induction to shift MID panel.

4.6-4 Sleep

- Click *Setting* Apps
- Click *Display*
- Click *Sleep*
- When pop-up the page of sleep time setting, you can choose the sleep time as you like. See as below picture 4.28;

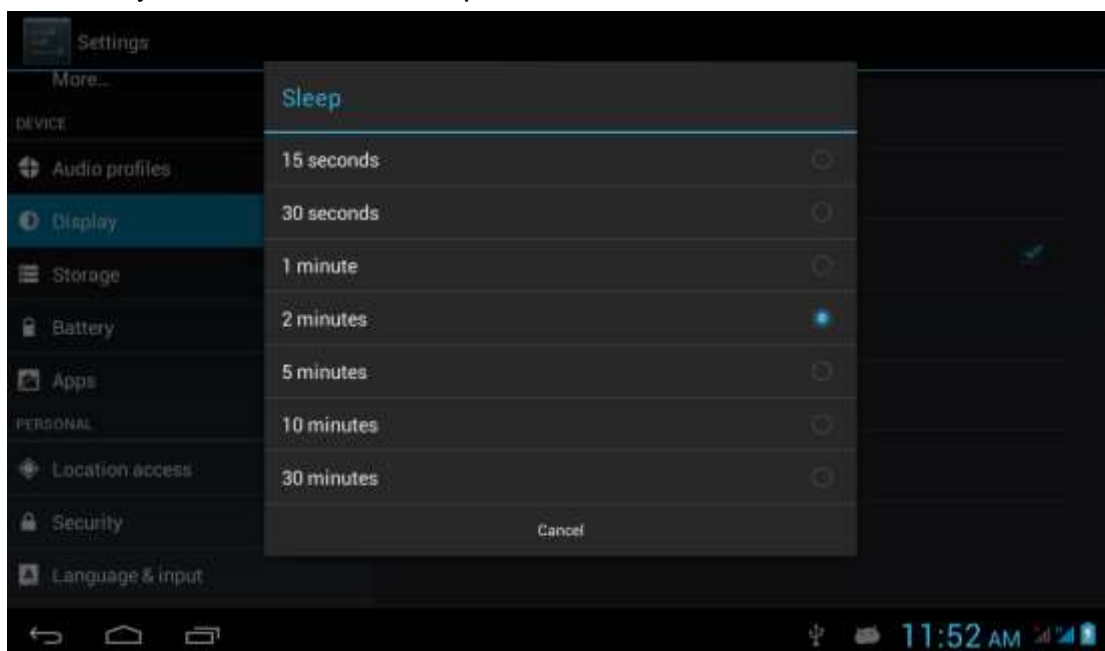

pic4.28

4.6-5 Font Size

Click *Font Size* which can adjust font size of the MID, see as below picture 4.29;

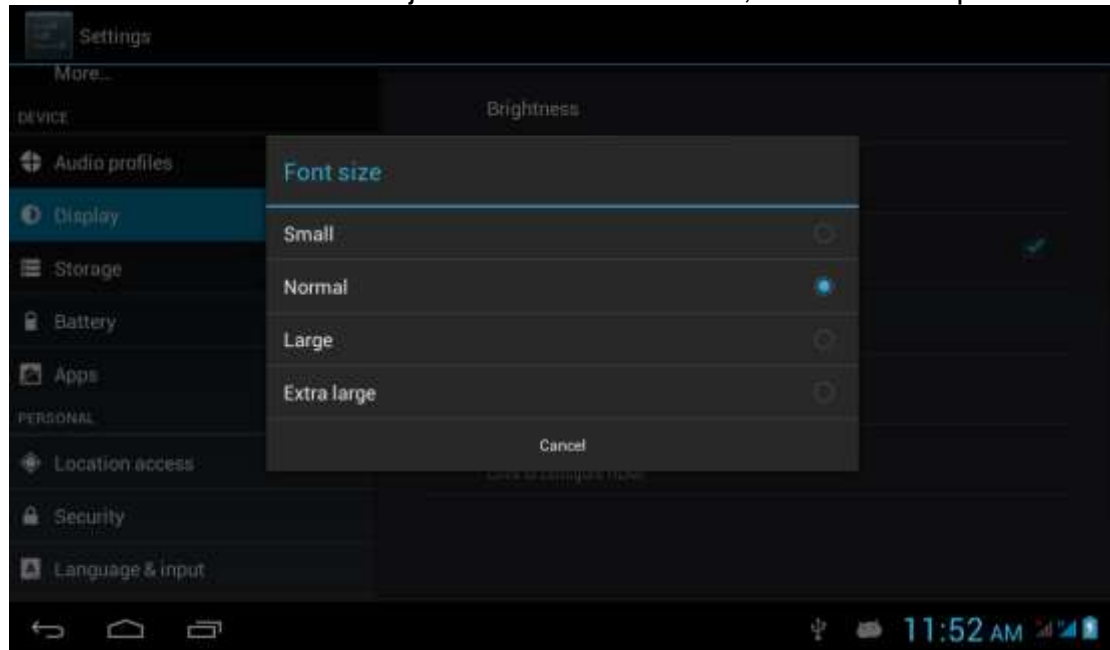

Pic 4.29

4.6.6 Screen shot setting show as Pic 4.30

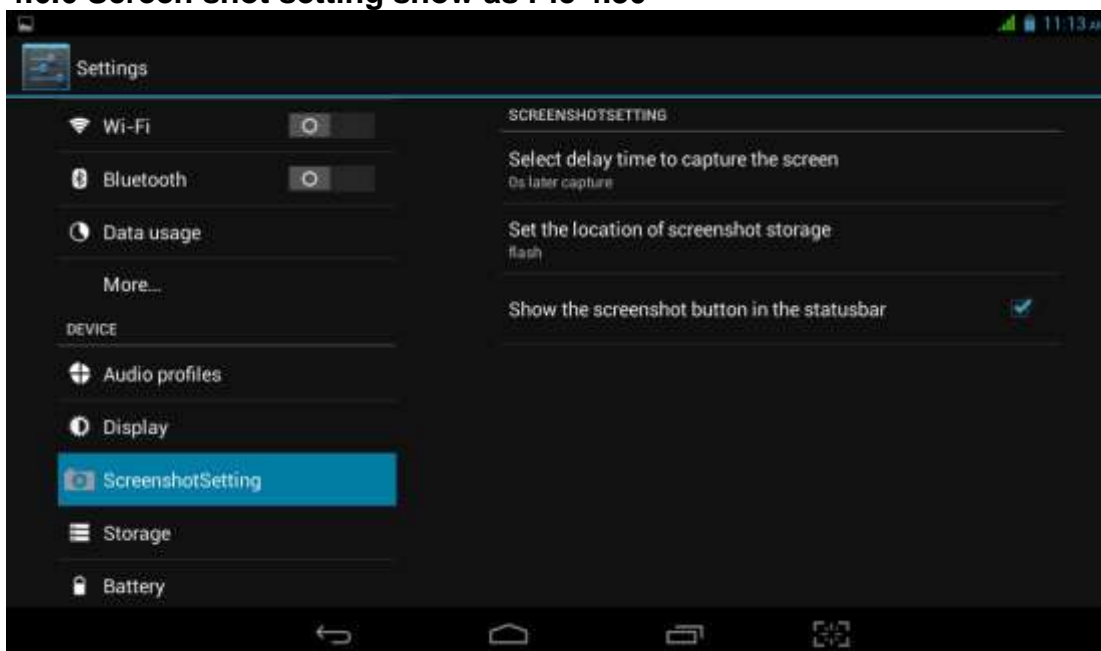

Pic 4.30

4.7 Storage

Open *setting* Apps→*Storage*→*DEFAULT WRITE DISK*, you can choose the preferred installation space when you install new applications.

Check available space of SD Card and MID.

- Enter into *setting* Apps

- Click *storage* to check total space.

Internal storage

Internal storage which is the system files storage space but can not check the content, see as picture 4.31;

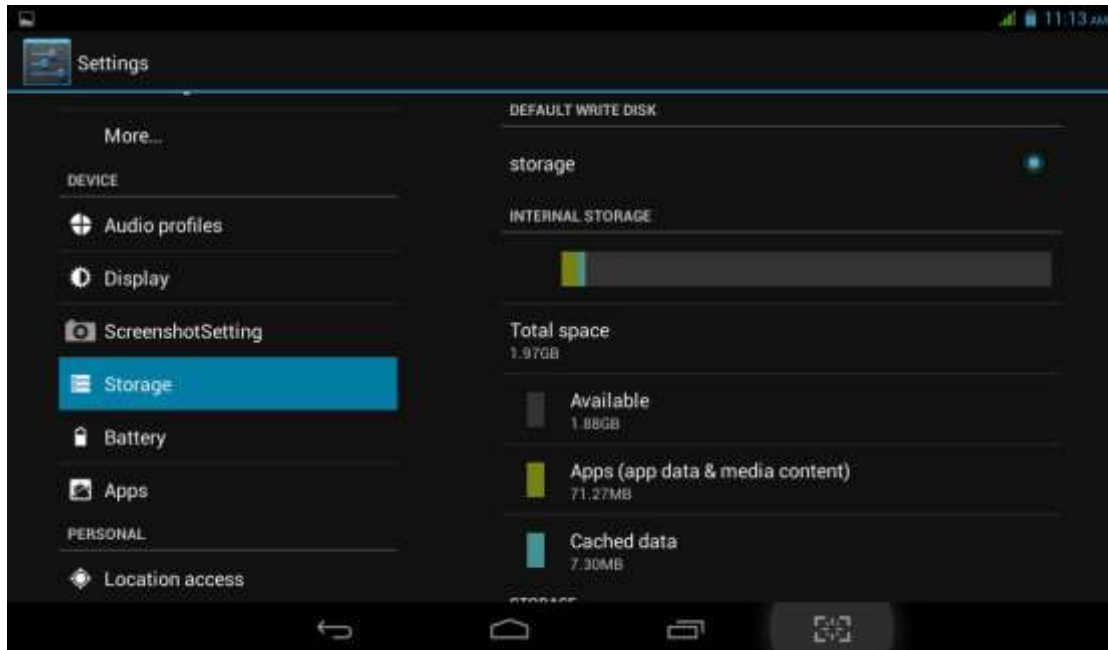

Pic 4.31

USB STORAGE

USB Storage is MID NAND memory. If want to check the storage content you can go to *main menu* → *files managements* for checking.



Pic 4.32

SD Card

In the storage you can check the SD Card total space, available, unmount SD Card and Erase SD Card, and see as below picture 4.33;

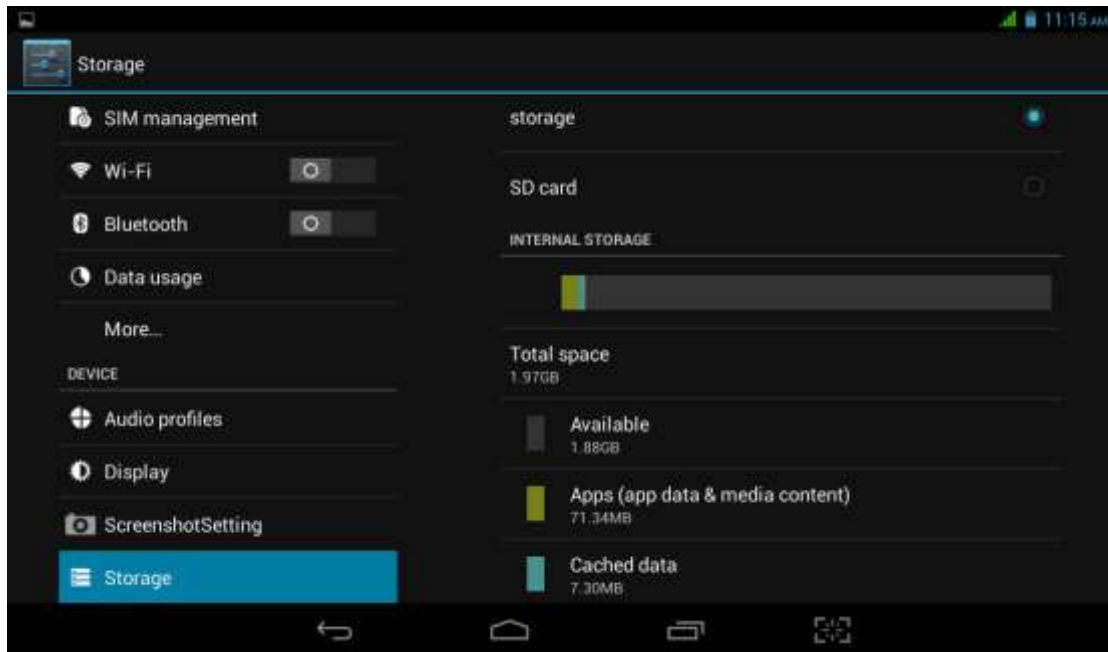

Pic 4.33

Remove SD Card safely

- Click *setting* Apps
- Click *storage*
- Click *uninstall SD Card*
- Now you can remove the SD Card safely.

Notes: If you remove the SD Card correctly, it can effectively protect it and increase the usage life of the SD Card.

4.8 Battery

Click *settings* → *battery* and then to check the battery using status as shown below:

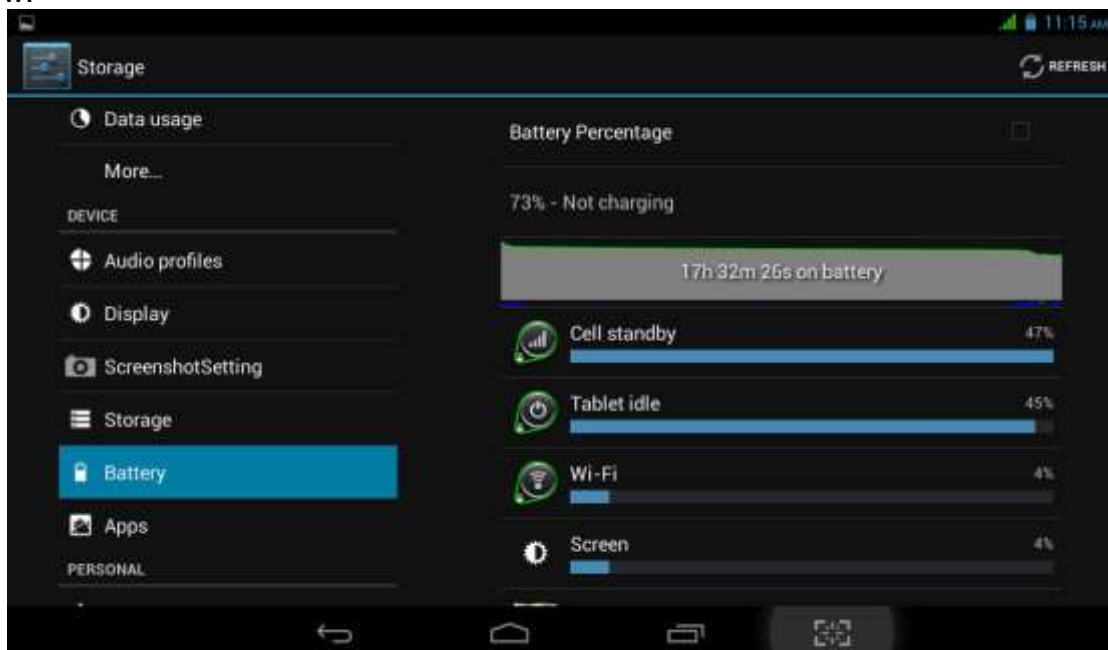

Pic 4.34

4.9 Apps

1. Please select setting in the application list.
2. Choose application and enter and then you can manage and delete the installed applications. In the lower left corner you can check the system storage space, see as below picture 4.39;

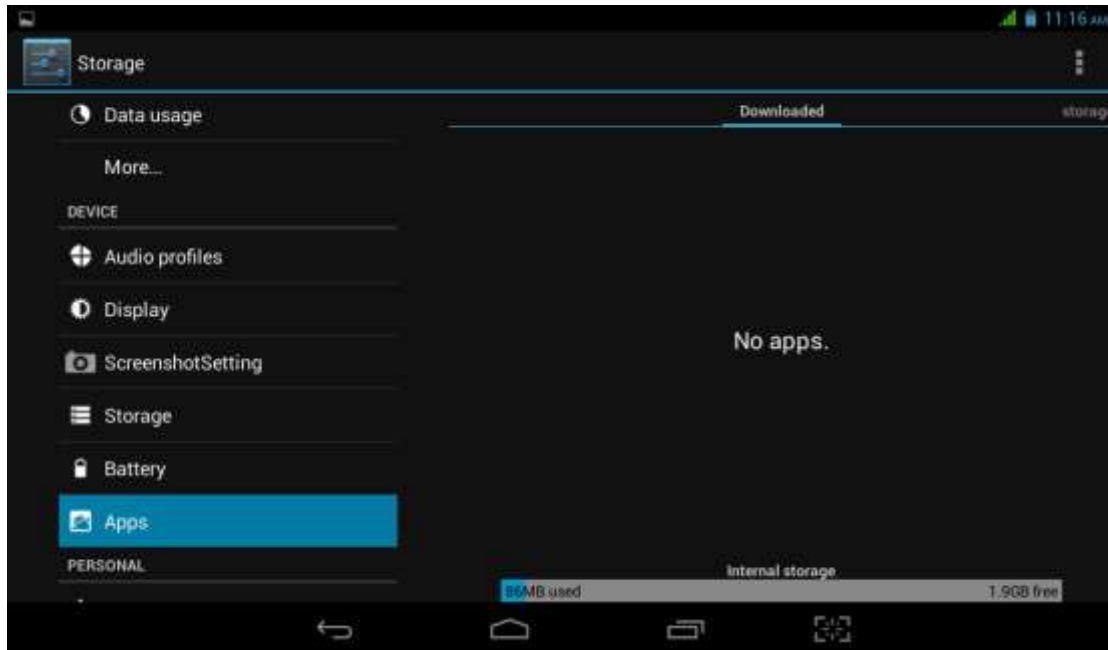

Pic 4.39

3. Check *internal storage space*; see as below picture 4.40;

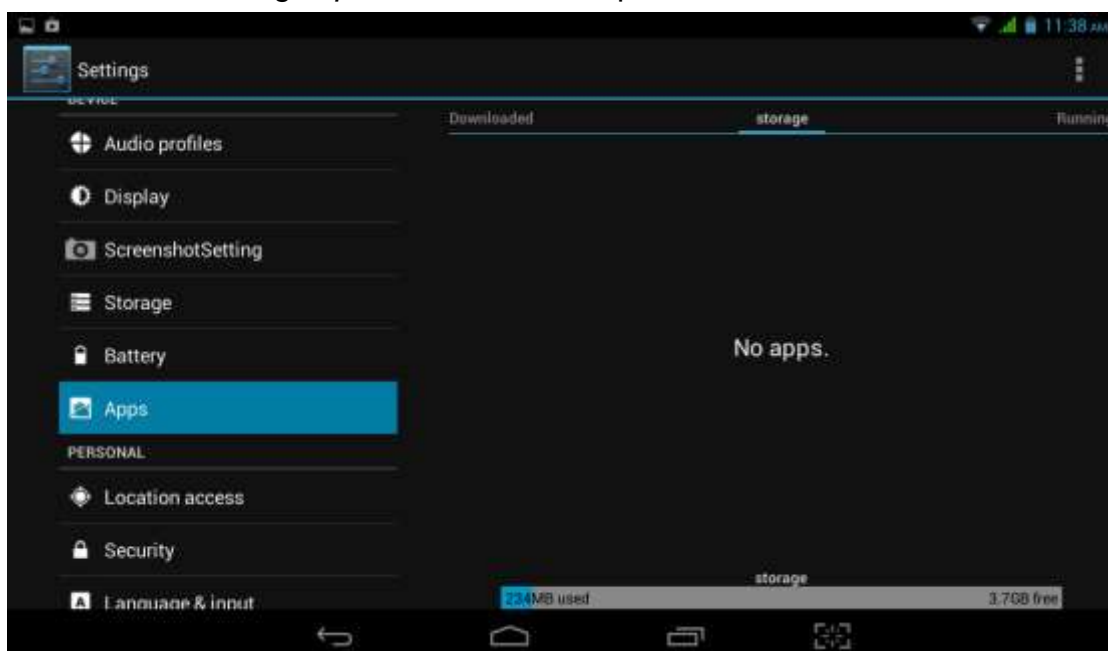

Pic 4.40

4. Check the running applications of their usage and available space see as below picture 4.41;



Pic 4.41

4.10 Account

1. Click *setting*
2. Click *Add account*, see as picture 4.42;

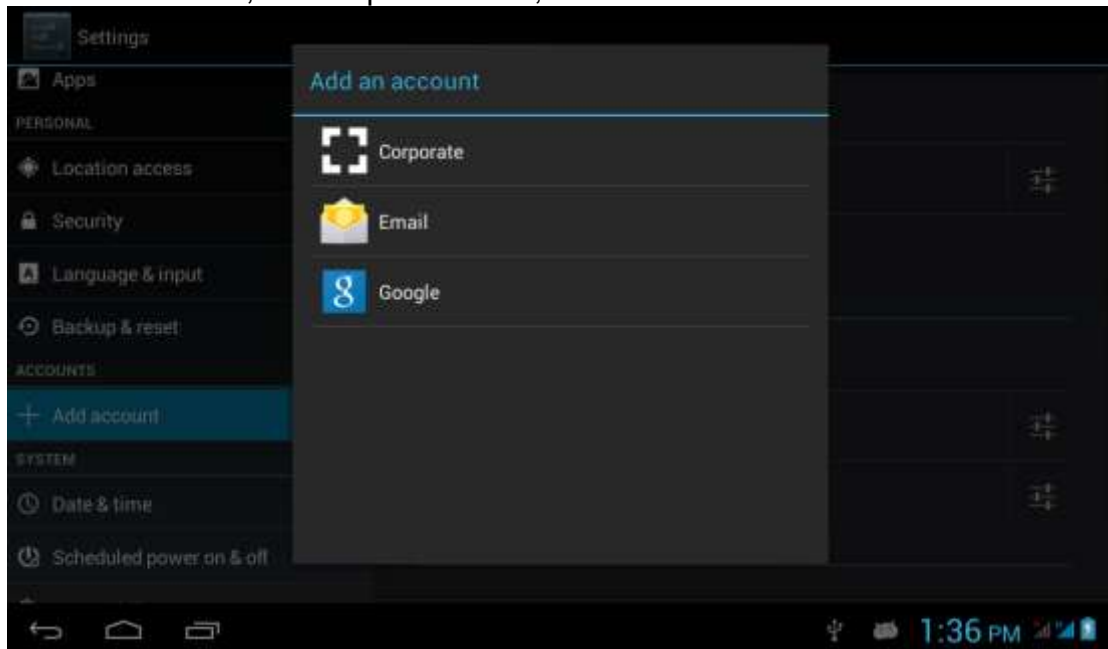

Pic 4.42

3. For example tap *Google*, see as picture 4.43;

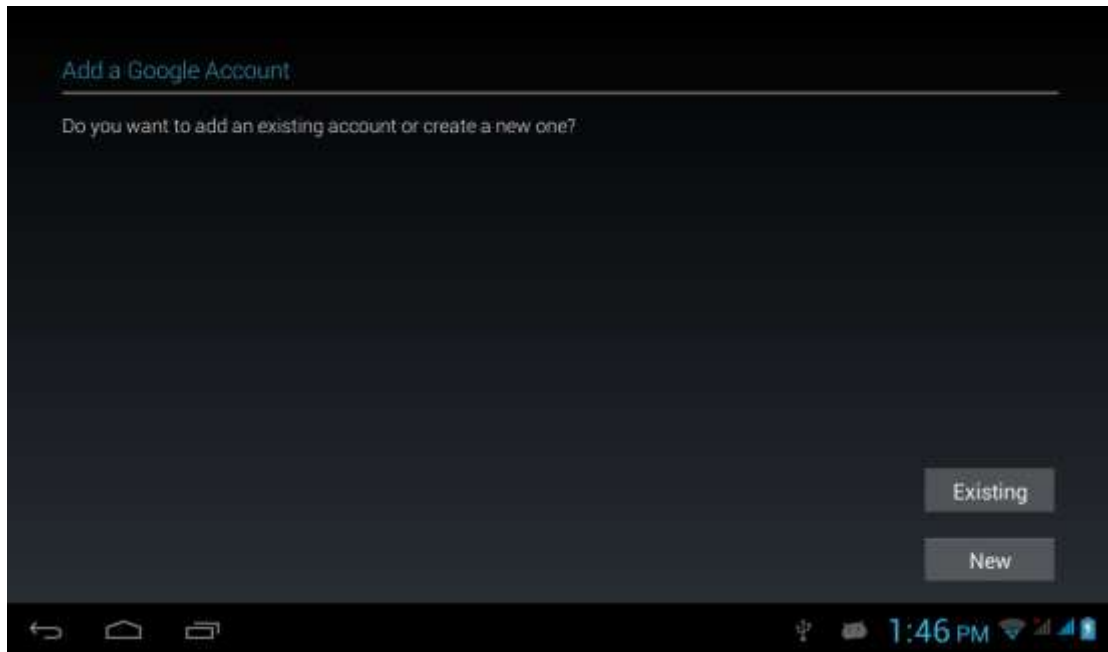

Pic 4.43

4. Once login successfully you can open synchronization function, see as picture 4.44;

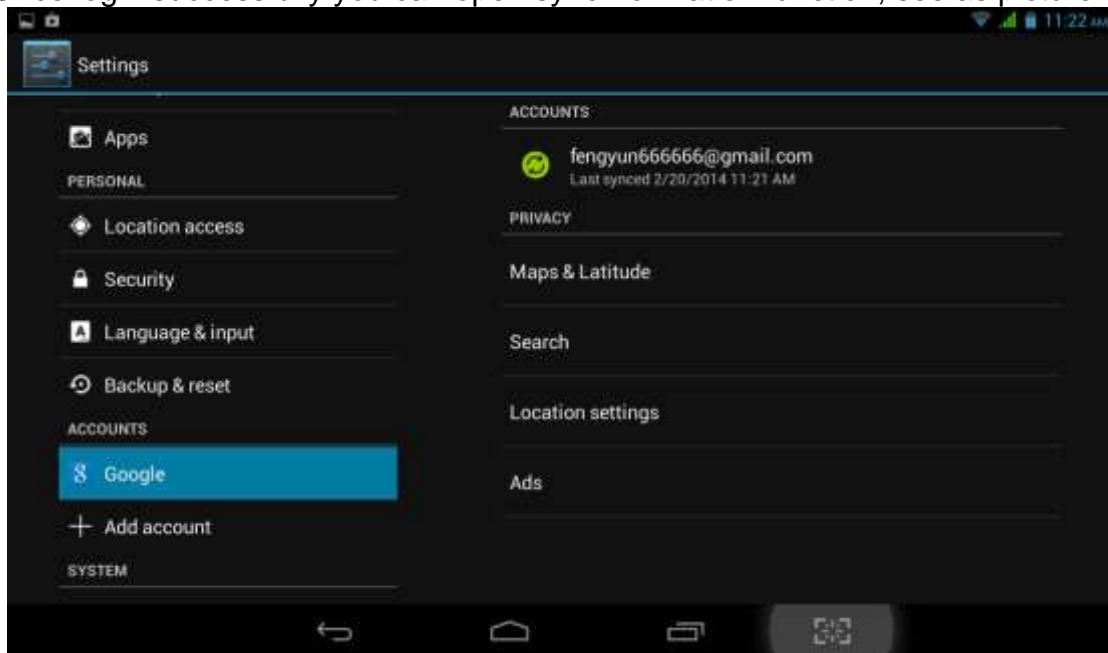

Pic 4.44

4.11 Location access

Click *setting* and choose *location access*, see as picture 4.45;

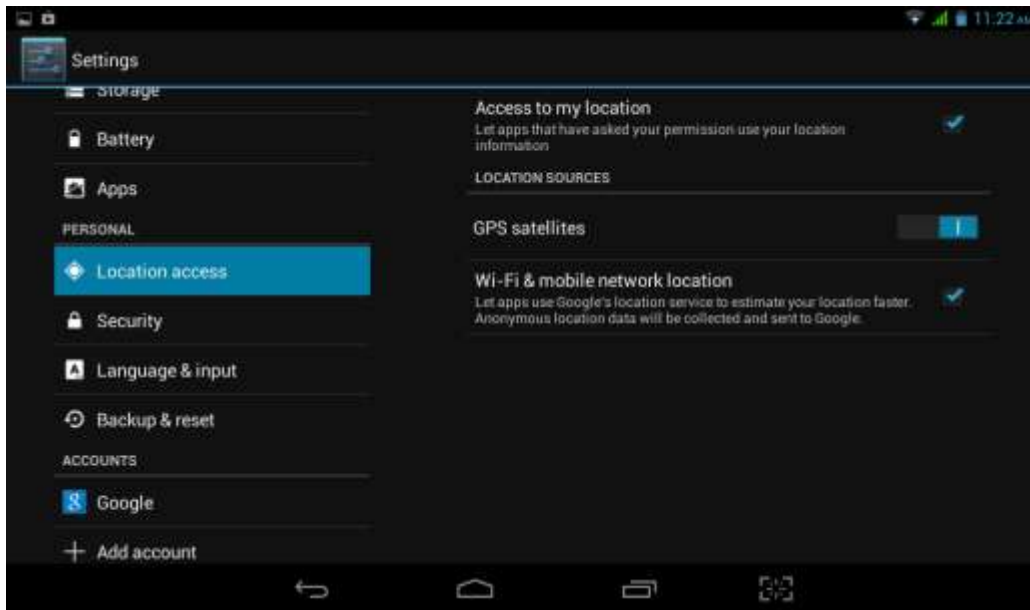

Pic 4.45

Google Location

When you open Google location, you can fix MID position via WIFI

GPS satellites

Use GPS on your MID which can pinpoint your location

GPS EPO assistance

Use GPS assistance data (EPO) to speed up GPS positioning, but it need insert SIM Card and generate lots of traffic.

EPO Setting

Tap EPO Setting to check EPO position date and whether it automatically downloads.

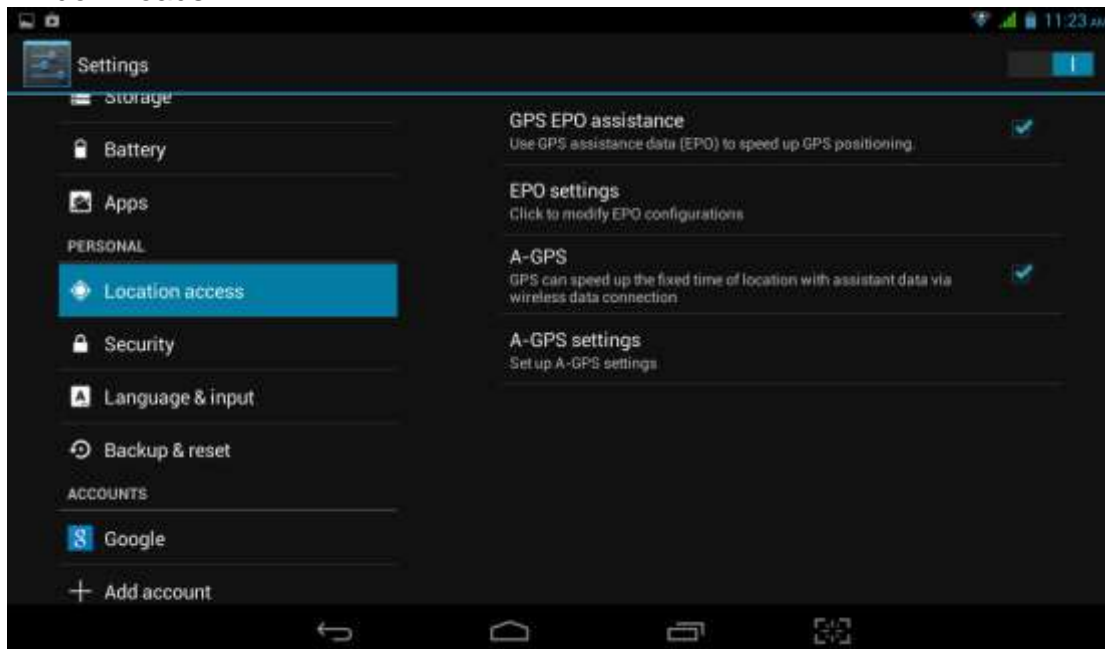

Pic 4.46

GPS

GPS can speed up the fixed time of location via internet when used

A GPS.

Tap A-GPS settings and you can see below picture 4.47;

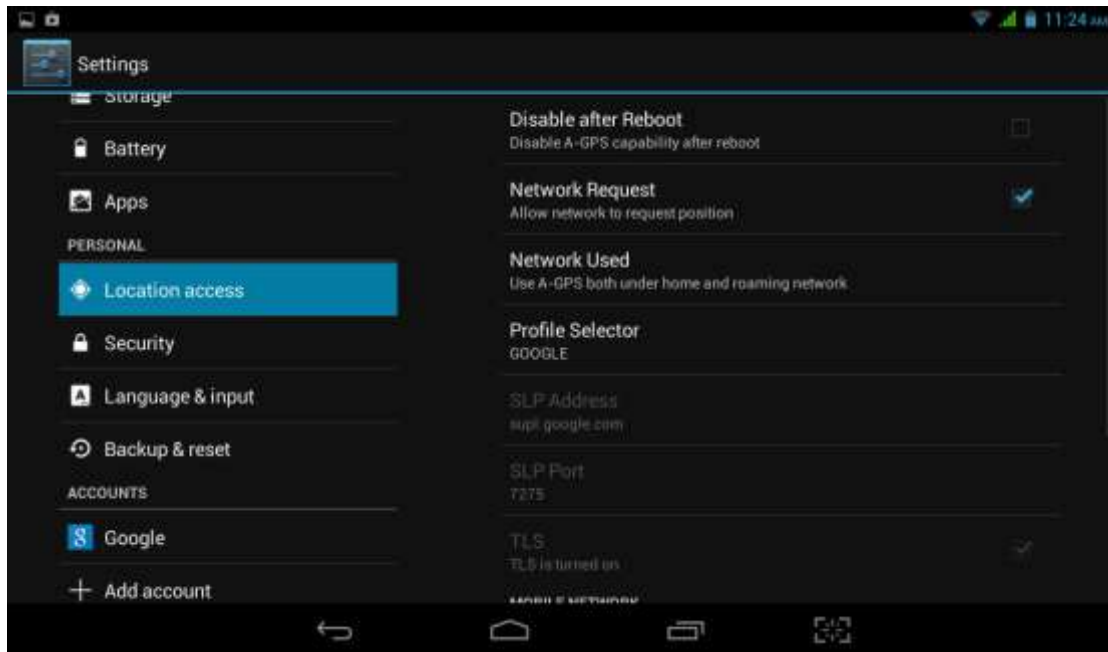

Pic 4.47

Disable after Reboot

Choose disable after reboot the A-GPS will automatically closed when you reboot MID.

Network Request

Use network request to get your location via internet

Network Used

Open network used you can choose the different mode of network, see as picture 4.48;

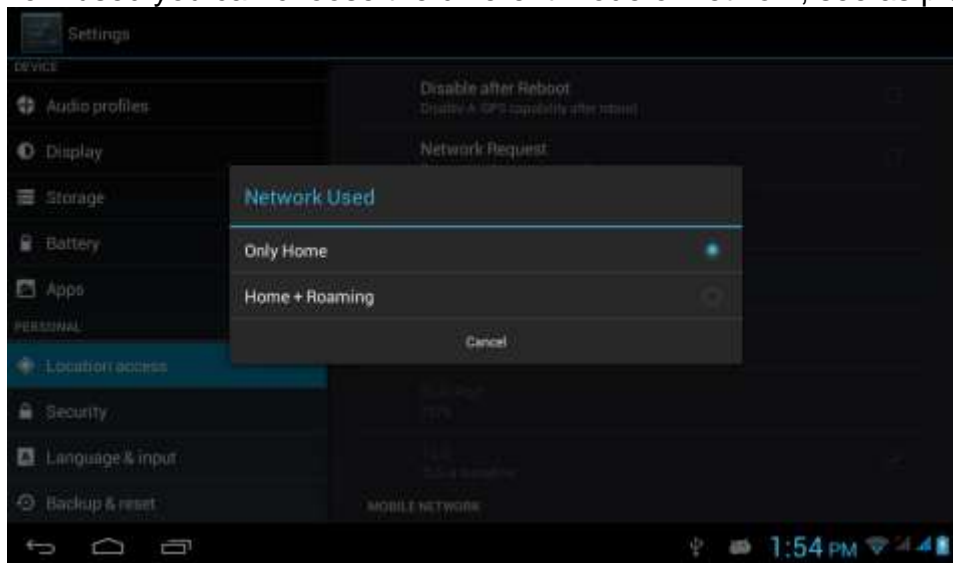

Pic 4.48

Profile selector

Choose profile selector you can shift them as you like, see as below picture 4.49;

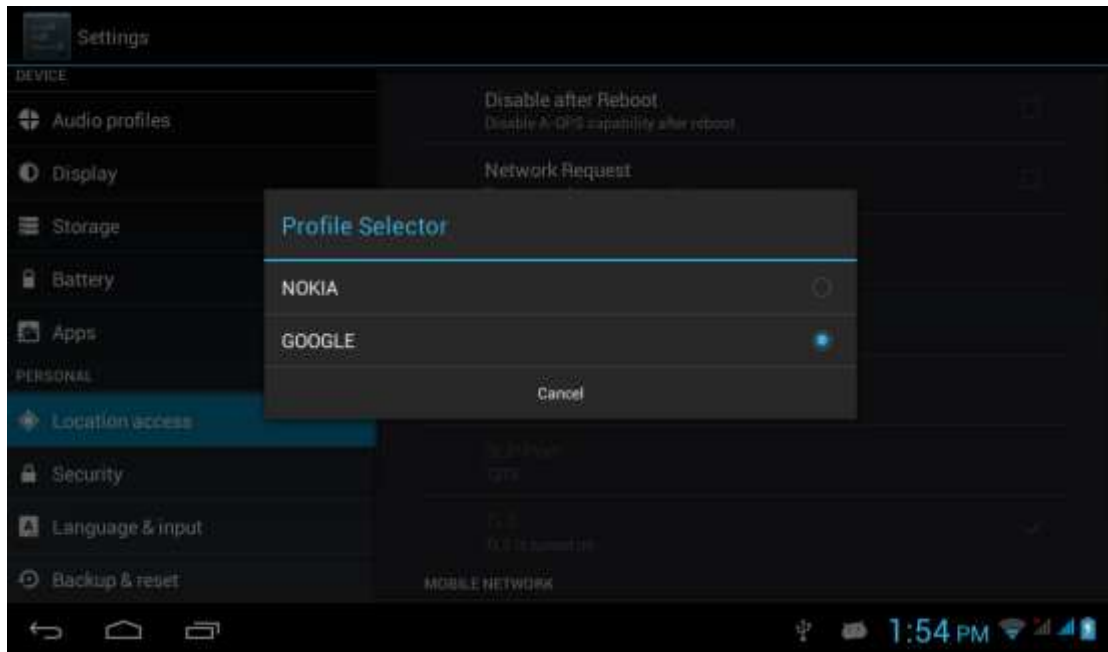

Pic 4.49

Location and Google search

Use Location access and Google search, you can use your location information to improve search result and other services.

4.12 Security

Set up screen lock

You can use password and unlock pattern to lock the touch panel and protect your MID.

Notes: Once you have set up the screen lock, every time when you reboot and unlock the touch screen will request to enter your password.

Set up unlock pattern

1. In the main menu page please click *setting* Application.
2. Click the *security*
3. Click the *Screen lock*
4. In the pop-up text setting area, choose *pattern*.
5. Click *Next step* as it mentioned.
6. It will pop up unlock pattern screen which has 9 dots. Slide your finger to connect the dots in any order on the next screen for creating a personal screen unlock pattern. You need to connect at least 4 dots. See as picture 4.50;
7. Click *Next*
8. When you see the notice and type again the *unlock pattern* and click OK.

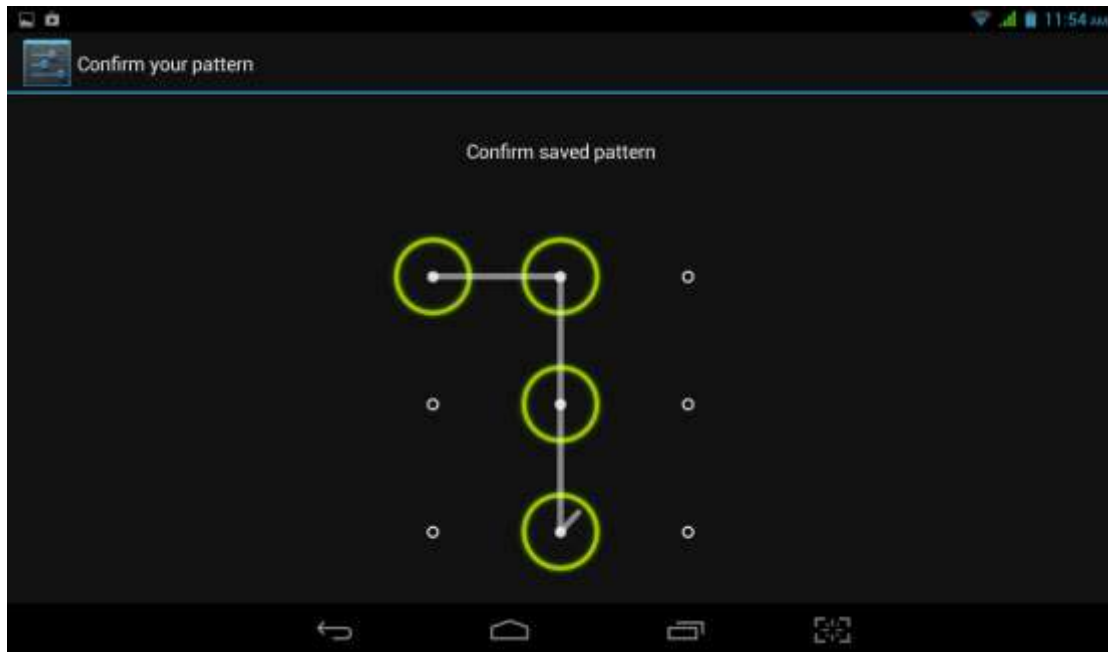

pic4.50

Set up unlock PIN password

In main menu please tap settings→Security→Lock screen→in the pop up text set area choose PIN→type new PIN password(finger) and tap Next→type again new PIN password and tap OK.

Set up password

In main menu please tap settings→Security→Lock screen→in the pop up text set area choose Password→type new Password(alphanumeric) and tap Next→type again new Password and tap OK.

Unknown sources

In main menu tap Settings→ Security→Unknown sources, see as shown picture 4.51;



Pic4.51

Notes: Click *unknown sources* and then you can install APK files by hand successfully.

4.13 Language & input

Tap setting→Language & input. You can choose the language as you need. See as below picture 4.52;



Pic 4.52

Tap *settings*→*Language & input*→*Android keyboard settings*→*input language*, see as below picture 5.34;



pic4.53

In the effective input method you can change the default language as you need. See as picture 4.54;

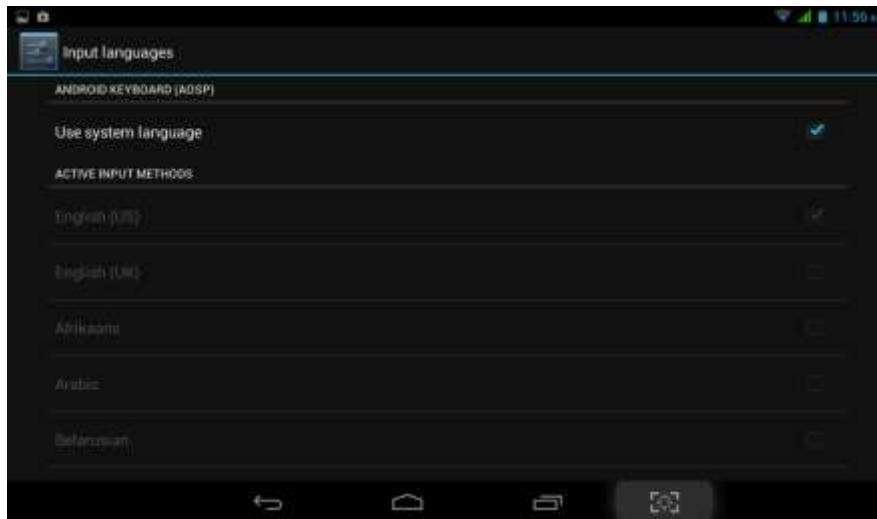

pic4.54

Return to *Language & input*, tap *default* to choose *input method* as you need. See shown picture 4.55;

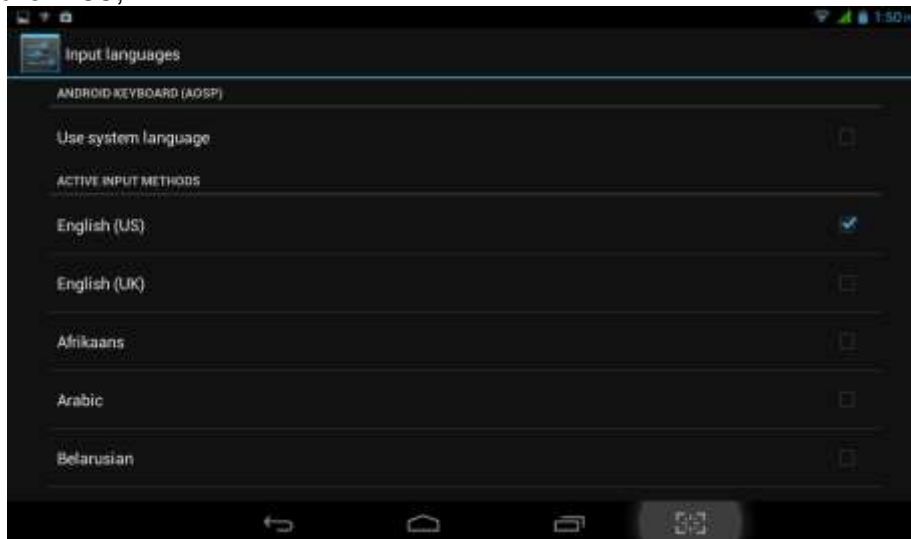

Pic 4.55

4.14 Backup and reset

Tap *Backup my data* after you have logged in Google account and connected Wifi the system will automatically backup your data to Google server.

For some reasons you have to restore the factory settings, please tap restore the factory settings.; If you want to format MID NAND, please click on Erase USB Storage and tap reset tablet is ok. See as picture 4.56;

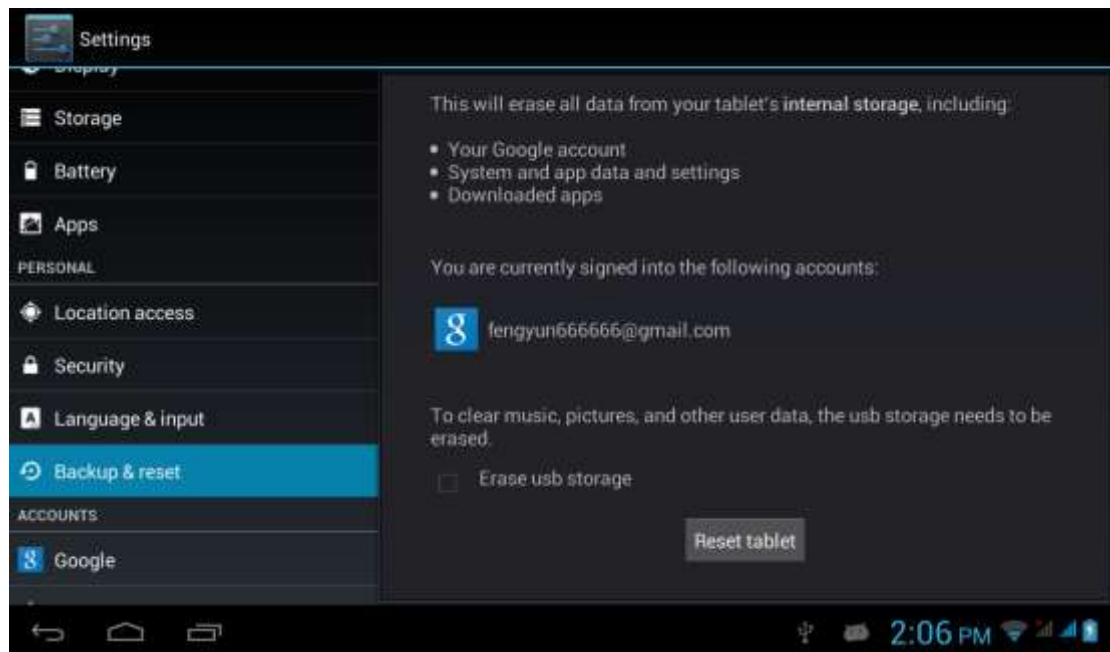

Pic 4.56

4.15 Date and Time

As default setting, system will set the date and time automatically by using network-provided values.

Set the date and time zone by hand

1. Click *settings*
2. scroll down the screen and click *date and time*.
3. Close *Automatic date & time*
4. Close *Automatic time zone*
5. Click *Select time zone*, and then choose *time zone* in the list. Scroll down the screen you can check more time zones.
6. Click *set date* and tap up and down button to select *Day, Month and Year*, thne tap “set” to finish the setting.
7. Tap *set time*, and tap up and down button to select hours , minutes, choose AM and PM to set morning or afternoon(it will not support 24-hour format), and then tap “set” to finish the setting.
8. Click *Use 24-hour format*, you can shift between 12-hour and 24-hour format. And the time format will applied in the alarm clock.
9. Click *choose date format* and choose the date format which will show in your MID.



Pic 4.57

Notes: If you use the time which network provided automatically, you are unable to set the date and time zone.

4.16 Scheduled power on off

Tap settings → Scheduled power on off

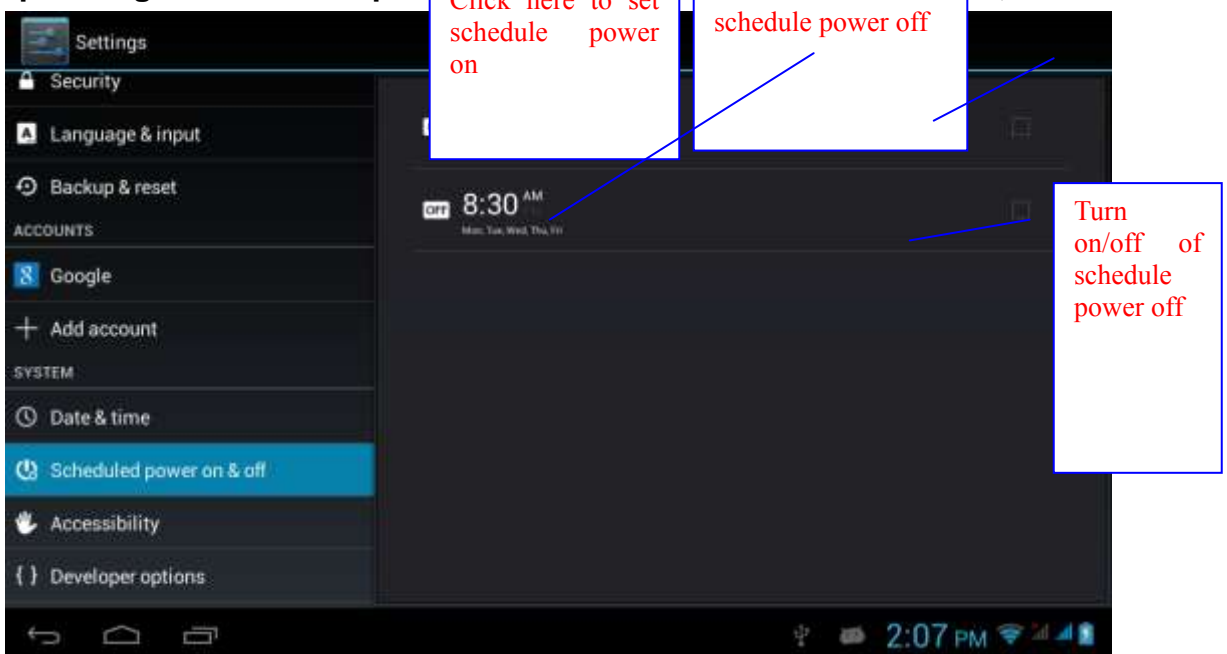

Pic 4.58

4.17 Accessibility

4.17-1. large text

Click **Large text** can make the system font become larger

4.17-2. Press **Power button to end call**

With this function, when you make a call and press “power” button, you phone call

will automatically hang up but will not turn to sleep

4.17-3. Touch & hold delay

Click *Touch & hold* delay can adjust the delay time, see as shown picture 4.59;

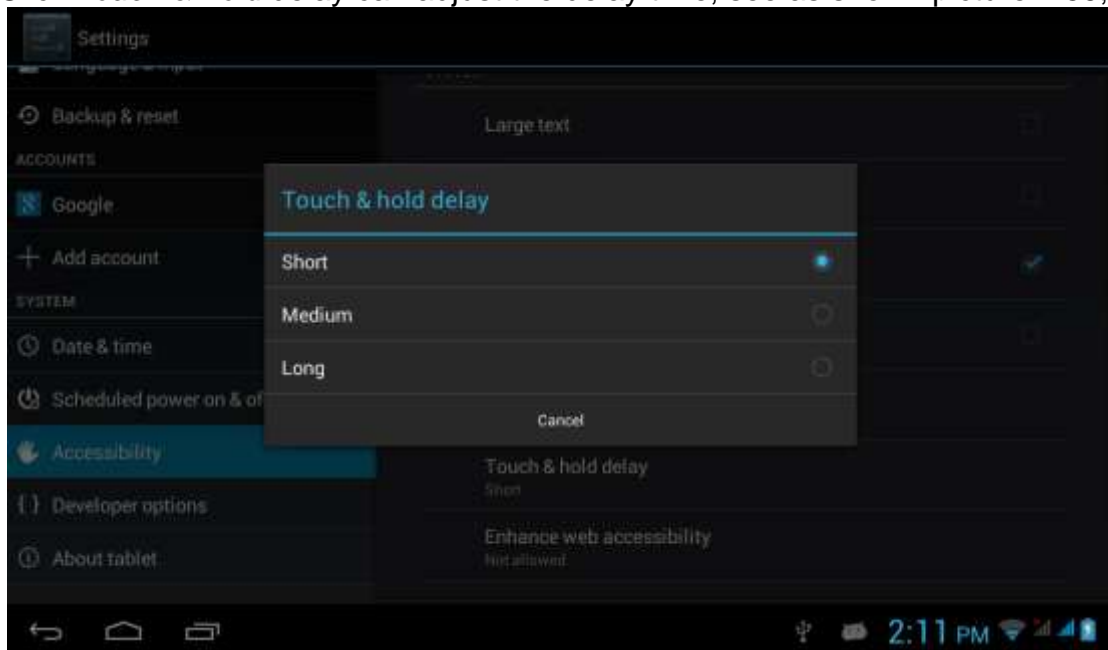

Pic 4.59

4.17-4. Install web scripts

When you open it system will allow you install web scripts, but it will increase the security risk when you browser website.

4.18 Developer options

4.18-1 USB Debugging

Once you open USB debugging, it can read the MID with some software. But when it opened the USB storage need to manually bring up before us.

4.18-2 stays awake

When you open stay awake, MID screen will never sleep while charging.

4.18-3 Cursor position

When you open Cursor position, you can read the touching point operation's transverse and longitudinal axis coordinates of your MID

4.18-4 Display touching operation

When you open display touching operation, it will display your touching area of MID. And it will more accurate and clear when used with cursor position

4.18-5 Display update

When display updates, it will flash in the corresponding place.

4.18-6 Display CPU usage

After opening display CPU usage, upper right corner of MID will display the CPU usage, pic 4.60



Pic 4.6

4.19 About MID

MID status

- 1 Enter the settings application
- 2 Click *About MID*. Can view the status information, model No., Android version, version no. and other information.
- 3 Click “status information”, Can view the battery status, battery, SIM status, IMEI No., IP address, etc.

5. Multimedia

5.1 Music Player

In the application menu or on the desktop, click the icon  to enter into the Music Player interface, as pic 5.1, select a different way to find songs

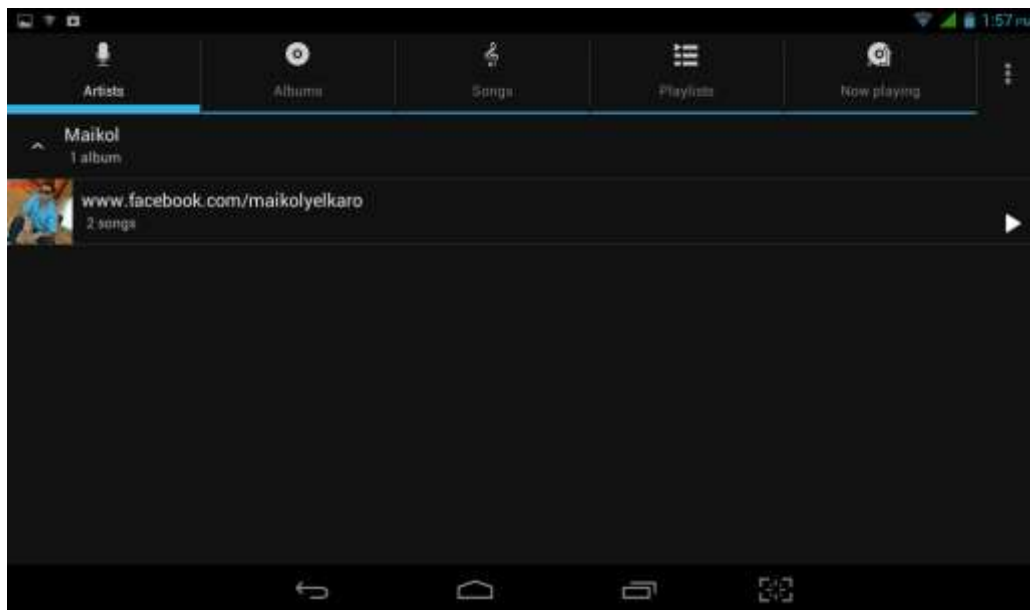

Pic 5.1

Shuffle



Pic 5.2

Artists

Album Cover

Song Name

Loop Playback

Stop /Play

Last song

Next song

Drag the playback progress bar  to adjust audio playback progress
 Music player button operation is shown in pic 5.2

5.2 Video

In the application menu or on the desktop, tap the icon  to enter into the video player interface.

Video player buttons described in pic 5.3



Pic 5.3

5.3 Gallery

Gallery application can automatically search for photos from the Micro SD card and video files, And Gallery folder will classify these pictures and video files, You can use the Gallery application to check and edit photos, check the photos and set it as a desktop picture

Check Photos

- 1 In the application menu or on the desktop, tap the Gallery application
- 2 Enter the gallery, tap the folder to check the included pictures
- 3 Tap the picture you want to view, the system will automatically view in full screen mode.
- 4 Photos can zoom in or zoom out by separate or fold two fingers. Double clicks can make it too.

Tips: When browse pictures, you can swipe left or right picture to switch picture
Browse

Edit and set picture

View images in full screen mode, press the Menu button to display the menu options, you can select the options you want to edit and set the picture.

slideshow

- 1 Open a picture, click the menu button using the virtual keys to display the menu options
- 2 Tap the slideshow, it will automatically loop (or tap the icon  in image folder)

Crop

- 1 Click on the menu button to display the menu options
- 2 Then tap Crop, drag the relevant regional election to adjust the cutter
- 3 Tap cutter, drag from center to outside to adjust the crop size.

4 Adjust the size you want, tap Crop

5 As abandon cropping, click Cancel to return to picture overview

Edit

1 Click on the menu button to display the menu options

2 Tap Edit

3 In the pop-up options can be brightness, style, color, effect settings

4 Click Save

5 As abandon editing, click the Back key, in the pop-up dialog box, click NO back to picture browsing

5.4 Camera

In the application menu or on the desktop, tap the icon  to enter into the Camera interface

Camera operation button and Switching camera as shown in pic 5.4 and pic 5.5

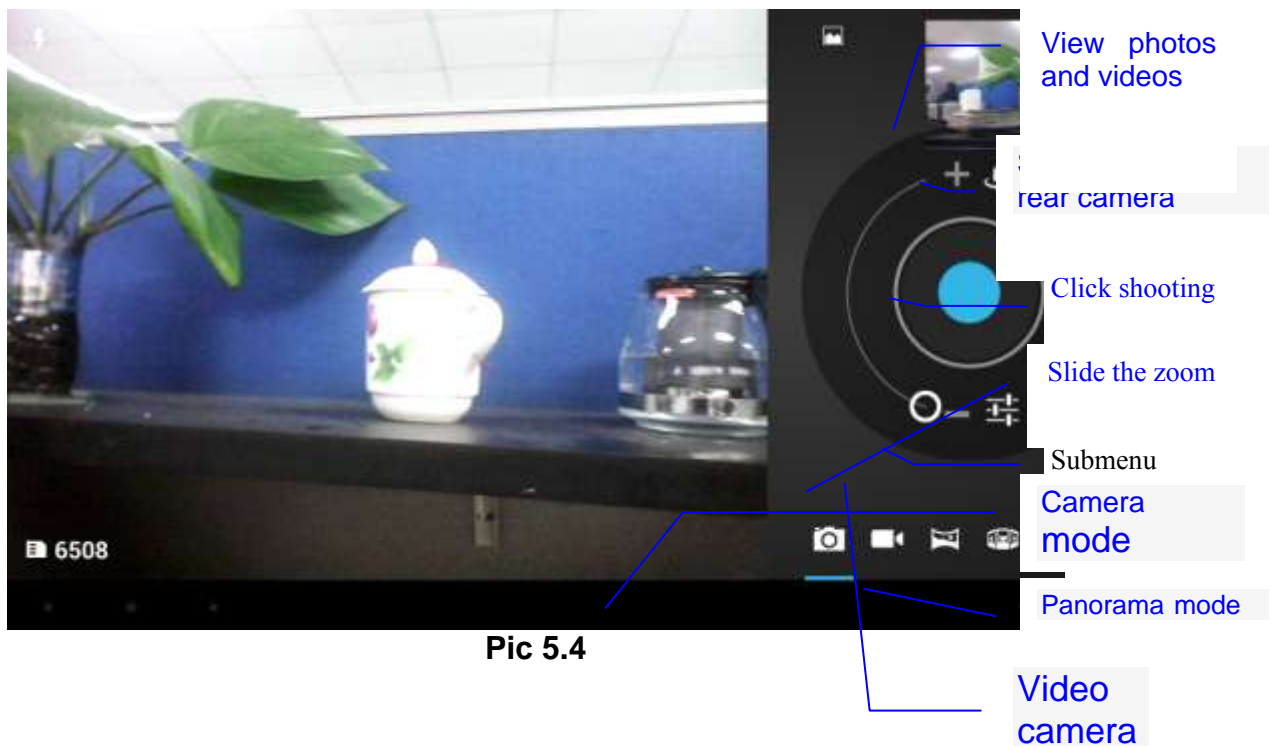

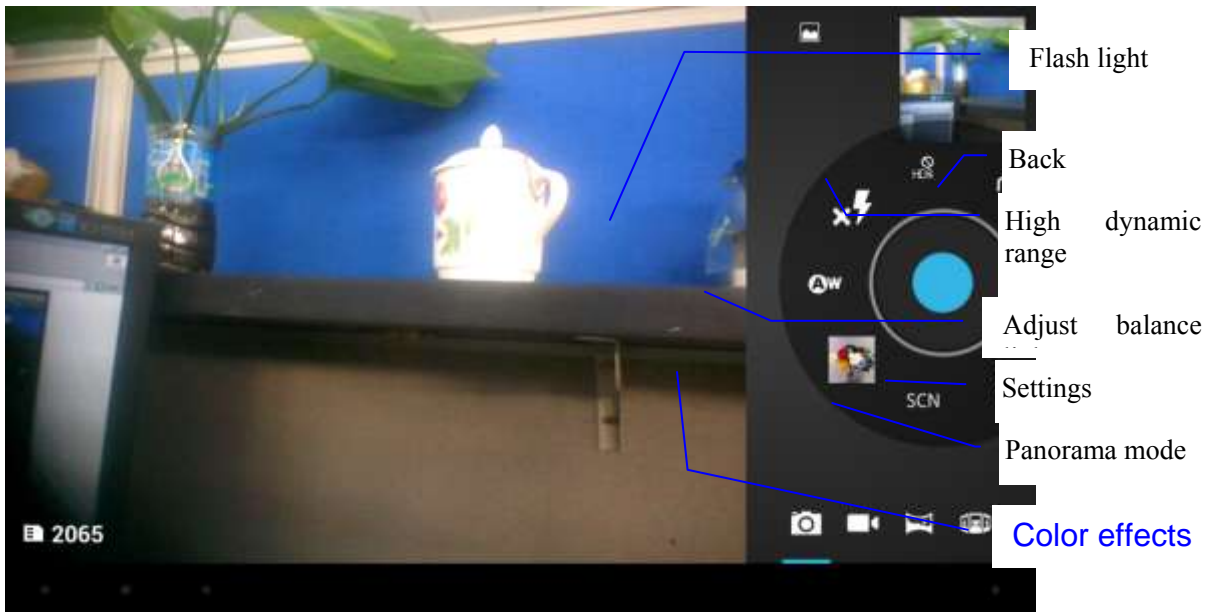

Pic 5.5

5.5 FM Radio (Optional functions)

In the application menu or on the desktop, tap the icon  to enter into the FM Radio interface

Connect Headphones

Select the top right corner button  pic 5.6

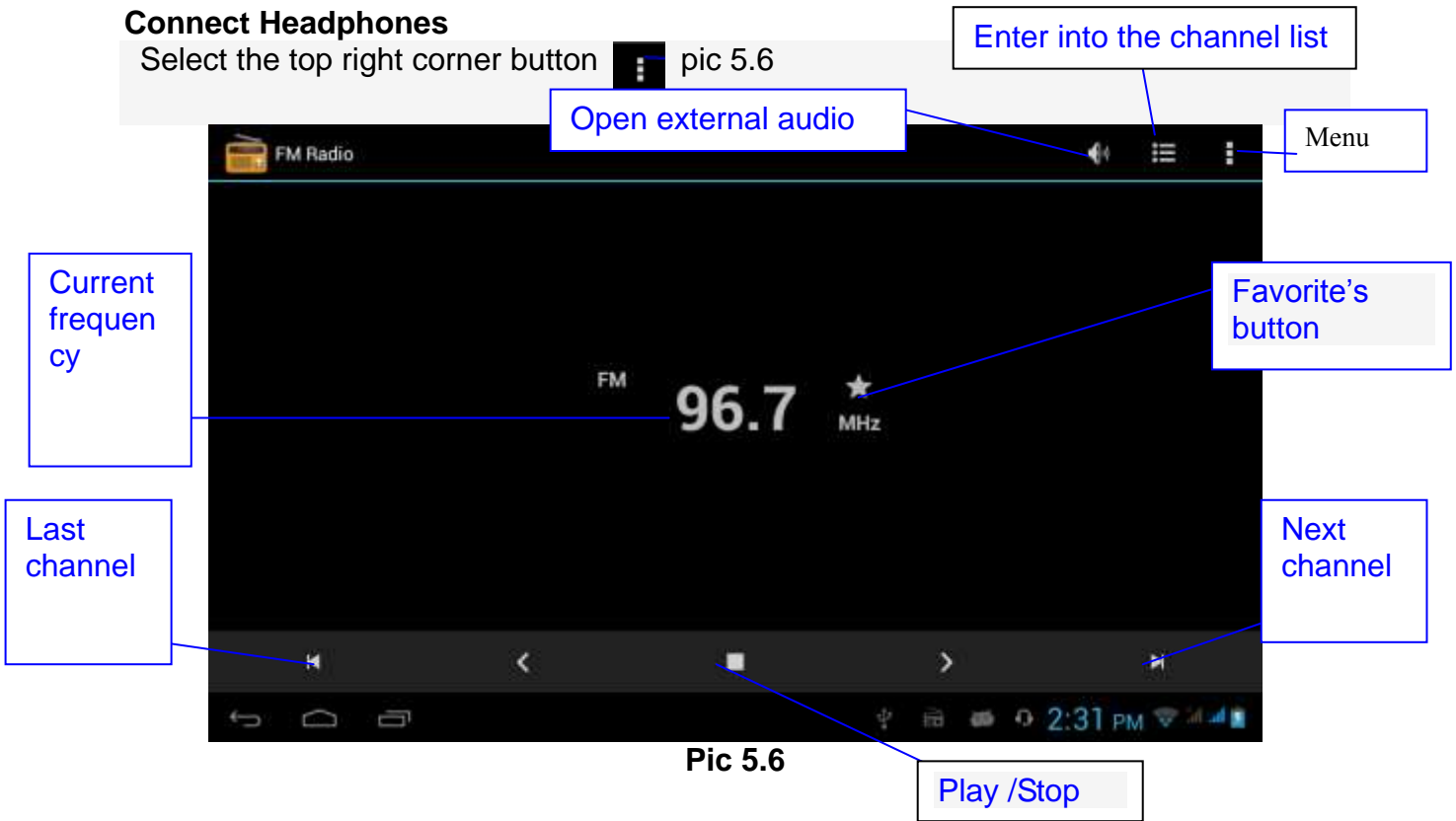

Pic 5.6

Select the search, Then FM band can be found in, as 5.7



Pic 5.7

Favorites: Click the button  on the main interface to add to Favorites
 Note: Using FM Radio plug in your headphones as an antenna
 If no antenna, you will not be able to search the MID band radio

6 Communication function

6.1 Phone

- 6 Select the dialing application
- 7 Operate according to Figure 6.1

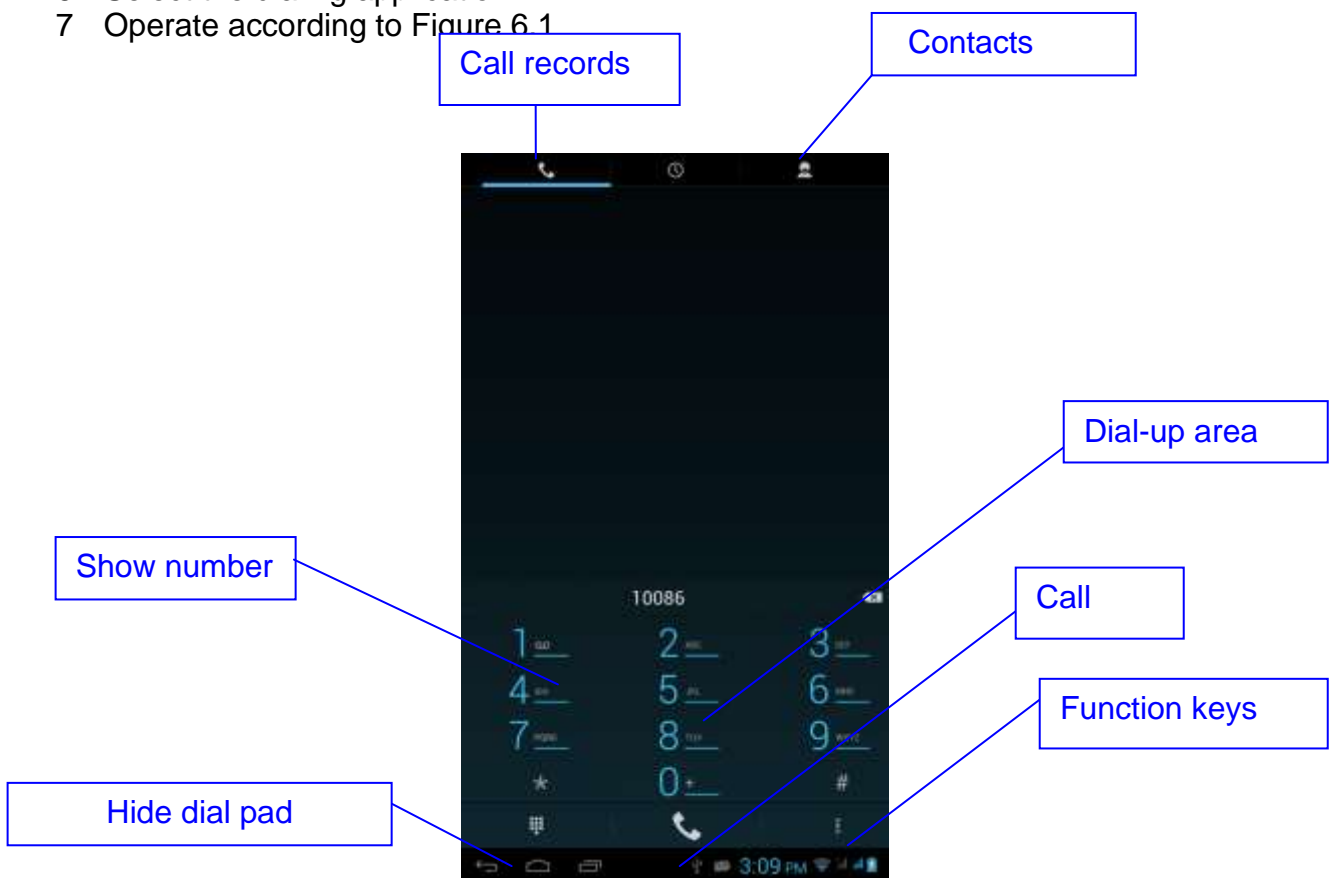

Pic 6.1

6.2 SMS

6.2.1 In the application menu or on the desktop, tap the icon  to enter into the SMS interface

6.2.2 Select edit new message

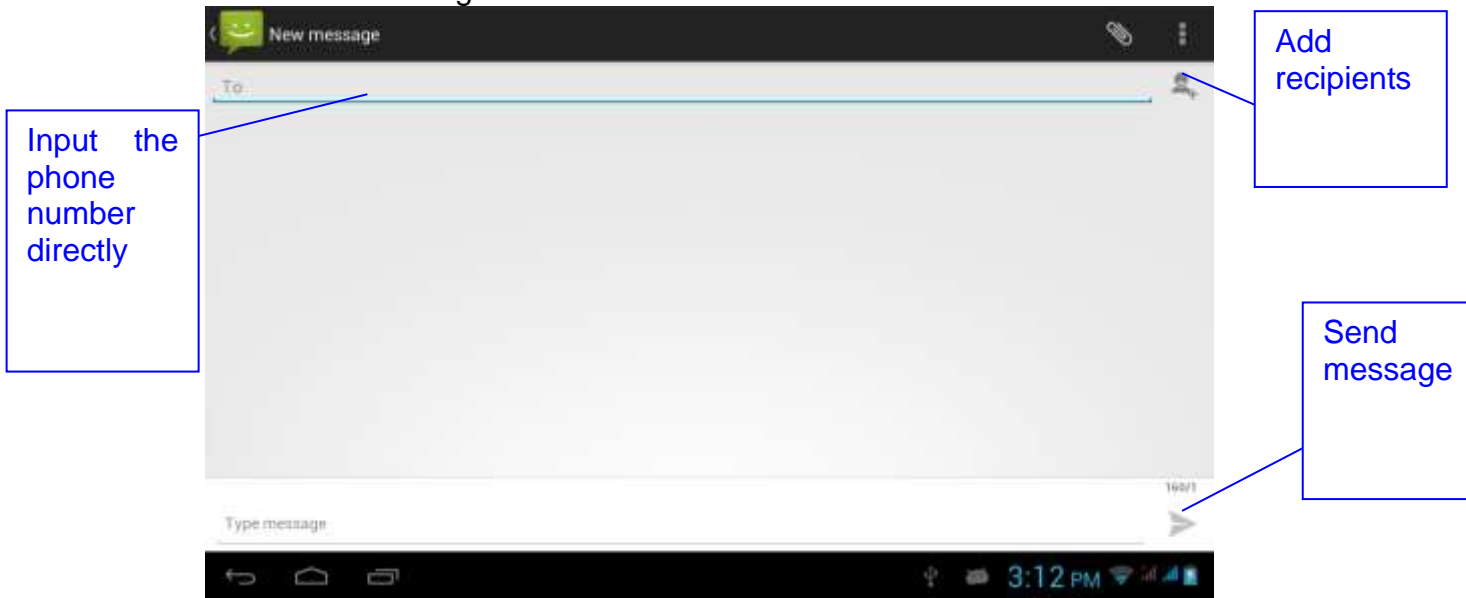

Pic 6.2

6.3 Contacts

In the application menu or on the desktop, tap the icon  to enter into the Contacts interface

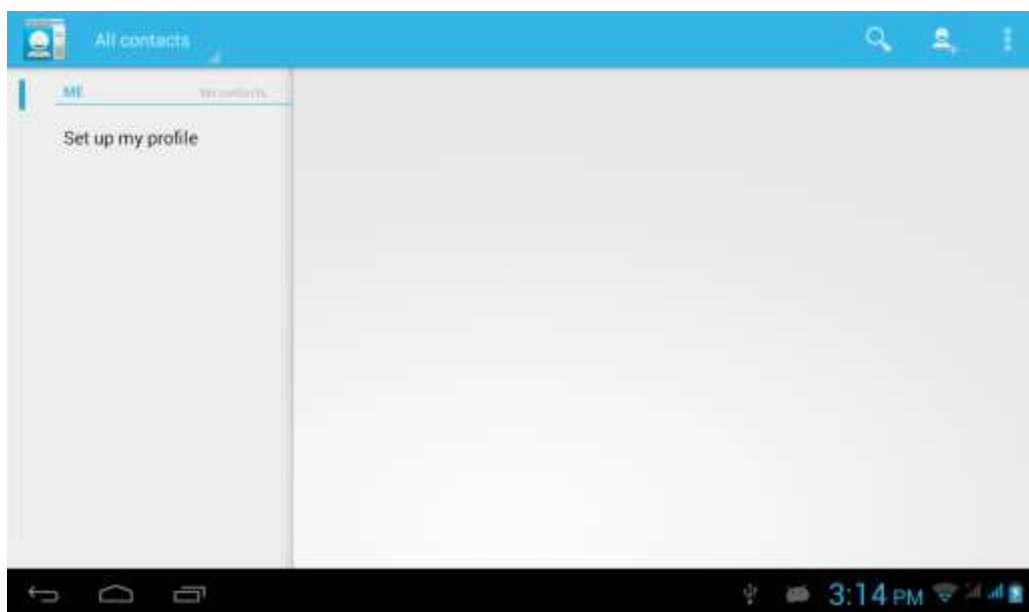

Pic 6.3

Search for contacts: Click the button  to enter into the search function

Add contacts: Click the button  to enter into the Add contact interface

7. Movil Teacher (Optional)

7.1 Device setting

Click the "Setting" icon  to enter in the setting panel.



Pic 7.1

Locate and choose "Language and keyboard" and select "Voice Search"



Pic 7.2

Select "Language"



Pic 7.3

Select “English”

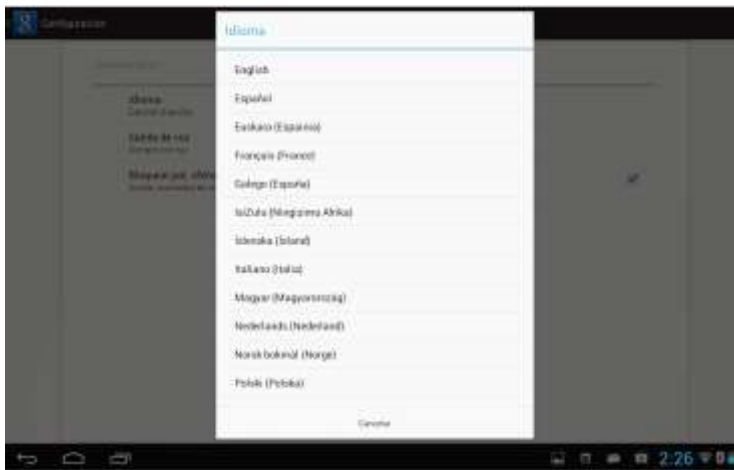

pic 7.4

Under "Dialect" choose, select English(US)

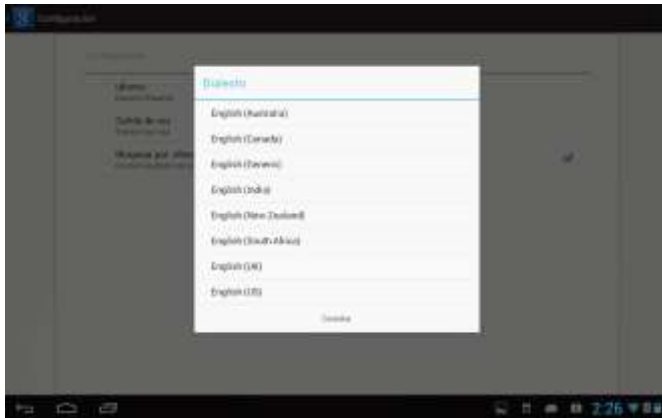

Pic 7.5

Select "Keyboard and Language", and select "Output of Voice Text" on the right



Pic 7.6

Select "Language"



Pic 7.7

Select in the menu that appears "English (United States)"

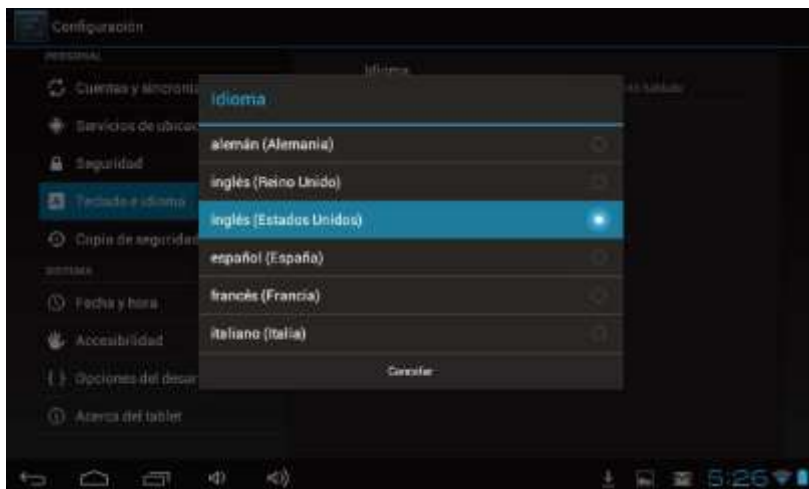

Pic 7.8

7.2 USER'S INTERFACE



Pic 7.9

7.3 NAVEGACION

The main screen contains the Main Menu of each chapter. From here you can enter all of the chapters of course.

There are two methods of navigation between chapters. You can move forwards and back from one chapter to another as shown in the following image.



Pic 7.10

Drag the tabs to navigate between chapters.



Pic 7.11

Drag lessons' panels for details of that lesson



Pic 7.12

In compounds chapters touch tabs to access that section



Pic 7.13

Once you enter a letter or a word in the "search query" in the dictionary, you can scroll through all the words in the dictionary, or choose the word that interests you to access more options



Pic 7.14

Once you choose a word from the list, you will see the dictionary. From here you can:

- See the translation of the word.
- See the definition of the word.
- Practice writing.
- Listen to the pronunciation.
- Practice your pronunciation of the word.



Pic 7.15

Touch the panels to access the main menu of the lessons in this chapter



Pic 7.16

The main menu of the lessons allows access to each individual lesson and also displays information about your score and progress in each lesson.



Pic 7.17

To unlock the padlock and enter the next lesson, you should get 50% or more in the previous lesson

Once the lock is opened, you will see the blue button 'play' to begin the next lesson

As you progress through the chapter, you will have access to more lessons. You can always go back and review the finished lesson to review topics or improve your score.



Pic 7.18

The lessons have several different types of activities, all complete with instructions and guidance. In all the lessons you can find the same functionality and continuity of concepts of user's interface.



Pic 7.19

8 Internet

8.1 Browser

When wifi or net work is well connected, click  to input IP address and can surf internet. As pic 7.1



Pic8.1

8.2 E-mail

Email application with e-mail setup wizard, can add common Web e-mail service provider (Such as Yahoo, Gmail and 163 other provider) external POP3 or IMAP e-mail account. Figure 7.2

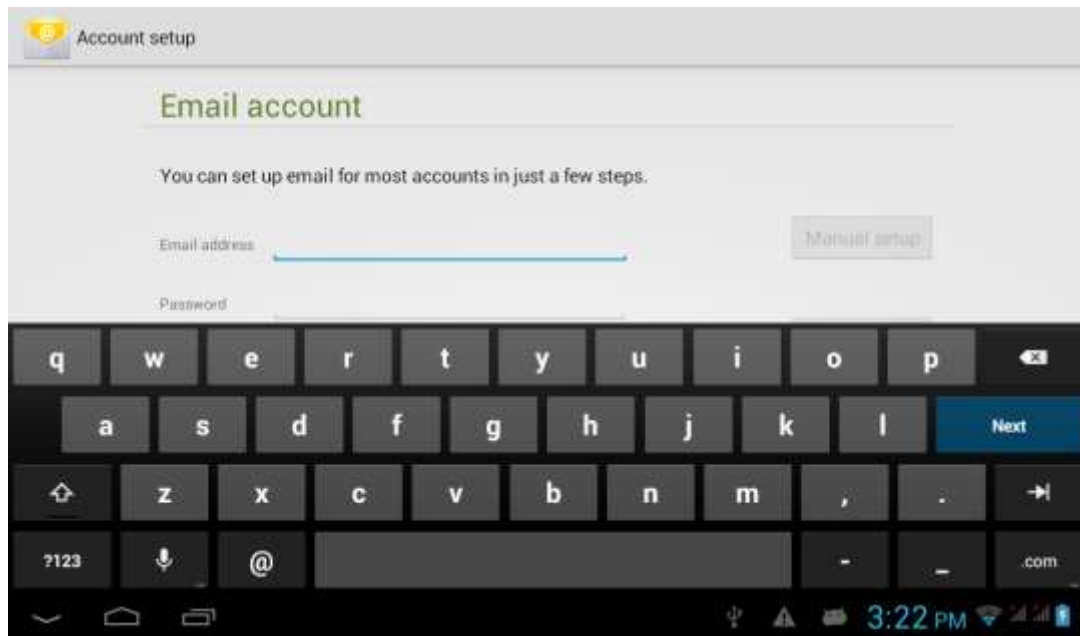

Pic 8.2

A E-mail settings

1 After clicking the icon , E-mail setup wizard will appear to help you set up



- 2 Input your email address and password for the email account
- 3 Click the *Next Step* button to check the mail server is available transceivers
- 4 Input the account name and email name, then tap *Done*
- 5 If the mailbox is available, will automatically enter your inbox

B Delete mail account

You can delete the set up POP3 or IMAP email account from your MID

- 1 taps the icon 
- 2 Enter into your inbox
- 3 Click the Menu key
- 4 Tap the Settings
- 5 Right down select Delete Account
- 6 Click *OK* to remove

C Send E-mail message

- 1 Tap  to display your inbox
- 2 Click the e-mail inbox will automatically refresh, click to read
- 3 Click the Menu key to pop up the menu
- 4 Tap the top right corner ; enter into edit new mail interface
- 5 input the recipient's e-mail address
- 6 Input a subject and message content
- 7 Click Add Attachment
- 8 Select the attachment you want to send (such as pictures, video, etc.)
- 9 Click the Sending key to send an e-mail

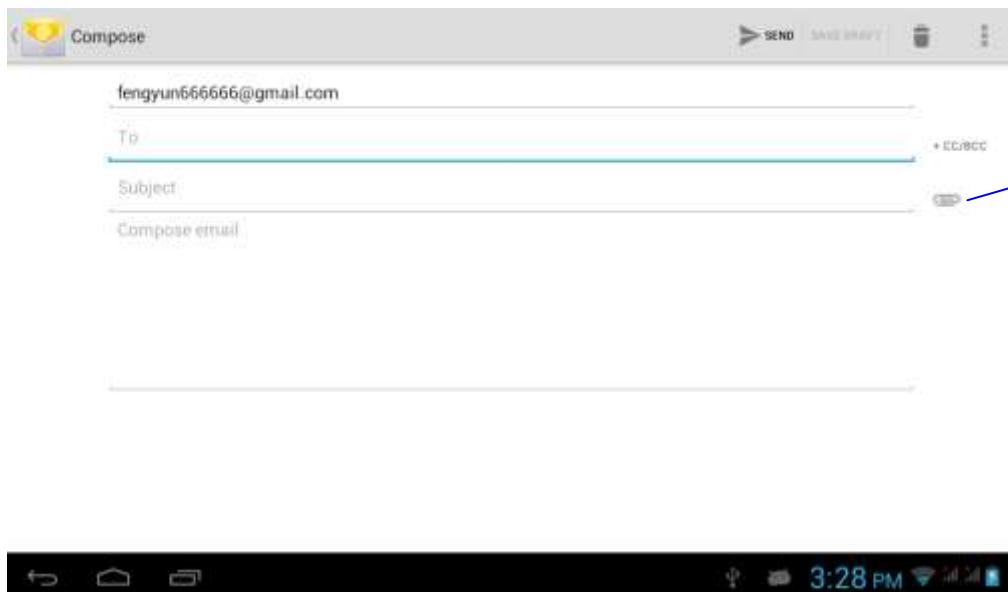

Pic 8.3

9 GPS function (optional feature)

9.1 GPS positioning

1 MID built-in GPS precise positioning satellite signal receiver. But available map is provided by third party.

2 Enter into the setting interface, click on the icon , enter in pic 9.1

[Return](#)

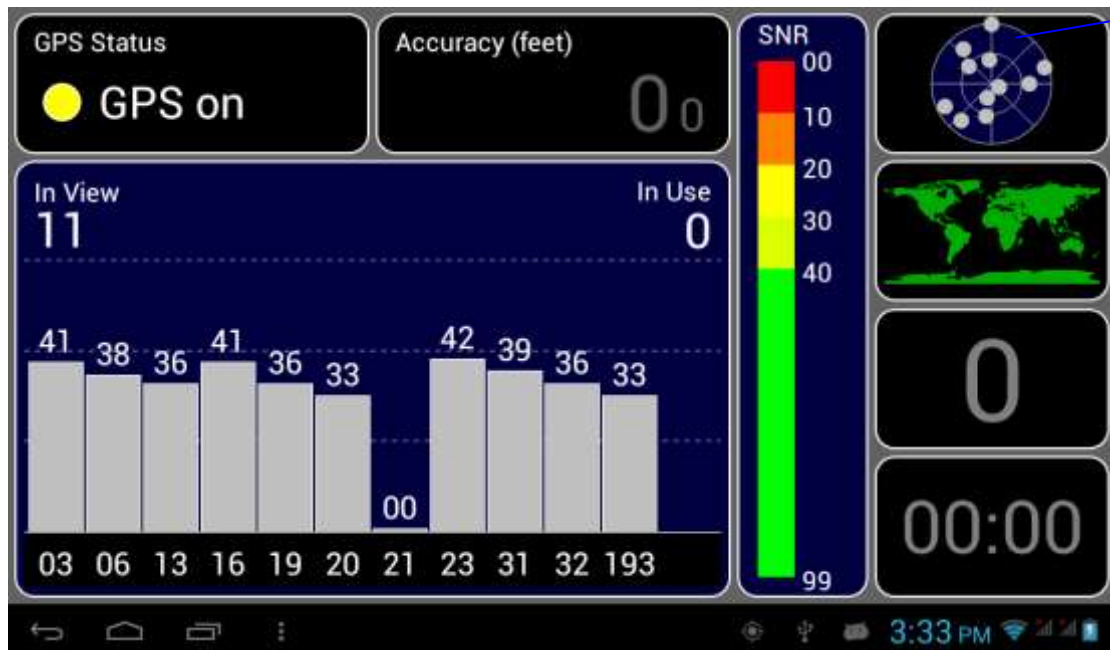

Pic 9.1

After successfully positioned, blue part will be transformed into green. And display the latitude, longitude and altitude, speed, position location time. pic

9.2. Satellite value represent positioning signal of the intensity,

Positioning time associated with the choice of setting time zone range. If time does not match with positioning location time, please check your time zone selection is correct

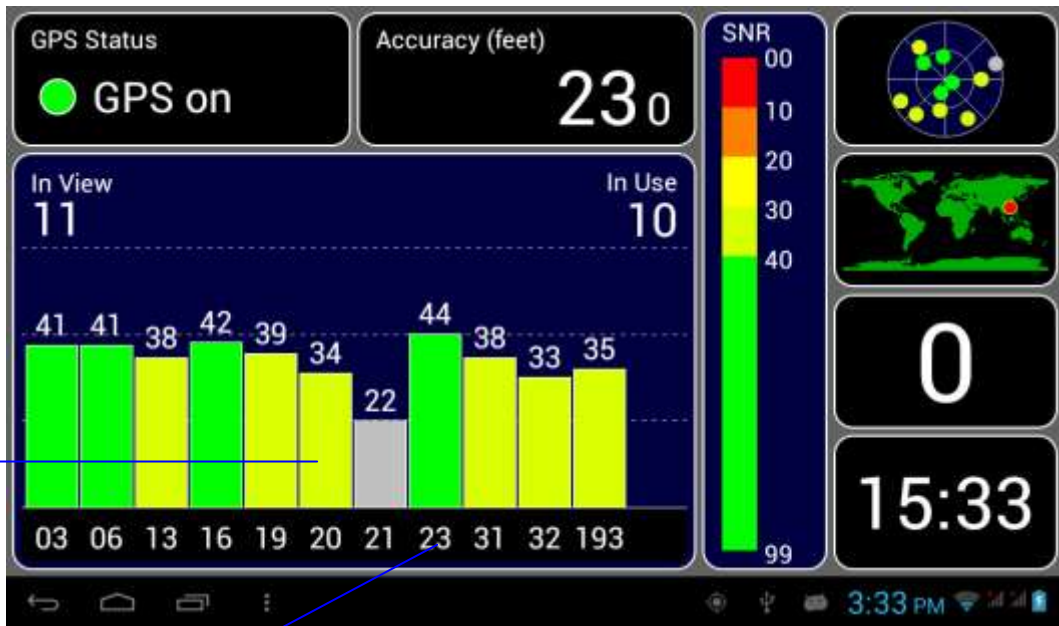

Satellite value

Satellite No.

Pic9.2

10 Other Applications

10.1 Clock

In the application menu or on the desktop, tap the icon *Clock* to enter into the Clock interface, Figure 9.1

Click the *alarm settings*, alarm clock can be set

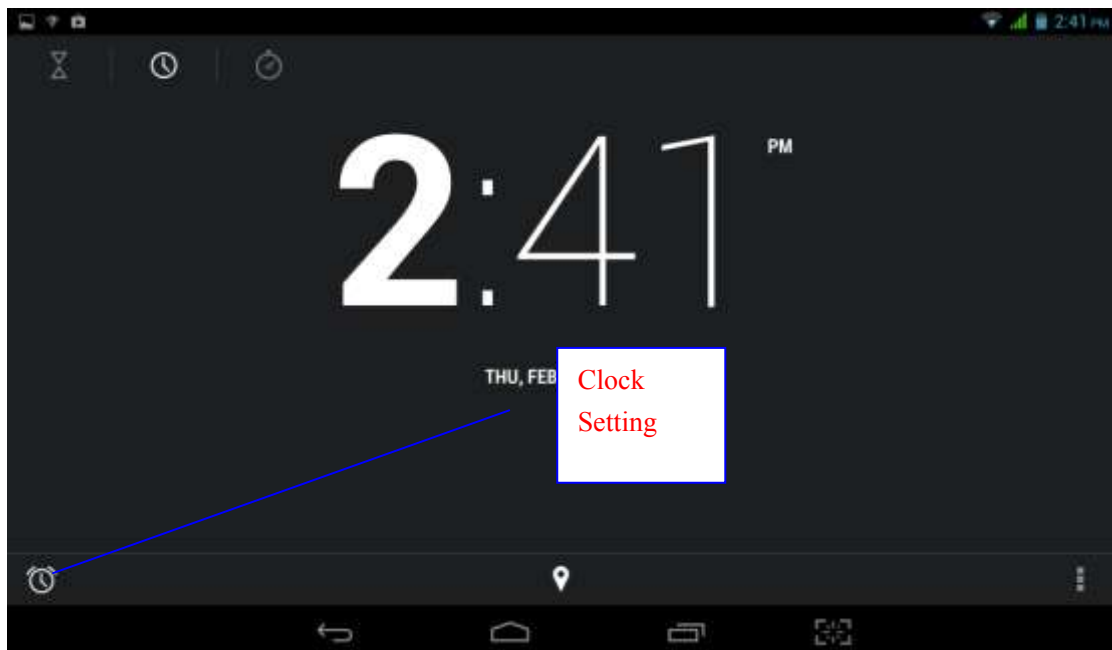

pic 10.1

10.2 Calculator

- 1 Tap on the icon 
- 2 Enter The calculator basic panel
- 3 Touch counter number on the panel or operator to calculate

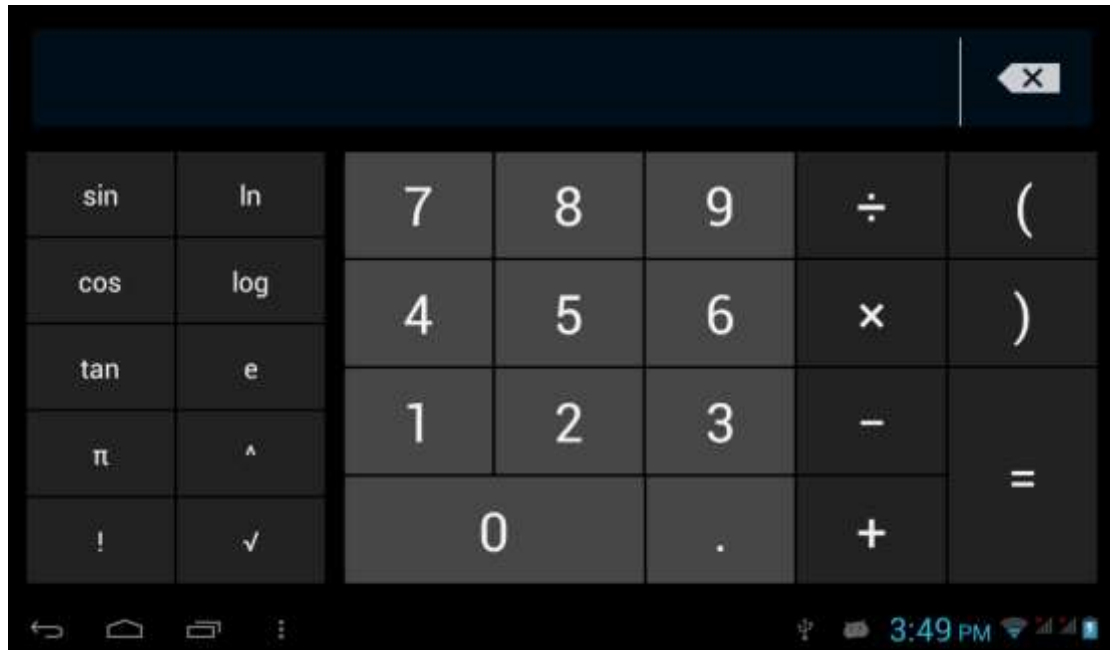

pic 10.2

10.3 Explorer

Explorer with the TF card files or folders to copy, cut, delete, rename and other operations

can also share the file, install apk and other functions

In the application menu or on the desktop, tap the icon  to enter into the Explorer interface, Figure 9.3

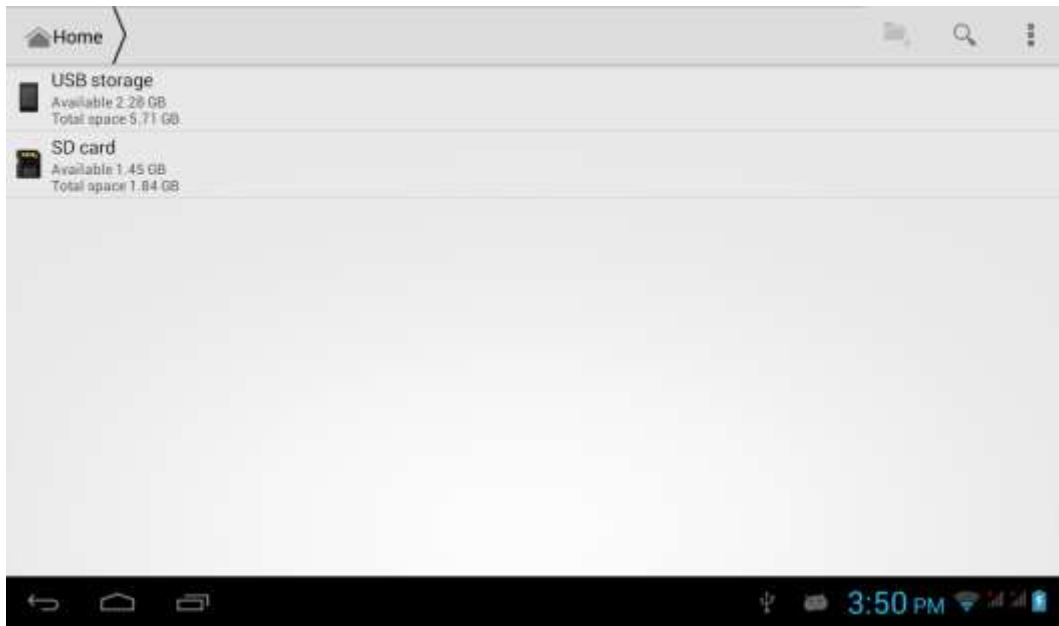

Pic10.3

A. Some operations, such as copy, cut, delete, rename, etc. Select a folder or file, long press a folder or file to enter into Figure 9.4 Interface.

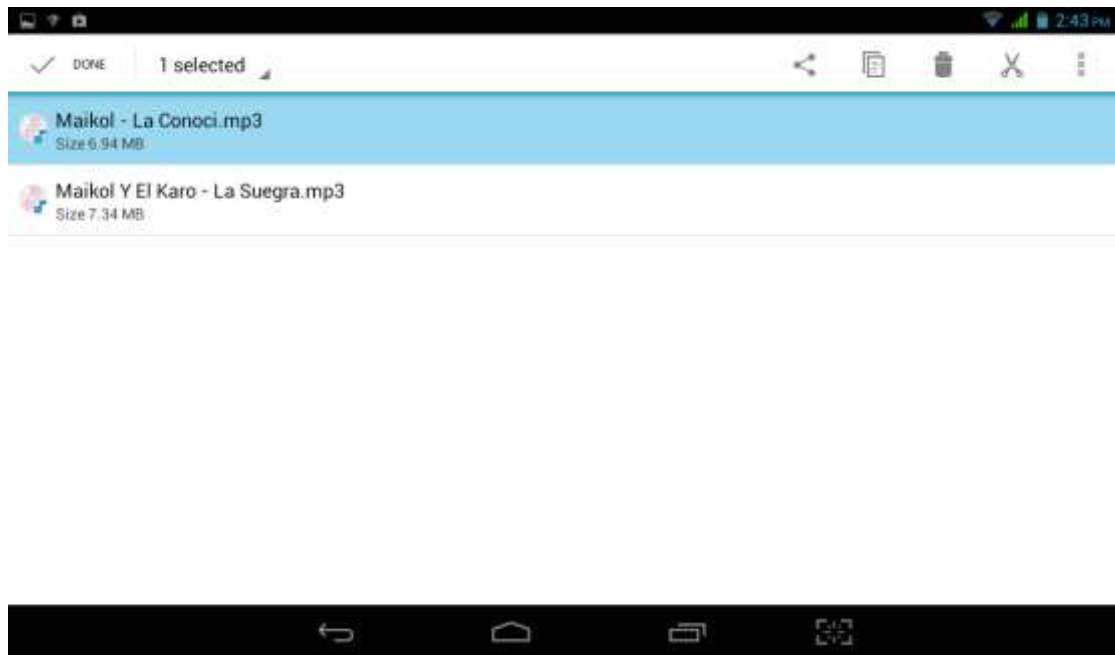

pic 10.4

B. Paste the copied or cut file or folder: on the directory you want to paste, you can select the icon  in the upper right corner to paste



Pic10.5

C .Share the file: Select a file and long press this file, In the top click on "☰" In the pop-up list, select "Share" item. According to the pop-up list to select the way you want to share

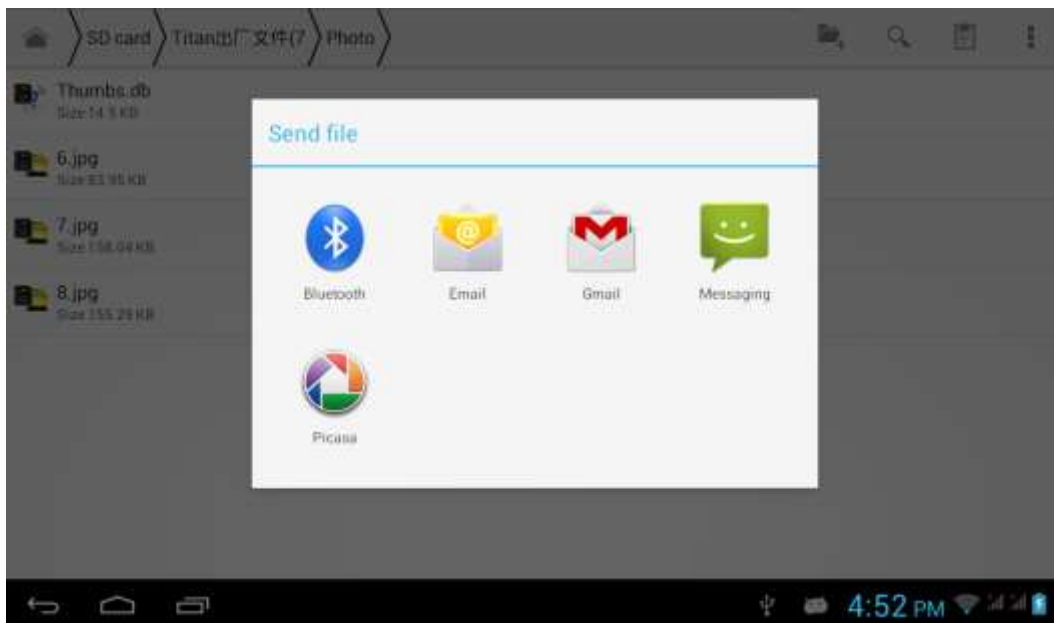





Pic 10.6

D. Install apk file: select the suffix. Apk file on the Explorer, pop up the installation program, follow the prompts to install third-party software

E. Create new folder: Select the folder you want to create the directory, Click the right button , select the Creat New Folder, Follow the prompts to

complete the Creat New Folder

10.4 Recorder

In the application menu or on the desktop, tap the icon  to enter into the Recorder interface, Click the Record button  to start recording, click the Stop button  to stop recording. Just click the play button  to play the recording, the system automatically prompts to use this recording or to give up, please manually select.

Play recordings: Select to use audio player audio, in accordance with the Explorer select the audio files, and click to play

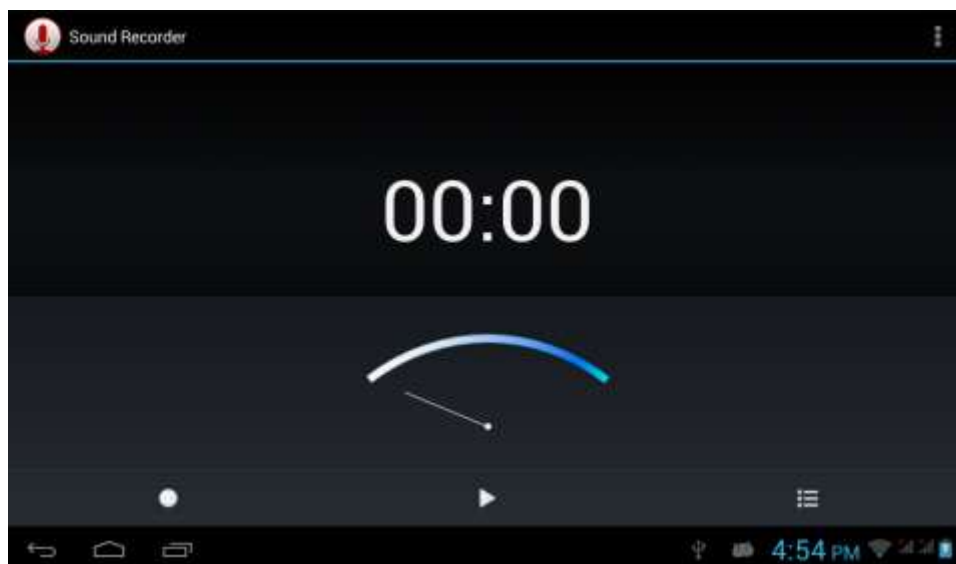

Figure10.7

11 Application Installation

11.1 Installation

Install third-party applications

- 1 Tap on "*Explorer*" application, select the application you want to install
- 2 Press and hold the application you need to install
- 3 Pop-up installation options, click *Install apk*
- 4 Follow the installation wizard to complete then can be run.

Note: Applications only with APK suffix are compatible with system.

11.2 Uninstall

Uninstall application

- 1 On the Home screen, tap *Settings* bitmap
- 2 Tap the *application* that lists all the applications installed on the system list of programs
- 3 Tap the APK you want to uninstall, click *Uninstall*
- 4 Click *OK* to complete the uninstall

Tips: system pre-installed program manager can easily achieve uninstall, Open the Program Manager, click on Uninstall tab, the system will list the installed application lis

12 Troubleshooting

1. Turn on MID slowly for the first time

- After MID system upgrading, the first time turn on the MID need to install the pre-installed applications, time in about 2-3 minutes. But it will faster later.

2. Device can not connect to Wi-Fi

- Ensure the router works well.
- Ensure the device and the wireless router is within the range of the wireless network to be connected too. Walls or other obstructions will reduce the possible distances between wireless devices
- Ensure the security password being used is correct

3. Heat Issues

When running multiple applications, using the screen on its brightest setting, or when being charged, this device can get quite hot. This is normal and should not cause any inconvenience when in use

4. Cannot set E-mail Account or registration application

- Ensure that the tablet is connected to a Wi-Fi network and can connect to the Internet
- Ensure your E-mail settings have been entered correctly for the account being accessed
- Make sure your system time and local time is the same.

5. System has anomalies and doesn't work correctly

Installing some third-party applications may cause the system to operate incorrectly. Press the RESET button and perform a system reset to resolve this issue

6. Unable to open the webpage

- Ensure the wireless router and MID device is within the range of the wireless network
- Please restart WIFI and try again

7. MID runs slowly

This is normal, Please close some applications which temporarily do not need to use the in Advanced Task Manager, Uninstall some third-party applications to free up more system resources.

13 Updating Instruction

1. Press the **“POWER”** button to turn off the device before updating (**NOTE:** Press and hold the **“POWER”** button for at least **10** seconds if the device can not be turned on normally).

Insert the Driver CD and copy the file named **“MTK Android Upgrade Tool”** to your computer desktop (**NOTE:** The device can not be updated directly from CD).

Open file **“ SP_Flash_Tool_v3.1332.0.187 ”** and double click



shown as below picture.

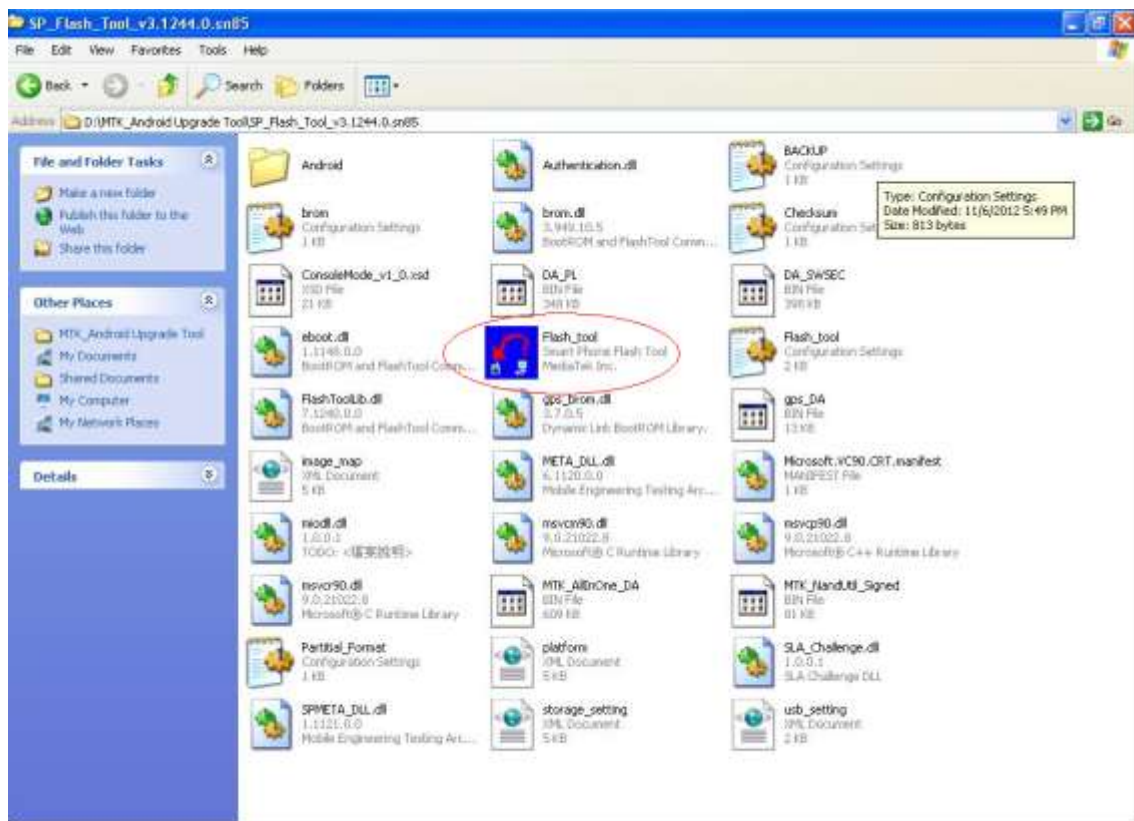

It shows as below picture after open the tool.

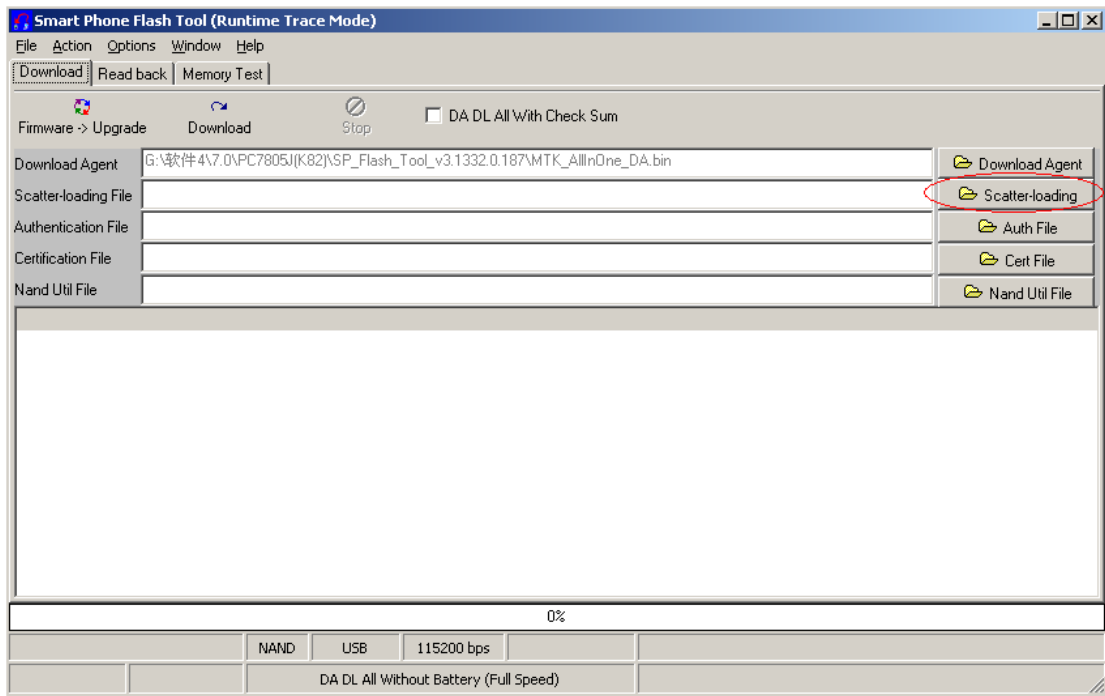

2. Click button “**Scatter-loading**” in the right, Choose file “**Upgrade file**” - “**MT8312_Android_scatter.txt**”, then click “**Open**”, shown as below picture.

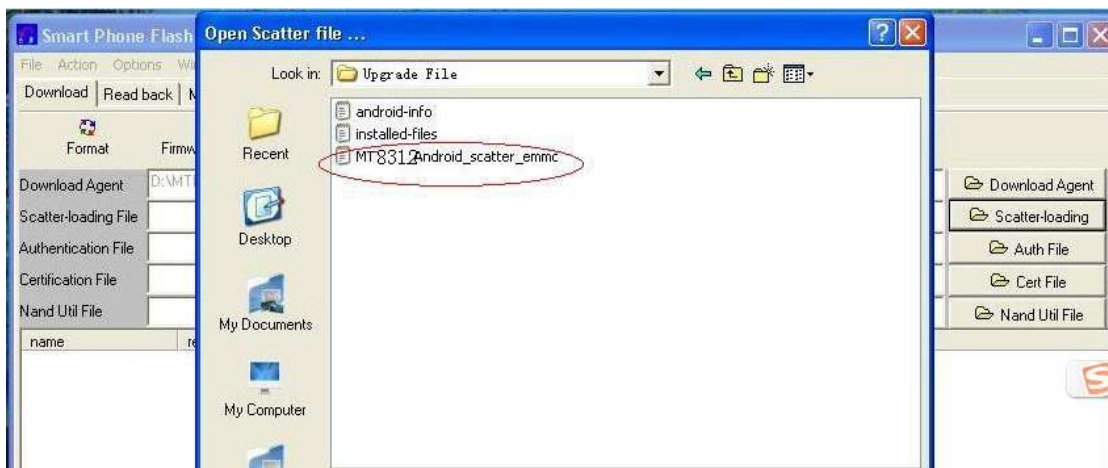

3. After device has been turned off; connect the device to the PC by the USB cable supplied with the device.
Choose “Install from a list or specific location (Advanced)”, and then click “Next”, see the picture below:

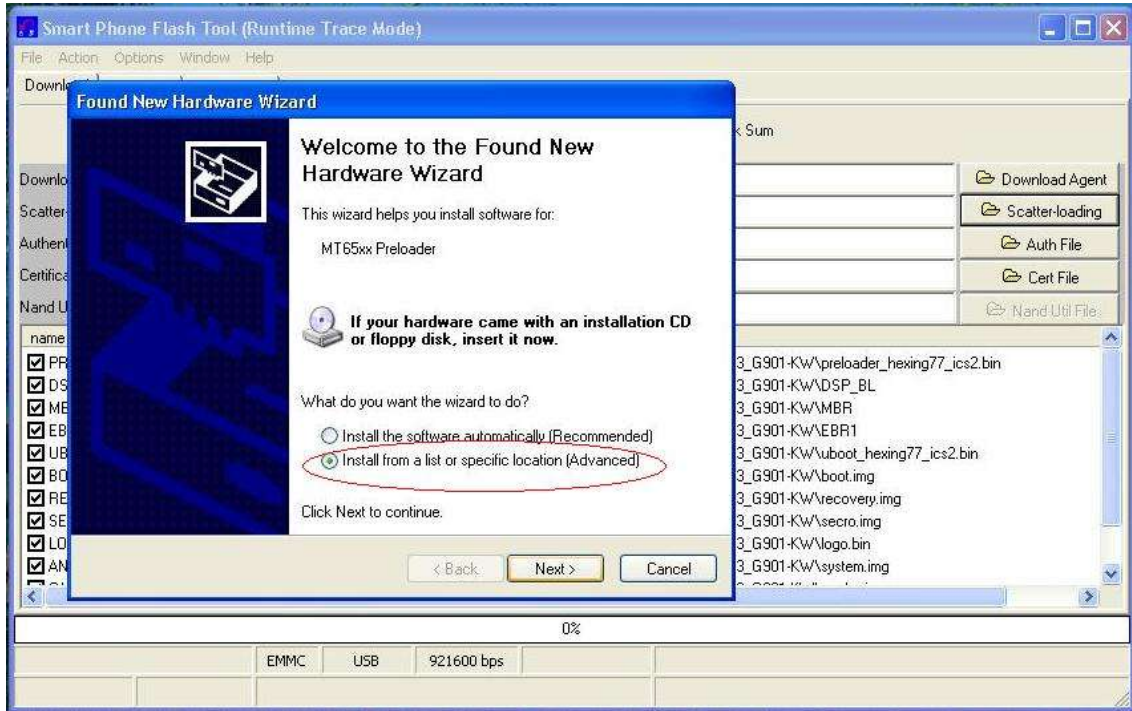

Choose “Include this location in the search” – “MTK Android Upgrade Tool” > “Driver_Auto_Installer_v1.1236.00” > SmartPhoneDriver > “x86” > “Infs”, Click “OK”. Shown as below picture.

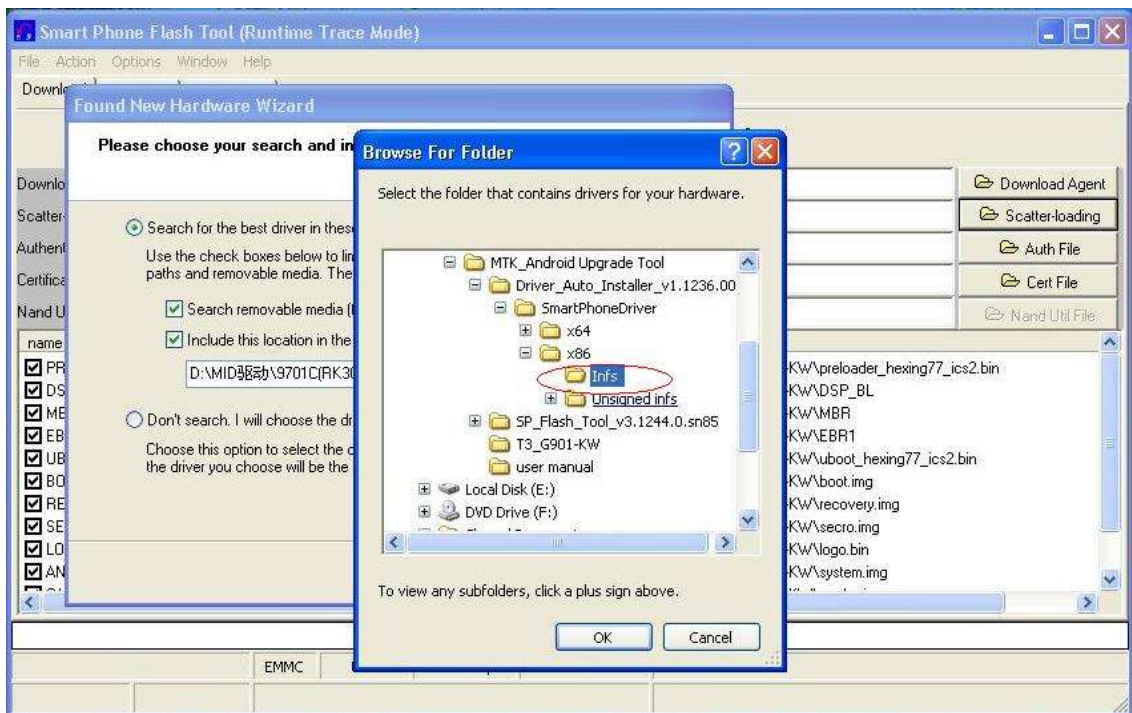

Then click “NEXT”, The system will detect and install the driver automatically, finally click “Finish”, see the pictures as below:

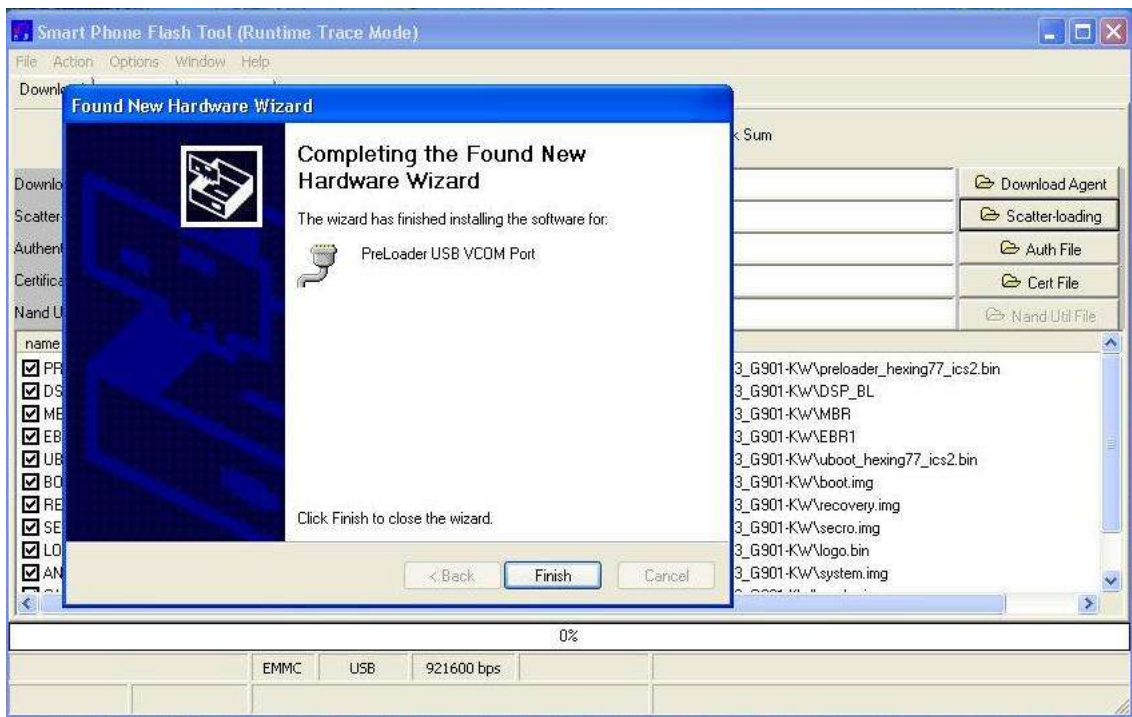
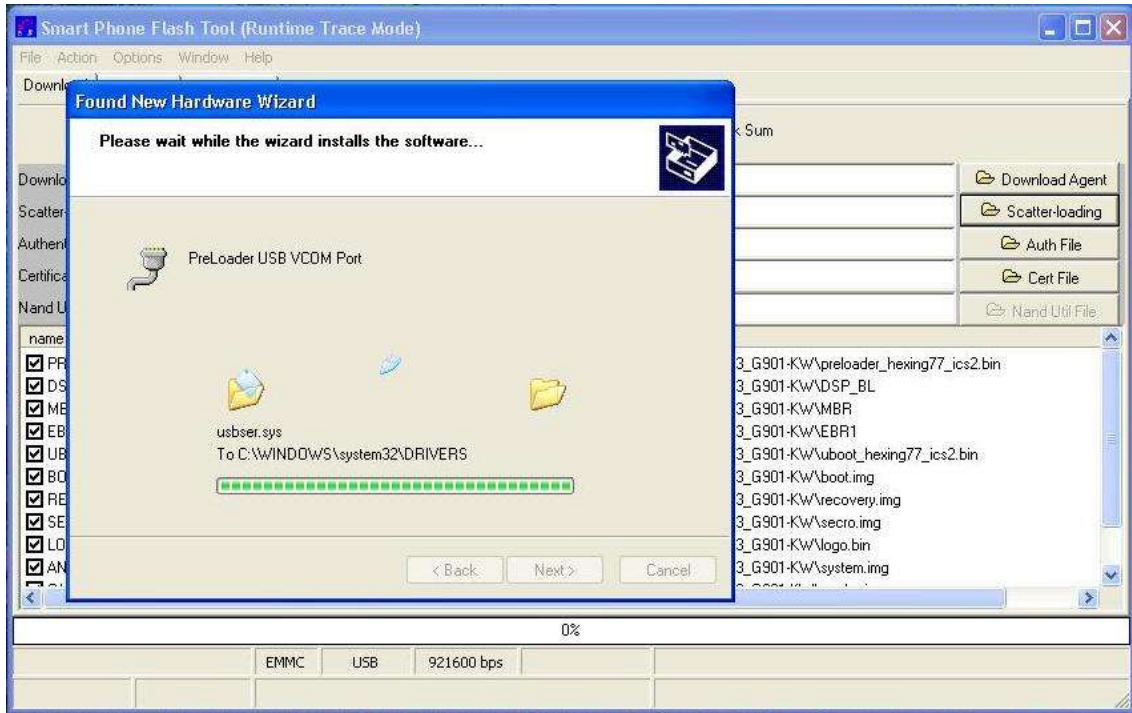

The “Found New Hardware Wizard” window will pop up on the bottom right corner as shown below.

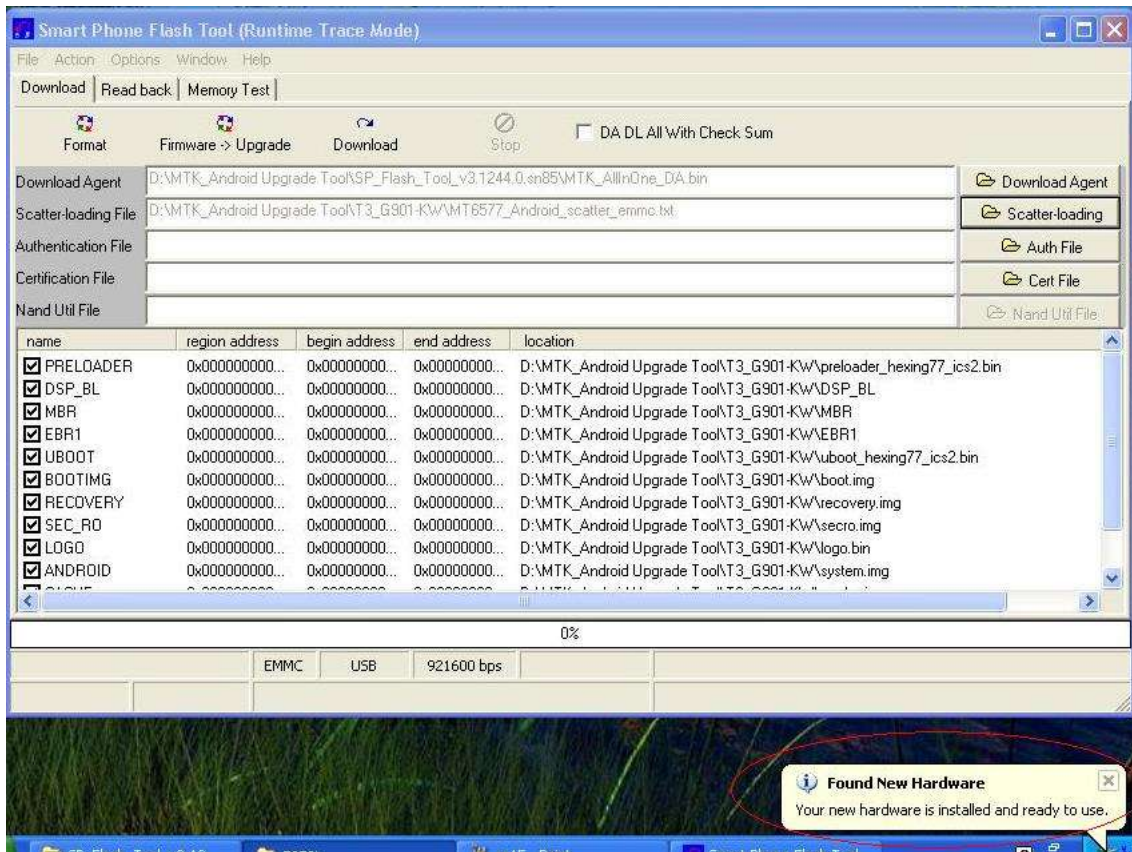

4. Pull out USB cable, then click **“Firmware->Upgrade”**

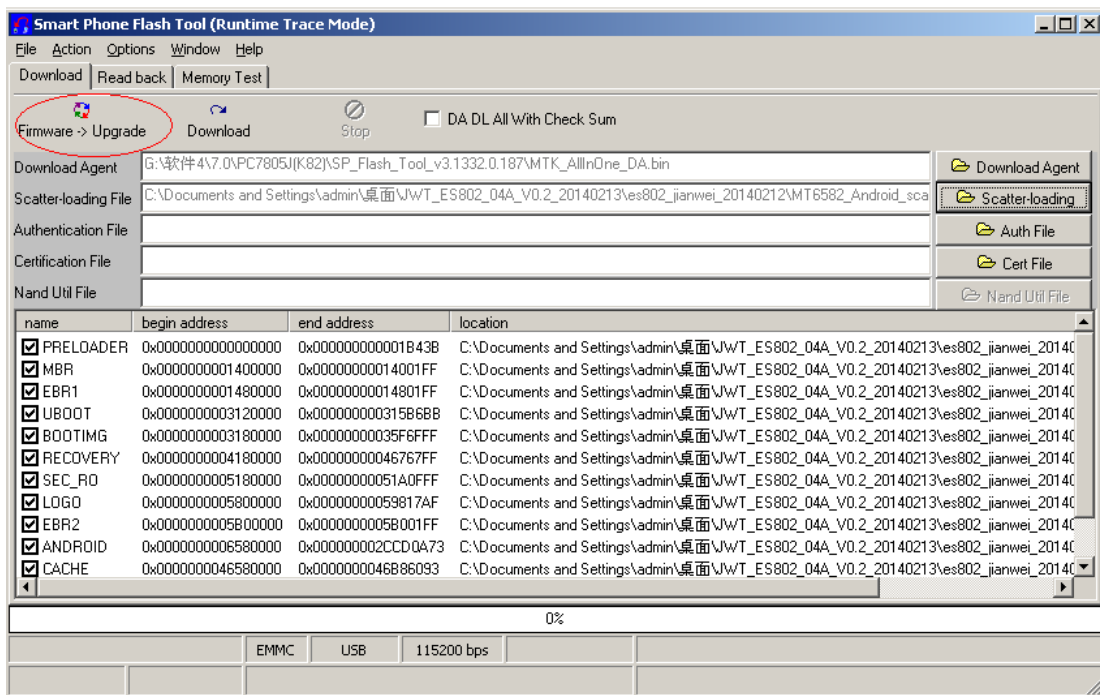

5. The upgrade process begins, shown as below picture (please reconnect the tablet pc to computer if it shows that it is being charged)

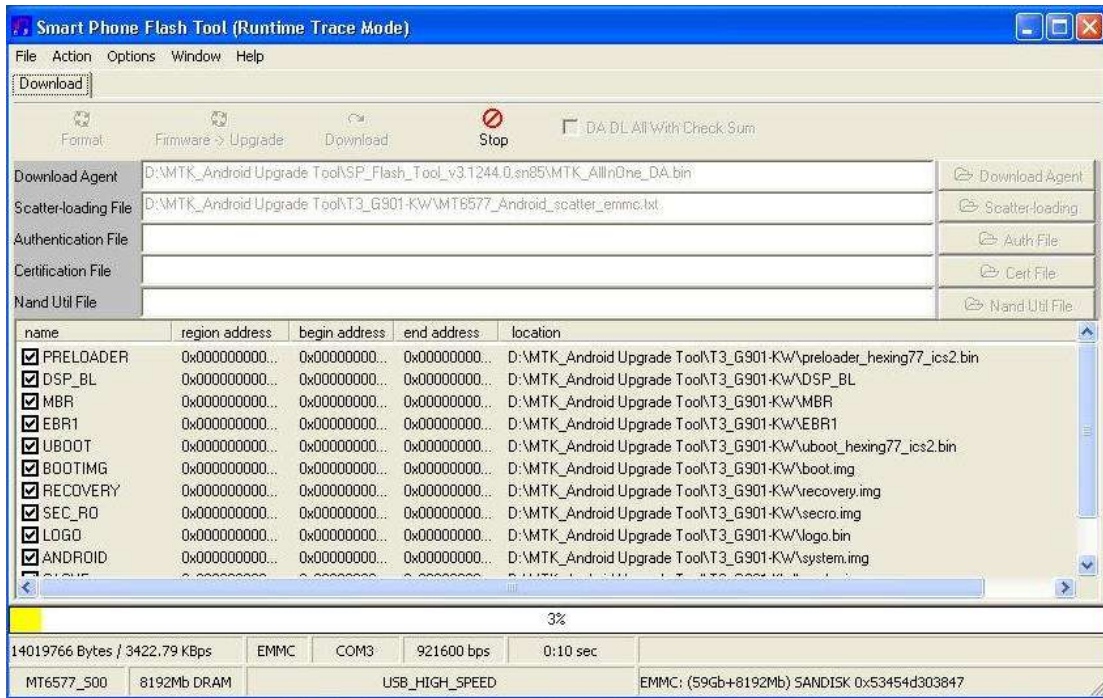

6. When the upgrading is 100% done , “Download OK” pops up. The upgrading process is done, and USB cable can be pulled out.

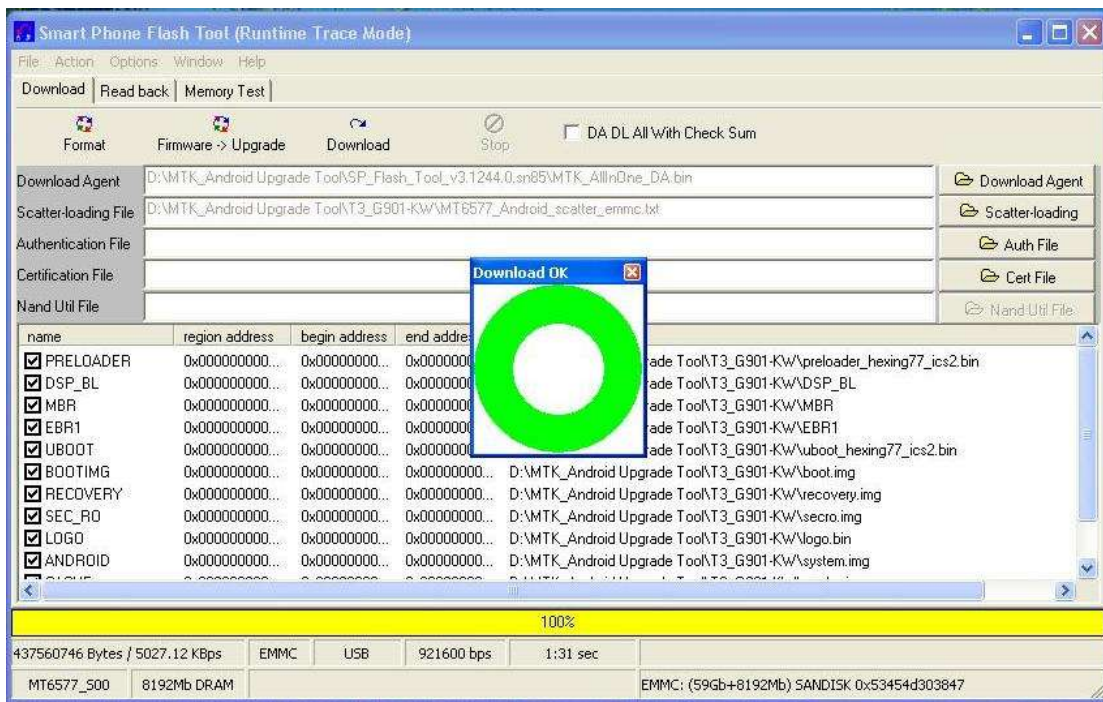

7. **NOTE:** Please don't disconnect the USB cable during the updating process because this will cause update failure or possible system failure of the device.

FCC RF EXPOSURE INFORMATION:

WARNING!! Read this information before using your phone

In August 1986 the Federal Communications Commission (FCC) of the United States with its action in Report and Order FCC 96-326 adopted an updated safety standard for human exposure to radio frequency (RF) electromagnetic energy emitted by FCC regulated transmitters. Those guidelines are consistent with the safety standard previously set by both U.S. and international standards bodies. The design of this phone complies with the FCC guidelines and these international standards. Use only the supplied or an approved antenna. Unauthorized antennas, modifications, or attachments could impair call quality, damage the phone, or result in violation of FCC regulations. Do not use the phone with a damaged antenna. If a damaged antenna comes into contact with the skin, a minor burn may result. Please contact your local dealer for replacement antenna.

BODY-WORN OPERATION:

This device was tested for typical body-worn operations with the back of the phone kept 0.5cm from the body. To comply with FCC RF exposure requirements, a minimum separation distance of 0.5cm must be maintained between the user's body and the back of the phone, including the antenna, whether extended or retracted. Third-party belt-clips, holsters and similar accessories containing metallic components shall not be used. Body-worn accessories that cannot maintain 0.5cm separation distance between the user's body and the back of the phone, and have not been tested for typical body-worn operations may not comply with FCC RF exposure limits and should be avoided.

For more information about RF exposure, please visit the FCC website at www.fcc.gov

Your wireless handheld portable telephone is a low power radio transmitter and receiver. When it is ON, it receives and also sends out radio frequency (RF) signals. In August, 1996, the Federal Communications Commission (FCC) adopted RF exposure guidelines with safety levels for hand-held wireless phones. Those guidelines are consistent with the safety standards previously set by both U.S. and international standards bodies:

<ANSI C95.1> (1992) / <NCRP Report 86> (1986) / <ICIMIRP> (1996)

Those standards were based on comprehensive and periodic evaluations of the relevant scientific literature. For example, over 120 scientists, engineers, and physicians from universities, government health agencies, and industry reviewed the available body of research to develop the ANSI Standard (C95.1). Nevertheless, we recommend that you use a hands-free kit with your phone (such as an earpiece or headset) to avoid potential exposure to RF energy. The design of your phone complies with the FCC guidelines (and those standards).

Use only the supplied or an approved replacement antenna. Unauthorized antennas, modifications, or attachments could damage the phone and may violate FCC regulations.

NORMAL POSITION:

Hold the phone as you would any other telephone with the antenna pointed up and over your shoulder.

TIPS ON EFFICIENT OPERATION:

For your phone to operate most efficiently:

- Extend your antenna fully.
- Do not touch the antenna unnecessarily when the phone is in use. Contact with the antenna affects call quality and may cause the phone to operate at a higher power level than otherwise needed.

RF Exposure Information:

This product is in compliance with FCC RF Exposure requirements and refer to FCC website search for FCC ID: BRCPC7805ME to gain further information include SAR Values.

This device complies with part 15 of the FCC rules. Operation is subject to the following two conditions:

- (1) this device may not cause harmful interference, and

(2) this device must accept any interference received, including interference that may cause undesired operation.

NOTE: The manufacturer is not responsible for any radio or TV interference caused by unauthorized modifications to this equipment. Such modifications could void the user's authority to operate the equipment.

NOTE: This equipment has been tested and found to comply with the limits for a Class B digital device, pursuant to part 15 of the FCC Rules. These limits are designed to provide reasonable protection against harmful interference in a residential installation. This equipment generates uses and can radiate radio frequency energy and, if not installed and used in accordance with the instructions, may cause harmful interference to radio communications. However, there is no guarantee that interference will not occur in a particular installation. If this equipment does cause harmful interference to radio or television reception, which can be determined by turning the equipment off and on, the user is encouraged to try to correct the interference by one or more of the following measures:

- Reorient or relocate the receiving antenna.
- Increase the separation between the equipment and receiver.
- Connect the equipment into an outlet on a circuit different from that to which the receiver is connected.
- Consult the dealer or an experienced radio/TV technician for help

Do not use the device with the environment which below minimum -10°C or over maximum 50°C, the device may not work.

Changes or modifications to this unit not expressly approved by the party responsible for compliance could void the user's authority to operate the equipment.

Ad Hoc function is supported but not able to operate on non-US frequencies.