

A decorative horizontal bar chart composed of vertical bars of varying heights and colors (gray, light blue, and medium blue). The bars are arranged in a pattern that frames the central text.

INSTRUCTION MANUAL

**DP 405**

Digital Two-way Radio

**DIGITAL**

<http://en.kirisun.com>

# **User Manual**

## **DP405**

### **Digital Two-way Radio**

We are very grateful for your purchasing KIRISUN brand two-way radios produced by Kirisun Communications Co., Ltd.

We believe KIRISUN two-way radio, which always incorporates the latest technology, can bring great convenience to your life and work.

We also believe that the quality and function of KIRISUN two-way radio can meet your demands for reliable communication.

## Notice to user

### RF Energy Exposure Information

### RF Energy Exposure Awareness And Control

#### Information For Fcc Occupational Use Requirements

Before using the two-way portable radio, review the following important RF energy awareness and control information and operational instructions. Comply with this information and instructions in order to ensure compliance with RF exposure guidelines. e the capability to access information in that form.



This radio is intended for use in occupational/controlled conditions, where users have full knowledge of their exposure and can exercise control over their exposure to remain below RF exposure limits. This radio is NOT authorized for general population, consumer, or any other use.

#### **Changes or modifications not expressly approved by Kirisun Communications Co., Ltd. could void the user's authority to operate the equipment.**

This two-way radio uses electromagnetic energy in the radio frequency (RF) spectrum to provide communications between two or more users over a distance. It uses RF energy or radio waves to send and receive calls. RF energy is one form of electromagnetic energy. Other forms include, but are not limited to, electric power, sunlight, and x-rays. RF energy, however, should not be confused with these other forms of electromagnetic energy, which, when used improperly, can cause biological damage. Very high levels of x-rays, for example, can damage tissues and genetic material. Experts in science, engineering, medicine, health, and industry work with organizations to develop standards for exposure to RF energy. These standards provide recommended levels of RF exposure for both workers and the general public. These recommended RF exposure levels include substantial margins of protection. All two-way radios marketed in North America are designed, manufactured, and tested to ensure they meet government-established RF exposure levels. In addition, manufacturers also recommend specific operating instructions to users of two-way radios. These instructions are important because they inform users about RF energy exposure and provide simple procedures on how to control it.

**Federal Communications Commission Regulations**

Before it was marketed in the United States, the Digital portable radio was tested to ensure compliance with FCC RF energy exposure limits for two-way portable radios. When two-way radios are used as a consequence of employment, the FCC requires users to be fully aware of and able to control their exposure to meet occupational requirements. Exposure awareness can be facilitated by the use of a label directing users to specific user awareness information. The radio has an RF exposure product label. Also, the Product Safety Manual and this Operator's Manual include information and operating instructions required to control RF exposure and to satisfy compliance requirements.

**Operation Safety Recommendations****Occupational Safety Guidelines And Safety Training Information**

To ensure bodily exposure to RF electromagnetic energy is within the FCC allowable limits for occupational use. Always adhere to the following basic guidelines:

- The push-to-talk button should only be depressed when intending to send a voice message.
- The radio should only be used for necessary work-related communications.
- The radio should only be used by authorized and trained personnel. It should never be operated by children.
- Do not attempt any unauthorized modification to the radio. Changes or modifications to the radio may cause harmful interference and/or cause it to exceed FCC RF exposure limits. Only qualified personnel should service the radio.
- Always use only authorized accessories (antennas, control heads, speakers/mics, etc.). Use of unauthorized accessories can cause the FCC RF exposure compliance requirements to be exceeded.

The information listed above provides the user with information needed to make him or her aware of a RF exposure, and what to do to assure that this radio operates within the FCC exposure limits of this radio.

**This device complies with part 15 of the FCC Rules. Operation is subject to the condition that this device does not cause harmful interference.**

## Content

<b>1</b>	<b>UNPACKING AND CHECKING</b> .....	<b>1</b>
1.1	SUPPLIED ACCESSORIES .....	1
<b>2</b>	<b>BATTERY INFORMATION</b> .....	<b>2</b>
2.1	NOTICE.....	2
2.2	BATTERY CHARGING .....	3
<b>3</b>	<b>ATTACHING THE ACCESSORIES</b> .....	<b>4</b>
3.1	ATTACHING/DETACHING THE BATTERY .....	4
3.2	ATTACHING/DETACHING THE ANTENNA .....	4
3.3	ATTACHING/DETACHING THE BELT CLIP .....	5
3.4	ATTACHING THE MICROPHONE .....	5
<b>4</b>	<b>INTRODUCTION</b> .....	<b>6</b>
<b>5</b>	<b>PROGRAMMABLE KEYS</b> .....	<b>8</b>
5.1	PROGRAMMABLE KEYS.....	8
5.2	LED INDICATION .....	9

---

<b>6</b>	<b>BASIC OPERATION .....</b>	<b>10</b>
6.1	POWER ON/OFF THE RADIO .....	10
6.2	SELECTING THE CHANNEL.....	10
6.3	ADJUSTING THE VOLUME.....	11
6.4	INITIATING A CALL .....	11
6.5	RECEIVING .....	11
6.6	REPLYING TO THE CALL.....	11
<b>7</b>	<b>FEATURES AND OPERATION .....</b>	<b>12</b>
7.1	TOT (TIME-OUT-TIMER).....	12
7.2	CHANNEL SCAN .....	12
7.3	SCAN THE REPLY MESSAGE .....	12
7.4	PRIORITY SCAN .....	12
7.5	KILL AND UNKILL.....	13
7.6	EMERGENCY.....	13
7.7	ENABLING COLOR CODE ON DIGITAL MODE .....	14
7.8	TECHNICAL PARAMETERS.....	14
<b>8</b>	<b>TROUBLE SHOOTING.....</b>	<b>15</b>

**FCC STATEMENT ..... 16**

## 1 Unpacking and Checking

Please carefully open the box, and check if the accessories listed below are contained in the package. For any missed or damaged item, please contact your local dealer for solution.

### 1.1 Supplied Accessories

Material	Quantity
Radio	1
Charger	1
Power Adaptor	1
Battery	1
Belt Clip	1
Antenna	1
Strip	1
User Manual	1

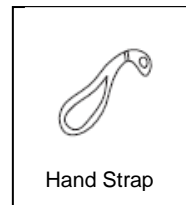
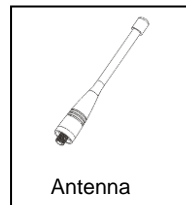
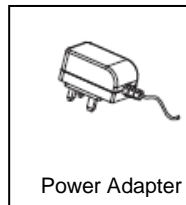
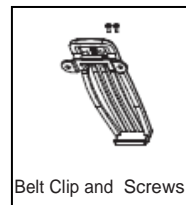
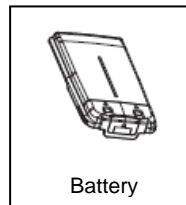
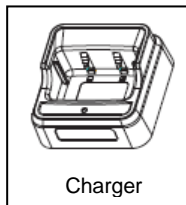



## 2 Battery Information

### 2.1 Notice

The battery is not charged before delivery, so please charge the battery for your first use. If the battery is not used for a long time or the battery is used up, please charge it before use. Charge/discharge for twice or three times alternately to achieve its optimal performance. For low battery, please charge it or replace it.

Note:

- ◆ Do not cause any short circuit on the battery or throw the battery into fire.
- ◆ When attaching the battery to the radio for charging, please make sure the radio is powered off to guarantee it can be fully charged.
- ◆ Do not leave the radio or battery on the charger after it is fully charged. Unnecessary constant charging will shorten the battery life.
- ◆ Do not put the fully-charged battery back to the charger for re-charging, or it may shorten the battery life.
- ◆ Please try to keep the battery in an indoor environment at around 25°C. The battery may get easily spoiled after being kept in the environment below -10°C for a long time.
- ◆ In temperature higher than 35°C or below -10°C, the dischargeable power of the battery may decrease due to the physical property of lithium battery.

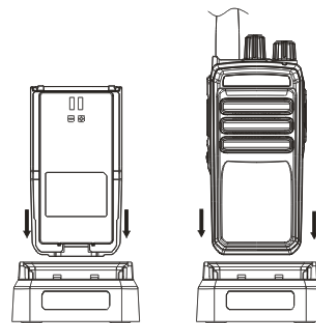
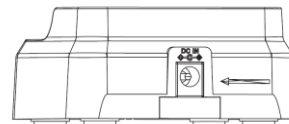

## 2.2 Battery Charging

- (1) Plug the power adaptor in the proper socket of AC power.
- (2) Plug the cable of the power adaptor at the back of the socket, and the green indicator glows.
- (3) Plug the battery or radio in the charger.
- (4) Make sure that the battery is in proper contact with the charger terminal, and the red indicator glows.
- (5) After the battery is charged for 6 hours, the red light goes out, indicating that the battery is fully charged.
- (6) When the green indicator glows, keep the battery on the charger for 1-2 hours before taking it out so as to achieve the optimal performance.
- (7) Take out the power adaptor from the socket of AC power output.

### Note:

- ◆ The battery is not charged before delivery from the factory, so please charge the battery before your first use.
- ◆ Kirisun KB-760B lithium-ion can be used for this radio.
- ◆ If the battery which is stored for over 2 months or a new battery is charged for the first time, it should be charged repeatedly to gain full battery capacity. The battery should be at least charged once every three months.
- ◆ When the battery is fully charged or the battery power is above the level of low power alert, do not charge the battery, or it may affect the battery life and performance. Please take out the battery from the charger after it is fully charged.
- ◆ When the radio enters the state of low voltage alarm, please charge the battery before using it and do not force to power on the radio in case that the battery life and performance is impaired.
- ◆ There is protection circuit inside KB-760B lithium battery. The power supply will be cut off in state of low power, and when you charge it in the charger, the indicator will glow after 1-5 minutes.

### 3 Attaching the Accessories

#### 3.1 Attaching/Detaching the Battery

##### ◆ Attaching the Battery

- (1) Slightly press the top of the belt clip as shown in ①;

##### ◆ Detaching the battery

- (1) For detaching the battery, please first turn off the radio.
- (2) Slide the battery latch along the direction as shown in ① to bounce the battery as shown in ②.
- (3) Slide to take out the battery along the direction as shown in ③. If there is belt clip, slightly press the belt clip top as shown in ④ and slide the battery along the direction as shown in ③ to take out the battery.

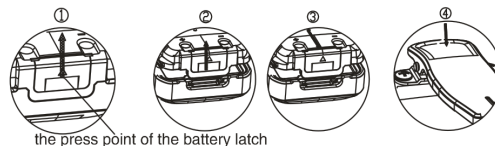
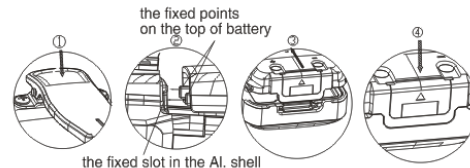

##### Note:

- ◆ Do not throw the battery terminals with short circuit or battery into fire.
- ◆ Do not remove the battery case without permission.

#### 3.2 Attaching/Detaching the Antenna

For attaching the antenna, put the antenna's end with screw thread into the

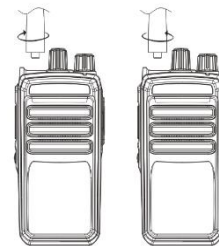

antenna port.

Turn the antenna clockwise until it is fixed.

For detaching the antenna, turn it counter-clockwise.

### 3.3 Attaching/Detaching the Belt Clip

Align the two screws on the belt clip with the screw holes at the back of the radio.

Use two 2.5x6.5 machine screws.

When detaching, loosen the two screws on the belt clip and remove the belt clip.

M2.5\*6.5 screw to  
fasten the belt clip

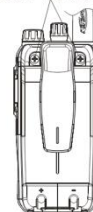

### 3.4 Attaching the Microphone

Open the earphone cover plate on the right and connect the earphone cable to the port.

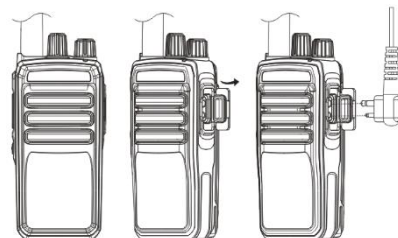

## 4 Introduction

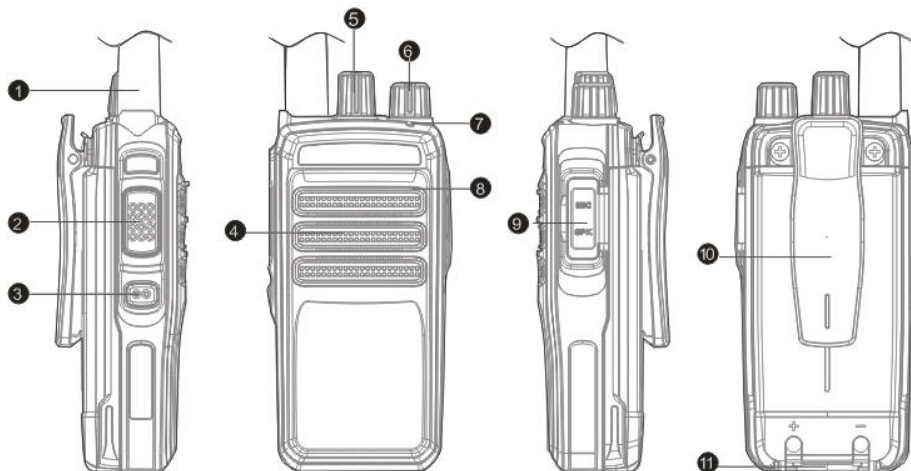

No.	Part Name
1	Antenna
2	PTT key Press this key to initiate a call and talk
3	Side key (programmable key) This key can be set with different features by dealer. Please refer to “5 Programmable Keys” for further details
4	Speaker Voice Output.
5	Channel Knob Rotate the knob to select channel 1-16.
6	Power/Volume Knob Turn it clockwise to turn on the radio. For turning off the radio, turn it counter-clockwise until a click is heard. When the radio is on, rotate the knob to adjust the volume.
7	LED Indicator Red indicator means the radio is transmitting, green means receiving and when the red indicator flashes, it means power shortage.
8	Microphone Voice input
9	External port Open the cover plate and connect the external speaker and microphone
10	Belt Clip
11	Battery Latch

## 5 Programmable Keys

### 5.1 Programmable Keys

To suit the operation habits of customer, programmable keys (side keys) are available and can be set by dealer as shortcut key.

**Note:**

Short Press: press and release quickly.

Long Press: press and hold for a while (press duration can be set by programming software)

No.	Programmable Feature	Application
1	None	No feature
2	High/Low Power	Switch to high and low power
3	Monitor	If the current analogue channel has CTCSS, press this key and switch to carrier squelch mode to cancel CTCSS; press it again to go back to the original state.
4	Emergency	Starts the emergency feature. Used for seeking help in emergency.
5	Emergency Exit	Exits the emergency state.

6	Squelch on/off	Enable/Disable squelch feature. Used for receiving the weak signals on the analogue channel.
7	Squelch Level	Adjusts the signal strength required when receiving.
8	Scan	Enable/Disable scan feature and listens to the communication activities on other channels.
9	Alert Tone on/off	Enable/disable all the alert tones.
10	Zone Selection	Press this key to switch among different zones. The zones are programmed by programming software.
11	Repeater/Talk around	Enable/disable Repeater feature.
12	Nuisance Delete	Deletes the channel which is useless from the scan list.

## 5.2 LED Indication

State	Operation
Glows red	Transmitting
Glows green	Receiving



Flashes red	Low battery
Flashes green	Channels are being scanned
Flashes orange	Digital call hang time and it will exit when the hang time is up
Glow orange	Blank channel which is not available. Switch to other channel to exit.
Flashes red quickly	The programming software is reading the parameters available for configuration
Flashes green quickly	The programming software is writing the parameters which is available for configuration into the radio.

## 6 Basic Operation

### 6.1 Power on/off the Radio

When the radio is off, rotate the power/volume knob clockwise until a click is heard to power on the radio.

When the radio is on, rotate the power/volume knob counter-clockwise until a click is heard to turn off the radio.

### 6.2 Selecting the Channel

When the radio is on, rotate the channel selector knob to select channels.

### 6.3 Adjusting the Volume

When the radio is on, rotate the power/volume knob clockwise to increase the volume and counter-clockwise to decrease the volume.

### 6.4 Initiating a Call

Press PTT button to initiate a call to the default contact on the current channel when it is digital channel. The default contact on the current channel can be programmed by dealer.

### 6.5 Receiving

When the radio receives the right signal on the current channel and green LED will light.

When the current channel is digital channel and when it received private call, group call or all call, the radio will output the voice from the channel.

When the channel is analogue channel and when it received analogue signals with CTCSS matching the one on this channel (or there is no CTCSS set on the channel), the radio will output voice form the channel.

### 6.6 Replying to the Call

When the current channel is digital channel and after a call is received, press PTT button within the call hang time to reply. If the call hang time is up, you need to initiate a call to reply. The call hang time can be set by dealer.

When the current channel is analogue channel and after a call is received, press PTT button within the call hang time and speak to the microphone to reply.

## 7 Features and Operation

### 7.1 TOT (time-out-timer)

TOT prevents the user from occupying the channel for too long. If the continuous transmission exceeds the duration set by dealer, the radio will stop transmitting and sound alarm. For stopping alarm, release PTT button. For transmission again, please press PTT button after a certain time interval (interval set by dealer). If the dealer set pre-alarm feature, pre-alarm will sound before TOT time is up.

### 7.2 Channel Scan

Channel scan searches channels with signals. When the channel scanned has signals, the radio will stay on this channel for communication. Scan method is carrier control scan.

By pressing the Scan shortcut key, the radio can scan the scan list related to the current channel. When the radio is in scan state, press the Scan shortcut key again to stop the scan.

### 7.3 Scan the Reply Message

When the radio is scanning, press PTT button and the radio will transmit and talk on the predefined channel. This channel is set by dealer.

### 7.4 Priority Scan

When there is priority scan set in the scan list, the priority scan will be automatically enabled when the radio starts the scan feature. The priority scan mode is cycle scan, and it scans priority channel every time when it scans a conventional channel. For example, if there are channel 1, 2, 3, 4 in the scan list and channel 2 is priority channel, the scan cycle will be 1->2->3->2->4->2->1.

## 7.5 Kill and Unkill

If the dealer enables and sets Kill and Unkill, the radio is able to receive and decode the Kill/Unkill signals from other radios. After being killed, the radio cannot transmit or receive any signals but activation signal. After being activated, the radio will be back to normal state. Kill/Unkill feature is valid on digital mode.

## 7.6 Emergency

In state of emergency, press the Emergency shortcut key to send emergency alarm.

Emergency alarm consists of two parts: alarm type and alarm mode. Alarm mode is used to specify the contents sent to other members in emergency. You can ask your dealer to set these parameters based on your requirements.

For exiting emergency, press again the Emergency shortcut key.

### ◆ Alarm Mode

Emergency Alarm: enable to send alarm and exit alarm state automatically afterwards.

Emergency Alarm + Emergency Call: after the radio sends emergency alarm, press PTT button to send emergency call.

Emergency Alarm + Auto Background Tone: after the radio sends emergency alarm, the background tone will be sent automatically in the way of emergency call.

### ◆ Alarm Type

None: no alarm feature (default).

Siren Only: after the radio enters the alarm state, the siren can only sound locally and the control center will not receive any alarm signals.

Conventional: after the radio enters alarm state, there will be light and sound alert and it can also receive response from other members.

Secret: after the radio enters alarm state, there will be no light or sound alert, and it cannot receive response

from other members.

Secret with Voice: after the radio enters alarm state, there will be no light or sound alert but it can receive response from other members.

**Note:**

Emergency Alarm: the radio transmits non-speech signal to trigger the alarm sent from other radios.

Emergency Call: it is a call mode which is faster in occupying channel than common calls, which ensures smooth call in emergency.

### 7.7 Enabling Color Code on Digital Mode

Only when both the color code and ID matches, the speaker can be turned on to receive.

Range: 0~15 (16 groups of color codes)

### 7.8 Technical Parameters

Frequency Range: 450MHz to 520MHz;

RF Output Power: High Power: 4W, Low Power: 1W;

Modulation Type:

Analog Voice: FM, Digital Data: 4FSK;

Channel Separation: Analog Voice: 12.5kHz; Digital Data: 12.5kHz;

## 8 Trouble shooting

No.	Problem	Cause and Solution
1	Failed to power on	A. The battery is used up –charge the battery or change to a new battery; B. Volume switch is faulty – repair at the specified service station;
2	Small voice during call	A. speaks too far from the microphone – the ideal distance: 3-10cm; B. wrong volume setting – turn the volume knob clockwise to increase the volume;
3	Failed to transmit or receive	A. wrong channel parameters – reset the parameters and try again; B. the group identity for default contact is wrong – select a right group; C. Beyond the communication scope.

## FCC Statement

This device complies with Part 15 of the FCC Rules. Operation is subject to the following two conditions:

- (1) This device may not cause harmful interference, and
- (2) This device must accept any interference received, including interference that may cause undesired operation.

NOTE 1: This equipment has been tested and found to comply with the limits for a Class B digital device, pursuant to part 15 of the FCC Rules. These limits are designed to provide reasonable protection against harmful interference in a residential installation. This equipment generates, uses and can radiate radio frequency energy and, if not installed and used in accordance with the instructions, may cause harmful interference to radio communications. However, there is no guarantee that interference will not occur in a particular installation. If this equipment does cause harmful interference to radio or television reception, which can be determined by turning the equipment off and on, the user is encouraged to try to correct the interference by one or more of the following measures:

- Reorient or relocate the receiving antenna.
- Increase the separation between the equipment and receiver.
- Connect the equipment into an outlet on a circuit different from that to which the receiver is

connected.

-Consult the dealer or an experienced radio/TV technician for help.

NOTE 2: Any changes or modifications to this unit not expressly approved by the party responsible for compliance could void the user's authority to operate the equipment.

Output power listed is rated conducted. This device must be restricted to workrelated operations only in an Occupational/Controlled RF exposure environment and must operate with a duty factor not exceeding 50%. This transmitter may operate with the antenna(s) documented in this filing in Pushto- Talk and body-worn configurations. RF exposure compliance is limited to the specific belt-clip and accessory configurations as documented in this filing and the separation distance between user and the device or its antenna shall be at least 2.5 cm. All qualified end-users of this device must have the knowledge to control their exposure conditions and/or duration to comply with occupational/controlled Exposure limit and requirements. The highest reported SAR values for Face-held, body-worn are 2.88W/Kg, 5.93 W/Kg.