

User Manual
DP990
DMR Two Way Radio

We are very grateful for your purchasing Kirisun brand two-way radio produced by Kirisun Communications Co., Ltd

We believe Kirisun two-way radio, which always incorporates the latest technology, can bring great convenience to your life and work. We also believe that the quality and function of Kirisun two-way radio can meet your demands for reliable communication.

Notice

- ◆ Please carefully read this instruction manual before using the product for your easy operation. We will consider that you have read this manual when you use the product.
- ◆ Please carefully keep the manual for future reference.
- ◆ In order to protect your legal rights from infringement, please carefully fill in the warranty card and claim valid receipt.
- ◆ Kirisun and our authorized partners own the intellectual property of all the parts of this product (including accessories). Any design and materials may not be modified, copied, extracted or translated without authorization of Kirisun or its authorized parties.
- ◆ This product may involve update or modification in future, and Kirisun owns the right to change the specifications of software and hardware described in this manual without further notice. Specifications and information contained in this manual are for reference only.
- ◆ All the contents are carefully proofread, but mistake may be inevitable. The rights of final explanation are preserved by Kirisun.

Safety Precaution

- ◆ The radio can only be repaired or maintained by professional technicians. The user must not disassemble the radio at liberty.
- ◆ In order to avoid problems caused by electromagnetic interference or electromagnetic incompatibility, please turn off the radio in the place such as hospital, plane and other health care centers where there is a sign such as “Turn off Your Radio”.
- ◆ In the car with air bags, please do not keep your radio at the place within possible reach of the air bag spread.
- ◆ Please turn off your radio before entering flammable or explosive environment.
- ◆ Do not change or charge the battery in flammable or explosive environment.
- ◆ Please turn off your radio when getting closer to the blast zone or thunder zone.
- ◆ Do not use any radio with damaged antenna, which may cause slight burning to the skin in contact.
- ◆ Please make sure that the antenna is properly attached when using the radio.
- ◆ Please keep the radio vertical when it is transmitting, and also keep the microphone 5 cm away from your mouth.
- ◆ Please make sure that the antenna is 2.5cm away from your body when the radio is transmitting.

Battery

- ◆ If the conductive substance on human body makes contact with the exposed battery terminal, it may damage your belongings, and/or do harm, such as burning, to human body. Conductive material includes jewelry, keys or bead-like necklace. They can form a loop (it causes short circuit) with battery and cause skin burn after the rapid temperature rise. Be cautious when managing a charged battery, especially when you put it in the pocket, wallet or container with metallic objects. To decrease the risk of being harmed, the battery cannot be exposed in the file, disassembled or squeeze.
- ◆ The highest environment temperature around the power supply device or voltage transformer must not be higher than 40°C (104°F).
- ◆ Please turn off the radio attached with battery when charging. Using radio during charging will affect its charging process.
- ◆ Please do not put the radio and battery into the charger when they are not in need of charging, and constant charging will shorten the battery life. Do not use the charger as a store to radio.
- ◆ To achieve optimal performance, we recommend changing battery after one-year use.

Content

1	UNPACKING AND CHECKING	- 2 -
2	BATTERY INFORMATION	- 3 -
3	INTRODUCTION.....	- 7 -
4	BASIC OPERATION	- 9 -
5	INITIATING/RECEIVING A CALL.....	- 13 -
6	SHORT MESSAGE	- 14 -
7	EMERGENCY	- 19 -
8	CALL LOG	- 21 -
9	GENERAL SETTING.....	- 23 -
10	ADVANCED FEATURES	- 29 -
11	TROUBLESHOOTING.....	- 40 -

12	MAJOR TECHNICAL SPECIFICATION	- 42 -
13	FCC STATEMENT	- 47 -

1 Unpacking and Checking

Please carefully open the box, and check if the accessories listed below are contained in the package. For any missed or damaged item, please contact your local dealer for solution.

1.1 Supplied Accessories

Material	Quantity
Radio	1
Charger	1
Power Adaptor	1
Battery	1
Belt Clip	1
Antenna	1
Strap	1
Certificate	1
User Manual	1

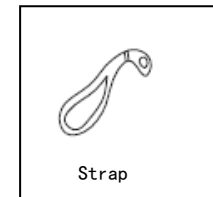
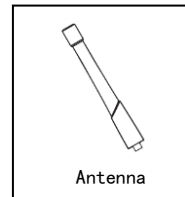
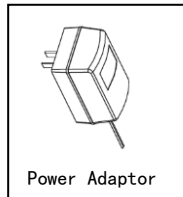
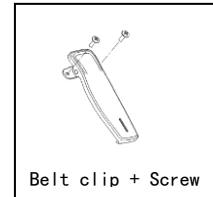
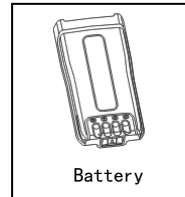
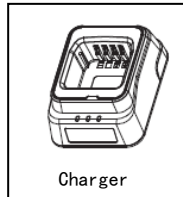

2 Battery Information

2.1 Battery Charging

- 1) Plug the power adaptor in the proper socket of AC power.
- 2) Plug the cable of the power adaptor at the back of the socket, and the green indicator glows.
- 3) Plug the battery or radio in the charger

Make sure that the battery is in proper contact with the charger terminal, and the red indicator glows.

- 4) After the battery is charged for 5 hours, the red light goes out, indicating that the battery is fully charged.

When the green indicator glows, keep the battery on the charger for 1-2 hours before taking it out so as to achieve the optimal performance.

- 5) Take out the power adaptor from the socket of AC power output.



Note:

- ◆ The battery is not charged before delivery from the factory, so please charge the battery before your first use.
- ◆ If the battery which is stored for over 2 months or a new battery is charged for the first time,

it should be charged repeatedly to gain full battery capacity. The battery should be at least charged once every three months.

- ◆ When the battery is fully charged or the battery power is above the level of low power alert, do not charge the battery, or it may affect the battery life and performance. Please take out the battery from the charger after it is fully charged.
- ◆ When the radio enters the state of low voltage alarm, please charge the battery before using it and do not force to power on the radio in case that the battery life and performance is impaired.

2.2 Attaching the Battery

As shown in ①, align the battery with the main unit and push it from the bottom. Press the battery until a click is heard as shown in ②

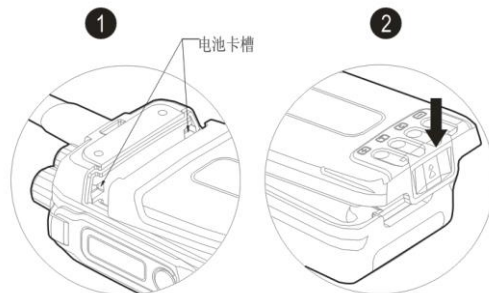

2.3 Detaching the Battery

For detaching the battery, please turn off the radio. As shown on the right picture, lift the battery latch to bounce the battery, and slide the battery downwards to take it out.

Note:

- ◆ Do not throw the battery terminals with short circuit or battery into fire.
- ◆ Do not remove the battery case without permission.

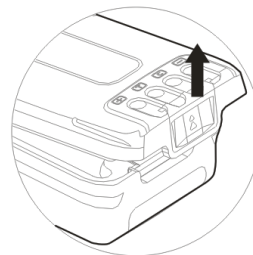

2.4 Attaching the Antenna

As shown in ①, align the antenna with the interface at the radio top, and turn it clockwise to fasten.

For detaching the antenna, turn the antenna counter-clockwise as shown in ② to take it out.

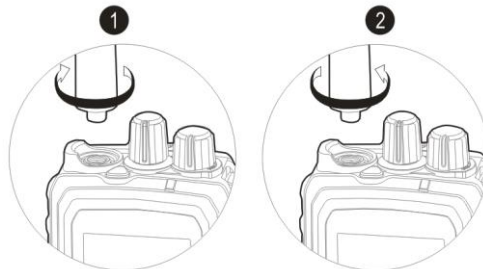

2.5 Attaching the Audio Accessories

Connect the audio accessory in the port and fix it with screw

2.6 Attaching the Belt Clip

Align the two screw holes in the belt clip with the holes at the back of the radio, and fix them together with screws.

Loosen the screws to detach the belt clip.

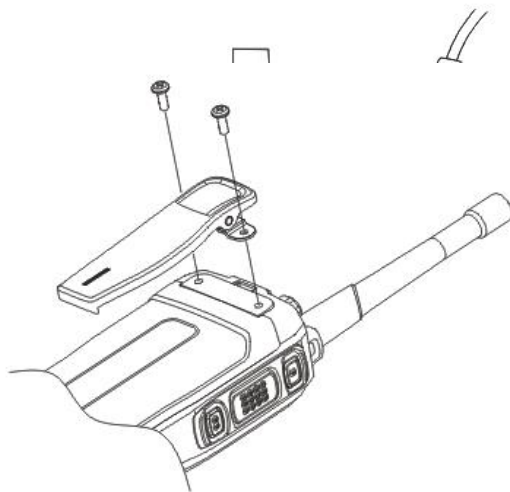

3 Introduction

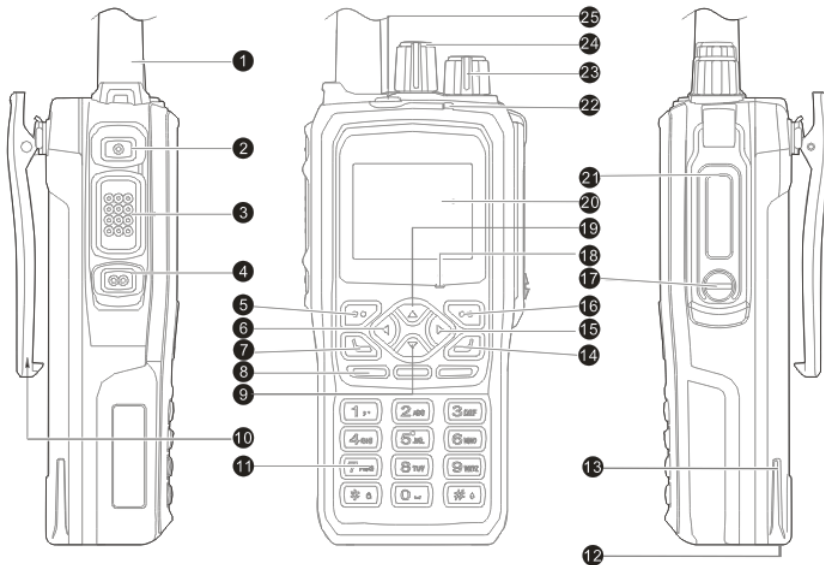

No.	Part Name	No.	Part Name	No.	Part Name
1	Antenna	10	Belt Clip	19	Up Key
2	Side Key 1	11	Digital Key	20	LCD Display Screen
3	PTT Key	12	Battery Latch	21	Comm Port
4	Side Key 2	13	Battery	22	LED Indicator
5	Menu/OK Key	14	Hang-up /Menu Key	23	Power/Volume Knob
6	Left Key	15	Right Key	24	Channel Selector Knob
7	Dial Key	16	Return Key	25	Top Key
8	Speaker	17	Cover Screw	-	-
9	Down Key	18	Microphone	-	-

4 Basic Operation

4.1 Powering on/off

To power on the radio, turn the power/volume knob clockwise until a click is heard; the LCD screen displays the power-on image and the backlight is on automatically; an alert tone and a slight vibrating hint (created by motor) will sound and shake at the same time .

To power off the radio, turn the power/volume knob counter-clockwise until a click is heard



4.2 Adjusting the Volume

When the radio is on, turn the power/volume knob to adjust the volume. Turn it clockwise to increase the volume and counter-clockwise to decrease

After turning the power/volume knob counter-clockwise to the minimum volume, and keep turning it until a click is heard.

4.3 Selecting the Zone

Zone is a group of channels. You can put channels of the same kind into a zone and you can quickly switch to different channel group in different working environment. It supports a maximum of 248 zones, and each supports a maximum of 128 channels.

- 1) Press  to enter the manual.
- 2) Select and enter  zone menu.
- 3) Press **【Up】** / **【Down】** key to select the target zone.

- 4) Press **【OK】** key to switch to the selected zone.

4.4 Selecting the Channel

Turn the channel selector knob to select channel

Each channel can be configured as analogue or digital. Turn the channel selector knob to switch between digital and analogue channel.

When the channel is switched from digital to analogue, certain features are no longer available such as short message and etc.

4.5 PTT Key



The PTT key has two basic applications below:



- 1) The PTT key can transmit signals to other radios when the radio is calling
- 2) The PTT key can initiate a new call when the radio is not calling.

Note:









- ◆ Press PTT key to talk during a call
- ◆ Release PTT key to receive and wait for calls.
- ◆ When other radio is calling, you cannot press PTT key to transmit.















4.6 Menu Operation

- 5) Press  to visit menu.
- 6) Press  to select menu item.

- 7) Press  to enter the menu item
- 8) Press  to return to the last menu or the main interface.
- 9) Press  to return to the main interface.

4.7 Icon

	Signal strength More bars indicate stronger signal and less bars weak signal. It only show up when receiving.
	Battery indicator Less space indicates more battery power. When the battery is low, the icon will turn red
	High power
	Low power
	Mute
	Unread message
	Full mailbox
	Keypad lock

	Emergency
	Encryption
	Man Down
	Talkaround
	GPS is receiving
	GPS positioned
	Icon whirling indicates it is scanning
	The scan stays on priority channel 1
	The scan stays on priority channel 2
IDType:	
	Private call
	Group call
	All call
Menu Selection:	
	Selected
	Not selected

4.8 LED Indication

Red Indicator glows: the radio is transmitting.

Green Indicator glows: the radio is receiving signals (speech message, text message and data) or it detected activity on the channel.

Orange indicator glows: orange indicator glows during the call hang time in digital mode or auto reset time in analog mode.

Orange indicator flashes: the radio is in emergency state or is receiving emergency alarm; missed call alert; the radio is scanning; the radio is roaming.

Red indicator flashes: the radio is in low power.

5 Initiating/Receiving a Call

5.1 Initiating a call to the default contact

If default contact is preset on the current channel, you can press the PTT key direct to initiate a call to the default contact

You can preset a default contact on each digital channel via dealer





5.2 Selecting the Contact and Initiating a Call

Enter the “contact” menu and select a contact in the contact list; press the PTT key to talk

5.3 Dialing Manually and Initiating a Call

Enter the contact menu and select “manual dial” to enter the call ID before pressing PTT key to initiate a call.

5.4 Receiving/Responding to a Call

- 1) LED indicator glows.
- 2) LCD displays icon of call type ( private call,  group call,  all call), alias or ID and incoming icon .
- 3) Broadcasts received call.
- 4) You can press the PTT key during the call hang time to call the current contact.



Note:

For receiving call from group, the radio must be a member of the group (set by dealer with programming software).

6 Short Message

The radio can receive/transmit short message and the message supports a maximum of 300 characters

6.1 Edit and send short message

- 1) Press  to enter menu.
- 2) Select and enter " short message" menu.
- 3) Select "New Message" and enter the editing interface.
- 4) In the editing interface, you can:
 - a) The cursor indicates the current editing position.

- b) Enter text contents through keypad.
 - c) Press  to move the cursor to the right/left.
 - d) Press **【#】** key to switch typewriting and **【*】** key to switch to lower/upper case.
 - e) In the non-digital input mode, press **【1】** key to enter punctuation.
 - f) Press the delete key to delete the character right before the cursor.
- 5) Press OK key after the message is edited and send, save or delete the message.
 - 6) Select “send” and enter the “contact” interface.
 - 7) Select contact list and enter the list.
 - 8) Select the target contact and press OK key to send message; or you can select manual dial in the contact interface and enter the target number and press OK key to send the edited message.
 - 9) After the message is sent, “Message Sent” indication will show on the LCD screen and the radio will return to the short message interface.
- If the message failed to deliver, “Message Failed” will show on the LCD screen and the radio returns to the short message interface.

The sent message is saved in the sent mailbox.

6.2 Sending Quick Message

The radio supports a maximum of 10 quick messages (message is edited by dealer through programming software)

You can edit the pre-defined quick message before sending it.

- 1) In the home screen, press  and enter the menu.
- 2) Select and enter  short message” menu.

- 3) Select “template” and enter quick message list.
- 4) Select the target quick message in the list and press OK key to enter the editing interface.

You can edit the quick message.

- 1) Press OK key to send, save or delete the edited message.
- 2) Select “Send” and enter the “Contact” interface.
- 3) Select the contact list and press OK key to enter.
- 4) Select the target contact and press OK key to send the edited message. Or you can select “Manual Dial” in the “Contact” interface and enter the target contact number before pressing OK key to send it.
- 5) When the quick message is successfully sent, “Message Sent” will show on the LCD screen and then it returns to the message list interface.



If the message failed to deliver, “Message Failed” will show on the LCD and then it returns to the message list interface.。

The sent message will be saved in the outbox.。

6.3 Sending Status Message

If the radio supports status message feature, you can receive and transmit status code which is agreed on with other radios.

The radio supports a maximum of 1024 status messages (programmed by dealer).

- 1) Press  to enter the menu in the home screen.
- 2) Select and enter  short message” menu.

- 3) Select “Status Message” and enter status message list.
- 4) Select the target status message and press OK key to enter the interface of status message.
- 5) Press “Send” key and enter the “Contact” interface.
- 6) Select “Contact List” and press OK key to enter the contact list interface.
- 7) Select the target contact and press OK key to send the selected status message.

Or you can select “Manual Dial” in the “Contact” interface and enter the target contact number before pressing OK key to send the message.

- 8) After the status message is sent, “Message Sent” will show on the LCD screen and then it returns to the message list interface.



If the status message failed to deliver, “Message Failed” will show on the LCD screen and then it returns to the interface of status message.

The sent status message is saved in outbox.

6.4 Receiving Short Message

When the radio receives a message, the LCD will remind you of the new message and display the icon of unread message  on the status bar.



You can enter inbox and read message.

- 1) Press  to enter the menu in the home screen.
- 2) Select and enter “ short message” menu.
- 3) Select “inbox” and enter.
- 4) Select an unread message and press OK key to read the message.

6.5 Deleting Short Message

You can delete the message that is sent, received or saved.

6.5.1 Deleting the Message by Batch

- 1) Press  to enter the menu.
- 2) Select and enter "  short message" menu.
- 3) Select "Delete Message" and enter the interface.
- 4) Select the mailbox of the message to be deleted (inbox, outbox or draft box) and press OK key to delete the message in the box.

Or you can select "Delete All" to delete all the messages.

6.5.2 Deleting the Message Individually

- 1) Select the target message in one box (inbox, outbox or draft box) and delete.
- 2) Press the option key to check details and to save or delete the target message.
- 3) Select "Delete".
- 4) Press OK key to delete.

7 Emergency

During emergency, you can send a confirmed emergency alarm and an emergency voice message to the specified radio group. You can initiate an emergency alarm anytime even when it is receiving signals.

The radio supports three kinds of emergency alarm mode.

- ◆ Emergency Alarm
- ◆ Emergency Alarm and Emergency Call
- ◆ Emergency Alarm and Auto Background Tone



There are alarm types below:

- 1) Siren Only—— after the radio enters the emergency state, the siren only sounds locally and the control center will not receive any alarm signal.
- 2) Conventional—— the radio sends emergency alarm and audio/visual alert.
- 3) Secret —— the radio sends emergency alarm but no audio/visual alert; the speaker will not turn on when receiving speech signal until the PTT button is pressed to talk.
- 4) Secret with Voice—— the radio sends emergency alarm and it receives call but no audio/visual alert until the PTT button is pressed.

In addition, when the alarm type is set as “Siren Only” and after the radio enters the emergency state, the siren will only sound locally and the control center will not receive any alarm signal.

7.1 Sending Emergency Alarm

- 1) Press the programmable button which is programmed as “Emergency” and enter the emergency state; the icon ▲ will show in the status bar; the LCD displays the emergency group call alias or ID. Emergency

icon is  and the outgoing call icon is .

2) When the radio receives response, the LCD will show “Emergency Alarm Succeeded”.

If the radio failed to receive response and when the retry count is used up, the LCD will show “Emergency Alarm Failed”.

3) The radio exits the emergency mode and returns to the home screen.

Note:

◆ If your radio is set as “Secret” or “Secret with Voice”, there will be no audio/visual alert.

◆ After the emergency alarm with voice responded, the two parties can communicate on the emergency channel.

◆ The emergency with voice will then open the radio mic, which allows user to talk without having to press PTT button. The automatic mic activation is called Hot Mic (set by dealer with programming software).

7.2 Receiving Emergency Alarm

If the radio enabled “Emergency Indication” feature, it can receive emergency alarm. Otherwise, the emergency alarm will be ignored (set by dealer through programming software) .

For receiving emergency alarm, the radio must be set as a group member(set by dealer through programming software) .

1) When the radio receives emergency alarm, the LCD status bar will show the emergency icon .

2) The LCD displays the alias or ID of the emergency radio. The radio periodically sounds the alarm alert and the red LED flashes quickly. Press any key to cancel the emergency alarm..

7.3 Exiting Emergency Alarm



The radio will exit the alarm mode under the circumstances listed below:

- ◆ Receives emergency alarm response on Emergency alarm mode.
- ◆ The emergency alarm retry count is used up and no response is received.
- ◆ Press and hold the programmable button programmed as “Emergency Exit”

8 Call Log

Through the call log, you can check and manage recent outgoing call, incoming calls and missed calls on the radio. The call log records private call only.

8.1 Checking Latest Call

- 1) Press  in the home screen to enter the menu.
- 2) Select and enter  call log” menu.
- 3) Select the call log (missed calls, outgoing calls and incoming calls) and enter the interface.
- 4) Select and enter the call list (missed calls, outgoing calls and incoming calls) .
- 5) Select the target call log. Press OK key to check, save or delete the target record.
- 6) Select “Details” and press OK key to check the record details.
- 7) Press PTT key to call the contact on the record.



8.2 Saving ID in the Contact List

- 1) Select the target record in the call list.

- 2) Select the target record which needs to be saved and you can press OK key to check, save or delete the target record.
- 3) Select "Save" and enter the interface for adding contact.
- 4) Enter the contact name.
- 5) Press Ok key to save the contact..

8.3 Deleting Call from the Call List

8.3.1 Deleting all the Records from the List.

- 1) Press  in the home screen to enter the menu.
- 2) Select and enter  call log" menu.
- 3) Select the call log (missed calls, outgoing calls and incoming calls) and enter the interface.
- 4) Select "Delete All".
- 5) Press Ok key to delete all the records in the list.



8.3.2 Deleting Individual Record

- 1) Select the target record in the call list.
- 2) Press OK key to check, save or delete the target record.
- 3) Select "Delete".
- 4) Press OK key to delete the record.

9 General Setting

9.1 Language Selection



You can switch the radio languages.

- 1) Press  in the home screen to enter the menu.
- 2) Select and enter  "setting" menu.
- 3) Select "Language Selection" and enter the interface.
- 4) Select the language and press OK key for switching to the language.

9.2 Alert Tone Setting

You can enable/disable the alert tone and adjusts the volume.

9.2.1 Enable/disable the Alert Tone

- 1) Press  in the home screen to enter the menu.
- 2) Select and enter  "setting" menu.

Select "Alert Tone Setting" and enter the interface for alert tone setting:

"All Alert Tone Off" – disables all the alert tones.

"All Alert Tone On" –enables all the alert tones.

"Outgoing Alert Tone" – enables/disables the outgoing alert tone.

"Private Call Alert Tone" – enables/disables the alert tone of receiving private call.

"Group Call Alert Tone" – enables/disables the alert tone of receiving group call

"Key Alert Tone" – enables/disables the key alert tone.

“Information Alert Tone” – enables/disables the alert tone of receiving short message.

“Finished Call Alert Tone” – enables/disables the alert tone of finished call.



Press OK key and the LCD will show “Operation Succeeded” and save the alert tone.

9.2.2 Adjusting the Volume of Alert Tone

- 1) In the alert tone setting interface, select and enter the “Alert Tone Volume” interface.
- 2) Press **【Up】** key or **【Left】** key to increase the alert tone volume. Press **【Down】** key or **【Right】** key to decrease the volume.
- 3) Press OK key and the LCD shows “Operation Succeeded” . The alert tone volume will be saved.

9.3 Vibration Setting

You can enable/disable the vibration feature.

- 1) Press  in the home screen to enter the menu.
- 2) Select and enter  setting” menu.
- 3) Select “Vibration Setting” and enter the interface.

You can enable/disable the vibration alerts below:

“All Vibration Off” –disable vibration of all types.

“All Vibration On” – enable vibration of all types.

“Call Alert” – enables/disables the vibration call alert.

“Incoming Call” – enables/disables the vibration alert of private call.



“Short Message” – enables/disables the vibration alert of receiving short message.

“Emergency Alarm”- enables/disables the emergency vibration alert.

4) Press OK key and the LCD will show “Operation Succeeded”. The vibration alert will be saved.

9.4 Power Level Setting



You can set high/low power for each channel.

- 1) Press  in the home screen to enter the menu.
- 2) Select and enter “ setting” menu.
- 3) Select “Power Setting” and enter the interface.
- 4) Select “High” or “Low” power and set the power level.
- 5) Press OK key and the LCD will show “Operation Succeeded”. The power level will be saved.

9.5 Keypad Lock Setting

You can lock the radio keypad in case of incorrect operation.

9.5.1 Manually Locking the Keypad

- 1) Press  in the home screen to enter the menu.
- 2) Select and enter “ setting” menu.
- 3) Select “keypad lock setting” and enter the interface.
- 4) Select “Locking Keypad”.
- 5) Press OK key and the LCD will show “Operation Succeeded” . The keypad is locked.

9.5.2 Automatically Locking the Keypad

- 1) In the keypad lock interface, select and enter the interface of “Auto Lock”.
- 2) Select the delay time of auto keypad lock.

- 3) Press OK key and the LCD will show “Operation Succeeded”. The auto lock time is saved. During the set time, the keypad will be locked automatically if no operation is performed on it.

9.5.3 Locking the Keypad Quickly



Press **【*】** key in any interface to lock the keypad.

9.5.4 Unlocking the Keypad

When the keypad is locked, press  and then **【*】** key to unlock the keypad.



9.6 Screen Brightness Setting

You can adjust the brightness of the screen based on different situation.

- 1) Press  in the home screen to enter the menu.
- 2) Select and enter  “setting” menu.
- 4) Select “Brightness” and enter the interface.
- 5) Press **【Up】** key or **【Left】** key to increase the brightness; press **【Down】** key or **【Right】** key to decrease the brightness.
- 6) Press OK key and the LCD will show “Operation Succeeded”. The brightness setting will be saved.

9.7 Screen Backlight Setting

You can set the backlight duration of the screen based on different situation to save battery power.



- 1) Press  in the home screen to enter the menu.
- 2) Select and enter  “setting” menu
- 3) Select “Backlight” and enter the interface..

- 4) Select the backlight duration for the screen.
- 5) Press OK key and the LCD will show "Operation Succeeded". The time setting for turning off the screen will be saved.

During the set time, the radio will turn off the screen if no operation is performed. Press any key to restore the brightness.



9.8 Indicator Setting

You can turn on/off the LED indicator based on different situation.

- 1) Press  in the home screen to enter the menu.
- 2) Select and enter " setting" menu.
- 3) Select "LED indication" and enter the interface.
- 4) Select "On" or "Off" and turn on/off the indicator.
- 5) Press OK key and the LCD will show "Operation Succeeded". The LED indication setting is saved.

9.9 Talk Around/Repeater Setting



You can switch the work mode based on different situation (talk around or repeater mode).

- 1) Press  in the home screen to enter the menu.
- 2) Enter the " setting" interface.
- 3) Select "Talk Around/ Repeater" and enter the interface.
- 4) Select "Talk Around/ Repeater" and switch work mode.
- 5) Press OK key and the LCD will show "Operation Succeeded". The work mode will be saved.

9.10 Squelch Level Setting



You can adjust the squelch level based on different situation to remove unnecessary calls in weak signals.

This setting is valid on analogue channel.

- 1) Press  in the home screen to enter the menu.
- 2) Select and enter  setting” menu.
- 3) Select “Squelch Level” and enter.
- 4) Press **【Up】** key or **【Left】** key to increase the squelch level and **【Down】** key or **【Right】** key to decrease the squelch level.
- 5) Press OK key to save the squelch level and return to the setting interface.

9.11 Checking Radio Information



You can check information such as radio ID, serial number, firmware version, hardware version and vocoder.

- 1) Press  in the home screen to enter the menu.
- 2) Press and enter  setting” menu.
- 3) Select and enter the “Radio Information” interface

10 Advanced Features

10.1 Radio Check

Radio Check feature is used to check whether the target radio is activated in the system. The target user will automatically send a response to the caller radio without any audible or visual indication.

- 1) Press  in the home screen to enter the menu.
- 2) Select and enter  "contact" menu.

Or you can press  in the home screen to directly enter the "Contact" menu.

- 3) Select and enter the "Contact List" interface. Select the target private call contact for radio check.
- 4) Press OK key and enter the "Contact" interface.
- 5) Select "Radio Check" and confirm.

The screen will show the alias or ID of the target private call contact and indicates that the radio is sending radio check; the red indicator glows.

- 6) Waiting for response from the target radio

If the target radio is activated in the system and it succeeded to respond, the radio will show "Radio Available".

Note:

- ◆ If you press  during radio check, the radio will exit the radio check process.
- ◆ If the retry count is used up and no response is received, the radio will exit the radio check and show "Radio Unavailable"

10.2 Call Alert

Call Alert feature allows the caller radio to request the target radio to call back.

10.2.1 Receiving and Responding to Call Alert

1) When the radio received call alert, it will automatically reply if call alert decode is enabled.

The LCD shows “Call Alert...”, the alias or ID of caller radio.

The radio periodically sounds alert tone and orange LED is flashing.

2) Press **【PTT】** key to respond to the caller radio or any other key to ignore the call alert.

10.2.2 Initiating Call Alert

1) Press  in the home screen to enter the menu.

2) Select and enter “ contact ” menu.

Or you can press  in the home screen and directly enter “Contact” Menu.

3) Select and enter “Contact List” interface. Select the target private call contact.

4) Press OK key and enter the “Contact” interface.

5) Select “Call Alert” and confirm.

The LCD screen displays the alias or ID of the target radio and indicates that the radio is sending call alert; the red LED glows.

6) Waiting for response from the target radio.

If the target radio succeeded to respond, the caller radio show “Call Alert Succeeded” on the screen, or it shows “Call Alert Failed”.

Note:

- ◆ If you press  when sending “call alert”, the radio will exit the call alert mode.
- ◆ If the retry count is used up and no response is received, the radio will automatically stop sending call alert and display “Call Alert Failed” on the screen.

10.3 Radio Stun/Un-stun

Stun/Un-stun feature allows the radio to stun/un-stun the target radio through air signaling. The stunned radio cannot transmit nor receive and it can only be activated by un-stun signaling of the authorized radio. This feature is used to prevent from being used without authorization or used by others when lost.

10.3.1 Receiving Stun/Un-stun Signaling



After the target radio receives the stun/un-stun signaling and succeeded to be stunned / un-stunned, it will automatically send operation success indication to the caller radio.

The radio which is stunned can only display channel alias and group alias when it returns to the home screen without the ability to receive all the other information except the un-stun signaling. All the operation on the radio is valid except powering on/off.

After the target radio receives the un-stun signaling and succeeded to be un-stunned, it will automatically send operation success indication to the caller radio.

The activated radio will go back to normal from being stunned.

10.3.2 Sending Stun and Un-stun Signaling

- 1) Press  in the home screen to enter the menu.
- 2) Select and enter  “management feature” menu.

- 3) Select “Stun/Un-stunned”.
- 4) Enter “Contact List” and select the target private call contact.

The screen shows the alias or ID of the target radio and the radio indicates that it is sending stun/un-stun signaling. The red indicator glows.

- 5) Waiting for response from the target radio.

If the response from the target radio is received, the screen will show “Stun Succeeded”/“Un-stun Succeeded”, or it shows “Stun Failed”/“Un-stun Failed”.

Note:

- ◆ If you press  in the process of sending signaling, the radio will stop sending stun/un-stun signaling.
- ◆ If the retry count is used up and no response is received, the radio will automatically stop sending signaling and indicate that the transmission failed.

10.4 Radio Kill

Kill feature allows the user to kill the target radio through air signaling. After the target radio is killed, the key configuration data will be cleared and the radio is powered off automatically. You cannot operate the radio after powering it on.

The killed radio can only be revived by the authorized dealer or supplier.



This feature is used to prevent the lost radio from being used and the key configuration data from being stolen.

Note:

- ◆ Once the radio is killed, the configuration data will be lost and the radio cannot go back to normal after reboot, so please operate with due care!
- ◆ The killed radio can only be revived by authorized dealer or supplier.

10.5 Remote Monitor

Remote Monitor allows the user to turn on the microphone of the target radio through air signaling. There will be no audible or visual indication on the target radio. You can use this feature to monitor the surroundings of the target radio.

- 1) Press  in the home screen to enter the menu.
- 2) Select and enter  "management" menu.
- 3) Select "Remote Monitor".
- 4) Enter "Contact List" and select the target private contact.

The screen displays the alias or ID of the target radio and indicates that the radio is sending remote control signaling. The red indicator glows.

- 5) Waiting for response from the target radio.

If the response from the target radio is received, the screen shows "Remote Control Succeeded", or it shows "Remote Control Failed".

Note:





- ◆ If you press  when the radio is sending remote monitor signaling, it will stop and exit the remote monitor mode.
- ◆ If the retry count is used up and no response is received, the radio automatically exits the mode and shows "Remote Control Failed".

10.6 Scan

In order to receive voice and data from multiple channels, the radio can be programmed to scan these channels. The radio supports up to a maximum of 128 scan lists and each scan list supports a maximum of 16 channels. Mixed scan of analogue and digital channels are available. You can relate different channel to different scan list.

By editing the scan list, you can add or delete the channels on the scan list and set priority channel.



10.6.1 Checking the Scan List

- 1) Press  in the home screen to enter the menu.
- 2) Select and enter " Scan" menu.
- 3) Select "Checking Scan List" to check the members on the list ( represents priority channel 1;  represents priority channel 2;  represents conventional channel).

Note:

If priority channel is set, the priority icon will be displayed on the right of the member alias, indicating that the member is on priority channel 1/priority channel 2. It can't be multiple priority channel 1 or priority channel 2 on the same scan list. If there is no priority channel, the icon indication will not exist.

10.6.2 Editing the Scan List

- 1) Press  in the home screen to enter the menu.
- 2) Select and enter " Scan" menu.
- 3) Select "Editing Scan List".



You can operate as below on the scan list:

Add: add the target channel to the scan list.

Delete: delete the target channel from the scan list.

Editing Priority: set the channel priority on the scan list.

10.6.3 Enabling/disabling Scan

- 1) Press  in the home screen to enter the menu.
- 2) Select and enter " Scan" menu.
- 3) Select "Scan Switch".
- 4) Select to enable/disable scan

Note:

During the scan, the radio receives data (short message, GPS, telemetry or PC data) and digital signaling only on the selected channel.



10.6.4 Responding during Scan

During the scan, when the radio detected a channel with activity, it will stay on this channel for certain time, and the time is called the scan hang time (programmed by dealer through programming software).

- 1) Keep your mouth 1-2 inches from the microphone.
- 2) Press PTT button during the scan hang time and the red indicator glows.

- 3) Wait for the alert tone of transmission permission to end and speak to the microphone.
- 4) Release PTT key to receive.
- 5) If you did not respond during the scan hang time, the radio will go on to scan other channels.

10.7 Man Down



- 1) Press  in the home screen to enter the menu.
- 2) Select and enter  "Application" menu.
- 3) Select "Man Down" and enter the interface.
- 4) Select "On" or "Off" to enable/disable Man Down.

10.8 VOX

If VOX is enabled on the radio, you can directly speak to the microphone and transmit without having to press PTT button.

You can enable/disable VOX through the menu and adjust the microphone sensitivity.

10.8.1 Enabling/Disabling VOX

- 1) Press  in the home screen to enter the menu.
- 2) Select and enter  "Application" menu.
- 3) Select "VOX" and enter "VOX" interface.
- 4) Select and enter the "VOX Switch" interface.
- 5) Select "On" or "Off" to enable/disable VOX.

10.8.2 Adjusting VOX Level



- 1) Press  in the home screen to enter the menu.

- 2) Select and enter “ Application” menu.
- 3) Select “VOX” and enter “VOX” interface.
- 4) Select and enter “VOX Level” interface.
- 5) Press **【Up】** key or **【Left】** key to increase VOX level or **【Down】** key or **【Right】** key to decrease VOX level.
- 6) Press OK key and save the VOX level and return to the VOX setting interface.



10.9 GPS

If GPS is enabled, the radio will display the location information and offer location information to the software server (set by dealer through programming software).

10.9.1 Checking the Current Location



- 1) Press  in the home screen to enter the menu.
- 2) Select and enter “ Application” menu.
- 3) Select “GPS” and enter “GPS” interface.
- 4) Select and enter “GPS interface” interface to check information such as date, time, longitude, latitude, and satellite number.

10.9.2 Enabling/disabling GPS



- 1) Press  in the home screen to enter the menu.
- 2) Select and enter “ Application” menu.
- 3) Select “GPS” and enter the interface.

- 4) Select and enter “GPS Switch” interface.
- 5) Select “On” or “Off” to enable/disable GPS.



10.9.3 Enabling/disabling GPS

- 1) Press  in the home screen and enter the menu.
- 2) Select and enter “ Application” menu.
- 3) Select “GPS” and enter “GPS” interface.
- 4) Select and enter “GPS Report On/Off” interface.
- 5) Select “On” or “Off” to enable the GPS Report feature.



10.10 Time

- 1) Press  in the home screen to enter the menu.
- 2) Select and enter “ Application” menu.
- 3) Select “Time” to set the display status and format of time and date.

10.11 Network

- 1) Press  in the home screen and enter the menu.
- 2) Select and enter “ Application” menu.
- 3) Select “Network” and check the transmitting and receiving frequency on the current channel.

10.12 Bluetooth

- 1) Press  in the home screen and enter the menu.
- 2) Select and enter " Bluetooth" menu.
- 3) Select "Bluetooth Switch" and enter the interface.
- 4) Select "Enable Bluetooth" or "Disable Bluetooth" to enable/disable Bluetooth.
- 5) After the bluetooth is enabled, go back to the Bluetooth menu and select "Device Available".
- 6) Select "Search Device" to search for device that matches.
- 7) Select "Connect".

11 Troubleshooting

No.	Troubleshooting	Causes and Solutions
1	Failed to power on	<p>A. Check if the battery is used up –charge the battery or change it if the power is out.</p> <p>B. Check if the power connecting pole is in proper contact with battery –try again after re-attachment.</p> <p>C. Check if the battery contact is contaminated or in poor contact –clean the contact.</p>
2	Communication failed	<p>A. Inconsistent frequency between radios – select a channel with the same frequency.</p> <p>B. Different CTCSS/CDCSS signaling –re-set with PC.</p> <p>C. Beyond communication scope.</p>

3	Failed to receive signals	<p>A. Poor antenna contact – fix the antenna.</p> <p>B. Wrong RX/TX frequency – select the same TX/RX frequency.</p> <p>C. Beyond communication scope.</p>
4	The green indicator glows but no sound is received	<p>A. Check if the volume is at its lowest level – increase volume.</p> <p>B. Check if the speaker is broken - change the speaker.</p>
5	GPS failed to locate	<p>A. Check if the antenna is dual mode - change to a dual-mode antenna.</p> <p>B. Check if GPS is properly set – reset GPS.</p> <p>C. The radio is placed in a blocked environment - place it in an open location.</p>
6	Abnormal programming	<p>A. Improper connection – check cable connection.</p> <p>B. PC USB driver is not installed - install the driver.</p> <p>C. The earpiece interface is in poor contact - change the interface.</p>

12 Major Technical Specification

General Specification	
Frequency Range	UHF: 400-470MHz,
Channel Capacity	1024
Channel Spacing	12.5kHz/20kHz/25kHz
Weight	386 g (with battery and antenna)
Size (height*width*thickness)	135.8mm*63.5mm*39.1mm
Display	1.8 inches 65535 kind of color display
Battery Capacity	7.4V 2000mAH lithium-ion battery
Working Hour (5-5-90)	Analogue: 12 hours Digital: 16 hours.

Work Environment	
Work Temperature	-30°C ~ +60°C
Storage Temperature	-40°C ~ +85°C
IP Rating	IP67
Electrostatic Protection	±4kV (in contact) / ±8kV (air)
Military Standard	MIL-STD-810 C/D/E/F/G
Damp proof	MIL-STD-810 C/D/E/F/G
Shock and Vibration	MIL-STD-810 C/D/E/F/G

RX	
Frequency Stability	±1.5ppm
Analogue RX Sensitivity	0.3uV (12dB SNR) /0.22uV (12Db SNR, typical)
Digital RX Sensitivity	0.3uV (5% bit error rate)
Inter-modulation	ETSI: 65dB TIA603: 70dB
Adjacent Channel Selectivity	ETSI/TIA603: 60dB@12.5kHz, 70dB@20/25kHz
Spurious Response Suppression	ETSI/TIA603: 70dB
Conduction Spurious Radiation	-57dBm
Block	ETSI: 84dB TIA603: 80dB
Rated Audio Power	0.5W
Rated Audio Distortion	<3% (typical)
Voice and Noise	-40dB@12.5kHz/-43dB@20kHz/-45dB@25kHz
Audio Response	+1dB ~ -3dB

TX	
Frequency Stability	±2.5ppm
TX Power	Low: 1W; High: 4W
Voice and Noise	-40dB@12.5kHz
Conduction Radiation	Spurious -36dBm@<1GHz, -30dBm@>1GHz
Adjacent Channel Power	60dB@12.5kHz
FM Modulation	9K84F3E@12.5kHz
4FSK Modulation	12.5kHz (data only) : 7K24FXD 12.5kHz (data + voice) : 7K24FXW
Modulation Limit	±2.5kHz@12.5kHz,
Audio Response	+1dB~-3dB
Audio Distortion	3% (Typical)
Vocoder	AMBE++
Digital Protocol	ETSI TS 102 361-1, -2, -3

GPS	
TTFF (cold start) initial positioning time	<1 min
TFF (hot start) initial positioning time	<10 seconds

13 FCC STATEMENT

This device complies with Part 15 of the FCC Rules. Operation is subject to the following two conditions:

- (1) This device may not cause harmful interference, and
- (2) this device must accept any interference received, including interference that may cause undesired operation.

NOTE 1: This equipment has been tested and found to comply with the limits for a Class B digital device, pursuant to part 15 of the FCC Rules. These limits are designed to provide reasonable protection against harmful interference in a residential installation.

This equipment generates, uses and can radiate radio frequency energy and, if not installed and used in accordance with the instructions, may cause harmful interference to radio communications. However, there is no guarantee that interference will not occur in a particular installation. If this equipment does cause harmful interference to radio or television reception, which can be determined by turning the equipment off and on, the user is encouraged to try to correct the interference by one or more of the following measures:

- Reorient or relocate the receiving antenna.
- Increase the separation between the equipment and receiver.
- Connect the equipment into an outlet on a circuit different from that to which the receiver is connected.

-Consult the dealer or an experienced radio/TV technician for help.

NOTE 2: Any changes or modifications to this unit not expressly approved by the party responsible for compliance could void the user's authority to operate the equipment.

Output power listed is rated conducted. This device must be restricted to work-related operations only in an Occupational/Controlled RF exposure environment and must operate with a duty factor not exceeding 50%. This transmitter may operate with the antenna(s) documented in this filing in Push-to-Talk and body-worn configurations.

RF exposure compliance is limited to the specific belt-clip and accessory configurations as documented in this filing and the separation distance between user and the device or its antenna shall be at least 2.5 cm. All qualified end-users of this device must have the knowledge to control their exposure conditions and/or duration to comply with occupational/controlled Exposure limit and requirements. The highest reported SAR values for Face-held, body-worn and simultaneous transmission conditions are 2.77 W/Kg, 3.70 W/Kg and 3.74W/Kg respectively.

This device contains Bluetooth and Two Way Radio transmitters.