



Professional wireless communication system solution supplier

## **Quick User Manual**

### **DSJ-H9**

**Body Worn Camera**

**Video Recorder / Camera / Microphone**

**Instruction Manual**  
**DSJ-H9**  
**Body Worn Camera**

Dear Customers,

We are very grateful for your purchasing our body worn camera We believe the product can bring great convenience to your work.

Our product applies advanced technology and sophisticated techniques. We believe the quality and features can be satisfying to you.

## Notice

- ◆ Please carefully read the user manual before using the product for your easy operation. We will consider that you have read this manual when you use body worn camera.
- ◆ Please properly keep this manual for your future reference or for other users'.
- ◆ To prevent your legal rights from infringement, please carefully fill in the warranty card at your purchase and claim valid receipt.
- ◆ Relevant intellectual property rights of all parts including accessories of our body worn camera belongs to us or its authorized parties. Any design or materials must not be copied, imitated, extracted or translated without our authorization or our authorized parties.
- ◆ Due to the update or modification of the product, we owns the right to change the specifications of software and hardware described in this manual without further notice. Specifications and information contained in this manual are for reference only.
- ◆ All the words are carefully proofread but mistake may be inevitable. We reserves the right to final interpretation.

### **Safety Precaution**

To prevent damaging the body worn camera and prevent injury to others or yourself, please carefully read the notice below before using the product and put these safety instructions within reach of others or yourself.

- ◆ Please do not try to disassemble or modify the product.
- ◆ Please do not use the product in the flammable or explosive atmosphere.
- ◆ Please do not place the product anywhere near the heating device or at the place of extremely abundant dust, damp or water splash. Pay attention to the notice below when charging with power adaptor:
  - ◆ Please use the power adaptor offered or sold by us .
  - ◆ Please keep the metal part of the power adaptor plug dry and clean. Failure to comply may lead to fire or electric shock.
  - ◆ Please do not use power adaptor in thunderstorm. Failure to comply may lead to electric shock.
  - ◆ Please do not try to damage, modify and repair the power adaptor, nor heat the radio or place it anywhere near open fire.
  - ◆ Please use the USB cable offered or sold by us
  - ◆ Non-technician must not try to repair the product or its accessories.

## Content

1. Unpacking and Checking .....	5
1.1 Supplied Accessories.....	5
1.2 Optional Accessories .....	6
2. DSJ-H9 Device .....	7
3. Basic Operation .....	9
4. Trouble Shooting .....	17
5. Maintenance and Cleaning .....	18

# 1. Unpacking and Checking

Please carefully open the package and check if the items listed below are included. Please contact your local dealer for anything lost or damaged.

## 1.1 Supplied Accessories

Material	Quantity
Body worn camera	1
Power Adaptor	1
USB Cable	1
Shoulder Strap	1
User Manual	1
CD	1

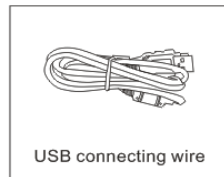
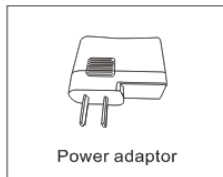
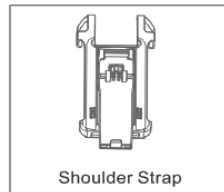

## 1.2 Optional Accessories

Material	Quantity
Vehicle-mounted Charger	1
Mobile Power bank of Big Capacity	1
External Camera	1
Vehicle-mounted Fixed Base	1
Vehicle-mounted Fixed Bracket	1
Charger	1

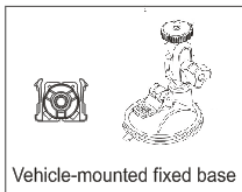
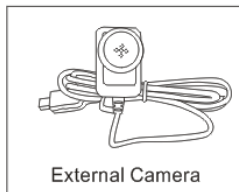
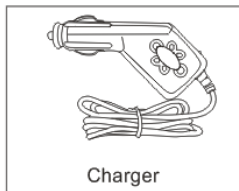

## 2. DSJ-H9 Device

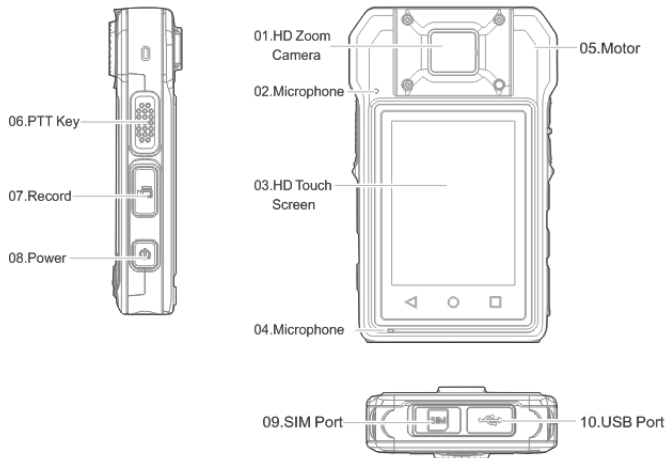



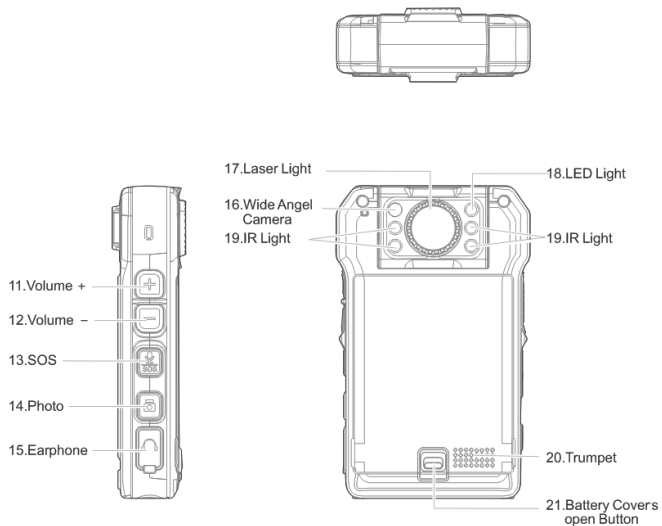



## 3. Basic Operation

### 3.1 POWER ON/OFF Key

Press and hold the power-on button  when the BWC is off. The body worn camera enters pre-view mode after being powered-on, and the green indicator keeps glowing.

On pre-view mode, press and hold  for 2 seconds and the picture shown on the right appears, which indicates the body worn camera is being powered-off. After confirm it, it will be off.

**Attention:** The device have 2 sets multiple user management.

**Normal user** Password: 123456 by default, can be modified by DSJ-H9 PC software, max. 5 user ID(YH1,YH2,YH3,YH4,YH5). Different user will have different password for using.

**Administrator:** no ID. Password: 456789 by default,, also can be reset by DSJ-H9 PC software. By software, Admin can reset BWC time, passwords, department name, user name, device no. , loop video, GPS on/off, and copy data, etc.

### 3.2 TOUCH Application

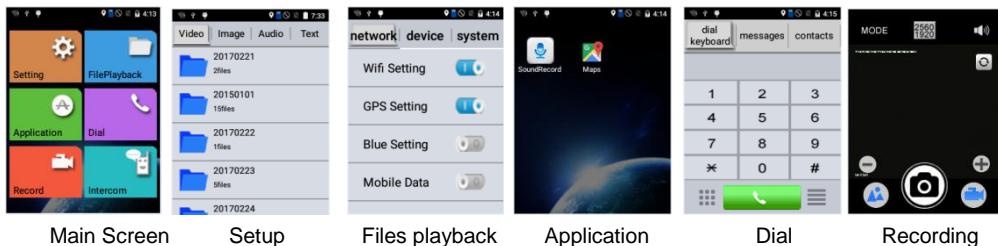

### 3.3 Working Indication

The green LED indicator glows after the BWC's power is on; The red LED indicator flashes when recording.



### 3.4 Charging Indication



The red indicator glows when charging and the green indicator glows when the battery is full.

### 3.5 PTT Button (Optional Function)

After you register on BWC's intelligence dispatch software, press PPT or "+" to realize public network talking. (This feature is optional and can be customized according to requirements).

### 3.6 Recording Button.

On video pre-view mode, press  to start recording , the red indicator light keeps flashing during recording(Long pressing will mark important video); press  again to stop recording and save the video file;

On power-off status, press and hold  to enter one-touch video mode; press  again to stop recording and save the file.

On preview recording mode, below options can be set.

Recording resolution: 1920\*1080/ 1280\*720/ 640\*480

Video time: 5min/10min/30min

Recording Sound: On/off

Pre-Recording/delay: On/off

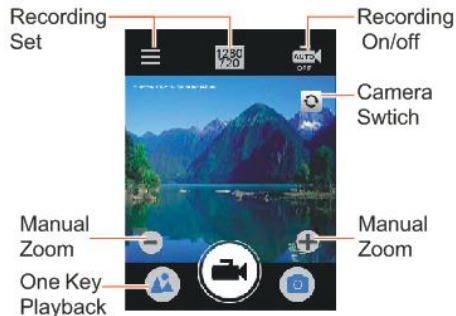

### 3.7 Recording/SOS

On Preview recording mode, press  to start sound recording, press again to stop recording and save file; Long press sound recording to start SOS contact dialing.

### 3.8 Photo Button

On Preview recording mode, short press on  to take photo and save automatic, the red indicator light keeps flashing. You also can set by following:

Photo resolution:

2560\*1920/3264\*2448/3968\*2976/4736\*3552/6528\*4896

Photo mode: single photo; serial 5 pieces/10 pieces /20 pieces options;

Interval of photo: 2S.3S.5S.10S.20S.30S options

timing to take photo: 5S.10S.15S.30S options;

### 3.9 IR/LED Compensation/Laser Position Light

IR/LED fill /Laser Position light can be opened by touching pull-down menu when recording.

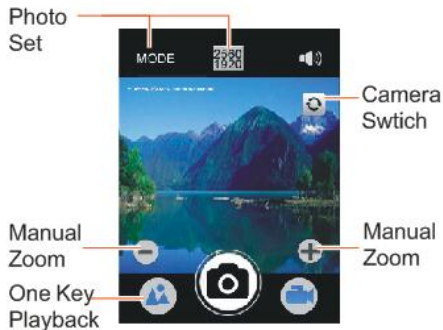

### **3.10 Microphone**

Used for communication and sound collection.

### **3.11 HD Zoom Camera**

The HD zoom camera is mainly used for taking microspur photo of certificate

### **3.12 SIM Card Slot.**

The device support Nano-SIM (4FF) SIM card, It supports:

3G Network: TD-SCDMA; WCDMA

2G Network: GSM (EGSM900/DCS1800/PCS1900/GSM850)

### **3.13 USB/AV-in Port**

Plug in USB cable to realize data interaction between the recorder and computer and to charge the battery. Use the specified external camera to realize features such as concealed sound recording, photo taking and recording.

### **3.14 Playback Speaker**

Used for playback of audio files.

### 3.15 HD Screen

The BWC use 2.4 inch HD touch screen, used for photo, recording, touch application and etc.

### 3.16 Files Playback

Audio and video files can be playback by touching. Main interface's files can be playback by menu or entering file on preview mode



### 3.17 Device Setting

Network settings: WiFi, GPS position, Bluetooth, mobile data on/off to set

Device setting: brightness setting, power saving mode, alarm clock, sound, real time data uploading, SOS contact , Vibration switches, Auto IR switch;

System setting: system information checking, time and date, language setting, hibernation setting

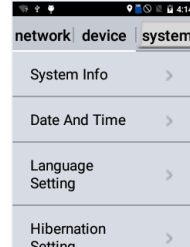
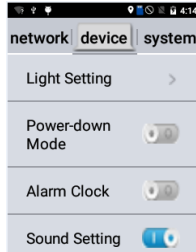
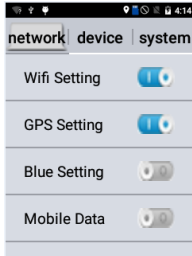

### 3.18 Built-in GPS Position.



Built-in GPS module can realize reporting and achieve global positioning. position trajectory playback.



### 3.19 Battery Replacement

Open the battery's cover along the arrow's direction to top, then clasp the left button, as picture.

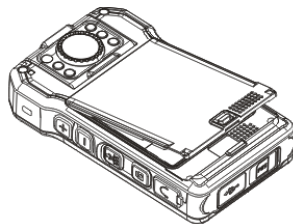
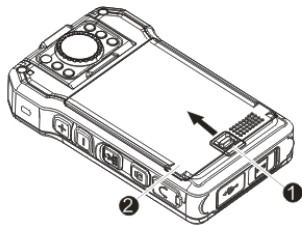

## 4. Trouble Shooting

Fault	Diagnosis	Solution
Power-on failure	Low Battery	Charge it for 4 hours
	Damaged power-on button	Please obtain service from our authorized maintenance station in your region or contact us.
The computer cannot identify device	Cannot log in the recorder	After connecting USB cable with computer, please enter the pin at the PC software to log in.
	Data cable problem	Change the data cable for reconnection.
	Problem of USB driver installation	Re-install USB driver.
Files cannot be copied	Authority level is limited	General account is only authorized to check files, and it cannot modify or delete them. Use an account with higher authority to copy.

## 5. Maintenance and Cleaning

DSJ-H9 body worn camera can be adapted to harsh environment, but the operation standards and maintenance should be complied with daily use to achieve its optimal performance.

◆ Carefully protect the lens, all the moveable parts and screen as they are inclined to damage due to the material and structure design requirements. Do not handle with force or press it. Prevent glass scratch if the display screen is damaged and prevent the liquid of the screen touching your skin, eyes or mouth.

### ◆ Battery

Please check the battery status before take the product out in the field and charge it before hand if necessary.

Stop the charging once the battery is full or the battery performance will be affected.

### ◆ Cleaning

Lens: The lens and glass are vulnerable parts, so try to keep your hands off them. You can use balloon blow to remove dust or lint. For stains which cannot be removed. You can use a clean soft cloth to wipe the lens from the center to the edge.

Display Screen: For removing fingerprints or other stains, please use a soft dry cloth to wipe it gently.

Body: Use balloon blow to remove dust or dirt and use a soft dry cloth to clean it.

#### ◆Storage

For long storage of the product, please turn it off before storage. Keep the product away from the following:

- ◎ Devices which possibly generate strong magnetic field.
- ◎ Places where the product is exposed to temperature of  $-10\text{ }^{\circ}\text{C}$  or above  $50\text{ }^{\circ}\text{C}$
- ◎ Damp places with poor ventilation.
- ◎ To prevent battery deterioration, the product should be taken out once a month and charged as well as operated before re-storing it.

## 6 . FCC Statement

### 6.1 Labeling requirements.

This device complies with part 15 of the FCC Rules. Operation is subject to the following two conditions: (1) This device may not cause harmful interference, and (2) this device must accept any interference received, including interference that may cause undesired operation.

### 6.2. Information to user.

Any Changes or modifications not expressly approved by the party responsible for compliance could void the user's authority to operate the equipment.

### 6.3 Information to user.

This equipment has been tested and found to comply with the limits for a Class B digital device, pursuant to Part 15 of the FCC Rules. These limits are designed to provide reasonable protection against harmful

interference in a residential installation. This equipment generates uses and can radiate radio frequency energy and, if not installed and used in accordance with the instructions, may cause harmful interference to radio communications. However, there is no guarantee that interference will not occur in a particular installation. If this equipment does cause harmful interference to radio or television reception, which can be determined by turning the equipment off and on, the user is encouraged to try to correct the interference by one or more of the following measures:

- Reorient or relocate the receiving antenna.
- Increase the separation between the equipment and receiver.
- Connect the equipment into an outlet on a circuit different from that to which the receiver is connected.
- Consult the dealer or an experienced radio/TV technician for help.

Specific Absorption Rate (SAR) information:

This product meets the government's requirements for exposure to radio waves. The guidelines are based on standards that were developed by independent scientific organizations through periodic and

thorough evaluation of scientific studies. The standards include a substantial safety margin designed to assure the safety of all persons regardless of age or health.

FCC RF Exposure Information and Statement The SAR limit of USA (FCC) is 1.6 W/kg averaged over one gram of tissue. This device was tested for typical body-worn operations with the back of the handset kept 0mm from the body with belt-clips and 5mm without belt-clips. To maintain compliance with FCC RF exposure requirements, use accessories that maintain a 5mm separation distance between the user's body and the back of the handset. The use of belt clips, holsters and similar accessories should not contain metallic components in its assembly. The use of accessories that do not satisfy these requirements may not comply with FCC RF exposure requirements, and should be avoided.

#### **6.4 Body-worn Operation**

This device was tested for typical body-worn operations. To comply with RF exposure requirements, a minimum separation distance of 5mm for body worn must be maintained between the user's body, including the antenna. Third-party belt-clips, holsters, and similar accessories used by this device should not contain any metallic components. Body-worn accessories that do not meet these requirements may not comply with RF exposure requirements and should be avoided. Use only the supplied or an approved antenna. comply with RF exposure requirements and should be avoided. Use only the supplied or an approved antenna.

Device is not restricted to use by only law enforcement agencies, device is also for other civil industries use.



**Kirisun Communications Co.,Ltd.**  
<http://en.kirisun.com>