



# User Manual

## PT3600

### FM HANDHELD TRANSCEIVER

We are very grateful for your purchasing  brand two-way radios produced by Shenzhen Kirisun Electronics Co., Ltd.

We believe  two-way radio, which always incorporates the latest technology, can bring great convenience to your life and work.

We also believe that the quality and function of  two-way radio can meet your demands for reliable communication.

#### **Instructional Icons**

This radio is not intended for use by general population in an uncontrolled environment. It is only for occupational use and only applied to work-related conditions.

The radio must be only used by users, who are fully aware of the hazards of the exposure and who are able to exercise control over their RF exposure to qualify for the higher exposure limits.

The radio should be not be using more than 50% duty factor in PPT and VOX function;

The following icons are available through this manual:

#### **Notice to the User:**

- \* Government laws prohibit radio communication without permission in government districts.
- \* Illegal operation is subject to punishment by fine and/or imprisonment.
- \* Refer service to the well-trained professional technicians only.

#### **Safety:**

It is important that the user is aware of and understands hazards common to the operation of any radio.

#### **Warning:**

Turn off your radio before entering any area with a potentially explosive atmosphere (where the air contains gas, dust and smog, etc.), such as while taking on fuel, or while parking at a gasoline service station.

#### **Attentions:**

Please comply with the following attentions to avoid fire, bodily injury and damage to the radio.

- \* Long time transmitting or continuous working in high power mode will make the rear side of the radio generate heat.
- \* Please do not disassemble or assemble the radio under any circumstance.
- \* Please do not expose the radio to direct sunlight for a long time; do not place the radio near any heating device, either.
- \* Please do not put the radio in extremely dusty, moist or dabbling places; do not place it on any unstable surface, either.
- \* If the radio emits smoke or strange odors, turn it off and remove the battery from the radio and contact your local authorized Kirisun dealer without delay.

## **RF Energy Exposure Compliance**

- Your radio is designed and tested to comply with a number of national and international standards and guidelines (listed below) regarding human exposure to radio frequency electromagnetic energy. This radio complies with the IEEE and ICNIRP exposure limits for occupational/controlled RF exposure environment at operating duty factors of up to 50% transmitting and is authorized by the FCC for occupational use only. In terms of measuring RF energy for compliance with the FCC exposure guidelines, your radio radiates measurable RF energy only while it is transmitting (during talking in VOX and PTT mode), not when it is receiving (listening) or in standby mode.
- The device complies with SAR and/or RF field strength limits of RSS-102 requirement and contact information where the user can obtain Canadian information on RF exposure and compliance.

### **Your radio complies with the following of RF energy exposure standards and guidelines**

- United States Federal Communications Commission, Code of Federal Regulations; 47CFR part 2 sub-part J
- American National Standards Institute (ANSI)/Institute of Electrical and Electronic Engineers (IEEE) C95. 1-1992
- Institute of Electrical and Electronic Engineers (IEEE) C95. 1-1999 Edition
- International Commission on Non-Ionizing Radiation Protection (ICNIRP) 1998

### **Operational Instructions and Training Guidelines**

To ensure optimal performance and compliance with the occupational/controlled environment RF energy exposure limits in the above standards and guidelines, users should transmit no more than 50% of the time (during talking in VOX and PTT mode) and always adhere to the following procedures: and should transmit no more than 50% of the time (during talking in VOX and PTT mode), although the hardware support transmission up to 100% of the time in analog mode.

### **Transmit and Receive**

To transmit (talk), push the Push-To-Talk (PTT) key; to receive, release the PTT key.

### **EU Regulatory Conformance**

The equipment is in compliance with the essential requirements and other relevant provisions of the Directive 1999/5/EC.

# CE 06780



Note: The above information is applicable to EU countries only.

## **FCC Licensing Information**

### **Part 15 Compliance**

This equipment has been tested and found to comply with the limits for a Class B digital device, pursuant to part 15 of the FCC Rules. These limits are designed to provide reasonable protection against harmful interference in a residential installation. This equipment generates, uses and can radiate radio frequency energy and, if not installed and used in accordance with the instructions, may cause harmful interference to radio communications. However, there is no guarantee that interference will not occur in a particular installation. If this equipment does cause harmful interference to radio or television reception, which can be determined by turning the equipment off and on, the user is encouraged to try to correct the interference by one or more of the following measures:

- ✚ Reorient or relocate the receiving antenna.
- ✚ Increase the separation between the equipment and receiver.
- ✚ Connect the equipment into an outlet on a circuit different from that to which the receiver is connected.
- ✚ Consult the dealer or an experienced radio/TV technician for help.

### **FCC Licensing Requirements**

A license from Federal Communications Commission is required prior to use. Your dealer will program each radio with your authorized frequencies, signaling codes, etc., and will be there to meet your communications needs as your system expands. Contact your dealer for more information.

## Contents

1. Unpacking and Checking .....	5
2. Preparation .....	5
2.1 Charging the Battery .....	5
2.2 Installing/Removing the Battery .....	6
2.3 Installing the Antenna .....	7
2.4 Installing the External Speaker/MIC.....	7
2.5 Installing/Removing the Belt Clip .....	7
3. Radio Overview .....	8
4. Basic Operations .....	9
4.1 Switching On.....	9
4.2 Adjusting the Volume .....	9
4.3 Selecting a Channel.....	9
4.4 Sending a Call .....	10
4.5 Receiving a Call .....	10
5. Functions of Programmable Buttons.....	10
6. Scan Function.....	11
7. Auxiliary Functions.....	11
7.1 Time-Out Timer (TOT) .....	11
7.2 Busy Channel Lockout (BCL) .....	12
7.3 Battery Saving.....	12
7.4 Low Battery Warning .....	12
7.5 Monitor .....	12
7.6 CTCSS/DCS.....	12
7.7 PTT ID .....	13
8. Troubleshooting .....	13
9. Major Specifications .....	13
10. Status Setting.....	14

## 1. Unpacking and Checking

Unpack the radio carefully. We recommend that you check the radio and the supplied accessories listed in the following table before discarding the packing material. If any damage or loss has occurred during shipment, please contact the dealer without delay.

### Supplied accessories

Item	Quantity
Antenna	1
Li-Poly Battery	1
Belt Clip	1
Charger	1
Power Adapter	1
Hand Strap	1
Instruction Manual	1

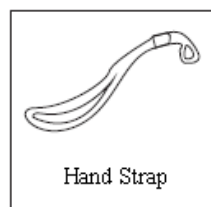
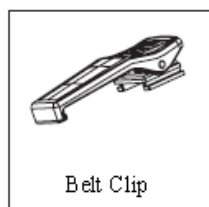
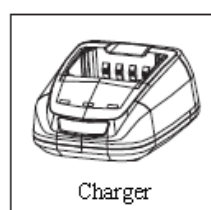
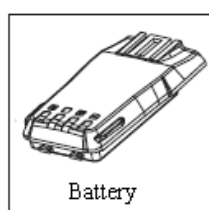
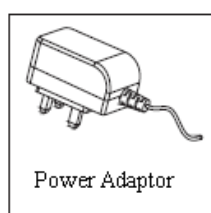
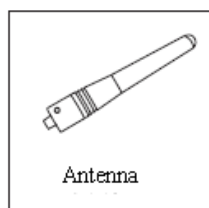

## 2. Preparation

### 2.1 Charging the Battery

Plug the power adapter into an applicable AC outlet and connect the power adapter to the

battery charger. The green LED will light up.

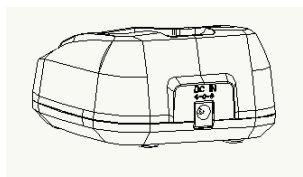

Insert the battery to be charged or the radio into the charger slot.

Make sure the battery is well connected with the charger. Then the red LED will light up, and the green LED will be out, which indicates that the charging starts.

After about 3~4 hours of charging, the red LED will be out, and the green LED will light up, which indicates that the battery is fully charged, then you can remove the battery from the charger.

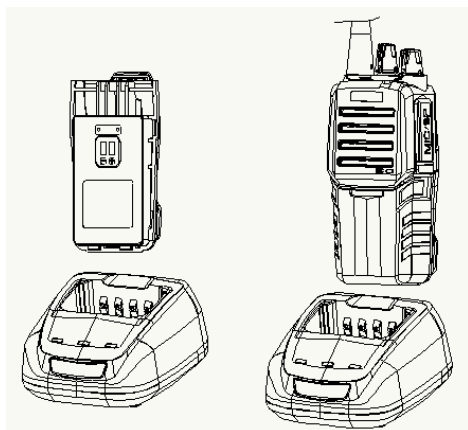

Note:

- \* The radio battery is not fully charged in the factory. Before the initial use, please charge the new battery.
- \* KB-31A Li-poly battery of Kirisun is applicable to this radio.
- \* When charging the battery for the first time after purchase or long-time storage (over 2 months), please repeat charging several times for the battery to achieve normal capacity.
- \* Do not recharge the battery if it has been fully charged or the radio is not in the low battery alarm state; otherwise, it will have bad effects on the battery's service life and performance. Remove the battery from the charger after charging.

## 2.2 Installing/Removing the Battery

Match the two bulges at the bottom of the battery pack with the corresponding slots at the rear bottom of the radio.

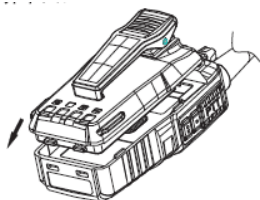

Press the top part of the battery towards the radio to lock it in place until a click is heard.

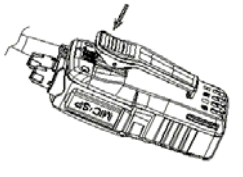

To remove the battery pack, push the battery latch upwards, and then remove the battery away from the radio.

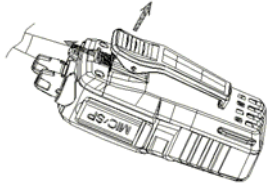

Note:

- \* Do not short-circuit the battery terminals or dispose battery in fire.
- \* Do not disassemble the battery casing by yourself.

### 2.3 Installing the Antenna

Hold the base of the antenna and turn the antenna clockwise into the connector on the top of the radio until secure.



### 2.4 Installing the External Speaker/MIC

Open the cover for external speaker/MIC jacks, and then insert the external speaker/MIC plug into the jacks on the radio.

Note: When using the external speaker/MIC, the radio will not be waterproof.

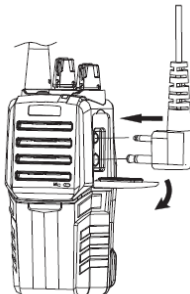

### 2.5 Installing/Removing the Belt Clip

Align the grooves of the belt clip with those on the rear of the battery. Then press the belt clip downwards until a click is heard. To remove the belt clip, use your fingernail or a tool to press the

belt clip tab away from the battery. Then slide the belt clip upwards to remove it.

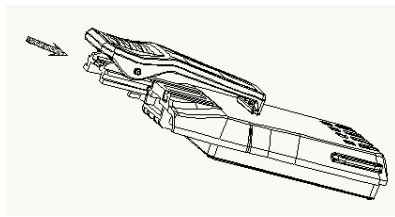

Belt Clip Tab

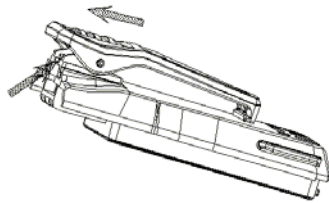
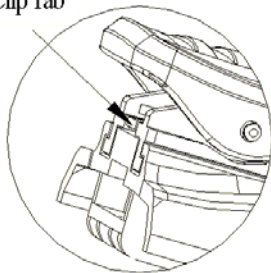

### 3. Radio Overview

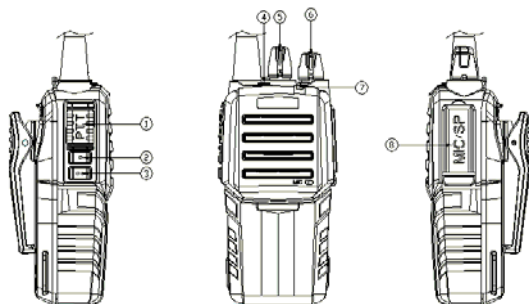

#### 1. PTT (Push-To-Talk) Button

To make a call, press and hold the PTT button, then speak into the microphone. Release the PTT button to receive signals.

#### 2. Programmable Button 2

You can assign functions to this button through PC software.

#### 3. Programmable Button 1

You can assign functions to this button through PC software.

#### 4. Emergency Button

Press the button to activate warning tone. Press it again to exit the emergency alert state.

Note: When the warning tone sounds, all the other buttons are disabled.

#### 5. Channel Selector Knob

Rotate it to select channel 1 – 16.

#### 6. On-Off/Volume Control Knob



Turn clockwise until you hear a click to turn the radio power on. Turn counterclockwise until you hear a click to turn it off. Rotate it to adjust the volume after turning on the radio.

#### 7. LED Indicator

Lights red while transmitting; lights green while receiving; flashes red when the radio is in low power while transmitting.

#### 8. External Speaker/MIC Jacks

For connecting external speaker/MIC. Open the MIC/SP cover to see the jacks.

## 4. Basic Operations

### 4.1 Switching On

Turn the On-Off/Volume Control Knob clockwise until a click is heard to switch on the radio. The radio will make a sound of “Di...” If programmed, the current channel number will be announced.

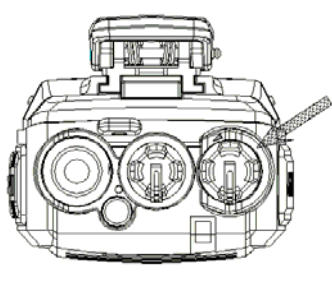

### 4.2 Adjusting the Volume

Turn the On-Off/Volume Control Knob to adjust the radio volume.

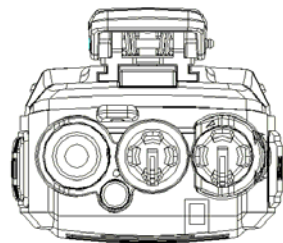

### 4.3 Selecting a Channel

Turn the channel selector knob to your desired channel. If voice annunciation has been set, the radio will announce the current channel number. You will hear voice from the speaker while receiving valid signals.

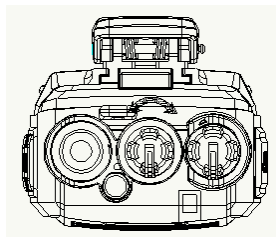

#### 4.4 Sending a Call

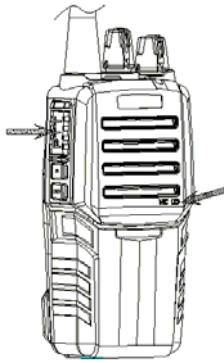

To make a call, press and hold the PTT button and speak to the microphone in normal voice. Please keep your mouth 3 - 8 cm away from the microphone.

#### 4.5 Receiving a Call

Adjust the volume to a proper level. Release the PTT button to receive a call.

### 5. Functions of Programmable Buttons

**Long Press Duration:** Amount of time that the radio-user is required to press (and hold down) a button, for the press to be interpreted by the radio as a long press. A short press is defined as any button-press that is shorter than the duration.

The dealer can assign one of the following auxiliary functions to the long press or short press of the programmable button 1 and programmable button 2:

- None: No function is assigned.
- Monitor Momentary

Press and hold the preprogrammed Monitor Momentary button to open squelch for monitoring the transmission on the channel whether the CTCSS/DCS, audio squelch conditions match or not. Release it to exit monitor mode.

- Monitor

Press the preprogrammed Monitor button to open squelch for monitoring the transmission on the channel whether the CTCSS/DCS, audio squelch conditions match or not. Press it again to exit monitor mode.

- Squelch Off Momentary

Press and hold the preprogrammed Squelch Off Momentary button to open squelch momentarily, and release it to resume normal operation.

- Squelch Off

Press the preprogrammed Squelch Off button to open squelch, and press it again to resume normal operation.

- Channel Annunciation

Press the preprogrammed Channel Annunciation button, the current channel number can be heard.

- Scan

Press the preprogrammed Scan button to start scanning (the scan list should be effective), press it again during the scanning to stop scanning.

- High/Low Power Switch

Press the preprogrammed High/Low Power Switch button to switch the current channel power between high and low.

- **Battery Check**

Press the preprogrammed Battery Check button, the current battery power level can be heard. There are four levels in all. Level 4 indicates that the battery power is full, and level 1 indicates that the battery power is low.

- **Squelch Adjust**

Press the preprogrammed Squelch Adjust button to change the current squelch level, and the squelch level after the change can be heard.

## **6. Scan Function** (this function can be disabled by the dealer)

If the scan function is enabled, you can press the preprogrammed Scan button to start scanning and press it again to stop scanning.

### **Explanations:**

- After scan pauses, there are two ways to resume scanning:

1. Time operate: After pausing on an active channel, the radio will resume scanning after a preprogrammed delay. The scan delay time can be preset from 0.5 to 5 seconds.
2. Carrier operate: After pausing on an active channel, the radio will resume scanning after a preprogrammed delay after the channel becomes inactive. The scan delay time can be preset from 0.5 to 5 seconds.

- The revert channel during scan can be designated through PC software. There are following options available:

1. Last Rx channel:

When pressing the PTT button during scanning, the radio will transmit from the last channel that received a call.

2. Selected:

When pressing the PTT button during scanning, the radio will transmit from the selected channel.

3. Priority channel (the priority channel must be set)

When pressing the PTT button during scanning, the radio will transmit from the priority channel in the scan list.

4. Last Tx channel:

When pressing the PTT button during scanning, the radio will transmit from the last channel that transmits signals.

## **7. Auxiliary Functions**

### **7.1 Time-Out Timer (TOT)**

- 1) TOT Function

The time-out-timer can prevent the user from continuously talking overlong and prevent the radio from heating due to continuous transmitting.

If you continuously transmit longer than the preset TOT time, the radio will make an alert tone and stop transmitting. To stop the warning tone, release the PTT button.

- 2) TOT Pre-alert

The radio will make an alert tone in advance before the TOT terminates the transmission. After the alert tone, when the time of transmission exceeds the preset time, the TOT timer will act.

### 3) TOT Rekey Time

A period in which the radio is forbidden to transmit after its overtime activity.

During the period, if the PTT button is pressed, an alert tone will be sounded, and the transmission is forbidden.

### 4) TOT Reset Time

The time delay from releasing the PTT button to the resetting of the timer is limited.

The countdown will go on if the time after releasing the PTT key is shorter than the reset time.

## **7.2 Busy Channel Lockout (BCL)**

If the channel on which a user attempts to transmit is being used by another party, BCL function restricts the transmission in order to avoid interfering with the other parties' communication, and the radio will make an alert tone, and returns to the receiving state.

## **7.3 Battery Saving**

The battery saving function can reduce power consumption of the radio when no signal is received and no operation is conducted (no button is pressed and no knob is turned).

If the radio hasn't receive any signal or no operation is being conducted for 16 seconds, the radio will enter Battery Saving Mode. When a signal is received or any operation occurs, the radio will exit the Battery Saving Mode automatically.

## **7.4 Low Battery Warning**

When the battery voltage drops too low while transmitting, the LED flashes red, low battery warning tone sounds, and the radio stops transmitting. You need to recharge or change the battery.

## **7.5 Monitor**

When there is no signal received, the radio's squelch circuit will mute the speaker automatically so that the background noise will not be heard by the user. You can press and hold the preprogrammed Monitor button to open squelch manually. This function is especially useful when you need to adjust the volume level or to receive weak signals.

When the Monitor button is pressed and held, the LED indicator lights green, and the radio is in the monitoring state.

## **7.6 CTCSS/DCS**

CTCSS/DCS tones may have been pre-programmed on some radio channels. A CTCSS/DCS tone is a sub-audible tone, which allows you to ignore (not hear) calls from other irrelevant parties who are using the same channel. When you receive a signal that has a tone different from the one set on your radio, you will not hear the signal. Likewise, signals that you transmit will only be received by parties whose CTCSS/DCS tones are the same as yours.

Note: Using a CTCSS/DCS channel doesn't mean your calls are private. If other parties' CTCSS/DCS tones are identical with yours, they can hear your calls.

## 7.7 PTT ID

PTT ID uses DTMF code. The preset DTMF sequence can be sent at the beginning of the transmission or at the end of the transmission. It is used to notify the identity of the callers to the monitoring center, or used to activate the repeater.

The encoder sequence and the encoder type can be set for each channel. There are 16 groups of sequences for your selection.

**PTT ID Keydown Code:** The radio will send DTMF sequence when the PTT button is pressed.

**PTT ID Dekey Code:** The radio will send DTMF sequence when the PTT button is released.

## 8. Troubleshooting

No.	Problem	Causes and Solutions
1	The radio cannot be switched on or no display after being switched on.	<ul style="list-style-type: none"> <li>* The battery power may be insufficient. Please recharge or replace the battery pack.</li> <li>* The battery pack may not be installed properly. Please remove the battery pack and install again.</li> </ul>
2	The battery power consumes quickly after charging.	<ul style="list-style-type: none"> <li>* The battery life is finished. Please replace it with a new battery pack.</li> </ul>
3	Cannot talk to or hear other group members.	<ul style="list-style-type: none"> <li>* Make sure the CTCSS/DCS signal is the same as that of your group members.</li> <li>* The radio is out of effective communication range.</li> </ul>
4	Other voices from non-group members are heard on the channel.	<ul style="list-style-type: none"> <li>* Change the CTCSS/DCS signal, and make sure to change the CTCSS/DCS signal of all radios in your group.</li> </ul>
5	The communication range is too short.	<ul style="list-style-type: none"> <li>* Make sure the antenna is well connected.</li> <li>* Make sure the antenna is the original supplied one.</li> <li>* Check if the battery power is in normal state.</li> <li>* Ask your local dealer to adjust the squelch level.</li> </ul>

## 9. Major Specifications

Model	PT3600	
Frequency (MHz)	136 – 174MHz	VHF
	400 – 470MHz	UHF
RF power	4W(UHF)	5W(VHF)
Tx clusters and harmonics	< -70dB	
Frequency stability	± 5ppm	
Max. deviation	± 5KHz (W) / ± 2.5KHz (N)	
Rx sensitivity	≤ 0.18μV	
Channel selectivity	> 60dB	
Intermodulation	> 60dB	
Max. audio power	≥ 1000mW	
Channel number	16 (15 + S)	
Power supply	DC 7.4V	
External dimension	47mm × 107mm × 33mm	
Weight	225g (with battery and antenna)	

**10. Status Setting** (by the dealer)

Model:

Serial No.:

1. Channel setting

Channel No.	Tx frequency	Rx frequency	CTCSS/DCS
1			
2			
3			
4			
5			
6			
7			
8			
9			
10			
11			
12			
13			
14			
15			
16			

2. The way to resume scanning after its pause:

Time Operate

Carrier Operate

3. Revert channel:

Selected Channel

Selected Channel or Currently Working Channel

Priority Channel

Priority Channel or Currently Working Channel

Last Called Channel

Last Working Channel + Currently Working Channel

4. Squelch

ON

OFF

5. TOT

ON

OFF