Kodak Digital Science DC120 Zoom Digital Camera



User's Guide *for camera and software*

Kodak, Digital Science, and the ds monogram symbol are trademarks of Eastman Kodak Company.

FlashPix is a trademark of Eastman Kodak Company. The *FlashPix* format is defined in a specification and test suite developed and published by Kodak in collaboration with Microsoft, Hewlett-Packard, and Live Picture. Only products that meet the specification and pass the test suite may use the *FlashPix* name and logo.

Adobe is a trademark of Adobe Systems Incorporated and its subsidiaries.



Table of Contents

Chapter-Page

| | |
|--|------------|
| Table of Contents | i |
| Getting Started | 1-1 |
| Package Contents | 1-1 |
| Your DC120 Camera | 1-2 |
| Using Your DC120 Camera | 2-1 |
| Batteries | 2-1 |
| Camera On/Off | 2-2 |
| Status Display | 2-3 |
| AutoFocus | 2-4 |
| Exposure | 2-5 |
| Flash | 2-7 |
| Album | 2-8 |
| Card Status | 2-9 |
| Picture Quality | 2-10 |
| Self-Timer | 2-11 |
| Pictures Remaining | 2-12 |
| Battery Status | 2-13 |
| Taking Pictures | 2-14 |
| Using the LCD Display | 2-15 |
| Quickview | 2-15 |
| Preview | 2-16 |
| Reviewing Your Pictures on the LCD | 2-17 |

| | |
|---|------------|
| Moving Pictures into Albums | 2-19 |
| Moving Pictures to a Kodak Picture Card | 2-20 |
| Erasing Pictures from the DC120 or Kodak Picture Card | 2-21 |
| INFO | 2-22 |
| Adjusting LCD Brightness | 2-23 |
| Automatic LCD Turn Off | 2-23 |
| Zoom | 2-24 |
| Automatic Power Off | 2-24 |
| Optional Accessories | 2-25 |
| AC Adaptor | 2-25 |
| Kodak Picture Card | 2-26 |
| General Maintenance and Safety | 2-28 |
| DC120 Specifications | 2-29 |
| Using DC120 with Your Computer | 3-1 |
| Connecting the DC120 to Your Computer | 3-1 |
| Checking Serial Port Availability | 3-2 |
| Monitor Adjustment | 3-3 |
| Printing | 3-4 |
| Installation Software | 4-1 |
| Software included on the CD | 4-1 |
| System Requirements | 4-2 |
| Installing the Software | 4-3 |
| Picture Transfer Application | 5-1 |
| Installation | 5-1 |
| Camera Communication Settings | 5-1 |
| Starting Picture Transfer Application | 5-2 |
| Overview | 5-2 |
| Transferring Pictures from DC120 | 5-3 |
| Preferences Settings | 5-6 |

| | |
|--|------------|
| TWAIN & Plug-in Access Software | 6-1 |
| Installation | 6-1 |
| Camera Communication Settings | 6-1 |
| Starting Access Software | 6-2 |
| Overview | 6-3 |
| Transferring Pictures from DC120 | 6-4 |
| Picture Information | 6-7 |
| Rotating Your Picture | 6-7 |
| Enhancing Your Picture | 6-8 |
| Preferences Settings | 6-9 |
| Changing Connection Setup | 6-9 |
| Changing Display Setup | 6-10 |
| Changing Transfer Resolution | 6-11 |
| Camera Functions | 6-12 |
| Changing LCD settings | 6-12 |
| Changing Camera Functions | 6-13 |
| Album Setup | 6-13 |
| Erasing Pictures | 6-14 |
| PhotoEnhancer Software | 7-1 |
| Installation | 7-1 |
| Starting PhotoEnhancer | 7-1 |
| Overview | 7-2 |
| Transferring Pictures into PhotoEnhancer | 7-3 |
| Editing Tools | 7-4 |
| Enhancing Your Picture | 7-5 |
| Enhancing in One Step | 7-5 |
| Enhancing by Example | 7-6 |
| Correcting for Lighting Conditions | 7-8 |
| Saving Your Pictures | 7-8 |
| Printing Your Pictures | 7-8 |

Mounter Software8-1

| | |
|---|-----|
| Installation | 8-1 |
| Camera Communication Settings | 8-1 |
| Overview | 8-2 |
| Transferring Pictures from DC120 | 8-3 |
| Setting and Viewing Properties | 8-5 |
| Camera Memory or Memory Card Properties | 8-5 |
| Picture File Properties | 8-6 |
| Album Properties | 8-7 |
| Camera Properties | 8-8 |

Troubleshooting9-1

Where to Get Help10-1

| | |
|-----------------------------|------|
| Software Help | 10-1 |
| Online Services | 10-2 |
| Faxed Information | 10-2 |
| Customer Support | 10-2 |

Warranty & Regulatory InformationW-1

| | |
|------------------------------------|-----|
| Warranty Time Period | W-1 |
| Warranty Repair Coverage | W-1 |
| Limitations | W-2 |
| Application Support | W-3 |
| How to Obtain Service | W-3 |
| Regulatory Information | W-4 |



Getting Started

Congratulations on purchasing your new *Kodak Digital Science™* DC120 Zoom Digital Camera (DC120). The DC120 features a 3x zoom lens, built-in flash, and color Liquid Crystal Display (LCD) which allows you to immediately view your pictures.

The DC120 offers 2 megabytes (MB) of internal picture storage plus the convenience of a removable optional Kodak Picture Card, and an album feature to easily store and organize your pictures. Use the enclosed software packages to transfer, enhance, and save pictures from the DC120.

The pictures used throughout this manual were taken with the DC120.

Package Contents

- ✓ DC120 camera with handstrap
- ✓ DC120 User's Guide
- ✓ two serial cables (one for Macintosh and one for PC)
- ✓ DC120 software
- ✓ four AA batteries
- ✓ quick setup guide(s)
- ✓ registration cards

Your DC120 Camera

Camera Front

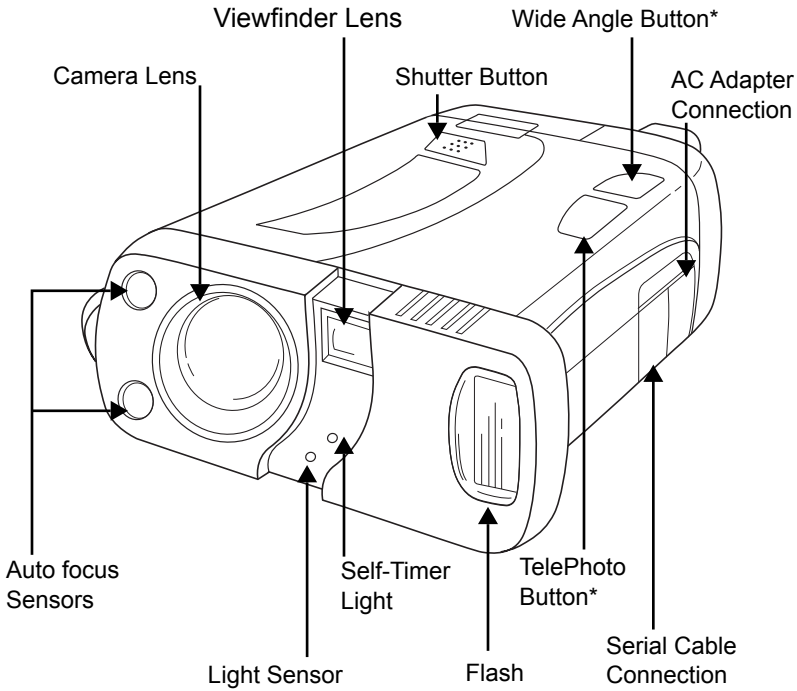

*The Wide Angle and the TelePhoto buttons are also used to scroll through previously taken pictures when the pictures are viewed on the LCD screen.

Camera Back

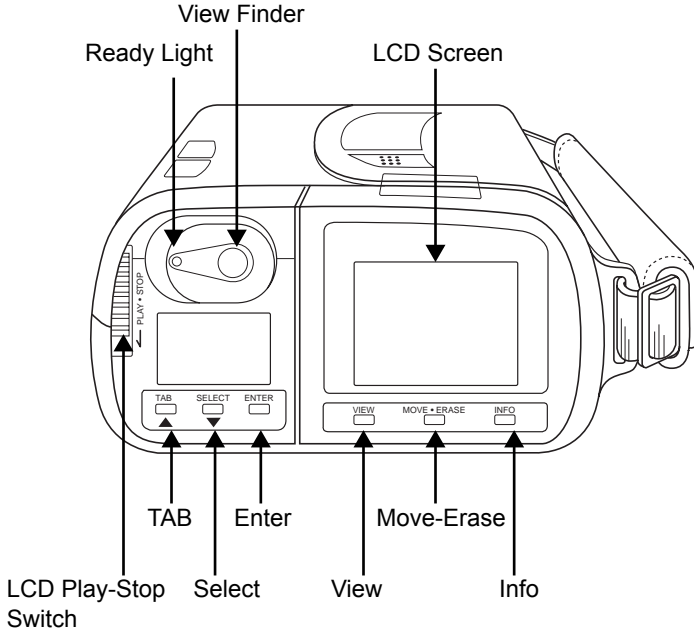

Camera Back - LCD Screen Up

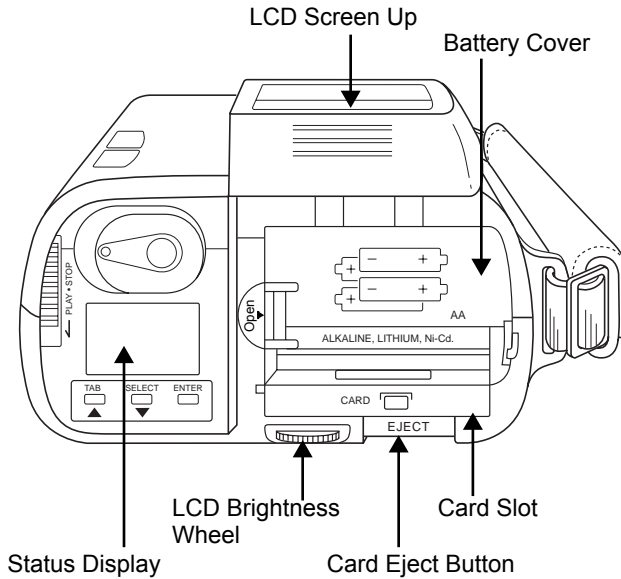



Using Your DC120 Camera

Batteries

The DC120 comes equipped with four AA batteries. You may use standard 1.5V alkaline, 1.7V lithium, or rechargeable 1.2V NiCad batteries. The power level of the batteries can be checked from the Status Display. See “Battery Status” on page 2-13 for details.

To install the batteries:

- 1 Flip-up the LCD screen to expose the battery cover.

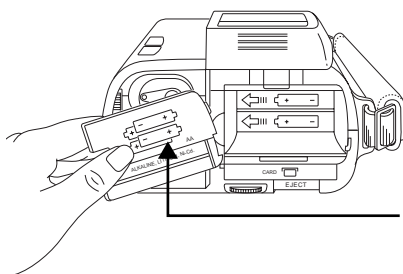

- 2 Remove the battery cover.

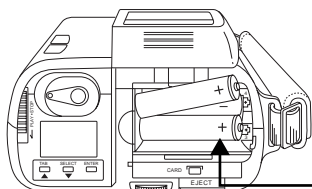

- 3 Insert the batteries as indicated on battery cover.

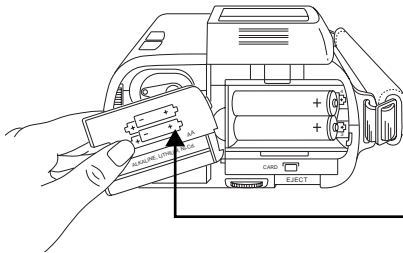

4 Place the battery cover over the batteries and flip-down the LCD screen.

 Remove the batteries if the DC120 will not be used for an extended period of time. This extends battery life and prevents camera damage from battery leaks or corrosion.

Camera On/Off

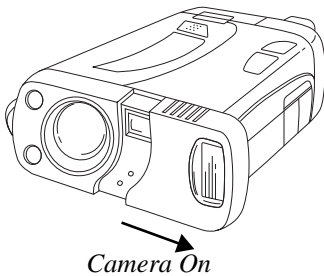

Turn the camera on—by sliding cover away from the camera until it clicks. The Status Display screen turns on.

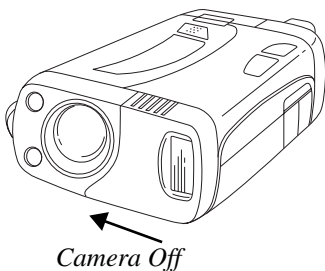

Turn the camera off—by sliding cover toward the camera until it covers the viewfinder lens and clicks into place.

 If the camera is turned off while a picture is being processed, the camera will finish processing the picture before turning off.

Status Display

The Status Display allows you to view, select, and change the camera settings. The following sections offer detailed descriptions of Status Display settings.

 The DC120 must be turned on to view the Status Display.

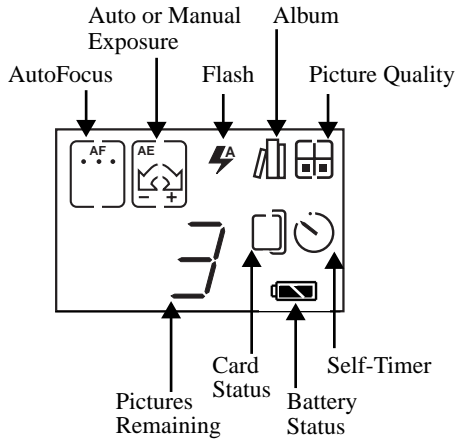

To select and change camera settings:

- 1 Turn the camera on.
- 2 Press the TAB button to select the icon.

The icon blinks when it is selected.

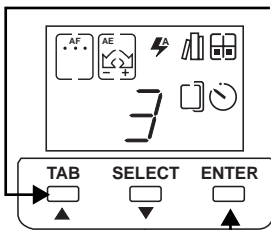

- 3 Press the SELECT button to scroll through setting options.
- 4 Press the ENTER button to select an option.

AutoFocus

The DC120 has three focus settings:



Auto Focus with multi-spot—measures the subject’s distance at three different locations in the scene and adjusts the focus to the closest distance. This is the default focus setting.



Auto Focus with single-spot—measures the subject’s distance at the center location and adjusts the focus to that distance.



Macro mode—allows you to manually adjust the focus from 8 to 20 inches using the TelePhoto or Wide buttons. The focus distance (in inches) is shown in the Status Display.



You may manually change the focus distance to centimeters using the TWAIN/Plug-in Access software. See [Chapter 6 - TWAIN/Plug-In Access Software](#) for more detailed information.

To accurately capture the picture in Macro mode the Preview option automatically starts when the Shutter button is pressed half-way down. See “Preview” on page 2-16 for detailed information.

To set and lock in the focus, while taking a picture, press the Shutter button half-way down. The camera can then be moved and the focus distance stays set until the Shutter button is released.

To change the AutoFocus setting:

- 1 Turn the camera on and press the TAB button once.

The AutoFocus icon blinks.

- 2 Press the SELECT button to scroll through the AutoFocus settings.
- 3 Press the ENTER button to select the appropriate AutoFocus setting.

The AutoFocus icon is changed to the selected AutoFocus setting. If Macro mode is selected, use the TelePhoto or Wide buttons to set the focus distance.

The selected Focus setting returns to the default setting when the camera is turned off.

Exposure



The DC120 has four exposure settings:



Auto Exposure—automatically adjusts the exposure. This is the default exposure setting.



Auto Exposure-plus (+)—allows you to manually increase the exposure in half-stop increments up to two full stops. The Status Display indicates the level of increase when you scroll through the Auto Exposure-plus settings using the SELECT button.

Use Auto Exposure-plus to lighten your picture.



Auto Exposure-minus (-)—allows you to manually decrease the exposure in half-stop increments up to two full stops. The Status Display indicates the level of decrease when you scroll through the Auto Exposure-minus settings using the SELECT button.

Use Auto Exposure-minus to darken your picture.



Manual Exposure—allows you to manually adjust the shutter speed from 1/500 to 16 seconds. The shutter speed appears in the Status Display when you scroll through the Manual Exposure options using the SELECT button.

The following table lists the Manual Exposure shutter speed settings and the corresponding F-stop.

| Shutter speed | F-stop (Wide Angle) | F-stop (TelePhoto) |
|---------------------|---------------------|--------------------|
| 1/500 | f14.4 | f21.4 |
| 1/430 | f10.9 | f16.2 |
| 1/380 | f8.2 | f12.2 |
| 1/330 | f6.2 | f9.2 |
| 1/300 | f4.7 | f6.9 |
| 1/250 | f3.5 | f5.2 |
| 1/225 | f2.6 | f3.9 |
| 1/125 to 16 seconds | f2.5 | f3.8 |

A longer exposure time may reduce picture clarity. The default lens position is Wide Angle. All other lens positions are considered TelePhoto settings.



The Auto flash setting will not respond when using a Manual Exposure shutter speed of 1/250 to 1/500 seconds. Set the flash to Fill if a flash is needed at those shutter speeds.



To change the Exposure setting:

- 1** Turn the camera on and press the TAB button twice to highlight the Auto Exposure setting or three times to highlight the Manual Exposure setting.
The Auto Exposure or Manual Exposure icon blinks.
- 2** Press the SELECT button to scroll through the Auto Exposure plus (+) or minus (-) settings or to adjust the Manual Exposure setting.
- 3** Press the ENTER button to select the appropriate exposure setting.
The exposure icon is changed to the selected exposure setting.

The selected Exposure setting returns to the default setting when the camera is turned off.

Flash

The DC120 is equipped with a built-in sensor flash with three settings:

-  **Auto**—flash fires automatically whenever the Shutter button is pressed and the DC120 determines that there is not enough light to take a picture. This is the default setting.
-  **Fill**—flash fires every time you press the Shutter button. Use this setting when the lighting is poor or when your subject is lit from behind.
-  **Off**—flash is turned off and will not fire.

 The Auto flash setting will not respond when using a Manual Exposure shutter speed of 1/250 to 1/500 seconds. Set the flash to Fill if a flash is needed at those shutter speeds.

The flash has an effective range of approximately:

- ✓ 2.3 to 16.4 ft. (0.7 to 5 m) using the Wide Angle setting
- ✓ 2.3 to 10.8 ft. (0.7 to 3.3 m) using the TelePhoto setting

To change the Flash setting:

- 1** Turn the camera on and press the TAB button four times.
The Flash icon blinks.
- 2** Press the SELECT button to scroll through the Flash settings.
- 3** Press the ENTER button to select the appropriate Flash setting.
The Flash icon is changed to the selected Flash setting.

The selected Flash setting returns to the default setting when the camera is turned off.

 An external flash may be used with an optional Flash Sync cable.

Album

The DC120 allows you to store pictures in one of 8 preset albums on the camera's internal memory or up to 60 albums using an optional Kodak Picture Card.

You can identify which album to store the picture in:

- ✓ before the picture is taken

or

- ✓ move it into an album after it is taken using the Change Album feature. See "Moving Pictures into Albums" on page 2-19 for more details.

Once the picture is taken you may then view pictures by album. See "Reviewing Your Pictures on the LCD" on page 2-17 for more details.

To change the Album setting:

- 1 Turn the camera on and press the TAB button five times.

The Album icon and the album number blinks.

- 2 Press the SELECT button to scroll through the Album settings.

The Album settings are displayed on the Status Display and Album names are displayed on the LCD.

- 3 Press the ENTER button to select the appropriate Album setting.

The LCD turns off. New pictures are now automatically saved to the selected Album setting.

The Album setting is maintained until another album is selected. This setting **does not** change when the camera is turned off.

-  Names of albums can be personalized using TWAIN/Plug-In Access software. See Chapter 6 - *TWAIN/Plug-in Access Software* for more detailed information.

Card Status

The Card Status icon changes automatically to indicate if there is an optional Kodak Picture Card inserted in the DC120. You may not select or change this icon.



No card inserted—pictures are saved to the camera's memory.



Card inserted—pictures are saved to the card's memory.







If a Kodak Picture Card is inserted into the camera and a picture is taken, the center of the icon blinks while the camera is processing the picture.

WARNING: Do not insert or eject a Kodak Picture Card when the Ready light is blinking, or when using the Move or Erase features. This may damage your pictures or camera.

Picture Quality

The DC120 captures pictures using one of four Picture Quality settings.

| Setting | Picture Quality | Minimum number of pictures stored | Compression |
|---|-----------------|-----------------------------------|-------------|
|  | Uncompressed | 2 | No |
|  | Best | 7 | Yes |
|  | Better | 12 | Yes |
|  | Good | 20 | Yes |

Pictures include more detail using the Uncompressed or Best setting, but they will use more memory than the Better or Good setting.

You can switch freely between the four settings when taking pictures. The number of pictures the DC120 is able to store will vary accordingly.

To change the Picture Quality setting:

1 Turn the camera on and press the TAB button six times.

The Picture Quality icon blinks.

2 Press the SELECT button to scroll through the Picture Quality settings.

3 Press the ENTER button to select the appropriate Picture Quality setting.

The Picture Quality icon is changed to the selected setting. The picture remaining number changes to reflect the new Picture Quality setting.

The Picture Quality setting is maintained until another setting is selected. This setting **does not** change when the camera is turned off.

Self-Timer

Selecting the Self-Timer icon creates a 10-second delay between the time you press the Shutter button and when the picture is taken. This allows you to include yourself in the picture.



To activate the Self-Timer:

- 1 Turn the camera on.
- 2 Press the TAB button seven times.
The Self-Timer icon blinks.
- 3 Press the SELECT button.
The Self-Timer icon is highlighted.
- 4 Press the ENTER button to activate the Self-Timer option
- 5 Place the camera on a flat, steady surface or tripod.
- 6 Press the Shutter button.

The red Self-Timer light, located on the front of the camera, and the green Ready Light, located on the back of the camera, turn on and stay lit for 8 seconds. The Self-Timer light flashes for 2 seconds just before the picture is taken.

The Self-Timer returns to the off setting once the picture is taken.

 To stop the Self-Timer before the picture is taken, press the TAB button.

Pictures Remaining 3

The Pictures Remaining icon changes automatically to indicate the following:

- ✓ Focus distance of camera, while in Macro mode
- ✓ Auto Exposure (plus or minus) amount, while it is being changed
- ✓ Manual Exposure shutter speed, while it is being changed
- ✓ Album number, while it is being changed
- ✓ error codes (see Chapter 9 - *Troubleshooting* for more detailed information)
- ✓ remaining number of pictures which can be stored at the current Picture Quality setting in the camera's internal memory. If an optional Kodak Picture Card is inserted this indicates remaining space on the card. To check the camera's memory, the card must be removed.
 - ☞ The Pictures Remaining number does not always change when a picture is taken if the picture content is easily compressed.
- ✓ when the camera's or optional Kodak Picture Card's memory is full the Status Display indicates **FUL** and you must erase the existing pictures to capture additional pictures. To save pictures, transfer them to your computer before erasing them. For more information on how to erase pictures, see "Erasing Pictures from the DC120 or Kodak Picture Card" on page 2-21 or the software chapters on how to move pictures from the DC120 to your computer.
 - ☞ If the optional Kodak Picture Card is full you will not be able to take any more pictures. Remove the card and, if the camera memory is not full, you can take additional pictures.

You may not select or change the Pictures Remaining icon.

Battery Status



The battery power level is indicated on the Status Display using the following icons.



—Batteries are fully charged.



—Batteries need to be replaced soon. Pictures stored in the camera's or Kodak Picture Card's memory are not lost if the batteries are depleted.

The DC120 may unexpectedly turn off if the batteries reach a low point and they will need to be replaced. If the batteries should go dead while pictures are stored in the camera's memory or optional Kodak Picture Card, the pictures remain stored in the camera or card.

The power level of alkaline batteries may drop suddenly when used in extreme cold. Warming or resting the batteries may restore the batteries to a usable condition.

The battery icon does not appear on the Status Display when the optional AC adaptor is used.

For information on installing batteries see "Batteries" on page 2-1.

Taking Pictures

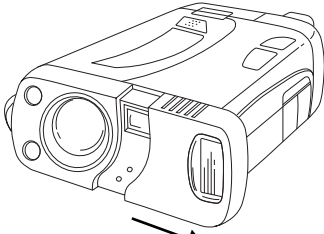

Camera On

Subject range 2 to 3 ft.
(0.5 to 1 m)

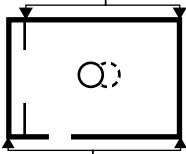

Subject range 3 ft. (1 m)
to infinity

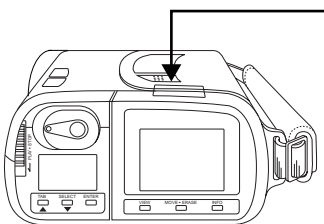

1 Turn the camera on.

2 Center subject using the:

- ✓ entire viewfinder area and the solid circle when your subject is more than 3 ft. (1 m) away.
- ✓ viewfinder's inside line and broken circle when your subject is 2 to 3 ft. (0.5 to 1 m) away.
- ✓ LCD Preview display, which is automatically activated when the focus is set to Macro mode, and your subject is less than 20 in. (50 cm) away.

3 Press the Shutter button half-way down to lock-in the focus on your subject.

The green Ready light stays on to indicate the focus is locked-in. In Macro mode the LCD displays a Preview of the picture.

4 Press the Shutter button completely down to take a picture.

There is a slight delay from when the Shutter button is fully depressed and when the picture is captured. The picture is stored in the camera's or optional Kodak Picture Card's memory.

The green Ready light and the Pictures Remaining number on the Status Display blinks rapidly as the DC120 processes the picture. The Pictures Remaining number on the Status Display is reduced by one.

You do not need to hold the camera still while the green Ready light is on, but you will not be able to take another picture until it turns off.

Using the LCD Display

Your DC120 comes equipped with a color Liquid Crystal Display (LCD) that allows you to quickview, preview, or review your pictures!

Quickview

The Quickview option allows you to view each picture moments after it is taken!

To activate Quickview:

- 1 Turn the camera on.

Do not activate the PLAY-STOP option.

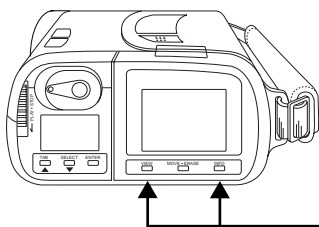

- 2 Press the VIEW and INFO buttons at the same time.

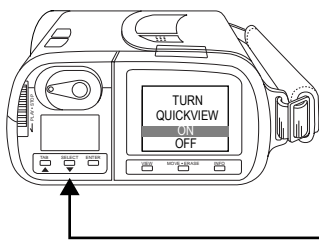

- 3 Press the SELECT button to highlight the appropriate option.

The LCD displays a QUICKVIEW ON/OFF screen.

- 4 Press the ENTER button.

The QUICKVIEW screen turns off.

When you take a picture with Quickview ON, the picture momentarily appears on the LCD after the picture is taken.

The Quickview setting is maintained until another setting is selected. This setting **does not** change when the camera is turned off.

Preview

You may also use the LCD as a viewfinder to preview your subject before taking a picture.

 Using the preview option shortens battery life.

To activate Preview:

- 1 Turn the camera on.

Do not activate the PLAY-STOP option.

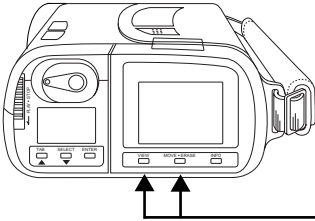

- 2 Press the VIEW and MOVE-ERASE buttons at the same time.

The LCD momentarily displays a PREVIEW ON screen.

- 3 Press and hold the Shutter button half-way down.

The LCD displays the subject that is viewed from the viewfinder. The LCD automatically turns off after several seconds to preserve battery life. Press the Shutter button half-way down to restart.

To Exit: Press the VIEW and MOVE-ERASE buttons again. The LCD momentarily displays a PREVIEW OFF screen.

The Preview setting automatically turns off when the camera is turned off.

Reviewing Your Pictures on the LCD

The Play-Stop switch allows you to review previously taken pictures on the LCD.

- ☞ The camera does not have to be turned on to use the PLAY-STOP option. You cannot take a picture when PLAY-STOP is on.

To activate PLAY-STOP:

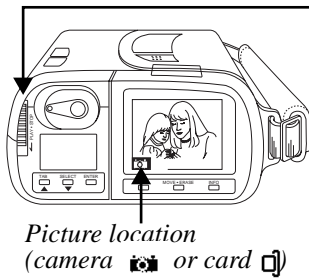

Press the PLAY-STOP switch.

The LCD displays the last picture taken. The picture location icon disappears after several seconds.

The Album icon only appears when a specific album has been selected in the PLAY OPTIONS screen.

A message appears if no pictures are in the camera's or optional Kodak Picture Card's memory.

To view multiple pictures:



Press the VIEW button:

- ✓ once to view four pictures at once
- ✓ twice to view nine pictures at once

- ☞ When viewing multiple pictures, you may view a larger format of a picture by pressing the SELECT button until the correct picture is highlighted by the yellow box, then press the ENTER button.

- ☞ Scroll through the pictures by pressing the TelePhoto or Wide Angle buttons.

To activate the PLAY OPTIONS screen:

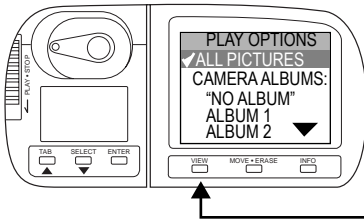

Press the VIEW button three times.

The PLAY OPTIONS screen allows you to view pictures:

- ✓ in both the camera's and/or optional Kodak Picture Card's memory.
- ✓ not assigned to an album.
- ✓ assigned to albums. Selecting an album limits playback to pictures in that album.

To select a play option, press the SELECT or TAB button until the appropriate option is highlighted, then press the ENTER button.

To Exit: Press the PLAY-STOP switch again to turn off the LCD.

Moving Pictures into Albums

The Change Album feature allows you to move previously taken pictures into albums on the DC120's memory or the optional Kodak Picture Card.

 The camera does not have to be turned on to use the PLAY-STOP option. You cannot take a picture when PLAY-STOP is on.

- 1** Press the PLAY-STOP switch.

The LCD displays the last picture taken.

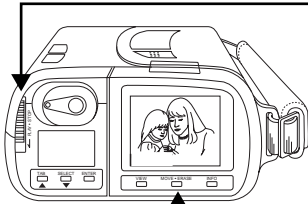

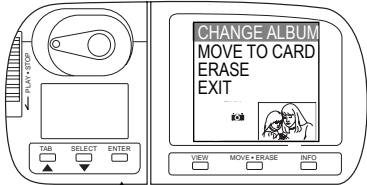

 Scroll through the pictures by pressing the TelePhoto or Wide Angle buttons.
- 2** Press the MOVE-ERASE button.

The MOVE-ERASE display appears with CHANGE ALBUM highlighted. The MOVE TO CARD option is grayed out if a card is not inserted in the camera.

- 3** Press the ENTER button.

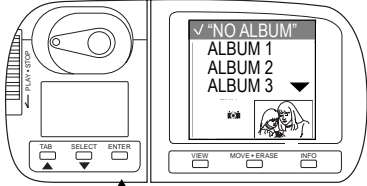
A display appears with NO ALBUM highlighted.

- 4** Press the TAB or SELECT button until the correct album is highlighted.

 If necessary, press the TelePhoto or Wide Angle buttons until the correct picture appears in the bottom right-hand corner.
- 5** Press the ENTER button.





The picture is moved into the identified album.

To Exit: Press the SELECT button until the EXIT option is highlighted and then press the ENTER button. To return to a picture display screen, press the VIEW button.

Moving Pictures to a Kodak Picture Card

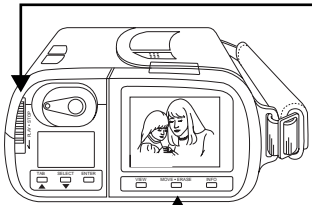
Selecting the MOVE TO CARD option on the MOVE-ERASE display allows you to move a single or all pictures from the camera's memory onto the optional Kodak Picture Card and **erases** the picture from the camera's memory.

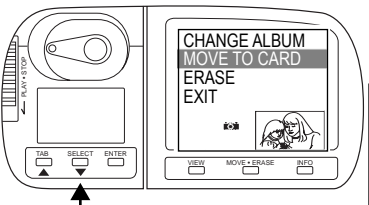
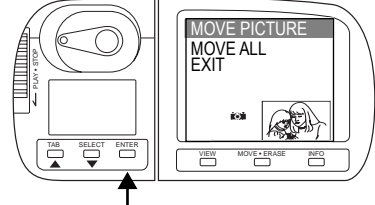
 A Kodak Picture Card must be inserted to use the MOVE TO CARD option.

-  Press the PLAY-STOP switch.
The LCD displays the last picture taken.

-  Scroll through the pictures by pressing the TelePhoto or Wide Angle buttons.

- Press the MOVE-ERASE button.
The MOVE-ERASE display appears with CHANGE ALBUM highlighted
- Press the SELECT button until MOVE TO CARD is highlighted.
- Press the ENTER button.
A display appears with MOVE PICTURE highlighted.

- Press the SELECT button until the correct move option is highlighted.
 The MOVE ALL option moves all the pictures. Pictures within albums are moved with their assigned album.
- Press the ENTER button.
The MOVING PICTURE display appears and the card icon blinks on the Status Display while the picture is moved.

A message appears if the move could not be completed because all the pictures would not fit on the optional Kodak Picture Card.

To Exit: Press SELECT until the EXIT option is highlighted and then press the ENTER button. To return to a picture display screen, press the VIEW button.

Erasing Pictures from the DC120 or Kodak Picture Card

The ERASE display allows you to erase individual or all pictures from the DC120's memory or the optional Kodak Picture Card.

 The camera does not have to be turned on to use the PLAY-STOP option. You cannot take a picture when PLAY-STOP is on.

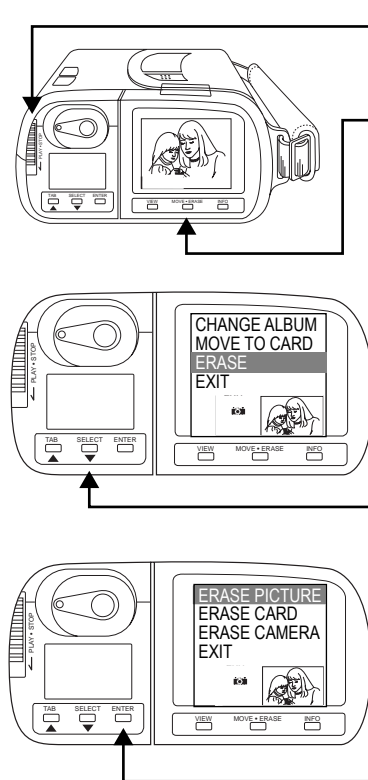

- 1 Press the PLAY-STOP switch.
The LCD displays the last picture taken.
- 2 Press the MOVE-ERASE button.
The MOVE-ERASE display appears with CHANGE ALBUM highlighted.
- 3 Press the SELECT button until ERASE is highlighted.
- 4 Press the ENTER button.
A display appears with ERASE PICTURE highlighted.
- 5 Press the SELECT button until the correct erase option is highlighted,
- 6 Press the ENTER button.
 If necessary, press the TelePhoto or Wide Angle buttons until the correct picture appears in the bottom right-hand corner.
The ERASING PICTURE display appears while the picture is erased. Empty albums are also erased.

If erasing the entire camera or card, a display appears asking you to verify that all the pictures should be erased. Press the SELECT button until the appropriate response is highlighted, then press the ENTER button.

To Exit: Press the SELECT button until the EXIT option is highlighted and then press the ENTER button. To return to a picture display screen, press the VIEW button.

INFO

Selecting the INFO button displays information about the currently selected picture on the LCD.

- ☞ The camera does not have to be turned on to use the PLAY-STOP option. You cannot take a picture when PLAY-STOP is on.

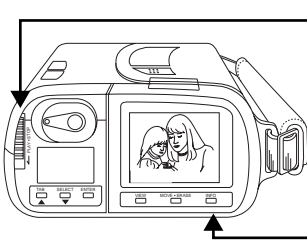

- 1 Press the PLAY-STOP switch.

The LCD displays the last picture taken.

- ☞ Scroll through the pictures by pressing the TelePhoto or Wide Angle buttons.

- 2 Press the INFO button.

The INFO display appears.

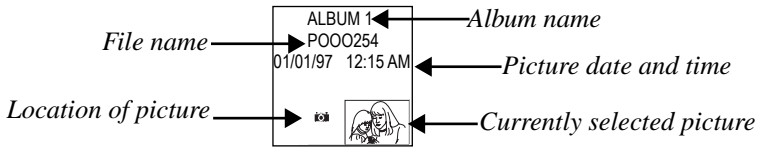

To Exit: Press the INFO or VIEW button to return to the PLAY-STOP LCD screen. Press the MOVE-ERASE button to open the MOVE-ERASE screen.

Adjusting LCD Brightness

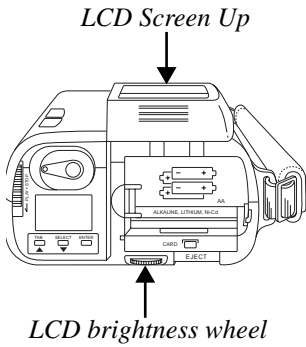

You may adjust the brightness of the LCD by turning the brightness wheel located at the bottom of the DC120.

Automatic LCD Turn Off

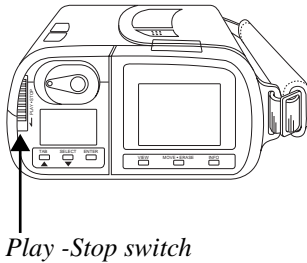

To save battery power, the LCD display automatically turns off after 60 seconds.

To turn the LCD on again, press the PLAY-STOP switch.

 When using an AC adaptor, the LCD display automatically turns off after 20 minutes.

Zoom

The DC120 comes equipped with a Wide Angle (38 mm) to TelePhoto (39 to 114 mm) lens.

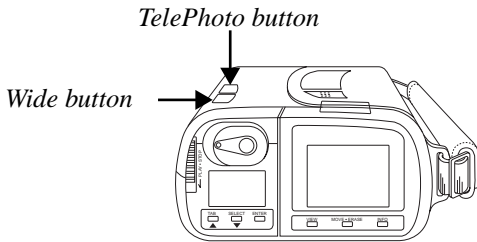

The subject will appear closer or farther away when you look through the viewfinder and press the appropriate button.

 The TelePhoto or Wide Angle buttons are also used to scroll through the pictures displayed on the LCD.

The camera's default lens position is Wide Angle. All other lens positions are considered TelePhoto settings.

Automatic Power Off

If you are not using an AC Power Adaptor and your DC120 is idle for approximately 60 seconds, it automatically turns off. To turn the camera on again, press any button on the camera. You may change the power off time using the TWAIN/Plug-In Access Software. See Chapter 6 - [TWAIN/Plug-In Access Software](#) for more information.

Optional Accessories

The following optional DC120 accessories are available from your Kodak dealer.

- ✓ Universal AC Adaptor, 8 VDC supply for use with Kodak digital cameras
- ✓ *Kodak Digital Science* Picture Card
- ✓ Flash Sync Cable for *Kodak Digital Science* DC120 Zoom Digital Camera

AC Adaptor

An AC adaptor allows you to connect your DC120 to a standard electrical outlet. This is especially useful when you are transferring pictures into your computer. The adaptor powers the camera, but does not charge the batteries.

WARNING: Only use the AC adaptor designed for the DC120. Use of any other adaptor can cause camera failure, fire, electric shock, or injury.

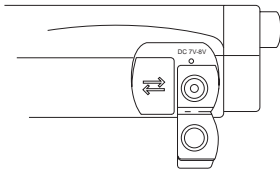

Insert the AC adaptor into the AC power adaptor connection on the side of your DC120.

Kodak Picture Card

You can take and store more pictures on the DC120 by purchasing a removable ATA compatible Kodak Picture Card. The card meets all CompactFlash association requirements. The 2 MB memory card can hold approximately 13 additional pictures at the better Picture Quality setting.

Album names longer than eight characters are shortened when viewed through a DOS file system. For example, an album named Winter 1 is viewed as Winte ~1.

 Memory cards containing compression or stacker software do not work with the camera until they are reformatted. Refer to the card's user's manual for reformatting information.

WARNING: Do not insert or eject a Kodak Picture Card when the Ready light is blinking, or when using the Move or Erase features. This may damage your pictures or camera.

To insert a Kodak Picture Card:

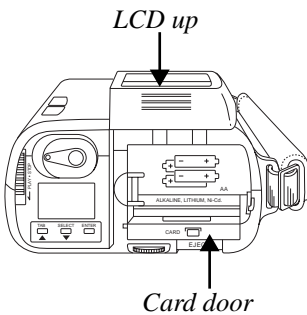

- 1 Flip-up the LCD screen.
- 2 Open the card door.

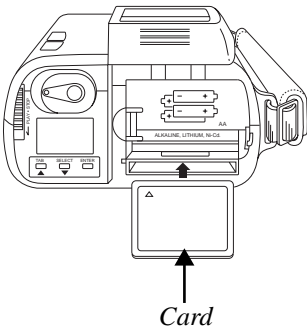

- 3 Hold the Kodak Picture Card face up, with the connecting end pointed at the camera.
- 4 Push the card all of the way into the card slot.
- 5 Close the card door.
- 6 Flip-down the LCD screen.

To remove a Kodak Picture Card

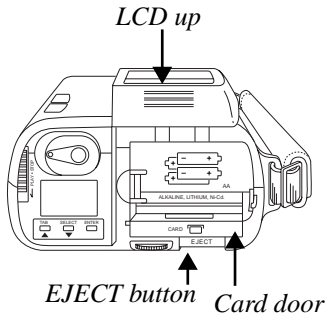

- 1 Flip-up the LCD screen.
- 2 Open the card door.
- 3 Press the EJECT button.

The card partially slides out of the slot.

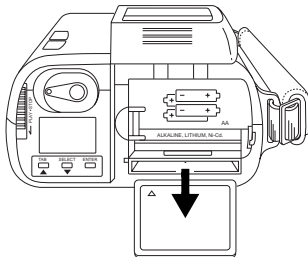

- 4 Take hold of the card and carefully remove it from the slot.
- 5 Close the card door.
- 6 Flip-down the LCD screen.

General Maintenance and Safety

- ✓ To keep from damaging your DC120, avoid exposing it to moisture and extreme temperatures.
- ✓ Clean the outside of the DC120 by wiping it with a clean, dry cloth. Never use harsh or abrasive cleaners or organic solvents on the camera or any of its parts.
- ✓ Never disassemble or touch the inside of the DC120. This could result in electrical shock.
- ✓ If you notice smoke or a strange smell coming from the DC120, immediately turn the camera off, wait a few minutes until the DC120 cools, then remove the batteries.

Cleaning the Lens

- 1 Blow gently on the lens to remove dust and dirt.
 - 2 Moisten the lens by breathing lightly on it.
 - 3 Wipe the lens gently with a soft, lint-free cloth or an untreated lens-cleaning tissue.
-  Do not use cleaning solutions unless they are designed specifically for camera lenses. Do not wipe the camera lens with chemically treated eyeglass lens tissue as it may scratch the lens.

DC120 Specifications

| | |
|---|---|
| Picture Resolution —1.2 million pixels | Lens —autofocus optical quality glass |
| CCD Resolution —836,400 pixels | Focus Distance —2.3 ft. (0.7 m) to infinity |
| Storage —2 MB internal | 3X Zoom Lens —38 to 114 mm Equivalent for 35mm camera Actual focal length is 7 to 21mm |
| Color —24-bit, millions of colors | Aperture —wide: f/2.5 to f/16 tele: f3.8 to f24 |
| Sensitivity —ASA/ISO rating equivalent to 160 | Shutter Speed —1/500 to 16 sec |
| Flash —effective range wide: 2.3 to 16.4 ft. (0.7 to 5 m) tele: 2.3 to 10.8 ft. (0.7 to 3.3 m) | Viewfinder —Zooming Optical |
| Tripod Socket —1/4 in. | Weight —1.15 lb. (520 g) without batteries |
| Power — 4 AA batteries | Dimensions —5.7 X 4.3 X 2.2 in. (146 X 108 X 55 mm) |
| Close Up —0.7 to 1.6 ft. (0.2 to 0.5 m) | |



Using DC120 with Your Computer

Connecting the DC120 to Your Computer

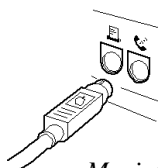

Macintosh

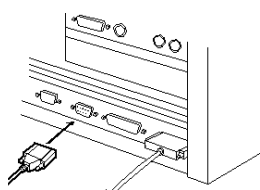

PC

- 1 Plug one end of the serial cable into the printer or modem port (on a Macintosh) or a COM port (on a PC) on the back of your computer.

 If your computer has a 25-pin port, you need to purchase a 9-pin adapter and attach it to the port before attaching the serial cable to the computer.

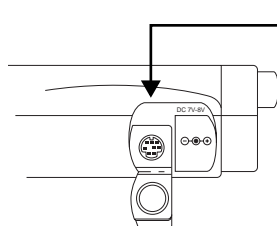

- 2 Pull down the rubber tab on the camera.

- 3 Plug the other end of the serial cable into the camera's serial port.

- 4 Turn on the camera.

If you have already installed the software included with the DC120, you are now ready to transfer the pictures from the camera to your computer using the appropriate software packages.

Refer to the appropriate chapters of this user's guide, or the software's quick setup guides in the back cover of this user's guide, for more information on the software packages.

Checking Serial Port Availability

If your computer cannot communicate with the DC120, you may need to adjust the serial port configuration on the computer. To verify that there are no serial port conflicts with other items on your computer, refer to the serial communication or corresponding section of your computer's or operating system's (Windows, Macintosh) user's guide.

 Additional technical information is available in the [Technical Tips Trouble.text](#) document located in the DC120 folder.

Windows

If your computer does not recognize that the DC120 is attached and turned on, and you are running Windows 95 or 3.1, you may need to adjust the serial port and speed settings.

Each software included on the DC120 CD has an option to adjust the serial port and speed. Refer to the software chapters for further details or complete the following steps to adjust the settings using the Kodak Picture Transfer Application Software (Picture Transfer).

- 1 Connect the DC120 to your computer and turn it on.
- 2 Open Picture Transfer software.
- 3 Click the Preferences button. 
- 4 Select DC120 from the Camera Type field.
- 5 Select COM1 (or the port you have connected the camera to) from the Port field.
- 6 Adjust Speed up or down by one setting.
- 7 Click Accept.
- 8 Click the Get Selected Pictures from the Camera button.

 If the software does not recognize the DC120, continue to adjust the serial port speed on COM1, and the other COM ports until it is recognized.

Once your computer can communicate with your camera, gradually increase speed to optimize transfer picture time.

Macintosh

If running software on a Macintosh computer or PowerBook, you may need to:

- ✓ turn off or disable AppleTalk, Express Modem, GlobalFax, and any loaded Speed RAM Doublers.
- ✓ specify an external or normal modem.
- ✓ run Extensions Manager on minimal if running Systems 7.5 or higher.

Monitor Adjustment

Your monitor display settings may need to be adjusted to view pictures from the DC120 camera.

Windows 95

- 1 Double-click on the My Computer icon.
- 2 Double-click on the Control Panel icon.
- 3 Double-click on the Display icon and click on the Settings tab.
- 4 From the Color Palette field, select the highest available setting {256, High (16-bit), or True (32-bit) color} and click the OK button.

Windows 3.1

Refer to the user's guide of your computer's video driver card or its manufacturer.

Macintosh

- 1 From the Apple icon, select the Control Panel folder.
- 2 Double-click on the Monitors icon.
- 3 From the Settings of Selected Monitor field, select the highest available color setting (256, Thousands, or Millions).

 To display pictures from the DC120, the minimum recommended setting is 256 colors. If you are not satisfied with the quality of the picture displayed after adjusting the monitor and/or you do not have a setting higher than 256, you may wish to upgrade your video display card and/or monitor. Contact your computer dealer for more information.

Printing

You may notice that the colors on your computer screen do not always match those in your documents or prints. This is because monitors and printers use different color systems.

Tips

You may be able to achieve more predictable results in your printed documents by:

- ✓ improving the quality of your paper. Copier paper may not offer the same results as coated paper or paper made especially for ink jet printers.
- ✓ adjusting your printer software settings.
- ✓ using fresh ink cartridges. Do not use ink cartridges beyond their life expectancy.

 If you need extreme precision in matching printed output to your computer screen, you may want to consider purchasing a calibration system. The aim of a calibration system is to match, as close as possible, the printed image to the image on your computer screen. Please consult your local computer dealer for more information.

Remember these few tips when it comes time to print your document.

- ✓ color printing takes more time.
- ✓ the more complex your document is increases the printing and drying time.
- ✓ color printing is more memory intensive than black and white. If your computer gives you an insufficient memory message, you may need to close some applications, change some settings, or add additional memory.
- ✓ color prints may not photocopy as clearly as black and white. If you plan to photocopy documents, you may consider printing the document in gray scale. This setting is usually changed from the print menu.
- ✓ resizing the picture to a smaller size or printing the picture on glossy paper may increase the quality of the print.

To improve the quality of your prints, you may want to print your pictures on Kodak Inkjet Snapshot Paper. Snapshot Paper is made to work with most inkjet printers to give you clearer, crisper, and more detailed images on your prints.



Installation Software

Kodak Digital Science DC120 Zoom Digital Camera Installation Software (Installation software) quickly and easily installs the software included on the DC120 CD to your computer. Customize your installation using one of the following install options:

- ✓ **Typical or Easy**—installs all software programs included on the CD.
- ✓ **Custom**—installs only the software that you select from the CD.

Software included on the CD

- ✓ **PictureWorks PhotoEnhancer**—fix, modify, or enhance your pictures using PhotoEnhancer software. Use Kodak DC120 Digital Access software to transfer pictures into PhotoEnhancer.
- ✓ **Kodak DC120 Digital Access**—transfer pictures from your camera or computer to TWAIN-compliant or Plug-In compatible software applications such as PhotoEnhancer or Adobe PhotoShop.
- ✓ **Kodak Picture Transfer Application**—download pictures quickly and easily from the camera or your computer in one of several standard file formats.
- ✓ **Kodak DC120 Mounter**—view and copy DC120 picture files (.KDC format) to your computer. Mounter software treats the DC120 and optional Kodak Picture Card as a read-only disk drive. You must have Windows 95 to use this application.

☞ You will not be able to work simultaneously in Digital Access (TWAIN), Picture Transfer Application, or Mounter software.

System Requirements

Windows

- ✓ Personal computer with 486/33MHz microprocessor minimum or Pentium Processor
- ✓ Windows 3.1 software or later, MS-DOS 6.0 or later, or Microsoft Windows 95
- ✓ 8 MB or more of RAM available, 12 MB recommended
- ✓ available serial port and CD-ROM drive

Macintosh

- ✓ Power PC, Centris, Quadra, Performa, or other systems with a 68020 processor or better
- ✓ System 7.1 or later
- ✓ 8 MB or more of RAM available, 16 MB recommended
- ✓ available serial port and CD-ROM drive

Installing the Software

While the Installation software is automatically loading your software, take a few minutes to fill out and send in the DC120 product registration card. This allows you to receive information regarding software updates and registers all the products included with the DC120 camera.

Windows

Close all other applications before starting the Installation software.

- 1 Place the DC120 CD into your CD-ROM drive.
 -  If Auto Run is turned on in Windows 95, the first install window automatically appears. Proceed to step 4.
- 2 Do one of the following:
 - ✓ **Windows 3.1**—choose RUN from the FILE pulldown menu.
 - ✓ **Windows 95**—choose RUN from the START menu.
- 3 Type the path to the drive that contains the CD and then the word “setup”.
 For example: *d:\setup*



The Kodak DC120 Software Install window appears.

- 4 Select your language.

The Welcome window appears.

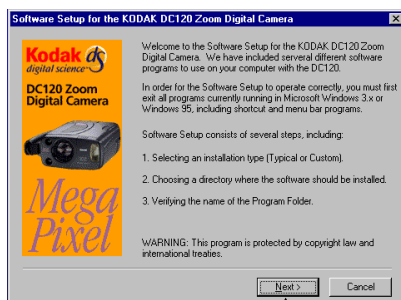

- 5 Click the Next button.

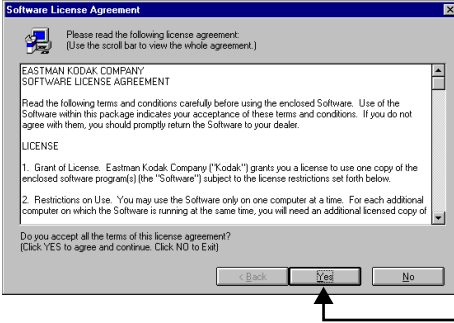

6 Read the agreement and click the Yes button to accept the software license agreement.

☞ If you do not accept the license you will not be able to install the software.



7 Select installation option:

- ✓ **Typical**—installs all software programs included on the CD.
- ✓ **Custom**—installs only the software that you select from the CD.

☞ If you select the Custom option, a software selection window appears and you are prompted to select which software should be installed.

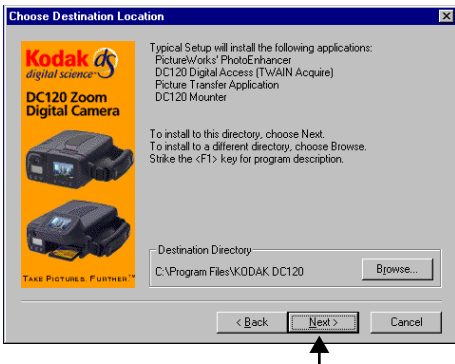

8 Verify the name of the directory where the software should be installed on your computer and click the Next button.

☞ If necessary, change the name of the directory by clicking the Browse button.

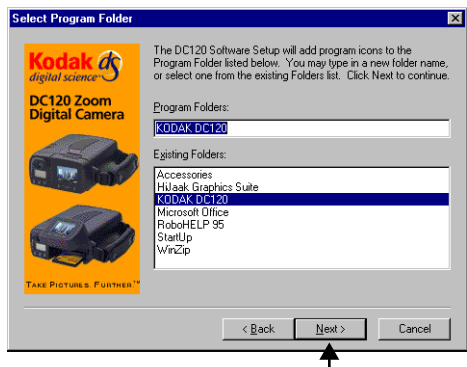

- 9 Verify the name of the Program Folder and click the Next button.

☞ If necessary, type a new folder name or select from the Existing Folders list.

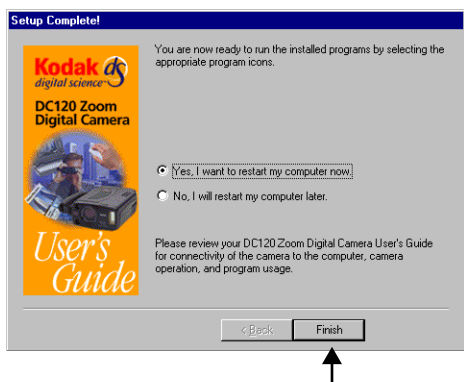

A progress screen appears while the software is installed. It takes approximately two minutes to install all the software on most systems.

- 10 Select the restart option and click the Finish button.

☞ If you have installed the Kodak DC120 Mounter software you must restart your computer.

You are now ready to run the newly installed software. See the following chapters for detailed instructions on the software.

When using DC120 software, if your computer does not recognize that the camera is attached and turned on, you may need to adjust the serial port and speed settings. Use the software's Preferences or Properties window to adjust the camera communications settings.

Macintosh

Close all other applications before starting the Installation software.



- 1 Place the DC120 CD into your CD-ROM drive.
The DC120 Software Installer icon appears on your desktop.
- 2 Double-click on the DC120 Software Installer icon.
The DC120 Installation Software window appears.
- 3 Click the Continue button.

The Software License Agreement appears.

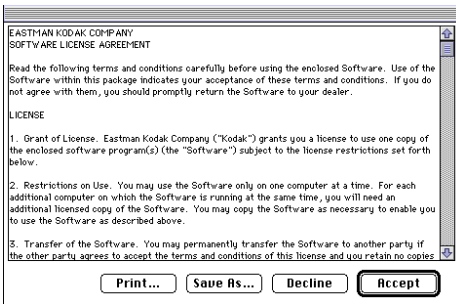

- 4 Read the agreement and click the Accept button to accept the software license agreement.

 If you do not accept the license you will not be able to install the software.

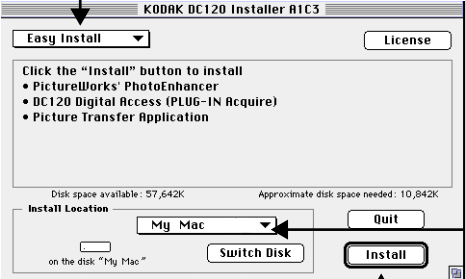
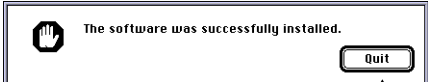
- 5** Select installation option:
- ✓ **Easy**—installs all software programs included on the CD.
 - ✓ **Custom**—installs only the software that you select from the CD.
- ☞ If you select the Custom option, a software selection window appears and you are prompted to select which software should be installed.
- 
- 6** Verify the name of the directory where the software should be installed on your computer.
- ☞ If necessary, change the name of the folder by clicking on the arrow in the Install Location box.
- 7** Click the Install button.
- A progress screen momentarily appears. It takes approximately two minutes to install the software on most systems.*
- 
- 8** Click the Quit button.

You are now ready to run the newly installed software by selecting the icons from your computer's Program Folder. See the following chapters for detailed instructions on the software.



Picture Transfer Application

Kodak Picture Transfer Application (Picture Transfer) software provides an easy way to manage pictures that are stored in the memory of your DC120 camera or optional Kodak Picture Card using your computer. You can do the following with Picture Transfer software:

- ✓ transfer pictures from the memory of the camera or the optional Kodak Picture Card to your computer
- ✓ move pictures between folders on your computer
- ✓ convert pictures to other file formats

Picture Transfer software for Windows and Macintosh uses the same screens except for minor differences specific to the platform. The screens displayed in this chapter are from Picture Transfer software for Windows 95.

Installation

If you selected the Typical or Easy installation option when you installed the software from the DC120 CD (see Chapter 4 - *Installer Software*), Picture Transfer software will already be installed. If it is not installed, complete the installation instructions in Chapter 4 and select the Picture Transfer option.

Camera Communication Settings

If your computer does not recognize that the camera is attached and turned on, you may need to adjust the serial port and speed settings. See “Preferences Settings” on page 5- 6 or Chapter 3 - *Using DC120 with Your Computer* for details.

Starting Picture Transfer Application

Windows 95 - from the Start menu select Programs, open the KODAK DC120 group and select the Picture Transfer Software.

Windows 3.1 - from the Program Manager, double-click on the Kodak Picture Transfer icon.

Macintosh - from the KODAK DC120 folder, double-click on the Kodak Picture Transfer icon.

Overview

The Picture Transfer main window lets you select Preferences for your computer, identify picture file destination, and create image files in any of the supported formats:

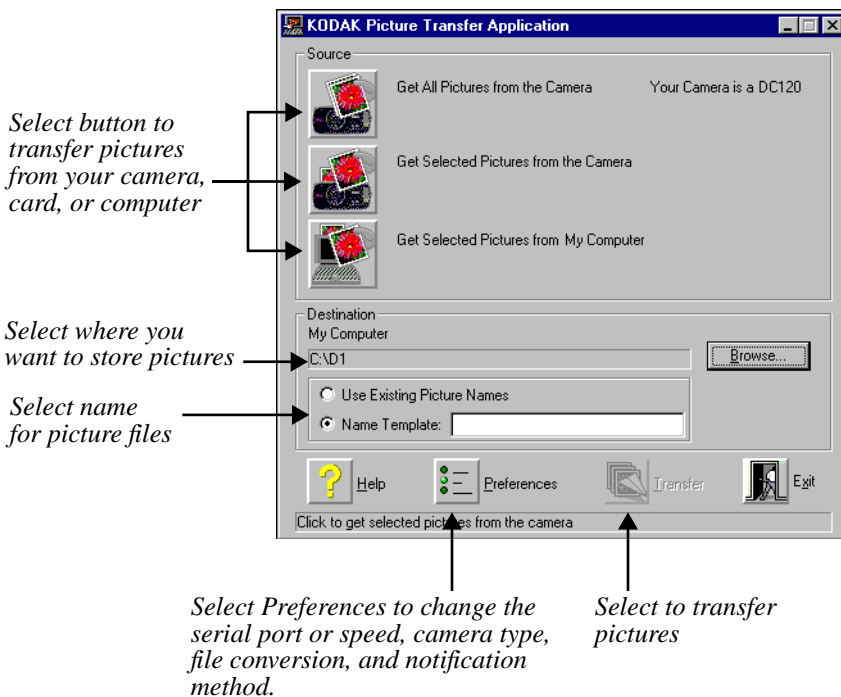

Transferring Pictures from DC120

You have the option of transferring all the pictures in the camera or transferring individual pictures from your camera to the computer.

When using Picture Transfer software, you cannot take pictures with the camera. The camera needs to be connected to your computer and turned on to access your picture files on the camera. The Status Display is replaced by the following screen

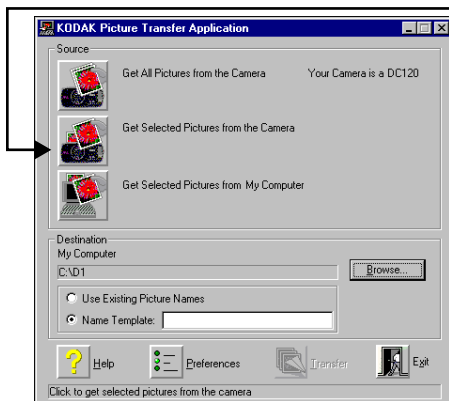

- 1 Click the Get Selected Pictures from the Camera button.

☞ You may also select:

- ✓ Get all Pictures from the Camera
- ✓ Get Selected Pictures from My Computer

The Picture Selection window appears.

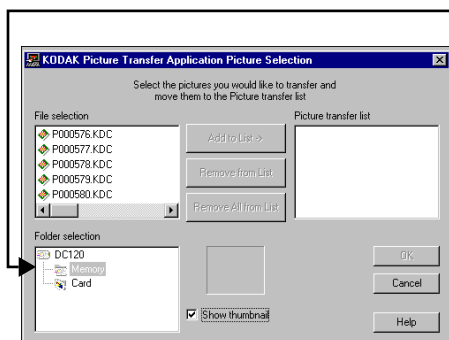

- 2 Select the folder where the pictures reside:

- ✓ memory of your camera
- ✓ optional Kodak Picture Card

☞ Check Show thumbnail to preview the picture file.

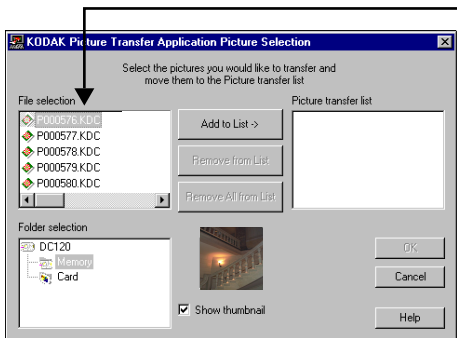

3 Select the picture file from the File Selection area.

The picture file is highlighted. If Show thumbnail is checked a preview of the picture appears.

 You can also select albums which may contain multiple files.

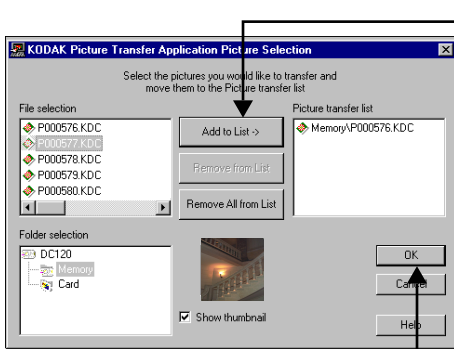

4 Click the Add to List button.

The picture file is listed in the transfer window.

 You may also select:

- ✓ Remove from List to remove a highlighted picture file from the Picture Transfer List
- ✓ Remove All from List to remove all the picture files from the Picture Transfer List

5 Click the OK button.

The main Picture Transfer window appears.

6 Verify the name of the folder where picture files should be transferred.

Click the Browse button to select or create a new folder on your computer.

7 Select the file naming format by clicking one of the following:

- ✓ Use Existing Picture Names
- ✓ Name Template and enter a new file name. The appropriate file extension and picture number will be automatically added to the file name.

If necessary, change the file conversion format using the Preferences window. See “Preferences Settings” on page 5- 6 for more information.

8 Click the Transfer button.

The Progress window appears.

Picture Transfer software allows you to work in other applications while the pictures are transferred. You are notified of transfer progress, completion, or error messages according to the options selected on the Preferences window.

Preferences Settings



The Preferences window is used to set camera communications, serial port and speed, and file conversion information. It also allows you to customize progress window options and notification options.

To change Preferences settings:

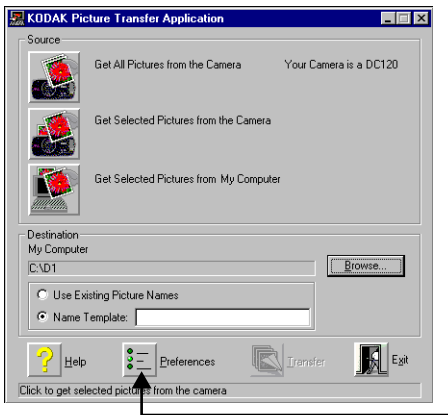

1 Click the Preferences button.

The Preferences window appears.

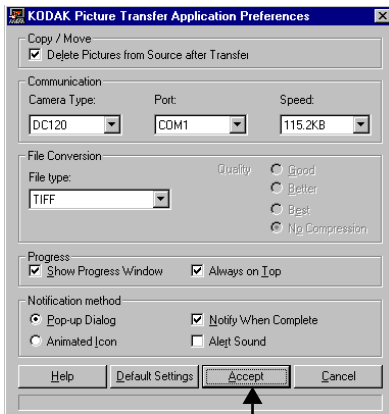

2 Select appropriate options.

 See following field descriptions for detailed information on options.

3 Click the Accept button.

The Picture Transfer main window appears.

Field Descriptions

Copy/Move—check “Delete Pictures from Source after Transfer” to erase the original pictures from the camera or computer after they are transferred.

Communication—adjust camera type, port, and port speed if your computer does not recognize that the camera is attached and turned on.

 To decrease the amount of time it takes to transfer a picture file, increase the port speed. The port speed of 230400 is only available on PCs or Macintosh PowerPCs with high-speed serial cards.

File Conversion—select the file format from the File type list. You may select:

- ✓ Native KDC format
- ✓ BMP (Bitmap, Windows only)
- ✓ TIFF (Tagged Image File Format)
- ✓ JPEG (Joint Photographic Experts Group)
- ✓ FPX (FlashPix, Windows 95 and Macintosh PowerPC only)
- ✓ PICT (Macintosh only)

 If you select JPEG or FPX select a Quality setting for the picture. The final Quality setting you select for JPEG or FPX is based on the camera’s Picture Quality setting when the picture was taken.

Progress—check an option for displaying the progress transfer dialog box. You can select:

- ✓ **Show Progress Window** to display transfer progress messages for the entire time the pictures are being transferred. If this option is not checked, the progress messages dialog box is not shown.
- ✓ **Always on Top (Windows only)** to display transfer progress messages as the top window for the entire time the pictures are being transferred.

Notification method—select how you want to be notified when the transfer is complete or an error occurs.

You can select:

- ✓ **Pop-up Dialog**
- ✓ **Animated Icon**
- ✓ **Notify When Complete** displays the Transfer Complete dialog box after all the pictures have been transferred to your computer.
- ✓ **Alert Sound** produces a sound when the transfer is complete or if an error occurs.



TWAIN & Plug-in Access Software

Kodak DC120 Digital Access Software (Access software), (TWAIN Acquire software for Windows and the Plug-in software for Macintosh), is a special industry-standard “language” that allows the DC120 camera to transfer pictures from your camera directly to your favorite TWAIN compliant or Plug-in compatible software, such as Adobe Photoshop.

No matter which software you choose, Access software allows you to preview, rotate, or enhance your pictures before they are transferred. It also allows you to adjust the camera’s picture quality, flash, sleep timeout and self-timer delay settings, and erase pictures from the DC120 while it is connected to your computer.

Access software for Windows and Macintosh uses the same screens except for minor differences specific to the platform. The screens displayed in this chapter are from Access software for Windows 95.

Installation

If you selected the Typical or Easy installation option when you installed the software from the DC120 CD (see Chapter 4 - *Installer Software*), Access software will already be installed. If it is not installed, complete the installation instructions in Chapter 4 and select the Access software option.

Camera Communication Settings

If your computer does not recognize that the camera is attached and turned on, you may need to adjust the serial port and speed settings. See “Changing Connection Setup” on page 6- 9 or Chapter 3 - *Using DC120 with Your Computer* for details.

Starting Access Software

Windows

- 1** Connect the DC120 camera to your computer.
See the “Connecting the DC120 to Your Computer” section in Chapter 3 - Using DC120 with Your Computer.
- 2** Open a TWAIN compliant software (for example, PhotoEnhancer software).
- 3** Pull down the File menu and select TWAIN Source.
- 4** Select Kodak DC120 Digital Access.
- 5** Pull down the File menu and select TWAIN Acquire.
The Access software main window appears.

Macintosh

- 1** Connect the DC120 camera to your computer.
See the “Connecting the DC120 to Your Computer” section in Chapter 3 - Using DC120 with Your Computer.
- 2** Open a Plug-in compatible software (for example, PhotoEnhancer software).
- 3** Pull down the File menu and select Acquire.
- 4** Select Kodak DC120 Digital Access.
The Access software main window appears.

Overview

The following is the main window of Access software. More detailed information is offered in the following sections.

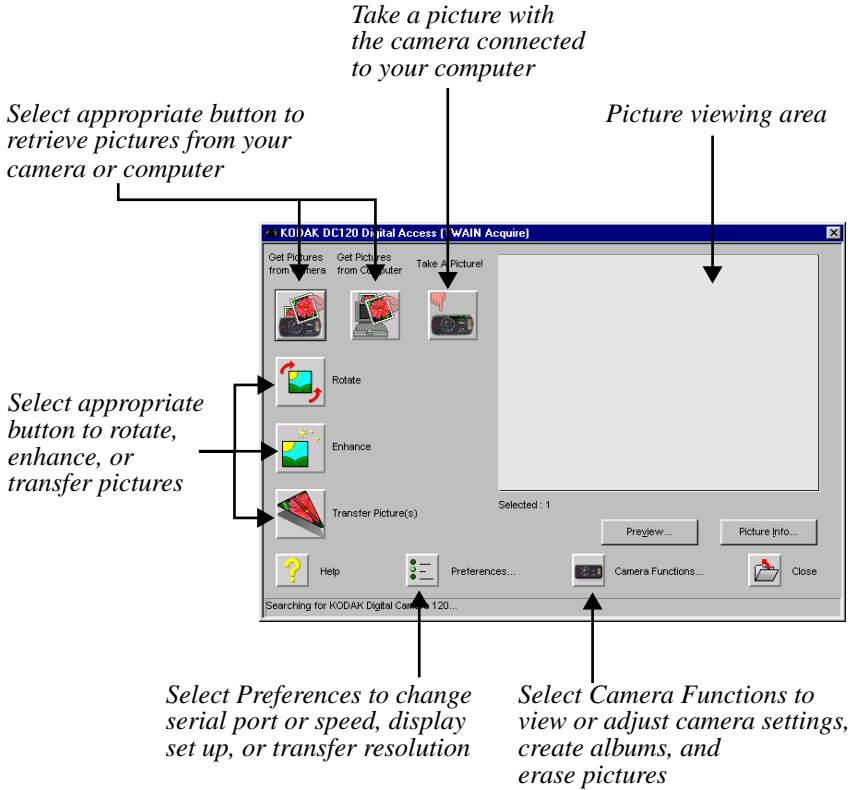

Transferring Pictures from DC120

☞ The DC120 needs to be turned on and connected to your computer to access pictures from the camera.

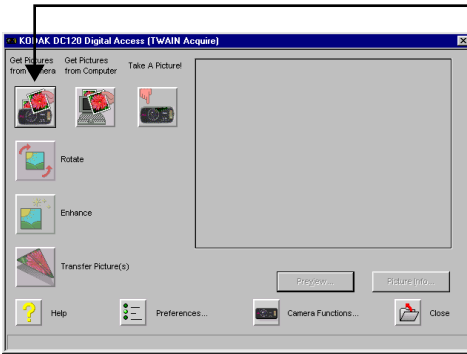

1 Click the Get Pictures from Camera button.

- ☞ You may also select:
- ✓ Get Pictures from Computer to transfer picture from a .KDC file
 - ✓ Take a Picture to use the camera when it is attached to the computer

The Get Camera Pictures window appears.

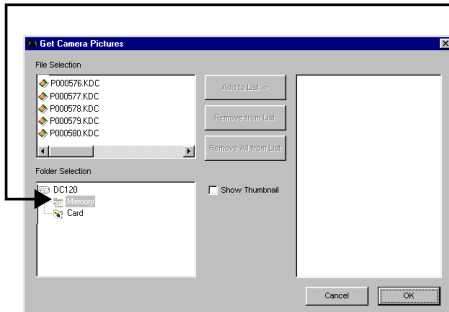

2 Select the folder where the pictures reside:

- ✓ memory of your camera
- ✓ optional Kodak Picture Card

☞ Check Show Thumbnail to preview the picture file.

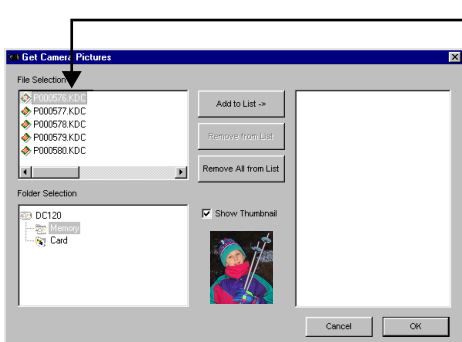

3 Select the picture file from the File Selection area.

The picture file is highlighted. If Show Thumbnail is checked a preview of the picture appears.

☞ To select multiple files at one time, hold down the control or shift key and click on the picture files.

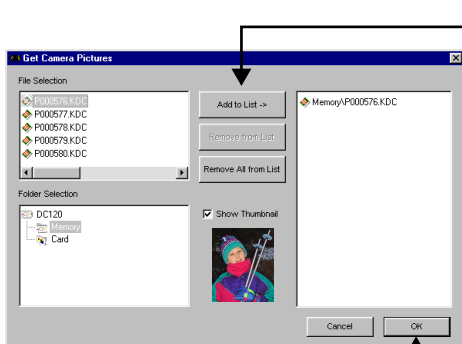

4 Click the Add to List button.

The picture file is listed in the transfer window.

☞ You may also select:

- ✓ Remove from List to remove a highlighted picture file from the Picture Transfer List
- ✓ Remove All from List to remove all the picture files from the Picture Transfer List

5 Click the OK button.

A progress window momentarily appears.

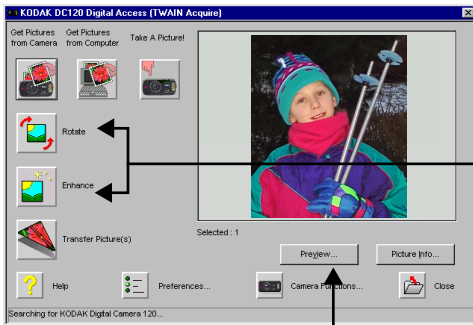

- 6 If necessary, select the Rotate or Enhance buttons to adjust the picture.

See “Rotating Your Picture” on page 6- 7 and “Enhancing Your Picture” on page 6- 8 for more information.

➡ To preview a picture click the Preview button.

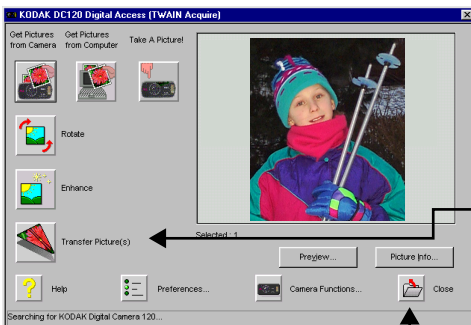

- 7 Click the Transfer Pictures button.

A window appears showing the progress and picture(s) being transferred.

- 8 Click the Close button to exit Access software.

The open TWAIN compliant or Plug-in compatible software window displays your picture.

Picture Information

The Picture Info button displays information about the picture and camera settings when the picture was taken. You may not select or change any settings on the window.

To display picture information:

Click the Picture Info button.

The Picture Information window appears and displays:

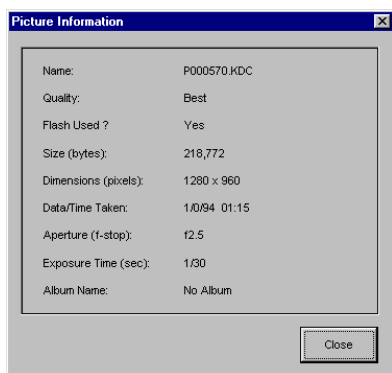

- ✓ Picture file and Album name
- ✓ Quality setting
- ✓ Flash information
- ✓ Size (in bytes) and dimensions (in pixels)
- ✓ Date and time picture was taken
- ✓ Aperture information
- ✓ Exposure time, in seconds

Rotating Your Picture



The Rotate button allows you to rotate your picture 90 to 180 degrees.

To rotate your picture:

- 1 Click the Rotate button.

The Rotate window appears.

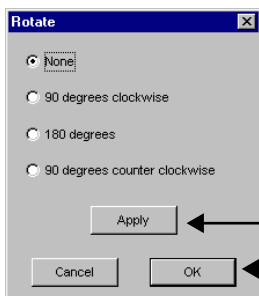

- 2 Click the appropriate rotate option.

- 3 Click the Apply button.

The rotate option is applied to your picture. If necessary, select another rotate option. until your picture is correct.

- 4 Click the OK button.

Enhancing Your Picture



The Enhance button corrects the color or lighting balance of your picture.

To enhance your picture:

- 1 Click the Enhance button.

The Enhance window appears.

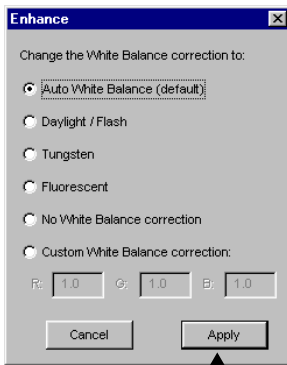

- 2 Select the appropriate enhance option that best matches the lighting conditions when you took the picture:

- ✓ Auto White Balance
- ✓ Daylight/Flash
- ✓ Tungsten—use this option to improve pictures taken under warm, incandescent, or candle light
- ✓ Fluorescent lighting—use this option if your picture has a green cast
- ✓ No White balance correction
- ✓ Custom White Balance correction—enter the balance values for red (R), green (G), or blue (B)

- 3 Click the Apply button.

The enhancements are applied to your picture.

Preferences Settings



The Preferences window allows you to change connection setup, display setup, and transfer resolution settings.

 You must press the Apply button to activate any changes to the Preferences window.

Changing Connection Setup

If your computer does not recognize that the camera is attached and turned on, adjust the serial port and speed setting using the Connection Setup tab.

To Change Connection Setup:

- 1 Click the Preferences button.

The Preferences window appears.

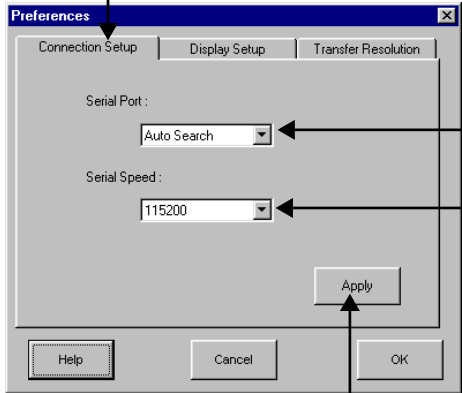

- 2 Click the Connection Setup tab.
- 3 Select appropriate serial port setting.
- 4 Adjust the serial speed to optimize picture transfer time.
- 5 Click the Apply button.

 The port speed of 230400 is only available on PCs or Macintosh PowerPCs with high-speed serial cards.

Changing Display Setup

You may customize your computer monitor setup using the Display Setup tab.

To change the Display Setup:

- 1 Click the Preferences button.

The Preferences window appears.

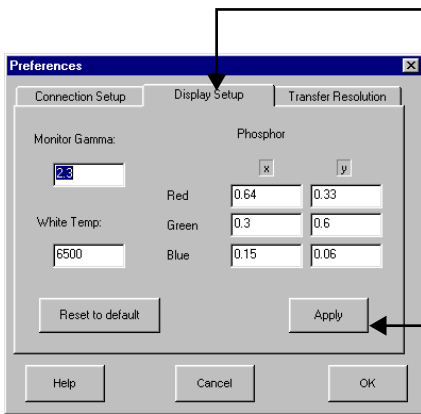

- 2 Click the Display Setup tab.

- 3 Adjust your monitor setup by changing the settings for:

- ✓ Monitor gamma
- ✓ White temperature
- ✓ Phosphor (red, green, blue) color values

- 4 Click the Apply button.

- ☞ Click the **Reset to default** button to return to the default settings.

Changing Transfer Resolution

The Transfer Resolution tab allows adjustment of the picture's resolution to preset settings (in pixels) during the transfer process.

To change the Transfer Resolution:

- 1 Click the Preferences button.

The Preferences window appears.

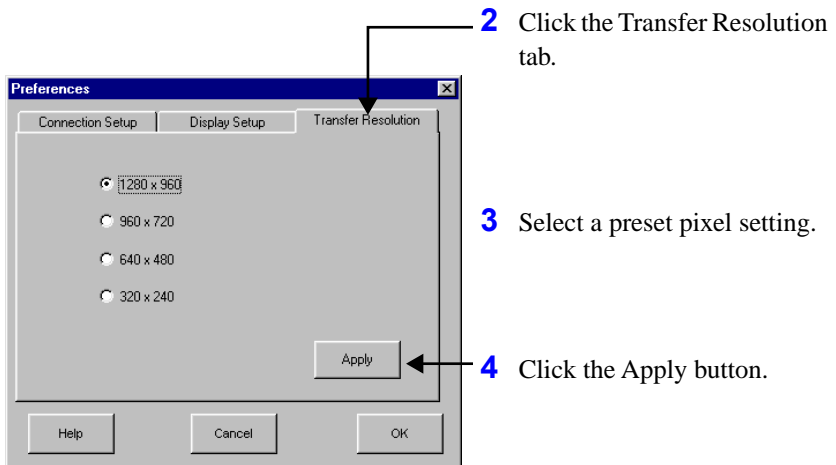

Camera Functions



The Camera Functions window allows you to review or reset camera settings from the Status LCD Function Setup or Other Camera Function Setup tabs while the DC120 is attached to your computer. You may also personalize albums using the Album Setup tab and erase pictures.

Changing LCD Settings

The Status LCD Function Setup allow you to set all the settings that are normally set using the Status Display on the camera.

To change the LCD settings:

- 1 Click the Camera Functions button.

The Camera Functions window appears.

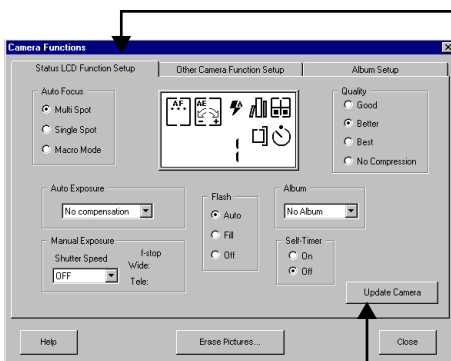

- 2 Click the Status LCD Function Setup tab.

- 3 If necessary, change the camera's settings.

 See “Status Display” on page 2-3 for more information on camera settings.

- 4 Click the Update Camera to apply changes.

Changing Camera Functions

The Other Camera Function Setup allows you to reset a limited number of camera settings.

To change the Camera Function settings:

- 1 Click the Camera Functions button.

The Camera Functions window appears

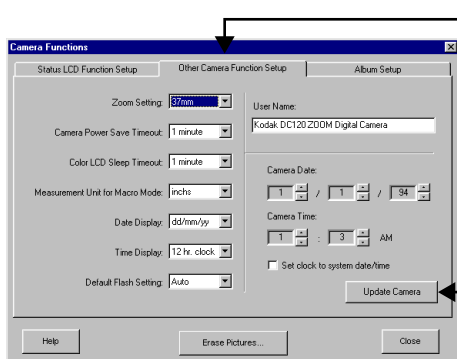

- 2 Click the Other Camera Function Setup tab.

- 3 If necessary, change camera's settings.

 See Chapter 2 - *Using Your DC120 Camera* for more information.

- 4 Click the Update Camera button to apply changes.

Album Setup

The Album Setup tab allows you to personalize album names in the camera.

To personalize an album:

- 1 Click the Camera Functions button.

The Camera Functions window appears.

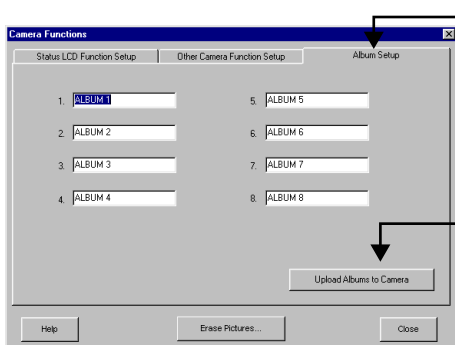

- 2 Click the Album Setup tab.

- 3 Personalize an album by placing the cursor in appropriate space and enter the new name.

- 4 Click the Upload Albums to Camera button.

Album names are updated in the camera.

Erasing Pictures

The Erase Pictures button on the Camera Functions window allows you to delete pictures from the camera's or optional Kodak Picture Card's memory.

To erase pictures:

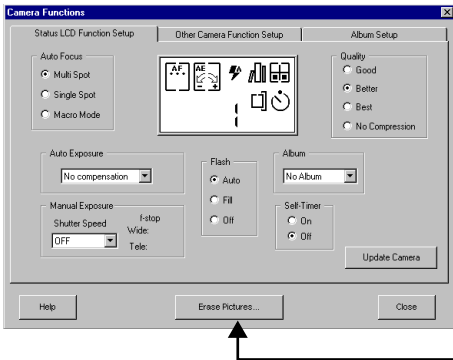

- 1 Click the Erase Pictures button.

The Erase Pictures window appears.

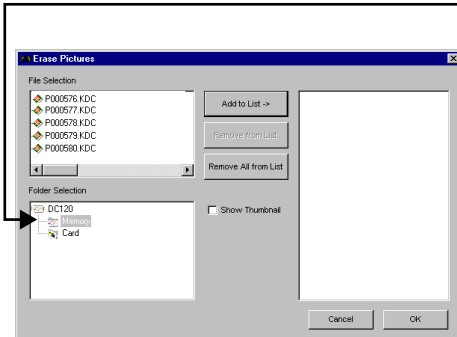

- 2 Select the folder where the pictures reside:

- ✓ memory of your camera
- ✓ optional Kodak Picture Card

 Check Show Thumbnail to preview the picture file.

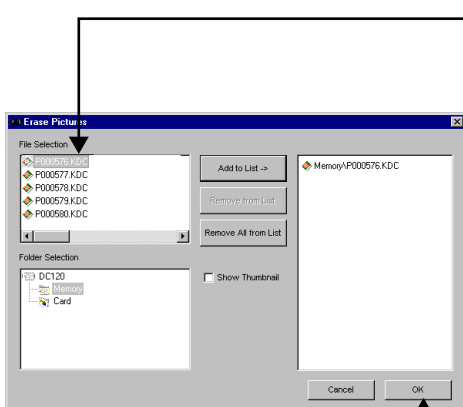

3 Select the picture file from the File Selection area.

The picture file is highlighted. If Show Thumbnail is checked a preview of the picture appears.

 To select multiple files at one time, hold down the control or shift key and click on the picture files.

4 Click the Add to List button.

The picture file is listed in the erase window.

 You may also select:

- ✓ Remove from List to remove a highlighted picture file from the Erase Picture List
- ✓ Remove All from List to remove all the picture files from the Erase Picture List

5 Click the OK button.

The picture file is erased from the camera's or card's memory.



PhotoEnhancer Software

With PictureWorks PhotoEnhancer software (PhotoEnhancer) you can view, edit, and enhance your digital pictures quickly and easily. Use the By Example enhancement feature to display your picture as different enhancing options are applied to it. Use SmartPix for one-step correction for lighting, focus, or color balance in your pictures. Pictures are transferred from your DC120 into PhotoEnhancer software using Access software (TWAIN Acquire or Plug-in Software). This version of PhotoEnhancer software will also work with the following Kodak digital cameras: DC20, DC25, DC40, and DC50.

PhotoEnhancer software for Windows and Macintosh use the same screens except for minor differences specific to the platform. The screens displayed in this chapter are from PhotoEnhancer software for Windows 95.

Installation

If you selected the Typical or Easy installation option when you installed the software from the DC120 CD (see Chapter 4 - [Installer Software](#)), PhotoEnhancer software will already be installed. If it is not installed, complete the installation instructions in Chapter 4 and select the PhotoEnhancer software option.

Starting PhotoEnhancer

Windows 95—from the Start menu select Programs, open the Kodak DC120 group and select PictureWorks PhotoEnhancer Software.

Windows 3.1—from the Program Manager, double-click on the PhotoEnhancer icon.

Macintosh—from the Kodak DC120 folder, double-click on the PhotoEnhancer icon.

Overview

Main menu bar

Name of picture file

Picture viewing area

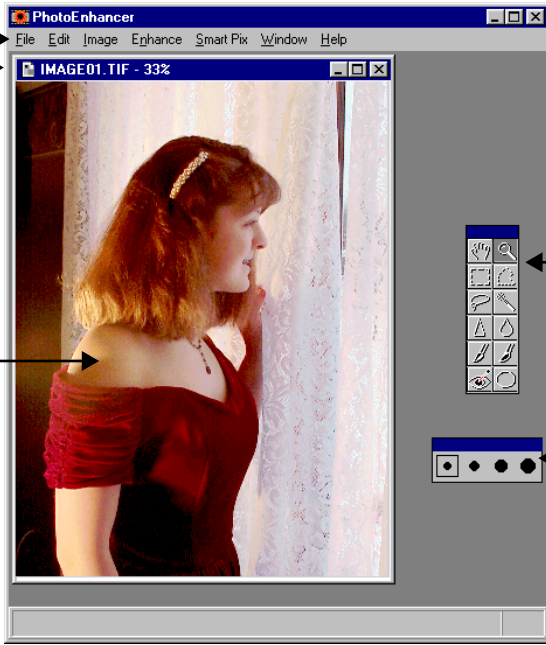

Tool palette

Brush box

Transferring Pictures into PhotoEnhancer

You must use the Access software (TWAIN Acquire or Plug-in Software) to transfer pictures from your camera into PhotoEnhancer software.

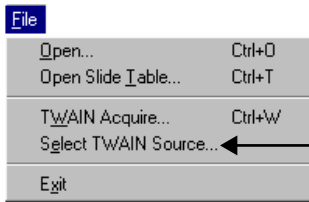

- 1** Click on File and select Select TWAIN Source from the pulldown menu.

The Select Source window appears

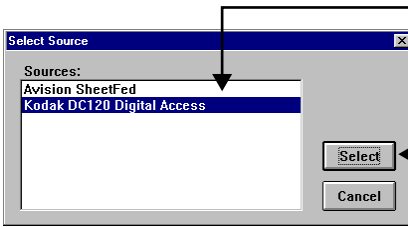

- 2** Select Kodak DC120 Digital Access from the Select Source window.

- 3** Click the Select button.

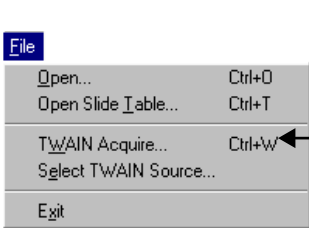

- 4** Click on File and select TWAIN Acquire from pulldown menu.

The main window of the Access software (TWAIN Acquire or Plug-in Software) appears.

- 5** Use the Access software to transfer pictures from your camera into PhotoEnhancer.

See Chapter 6 - TWAIN & Plug-in Access Software for more information.

Once pictures are transferred into PhotoEnhancer software you may edit, enhance, save and print them.

 You can also open pictures from files on your computer. Simply select Open from the File pulldown menu, and select the picture file from the appropriate location on your computer. Select Open Slide Table to view a table of several pictures files, from which you would double-click on a file to open it.

Editing Tools

PhotoEnhancer's editing Tool Palette automatically appears when the software is opened. Once you have opened your picture into PhotoEnhancer, use the selection tools and brushes, along with the editing options from the main menu bar, to edit your pictures.

Hand—scrolls through a picture.

Rectangle—makes a rectangular selection.

Lasso—makes freehand selection.

Sharpen—focuses area of picture using a brush.

Lighten—lightens area of picture using a brush.

Red Eye—corrects area of picture for red eye using a brush.

 The Brush Box automatically appears when using the Sharpen, Smooth, Lighten, Darken, and Red Eye tools.

Tool Palette

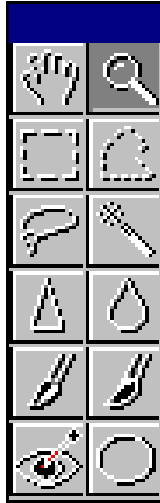

Zoom—magnifies. To resize select the File menu's Image, View option (or on PCs press the mouse buttons).

Polygon—makes irregular straight-sided selection.

Magic Wand—selects areas by similar color.

Smooth—softens area of picture using a brush.

Darken—darkens area of picture using a brush.

Oval—makes a circular or an oval selection.

Brush Box



To use the tool palette:

- 1 Click on a tool to select it.
- 2 Place the cursor on the part of the picture that you want to select or brush.
- 3 Click and drag the mouse to complete your selection or brush stroke.
- 4 Release the mouse button.
- 5 Use the:
 - ✓ **Edit** pulldown menu to undo, cut, copy, or paste a selected area.
 - ✓ **Image** pulldown menu to resize, flip, rotate, or crop a selected area.

Enhancing Your Picture

PhotoEnhancer allows you to enhance your picture two ways. The Enhance pulldown menu options allows you to adjust your picture automatically in one easy step. Use By Example to see how your picture changes before the enhancements are applied.

Enhancing in One Step



- 1 Open a picture file.
- 2 Click on Enhance and select the appropriate enhancement option from the pulldown menu.

Your picture adjusts according to your selection.

The Adjust options include:

- ✓ Negate to apply a photographic negative effect to your picture.
- ✓ Lightening or darkening your picture.
- ✓ Equalize to distribute the brightness values evenly across your picture and to increase the contrast.

You may also choose to soften, sharpen, intensify, or lighten shadows a little or a lot.

Enhancing by Example

Enhance



- 1 Open a picture file.
- 2 Click on Enhance and select By Example from the pulldown menu.

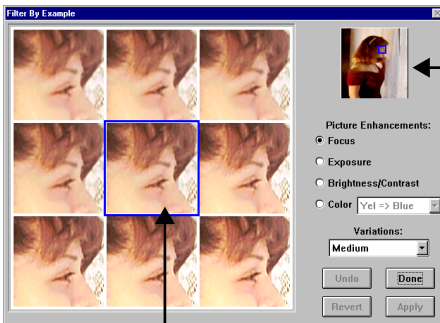

The Filter By Example window appears with a reduced version of the original picture in the upper right corner. The blue square controls the part of the picture that appears in the nine sample boxes. Drag the blue square in the reduced version to view the different areas of the picture.

The middle sample box corresponds to the current picture setting.

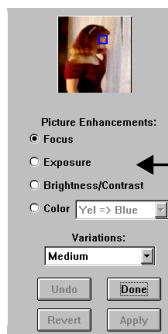

- 3 Click on the appropriate Picture Enhancement option:
 - ✓ Focus to sharpen.
 - ✓ Exposure to adjust lightness or darkness.
 - ✓ Brightness/Contrast to adjust the tones.
 - ✓ Color to adjust the color balance.
 - ✓ Variations to adjust the amount of enhancement.

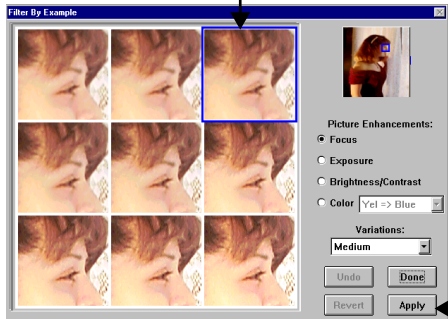

4 View the pictures in the sample box and click on the one you like best.

5 Click the Apply button.

The enhancement selected from the sample is applied to the entire picture.

The sample boxes show the applied enhancement in various degrees.

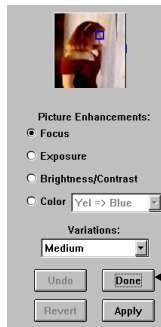

6 Experiment with the different enhancement options to find the best one for improving your picture.

 Click the Undo button to delete the last change applied to the picture and Revert to return the picture to its original state.

7 Click the Done button to exit By Example and keep changes.

Correcting for Lighting Conditions

Use SmartPix to improve pictures taken in specific lighting conditions.



- 1 Open a picture file.
- 2 Click on SmartPix and select the appropriate option from the pull-down menu.
- 3 Select the lighting condition in which your picture was taken.

Your picture adjusts to compensate for a specific lighting condition.

 You can also adjust for faded colors, light or heavy shadows, or remove dot patterns.

Optimize For indicates that the SmartPix values were set for the DC120 camera. Optimize For also supports other Kodak devices.

Experiment with the different SmartPix options to find the best one for improving your picture.

 You can also apply SmartPix to multiple pictures at the same time from a slide table. Simply hold down the shift key and click the slides you want to enhance, then select a SmartPix option.

Saving Your Pictures

Save your enhanced pictures by selecting Save or Save As from the File pull-down menu.

Printing Your Pictures

Print your enhanced pictures by selecting Print from the File pull-down menu. Use SmartPrint from the File pull-down menu to print a representative area of your picture several times on one page. This allows you to view how different printer settings affect your print. You would then select the best one for your picture.



Mounter Software

Kodak DC120 Mounter software (Mounter software) is an easy way to manage pictures stored in the camera's or optional Kodak Picture Card's memory using your PC computer and Windows 95 software.

You can view or transfer picture files to different locations on your computer using the My Computer or Explorer window options. The My Computer icon allows you to display and copy your files from your desktop. The Explorer window provides access to all your files through an explorer shell. For more detailed information on working with files through the My Computer or Explorer window options, refer to your Windows 95 software user's guide.

Installation

If you selected the Typical installation option when you installed the software from the DC120 CD (see Chapter 4 - [Installation Software](#)), Mounter software will already be installed. If it is not installed, complete the installation instructions in Chapter 4 and select the Mounter software option.

Camera Communication Settings

If your computer does not recognize that the camera is attached and turned on, you may need to adjust the serial port and speed settings. See "Serial Port" on page 8- 9 or Chapter 3 - [Setting up Computer](#), for details.

Overview

Mounter software uses the following icons:



Camera icon—displays the DC120 Camera.



Camera Memory icon—displays picture files or albums stored in the DC120 camera.



Memory Card icon—displays picture files or albums stored in the optional Kodak Picture Card.



Do **NOT** delete the album.ctl file on the optional Kodak Picture Card.



Album icon—displays picture files stored in an album.



Picture File icon—displays picture files with .KDC extensions.

Transferring Pictures from DC120

When using Mounter software, you cannot take pictures with the camera. The camera needs to be connected to your computer and turned on to access your picture files. The Status Display on the camera is replaced by the following screen.



- 1 Double-click on the My Computer icon.

 To open Mounter software from the Explorer window, select Programs from the Start menu and then select Windows Explorer.

My Computer window

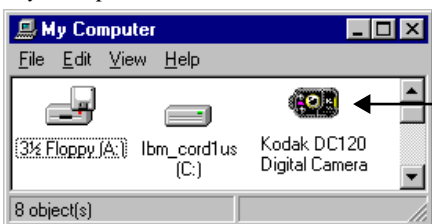

The My Computer or Explorer window appears.

- 2 Double-click on the Kodak DC120 Digital Camera icon.

Exploring - Kodak DC120 window

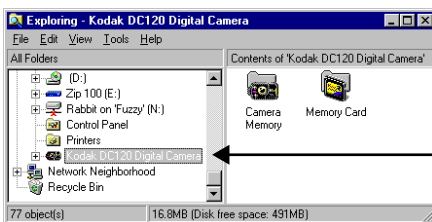

The Camera Memory icon appears either in a separate window when using My Computer or on the split screen when using Explorer. A Memory Card icon also appears if an optional Kodak Picture Card is inserted in the camera.

- 3 Double-click on the Camera Memory or Memory Card icon.

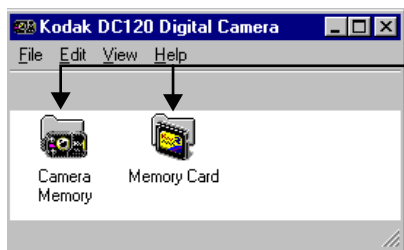

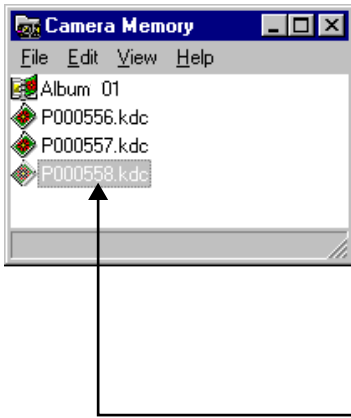

The Camera Memory window appears. Album icons and individual picture files appear.

- ☞ Double-click on an album to open it. Double-click on a picture file to open it into a registered application.

To change the way files are displayed, use the commands listed on the View menu.

- 4 Select a picture file (or album) to highlight it and hold the mouse button down.

Camera Memory window

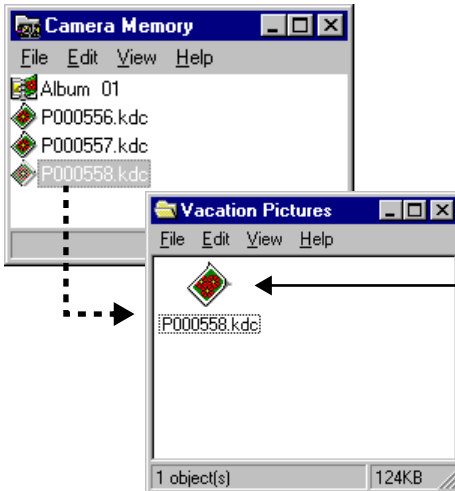

- ☞ Make sure the location where you want to drag the picture file into is visible.

- 5 Drag the picture file to where you want it positioned and then release the mouse button.

The picture file is copied to the new location.

Picture file is copied to new location on computer

- ☞ To select multiple pictures, hold down the shift key and click on additional files.

Mounter software does not allow you to copy picture files or albums **into** the camera's or optional Kodak Picture Card's memory. You can only copy picture files from the camera's or card's memory into your computer.

Setting and Viewing Properties

Mounter software displays camera, serial port, picture, or album information from the Properties window of the following icons:

- ✓ Camera Memory
- ✓ Memory Card
- ✓ Picture File
- ✓ Album
- ✓ Camera

Camera Memory  or Memory Card  Properties

The General Info tab on the Camera or Camera Card Memory Properties window displays the current setting of the camera's or optional memory card's memory. You cannot change settings on this window.

 You must have an optional Kodak Picture Card inserted to view the Camera Card Memory Properties window.

To open the Camera Memory Properties window:

- 1 Click on the Camera Memory icon with the right mouse button.
- 2 Select Properties from the popup menu.

The Camera Memory Properties window appears and displays:

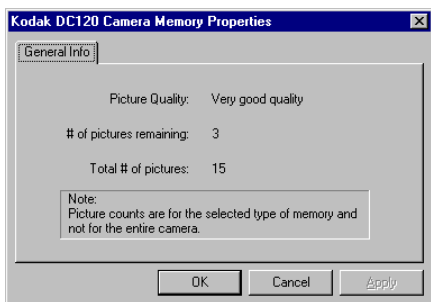

- ✓ Picture Quality setting of camera
- ✓ Number of pictures remaining that can be stored in the memory of your camera
- ✓ Number of pictures stored in the memory of your camera

Picture File Properties



The General Info tab on the Picture File Properties window displays information about the current picture file. You cannot change any settings on this window.

To open the Picture File Properties window:

- 1 Click on the Picture File icon with the right mouse button.
- 2 Select Properties from the popup menu.

The Picture File Properties window appears and displays:



- ✓ Picture Quality setting of the picture file
- ✓ Picture Size in bytes
- ✓ Date and time the picture was taken
- ✓ Name of the picture file

Album Properties



The General Info tab on the Camera Album Properties window displays information on the current album. You cannot change any settings from this window.

To open the Camera Album Properties window:

- 1 Click on the Album icon with the right mouse button.
- 2 Select Properties from the popup menu.

The Camera Album Properties window appears and displays:

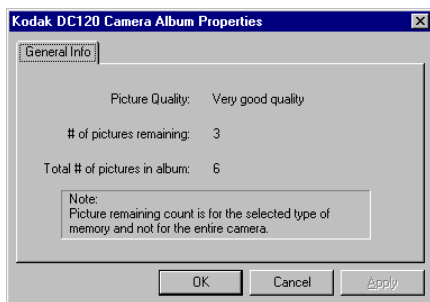

- ✓ Picture Quality Setting of the album
- ✓ Number of pictures remaining that can be stored in the album
- ✓ Number of pictures stored in the album

Camera Properties



The Camera Properties window displays general information on the camera and serial port settings.

General Information Tab

The General Info tab on the Camera Properties window allows you to view the camera's current settings. You cannot change any settings from this window.

To open the General Information window:

- 1 Click on the Camera icon with the right mouse button.
- 2 Select Camera Properties from the popup menu.

The Camera Properties window appears.

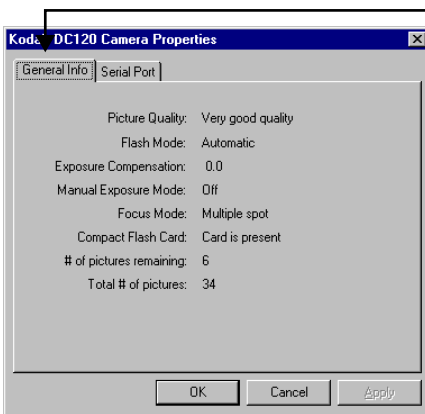

- 3 Click the General Info tab.

The General Info tab displays:

- ✓ Picture Quality and Flash setting
- ✓ Auto and Manual Exposure Mode setting
- ✓ Focus Mode
- ✓ Whether an optional Kodak Picture Card is inserted
- ✓ Number of pictures remaining that can be stored in the camera's or optional Kodak Picture Card's memory
- ✓ Number of pictures taken and stored in the camera's or optional Kodak Picture Card's memory

Serial Port

The Serial Port tab on the Camera Properties window allows you to view and change the serial port and port speed settings while the camera is attached to your computer.

See the “Checking Serial Port Availability” section in Chapter 3 - *Using DC120 with Your Computer* for more detailed information.

To open the Serial Port window:

- 1 Click on the Camera icon with the right mouse button.
- 2 Select Camera Properties from the popup menu.

The Camera Properties window appears.

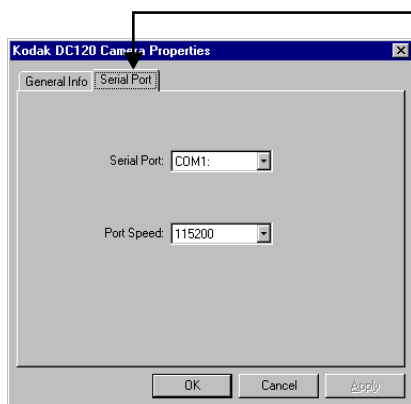

- 3 Click the Serial Port tab.

The Serial Port Tab appears.

- 4 If necessary adjust the:
 - ✓ serial port if your computer does not recognize the camera
 - ✓ port speed to optimize picture transfer time

☞ The port speed of 230400 is only available on PCs or Macintosh PowerPCs with high-speed serial cards.



Troubleshooting

If you are experiencing difficulties with your DC120 camera, check the following table for possible solutions. If the difficulties persist, refer to Chapter 10 - *Where to Get Help*.

 Additional technical information is available in the Technical Tips Trouble.text document located in the DC120 or KODAK DC120 folder.

| Computer Monitor | | |
|--|---------------------------------------|---|
| Problem | Cause | Solution |
| The image on your monitor is jagged or inappropriately colored. | Monitor is not set correctly. | Adjust your monitor display settings. See the “Monitor Adjustment” section in Chapter 3 - <i>Using DC120 with Your Computer</i> . |
| Windows/DC120 Camera Communications | | |
| Problem | Cause | Solution |
| Open slide table in software indicates the wrong number of pictures or zero pictures stored in the camera. | Possibly a serial port speed problem. | Lower the port speed by one setting using the Preferences window in Picture Transfer or Access (TWAIN Acquire) software, or the Camera Properties window in Mounter software. |

| Windows/DC120 Camera Communications | | |
|---|---|---|
| Problem | Cause | Solution |
| Camera does not respond after selecting camera options from the software. | Some Advanced Power Management utilities on laptops can turn off ports to save battery life. | See the Power Management section of your laptop's user guide to disable this feature. |
| | Conflict with another serial device, such as a modem. | Refer to the serial communication or corresponding section of your computer's, modem, and/or operating system's (Windows 95 or Windows 3.1) user's guide. |
| | Camera power is off. | Slide the cover open to turn the camera on. |
| | Camera is not connected to serial cable or cable is not connected to the computer's COM port. | Connect serial cable to camera and COM port. See the "Connecting the DC120 to Your Computer" section in Chapter 3 - <i>Using DC120 with Your Computer.</i> |
| | Port settings in software's Acquire-Preferences may be set to the incorrect COM port. | Change the COM port settings to Auto-Search or to a specific COM port using the Preferences window in Picture Transfer or Access (TWAIN Acquire) software, or the Camera Properties window in Mounter software. |

| Macintosh/DC120 Camera Communications | | |
|---|--|--|
| Problem | Cause | Solution |
| Camera does not respond after selecting camera options from the software. | Camera power is off. | Slide the cover open to turn the camera on. |
| | Camera is not connected to serial cable or cable is not connected to the computer's serial port. | Connect serial cable to camera and serial port. See the "Connecting DC120 to Your Computer" section in Chapter 3 - <i>Using DC120 with Your Computer</i> . |
| | AppleTalk is conflicting with serial port communications. | Disable AppleTalk. |
| | Modem or fax software is conflicting with serial port communications. | Turn off or disable Express Modem, GlobalFax, and any speed doublers. |
| | Extensions may be conflicting with serial port communications. | Run Extensions Manager on minimal if running 7.1 systems or higher. |

| DC120 Camera | | |
|--|---|---|
| Problem | Cause | Solution |
| Ready light does not turn on and the camera does not work. | Batteries are low or empty. | Replace the batteries. Pictures remain in the camera's memory when the battery is removed. |
| | Camera is not turned on. | Turn the camera on and verify that the green Ready light turns on. |
| Shutter button does not work. | Camera is not turned on. | Turn the camera on and verify that the green Ready light turns on. |
| | Ready light is blinking. Camera is processing picture. | Wait until Ready light stops blinking before attempting to take another picture. |
| | The Status Display reads FUL . The camera memory or optional Picture Card is full. | Transfer pictures to your computer and erase them from the camera's memory. |
| | Camera is connected to the computer. | Disconnect camera from computer. |
| Camera does not turn on. | Batteries are not properly installed. | Remove the batteries and install them according to the directions on the outside of the battery door. |
| Part of the picture is missing. | Something was blocking the lens when the picture was taken. | Keep hands, fingers, or other objects away from the lens when taking pictures. |
| | Your eye or the picture was not centered correctly in the viewfinder | Leave space around subject when centering picture in viewfinder. |

| DC120 Camera | | |
|--|--|---|
| Problem | Cause | Solution |
| Picture is too dark. | Flash is not on or did not go off. | Turn on the flash. See the “Flash” section in Chapter 2 - <i>Using Your DC120</i> . |
| | The subject is too far away for the flash to have an effect. | Move so there is no more than 16.4 feet (5 m) between the camera and the subject. |
| | The subject is in front of a bright light. | Change your position so the light is not behind the subject. |
| Picture is too light. | The flash is not needed. | Change to automatic flash. See the “Flash” section in Chapter 2 - <i>Using Your DC120</i> . |
| | The subject is too close when the flash was used. | Move so there is at least 2.3 feet (0.7 m) between the camera and the subject. |
| | The light sensor is covered. | Hold the camera so your hands or other objects do not cover the light sensor. |
| Stored pictures are damaged. | The memory card was inserted or removed when the Ready light was blinking. | Make sure the Ready light is not blinking before inserting or removing the memory card. |
| Pictures remaining number does not decrease. | The image resolution does not take up sufficient space to decrease the picture remaining number. | Continue taking pictures. |

| DC120 Camera | | |
|---|--|--|
| Problem | Cause | Solution |
| Picture is not clear. | The lens is dirty. | Clean the lens. See the “Cleaning the Lens” section in Chapter 2 - Using Your DC120 . |
| | Subject too close when taking picture | Stand at least 8 in. away when taking pictures using Macro mode. |
| | Subject or the camera moved while the picture was taken. | Hold camera steady until you the picture is taken. |
| | The subject is too far away for the flash to be effective. | Move so the subject is less than 16.4 feet (5 m) away. |
| Camera Memory Error appears on the LCD. | | Press the TAB and INFO buttons at the same time to reformat the Camera’s memory. Any picture files stored on the camera are lost. |

| Memory Card | | |
|--|--|--|
| Problem | Cause | Solution |
| The DC120 does not recognize your memory card. | The memory card may not be ATA compatible. | Memory cards must be ATA compatible to work with the DC120 camera. |
| | The memory card may contain compression or stacker software. | Reformat any memory cards that contain compression or stacker software. Refer to the memory card's user's guide for instructions on reformatting the card. |
| Status Display Codes | | |
| Code which appears on the Status Display screen | Cause | Solution |
| 11, 12, 13, or 14 | Indicates a cycle power error. | Turn the camera off. Wait 1 minute, and turn the camera on. If the error code still appears, the camera will need to be serviced. |
| 20 | The flash did not charge within a certain time. | Turn the camera off. Wait 1 minute, and turn the camera on. If the error code still appears, the camera will need to be serviced. |

| Status Display Code | | |
|--|---|---|
| Code which appears on the Status Display screen | Cause | Solution |
| 30 or 31 | A zoom drive position error. | Turn the camera off. Wait 1 minute, and turn the camera on. If the error code still appears, the camera will need to be serviced. |
| 40 | Album error. | Turn the camera off. Wait 1 minute, and turn the camera on. If the error code still appears, the camera will need to be serviced. |
| E50, E51, and E52 | JPEG compression or decompression failed. | If picture file is on a card, try opening picture file using DC120 software on computer. If unable to open picture file using the software turn the camera off. Wait 1 minute, and turn the camera on. If the error code still appears, the camera will need to be serviced. |
| E60 | Card has over 60 albums. | The card may be used but new albums cannot be created on it. |
| E61 | Card has over 1000 images stored. | Picture may be reviewed but new pictures cannot be stored to it. |

| Status Display Code | | |
|--|---|---|
| Code which appears on the Status Display screen | Cause | Solution |
| EAO - AA | Error on the optional memory card. | <p>Turn the camera off. Wait 1 minute, and turn the camera on. If the error code still appears, the memory card will need to be reformatted.</p> <p>If the error code still appears, the camera will need to be serviced.</p> |
| E80 - 8F, E90, E91, EB1 - EB7 | Indicates an error with the camera's internal memory. | <p>Turn the camera off. Wait 1 minute, and turn the camera on. If the error code still appears, press the TAB and INFO buttons at the same time to reformat the Camera's memory.</p> <p>If the error code still appears, the camera will need to be serviced.</p> |
| EFO - FD | System error | <p>Turn the camera off. Wait 1 minute, and turn the camera on. If the error code still appears, the camera will need to be serviced.</p> |



Where to Get Help

Help with your DC120 is available from a number of resources.

- ✓ in *Troubleshooting*, Chapter 9
- ✓ the software's manufacturer
- ✓ product information by fax
- ✓ your place of purchase
- ✓ World Wide Web
- ✓ technical support

Software Help

Help with any **software** packaged with your DC120 can be obtained from the software chapters in this manual, quick set-up guides located in the back pocket of this manual, the software's help screens, or by contacting the manufacturer of that product.

- ✓ **Pictureworks PhotoEnhancer Software**—phone 510-855-2009; fax 510-855-2019; e-mail techsupport@pictureworks.com; America Online PWORKS TS; CompuServe 73661,112; url <http://www.pictureworks.com/>
- ✓ **Kodak DC120 Digital Access** (TWAIN Acquire software for Windows systems and the Adobe Photoshop Plug-in software for Macintosh)—refer to the Customer Support, Faxed Information, or Online Services listing on the following pages.
- ✓ **Kodak Picture Transfer Application**—refer to the Customer Support, Faxed Information, or Online Services listing on the following pages.
- ✓ **Kodak DC120 Mounter**—refer to the Customer Support, Faxed Information, or Online Services listing on the following pages.

Online Services

Contact Kodak via:

World Wide Web—<http://www.kodak.com/GO/DC120/>

America Online—(keyword) KODAK

CompuServe—GO KODAK

Kodak Internet listserv—photo-cd@info.kodak.com; or <ftp.kodak.com>

Faxed Information

Kodak offers automated support for digital imaging products and services. Product information can be faxed to you by calling:

U.S.—1-800-508-1531

Canada—1-800-295-5531

Europe—44-131-458-6962

U.K.—44-0-131-458-6962

Customer Support

If you have questions concerning the operation of TWAIN Acquire or Plug-in software, Kodak Picture Transfer Application, Kodak DC120 Mounter software, or the DC120, you may speak directly to a customer support representative. Have the DC120 connected to your computer, its serial number ready, and be at your computer when you call.

U.S. and Canada—call toll free, 1-888-375-6325, between the hours of 9:00 a.m. and 8:00 p.m. (Eastern Standard Time) Monday through Friday.

Europe—call the Kodak Digital Imaging Support Centre toll free number associated with your location, or U.K. toll line, 44-131-458-6714, between the hours of 09.00 and 17.00 (GMT/CET) Monday through Friday.

Outside the U.S., Canada, and Europe—call the number on the following pages that is associated with your location.

| Country | Help number | Fax |
|----------------|--------------------|-----------------|
| Argentina | 541-808-3218 | |
| Australia | 1-800-674-831 | 61-3-9353-2488 |
| Austria | 0-660-7348 | 44-131-458-6962 |
| Belgium | 0800-72247 | |
| Brazil | 0800-150000 | |
| Chile | 54-1-808-3218 | |
| China–Shanghai | 8621-64720888 | 8621-64726582 |
| China–Beijing | 8610-63471155 | 8610-63475641 |
| Denmark | 80-01-09-24 | 44-131-458-6962 |
| Egypt | 20-2-394-2205 | 20-2-393-1119 |
| France | 0800-90-6281 | 44-131-458-6962 |
| Finland | 0800-117056 | 44-131-458-6962 |
| Germany | 0130-82-54-02 | 44-131-458-6962 |
| Greece | 00800-44125605 | |
| Hong Kong | 852-2564-9777 | 852-2564-9753 |
| Hungary | 36-1-269-71-17 | 36-1-269-71-13 |
| India | 91-22-617-5823 | 91-22-617-6004 |
| Ireland | 1-800-409391 | 44-131-458-6962 |
| Italy | 1678-72-996 | |
| Japan | 81-3-5488-2390 | 81-3-5488-4512 |
| Korea | 82-2-708-5400 | 82-2-708-5500 |
| Latin America | 1-305-267-4735 | 1-305-267-4780 |
| Lebanon | 961-1-883822 | 961-1-881726 |
| Malaysia | 60-3-757-2722 | 60-3-755-5919 |
| Mexico | 52-5-326-3848 | 91-800-36412 |
| Middle East | 971-4-444-910 | 971-4-447-059 |
| Netherlands | 06-0224428 | 44-131-458-6962 |
| New Zealand | 0800-500-135 | 64-9-302-8637 |

| Country | Help number | Fax |
|----------------|--------------------|-----------------|
| Norway | 800-1-1848 | 44-131-458-6962 |
| Philippines | 63-2-810-0331 | 63-2-816-6718 |
| Portugal | 351-1-4149-500 | 351-14194-321 |
| Russia | 7-095-929-9166 | 7-095-929-9170 |
| Singapore | 65-470-9875 | 65-479-8397 |
| South Africa | 27-11-804-2852 | 27-11-804-5013 |
| Spain | 900-98-4485 | 44-131-458-6962 |
| Sweden | 020-793169 | 44-131-458-6962 |
| Switzerland | 155-1034 | 44-131-458-6962 |
| Taiwan | 886-2-893-8210 | 886-2-895-1069 |
| Thailand | 66-2-271-3040 | 66-2-279-5073 |
| Turkey | 90-216-342-3332 | 90-216-343-6743 |
| U.K. | 0800-281487 | |
| Uruguay | 54-1-808-3218 | |



Warranty & Regulatory Information

Warranty Time Period

Kodak warrants the Kodak DC120 camera (excluding the batteries) to be free from malfunctions and defects in both materials and workmanship for one year from the date of purchase.

Warranty Repair Coverage

This warranty will be honored within the geographical location that the product was purchased.

If the equipment does not function properly during the warranty period due to defects in either materials or workmanship, Kodak will, at its option, either repair or replace the equipment without charge, subject to the conditions and limitations stated herein. Such repair service will include all labor as well as any necessary adjustments and/or replacement parts.

If replacement parts are used in making repairs, these parts may be remanufactured, or may contain remanufactured materials. If it is necessary to replace the entire system, it may be replaced with a remanufactured system.

Kodak will also provide telephone assistance during the warranty period.

Limitations

WARRANTY SERVICE WILL NOT BE PROVIDED WITHOUT DATED PROOF OF PURCHASE. PLEASE RETURN THE WARRANTY REGISTRATION CARD WITHIN 30 DAYS OF PURCHASE.

THIS WARRANTY BECOMES NULL AND VOID IF YOU FAIL TO PACK YOUR DC120 CAMERA IN A MANNER CONSISTENT WITH THE ORIGINAL PRODUCT PACKAGING AND DAMAGE OCCURS DURING PRODUCT SHIPMENT.

THIS WARRANTY DOES NOT COVER: CIRCUMSTANCES BEYOND KODAK'S CONTROL; SERVICE OR PARTS TO CORRECT PROBLEMS RESULTING FROM THE USE OF ATTACHMENTS, ACCESSORIES OR ALTERATIONS NOT MARKETED BY KODAK; SERVICE REQUIRED AS THE RESULT OF UNAUTHORIZED MODIFICATIONS OR SERVICE; MISUSE, ABUSE; FAILURE TO FOLLOW KODAK'S OPERATING, MAINTENANCE OR REPACKAGING INSTRUCTIONS; OR FAILURE TO USE ITEMS SUPPLIED BY KODAK (SUCH AS ADAPTERS AND CABLES).

KODAK MAKES NO OTHER WARRANTIES, EXPRESS, IMPLIED, OR OF MERCHANTABILITY OR FITNESS FOR A PARTICULAR PURPOSE FOR THIS EQUIPMENT OR SOFTWARE.

REPAIR OR REPLACEMENT WITHOUT CHARGE ARE KODAK'S ONLY OBLIGATION UNDER THIS WARRANTY. KODAK WILL NOT BE RESPONSIBLE FOR ANY SPECIAL, CONSEQUENTIAL OR INCIDENTAL DAMAGES RESULTING FROM THE PURCHASE, USE, OR IMPROPER FUNCTIONING OF THIS EQUIPMENT REGARDLESS OF THE CAUSE. SUCH DAMAGES FOR WHICH KODAK WILL NOT BE RESPONSIBLE INCLUDE, BUT ARE NOT LIMITED TO, LOSS OF REVENUE OR PROFIT, DOWNTIME COSTS, LOSS OF USE OF THE EQUIPMENT, COST OF ANY SUBSTITUTE EQUIPMENT, FACILITIES OR SERVICES, OR CLAIMS OF YOUR CUSTOMERS FOR SUCH DAMAGES.

Depending on your geographical location, some limitations and exclusions may not apply.

Application Support

For application specific support, contact your reseller, systems integrator, software manufacturer, or dealer.

How to Obtain Service

Visit us on the Internet at <http://www.kodak.com>

Please refer to the Service and Support section of your User's Guide for the support hotline designated to your location.

When returning a DC120 camera for repair, the unit shall be packed in its original packing materials. A problem report should also be enclosed with the equipment. If the original packaging has been discarded or is not available, packing will be at the owner's expense.

The repaired or replaced unit will be shipped from Kodak within five business days from the date of DC120 camera receipt at the service center.

Unless a specific Kodak warranty is communicated to the purchaser in writing by a Kodak company, no other warranty or liability exists beyond the information contained above, even though defect, damage or loss may be caused by negligence or other act.

To obtain warranty repair service contact your local Kodak representative. For assistance, refer to the Service and Support information in the Kodak DC120 camera User's Guide.

Regulatory Information

FCC Compliance and Advisory

This device complies with Part 15 of the FCC Rules. Operation is subject to the following two conditions: 1) this device may not cause harmful interference, and 2) this device must accept any interference received, including interference that may cause undesired operation.

This equipment has been tested and found to comply with the limits for a Class B digital device, pursuant to Part 15 of the FCC Rules. These limits are designed to provide reasonable protection against harmful interference in a residential installation.

This equipment generates, uses, and can radiate radio frequency energy and, if not installed or used in accordance with the instructions, may cause harmful interference to radio communications. However, there is no guarantee that interference will not occur in a particular installation.

If this equipment does cause harmful interference to radio or television reception, which can be determined by turning the equipment off and on, the user is encouraged to try to correct the interference by one or more of the following measures: 1) reorient or relocate the receiving antenna; 2) increase the separation between the equipment and the receiver; 3) connect the equipment to an outlet on a circuit different from that to which the receiver is connected; 4) consult the dealer or an experienced radio/TV technician for additional suggestions.

Any changes or modifications not expressly approved by the party responsible for compliance could void the user's authority to operate the equipment. Where shielded interface cables have been provided with the product or specified additional components or accessories elsewhere defined to be used with the installation of the product, they must be used in order to ensure compliance with FCC regulation.

Canadian DOC Statement

DOC Class B Compliance—This digital apparatus does not exceed the Class B limits for radio noise emissions from digital apparatus set out in the radio interference regulations of the Canadian Department of Communications.

Observation des normes-Class B—Le présent appareil numérique n'émet pas de bruits radioélectriques dépassant les limites applicables aux appareils numériques de la Classe B prescrites dans les règlements sur le brouillage radioélectrique édictés par le Ministère des Communications du Canada.



Index

A

- AC Adapter 2-25
- Accessories 2-25
- Activating the Self-Timer Indicator 2-11
- Adjusting LCD Brightness 2-23
- Adjusting the Exposure 2-5, 2-6
- Album
 - Changing Settings 2-8
 - Moving Pictures Into 2-19
- America Online 10-2
- Autofocus Settings 2-4
- Automatic LCD Turn Off 2-23
- Automatic Power Off 2-24

B

- Batteries
 - Installing 2-1, 2-2
 - That Can Be Used 2-1
- Battery Life, Extending 2-2
- Battery Status 2-13
- Brightness Adjustment 2-23

C

- Camera, *See* DC120 Camera
- Camera Troubleshooting 9-4
- Card Status 2-9
- Changing
 - Album Settings 2-8
 - Autofocus Setting 2-4
 - Camera Settings 2-3
 - Exposure Setting 2-6

Changing (*continued*)

- Flash Setting 2-7
- Picture Quality Setting 2-10
- Checking Serial Port Availability 3-2
 - Macintosh 3-3
 - Windows 3-2
- Cleaning the Lens 2-28
- CompuServe 10-2
- Connecting the DC120 to Your Computer 3-1
- Contents of Camera Package 1-1
- Controls
 - Back of Camera 1-3
 - Front of Camera 1-2
- Customer Support 10-2

D

- Damage from Batteries, Preventing 2-2
- DC120 Camera
 - Accessories 2-25
 - Back Controls 1-3
 - Front Controls 1-2
 - Package Contents 1-1
 - Status Display 2-2
 - Turning Off 2-2
 - Turning On 2-2

E

- Editing Tools
 - Darken 7-4
 - Hand 7-4
 - Lasso 7-4

Editing (*continued*)

- Lighten 7-4
- Magic Wand 7-4
- Polygon 7-4
- Rectangle 7-4
- Red Eye 7-4
- Sharpen 7-4
- Smooth 7-4
- Sphere 7-4
- Zoom 7-4

Enhancing Your Pictures

- By Example 7-6
- In One Step 7-5

Erasing Pictures 2-21

EXIT Option 2-19, 2-20, 2-21

Exposure Settings 2-5

- Changing 2-6

Extending Battery Life 2-2

F

Faxed Information 10-2

Flash Settings 2-7

- Changing 2-7

Focus Settings, *See* Autofocus

G

General Maintenance and Safety 2-28

H

Help Options

- America Online 10-2
- CompuServe 10-2
- Customer Support 10-2
- Fax 10-2
- Kodak Internet Listserv 10-2
- Online Services 10-2
- Software 10-1
- World Wide Web 10-2

I

Including Yourself In the Picture 2-11

Indicator

- Number of Pictures

- Remaining 2-12

- Self-timer 2-11

INFO Option 2-22

Inserting a Picture Card 2-9, 2-26

Installing Batteries 2-1, 2-2

Internet 10-2

K

Kodak Internet Listserv 10-2

L

LCD Display

- Brightness 2-23

- Preview Option 2-16

- Quickview Option 2-15

- Reviewing Your Pictures 2-17

- Turning Off 2-23

Lens, Cleaning 2-28

Looking at a Picture After

- Taking It 2-15

Looking at a Subject Before Taking a Picture 2-16

M

Macintosh/DC120 Camera

- Communications 9-3

Maintenance and Safety 2-28

Memory

- Erasing Pictures From 2-21

Monitor Adjustment 3-3

- Macintosh 3-3

- Windows 3-3

-
-
- Mounter Software
- Camera Communication
 - Settings 8-1
 - Installation 8-1
 - Overview 8-2
 - Properties 8-5
 - Transferring Pictures 8-3
- MOVE TO CARD Option 2-20
- Moving Pictures
- Into Albums 2-19
 - To a Picture Card 2-20
- N**
-
- Number of Pictures Remaining 2-12
- O**
-
- Online Services 10-2
- Optional Accessories 2-25
- P**
-
- PhotoEnhancer Software 7-1
- Correcting for Lighting
 - Conditions 7-8
 - Editing Tools 7-4
 - Enhancing Pictures 7-5
 - Installation 7-1
 - Printing Your Pictures 7-8
 - Starting the Software 7-1
- Photoshop 6-1
- Picture Card
- Erasing Pictures From 2-21
 - Moving Pictures to 2-20
 - Removing 2-27
 - Status 2-9
- Picture Quality Settings 2-10
- Changing 2-10
- Picture Taking 2-14
- Reviewing Your Pictures 2-17
 - Viewing a Picture After
 - Taking It 2-15
 - Viewing a Subject Before Taking
 - a Picture 2-16
- Picture Transfer Software
- Camera Communication
 - Settings 5-1
 - Installation 5-1
 - Overview 5-2
 - Preferences Settings 5-6
 - Starting Picture Transfer
 - Software 5-2
 - Transferring Pictures from
 - Camera 5-3
- Picture, Including Yourself In the 2-11
- Pictures
- Erasing 2-21
 - Moving into Albums 2-19
 - Reviewing 2-17
 - Storing 2-8
 - Viewing Information About 2-22
- Pictures Remaining 2-12
- PLAY-STOP Option 2-17
- Power
- Automatic Off 2-24
- Preventing Damage from Batteries 2-2
- Preview Option 2-16
- Printing 3-4
- Q**
-
- Quickview Option 2-15
- R**
-
- Removing a Picture Card 2-27
- Reviewing Your Pictures 2-17

S

Saving Your Pictures 7-8
Selecting Camera Settings 2-3
Self-timer Indicator 2-11
 Activating 2-11
Service, How to Obtain 3
Settings
 Adjusting the Exposure 2-6
 Autofocus 2-4
 Camera Communication for
 Mounter Software 8-1
 Camera Communications for
 Picture Transfer
 Software 5-1
 Changing the Autofocus Setting
 2-4
 Changing the Flash Setting 2-7
 Changing the Picture Quality
 Setting 2-10
 Exposure 2-5
 Flash 2-7
 Picture Quality 2-10
 Preferences for Picture Transfer
 Software 5-6
 Selecting and Changing Camera
 Settings 2-3
Shutter Speed, *See* Exposure Settings
Software 4-1
 Installer 4-1
 Mounter 8-1
 PhotoEnhancer 7-1
 Picture Transfer Application 5-1
 TWAIN Acquire & Plug-in 6-1
Software Help 10-1
 Kodak DC120 Digital
 Access 10-1
 Kodak DC120 Mounter 10-1
 Kodak Picture Transfer
 Application 10-1
 PictureWorks PhotoEnhancer
 Software 10-1

Specifications 2-29
Status Display 2-3
Status, Battery 2-13
System Requirements
 Macintosh 4-2
 Windows 4-2

T

Taking Pictures 2-14
 Reviewing Your Pictures 2-17
 Viewing a Picture After
 Taking It 2-15
 Viewing a Subject Before Taking
 a Picture 2-16
Technical Tips 9-1
Tool Palette 7-4
Troubleshooting
 Computer Monitor 9-1
 DC120 Camera 9-4
 Macintosh/DC120 Camera
 Communications 9-3
 Memory Card 9-7
 Status Display Error Codes 9-7
 Windows/DC120 Camera
 Communications 9-1
Turning Off the LCD 2-23
Turning the Camera
 Off 2-2
 On 2-2
TWAIN Acquire & Plug-in
 Software 6-1
 Camera Communication
 Settings 6-1
 Camera Functions 6-12
 Enhancing Your Picture 6-8
 Installation 6-1
 Overview 6-3
 Picture Information 6-7
 Preferences 6-9
 Rotating Your Picture 6-7
 Transferring Your Picture 6-6

V

- Viewing a Picture After Taking It 2-15
- Viewing a Subject Before Taking a
Picture 2-16
- Viewing Information About the
Picture 2-22

W

- Warranty
 - Application Support 3
 - How to Obtain Service 3
 - Limitations 2
 - Regulatory Information 4
 - Repair Coverage 1
 - Warranty Time Period 1
- What's included with the DC120
Camera 1-1
- Windows/DC120 Camera
Communications 9-1
- World Wide Web 10-2

Z

- Zoom 2-24